

# One Talk CP925

Conference phone user guide

[verizon.com/support/one-talk/](https://verizon.com/support/one-talk/)

[verizon.com/support/yealink/](https://verizon.com/support/yealink/)



CP925

---

**Table of contents**

<b>Table of contents</b> .....	<b>2</b>
<b>Before you begin</b> .....	<b>5</b>
<b>Getting started</b> .....	<b>5</b>
Hardware overview .....	5
Screen and icons .....	6
Control center .....	6
Idle screen .....	7
The DSSKey screen .....	8
Calls screen .....	9
Icons in the status bar .....	9
<b>Call features</b> .....	<b>10</b>
Placing calls .....	10
Placing a call from the Dialer .....	10
Placing multiple calls .....	10
Placing a call with a Speed Dial key .....	10
Placing an international call .....	11
Placing a call from the call History .....	11
Placing a call from the directory .....	11
Answering calls .....	11
Answering a call .....	11
Answering a call when in a call .....	11
Answering a call automatically .....	12
Silencing or rejecting incoming calls .....	12
Silencing a call .....	12
Rejecting a call manually .....	12
Rejecting anonymous calls .....	14
Rejecting calls with Do Not Disturb (DND) .....	14
Ending calls .....	14
Muting/unmuting audio .....	14
Mute .....	15
Holding and resuming calls .....	15
Resuming a held call .....	16
Redirecting incoming calls .....	16
Forwarding all incoming calls to a contact .....	16
Forwarding all incoming calls on all lines .....	16
Deactivating call forward .....	17
Forwarding an incoming call manually .....	17
Diverting calls to a contact .....	17
Transferring calls .....	17
Performing a direct transfer .....	17
Performing a semi-attended/attended transfer .....	18
Conference calls .....	18
Local conference .....	18
Initiating a conference by dialing multiple numbers .....	18
Initiating a conference by inviting participants .....	19
Merging multiple calls into a conference call .....	19
Holding/Resuming a conference call .....	19
Muting/unmuting a conference call .....	19
Enabling/disabling the DND mode for a conference call .....	19
<b>Advanced call features</b> .....	<b>20</b>
Call park and call retrieve .....	20
Parking or retrieving a call with a Park or Retrieve key .....	20
State indicator of the Park/Retrieve key .....	20
Parking a call using a Park key .....	20
Retrieving a parked call using a Retrieve key .....	20
Intercom .....	21
State indicator of the Intercom key .....	21
Placing an intercom call .....	21
Picking up an incoming call of the target extension .....	21

Answering an intercom call.....	22
Voice mail .....	22
Setting the voice mail code.....	22
Leaving voice mails .....	23
Listening to voice mails.....	23
<b>Directory.....</b>	<b>23</b>
Local directory.....	23
Managing the local directory groups.....	23
Managing the Local Directory contacts.....	24
Moving a Local Directory contact to Blacklist .....	25
Searching for contacts .....	26
Favorites .....	26
Adding favorites.....	26
Viewing favorites.....	28
Reordering favorites .....	28
Deleting favorites.....	28
Blacklist.....	28
Adding a Blacklist contact.....	28
Viewing Blacklist Contacts.....	29
Editing a Blacklist contact.....	29
Deleting Blacklist contacts.....	29
Moving a Blacklist contact to the Local Directory .....	30
Mobile contacts.....	30
Remote Phone Book.....	31
<b>Call history .....</b>	<b>32</b>
Call history icons.....	32
Viewing History Records.....	32
Saving a History Record to Local Directory.....	32
Saving a History Record to Blacklist.....	32
Deleting history records .....	33
<b>Customizing your phone.....</b>	<b>33</b>
Changing the administrator password .....	33
Wallpaper.....	34
Screen saver.....	34
Setting the screen saver type .....	34
Changing the backlight and time .....	35
Changing the language.....	35
Time and date.....	35
Changing the time and date format .....	36
Phone lock.....	36
Setting the Phone lock.....	36
Setting a Phone Lock key .....	36
Locking your phone manually .....	37
Unlocking your phone.....	37
Changing your phone unlock PIN .....	37
<b>Audio settings .....</b>	<b>37</b>
Adjusting the volume .....	37
Setting the ring tone.....	37
Disabling the key tone .....	38
Enabling touch tone.....	38
<b>Using the CP Wireless Microphone CPW25 .....</b>	<b>39</b>
CPW25 LED Instructions.....	39
Charging the CPW25.....	39
Turning the CPW25 On or Off .....	40
Registering the CPW25 .....	40
Registering the CPW25 with another phone.....	41
Unregistering the CPW25.....	41
Muting or unmuting the CPW25.....	41
Viewing CPW25 information .....	42
Finding the CPW25.....	42
<b>Connecting a mobile phone via Bluetooth.....</b>	<b>42</b>
Activating the Bluetooth mode .....	42
Pairing and connecting the Bluetooth-enabled mobile phone .....	43

Syncing the mobile contacts to the phone ..... 43

Enabling the phone audio ..... 44

Enabling the phone media ..... 44

Handling a mobile phone call on the phone ..... 44

Editing device name of your phone ..... 44

Making the phone discoverable ..... 45

Deleting the paired Bluetooth device ..... 45

Disconnecting the Bluetooth device ..... 45

Deactivating the Bluetooth mode ..... 45

**Wireless network ..... 45**

    Activating the Wi-Fi mode ..... 47

    Connecting to the wireless network ..... 47

    Viewing the wireless network information ..... 48

    Disconnecting the wireless network connection ..... 48

    Deactivating the Wi-Fi mode ..... 48

**Maintaining your phone ..... 48**

    Warnings ..... 48

    Rebooting your phone ..... 49

    Resetting to factory settings ..... 49

    Updating the phone configuration ..... 49

    Clearing user's personalized configuration settings ..... 49

**Notices ..... 50**

    Technical support ..... 50

    Important customer information ..... 50

    WEEE warning ..... 50

    Disclaimer ..... 50

    Important 911 emergency response information ..... 51

    Declaration of conformity ..... 51

    CE mark warning ..... 51

    Part 15 FCC Rules ..... 51

    Class B digital device or peripheral ..... 52

    Important safety precautions ..... 52

    Danger—electric shock and fire ..... 52

    Learn more ..... 52

## Before you begin

This guide provides information you need to quickly use your new phone.

Firstly, verify with your system administrator that the IP network is ready for phone configuration. Also, be sure to read the Quick Start Guide which can be found in your phone package before you set up and use the phone. As you read this guide, keep in mind that some features are only configurable by your system administrator or determined by your phone environment. As a result, some features may not be enabled or may be operated differently on your phone. Additionally, the examples and graphics in this guide may not directly reflect what is displayed or is available on your phone screen.

## Getting started

Before you use your phone, take some time to get familiar with its features and user interface.

## Hardware overview

Understanding the phone hardware helps you easily use the phone's features.

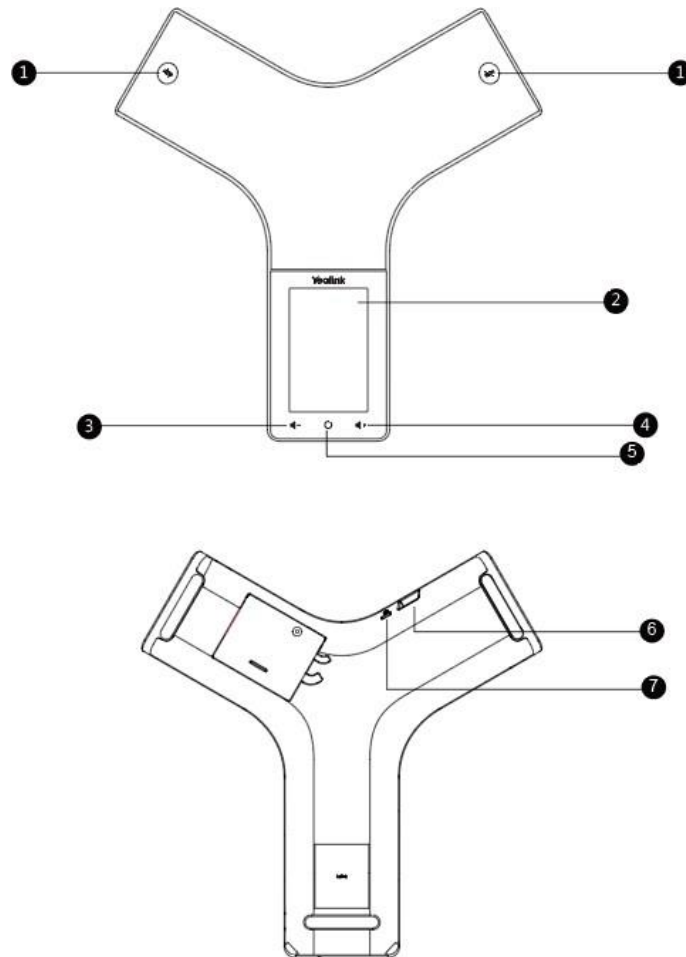

NO.	Item	Description
1	Mute key	<ul style="list-style-type: none"> <li>• Toggles mute feature</li> <li>• Indicate phone and call statuses</li> </ul>
2	Touch screen	<ul style="list-style-type: none"> <li>• Shows information about calls, soft keys, time, date and other relevant data.</li> </ul>
3	Volume (-) touch key	<ul style="list-style-type: none"> <li>• Lowers the volume of the speaker, ringer or media</li> </ul>

4	Volume (+) touch key	<ul style="list-style-type: none"> <li>Increases the volume of the speaker, ringer, or media</li> </ul>
5	Home touch Key	<ul style="list-style-type: none"> <li>Returns to the idle screen</li> </ul>
6	USB Type-C Port	<ul style="list-style-type: none"> <li>Allows you to connect a USB flash drive (optional) to your phone so you can record calls/conferences and play back recorded files</li> <li>Allows you to connect expansion PSTN box(es) (optional) to experience calls in PSTN. Up to two cascaded expansion PSTN boxes can be connected, so you can experience the local five-way conference conveniently in excellent speech quality with PSTN</li> <li>Allows you to charge the Bluetooth Wireless Microphone CPW25</li> </ul>
7	Security slot	<ul style="list-style-type: none"> <li>Allows you to connect a universal security cable to your phone so you can lock down your phone. The phone will not be removed after locked</li> </ul>

### Mute touch key LED indicators

The Mute touch key LED indicators indicate the call and phone status.

LED status	Description
Solid red	The phone is initializing. The phone is muted.
Flashing red	The phone is ringing.
Solid green	The phone is placing a call. There is an active call on the phone.
Off	The phone is powered off. The phone is idle.

### Screen and icons

The user screens and icon indicators can help you navigate and understand the important information on the phone's status.

### Control center

Control center allows you to access common features quickly or enter the menu screen.

#### Procedure

Swipe down from the top of the screen or tap **More** on the idle screen.



No.	Name	Description	
1	Control center	Backlight slider	<ul style="list-style-type: none"> <li>• Drag the slider to adjust the screen brightness quickly</li> </ul>
		Bluetooth	<ul style="list-style-type: none"> <li>• Tap to turn Bluetooth on or off quickly</li> <li>• Long tap to enter the Bluetooth setting screen</li> </ul>
		Wi-Fi	<ul style="list-style-type: none"> <li>• Tap to turn Wi-Fi on or off quickly</li> <li>• Long tap to enter Wi-Fi setting screen</li> </ul>
		Mute	<ul style="list-style-type: none"> <li>• Tap to turn mute on or off quickly</li> </ul>
		DND	<ul style="list-style-type: none"> <li>• Tap to turn DND on or off quickly</li> </ul>
		Auto answer	<ul style="list-style-type: none"> <li>• Tap to turn auto answer on or off quickly</li> </ul>

No.	Name	Description	
2	Menu	Status	Tap to enter the Status menu.
		Features	Tap to enter the Features setting menu.
		Message	Tap to enter the Message setting menu.
		MIC (coming soon)	Tap to enter the MIC setting menu.
		Basic	Tap to enter the Basic setting menu.
		Advanced	Tap to enter the Advanced setting menu.
		USB	Tap to view the recorded audios and the available recording time.

Swipe up from the bottom of the screen or tap the Home touch key to exit this screen.

### Idle screen

The idle screen mainly displays the registered account, time and date, and programmable keys. You can access the DSSKey screen and the control center.



No.	Name	Description
1	Status Bar	Displays the label of the current account and icons.
2	Icons	Icons are displayed on the left of the status bar.
3	Current account	Displays the current registered account. If there is no account registered on the phone, <b>No Service</b> appears.

No.	Name	Description	
4	Digital clock widget	Displays the phone's time and date.	
5	Programmable keys	Call	Tap to enter the dialing screen.
		Dial	Tap to enter the Bluetooth settings screen.
		History	Tap to enter the History screen and view history records.
		Directory	Tap to enter the Directory screen and view contacts.
6	DSSKey	Tap to enter the DSSKey screen.	
7	More	Tap to enter the control center.	

## The DSSKey screen

The DSSKey screen displays phone's line keys.





No.	Application	Description
1		Tap to add a line key.
2	Line Key List	Shows the line key labels. You can customize the line keys.
3	Page Keys	Tap to turn to the corresponding page.

## Calls screen

All of your active and held calls are displayed on the calls screen.



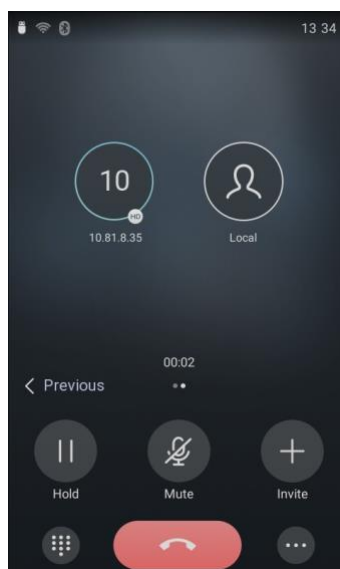















When there is an active call and a held call, the calls screen is shown below:



You can tap the Previous/Next to switch between multiple calls.

## Icons in the status bar

By viewing the icons in the status bar, you can easily get the current phone status, such as call and Bluetooth status.

Icons	Description	Icons	Description
	Wired network is unavailable		Phone warning
	Wired network is unreachable		Keep mute
	Auto answer		Voice mail
	Registered successfully		Phone lock
	Do Not Disturb (DND)		Ringer volume is 0
	Call forward		Missed calls
	USB flash drive is detected		PSTN box is detected
	Wi-Fi enabled		Wi-Fi connection is unreachable
	Bluetooth enabled		Bluetooth-enabled mobile phone paired and connected

## Call features

You can use the phone to place and answer calls, ignore incoming calls, transfer a call to someone else, conduct a conference call and perform other basic call features.

### Placing calls

You can use your phone like a regular phone to place calls in many ways.

#### Placing a call from the Dialer

The Dialer enables you to enter a number to place a call, and it displays a list of previously placed calls or contacts in your directory.

You can also select the desired contact from the search list, the placed call list or Directory.

Note: Your system administrator can configure the source list for searching and disable to display the placed call records.

#### Procedure

1. Tap .

Enter a number.

Select send .

Note: Your system administrator can enable live Dialpad feature, which enables your phone to automatically dial out the phone number after a period of time without selecting Send.

#### Placing multiple calls

When you are in a call, you can hold your current call and place a new one of the following:

Select  New Call. The active call is placed on hold.

Select Hold to place the original call on hold.

Select  New Call.

Enter the desired number or select a contact.

Select Send .

#### Placing a call with a Speed Dial key

You can quickly dial a number by using a Speed Dial key.

#### Procedure

1. Tap DSSKey.

2. Long tap the desired line key.

3. Select Speed Dial from the Type field.

4. Select the desired line from the Account ID field.

5. Do one of the following:

- (Optional) Enter the string that will appear on the phone screen in the Label field. Enter the contact number you want to dial out directly in the Value field.

You can also enter the contact number with the DTMF sequence that you want to send in the Value field. The contact number and DTMF sequence are separated by commas. One comma stands for 500 milliseconds.

For example, 1234,,123# means the phone dials out the number 1234 first, then after the call is set up for 1 second, it sends the DTMF sequence 123# to the remote party.



- Select  and select the desired contact.

6. Select .

## Placing an international call

You can place calls to international phone numbers on your phone (make sure your line is allowed to place International calls)

### Procedure

1. Tap .
2. Long press digit key 0 on the phone keypad until the plus sign (+) appears.
3. Enter the phone number with the country code.
4. Select Send .

## Placing a call from the call History

You can place calls to contacts from the History list, which contains the calls that were recently placed, answered, missed or forwarded.



### Procedure

1. Tap .
2. The phone screen displays all call records.
3. Tap All Calls and select the desired history list.
4. Tap the desired entry.

## Placing a call from the directory

You can place a call to a contact directly from your directory.

### Procedure

1. Tap .
2. If the contact was added to a specified contact group, you can tap Local Directory to select the desired contact group.
3. Tap .
4. If the selected contact has multiple numbers, tap the desired number to dial out.

---

## Answering calls

When you receive a call, you can choose to answer it manually or automatically.

### Answering a call

When you receive an incoming call, the phone rings and the screen displays the information of the incoming call. You can choose to answer the incoming call.

### Procedure

1. Select Answer.

## Answering a call when in a call

You can answer a call when there is already an active call on your phone.

When you are in an active call and an incoming call arrives on the phone, a call waiting tone beeps, and the incoming call information is displayed.

### Procedure

1. Select **Answer** .

The active call is placed on hold, and the incoming call becomes active.

Note: You can disable the call waiting feature to reject the incoming call automatically during a call.

## Answering a call automatically

Auto answer enables you to automatically answer an incoming call from speakerphone (hands-free) mode when your phone is idle.

You can also enable auto answer mute to mute the local microphone when an incoming call is answered automatically.

### Procedure

1. Go to Control Center.
2. Tab on the Auto Answer.

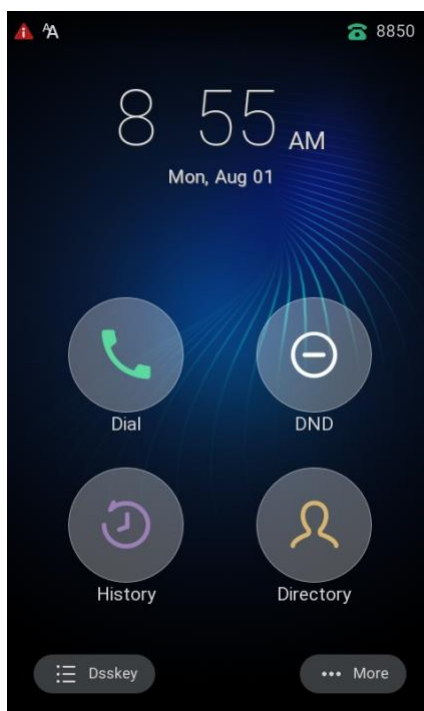

If the auto answer feature is enabled, the auto answer icon appears on the phone screen.

---

## Silencing or rejecting incoming calls

When you receive an incoming call, you can choose to silence or reject the call instead of answering.

### Silencing a call

You can silence a call to stop your phone from ringing. Even if you silence the call, the incoming call notification continues to be displayed on your phone.

### Procedure

1. Select .

### Rejecting a call manually

You can reject a call manually, and the call may be sent to voice mail. The rejected calls are displayed in the Received Calls list in your History list.

### Procedure

1. Select Reject.



## Rejecting anonymous calls

You can reject incoming calls from the callers who have hidden their identities. As a result, your phone will not ring and you will not be notified of an attempted call.

### Before you begin

Check with your system administrator if the anonymous call rejection on code or off code is required. If required, get it from your system administrator.

### Procedure

1. Go to More > Features > Anonymous Call.
2. Select the desired line.
3. Turn on Local Anonymous Rejection (AnonymousRejection).
4. (Optional) Turn on Send Anonymous RejectionCode.
5. (Optional) Enter the anonymous call rejection on code and off code respectively in the On Code and OffCode field.
6. Select  .

## Rejecting calls with Do Not Disturb (DND)

You can enable DND to reject all incoming calls automatically when you do not want to be interrupted.

Note: Check with your system administrator to find out if the DND feature is available on your phone.

### Activating DND

You can activate DND to prevent your phone from ringing and to reject all incoming calls automatically. All calls you receive while DND is enabled are logged in the Missed Calls list.

Note: If both DND and busy forward are activated on the phone, calls will be forwarded to the configured destination number.

### Procedure

1. Tap More > DND when the phone is idle.
2. The DND icon  appears in the status bar.

### Deactivating DND

You can deactivate DND when you are ready to resume receiving calls again.

### Procedure

1. Tap More > DND when the phone is idle.
2. The DND icon  disappears from the status bar.

---

## Ending calls

You can end the current call at any time.

### Procedure





1. Select  .

---

## Muting/unmuting audio

When you are in a call, you can mute the audio, so that you can hear the other person, but they cannot hear you.

**Procedure**

1. Tap the mute touch key  or  during a call.
2. The mute touch key LED glows red.
3. Tap the mute touch key  or  again to unmute the call.  
The mute touch key LED glows green.



Tip: You can also mute the microphone while the phone is dialing so that the other party cannot hear you when the call is set up.

**Mute**

In a meeting room, if incoming calls are answered automatically on your phone, callers may hear your discussion with your colleagues. You can keep the phone in mute to prevent this unintended situation.

The mute state of your phone persists across calls. The phone stays in the mute state until you unmute the microphone manually or until the phone restarts.

**Procedure**

1. Tap the Mute touch key  when the phone is idle.  
The mute icon appears on the idle screen.
2. Tap the Mute touch key  again to deactivate the mute state.

**Holding and resuming calls**

You can place an active call on hold and resume the call when you are ready. When you place a call on hold, the held party may hear the music on hold from your phone system.

**Holding a call**

You can place an active call on hold on your phone.

**Procedure**

1. Select Hold during a call.

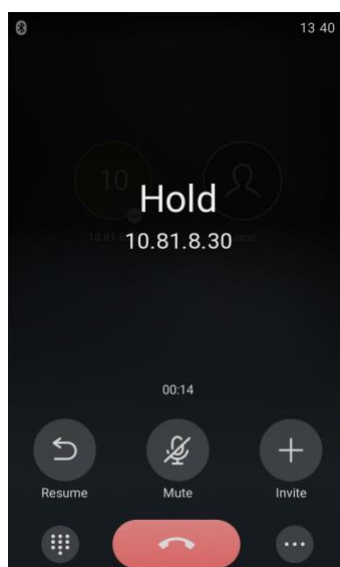

The phone will beep softly every 30 seconds to remind you that you still have a call on hold.

Note: When you have multiple calls on the phone and the current call is held, you can select Previous/Next to swap to the active call.

## Resuming a held call

You can view and resume a held call on the phone.

### Procedure

Select Resume.

If multiple calls are placed on hold, select the desired call first.

Note: When you have multiple calls on the phone and the current call is active, you can select Previous/Next to swap to the held call.

## Redirecting incoming calls

When you are not available to answer calls on your phone, you can forward the calls to another phone.

### Forwarding all incoming calls to a contact

You can set up the forwarding type which enables your phone to forward all incoming calls to a contact. There are three types of forwarding:

- Always Forward: Forwards all incoming calls immediately.
- Busy Forward: Forwards incoming calls when you are busy in a call.
- No Answer Forward: Forwards incoming calls when no one answers the calls.

### Forwarding all incoming calls on all lines

You can forward all incoming calls on the phone.

#### Before you begin

Check with your system administrator if the forward on code or off code is required. If required, get it from your system administrator.

#### Procedure

1. Go to More > Features > Call Forward.
2. Select the desired forwarding type and turn on the feature.
3. Do one of the following:



Enter the contact number you want to forward incoming calls to in the Forward to field.

Select  and select the desired contact.

4. If you select the No Answer Forward option, select the desired ring time to wait before forwarding from the After Ring Time field.
5. (Optional) Enter the always/busy/no answer forward on code or off code respectively in the On Code or Off Code field.
6. Tap . The call forward icon appears in the status bar. And the phone prompts you that call forward is enabled.

## Deactivating call forward

You can deactivate the call forward when you no longer want to forward your calls.

### Procedure

1. Go to More > Features > Call Forward.
2. Select the desired forwarding type and turn off the feature.
3. Tap .

## Forwarding an incoming call manually

You can manually forward the call to another contact while your phone rings.



### Procedure

1. When the phone is ringing, tap .
2. Enter the number you want to forward the incoming call to.
3. Select Forward.  
The phone prompts a call forward message.

## Diverting calls to a contact

You can divert all incoming calls from a particular contact to another contact. Auto divert has precedence over call forward.

### Procedure

1. Tap .
2. Tap the desired contact and select .
3. Edit the contact information.
4. Enter a contact's number you want to divert the call to in the Auto Divert field.
5. Select Done.

---

## Transferring calls

During a call, you can transfer the call to another contact. You can use one of three ways:

- Direct Transfer: Transfer a call directly to the third party without consulting.
- Semi Consultative Transfer: Transfer a call when receiving ringback.
- Attended Transfer (Consultative Transfer): Transfer a call with prior consulting.

## Performing a direct transfer

You can transfer a call to another contact immediately without consulting with her/him first.



**Procedure**

1. Select  Transfer.
2. Enter the number you want to transfer to.
3. Select Transfer to complete the transfer.

**Performing a semi-attended/attended transfer**

You can transfer calls to other contacts immediately when receiving ringback or after consulting with them first.

**Procedure**

1. Select  **Transfer** during a call.
2. Do one of the following:
  - Enter the number or select a contact from the placed call list you want to transfer the call to.
  - Select  the desired contact from the Directory list.
3. Tap # key or .
4. Do one of the following:
  - When you hear the ringback tone, select Transfer to finish the Consultative Transfer.
  - After the contact answers the call, select Transfer to finish the attended transfer (consultative transfer).

---

**Conference calls**

The phone supports creating local conference and network conference. During the conference, follow these tips:

- Mute your microphone when you are not speaking, especially in noisy environments.
- Avoid tapping or rustling papers near the microphone.
- Speak in your normal voice without shouting.

**Local conference**

The phone supports up to six parties (including yourself) in a conference call. There are three ways to create a conference:

- Initiating a conference by dialing multiple numbers.
- Initiating a conference by inviting participants.
- Merging multiple calls into a conference.

If you connect a mobile phone and PC to your IP phones, you can also create a hybrid UC conference.

**Initiating a conference by dialing multiple numbers**



You can initiate a conference by dialing multiple numbers, this is a convenient way to set up a local conference.

**Procedure**

1. Select .
2. Select Call multiple members? Click here >>.
3. Enter the number of the first party then select Add Members or select a contact.
 

The avatar of the first party appears on the top of phone screen. You can tap the avatar to cancel the addition.
4. Repeat the step 3 until you add all intended parties.
5. Select  to call all intended parties at the same time.
 



The conference is set up after the intended parties answer the call.

Note: The value under the icon  indicates the number of parties you have added and the maximum number of the parties you can add. For example,  indicates you can add up to 4 parties and you have added 1 party.

## Initiating a conference by inviting participants

You can invite one or multiple members at a time to join the conference.

### Procedure

1. Place a call to the first party.
  2. After the first party answers the call, select Invite.
  3. Do one of the following:
    - Enter the number of the second party, and select Invite. Repeat the step above until you add all intended parties.
    - Select  select the desired contact to dial out.
    - Select  select the desired history record to dial out.
    - Select Call multiple members? Click here >>. Enter the number or select the contact, and then select Add Members to add multiple members.
- Tap  to call all intended parties at the same time.

## Merging multiple calls into a conference call

During the multiple calls, you can merge them into a conference call.

### Procedure

1. Tap  Merge calls.  
The calls are merged into a conference call.

## Holding/Resuming a conference call

When you place a conference call on hold, both other participants are placed on hold. Other participants cannot hear each other until you resume the held conference call.

### Procedure

1. Select Hold to place the conference call on hold.
2. Select Resume to resume the held conference call.

## Muting/unmuting a conference call

You can mute the local microphone during a conference call so that the other participants can hear each other except you.



### Procedure

1. Select Mute to mute the conference call.
2. Select Mute again to unmute the conference.

## Enabling/disabling the DND mode for a conference call

You can enable the DND mode for a conference call, as a result, the conference call will not be disturbed by the incoming calls.

### Procedure

1. Select  DND to enable the DND mode.
2. Select  DND again to disable the DND mode.

## Advanced call features

You can perform some server-dependent tasks on the phone. Contact your system administrator to find out if your phone supports these advanced call features.

### Call park and call retrieve





You can park a call, and then retrieve the call either from your phone or another phone. After parked, the call is placed on hold, you can continue the conversation after retrieving it.

#### Parking or retrieving a call with a Park or Retrieve key

You can easily use a Park key to park a call to a specific extension (if the FAC mode is set) or shared parking lot (if the Transfer mode is set), and quickly retrieve this parked call using a retrieve key.

#### State indicator of the Park/Retrieve key

You can get the call park/retrieve status by viewing the icon indicator of the Park/Retrieve key.

Icons	Description	Icons	Description
	Park successfully/Idle state		Park failed
	Ringing state		Retrieve parked call



#### Parking a call using a Park key

You can set a line key as a Park key, and specify an extension or a shared parking lot you want to park a call to for this key. By using the Park key, you can park a call quickly.

##### Before you begin

Check with your system administrator if the FAC or Transfer mode is set on your phone, and if **Account ID** is necessary for this key.

##### Procedure

1. Tap DSSKey.
2. Long tap the desired line key.
3. Select Key Event from the Type field.
4. Select Call Park from the Key Type field.  
(Optional) Select the desired line from the Account ID field.
5. Do one of the following:  
(Optional) Enter the string that will appear on the phone screen in the Label field.  
Enter the park extension number or the shared parking lot you want to park the call to in the Value field.  
Select  and select the desired contact.
6. Select  .

During a call, you can the Call Park key, and the call is parked to the desired extension or the shared parking lot directly.



#### Retrieving a parked call using a Retrieve key

You can set a line key as a Retrieve key, and specify a parked extension or retrieve lot you want to retrieve a parked call from for this key. By using the Retrieve key, you can retrieve a parked call quickly.

##### Before you begin

Check with your system administrator if the FAC or Transfer mode is set on your phone, and if Account ID is necessary for this key.

##### Procedure

1. Tap DSSKey.
2. Long tap the desired line key.
3. Select Retrieve Park from the Type field.
4. (Optional) Select the desired line from the Account ID field.
5. Do one of the following:  
(Optional) Enter the string that will appear on the phone screen in the Label field. Enter the parked extension or the retrieve lot in the Value field.  
Select  and select the desired contact.
6. Tap .

When there is a call parked on the extension or the shared parking lot, you can the Retrieve key on the idle screen, and the call is retrieved from the parked extension or shared parking lot directly.

---

## Intercom





Intercom is a useful feature in an office environment to quickly connect with the operator or the secretary.

Intercom enables you to place an intercom call that is answered automatically on the contact's phone as long as the contact is not in an active call.

Note: Intercom is not available on all servers. Contact your system administrator for more information.

### State indicator of the Intercom key

You can get the intercom status by viewing the icon indicator of the Intercom key.



Icons	Description	Icons	Description
	Target extension is available.		Target extension is ringing.
 Callout	Target extension is dialing.	 Talking	Target extension is busy or is in a call.
	Target extension fails to register.		

## Placing an intercom call

You can place an intercom call to quickly relay a message to a contact.

The target phone plays a warning tone and automatically answers the call-in speakerphone (hands-free) mode by default. When the target phone has an active call, the intercom call is answered automatically after the active call ends.

### Procedure

1. Tap DSSKey.
2. Long tap the desired line key.
3. Select Intercom from the Type field.
4. Select the desired line from the Account ID field.
5. Do one of the following:  
(Optional) Enter the string that will appear on the phone screen in the Label field. Enter the target extension number in the Value field.  
Select  and select the desired contact.
6. Select. .
7. Tap the Intercom key to place an intercom call.

## Picking up an incoming call of the target extension

You can pick up the target extension's incoming call by pressing the Intercom key.

Before picking up an incoming call, make sure that the directed call pickup code has been configured either for an Intercom key or for Call Pickup feature in advance.

Check with your system administrator to find out if this feature is available on your phone.

Note: If the directed call pickup code is not set, the phone will place a call to the target extension instead of picking up an incoming call of the target extension when you tap the Intercom key.

#### Procedure

1. Tap DSSKey.
2. Long press the Intercom key.
3. Enter the directed call pickup code in the Extension field.
4. Select  .

When the target extension receives an incoming call, the Intercom key icon of the target extension will change to  . Tap the Intercom key to pick up the incoming call directly.

### Answering an intercom call

By default, when there is an incoming intercom call, the phone plays a warning tone and automatically answer the incoming call.

If your phone is set to answer intercom calls with your microphone muted, you need to tap the Mute touch key to unmute your microphone before responding to the call.

You can configure the following behaviors when receiving an intercom call.

- **Intercom Allow**

Intercom Allow feature allows the phone to automatically answer an incoming intercom call. If you disable this feature, the phone will handle an incoming intercom call like a normal incoming call.

Note: Your system administrator can set a period of delay time before the phone automatically answers intercom calls

- **Intercom Mute**

Intercom Mute feature allows the phone to mute the microphone when incoming intercom calls are answered automatically.

Note: To enable the phone to receive a new incoming call when it already has an active call, make sure that the call waiting feature is enabled on the phone in advance.

#### Procedure

1. Go to More > Features > Intercom.
2. Make the desired changes.
3. Select  .

---

### Voice mail

Voice mail feature allows you to leave voice mails for someone or listen to your voice mail messages on your IP phones.

This feature is set up on the server-side and not all servers support this feature.

### Setting the voice mail code

If you want to connect your phone to the message center, you need to set the voice mail code on your phone.

### Before you begin

Get the voice mail code from your system administrator.

### Procedure

1. Go to More > Message > Set Voice Mail Code.
2. Enter the voice mail code (for example, \*4) in the desired account field.
3. Select .

### Leaving voice mails

You can leave a voice mail to someone who is busy or inconvenient to answer the call.

### Procedure

1. Follow the voice prompts to leave a voice mail.
2. Hang up to complete the voice mail.

### Listening to voice mails

You can listen to your voice mails on the phone, to obtain voice information sent by a contact.

### Before you begin

You need to set the voice mail code in advance.

### Procedure

1. Go to More > Message > View Voice Mail.  
The phone screen displays the amount of new and old voice mails.
2. Tap the account.
3. Follow the voice prompt to listen to your voice mails.

Tip: When the phone prompts that the phone receives a new voice mail, you can tap Connect to dial out the voice mail access code directly.

---

## Directory

The phone provides several types of phone directories, which can be customized by your system administrator.

---

### Local directory

Note: You can back up the Local Directory to the provisioning server. For more information, contact your system administrator.



### Managing the local directory groups

You can manage the Local Directory groups when the phone is idle.

#### Adding contact groups

To organize your contacts and make them easier to find, you can add additional groups in the Local Directory.



#### Procedure

1. Go to  > Local Directory.
2. Select  after Custom Group.
3. Enter the desired group name.
4. Select OK.

#### Editing contact groups

You can change or add the group's information.



#### Procedure

1. Go to  Local Directory.
2. Select  after the desired group and then select Rename.
3. Edit the group name.
4. Select OK.

#### Deleting contact groups

When you delete a contact group, the contacts in the group will not be deleted. You can view the contacts in All Contacts (Local Directory) list.

#### Procedure

1. Go to  Local Directory.
2. Select  after the desired group and then select Delete.
3. The phone prompts you to delete the group or not.
4. Select OK.



## Managing the Local Directory contacts

You can manage the Local Directory contacts when the phone is idle.

#### Adding contacts

When you add a contact to your Local Directory, you can choose how much information you want to enter for your contact. You are required to enter a contact name at least for each new contact.

#### Procedure

1. Select .
2. If you want to add a contact to the specified contact group, select Local Directory to select the desired contact group.
3. Select .
4. Enter your contact's information.
5. Select the desired account from the Account field.
6. Select the desired photo from the Photo field.
7. Select Done.

#### Viewing contacts

You can view the local contacts from the Local Directory on your phone.

#### Procedure



1. Select .
2. If you want to view a contact to the specified contact group, select Local Directory to select the desired contact group.  
The contact names are displayed in alphabetical order.

#### Editing contacts

You can update your contacts' information.



**Procedure**

1. Select .
2. If you want to view a contact to the specified contact group, select Local Directory to select the desired contact group.
3. Tap the desired contact and select .
4. Edit the contact information.
5. Select Done.

**Deleting a contact**

You can delete any contact from the Local Directory.

**Procedure**



1. Select .
2. If you want to delete a contact from the specified contact group, select Local Directory to select the desired contact group.
3. Tap the desired contact.
4. Select Delete.  
The phone prompts you to delete the contact or not.
5. Select OK.

Note: If the contact added to the Favorites directory is deleted in the Local Directory, it will be automatically deleted from the Favorites directory.

**Deleting all contacts**

You can delete all contacts from the Local Directory.

**Procedure**

1. Select .
2. Long tap a contact.
3. Tap the radio box in the top right of the screen.
4. Select  > Delete.  
The phone prompts you to delete all contacts or not.
5. Select OK.

Note: If the contact added to the Favorites directory is deleted in the Local Directory, it will be automatically deleted from the Favorites directory.

**Moving a Local Directory contact to Blacklist**

You can move a contact in the Local Directory to Blacklist. Incoming calls from this contact will be rejected automatically.



**Procedure**

1. Select .
2. If you want to select a contact to the specified contact group, select Local Directory to select the desired contact group.
3. Tap the desired contact.
4. Select Blacklist.  
The phone prompts you to move this contact to the blacklist or not.
5. Select OK.

## Searching for contacts

In the Local Directory, you can enter search criteria to find your desired contact quickly.

### Procedure

1. Select .
2. Do one of the following:
  - Select .
  - Enter your search criteria in the search field.
  - Select the desired letter (for example, T) along the right side to jump to contacts whose names start with T or t.

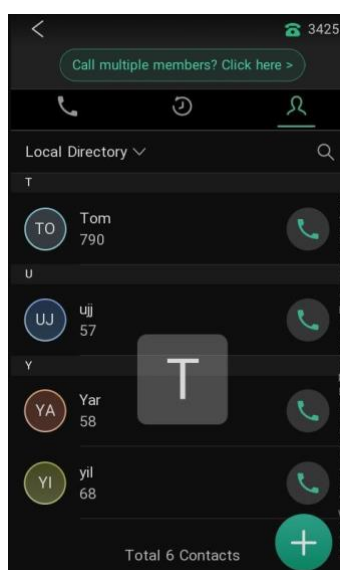

## Favorites

Favorites are the contacts in your Local Directory that you call most often.

If your system administrator has enabled this feature for you, you can add contacts as favorites, view favorites on the idle screen, reorder favorites, and delete favorites.



### Adding favorites

After adding a contact as a favorite, your phone will automatically assign a Speed Dial key for it. You can quickly dial a contact using the Speed Dial key on the idle screen.

#### Adding an existing contact to your favorites

You can add an existing contact as a favorite from the Local Directory.

### Procedure



1. Select .
2. If you want to edit a contact from the specified contact group, select Local Directory to select the desired contact group.
3. Tap the desired contact and select .
4. Select Copy to Favorites.
  - The phone prompts you to automatically accept the next available index number or manually enter your own.
5. Select OK to automatically accept an index number or select Edit to enter an index number (1-999999999).



### Adding a new contact to your favorites

You can add a new contact as a favorite by designating an index number.

#### Procedure

1. Select .
2. If you want to add a contact to the specified contact group, select Local Directory to select the desired contact group.
3. Select .
4. Enter the contact information.
5. Enter the desired index number (1-999999999) in the Favorite Index field.
6. Select Done.

### Viewing favorites

You can view a list of favorites in the Favorites directory.



#### Procedure

1. Select .
2. Tap Local Directory to select Favorites.

### Reordering favorites

You can reorder favorites to change the display order in the Favorite.



#### Procedure

1. Select .
2. Tap Local Directory to select Favorites.
3. Tap the desired contact and select  > Edit.
4. Enter a new index number in the Favorites Index field.
5. Select Done.

### Deleting favorites

You can delete favorites to make room for new favorites.

#### Procedure

1. Select .
2. Tap Local Directory to select Favorites.
3. Tap the desired contact and select  > Edit.
4. Delete the favorite index number in the Favorites Index field.
5. Select Done.

The contact is removed from Favorites directory, while it still remains in your Local Directory.



### Blacklist

Incoming calls from the Blacklist are rejected automatically. You can store up to 30 contacts in the Blacklist to block unwanted callers.

#### Adding a Blacklist contact

You can add a Blacklist contact on the phone to prevent someone from calling you.

**Procedure**

1. Go to  Local Directory > Blacklist.
2. Select .
3. Enter the Blacklist contact's information.
4. Select Done.

**Viewing Blacklist Contacts**

You can view the Blacklist contacts from the Blacklist on your phone.



**Procedure**

1. Go to  > Local Directory > Blacklist.

**Editing a Blacklist contact**

You can update your Blacklist contacts' information.

**Procedure**

1. Go to  > Local Directory > Blacklist.
2. Tap the desired Blacklist contact and select .
3. Edit the Blacklist contact information.
4. Select Done.

**Deleting Blacklist contacts**

You can delete one or all Blacklist contacts. If a contact is removed from the Blacklist, you can answer the call from the contact normally.

**Deleting a Blacklist contact**

If you want to answer a call from a specific contact, you need to remove it from the Blacklist.



**Procedure**

1. Go to  > Local Directory > Blacklist.
2. Tap the desired Blacklist contact.
3. Select Delete.  
The phone prompts you to delete the contact or not.
4. Select OK.

**Deleting all Blacklist contacts**

You can delete all contacts from the Blacklist when you are ready to answer calls from them again.



**Procedure**

1. Go to  > Local Directory > Blacklist.
2. Long tap a contact.
3. Tap the radio box on the top-right of the screen.
4. Select  > Delete.
5. The phone prompts you to delete all contacts or not.
6. Select OK.

## Moving a Blacklist contact to the Local Directory

You can move a Blacklist contact to a Local Directory. Incoming calls from this contact will not be rejected automatically.

### Procedure

1. Go to  Local Directory > Blacklist.
2. Tap the desired Blacklist contact and select .
3. Select Local Directory from the Group field.
4. Select Done.

## Mobile contacts

The mobile phone contacts will be imported to your IP phones and stored under the Mobile Contacts directory.

You can save mobile contacts to the local directory, but you cannot save a local contact to the Mobile Contacts directory.

Note: If you disconnect the Bluetooth-enabled mobile phone from phone or disable the phone to synchronize phone contacts, the mobile contacts will not be displayed.



### Saving a mobile contact to the Local Directory

You can save any mobile contact to the Local Directory, to conveniently call this contact after disconnecting the mobile phone from the phone.

#### Before you begin

Make sure your Bluetooth-enabled mobile phone has been paired with your IP phones, and mobile contact sync feature is enabled.

### Procedure

1. Go to  > Local Directory > Mobile Contacts.
2. Tap the desired contact and select  > Add.
3. Select Local Directory from the Group field.
4. Edit the contact information.
5. Select Done.



### Searching for Mobile Contacts

In Mobile Contacts, you can enter search criteria to find your desired mobile contact quickly.

#### Before you begin

Make sure your Bluetooth-enabled mobile phone has been paired with and connected to your IP phones, and mobile contact sync feature is enabled.

### Procedure

1. Go to  > Local Directory > MobileContacts.
2. Do one of the following:
  - Select  .  
Enter your search criteria.  
The contacts whose name or phone number matches the search string will be displayed in the result list.
  - Select the desired letter (for example, T) along the right side to jump to the contacts whose names start with T or t.



### Updating the Mobile Contacts

You can update the Mobile Contact to synchronize the contacts you add, edit, and delete on the mobile phone to your phone.

**Before you begin**

Make sure your Bluetooth-enabled mobile phone has been paired with and connected to your phones, and mobile contact sync feature is enabled.

**Procedure**

1. Go to  > Local Directory > Mobile Contacts.
2. Select  .  
The phone prompts “Updating, please wait...”.

Note: If you disconnect the mobile phone from the phone when the phone is updating the Mobile Contacts, the phone screen will prompt “Fail to download mobile contacts!”, and the mobile contacts disappear from the phone directory list.



**Remote Phone Book**

If the Remote Phone Book feature has been enabled by your system administrator, you can access your corporate directory directly from your phone.

**Searching for Remote Phone Book contacts**

In the Remote Phone Book, you can enter search criteria to find your desired contact quickly.

**Procedure**

1. Select  > Local Directory > Remote Directory.
2. Select the desired remote phone book.
3. Do one of the following:
  - Select  .  
Enter your search criteria in the search field.
  - Select the desired letter (for example, T) along the right side to jump to contacts whose names start with T or t.

**Viewing Remote Phone Book contacts**

You can view the contact list of the remote phone book on your phone.



**Procedure**

1. Select  > Local Directory > Remote Directory.

**Saving a Remote Phone Book contact to the Local Directory**

You can save any remote phone book contact to the Local Directory, to conveniently call this contact when you cannot access the remote phone book.



**Procedure**

1. Select  > Local Directory > Remote Directory.
2. Select the desired remote phone book.
3. Tap the desired contact and select  .
4. Select Add.
5. Select Local Directory from the Group field.
6. Select Done.

**Saving a Remote Phone Book contact to the Blacklist**

You can save any Remote Phone Book Contact to the Blacklist on the phone, to prevent this contact from calling you.

**Procedure**





1. Select  > Local Directory > Remote Directory.
2. Select the desired remote phone book.
3. Tap the desired contact and select .
4. Select Add.
5. Select Blacklist from the Group field.
6. Select Done.

## Call history

The call history list includes Missed Calls, Placed Calls, Received Calls and Forwarded Calls, and each list holds 100 entries.

### Call history icons



#### Each icon in the call history

Icons	Description	Icons	Description
	Received Call		Missed Call
	Placed Call		Forwarded Call

### Viewing History Records

The History Record saves the call information such as the caller's name and number, local line and call duration.



**Procedure**

1. Tap .
2. Tap All Calls to select the desired list.
3. Select  after the desired entry.

### Saving a History Record to Local Directory

To identify a call the next time, you can save a History Record to the Local Directory.

**Procedure**



1. Select .
2. Tap All Calls to select the desired list.
3. Select  >  > Add.
4. Edit the contact information.
5. Select Done.

### Saving a History Record to Blacklist

You can prevent someone from calling you again by saving a History Record to Blacklist.



**Procedure**

1. Tap .
2. Tap All Calls to select the desired list.
3. Select  > Blacklist.
4. Edit the contact information.
5. Select Done.



**Deleting history records**

You can delete one or all call records from the call history list.

**Deleting a call record**

You can delete any call record from the call history list.



**Procedure**

1. Tap .
2. Tap All Calls to select the desired list.
3. Select  after the desired entry, and then tap Delete.
4. The phone prompts you to delete the record or not.
5. Select OK.

**Deleting all call records**

You can delete all call records from the call history list.

**Procedure**

1. Select .
2. Tap All Calls to select the desired list.
3. Long tap a contact.
4. Tap the radio box on the top-right of the screen.
5. Select  > Delete.  
The phone prompts you to delete all the records or not.
6. Select OK.

---

**Customizing your phone**

You can make your phone more personalized by customizing various settings.

**Changing the administrator password**

By default, you require an administrator password to access the Advanced/Advanced Settings menu. The default password is @N3ta!k2@2\* . For security reasons, you should change the default password as soon as possible.

Note: If you do not change the default password, the phone displays a warning icon in the status bar.

**Procedure**

1. Go to More > Advanced > Set Password.
2. Enter your old and new password information.
3. Select .

## Wallpaper

You can change the background picture that is displayed on your phone.

The phone comes with a default background picture, you can change it to another built-in picture. You can also use a custom picture uploaded by your system administrator as the wallpaper.

### Changing wallpaper on idle screen

You can set one of your pictures as the background image on your phone's idle screen.

#### Procedure

1. Go to More > Basic > Display > Wallpaper.
2. Select Set Wallpaper.

## Screen saver

The screen saver starts automatically when your phone has been idle for the preset waiting time. You can stop the screen saver by touching the screen or tapping any key.

### Changing the waiting time for screen saver

You can set the waiting time after no activity before displaying the screen saver.

#### Procedure

1. Go to More > Basic > Display > Screensaver.
2. Select the desired waiting time from the Wait Time field.
3. Select  .

### Disabling time & date and status icons display

You can disable your phone to display time, date and status icons on the screen saver.

Note: You cannot configure Time & Date and status icons display if your system administrator has set your phone to display custom information on the screen saver.

#### Procedure

1. Go to More > Basic > Display > Screensaver.
2. Select Disabled from the Display Clock field.
3. Select  .

## Setting the screen saver type

The screen saver can start with different types and you can set it manually. You can choose one of the following screen saver types:

- System
- Custom

### Before you begin

If you want to set a custom picture as the screen saver, make sure that the custom picture has been uploaded by your system administrator.

If you want to show custom information on the screen saver, make sure that the custom information has set by your system administrator.

**Procedure**

1. Go to More > Basic > Display > Screensaver.
2. Select the desired screen saver type from the Screensaver Type field.
  - If you select System.  
The phone automatically sets the built-in picture as the screen saver.
  - If you select Custom.  
The phone automatically set the custom pictures as the screen saver, and display these pictures alternately.
3. Select  .

**Changing the backlight and time**

You can change the brightness of the phone screen during phone activity and inactivity. The brightness automatically changes after the phone has been idle for a specified time.

You can change the screen backlight and time in the following settings:

- **Active level:** The brightness level of the phone screen when the phone is active. Digits 1 to 10 represent different brightness levels. 10 is the brightest level
- **Inactive level:** The brightness of the phone screen when the phone is inactive. You can select a low brightness or turn off the backlight
- **Backlight time:** The delay time to change the brightness of the phone screen when the phone is inactive. Backlight time includes the following settings:
  - Always on: Backlight is on permanently
  - 30min, 1h, 2h, 4h, 6h, 8h or 12h: Backlight is changed when the phone is inactive after the designated time

**Procedure**

1. Go to More > Basic > Display > Backlight.
2. Select the desired level from the Active Level field.
3. Select the desired level from the Inactive Level field.
4. Select the desired time from the Backlight Time field.
5. Select  .

**Changing the language**

Your phone supports several languages that you can choose to use on the phone.

Contact your system administrator to find out exactly which languages are supported on your phone.

**Procedure**

1. Go to More > Basic > Language.
2. Select the desired language.
3. Select  .  
The phone language is changed to the selected one.

**Time and date**

You can set the time and date manually. The time and date formats are also variable.

**Setting the time and date manually**

If your phone cannot obtain the time and date automatically, you can set it manually.

**Procedure**

1. Go to More > Basic > Time & Date > General.
2. Select Manual Setting from the Type drop-down menu.
3. Edit the date and time.
4. Select  .  
The time and date set on the phone will be changed accordingly.

Note: After the phone reboots, it will be forcibly switched to obtain the time and date from the NTP server

**Changing the time and date format**

You can set the phone to display the time in 12-hour format or 24-hour format. You can also change the date format, including the options to display the day (D), month (M), and year (Y).

Note: Your system administrator can customize the date format.

**Procedure**

1. Go to More > Basic > Time & Date > Time & DateFormat.
2. Select the desired time format or dateformat.
3. Select  .

**Phone lock**



Phone lock helps you protect your phone from unauthorized use.

**Setting the Phone lock**

You can manually lock the phone or wait a specified time to automatically lock the phone. When your phone is locked, you can:

- Dial emergency numbers
- Reject incoming calls
- Answer incoming calls
- End the call

**Procedure**

1. Go to More > Advanced (default password: @N3ta!k2@2\* ) > Phone Lock.
2. Enter the desired PIN (default PIN: 123) in the Unlock PIN field.
3. Select  .
4. Select Enabled from the Lock Enable field.
5. Enter the desired interval (0 – 3600 seconds) in the Auto Lock field.
6. Select  .

**Setting a Phone Lock key**

You have to set a Phone Lock key manually to lock your phone.

**Procedure**

1. Tap DSSKey.
2. Long tap the desired line key.
3. Select Key Event from the Type field.
4. Select Phone Lock from the Key Type field.
5. (Optional) Enter the string that will display on the phone screen in the Label field.

6. Select  .

## Locking your phone manually

You can lock the phone manually before the phone is automatically locked.

### Before you begin

Make sure that the phone lock is set and you have set a phone lock key.

### Procedure

1. Tap the phone lock key.  
The lock icon appears on the phone screen.

## Unlocking your phone

You can use an unlock PIN to unlock the phone.

If you forget the unlock PIN, you can enter the administrator password to unlock your phone, and then automatically access the PIN change screen.

### Procedure

1. Tap the screen or tap the Mute touch key, the phone prompts you to enter an unlock PIN.
2. Enter the desired PIN (default: 123) in the Unlock PIN field.
3. Select OK.  
The lock icon disappears from the phone screen.

## Changing your phone unlock PIN

The default unlock PIN is "123". For security reasons, you should change the default unlock PIN as soon as possible.

### Procedure

1. Go to More > Basic > Change PIN.
2. Enter your old and new unlock PIN respectively. The unlock PIN length must be within 15 digits.
3. Select  .

## Audio settings

You can change the basic audio settings on your phone.

### Adjusting the volume

You can adjust the volume of the ringer, media, and audio during a call.

### Procedure

1. Press the Volume touch key.

### Setting the ring tone

You can set distinctive ring tones for groups or contacts in your Local Directory so that you can identify the caller when your phone rings.

The ring tones are used according to this priority: Contact ring tone>Group ring tone>Account ring tone >Phone ring tone.

### Setting a ring tone for the Phone

You can choose a ring tone for all incoming calls.

### Procedure

1. Go to More > Basic > Sound > Ring Tones > Common.
2. Select the desired ring tone.

3. Select .

### Setting a ring tone for an Account

You can select a unique ring tone for an individual account.

#### Procedure



1. Go to More > Basic > Sound > Ring Tones.
2. Select the desired account.
3. Select the desired ring tone.  
If Common is selected, this account will use the ring tone selected for the phone.
4. Select .

### Setting a ring tone for a group

You can select a unique ring tone for various groups in your Local Directory.

Note: You can only set a ring tone for a group that is added manually.



#### Procedure

1. Select  > Local Directory.
2. Select  after the desired group, and then select Ring.
3. Select the desired ring tone.  
If Auto is selected, this group uses the ring tone according to the default priority.  
If a specific ring tone is selected, this group uses the ring tone according to the priority: Contact ring tone>Group ring tone.
4. Select OK.

### Setting a ring tone for a contact

You can select a unique ring tone for various contacts in your Local Directory. This helps you quickly identify callers according to the ring tones.

#### Procedure

1. Select .
2. Select Local Directory to select the desired contact group.
3. Tap the desired contact and select .
4. Select the desired ring tone from the Ring field.  
If Auto is selected, the contact uses the ring tone according to the default priority.
5. Select Done.

### Disabling the key tone

If you disable the key tone, the phone will not produce a sound when pressing the keypad keys.

#### Procedure

1. Go to More > Basic > Sound > Key Tone.
2. Turn off Key Tone.
3. Select .

### Enabling touch tone

If you enable touch tone, the phone will produce a sound when you tap an option on the phone screen.

**Procedure**

1. Go to More > Basic > Sound > TouchTone.
2. Turn on Touch Tone.
3. Select  .

---

## Using the CP Wireless Microphone CPW25

The Yealink CPW25 is a CP Wireless Expansion Mic which works as an audio input device for CP925 phone. It features superior audio technology and supports 360-degree voice pickup range at a radius of up to 10 feet (3 meters) without any wiring troubles.

**CPW25 LED Instructions**

The CPW25 LED indicator indicates the call, register, and battery's system status. Mute button LED indicator on the wireless expansion microphone CPW25:

LED status	Description
Solid green	The phone enters the dialing screen. The phone is in a call and unmuted.
Fast flashing red	The phone is receiving an incoming call.
Solid red	The phone is muted.
Fast flashing yellow	The CPW25 is in the registration mode.
Slowly flashing yellow	The CPW25 has registered with the phone, but the CPW25 is out of range. The CPW25 has registered with the phone, but the phone is turned off.
Flashing red and green alternately	The phone is searching for the CPW25 which has registered with it.
Off	The CPW25 is in the idle mode.

Battery LED indicator on the wireless expansion microphone CPW25:

LED status	Description
Solid green for one second and then off	The CPW25 is turned on.
Solid green for 3 seconds and then off	The CPW25 is in the idle mode.
Solid green	The CPW25 is fully charged.
Solid red	The CPW25 is being charged.
Fast flashing red 3 times and then off	The battery capacity is too low to turn on the CPW25.
Slowly flashing red	The battery capacity is less than 10%.
Off	If you tap the mute button, the battery LED indicator on the CPW25 is still off, it means the CPW25 is turned off.

**Charging the CPW25**

The phone can power to the USB port, so you can directly charge the CPW25 on the phone.

If it is the first time you use the CPW25, you need to fully charge the CPW25 for normal use. If the CPW25 is not in use, we recommend you charge the CPW25 even when the battery is full.

**Procedure**

1. Put the CPW25 on the charging cradle.
2. Connect the charging cradle to the USB port on the phone using a USB cable.



During charging, the battery LED indicator on the CPW25 glows solid red. When the battery capacity reaches 100%, the battery LED indicator on the CPW25 will glow solid green.

Note: If your system administrator disables the USB port of the phone, the phone cannot power to the USB port.

## Turning the CPW25 On or Off

To use the CPW25 as the external audio input device, you need to turn the CPW25 on first.

### Procedure

1. You can do the following to turn on the CPW25:
  - Put the CPW25 on a charging cradle or connect to the charging cable, the CPW25 starts up automatically
  - If you do not charge the CPW25, long tap  on the CPW25 for 3 seconds  
The battery LED indicator glows green for one second and then goes out
2. To turn off the CPW25, long tap  on the CPW25 until the battery LED indicator glows red for 3 seconds and then goes out.

Note: When the battery is below 10%, the battery LED indicator flashes red, and it will automatically shut down after 10 minutes of standby; when the low battery reaches 0%, it will automatically shut down.

## Registering the CPW25

To ensure good voice quality of the calls on the phones, you can register CPW25 with the phone to use the CPW25 as the external audio input device.

### Procedure

1. Go to More > MIC.
2. Select OK when the phone prompts you that turning on the Bluetooth microphone will turn off Bluetooth.
3. Select  to search for CPW25.
4. Turn on the CPW25.

The CPW25 will enter the registration mode automatically. And the mute LED indicator on the CPW25 fast lashes yellow.

The CPW25 registers with the phone automatically. If the registration is successful, the mute LED indicator on the CPW25 goes out and phone screen prompts the CPW25 information: battery, work time and standby time.



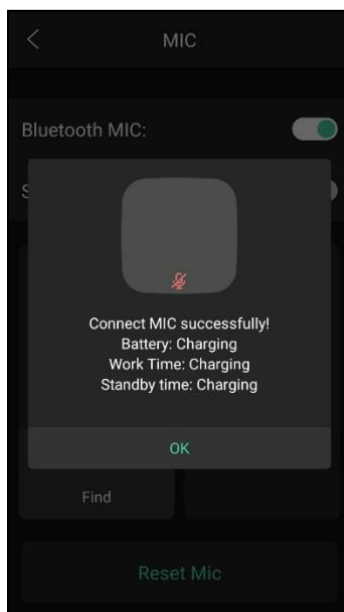

## Registering the CPW25 with another phone

When you no longer want to register with the current phone, you can register the CPW25 with another phone.

CPW25 can only be registered with one phone at a time, if you register the CPW25 to another phone, the CPW25 will deregister from the previous phone automatically.

### Procedure

1. Go to More > MIC.
2. Turn on Bluetooth MIC.
3. Select OK when the phone prompts you that turning on the Bluetooth microphone will turn off Bluetooth.
4. Select + to search for CPW25.
5. Put the CPW25 on the charging cradle or connect to the charging cable and make sure it is charging.
6. Long tap the  on the CPW25 for 5 seconds.

The CPW25 enters the registration mode. And the mute LED indicator on the CPW25 fast flashes yellow. The CPW25 registers with the phone automatically.

## Unregistering the CPW25

When you no longer need the CPW25 as the external audio input device, you can unregister it.





### Procedure

1. Go to More > MIC.
2. Select the desired microphone and then select Detail.
3. Select Unbind.

## Muting or unmuting the CPW25

During the call, you can mute or unmute the CPW25 at any time.

**Procedure**

1. Tap  to mute the call.
2. The mute LED indicator glows red. And the icon  appears in the status bar of the phone.
3. Tap  again to unmute the call.
4. The mute LED indicator glows green. And the icon  disappears from the status bar of the phone.

**Viewing CPW25 information**

When the CPW25 is registered with the phones, you can view CPW25 status on the phone. Available information of CPW25 includes:

- Register status
- MIC model
- MICPOD MAC
- Battery
- Standby time
- Work time

**Procedure**

1. Go to More > MIC.
2. Select Detail from the desired microphoneblock.

**Finding the CPW25**

You can find the CPW25 which has registered with the phone.

**Procedure**

1. Go to More > MIC.
2. Select Find from the desired microphone block.
3. The mute key LED indicator on the registered CPW25 flashes red and green alternately.

---

**Connecting a mobile phone via Bluetooth**

Bluetooth enables low-bandwidth wireless connections within a range of 10 meters (32 feet). The best performance is in the range of 1 to 2 meters (3 to 6 feet).

You can pair and connect the Bluetooth-enabled mobile phone with your phone. After connection, you can do the following:

- Make and receive mobile calls on the phone
- Use the phone as a Bluetooth speaker for your mobile phone to playmusic
- Merge the calls on your phones, the PSTN and connected mobile phone into a hybrid UCconference

**Activating the Bluetooth mode**

You should activate the Bluetooth mode first when you need to connect the Bluetooth device to your phone.

**Procedure**

1. Tap .
2. Turn on Bluetooth.  
The phone scans the available Bluetooth devices automatically.

## Pairing and connecting the Bluetooth-enabled mobile phone



After pairing and connecting the Bluetooth-enabled mobile phone, you can use the sync feature.

You can pair with countless mobile phones with your IP phones but only one mobile phone can be connected at a time.

### Before you begin

Make sure that the Bluetooth-enabled mobile phone is discoverable.

### Procedure

1. Tap .
2. Select  to search for the Bluetooth-enabled mobile phone.
3. Tap your Bluetooth-enabled mobile phone.  
The phone will prompt the connection passkey on the phone screen.
4. Make sure your mobile phone is showing the same passkey, and then select OK on both mobile phone and phone.  
(Optional) Select OK to enable the mobile contacts sync feature, or select Cancel to disable mobile contacts sync feature.

Note: If you enable mobile contacts sync feature, you also need to authorize the phone to sync the contacts temporarily on the mobile phone.

## Syncing the mobile contacts to the phone

You can sync mobile contacts to your phone. This is a convenient way to view a contact without accessing your mobile phone.



### Enabling the Mobile Contacts Sync feature

To sync the mobile contacts to the phone, you should enable the sync feature in advance.

### Before you begin

Make sure that the Bluetooth-enabled mobile phone is paired and connected to your phone.

### Procedure

1. Tap .
2. Tap  after the connected Bluetooth-enabled mobile phone name.
3. Turn on Mobile Contacts Sync.
4. You need to authorize the phone to synchronize the contacts temporarily on the mobile phone first, and then the mobile contacts directory will appear in the phone directory list.

### Viewing your mobile contacts

You can view a list of mobile contacts on the phone.

### Before you begin

Make sure that the mobile contact sync feature is enabled.



### Procedure

1. Go to  Local Directory > Mobile Contacts.
2. The contacts stored in your mobile phone will display in the Mobile Contacts list.

### Disabling the Mobile Contacts Sync feature

When you no longer view and use the mobile contacts on the phone, you can disable the sync feature.

**Procedure**



1. Tap .
2. Tap  after the connected Bluetooth-enabled mobile phone name.
3. Turn off Mobile Contacts Sync.  
The mobile contacts directory disappears from the phone directory list.

Tip: The mobile contacts directory also disappears from the phone directory list after deactivating the Bluetooth mode.

**Enabling the phone audio**

When you enable the phone audio, the phone can act as a speaker and microphone for your connected mobile phone. The call is made through your mobile phone, but the audio is present on the phone and the call is also controlled by the phone.



**Procedure**

1. Tap .
2. Tap  after the connected device.
3. Turn on phone audio.

**Enabling the phone media**

You can enable the Media Audio feature to use the phone as a Bluetooth speaker for your mobile phone/PC to play music.

**Procedure**

1. Tap .
2. Tap  after the connected device.
3. Turn on Media Audio.

**Handling a mobile phone call on the phone**

You can handle a mobile phone call on your phone, the phone acts as a speaker and microphone for your mobile phone.

**Before you begin**

1. Make sure that the Bluetooth-enabled mobile phone is paired and connected to your phone.
2. You have enabled the phone audio.

**Procedure**

Do the following on the phone:

- Place a call
- Answer a call. An incoming call to your mobile phone is also shown on the phone, you can answer the call on the phone. The contacts will be firstly matched with those in the mobile contacts directory to present the caller identity when receiving a mobile phone call
- During the call, you can hold/resume, mute/unmute or end the call on the phone



**Editing device name of your phone**

You can edit the device name of your phone for easily recognizable.

**Before you begin**

Make sure that the Bluetooth mode is activated.

**Procedure**

1. Tap  > Edit My Device Information.  
The phone screen displays the device name.
2. Enter the desired name in the Device Name field.
3. Select .



**Making the phone discoverable**

If you make your phone discoverable to other Bluetooth devices, other Bluetooth devices can scan and find your IP phone.

**Before you begin**

Make sure that the Bluetooth mode is activated.



**Procedure**

1. Tap  > Edit My Device Information.
2. Turn on Open Discover.
3. Select .

**Deleting the paired Bluetooth device**

You can delete the Bluetooth device paired from your phone, the next time you activate the Bluetooth mode, the phone will not automatically connect to this device.

**Procedure**

1. Tap .
2. Tap  after the connected device and select Unpair.

**Disconnecting the Bluetooth device**

You can disconnect your Bluetooth device from your phone. When you disconnect a Bluetooth device, it remains paired and you can reconnect it to your phone.

**Procedure**

1. Tap .
2. Tap the connected Bluetooth device.

**Deactivating the Bluetooth mode**

After you deactivate the Bluetooth mode, the Bluetooth device will disconnect from your phone, but it remains paired and you can reconnect it to your phone.

**Procedure**

1. Tap .
2. Turn off Bluetooth.

---

**Wireless network**

The phone can be connected to the wireless network if Wi-Fi is available within the area.

Note: Enabling Bluetooth may degrade your wireless network connection. For improved wireless network performance, you should disable Bluetooth when it is not in use.



## Activating the Wi-Fi mode

You can activate the Wi-Fi mode to connect your phone to an available wireless network.

### Procedure

1. Go to More > Basic > Wi-Fi.
2. Turn on Wi-Fi.

The phone scans the available wireless networks in your area.

## Connecting to the wireless network

After you have activated the Wi-Fi mode, you can connect the phone to the wireless network.

### Connecting to an available wireless network manually

When you enable the Wi-Fi mode, the phone is automatically connected to the saved wireless network, you can also connect it manually.

### Before you begin

Get the password of the wireless network from your system administrator. Make sure that the Wi-Fi mode is activated.

### Procedure

1. Go to More > Basic > Wi-Fi.
2. Tap the desired wireless network to connect.
3. Enter the password in the Password field.
4. Select Save.

### Connecting to the wireless network Using WPS

The Wi-Fi protected setup (WPS) provides simplified mechanisms to configure secure wireless networks which can automatically configure a wireless network with a network name (SSID) and strong WPA data encryption and authentication.



There are two supported methods in the Wi-Fi protected setup:

- Push Button Configuration (PBC): The user simply has to press the WPS key on both the phone and gateway/router to connect
- Personal Identification Number (PIN): The user enters the PIN generated randomly by the phone on the gateway/router to connect

### Before you begin

Make sure that the Wi-Fi mode is activated.

### Procedure

1. Go to More > Basic > Wi-Fi.
2. Do one of the following:
  - Select  WPS to use the PBC method, then long press the WPS key on your gateway or router
    - Once the WPS setup has completed successfully, the phone screen will prompt "Connect Success"
  - Select  WPS-PIN to use the PIN method, then log into your gateway or router's web interface, and configure it to search the clients. For more information, refer to the documentation from the gateway or router manufacturer
    - Once WPS-PIN setup has completed successfully, the web interface of the gateway or router will prompt that the connection is successful

### Adding a wireless network manually

If SSID broadcast on your gateway or router is disabled, the wireless network might not appear in the scanning results. In that case, you must manually add a wireless network. The phone can store up to 5 connected wireless networks.

### Before you begin

Get the available wireless network information from your system administrator. Make sure that the Wi-Fi mode is activated.

#### Procedure

1. Go to More > Basic > Wi-Fi.
2. Tap Known Network(s) and select  .
3. Enter the desired SSID in the SSID field.
4. Do the following:
  - Select None from the Security Mode field
  - If you select WEP, WPA/WPA2 PSK from the Security Mode field, enter the desired password
  - If you select 802.1x EAP from the Security Mode field, select the desired EAP method and enter the desired values in the corresponding fields
5. Select Save.

The connected wireless networks will be saved to the Known Network(s) list.

### Viewing the wireless network information

You can view the wireless network information (for example, Profile Name, SSID or Signal Strength) when the Wi-Fi mode is activated.

#### Procedure

1. Go to More > Basic > Wi-Fi.

### Disconnecting the wireless network connection

When you no longer want to connect to the current wireless network, you can disconnect it.

#### Procedure

1. Go to More > Basic > Wi-Fi.
2. Tap the connected wireless network.

Tip: You can also disconnect the wireless network when deactivating the Wi-Fi mode.

### Deactivating the Wi-Fi mode

You should deactivate the Wi-Fi mode when you need to connect your phone to the wired network.

#### Procedure

1. Go to More > Basic > Wi-Fi.
2. Turn off Wi-Fi.

---

## Maintaining your phone

When your phone is unable to operate properly, you need to investigate or troubleshoot issues along with other tasks your system administrator may ask you to perform.

### Warnings

When some issues occur on your phone, a warning icon appears in the status bar. The following lists the detailed situations:

- The default password is being used
- Failed to register the account
- Provisioning credentials are wrong
- Network is unavailable



### Investigating warnings

The warning icon lets you know that your phone has one or more important issues. You can view details about warnings on the Status screen.

#### Procedure

1. Go to More > Status > General.  
The Warnings screen is displayed listing any issues.

### Clearing warnings

You can temporarily remove the warning icon from the status bar.

However, the warning icon appears again after the phone reboots or the phone has a new warning if the issue is not solved.

#### Procedure

1. Go to More > Status > General.
2. Tap the Warning field.
3. Tap OK.

### Rebooting your phone

The improper operation may cause malfunction. If the malfunction occurs, your system administrator may ask you to reboot your phone.

#### Procedure

1. Go to More > Basic > Reboot > Reboot.  
The phone prompts you to reboot the phone or not.
2. Select OK.

### Resetting to factory settings

When some issues occur on your phone and you have tried all troubleshooting suggestions but still do not solve the problem, you can reset your phone to factory configurations.

This operation will delete all your personal configuration settings, and reset all settings to the factory defaults. Check with your system administrator if the personalized settings are kept before resetting your phone to factory settings.

#### Procedure

1. Go to More > Advanced (default password: @N3ta!k2@2\* ) > Reset Config.
2. Select Reset to Factory Settings.  
The phone prompts you to reset the setting or not.
3. Select OK.  
The phone begins resetting.  
After reset, the screen prompts "Welcome Initializing...Please wait". The phone will be reset successfully after startup.

Note: Reset of your phone may take a few minutes. Do not power off until the phone has started up successfully.

### Updating the phone configuration

Your system administrator may ask you to update the configuration for your phone to apply any changes to system settings, which you can do without restarting it.

#### Procedure

1. Go to More > Basic > Update Configuration > Auto Provision.
2. Select OK.

### Clearing user's personalized configuration settings

You can clear the personalized configuration settings manually on the phone.

#### Before you begin



Your system administrator has enabled the phone to keep the user's personalized settings after auto provisioning.

### Procedure

1. Go to More > Basic > Reset local settings> Reset local settings.  
The phone prompts you to reset the local settings or not.
2. Select OK.

---

## Notices

The specifications and information regarding the products in this guide are subject to change without notice. All statements, information and recommendations in this guide are believed to be accurate and presented without warranty of any kind, express or implied. Users must take full responsibility for their application of products.

---

## Technical support

For additional support information please visit the One Talk support site ([verizonwireless.com/support/one-talk/](http://verizonwireless.com/support/one-talk/)) for the latest guides, FAQs, product documents and more.

---

## Important customer information

To avoid electric shock, use caution when connecting cables. For example, do not connect safety extra-low voltage (SELV) circuits to telephone-network voltage (TNV) circuits. LAN ports contain SELV circuits, and WAN ports contain TNV circuits.

Some LAN and WAN ports both use RJ-45 connectors.

To avoid electric shock, do not operate the product or connect or disconnect cables during electrical storms. To avoid electric shock, do not use this product in or near water.

To reduce the risk of fire or overheating, keep this product in well-ventilated areas, away from radiators or other heat sources. Do not block cooling vents.

The plug-socket combination must be accessible at all times because it serves as the main power-disconnecting device.

Use only the manufacturer-provided AC adaptor approved for use with this product. Use of another AC adaptor may cause a fire or explosion.

This product relies on short-circuit (overcurrent) protection installed in your home or office. Ensure that a fuse or circuit breaker no larger than 120 VAC, 15 A U.S. is used on the phase conductors (all current carrying conductors).

Unplug this product from the wall outlet and refer servicing to qualified service personnel under the following conditions:

1. When the power cord or plug is damaged or frayed.
2. If liquid has been spilled into the product.
3. If the product has been exposed to rain or water.
4. If the product does not operate normally when the operating instructions are followed. Adjust only those controls that are covered by the operating instructions, since improper adjustment of other controls may result in damage and will often require extensive work by a qualified technician to restore the product to normal condition.



---

## WEEE warning

To avoid the potential effects on the environment and human health as a result of the presence of hazardous substances in electrical and electronic equipment, end users of electrical and electronic equipment should understand the meaning of the crossed-out wheeled bin symbol. Do not dispose of waste electrical and electronic equipment (WEEE) as unsorted municipal waste and collect such WEEE separately.

---

## Disclaimer

The specifications and information regarding the products in this guide are subject to change without notice. All statements, information, and recommendations in this guide are believed to be accurate and presented without warranty of any kind, express or implied. Users must take full responsibility for their application of products.

Yealink Network Technology CO., LTD., makes no warranty of any kind with regard to this guide, including, but not limited to, the implied warranties of merchantability and fitness for a particular purpose. Yealink Network Technology CO., LTD., shall not be liable for errors contained herein nor for incidental or consequential damages in connection with the furnishing, performance, or use of this guide.

---

## Important 911 emergency response information

If you call 911, emergency service responders will be sent to the registered location you provided when you provisioned this phone. An incorrect address could result in incorrect routing of 911 calls and dispatch of emergency personnel to the wrong location, so please contact your administrator if your registered location is not accurate.

Once a 911 call is placed, the device will enter for a period of five minutes Emergency call back mode and on the LCD screen of the device the message displayed will say **“Emergency Call Activated: features restored after 5 minutes”**. What this means is that for a period of five minutes all of the advanced One Talk calling features will not work to allow the 911 operator to contact the number placing the 911 call during those five minutes. Once the five minutes have passed, the phone will resume normal operation.

Data and voice functionality (including the ability to make and receive 911 calls) will not be available during a power outage, broadband connection failure or other service disruption. Neither Verizon Wireless nor any of its affiliates shall be liable for any service outage and/or inability to access emergency service personnel, nor shall Verizon Wireless or any of its affiliates be responsible for the acts or omissions of emergency response center personnel.

---

## Declaration of conformity



Hereby, Yealink Network Technology CO., LTD., declares that this phone is in conformity with the essential requirements and other relevant provisions of the Conformité Européene (CE) and the Federal Communications Commission (FCC). You can find the CE and FCC information from the label on the back of the IP phone.

---

## CE mark warning

This device is marked with the CE mark in compliance with Radio equipment and Telecommunications Terminal Equipment (R&TTE Directive 1999/5/EC).

---

## Part 15 FCC Rules

Any changes or modifications not expressly approved by the party responsible for compliance could void the user's authority to operate the equipment.

This device is compliant with Part 15 of the FCC Rules. Operation is subject to the following two conditions:

1. This device may not cause harmful interference.
2. This device must accept any interference received, including interference that may cause undesired operation.

---

## Class B digital device or peripheral

Note: This equipment has been tested and found to comply with the limits for a Class B digital device, pursuant to Part 15 of the FCC Rules. These limits are designed to provide reasonable protection against harmful interference in a residential installation. This equipment generates, uses and can radiate radio frequency energy and, if not installed and used in accordance with the instructions, may cause harmful interference to radio communications. However, there is no guarantee that interference will not occur in a particular installation. If this equipment does cause harmful interference to radio or television reception, which can be determined by turning the equipment off and on, the user is encouraged to try to correct the interference by one or more of the following measures:

1. Reorient or relocate the receiving antenna.
2. Increase the separation between the equipment and receiver.
3. Connect the equipment into an outlet on a circuit different from that to which the receiver is connected.
4. Consult the dealer or an experienced radio/TV technician for help.

---

## Important safety precautions

Please read the following important safety notices and instructions before installing or using the product.

A DANGER warning refers to situations that could cause bodily injury

A CAUTION warning refers to situations that could result in equipment malfunction or damage

1. Follow all warnings and instructions marked on the product.
2. Unplug this product from the wall outlet before cleaning. Do not use liquid cleaners or aerosol cleaners. Use an antistatic cleaning pad for cleaning.
3. Do not use this product near water.
4. Do not place this product on an unstable cart, stand or table. If the product falls, it could be seriously damaged.
5. This product should be operated using the type of power indicated on the marking label. If you are not sure of the type of power available, consult your dealer or local power company.
6. Do not allow anything to rest on the power cord. Do not locate this product where people will walk on the cord.
7. Never push objects of any kind into this product through cabinet slots as they may touch dangerous voltage points or short out parts that could result in a fire or electric shock.
8. Never spill liquid of any kind into or onto the product.
9. Do not attempt to service this product yourself, as opening or removing covers may expose you to dangerous voltage points or other risks.
10. Refer all questions regarding servicing of this product to qualified service personnel.

---

## Danger—electric shock and fire

Electric current from power, telephone and communication cables is hazardous and could result in electric shock and/or fire.

---

## Learn more

For more information, visit [www.onetalk.com](http://www.onetalk.com)