



P O R C E L A I N T I L E S

## EXPANDING SURFACES

### SERVICES

- 4 **ITALIAN PORCELAIN SURFACES**
- 5 **UNLOCK THE POTENTIAL OF THE SLAB**
- 6 **INTRODUCING CUT-TO-SIZE**

### VERTICAL CLADDING

- 7 **WORKING WITH LARGE FORMATS**
- 8 **VERTICAL CLADDING APPLICATIONS**
- 9 **BOOKMATCHING** PRECISION CUTTING
- 11 **COLUMNS** COLUMN CLADDING
- 13 **FIREPLACES** 3D SURROUNDS

### FLOOR

- 17 **BESPOKE FLOORING DESIGNS**
- 18 **LARGE FORMAT CUSTOM DESIGNS**
- 19 **INLAID FLOORING**

### INLAYS AND TOPS

- 22 **FURNITURE INLAYS**
- 23 **REPLACEMENT TABLE TOPS**

### 3D CLADDING APPLICATIONS

- 25 **3D CLADDING** PRACTICAL APPLICATIONS
- 27 **OFFICE STORAGE & DESK**
- 29 **SURFACE DECOR** FLUTED AND STRIPS DECOR
- 30 **OUTDOOR APPLICATIONS**

### STEPS AND TREADS

- 31 **STEPS AND TREADS** INDOOR AND OUTDOOR
- 34 **NOSING** TREAD AND NOSING PROFILES
- 36 **SWIMMING POOL** COPING STONES
- 37 **PROFILING** MITRES AND EDGE PROFILES

## NOW IMAGINE: BATHROOM AND WELLNESS

### WASHBASINS

- 44 **GEMINI** SURFACE-MOUNTED SINGLE WASHBASIN
- 46 **LIBRA** WALL-MOUNTED SINGLE WASHBASIN
- 50 **LEO** WALL-MOUNTED SLIMLINE WASHBASIN
- 54 **CAPRICORN** WALL-MOUNTED DOUBLE WASHBASIN
- 58 **SCORPIO** WALL-MOUNTED DOUBLE TROUGH BASIN

### VANITIES

- 60 **VIRGO** VANITY TOP WITH STORAGE
- 63 **VANITY TOP** WALL-MOUNTED VANITY TOP FOR VESSEL BASIN
- 64 **VANITY TOP WITH CUT-OUT** VANITY TOP FOR DROP-IN BASIN
- 69 **VANITY SHELF** WALL-MOUNTED VANITY SHELF
- 70 **GLOBO** BATHROOM STORAGE UNIT

### FREE-STANDING BASINS

- 72 **VENUS** FREE-STANDING SINGLE WASHBASIN
- 75 **SATURN** LUXURY FREE-STANDING DOUBLE BASIN
- 76 **MERCURY** FREE-STANDING TROUGH WASHBASIN

### BATHROOM ADDITIONS

- 79 **BASIN BASE & TAP SYSTEMS**
- 80 **POCKETS, CAVITIES & RECESSES**
- 81 **STORAGE OPTIONS**
- 82 **INTERNAL VENEER** COLOUR OPTIONS
- 83 **SHOWER TRAY** LOW PROFILE TRAY WITH DRAINAGE SYSTEM
- 84 **3D MIRROR** DEEP FRAMED VANITY MIRROR

## NOW IMAGINE: FURNITURE COLLECTION

### COLLECTION ROMANO

- 88 **TAVOLINO ROMANO**
- 91 **TAVOLO LUNA ROMANO**
- 92 **TAVOLO MEZZALUNA ROMANO**

### COLLECTION ORIGAMI

- 93 **TAVOLINO ORIGAMI**
- 95 **TAVOLO ORIGAMI**
- 97 **CONSOLLE ORIGAMI**

### COLLECTION VENEZIANA

- 99 **TAVOLO MEZZALUNA VENEZIANA**
- 101 **TAVOLO LUNA VENEZIANA**
- 103 **TAVOLO TELESTO VENEZIANA**
- 105 **CONSOLLE VENEZIANA**

### COLLECTION GESSATO

- 107 **CONSOLLE GESSATO**
- 109 **TAVOLO GESSATO**

### DESIGNER COMMISSIONS

- 111 **TAVOLINO TORNIO**
- 113 **TAVOLINO CUBO**

### TABLE TOPS, INLAYS AND WORKTOPS

- 115 **TABLE TOP** CONFIGURATION
- 116 **TABLE TOP** PROFILES
- 117 **PROFILE BANDING** COLOUR OPTIONS
- 118 **WOOD LEG** MODEL & DECOR OPTIONS
- 119 **WOOD LEG** COLOUR OPTIONS
- 120 **PODIUM** SIDE TABLE PLINTH
- 123 **KITCHEN WORKTOPS** REPLACEMENT COUNTERTOPS

## COLOURS AND STYLES

### PORCELAIN SURFACES

- 128 **PORCELAIN SURFACES REDEFINED**
- 129 **6 MM SLABS**
- 140 **12 MM BOOKMATCHED SLABS**







By combining beauty with technology and sustainability, Italian porcelain slabs have expanded design limits and streamlined production processes, enabling the creation of ever more dynamic spaces... but this innovative material is not only for walls and floors.

Through the Now Imagine campaign, and by demonstrating the material's potential in our showrooms, we hope to inspire designers to think of each slab as a creative surface.

Now Imagine is supported by a full service technical and design solution that enables architects, designers, and product manufacturers to incorporate large format Italian porcelain surfaces into their designs in new and innovative ways.

From laser templating, cutting and manufacturing to delivery and installation we take care of each step. This means there is no risk and no headaches. Create your design, choose from any of the one hundred and fifty available colours and styles, and we'll do the rest.

## ITALIAN PORCELAIN SURFACES

Detailed over the next few pages are design specifications, products and services dedicated to porcelain surfaces that will stretch your imagination. Services that redefine how architects and designers approach material selection, providing creative solutions for the functional and aesthetic requirements of each project. Services that facilitate the creation of luxury stand-alone products such as bathroom vanities and whole home furniture, and help designers and architects transform their ideas into finished projects.

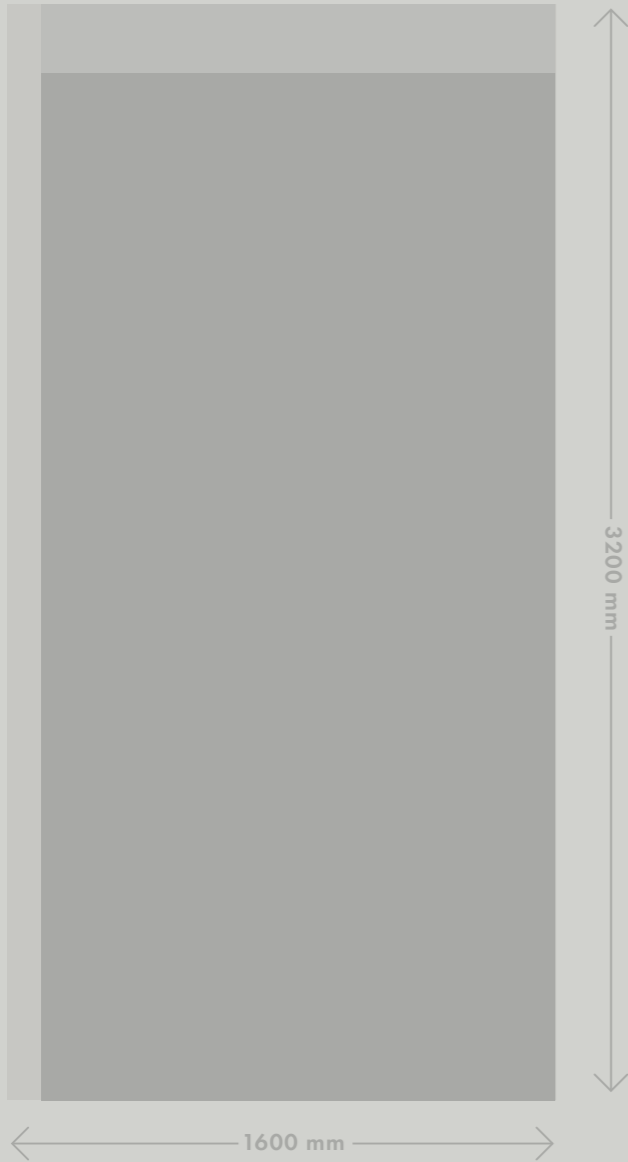

## UNLOCK THE POTENTIAL OF THE SLAB

Large format porcelain slabs are one of the most sustainable and aesthetically appealing surface materials available in the world today. The wider availability of this cutting-edge surface in the UK has transformed the way these materials are used, presenting new beginnings, opportunities, and challenges. To unlock the full potential of large format porcelain slabs, a comprehensive UK-based cut-to-size solution is essential.



**We are that solution.**

Our new cut-to-size and cut-to-shape services empower designers to expand their creative boundaries and reach their design objectives. Cut-to-size benefits architects, designers, and contractors by providing practical solutions to design challenges. It is a comprehensive service that revolutionises how porcelain slabs are specified, offering considerable execution advantages. These advantages include shorter lead times, reduced onsite assembly and installation, less material wastage and lower risk of onsite damages.

## INTRODUCING CUT-TO-SIZE

Porcelain slabs offer an extremely durable surface, but cutting and handling three metre high large formats onsite brings its own challenges, which can often result in chipping or cracking. By utilising our cut-to-size solution, the entire cutting process takes place offsite and is risk-free to you.

Cut-to-size eliminates the need for third-party operations including the transport of slabs between suppliers. Use cut-to-size for surface cladding, custom flooring, inlays and staircases. Also for projects where space is limited and manoeuvring full size slabs is impractical.

This level of support allows designers to have a relaxed approach to specifying large formats, and gives installers the confidence to handle slabs onsite and complete projects successfully. It's a collaboration that adds considerable value to a project, combining our expertise with your creativity, allowing this high-performing material to be specified with confidence and ease.



CUT-TO-SIZE THROUGHOUT RESIDENTIAL PROJECT (FIG.6.1)



## VERTICAL CLADDING

Achieving visual and tactile consistency in a given interior space through the harmonious use of materials, colours, and textures is a fundamental principle of interior design. Cladding is a highly effective way to achieve this, but this does not have to stop at the walls.

Being able to specify large formats on additional vertical surfaces provides exciting new design opportunities. With three metre long slabs you can promote this grand sense of scale, taking full advantage of less grout lines for a more seamless result. Experiment with pattern matching across cladded surfaces and achieve homogeneity and coherence in the design that is not possible with standard formats.

Leverage the longer lengths available with large format porcelain slabs to add interest to architectural details, including mouldings, columns, door skins, steps, archways, fireplace surrounds and feature walls.



VERTICAL CLADDIED SURFACES PRE-CUT OFF-SITE (FIG.7.1)



COUNTER WITH VEIN MATCHED CURVED CORNERS (FIG.8.1)

## CLADDING WITH VEIN MATCHING

Vein matching involves placing panels so that the vein movement found in the material continues across adjacent surfaces. This veining flows from one piece onto the other creating a continuous vein pattern.

Through our cut-to-size services, vein matching can be maintained across cladded surfaces. By pre-cutting each panel offsite, any risk of breakage onsite, or mismatching pieces is significantly reduced. Installers can approach vein matching projects with confidence while designers can execute complex schemes.

12 mm thickness bookmatched slabs are not rectified. This means that for bookmatched designs it will always be necessary to trim all four sides of both slabs. Trimming 12 mm slabs onsite is difficult, which is why we offer a fixed cost slab trimming service where all four edges of the slab are precision cut to your exact specification by CAD cutting machines.

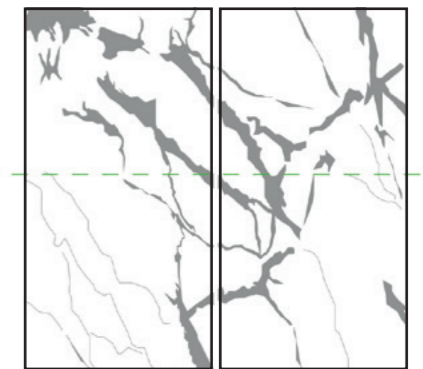

VEIN MATCHING (FIG.8.2)





PERFECTLY ALIGNED BOOKMATCHED SLABS (FIG.9.1)



BOOKMATCHED FEATURE WALL AND MATCHING COUNTER WITH PRECISION ALIGNMENT (FIG.9.2)





3D CLADDING WITH PRE-CUT DECORATIVE PIECES (FIG.10.1)



CUT-TO-SIZE FOR SPLIT LEVELS, ISLAND, AND ARCHITRAVE (FIG.10.2)





CUT-TO-SIZE VEIN MATCHING PANELS FOR RECTANGULAR COLUMN (FIG. 11.1)



CUT-TO-SIZE VEIN MATCHING STRIPS FOR CIRCULAR COLUMN (FIG. 11.2)





3D MEDIA WALL WITH SHELVING (FIG.12.1)





ORIGINAL FIREPLACE DESIGNS (FIG.13.1)



PROJECTS SUPPLIED PRE-CUT AND LABELLED (FIG.13.2)



INSTALLATION DRAWINGS MEAN PROJECTS MATCH YOUR DESIGNS (FIG.13.3)





RETAIL SPACE WITH CLADDED POINT OF SALE DISPLAYS AND COUNTERS (FIG.14.1)





DESIGN ENTIRE SCHEMES (FIG.15.1)





ARCHITECTURAL SURFACES ARE MATCHED WITH RETAIL DISPLAYS AND COUNTERS (FIG.16.1)





DESIGN FLOORING WITH SPATIAL ZONING TO CREATE SUB-SPACES IN LARGER AREAS (FIG.17.1)

## BESPOKE FLOORING DESIGNS

Create unique and visually stunning flooring designs on a larger scale by leveraging the full size and aesthetic appeal of large format slabs. Longer runs provide a seamless design with fewer grout lines. With our cut-to-size services, you can experiment with geometric patterns and curves to create your own bespoke cosmati flooring designs. Suitable for large scale projects spanning several hundred square metres, to a single inlaid floor for an entrance lobby, designs can be created for any style, from contemporary to classical. Geometric designs can be used to create intricate patterns and shapes, while curved designs can help with spatial zoning.

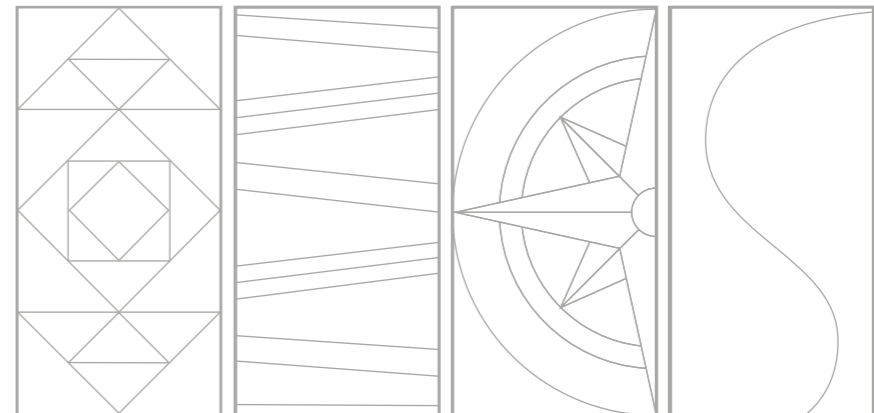

CLASSIC GEOMETRIC    MODERN GEOMETRIC    LARGE SCALE    CURVE DESIGNS





PRE-CUT SLABS PROVIDE MAXIMUM FLOOR COVERAGE FOR LARGE SCALE PROJECTS (FIG.18.1)



LABELLED PRECISION CUT PIECES MAKE INSTALLATION EASY (FIG.18.2)





BESPOKE FLOORS BLEND GEOMETRIC SHAPES, COLOURS, AND TEXTURES (FIG. 19.1)

## THE PROCESS

Be bold, experiment and elevate your room with a custom designed inlaid porcelain floor. Incorporate larger single pieces up to 3200 x 1600 mm and choose from over one hundred colours, textures and styles of porcelain slabs.

Our team will work with you to create your flooring design, bringing your vision to life and elevating the beauty of your space. Your design will be prepared offsite at our UK manufacturing facility. It will be carefully packaged and supplied with technical drawings. All flooring is supplied with clear piece numbering, to ensure successful and reliable installation.



UNIQUE GEOMETRIC FLOOR DESIGNS FOR MAXIMUM IMPACT (FIG.20.1)



## FURNITURE INLAYS AND TOPS

Reimagine your cherished furniture pieces with the timeless allure and durability of a porcelain inlay or top. Upgrade your existing table tops and furniture inlays with precision cut-to-size porcelain surfaces, made possible by our advanced CNC cutting technology. We can accommodate any shape, including ovals, irregular shapes, or rectangles, and provide square or curved corners to your exact specification or technical drawings.

Request circular diameters up to 1600 mm or rectangular pieces up to 3200 mm in length, while you can choose from over a hundred colours and textures, with an edge profile suitable for your needs.

The use of a porcelain inlay within existing furniture is both an elegant, cost effective and practical choice, offering beautiful variations of colour, style and texture. Porcelain also provides a durable and waterproof surface that is easy to maintain and suitable for hospitality and commercial remodelling projects.



REIMAGINE SIDE TABLES WITH PORCELAIN INLAYS (FIG.21.1)





CIRCLE OF ELEGANCE: REIMAGINE SIDE TABLES WITH CHIC CIRCULAR PORCELAIN INLAYS (FIG.22.1)



UPDATE CONSOLES WITH REPLACEMENT TOPS (FIG.22.2)





REMODEL EXISTING TABLES WITH PRECISION CUT PORCELAIN TOPS (FIG.23.1)





REVITALISE TIRED HOSPITALITY AREAS WITH COST-EFFECTIVE TABLE TOPS AND SURFACES (FIG.24.1)



## 3D CLADDING APPLICATIONS

Through the cut-to-size service, we are able to supply pre-prepared 3D cladding for a whole host of practical, artistic and time-saving applications. We meticulously label each piece and provide precision cut mitred edges for effortless installation. Employing pre-cut cladding streamlines the fabrication process, resulting in significant cost and time savings onsite.

3D cladding solutions can be used for residential projects both indoors and out, and for a host of retail and hospitality applications including plinths, planters, display stands, seating and customer service counters.

Architects can also exploit the beauty and practicality of porcelain slabs to explore every facet of stair design including steps, treads, nosing, risers and handrails.



TRANSFORM YOUR SURFACES WITH SEAMLESS 3D CLADDING (FIG.25.1)





CLADDED POINT OF SALE DISPLAYS AND ARCHITECTURAL FINERY (FIG.26.2)





UNIQUE TABLE DESIGN (FIG.27.1)







FIRST IMPRESSIONS MATTER FOR THIS STUNNING RECEPTION COUNTER (FIG.28.1)



DOUBLE BEVELLED 12 mm COUNTERTOP (FIG.28.2)

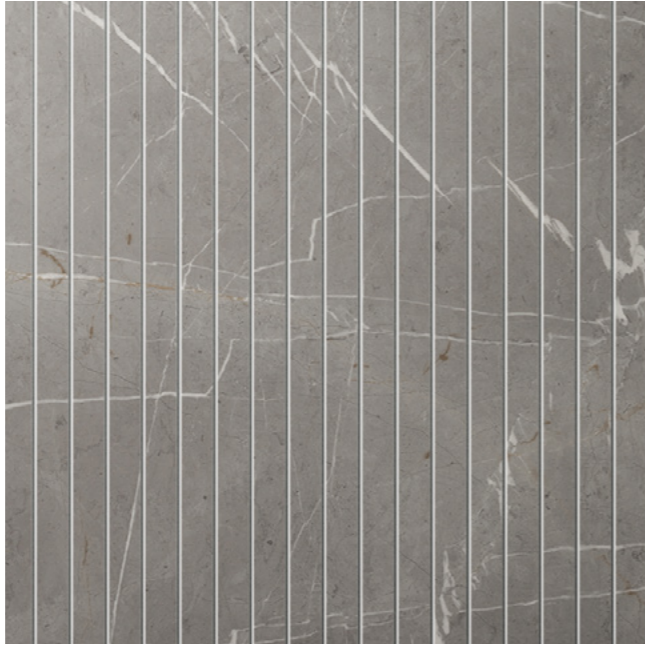

## FLUTED DECOR

Fluted Decor can be incorporated into cut-to-size requests and is priced per square metre. Delicate grooves are cut into the material, creating a subtle contrast and variation to the surface design.

Fluted grooves are 2 mm in thickness and can be specified at 5 mm, 10 mm or 20 mm intervals and a vertical or horizontal direction.



## STRIPS DECOR

Individually cut strips can be supplied in widths between 26 - 34 mm. Strips can be cut to clad flat or curved surfaces and applied to curved walls and pillars. Accurately angled mitred edges ensure a flush finish.

Each strip is carefully labelled to simplify the installation process and ensure the veining and pattern matching continues across surfaces to be cladded.





PORCELAIN SURFACES ARE DURABLE FOR ALL YEAR ROUND OUTDOOR USE WITH NO DISCOLOURATION OR FROST DAMAGE (FIG.30.1)





CUSTOM STAIRCASE WITH PORCELAIN TREADS (FIG.31.1)

## STAIRCASE, STEPS AND TREADS

Contemporary staircase design embraces clean lines and innovative materials. Through our cut-to-size services architects and designers can now exploit the beauty and practicality of porcelain slabs to explore every facet of stair design including steps, treads, nosing, risers and handrails. We provide solutions for commercial and residential projects, and offer surfaces that are suitable for both internal and external spaces.

Use cut-to-size for projects of any scale, from a single step within a split-level scheme, to a full stairwell design, while our expertise and support ensure that your project is completed on-time and on-budget. Both cladded treads and profile edge steps are possible and all can be supplied with matching skirting and wall tiles. For accurate specification we recommend our onsite laser templating service to ensure the precision and fit of every step.



EXTERNAL 12 mm STEPS WITH BULLNOSE PROFILE AND ANTI-SLIP GROOVES (FIG.32.1)





STAIRCASE WITH SLEEK PORCELAIN TREADS (FIG.33.1)







## TREAD AND NOSING PROFILES

Our steps and treads service provides a comprehensive solution for clients seeking bespoke steps, treads, and risers. We offer full laser templating to ensure accurate fitment and a smooth installation. All staircase projects are manufactured in the UK, which translates into a hassle-free process and reliable lead times.

On the following page you will find a selection of available nosing profiles, suitable for internal and external applications. All steps are available in 12 mm thicknesses and can be supplied with matching risers. External steps use 20 mm formats with a Grip finish. Options are also available for configuring anti-slip grooves and pre-installed channels ready for LED strip lighting (not supplied).





12 mm BULLNOSE NOSING WITH ANTI-SLIP GROOVES (FIG.35.1)



BULLNOSE



HALF BULLNOSE



DOUBLE BEVELLED EDGE



L SHAPE HALF BULLNOSE (includes riser)



DOUBLE HALF BULLNOSE



DOUBLE HALF BULLNOSE W/RISER



MITRED APRON W/SHADOW GAP

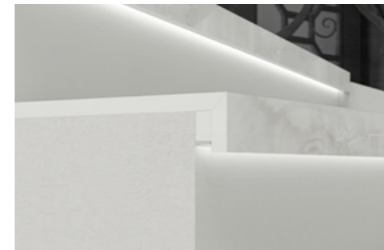

MITRED APRON W/LED CHANNEL

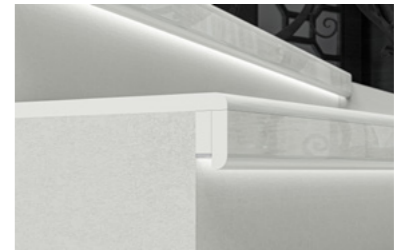

DOUBLE HALF BULLNOSE W/LED CHANNEL



L SHAPE MITRED APRON (includes riser)\*



MITRED APRON RETURN\*

All steps are available in 12 mm thicknesses.  
 \*L Shape Mitre and Mitred Apron Return steps are also available in 6 mm thickness.





12 MM BULLNOSE SWIMMING POOL COPING STONES WITH GRIP FINISH AND CUSTOM DECK LEVEL GRILLES (FIG.36.1)





CNC EDGE PROFILING (FIG.37.1)

## EDGE PROFILING AND MITRES

Latest generation contouring machines prepare all profiling requests to exact specifications. Intricate cut-outs including circular, square or irregular shapes can be specified as well as decorative elements such as skirting and step tiles. We offer dependable lead times and execute all requests from within the UK.

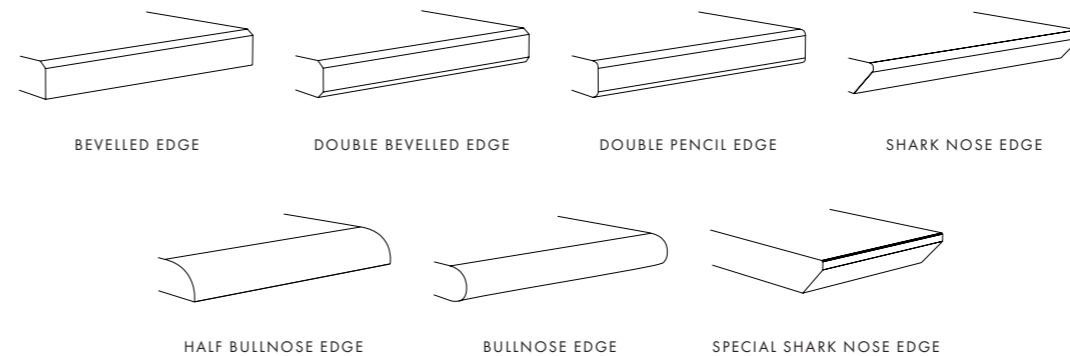

## CLADDING PROFILES

Through the cut-to-size service, we provide cladding for a whole host of practical, aesthetic and time saving tasks. Supplied with carefully labelled, precision cut mitres, pre-cut cladding saves considerable time onsite, improving efficiency, reducing waste and the chance of damage. A laser templating service is also available for complex cladding projects.

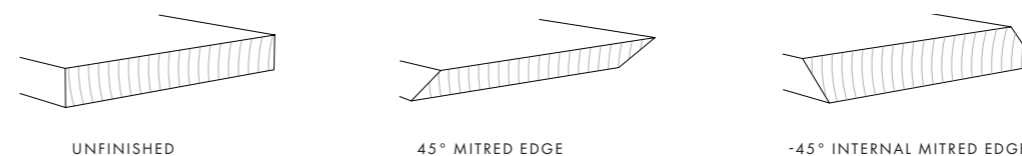







A modern bathroom vanity with a marble countertop and a concrete wall background. The vanity is a long, low-profile unit with a thick, rectangular top made of light-colored marble with prominent orange and red veining. Below the countertop are two large, minimalist drawers with thin, dark horizontal lines. The vanity is mounted on a light gray, textured concrete wall. Above the vanity, a dark gray rectangular mirror is mounted. Below the mirror, three gold-colored faucets are arranged horizontally. To the left of the vanity, a gold-colored towel rack holds two dark towels. On the countertop, there are several items: two bottles of soap, a small gold-colored vase, and a lit candle. To the right of the vanity, a gold-colored decorative object is mounted on the wall. In the foreground, a small, round, black table on a concrete pedestal holds a gold-colored figurine, three rolled-up dark towels, and two lit candles. The overall aesthetic is minimalist and modern, with a focus on natural materials and clean lines.

THE PERFECT FINISH:  
COMPLETING YOUR BATHROOM  
WITH A STYLISH VANITY





EXPLORE THE WIDEST CHOICE OF MARBLE AND STONE DESIGNS (FIG.40.1)





CLOAKROOM VANITY TOP FOR VESSEL BASIN (FIG.41.1)



WALL-MOUNTED VANITY TOP (FIG.41.2)





LIBRA SINGLE BASIN TO FIT AVAILABLE SPACE (FIG.42.1)



12 mm VANITY TOP WITH CUT-OUT FOR UNDERMOUNT SINK (FIG.42.2)





VENUS FREE-STANDING BASIN (FIG.43.1)





GEMINI 750 X 500 X 120 mm WITH FIXED BASE (FIG.44.1)

## GEMINI SURFACE-MOUNTED WASHBASIN

Gemini is a surface-mounted washbasin for installation over a vanity shelf or storage unit. Available in multiple sizes to meet your installation requirements, this basin can cater for both wall or surface-mounted tap systems. Configure Gemini with a fixed straight or sloping base.

SURFACE SHOWN: BIANCO STATUARIO - POLISHED



GEMINI WITH FIXED SLOPING BASE (FIG.44.2)

### SPECIFICATION

<b>Model</b>	Gemini
<b>Dimensions (mm)</b> (tolerance ±2 mm)	Length (L): 450-1600 Height (H): 120-200 Depth (D): 400-650
<b>Approximate weight</b>	30 kg
<b>Tap mounting position</b>	[ Wall-mounted ] [ Surface-mounted ]





GEMINI WITH FIXED STRAIGHT BASE AND SURFACE-MOUNTED TAP (FIG.45.1)



GEMINI WITH FIXED SLOPING BASE AND WALL-MOUNTED TAP (FIG.45.2)





LIBRA 800 X 500 X 200 mm WITH WALL-MOUNTED TAP (FIG.46.1)

SURFACE SHOWN: BIANCO STATUARIO - POLISHED



LIBRA WITH FIXED SLOPING BASE (FIG.46.2)

## LIBRA WALL-MOUNTED WASHBASIN

Libra is a diminutive wall-mounted washbasin with options for integrated storage. Ideal for washrooms where space is at a premium, Libra can be optioned with a single or double drawer, and fitted with premium push-to-open or soft-close runners. Specify your tap requirement and choose between a straight, sloping or removable sink base.

### SPECIFICATION

<b>Model</b>	Libra
<b>Dimensions (mm)</b> (tolerance ±2 mm)	Length (L): 450-2600 Height (H): 120-200 or 300-700 w/storage Depth (D): 400-650
<b>Approximate weight</b>	30-50 kg
<b>Tap mounting position</b>	[ Wall-mounted ][ Surface-mounted ]





LIBRA 780 X 500 X 300 mm WITH SINGLE DRAWER AND REMOVABLE BASE (FIG.47.1)



LIBRA WITH SINGLE DRAWER AND REMOVABLE BASE (FIG.47.2)



SURFACE SHOWN: BIANCO STATUARIO - POLISHED



LIBRA 780 X 500 X 490 mm WITH DOUBLE STACKED DRAWER (FIG.48.1)

## LIBRA STORAGE

Libra can also be optioned with a single or double stacked drawer to keep your essentials in order. By adding drawers you can turn Libra into a sleek and functional storage unit fitted with premium push-to-open or soft-close mechanisms.

### CONFIGURATION

**Storage Options** [ None ] [ Single Drawer ] [ Double Stacked Drawer ]

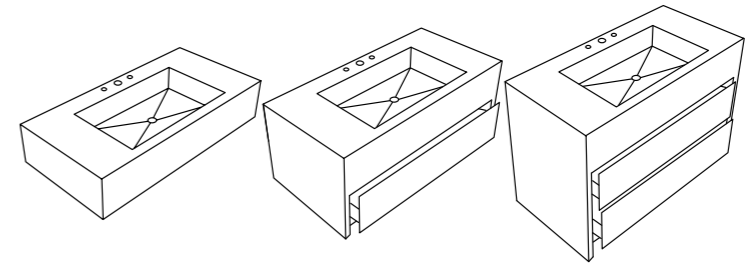

[ None ] [ Double drawer ] [ Double shelf ]

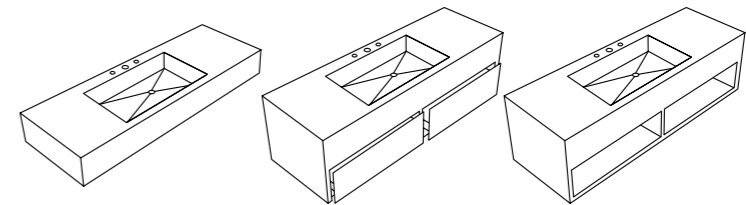

**Base type** [ Fixed straight base ] [ Fixed sloping base ] [ Removable base ]

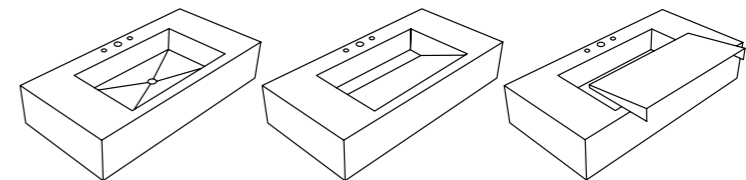

**Waste** [ Chrome ] [ Black ] [ Brass ] Hidden waste Hidden waste





SCORPIO WALL-MOUNTED WASHBASIN (FIG.49.1)

## EXPERIMENTING WITH TONE-ON-TONE

Experimenting with a tone-on-tone palette in the bathroom creates a sense of subtle sophistication. By pairing a stone effect surface for the wall-mounted basin with an ivory coloured bookmatched wall covering, the design remains cohesive while offering depth and texture. The soft contrast between the materials enhances the natural beauty of both elements, creating a characterful space.



MINIMA PEARL  
NATURAL



IVORY GIOIELLO BOOKMATCHED  
POLISHED





LEO 2200 X 500 X 150 mm WITH FIXED SLOPING BASE (FIG.50.1)



LEO 2200 X 500 X 370 mm WITH DOUBLE SHELF (FIG.50.2)

SURFACE SHOWN: BIANCO STATUARIO - POLISHED

## LEO WALL-MOUNTED WASHBASIN

Leo is a stylish wall-mounted washbasin with a slimline 400 mm depth. Ideal for washrooms where space is limited but imagination is not, Leo underlines its flexibility with a host of storage options including integrated shelving and drawers. Use with a wall or surface-mounted tap system and configure the sink base to slope from the front or the side or choose a straight base with click-clack waste. See overleaf for Leo storage options.

### SPECIFICATION

<b>Model</b>	Leo
<b>Dimensions (mm)</b> (tolerance ±2 mm)	Length (L): 1000-2600 Height (H): 120-300 or 350-500 w/storage Depth (D): 400-650
<b>Approximate weight</b>	40-50 kg

### CONFIGURATION

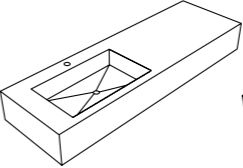
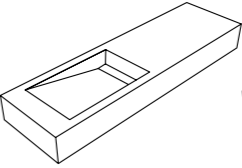
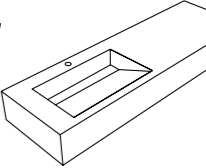
<b>Base type</b>	[ Fixed straight ]	[ Fixed side sloping ]	[ Fixed front sloping ]
			
<b>Waste</b>	[ Chrome ] [ Black ] [ Brass ]	Hidden waste	Hidden waste
<b>Tap mounting position</b>	[ Wall-mounted ] [ Surface-mounted ]		





LEO 2200 X 500 X 370 mm WITH TRIPLE DRAWER AND SIDE RECESS (FIG.51.1)

SURFACE SHOWN: BIANCO STATUARIO - POLISHED



LEO 2200 X 500 X 370 mm WITH TRIPLE DRAWER AND SIDE RECESS (FIG.51.2)

## LEO STORAGE

Despite its slim profile, Leo can transform your bathroom into a clutter-free oasis by adding the optional drawers and shelves. With ample space for all your essentials Leo becomes a spacious and versatile vanity and storage unit. Single, double or triple arrangements can be catered for in any combination of drawer and shelf. Premium push-to-open runners continue the luxury feel. Leo can be specified with a single cavity for hand towels, storage buckets, laundry baskets or waste bins.

### CONFIGURATION

**Storage Options** [ Double Drawer ] [ Drawer & Shelf ] [ Double shelf ]

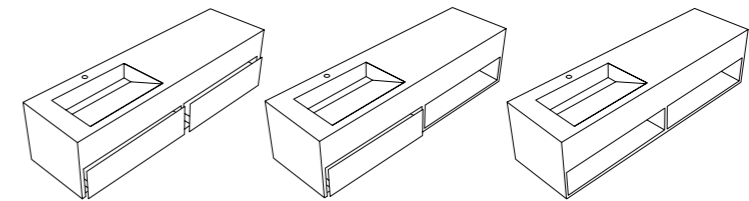

[ Triple Drawer ] [ Triple shelf ]

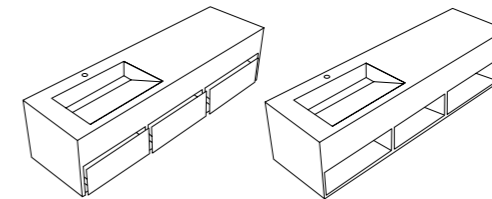

### Cavity or Recess

Leo can be specified with a recess suitable for storing hand towels and toiletries or a cavity / opening for storage buckets, laundry baskets or waste bins.

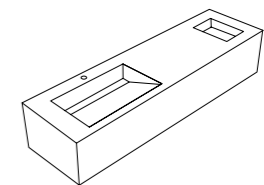





LEO 1400 X 500 X 355 mm WITH FIXED STRAIGHT BASE, DRAWER AND SHELF (FIG.52.1)



LEO 1400 X 500 X 355 mm WITH FIXED SLOPING BASE AND DOUBLE DRAWER (FIG.52.3)



LEO 1400 X 500 X 355 mm WITH FIXED STRAIGHT BASE, DRAWER AND SHELF (FIG.52.2)

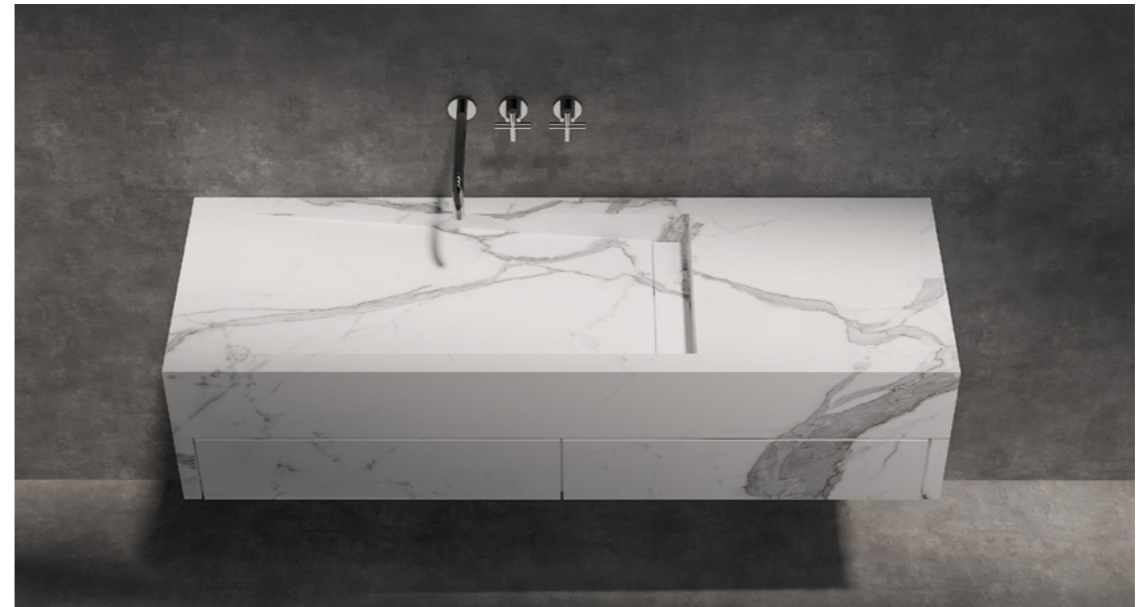

LEO 1400 X 500 X 355 mm WITH FIXED SLOPING BASE AND DOUBLE DRAWER (FIG.52.4)



## EXPERIMENTING WITHOUT COLOUR

Designing with a monotone colour palette can create a sleek and sophisticated atmosphere. Introduce visual interest through gold and white veining within the marble, without disrupting the monochromatic theme. Large vanity mirrors enhance the sense of space, maintaining the room's airy feel. To further elevate the design, consider incorporating subtle textures and matte finishes, adding depth without overpowering the minimalist aesthetic.



VANITY TOP 2000 X 500 X 130 mm (FIG.53.1)

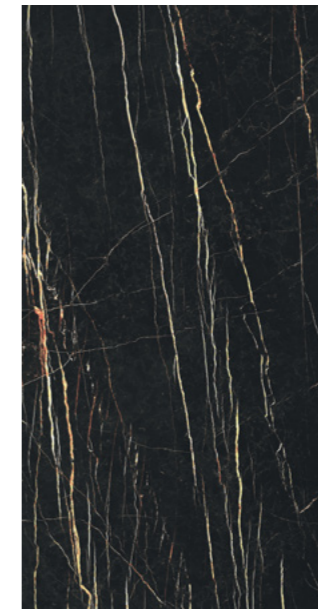

NOIR DORATO  
POLISHED





CAPRICORN 2200 X 550 X 150 mm WITH FIXED STRAIGHT BASE (FIG.54.1)

SURFACE SHOWN: BIANCO STATUARIO - POLISHED



CAPRICORN WITH SURFACE-MOUNTED TAP (FIG.54.2)

## CAPRICORN WALL-MOUNTED DOUBLE WASHBASIN

Capricorn is an opulent wall-mounted double washbasin available in lengths up to 2600 mm. With twin basins and various sink base options, Capricorn can accommodate any tap system. Multiple storage options can be specified including shelves and drawers.

### SPECIFICATION

<b>Model</b>	Capricorn
<b>Dimensions (mm)</b> (tolerance ±2 mm)	Length (L): 1400-2600 Height (H): 120-250 or 350-450 w/storage Depth (D): 450-650
<b>Approximate weight</b>	45-65 kg

### CONFIGURATION

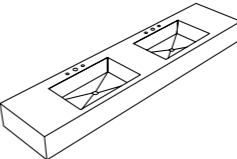
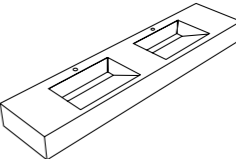
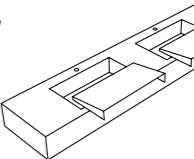
<b>Base type</b>	[ Fixed straight base ]	[ Fixed sloping base ]	[ Removable base ]
			
<b>Waste</b>	[ Chrome ][ Black ][ Brass ]	Hidden waste	Hidden waste
<b>Tap mounting position</b>	[ Wall-mounted ][ Surface-mounted ]		





CAPRICORN 2200 X 550 X 400 mm WITH TRIPLE DRAWER AND TWIN RECESS (FIG.55.1)



CAPRICORN 2200 X 550 X 400 mm WITH REMOVABLE BASE AND RECESS (FIG.55.2)

## CAPRICORN STORAGE

Capricorn provides flexible storage options in the form of drawers and shelves. Single, double or triple configurations can be catered for in any combination of drawer and shelf. Premium push-to-open runners continue the luxury feel, while waste pipes are hidden from view within the unit. Capricorn models can be specified with a single or double cavity for storage buckets, laundry baskets or waste bins.

### STORAGE CONFIGURATION

**Storage Options** [ None ] [ Single Shelf ] [ Double Shelf ]

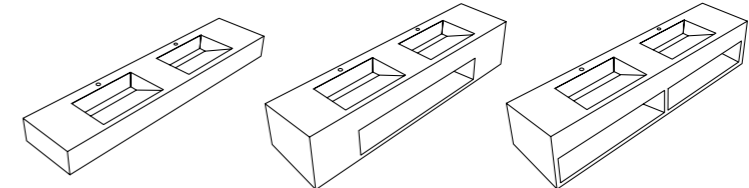

[ Double Drawer ] [ Drawer & Shelf ] [ Triple Drawer ]

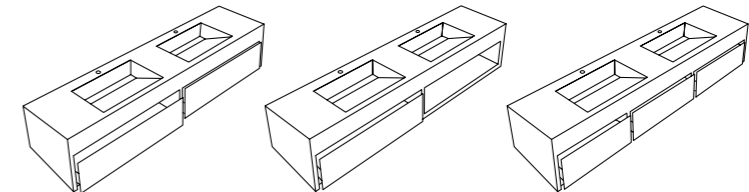

**Cavity or Recess** Capricorn models can be specified with a recess suitable for storing hand towels and toiletries or a cavity / opening for storage buckets, laundry baskets or waste bins.

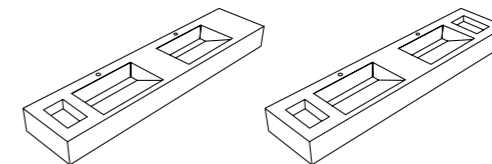



CAPRICORN 1400 X 550 X 400 mm WITH FIXED STRAIGHT BASE, DRAWER AND SHELF (FIG.56.1)



CAPRICORN 2200 X 550 X 400 mm WITH FIXED SLOPING BASE AND SINGLE SHELF (FIG.56.3)

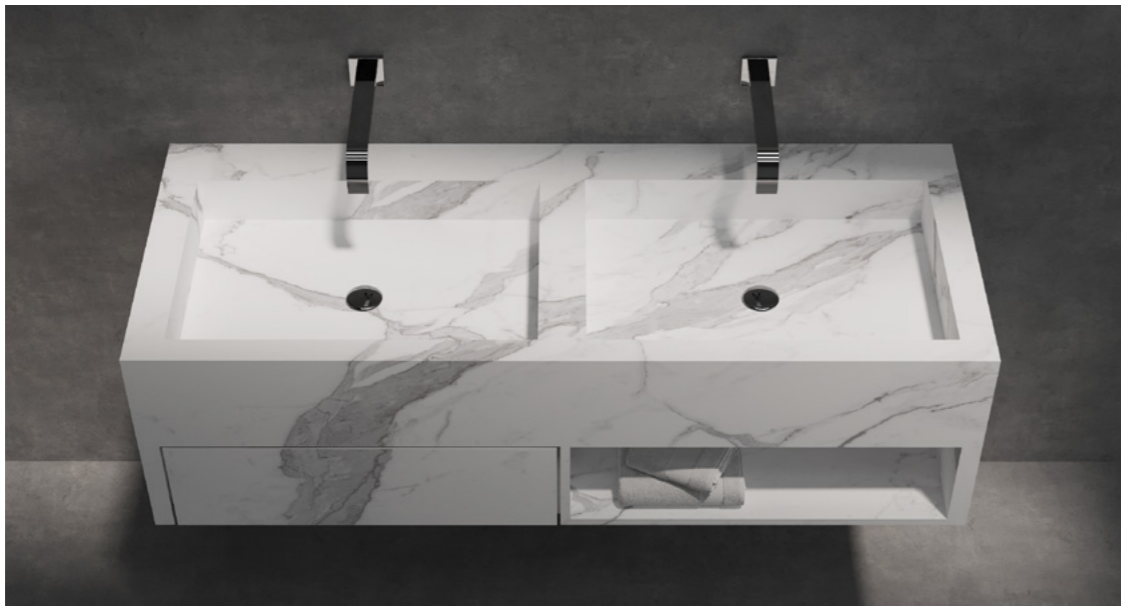

CAPRICORN 1400 X 550 X 400 mm WITH FIXED STRAIGHT BASE, DRAWER AND SHELF (FIG.56.2)



CAPRICORN 2200 X 550 X 400 mm WITH FIXED SLOPING BASE AND SINGLE SHELF (FIG.56.4)



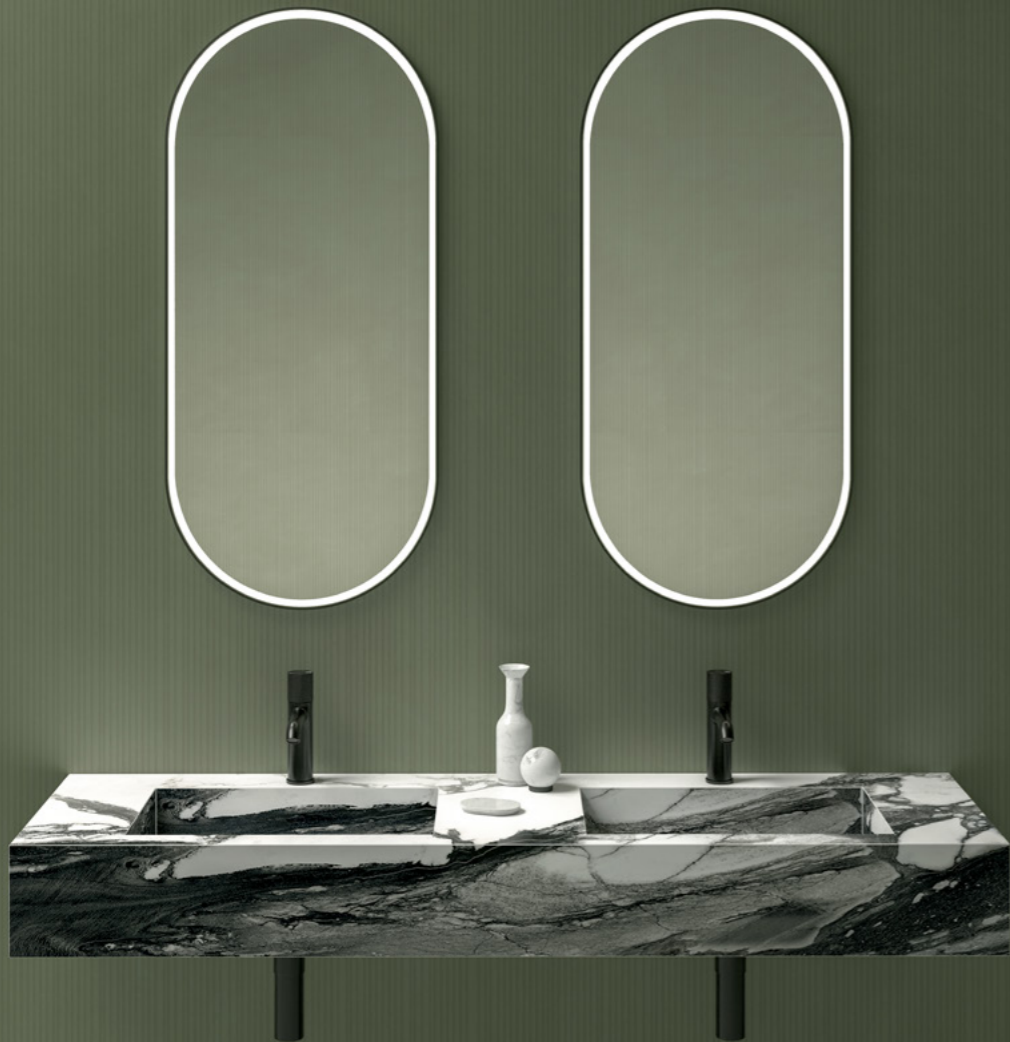

CAPRICORN 1600 X 500 X 180 mm (FIG.57.1)

## EXPERIMENTING WITH GREEN

Incorporating an olive green wall covering into your black and white bathroom design brings an earthy richness to the space. The high-contrast Renoir calacatta marble, with its bold black and white veining, creates a striking focal point against the olive backdrop. To enhance the balance between these elements, matte black fixtures and modern lighting help maintain the contrast while ensuring the space feels cohesive, bright, and inviting.



RENOIR CALACATTA  
POLISHED



SCORPIO 2200 X 600 X 300 mm WITH FIXED STRAIGHT BASE (FIG.58.1)

## SCORPIO WALL-MOUNTED DOUBLE TROUGH BASIN

Scorpio is a deluxe wall-mounted double trough basin which can be specified with a fixed straight or sloping base. Suitable for two people, Scorpio can be specified with any tap system arrangement.

SURFACE SHOWN: BIANCO STATUARIO - POLISHED



SCORPIO WITH SURFACE-MOUNTED TAPS (FIG.58.2)

### SPECIFICATION

<b>Model</b>	Scorpio
<b>Dimensions (mm)</b> (tolerance $\pm 2$ mm)	Length (L): 1200-2600 Height (H): 200-400 Depth (D): 450-650
<b>Approximate weight</b>	50 kg





SCORPIO 2200 X 600 X 300 mm WITH FIXED SLOPING BASE AND SINGLE SIDE RECESS

SURFACE SHOWN: BIANCO STATUARIO - POLISHED

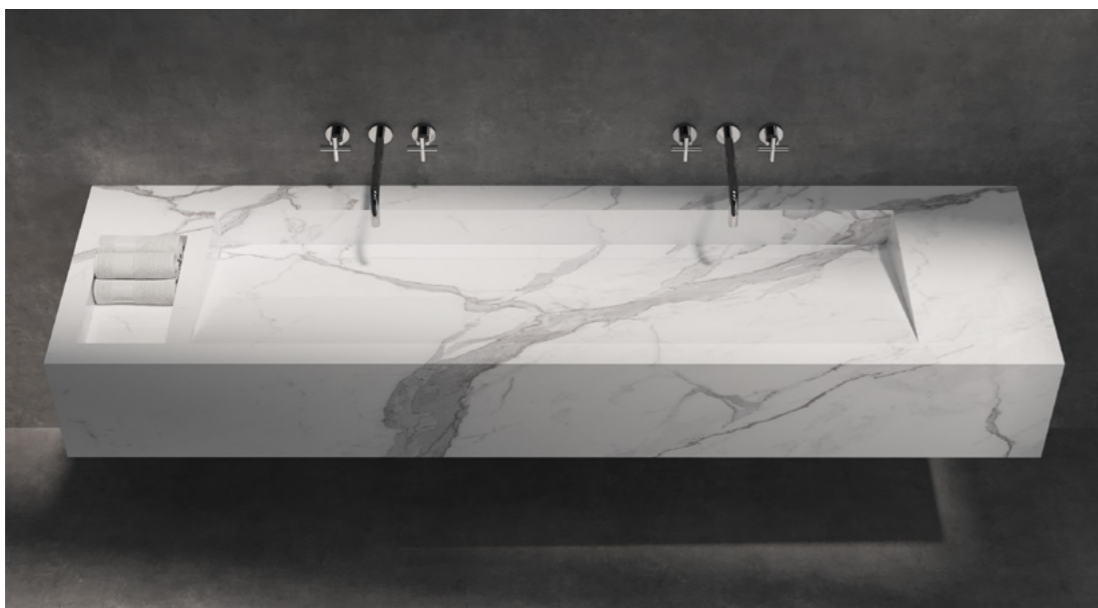

SCORPIO WITH FIXED SLOPING BASE AND SINGLE SIDE RECESS (FIG.59.2)

## SCORPIO CONFIGURATION

Recesses for storing hand towels and toiletries are available, while cavities suitable for storage buckets, laundry baskets or waste bins can be optioned at both ends of the unit.

### CONFIGURATION

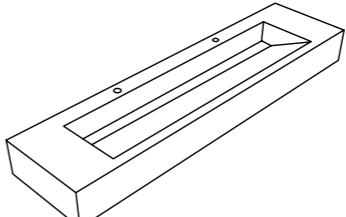
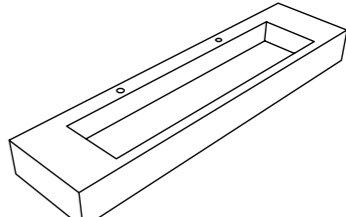
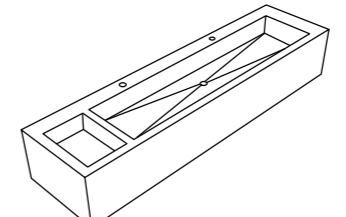
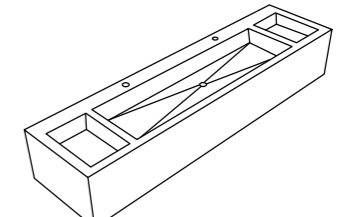
<b>Base type</b>	[ Fixed sloping base ]	[ Fixed straight base ]
		
<b>Waste</b>	Hidden Waste	[ Chrome ][ Black ][ Brass ]
<b>Cavity or Recess</b>	Scorpio models can be specified with a recess suitable for storing hand towels and toiletries or a cavity /opening for storage buckets, laundry baskets or waste bins.	
		
<b>Tap mounting position</b>	[ Wall-mounted ][ Surface-mounted ]	

SURFACE SHOWN: BIANCO STATUARIO - POLISHED



VIRGO WITH SINGLE FLUTED DRAWER 2400 X 600 X 230 mm (FIG.60.1)

## VIRGO VANITY TOP WITH STORAGE

The Virgo vanity top with integrated storage provides ample space to keep your bathroom essentials organised and within reach. With its sleek and functional design, it is perfect for small bathrooms that need extra storage, or for larger bathrooms that require additional organisation. The push-to-open drawers provide a smooth and effortless opening, while the wall-mounted design keeps your space looking clean and clutter-free.

### SPECIFICATION

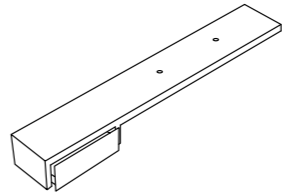
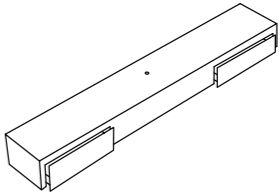
	Model	Single drawer	Double drawer
			
<b>Dimensions (mm)</b> (tolerance ±2 mm)		Length (L): 1401-2600 Depth (D): 400-650	
<b>Approximate weight</b>		40-50 kg	
<b>Top height (mm)</b>		50-300 mm	
<b>Drawer height (mm)</b>		160-300 mm	
<b>Decoration</b>		[ Fluted ] [ None ]	





VIRGO VANITY TOP WITH SINGLE DRAWER 2400 X 600 X 230 mm (FIG. 61.1)

## EXPERIMENTING WITH COLOUR

Go bold with an anapologetically daring feature wall, and maintain balance by pairing with structured aggregate surfaces. Both dominants and monochromatic in colour. The sleekness of Virgo and imposing scale of 3D Mirror adds a visually convincing dimension. This approach ensures the space has interaction and poise. Embrace visual contrast in our bathroom product collection.

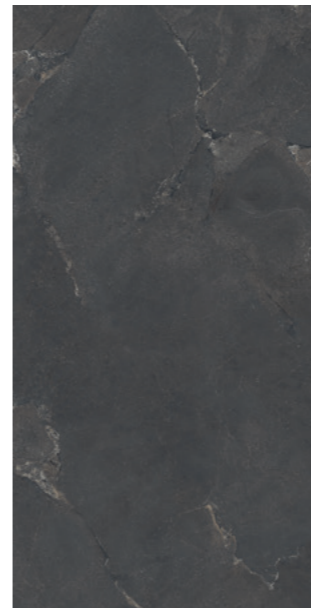

EBONY  
NATURAL



LAGUNA BLANCA BOOKMATCHED  
POLISHED



SURFACE SHOWN: BIANCO STATUARIO - POLISHED & BLACK CALACATTA - POLISHED



VIRGO WITH DOUBLE DRAWER 2400 X 600 X 230 mm. SHOWN HERE WITH GEMINI SURFACE-MOUNTED BASIN (FIG.62.1)





VANITY TOP 1000 X 500 X 100 mm WITH FLUTED DECORATION (FIG.63.1)

## VANITY TOP

Our wall-mounted vanity tops offer the widest range of colours for interior designers to choose from, allowing them to create a sophisticated look that complements any bathroom decor. From elegant marble finishes to authentic stone textures, these tops can be customised to meet your precise size and installation needs, with lengths up to 2600 mm and heights from 50 to 120 mm. The pre-drilled cut-outs for taps and waste make them compatible with all vessel and countertop basins and tap systems.

SURFACE SHOWN: BIANCO STATUARIO - POLISHED



VANITY TOP 2600 X 500 X 100 mm WITH TWIN VESSEL BASINS (FIG.63.2)

### SPECIFICATION

<b>Model</b>	Vanity Top
<b>Dimensions (mm)</b> (tolerance ±2 mm)	Length (L): 600-2600 Height (H): 50-120 Depth (D): 400-650
<b>Approximate weight</b>	15 kg per linear metre

### CONFIGURATION

<b>Decoration</b>	[ Fluted ] [ None ]
<b>Tap mounting position</b>	[ Wall-mounted ] [ Surface-mounted ]

## SURFACE-MOUNTED VANITY TOP WITH CUT-OUT

Vanity top with cut-out is a surface-mounted top to be installed above an existing vanity or storage unit (not supplied). Surface-mounted tops can be specified with heights of 12 mm, 20 mm, or a custom height between 40-100 mm. Tops are supplied with laser cut openings for inset or under-mount basins (not supplied). Ellipse or rectangular cut-outs can be accommodated in single or multiple arrangements. Please provide the basin manufacturer's fitting specification.

See over for wall-mounting options.

SURFACE SHOWN: BIANCO STATUARIO - POLISHED



SURFACE-MOUNTED WITH CIRCULAR CUT-OUT 1000 X 600 X 50 mm (FIG.64.1)

### SPECIFICATION

<b>Model</b>	Surface-mounted vanity top with cut-out		
<b>Height (H)</b>	40-100 mm	12 mm	20 mm
<b>Length (L)</b>	600-2600 mm	∞ (joint every 3200 mm)	∞ (joint every 3200 mm)
<b>Depth (D)</b>	500-700 mm	500-700 mm	500-700 mm
<b>Approximate weight</b>	26 kg per m <sup>2</sup>	40 kg per m <sup>2</sup>	56 kg per m <sup>2</sup>
<b>Edge profiles</b>	Vanity tops are supplied as standard with their front and inner edges profiled. Sides and rear edges can also be specified.		
<b>Profile</b>	Mitred	[ Double Pencil ][ Bevelled ][ Double Bevelled ] [ Bullnose ][ Half Bullnose ][ Shark Nose ]	
<b>Surface-mounted installation</b>			
<b>Basin cut-outs</b>	[ 1 ][ 2 ][ 3 ] Please consult basin specification.		
<b>Integrated basin</b>	[ 1 ][ 2 ][ 3 ]		
<b>Shape of cut-outs</b>	[ Circular ][ Ellipse ][ Rectangular ] Please consult basin specification.		
<b>Basin fitting type</b>	[ Top-mounted ][ Under-mounted ][ Integrated ]		





SURFACE-MOUNTED WITH RECTANGULAR CUT-OUT 1000 X 600 X 12 mm (FIG.65.1)



SURFACE-MOUNTED WITH TWO ELLIPSE CUT-OUTS 2040 X 600 X 12 mm (FIG.65.2)



SURFACE-MOUNTED VANITY TOP WITH THREE ELLIPSE CUT-OUTS 3000 X 600 X 12 mm WALL CABINET NOT SUPPLIED (FIG.66.1)



## WALL-MOUNTED VANITY TOP WITH CUT-OUT

With multiple mounting options vanity top with cut-outs can also be wall-mounted with a height from 100 to 400 mm. Tops are supplied with laser cut openings for inset or under-mount basins (not supplied). Ellipse or rectangular cut-outs can be accommodated in single or multi-basin arrangements.

SURFACE SHOWN: BIANCO STATUARIO - POLISHED



WALL-MOUNTED WITH TWO RECTANGULAR CUT-OUTS 2200 X 550 X 350 mm (FIG.67.1)

### SPECIFICATION

<b>Model</b>	Wall-mounted vanity top with cut-out
<b>Height (H)</b>	100-400 mm
<b>Length (L)</b>	600-2600 mm
<b>Depth (D)</b>	500-700 mm
<b>Approximate weight</b>	26 kg per m <sup>2</sup>
<b>Edge profiles</b>	Vanity tops are supplied as standard with their front and inner edges profiled. Sides and rear edges can also be specified.
<b>Profile</b>	Mitred

#### Wall-mounted installation

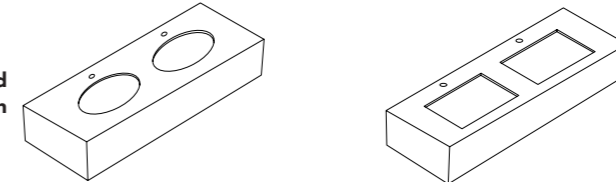

<b>Basin cut-outs</b>	[ 1 ] [ 2 ] [ 3 ] Please consult basin specification.
<b>Integrated basin</b>	[ 1 ] [ 2 ] [ 3 ]
<b>Shape of cut-outs</b>	[ Circular ] [ Ellipse ] [ Rectangular ] Please consult basin specification.
<b>Basin fitting type</b>	[ Top-mounted ] [ Under-mounted ] [ Integrated ]



WALL-MOUNTED WITH THREE ELLIPSE CUT-OUTS 2600 X 500 X 200 mm (FIG.68.1)



SURFACE SHOWN: BIANCO STATUARIO - POLISHED



VANITY SHELF 2200 X 550 X 60 mm (FIG.69.1)

## VANITY SHELF

Fully configurable, this vanity shelf can be specified in a range of colours and matched with wall and floor tiling to create the appearance of one continuous surface. Available in Marble, Stone and Concrete styles, each shelf is wall-mounted and sized to your specific dimensions. Lengths up to 2600 mm and heights of 200 mm are possible. Vanity shelf can be paired with a wall-mounted basin and our Globo storage unit.

### SPECIFICATION

<b>Model</b>	Vanity Shelf
<b>Dimensions (mm)</b> (tolerance $\pm 2$ mm)	Length (L): 600-2600 Height (H): 50-200 Depth (D): 400-650
<b>Approximate weight</b>	25 kg per linear metre



GLOBO 1400 X 500 X 180 mm WITH DOUBLE DRAWER (FIG.70.1)

## GLOBO

Whether you use it on its own or pair with one of our wall-mounted basins, Globo provides additional storage options for high-end bathroom projects. Globo offers plenty of storage space and can be configured with drawers or shelving. Globo comes ready for wall-mounting, with premium push-to-open drawers and can be specified in length from 650 to 2600 mm making it suitable for bathrooms of all sizes.

### SPECIFICATION

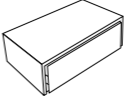
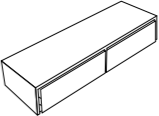
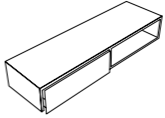
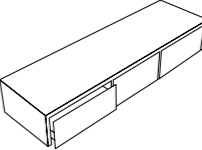
<b>Height (mm)</b>	180-300	
<b>Depth (mm)</b>	400-650	
<b>Model</b>	Single Drawer	Double Drawer
<b>Length (mm)</b>	650-780	781-1560
		
<b>Model</b>	Drawer & Shelf	Triple Drawer
<b>Length (mm)</b>	781-1560	1401-2600
		
<b>Decoration</b>	[ Fluted ] [ None ]	

SURFACE SHOWN: BIANCO STATUARIO - POLISHED



GLOBO 1400 X 500 X 180 mm WITH FLUTED DRAWER AND SHELF (FIG.70.2)





GLOBO 2180 X 500 X 300 mm WITH TRIPLE DRAWER (FIG.71.1)

# VENUS

Ideal for smaller sized washrooms and cloakrooms, Venus is a free-standing single washbasin and is available with configurable storage including shelving, drawers or cupboard space.

## SPECIFICATION

**Model** [ No storage ] [ Double stacked shelf ]

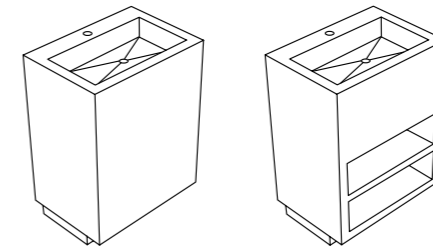

[ Single drawer ] [ Double stacked drawer ] [ Cupboard ]

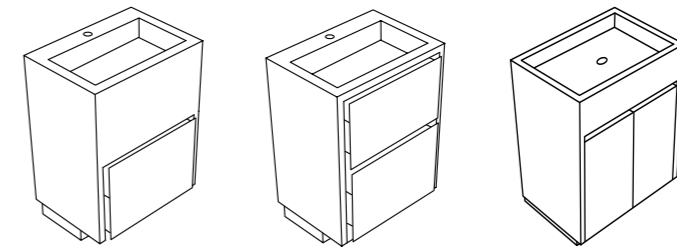

**Dimensions (mm)** Length (L): 500-780  
Height (H): 850-950  
Depth (D): 450-650  
(tolerance  $\pm 2$  mm)

**Internal Finish** [ Beige Linen ] [ Grey Tweed ] [ Denver Oak ] [ French Elm ] [ Grey Venice ]  
[ Light Westminster Oak ] [ Missouri Walnut ] [ Quartz ] [ Smoked Oak ]

**Door/Drawer Edge Finish** [ Internal Veneer ] [ Metal Banding ] [ Tile Cladding ]

**Base type** [ Fixed straight base ] [ Fixed sloping base ] [ Removable base ]

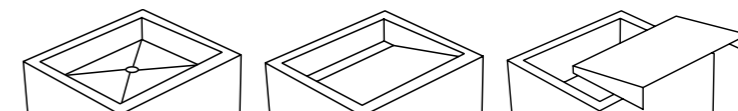

SURFACE SHOWN: BIANCO STATUARIO - POLISHED

VENUS 650 X 550 X 900 mm WITH DOUBLE STACKED SHELF (FIG.72.1)





LEFT: VENUS 650 X 550 X 900 mm DOUBLE STACKED DRAWER FIXED STRAIGHT BASE  
RIGHT: VENUS WITH SINGLE DRAWER AND FIXED STRAIGHT BASE (FIG.73.1)



VENUS 700 X 550 X 900 mm CUPBOARD WITH TWO INTERNAL SHELVES (FIG.73.2)



VENUS 650 X 500 X 900 MM (FIG.74.1)

## EXPERIMENTING WITH COLOUR

The elegant beauty of onyx stone is known for its luxurious feel and timeless appeal. Pair with the raw aesthetic of grey stone to create contrast, and an unexpected fusion. It's an enticing scene of urban chic, that elevates the dynamic identity of Venus to a whole new level. Embrace the power of opposing surfaces to unlock exciting design possibilities.

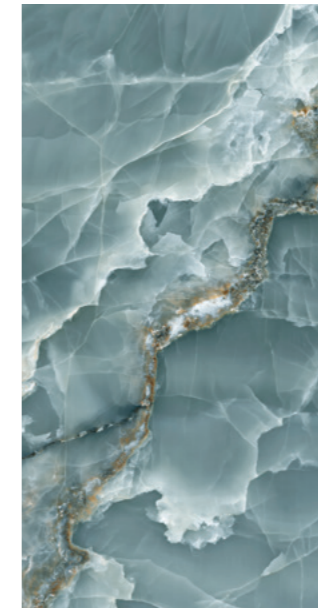

CYAN  
POLISHED



SURFACE: BIANCO STATUARIO - POLISHED & BLACK CALACATTA - POLISHED



SATURN 2200 X 550 X 850 mm FREE-STANDING DOUBLE BASIN (FIG.75.1)

## SATURN

Saturn is a luxury free-standing washbasin with a twin sink arrangement. Substantial in size and prestige, Saturn hides all pipe work and provides an access panel to the rear for servicing. For a true statement piece, pair with a bold tap system of your choice and design with contrasting colours.

### SPECIFICATION

<b>Dimensions (mm)</b> (tolerance $\pm 2$ mm)	Length (L): 1800-2200
	Height (H): 850-900
	Depth (D): 500-650

<b>Approximate weight</b>	120-150 kg
---------------------------	------------

### CONFIGURATION

<b>Waste</b>	[ Chrome ] [ Black ] [ Brass ]
--------------	--------------------------------

<b>Tap mounting position</b>	[ Wall-mounted ] [ Surface-mounted ]
------------------------------	--------------------------------------

<b>Position of access panels</b>	[ Rear ] [ Side ] (There is one access panel per sink unit)
----------------------------------	---

# MERCURY

Mercury is a free-standing double trough washbasin that can be configured with one, two or three wash stations. With various colours and styles to choose from and custom-sized to fit your space, Mercury offers unrivalled configuration options. Suitable for both residential and commercial installation, Mercury can be specified with a side or rear facing access panel, multiple tap systems and counter mounted soap dispensers.

SURFACE SHOWN: BIANCO STATUARIO - POLISHED



MERCURY 1895 X 650 X 850 mm WITH FIXED SLOPING BASE (FIG.76.1)

## SPECIFICATION

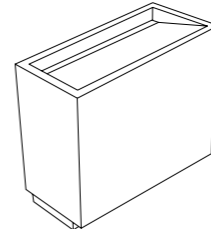
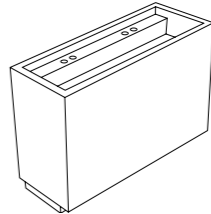
	Fixed sloping base	Fixed straight base
<b>Base type</b>	Fixed sloping base	Fixed straight base
		
<b>Dimensions (mm)</b> (tolerance $\pm 2$ mm)	Length (L): 1200-2600 Height (H): 850-900 Depth (D): 450-650	
<b>Approximate weight</b>	120-150 kg	
<b>Waste</b>	[ Chrome ][ Black ][ Brass ]	
<b>Tap mounting position</b>	[ Surface-mounted ][ Wall-mounted ] Surface-mounted taps require a fixed straight base as shown opposite. Wall-mounted taps require a fixed sloping base as shown on the next page.	





MERCURY 1895 X 650 X 850 mm (FIG.77.1)

## EXPERIMENTING WITH COLOUR

An imposing floor-standing trough basin with space for three wash stations can be a stunning centrepiece. This expansive basin not only offers ample room for multiple users, but also creates a striking visual impact that elevates the entire space. To maximise the effect, pair with a floor-mounted tap system for a multi-station setup. Add drama by designing with bold marble surfaces.

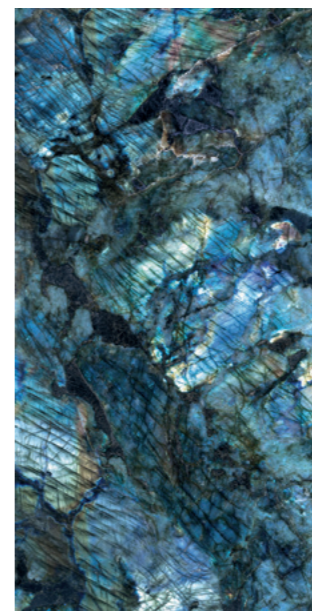

LABRADORITE  
POLISHED



MERCURY 1660 X 650 X 850 mm WITH SURFACE-MOUNTED TAPS AND DISPENSER



MERCURY 1660 X 650 X 850 mm WITH SURFACE-MOUNTED TAPS AND DISPENSER



# BASIN BASE & TAP SYSTEMS

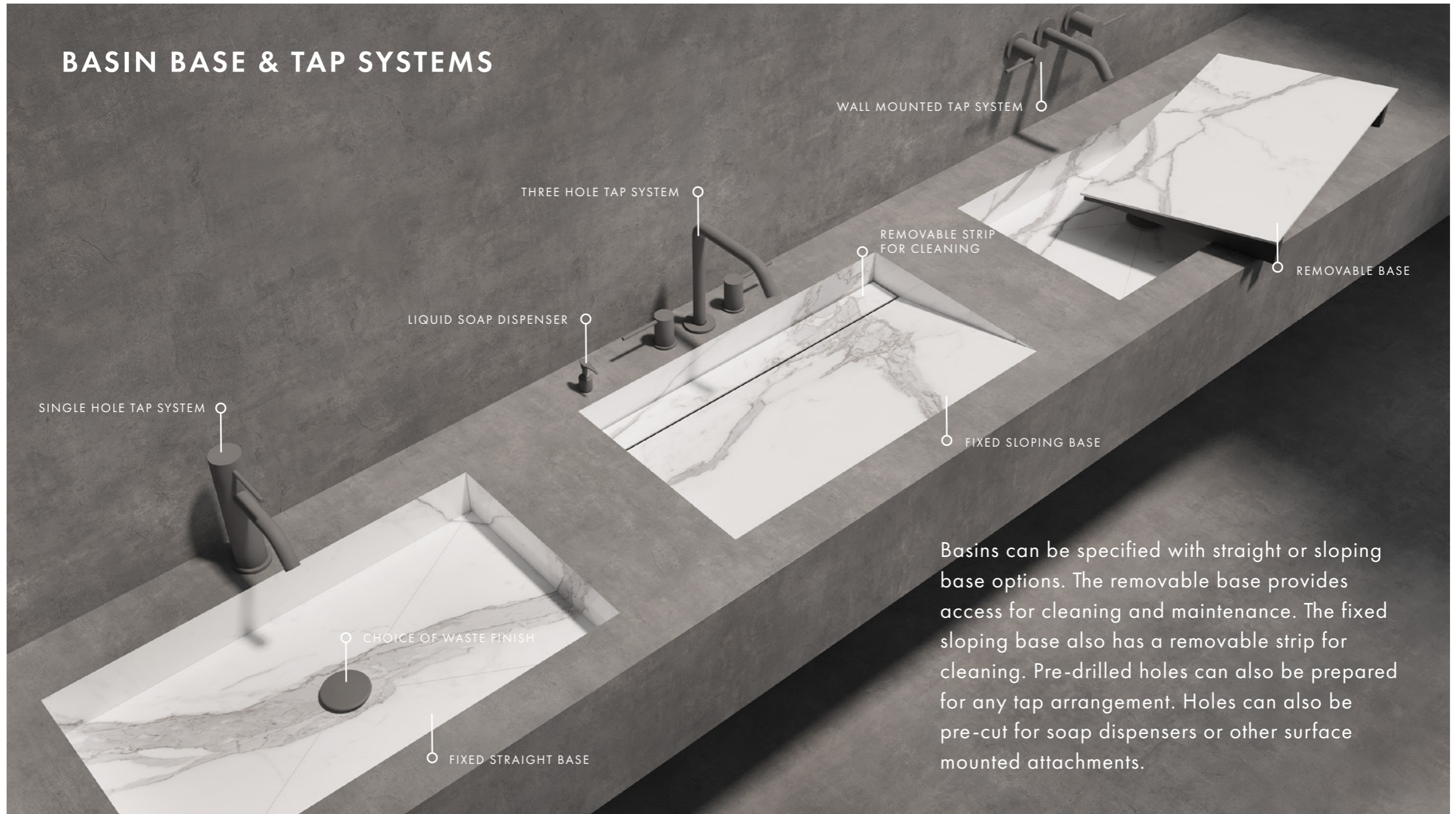

Basins can be specified with straight or sloping base options. The removable base provides access for cleaning and maintenance. The fixed sloping base also has a removable strip for cleaning. Pre-drilled holes can also be prepared for any tap arrangement. Holes can also be pre-cut for soap dispensers or other surface mounted attachments.



# POCKETS

RECESS

CAVITY

Basins can be specified with a recess suitable for storing hand towels and toiletries or a cavity /opening for storage buckets, laundry baskets or waste bins.



# STORAGE OPTIONS

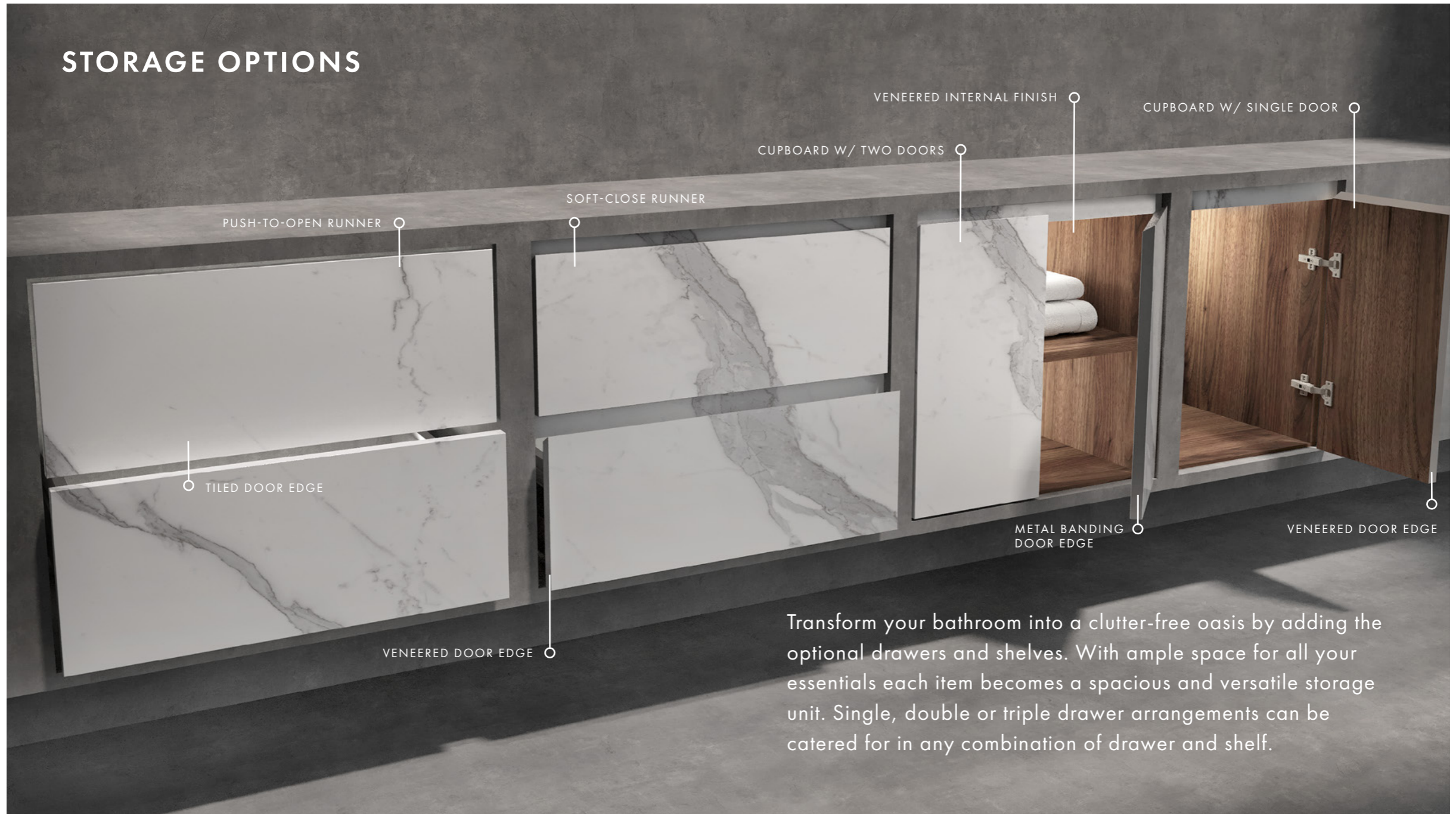

Transform your bathroom into a clutter-free oasis by adding the optional drawers and shelves. With ample space for all your essentials each item becomes a spacious and versatile storage unit. Single, double or triple drawer arrangements can be catered for in any combination of drawer and shelf.

# INTERNAL VENEER COLOUR OPTIONS

Premium push-to-open or soft-close runners continue the luxury feel, while a selection of internal veneers and door edge finish choices provide further personalisation.

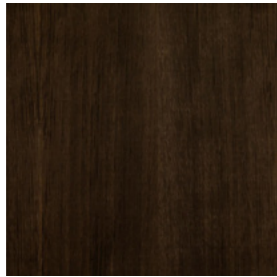

SMOKED OAK



MISSOURI WALNUT



FRENCH ELM



LIGHT WESTMINSTER OAK

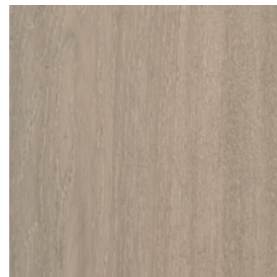

DENVER OAK

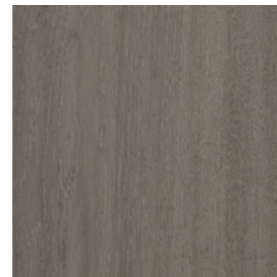

GREY VENICE

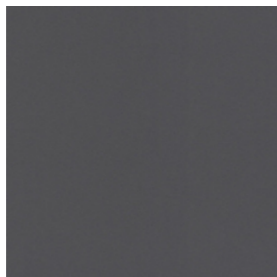

QUARTZ



BEIGE LINEN

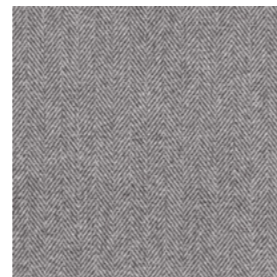

GREY TWEED



GREY VENICE VENEER (FIG.82.1)



SURFACE SHOWN: BIANCO STATUARIO - NATURAL



SHOWER TRAY 'RECT1200'. 1200 x 800 mm (FIG.83.1)

## SHOWER TRAY

Available in the full range of colours, this shower tray can be specified in the same surface material as the flooring. Three popular sizes are shown but custom specifications are possible to fit with project requirements. This item is supplied with hidden drainage system.

### SPECIFICATION

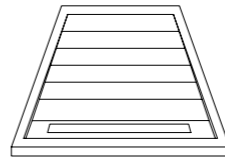
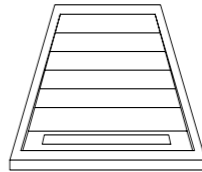
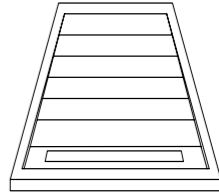
<b>Item</b>	Shower Tray		
<b>Description</b>	Low profile tray with drainage system		
<b>Model</b>	SQ900	RECT1200	RECT1500
			
<b>Dimensions (mm)</b> (tolerance ±2 mm)	Length (L): 900 Depth (D): 900 Height (H): 70	Length (L): 1200 Depth (D): 800 Height (H): 70	Length (L): 1500 Depth (D): 850 Height (H): 70
<b>Approximate weight</b>	20 kg	25 kg	30 kg

SURFACE SHOWN: BIANCO STATUARIO - POLISHED



DEEP FRAME BATHROOM MIRROR 2000 X 840 X 200 mm (FIG.84.1)

## 3D MIRROR

Every successful bathroom project needs a mirror, so complete your design with this deep framed bathroom mirror, providing additional shelf space for toiletries and accessories. Sized to match your vanity top and fit your space in lengths up to 2600 mm, this mirror can be mounted horizontally on a wall (using the supplied hanger), or leaned vertically against a wall. Specify to complement existing elements of your bathroom design.

### SPECIFICATION

<b>Dimensions (mm)</b> (tolerance $\pm 2$ mm)	Length (L): 600 - 2600 Height (H): 650 - 1000 Depth (D): 100 - 200
<b>Approximate weight</b>	50 kg
<b>Fixing type</b>	Wall Hanging. This unit is supplied with a Z Bar mirror hanger



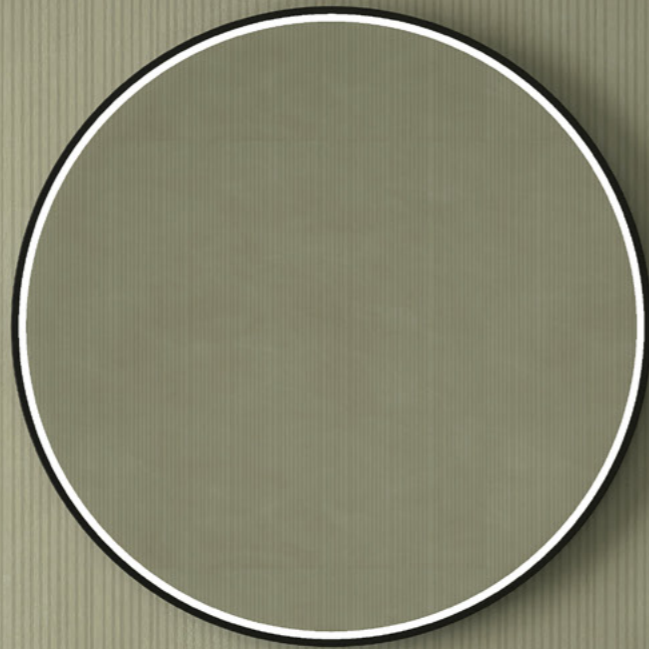

VENUS FREE-STANDING BASIN (FIG.85.1)

VANITY GOALS:  
INSPIRING BATHROOM VANITY  
DESIGNS FOR EVERY STYLE

## NOW IMAGINE: FURNITURE COLLECTION

Introducing an exquisite collection of furniture. Each piece has been crafted with Italian porcelain, the perfect surface solution for interior designers seeking to create striking centerpieces and one-off originals.

All items are manufactured in the UK which means shorter lead times and no logistical headaches. Customer support and delivery services are provided locally.

The collection features a variety of furniture items including dining tables, consoles, coffee and side tables, all made-to-order and customisable in a wide array of original colours and finishes. Each piece boasts a durable and high-performance surface that requires minimal maintenance and is suitable for both residential and commercial use.





TABLE COUTURE:  
THE ART OF SELECTING  
THE PERFECT PIECE FOR YOUR SPACE.

TAVOLO MEZZALUNA ROMANO (FIG. 87.1)



TAVOLINO ROMANO GRANDE (left) MEDIO (centre) PICCOLO (right) (FIG.88.1)





TAVOLINO ROMANO MEDIO (FIG.89.1)

## TAVOLINO ROMANO

Tavolino Romano is a combination of elements. A fluted circular wooden base melts away as the stunning porcelain top appears to defy gravity. Base is made from moulded tulip wood which supports a 12 mm thickness porcelain top. Alternative surfaces available. Combine sizes and colours for contrast or allow just one Tavolino Romano to tell its own beautiful story.

### SPECIFICATION

<b>Grande (mm)</b> (tolerance ±2 mm)	Diameter:	1250
	Height:	400
	Base Diameter:	480

<b>Medio (mm)</b>	Diameter:	700
	Height:	600
	Base Diameter:	360

<b>Piccolo (mm)</b>	Diameter:	600
	Height:	400
	Base Diameter:	300

<b>Table top</b>	12 mm thickness with double bevel
------------------	-----------------------------------

<b>Base design</b>	Circular base in Ebony. Other finishes available.
--------------------	---



**PANDA**  
POLISHED  
12 mm THICKNESS



TAVOLINO ROMANO GRANDE (FIG.90.1)





TAVOLO LUNA ROMANO (FIG.91.1)

## TAVOLO LUNA ROMANO

Tavolo Luna Romano, a luxurious and elegant addition to any dining room. The table's clean lines are beautifully balanced by contrasting tones, creating a striking and sophisticated look. The elegant round top dining table is supported by a single pillar base that can be customised to your taste with a selection of colour combinations and finishes. The top has a diameter of 1450 mm and the base is 450 mm making this table perfect for any high-end dining room.

### SPECIFICATION

<b>Dimensions (mm)</b> (tolerance $\pm 2$ mm)	Diameter: 1450 Height (H): 760
<b>Table top</b>	12 mm thickness with double bevel
<b>Base design</b>	Circular base in Oak. Other finishes available.
<b>Base diameter</b>	450 mm



IRISH GREEN  
POLISHED  
12 mm THICKNESS



TAVOLO MEZZALUNA ROMANO (FIG.92.1)

## TAVOLO MEZZALUNA ROMANO

Elevate the sophistication of your dining space with the Tavolo Mezzaluna Romano. This extraordinary centrepiece boasts a streamlined chic, featuring a generously spacious tabletop and a pair of fluted semicircular pedestal legs. Able to reflect your personal style with a plethora of finishes and colour options to choose from, the Tavolo Mezzaluna Romano stands as the ultimate focal point.

### SPECIFICATION

<b>Dimensions (mm)</b> (tolerance $\pm 2$ mm)	Length (L): 2800
	Depth (D): 1200
	Height (H): 760
<b>Table top</b>	12 mm thickness with double bevel
<b>Base design</b>	500 mm Semicircular base in black. Other finishes available.

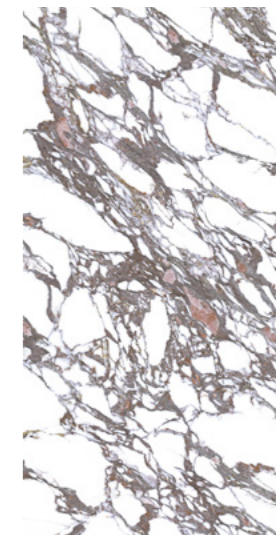

CALACATTA VIOLA  
POLISHED  
12 mm THICKNESS



## TAVOLINO ORIGAMI

The Tavolino Origami is a refined and stylish piece of furniture, designed to add a touch of playfulness and modernity to any living space. Available in two complementary sizes, this table is dressed in a striking contrasting colourway, making it a striking focal point in any room. The Tavolino Origami features a polished white marble effect top and Renoir Calacatta base for a luxurious and upscale feel. For maximum impact, place two in an open living space to create a cohesive and elegant design.

### SPECIFICATION

<b>Grande (mm)</b> (tolerance $\pm 2$ mm)	Length (L): 1200 Depth (D): 1200 Height (H): 280
<b>Medio (mm)</b>	Length (L): 900 Depth (D): 900 Height (H): 380
<b>Table top</b>	12 mm thickness with double bevel
<b>Base design</b>	Rectangular base

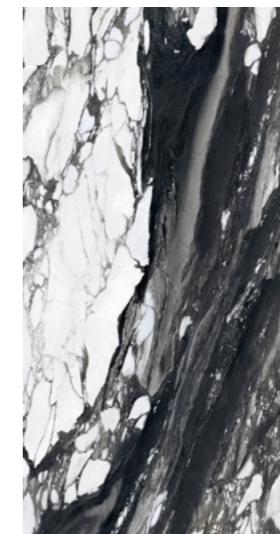

RENOIR CALACATTA  
POLISHED



PARADISE WHITE  
POLISHED  
12 mm THICKNESS



TAVOLINO ORIGAMI GRANDE (LEFT) AND MEDIO (RIGHT) (FIG.93.1)



TAVOLINO ORIGAMI (FIG.94.1)



TAVOLINO ORIGAMI (FIG.94.2)



## TAVOLO ORIGAMI

Tavolo Origami, a masterpiece of luxury furniture, designed to furnish the most contemporary of living spaces. Shown here in its two-tone version, but also available in a single stone, this dining table is crafted from the most luxurious materials and expertly made to ensure it is a true work of art. It can be tailored to your preferences with various colours and finishes to choose from. With its sleek and sophisticated design, the Tavolo Origami comfortably seats eight people and makes a perfect centerpiece for any high-end dining room.



TAVOLO ORIGAMI (FIG.95.1)

### SPECIFICATION

<b>Dimensions (mm)</b> (tolerance $\pm 2$ mm)	Length (L): 2800
	Depth (D): 1200
	Height (H): 760
<b>Table top</b>	60 mm thickness with mitred edge
<b>Base design</b>	Rectangular base



LUMIX  
POLISHED



EBONY  
NATURAL



TAVOLO ORIGAMI (FIG.96.1)





CONSOLLE ORIGAMI (FIG.97.1)

## CONSOLLE ORIGAMI

Consolle Origami is an elegant and refined console table, designed with modern aesthetic and sculptural appeal. It provides a functional space to display your object d'art and is a masterpiece of craftsmanship. Consolle Origami is a statement piece that can add character to any living space. To make an even stronger impact, opt for the two-tone colour combination which creates a truly unique and striking piece. It is an ideal addition for those looking to elevate their home decor with a touch of luxury and exclusivity.

### SPECIFICATION

<b>Dimensions (mm)</b> (tolerance $\pm 2$ mm)	Length (L): 2000
	Depth (D): 500
	Height (H): 900
<b>Console top</b>	40 mm thickness mitred edge
<b>Base design</b>	Rectangular base

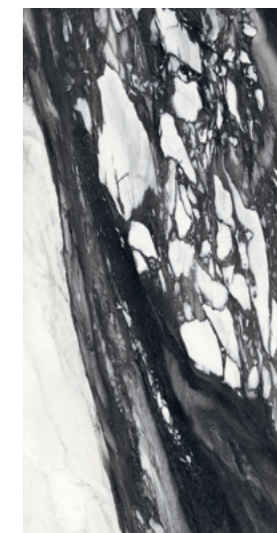
BLACK CALACATTA  
POLISHEDRENOIR CALACATTA  
POLISHED





CONSOLLE ORIGAMI (FIG. 98.1)



CONSOLLE ORIGAMI (FIG. 98.2)



## TAVOLO MEZZALUNA VENEZIANA

Introduce a touch of contemporary elegance to your dining room with the Tavolo Mezzaluna Veneziana. This statement piece showcases a sleek modern design with a grand, expansive top and a twin semicircular base. The table can be customised to suit your taste with a variety of finishes and colour variations available. The table design and its unique detail make it the perfect centerpiece for any luxurious dining room.



TAVOLO MEZZALUNA VENEZIANA (FIG.99.1)

### SPECIFICATION

<b>Dimensions (mm)</b> (tolerance $\pm 2$ mm)	Length (L): 2800 Depth (D): 1200 Height (H): 760
<b>Table top</b>	12 mm thickness with double bevel
<b>Base design</b>	Semicircular base



LATTE VEIN  
NATURAL

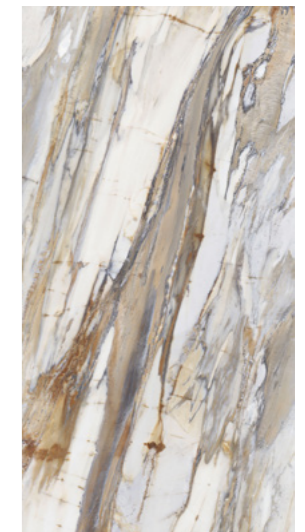

CALACATTA FOSSIL  
POLISHED  
12 mm THICKNESS



TAVOLO MEZZALUNA VENEZIANA (FIG.100.1)



TAVOLO MEZZALUNA VENEZIANA (FIG.100.2)



## TAVOLO LUNA VENEZIANA

Tavolo Luna Veneziana, a luxurious and elegant addition to any dining room. The table's clean lines are beautifully balanced by contrasting tones, creating a striking and sophisticated look. The elegant round top dining table is supported by a single pillar base that can be customised to your taste with a selection of colour combinations and finishes. The top has a diameter of 1450 mm and the base is 450 mm making this table perfect for any high-end dining room.



TAVOLO LUNA VENEZIANA (FIG.101.1)

### SPECIFICATION

<b>Dimensions (mm)</b> (tolerance $\pm 2$ mm)	Diameter:	1450
	Height (H):	760
<b>Table top</b>	6 mm thickness with double bevel	
<b>Base design</b>	Circular	
<b>Base diameter</b>	450 mm	



VIOLET  
POLISHED

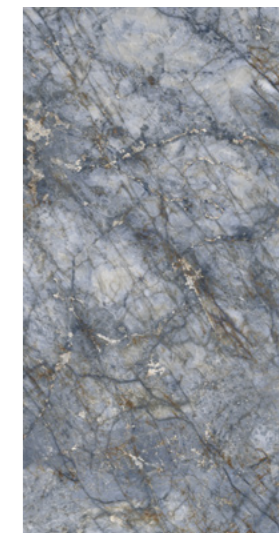

BLUE ANDE  
POLISHED  
6 mm THICKNESS



TAVOLO LUNA VENEZIANA (FIG.102.1)



TAVOLO LUNA VENEZIANA (FIG.102.2)



## TAVOLO TELESTO VENEZIANA

Tavolo Telesto Veneziana is a masterful blend of luxury and elegance, designed to elevate any dining room. Able to seat up to eight people, this grand table boasts a 50 mm thickness top that is harmoniously paired with its twin pedestal base. The top is adorned with a sleek metallic banding that adds a touch of refinement to its overall look. Shown here in an Decorative Bronze finish. Banding can be tailored to your personal style with a variety of alternative finishes available.



TAVOLO TELESTO VENEZIANA (FIG.103.1)

### SPECIFICATION

<b>Dimensions (mm)</b> (tolerance $\pm 2$ mm)	Length (L): 2900 Depth (D): 1300 Height (H): 760
<b>Table top</b>	50 mm with metal banding
<b>Base design</b>	Oval base
<b>Profile banding</b>	Metal banding - Decorative Bronze

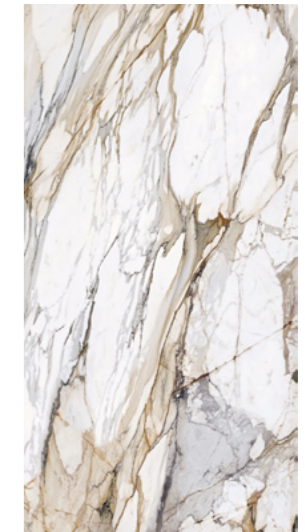

MACCHIA VECCHIA  
POLISHED



TAVOLO TELESTO VENEZIANA (FIG.104.1)



TAVOLO TELESTO VENEZIANA (FIG.104.2)



## CONSOLLE VENEZIANA

Consolle Veneziana is a breathtaking piece of furniture, perfect for adding a touch of refined elegance to the entryways or hallways of modern homes. This striking sculptural console table features a twin semicircular base adorned with intricate decoration. This unique design element adds a touch of timeless beauty, making it a true conversation piece. This console table is the perfect blend of form and function, and an ideal addition for those looking to elevate their home decor with a touch of luxury and exclusivity.



CONSOLLE VENEZIANA (FIG.105.1)

### SPECIFICATION

<b>Dimensions (mm)</b> (tolerance $\pm 2$ mm)	Length (L): 1700
	Depth (D): 450
	Height (H): 900
<b>Console top</b>	12 mm thickness with double bevel
<b>Base design</b>	Semicircular base



MOON GREY  
NATURAL  
12 mm THICKNESS



CONSOLLE VENEZIANA (FIG.106.1)



CONSOLLE VENEZIANA (FIG.106.2)





CONSOLLE GESSATO (FIG.107.1)

## CONSOLLE GESSATO

Consolle Gessato is a work of art, a sophisticated and refined console that combines modern design with timeless elegance. The console boasts an angled rectangular base adorned with a vertical decorative detail. Shown here in two contrasting colours, the 50 mm thickness top features a bold design, that contrasts beautifully with the base. Aesthetically versatile, and strong enough to make a statement in any hallway, Consolle Gessato can be specified in various colour combinations to suit your scheme. It is a perfect blend of form and function, making it a must-have for the discerning home designer seeking to add a touch of luxury and sophistication to their living space.

### SPECIFICATION

<b>Dimensions (mm)</b> (tolerance $\pm 2$ mm)	Length (L): 1950 Depth (D): 450 Height (H): 900
<b>Console top</b>	50 mm thickness with mitred edge
<b>Base design</b>	Rectangular base
<b>Flute divide</b>	10 mm

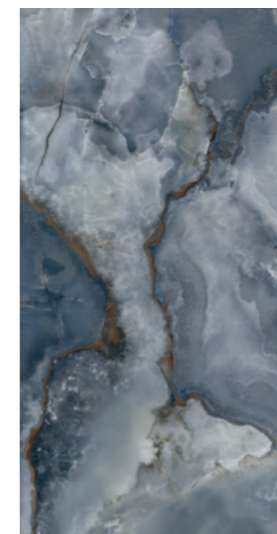
SODALITE  
POLISHEDPURO  
POLISHED



CONSOLLE GESSATO (FIG.108.1)



CONSOLLE GESSATO (FIG.108.2)



## TAVOLO GESSATO

Tavolo Gessato has been designed to elevate the grandest of living spaces with its dynamic finish and striking design. The structure of this table is a masterpiece of geometric lines, culminating in a magnificent 12 mm thickness top. The edges are intricately bevelled, and each piece holds its individuality due to the subtle variations within the porcelain stone. The twin rectangular base features a vertical decorative detail that adds an extra touch of elegance.

A statement piece that will leave a lasting impression.



TAVOLO GESSATO (FIG.109.1)

### SPECIFICATION

<b>Dimensions (mm)</b> (tolerance $\pm 2$ mm)	Length (L): 2500 Depth (D): 1100 Height (H): 760
<b>Table top</b>	12 mm thickness with double bevel
<b>Base design</b>	Rectangular base
<b>Flute divide</b>	20 mm

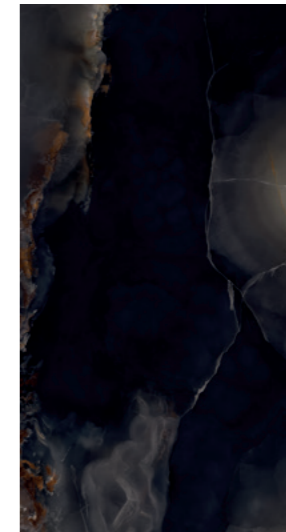

**JET**  
POLISHED  
12 mm THICKNESS



**TORTORA TAFU**  
NATURAL



TAVOLO GESSATO (FIG.110.1)



TAVOLO GESSATO (FIG.110.2)





TAVOLINO TORNIO GRANDE (FIG.111.1)

## TAVOLINO TORNIO

The alliance between product designer and furniture manufacturer can result in truly exceptional pieces that embody the designer's vision while also showcasing the craftsmanship and beauty of the porcelain surface. Tavolino Tornio is a luxurious round coffee and side table set, featuring a single pedestal and sleek rectangular base. Its deceptively simple design is elevated by the contrasting colourways and framed by a metallic band around the top surface. This elegantly minimal piece is available in a variety of alternative colour pairs and metal banding styles, custom crafted to meet your specific tastes and preferences.

### SPECIFICATION

<b>Grande (mm)</b> (tolerance $\pm 2$ mm)	Diameter: 1450 Height (H): 400
<b>Medio (mm)</b>	Diameter: 700 Height (H): 600
<b>Table top</b>	40 mm thickness with metal banding
<b>Profile banding</b>	Metal banding - Brushed Gold

LATTE VEIN  
NATURALTORTORA TAFU  
POLISHED



TAVOLINO TORNIO MEDIO (FIG.112.1)



TAVOLINO TORNIO GRANDE (FIG.112.2)





TAVOLINO CUBO MEDIO (TOP) PICCOLO (BOTTOM) (FIG.113.1)

## TAVOLINO CUBO

Tavolino Cubo, a luxurious furniture piece that exudes sophistication and elegance. Handcrafted by skilled artisans using only the finest materials, this versatile piece can be used as a coffee, side, or occasional table. Showcasing a striking contrast of light and dark colourways, its clean lines and minimalist design make it the perfect centerpiece for any luxurious interior. Customise your own unique piece with a variety of finishes and colour combinations available upon request.

### SPECIFICATION

<b>Grande (mm)</b> (tolerance $\pm 2$ mm)	Length (L): 1200 Depth (D): 1200 Height (H): 200
<b>Medio (mm)</b>	Length (L): 1200 Depth (D): 600 Height (H): 350
<b>Piccolo (mm)</b>	Length (L): 600 Depth (D): 600 Height (H): 350

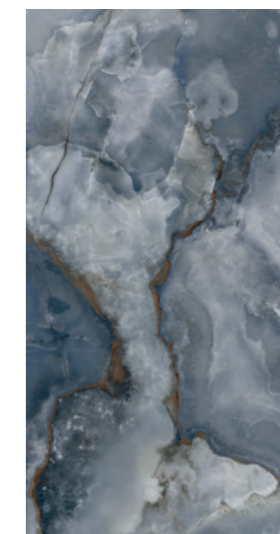
LATTE CROSS  
NATURALSODALITE  
POLISHED



TAVOLINO CUBO GRANDE (FIG. 114.1)



TAVOLINO CUBO MEDIO (FIG. 114.2)











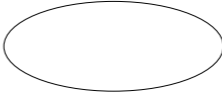

TOV-TT04 TABLE TOP (FIG.115.1)

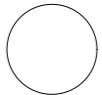
## TABLE TOP CONFIGURATION

Italian porcelain surfaces are available as luxurious and elegant table tops and table inlays. Known for their durability and timeless beauty, and with a wide selection of colours and styles to choose from, each top boasts its own delicate veining and unique patterns. There is a choice of three finishes including Polished, with its high shine, Honed which adds a soft sheen, or Natural with its delicate textures, each adding an air of sophistication and refinement. Please note that if you are supplying your own base, porcelain table tops are extremely heavy and require a very sturdy support.

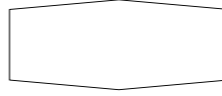
### CONFIGURATION

Model	TOV-TT01	TOV-TT03	TOV-TT02
			
<b>Maximum Dimensions</b>	2900 x 1400 mm	2900 x 1400 mm	1400 x 1400 mm
Model	TOV-TT04	TOV-TT06	TOV-TT07
			
<b>Maximum Dimensions</b>	2900 x 1400 mm	2900 x 1400 mm	1400 x 1400 mm
Model	TOV-TT08	TOV-TT09	TOV-TT11
			
<b>Maximum Dimensions</b>	2900 x 1400 mm	2900 x 1400 mm	2900 x 1400 mm

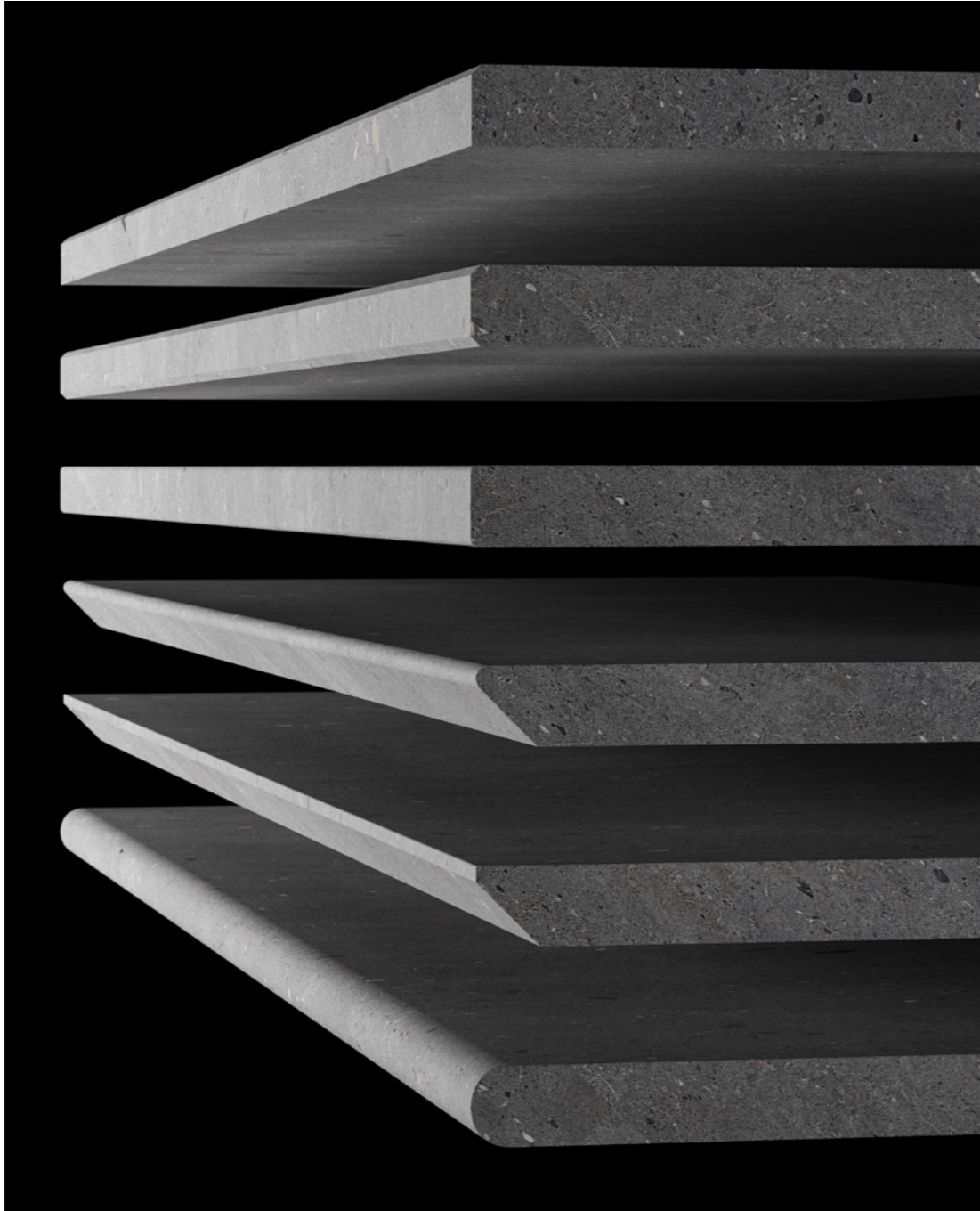
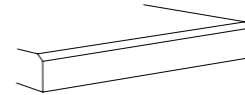

TABLE TOP PROFILES (FIG. 116.1)

## TABLE TOP PROFILES

12 and 20 mm thicknes table tops can be specified with a choice of edge profiles:



BEVELLED EDGE

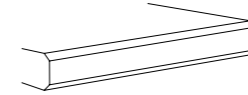

DOUBLE BEVELLED EDGE

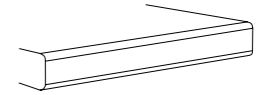

DOUBLE PENCIL EDGE



HALF BULLNOSE EDGE

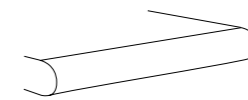

BULLNOSE EDGE

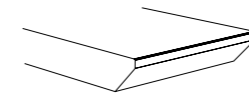

SPECIAL SHARK NOSE EDGE

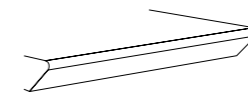

SHARK NOSE EDGE



## PROFILE BANDING OPTIONS

Table tops can be specified with an attractive and durable metal banding edge. Banding is available in a choice of six metallic colours that can be used to complement or contrast with the chosen surface design. Banding can be specified between 40 to 100 mm in thickness for table tops.

**Profile banding** [ 90° Metal Banding ]

**Banding colour** [ Brushed Copper ][ Brushed Bronze ][ Brushed Gold ]

[ Brushed Inox ][ Satin Black ][ Decorative Bronze ]

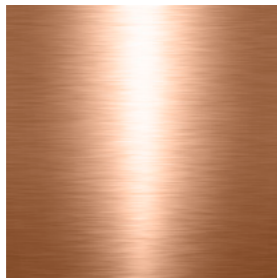

BRUSHED COPPER

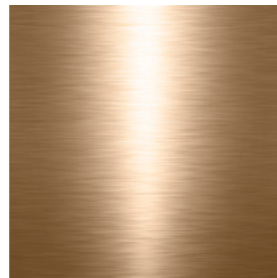

BRUSHED BRONZE



BRUSHED GOLD



BRUSHED INOX



SATIN BLACK

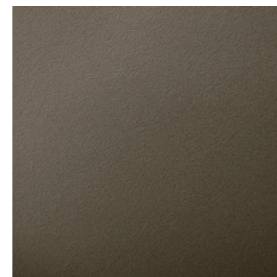

DECORATIVE BRONZE

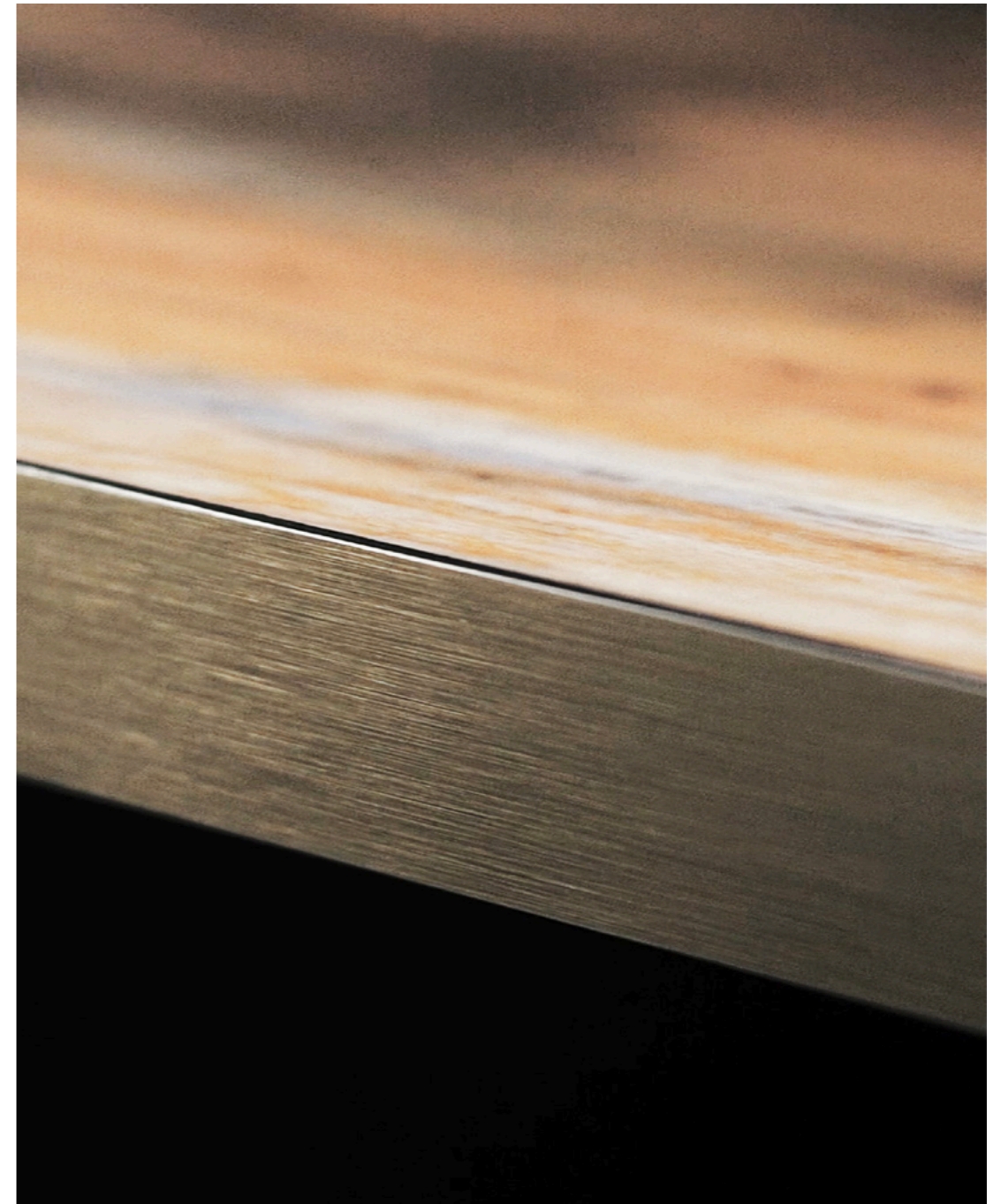

BRUSHED BRONZE METAL BANDING (FIG.117.1)



SEMICIRCULAR LEG MODEL WITH WOOD DECOR STYLE 4 (FIG.118.1)

## WOOD LEG OPTIONS

Explore the diverse range of wooden leg options available, each crafted to complement and enhance the aesthetic of your porcelain table top.

### CONFIGURATION

#### Wood Leg Models

CIRCULAR

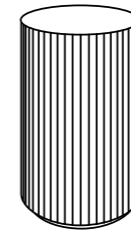

SEMICIRCULAR

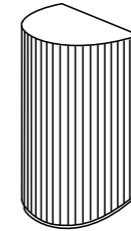

OVAL

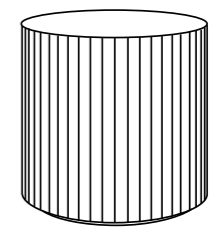

#### Wood Decor Styles

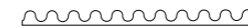

DECOR STYLE 1

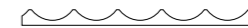

DECOR STYLE 2



DECOR STYLE 3



DECOR STYLE 4



DECOR STYLE 5



DECOR STYLE 6





CIRCULAR LEG MODEL WITH EBONY COLOUR BASE (FIG. 119.1)

## WOOD LEG COLOUR OPTIONS

Whether you're drawn to classic designs or contemporary styles, we will help you make informed choices, ensuring your furniture reflects your unique taste and seamlessly integrates into your space.



EBONY



AMERICAN WALNUT



OAK



JET BLACK - RAL 9005



BLACK GREY - RAL 7021

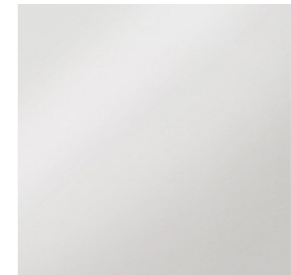

SILK GREY - RAL 7044



PODIUM (FIG.120.1)

## PODIUM

Podium is four or six-sided plinth which can also be used as a low table or seating unit. Present object d'art or sculptures in all their glory, Podium can also be specified as a planter with a shallow base ideal for orchids and other statement plants. Use within bathrooms, public places, galleries, or hotel lobbies.

### SPECIFICATION

Model	Podium
Height (H):	150-1200
Width (W):	200-500
Depth (D):	200-500

### PLANTER OPTION

Top plate	[ Fixed ][ Planter ]
Top plate depth (mm)	80-200



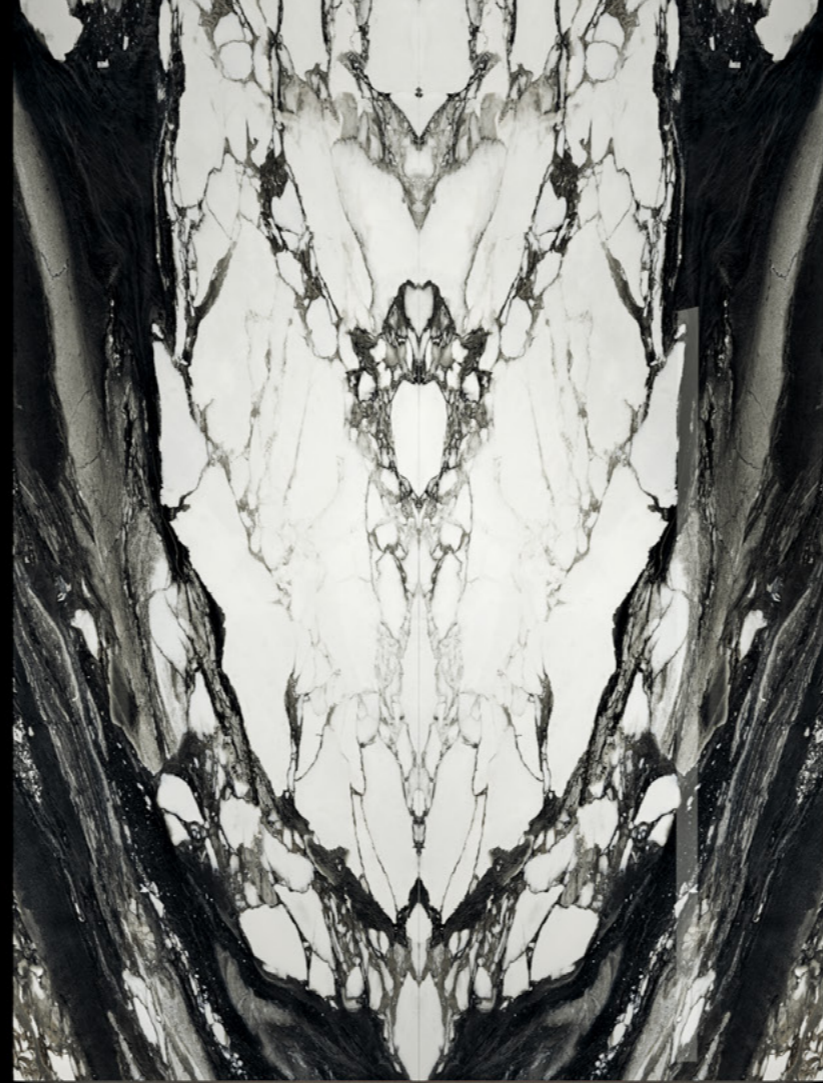

TAVOLINO ORIGAMI (FIG. 121.1)





LIVING ROOM LUXURY:  
DINING TABLES THAT  
ELEVATE YOUR SPACE

TAVOLO MEZZALUNA VENEZIANA (FIG. 122.1)



## KITCHEN WORKTOPS

Remodel kitchen islands and countertops with a brand new porcelain worktop. Install precision cut high-performance worktops from a choice of over one hundred stunning colours and styles. Upgrading existing kitchen worktops is easy... Select your chosen surface from our extensive collection of Italian Porcelain. Then schedule an appointment to carry out a detailed laser templating of the project site. When the new top is ready, we send our installation team to deliver and install it. The entire process is stress free, and because we take care of the entire process from templating, manufacturing to installation, it is also totally risk free.

### COUNTERTOP DATA SHEET

<b>Length (L)</b>	∞ (Max 3200 mm without a join)	
<b>Depth (D)</b>	651 - 1500 mm	
<b>Thickness (T)</b>	12 mm	20 mm
<b>Approximate weight</b>	29 kg per m <sup>2</sup>	45 kg per m <sup>2</sup>
<b>Edge profile</b>	See Edge Profiles	
<b>Configurable options</b>	Options for cut-outs, integrated sink and tap holes	



12 mm ISLAND COUNTERTOP (FIG.123.1)





12 mm ISLAND COUNTERTOP (FIG.124.1)











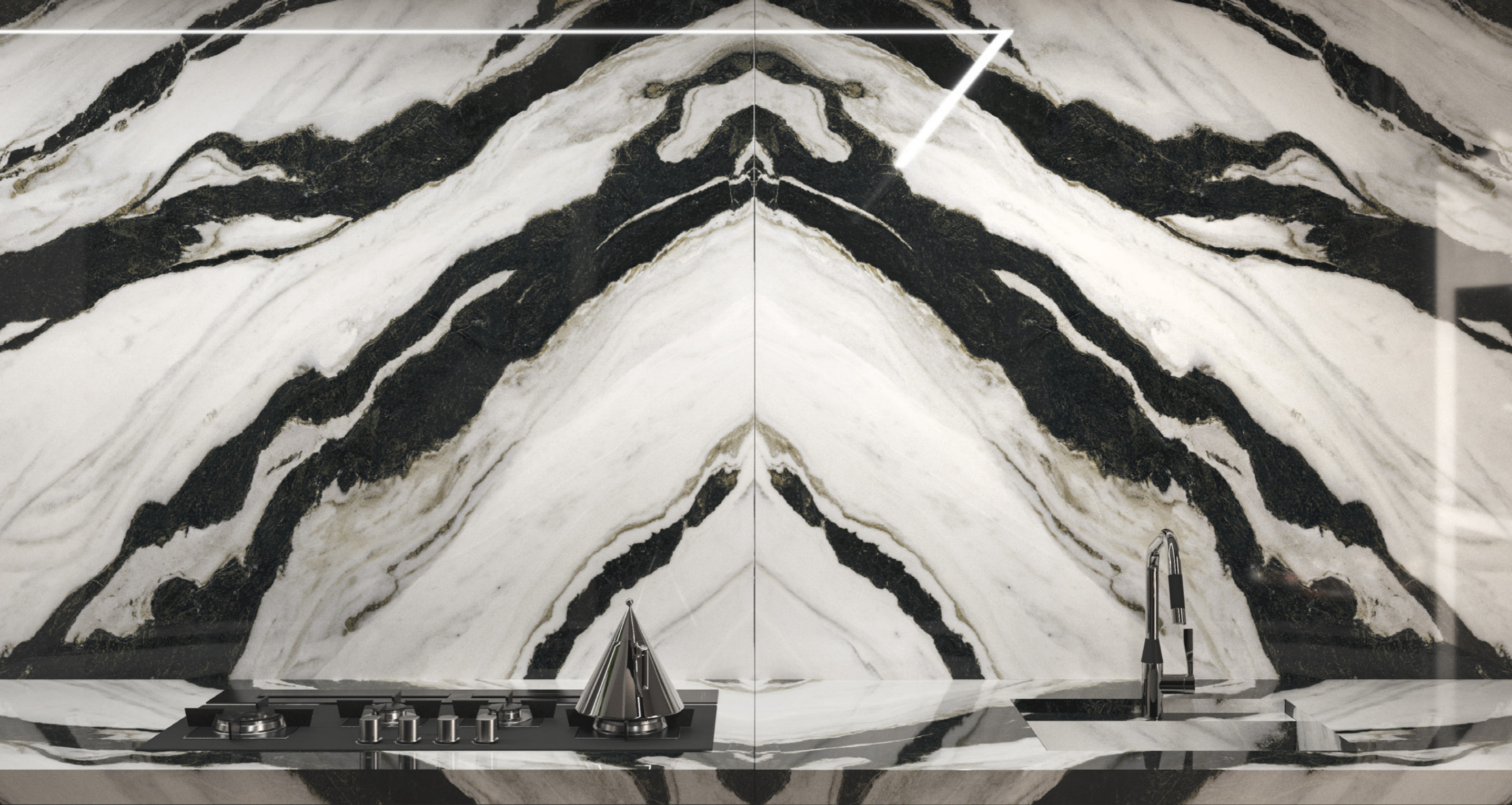

SPLASHBACK FEATURE WALL (FIG. 127.1)



# PORCELAIN SURFACES REDEFINED

The products presented in this catalogue are available in a wide range of colours and styles. All colours can be paired with matching large format Italian porcelain slabs for walls and floors. Porcelain slabs are the latest generation of surface materials that combine lightweight design with increased technical performance.

These slabs redefine conventional size rules, with 160 x 320 cm formats that offer unparalleled versatility for ambitious design schemes. Additional formats measuring 120 x 278 cm have been introduced to provide practical solutions for walls, minimising waste and eliminating the need for cutting during installation.

With a thickness of just 6 millimetres, these porcelain slabs can be seamlessly used for flooring, wall cladding, or fixed to any vertical or horizontal surface including upstands and skirting. The result is an easy-to-install, continuous flat surface with minimal grout lines and maximum decorative impact.

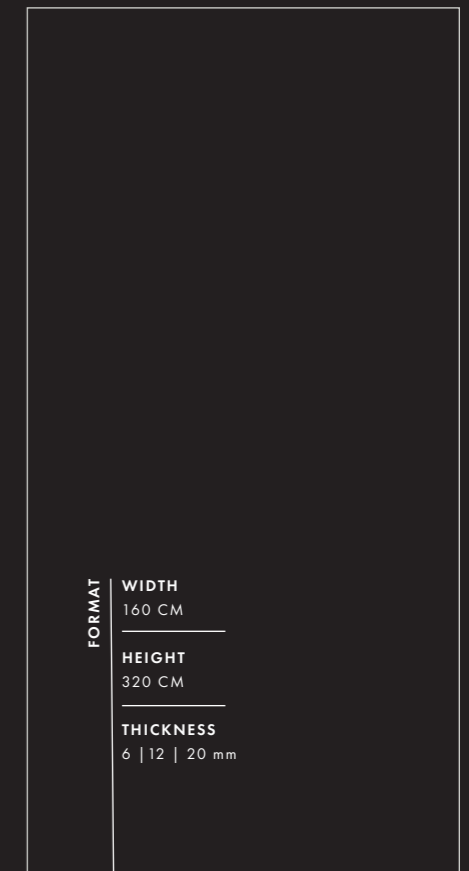
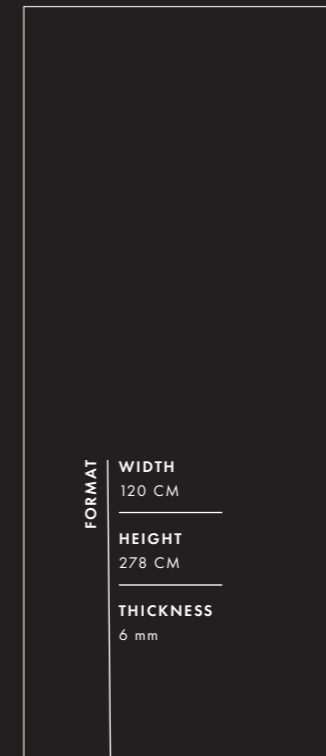
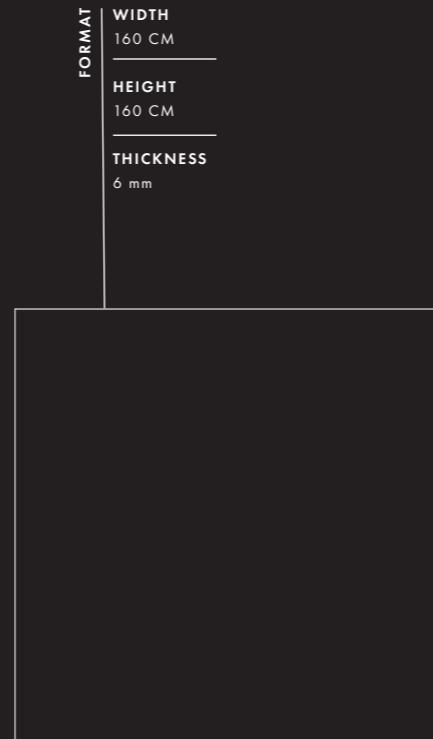



# 6 mm SLABS

All items 6 mm unless specified



**BLACK CALACATTA**  
POLISHED | NATURAL

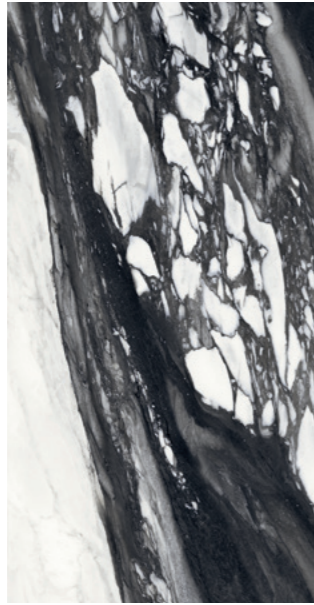

**RENOIR CALACATTA**  
POLISHED

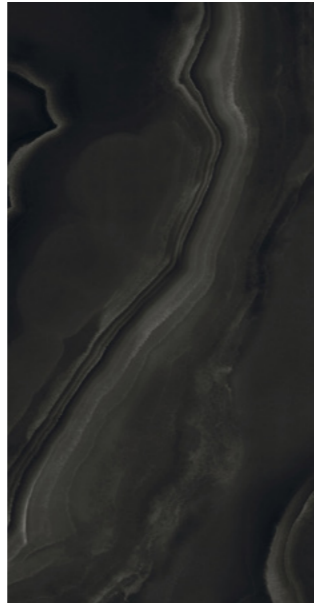

**OBSIDIAN GLOW**  
POLISHED



**IMPERIAL BLACK SELECT**  
POLISHED | NATURAL

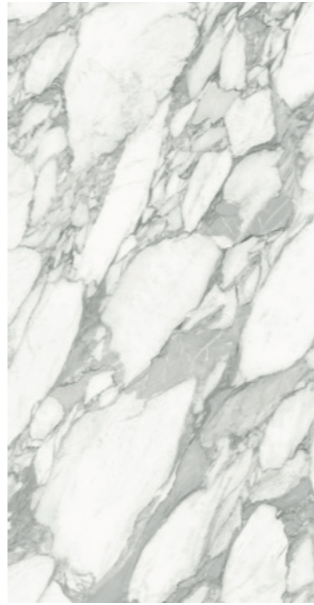

**CORCHIA ARABESCATO**  
POLISHED



**BIANCO STATUARIO**  
POLISHED



**CALACATTA CANOVA**  
POLISHED



**MACCHIA VECCHIA**  
POLISHED



**MOON GREY**  
POLISHED | NATURAL



**MICHELANGELO STATUARIO**  
POLISHED | NATURAL

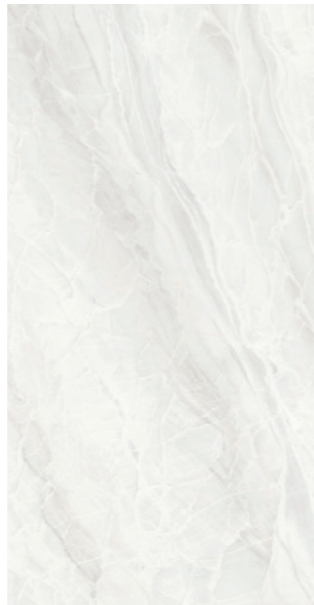

**PARADISE WHITE**  
POLISHED

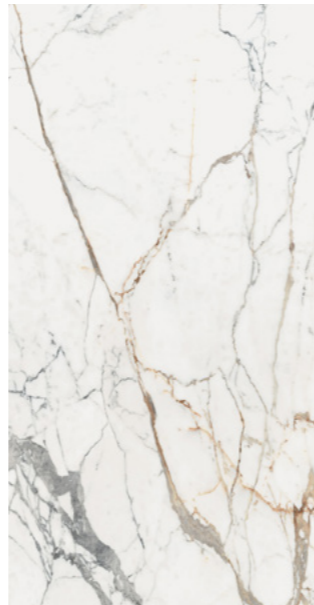

**CALACATTA DORATO**  
POLISHED | NATURAL



**QUARZO**  
POLISHED | NATURAL



**LUMIX**  
POLISHED | NATURAL

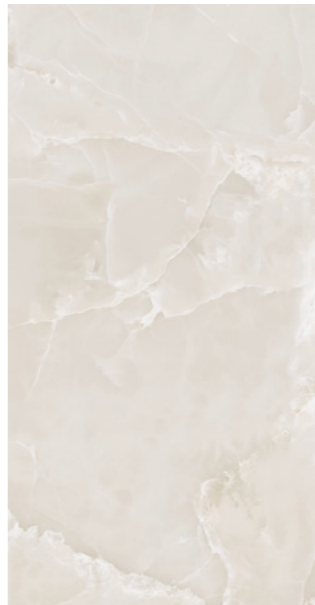

**PEARL BREEZE**  
POLISHED



**CALACATTA GOLD**  
POLISHED | NATURAL



# 6 mm SLABS

All items 6 mm unless specified



**IVORY GIOIELLO**  
POLISHED



**GOLDEN AMBRA**  
POLISHED

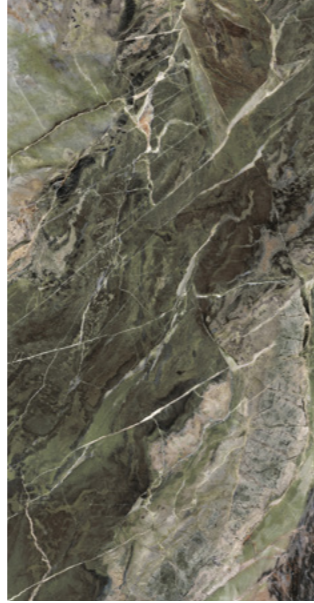

**CRISTALLO ENIGMA**  
POLISHED | NATURAL



**LUX GREEN**  
POLISHED | NATURAL

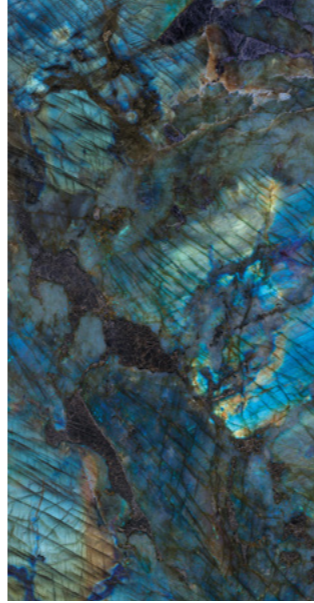

**LABRADORITE**  
POLISHED

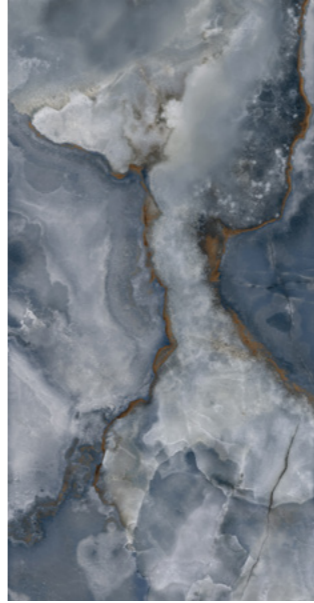

**SODALITE**  
POLISHED

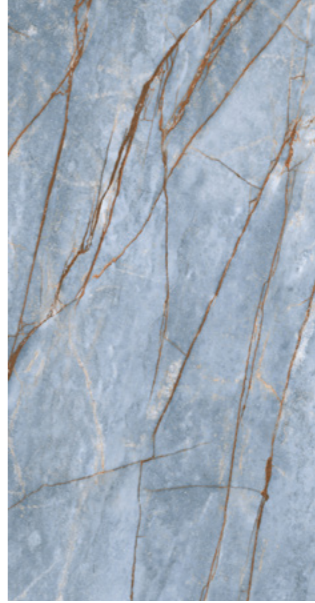

**BLUEDEEP**  
POLISHED | NATURAL

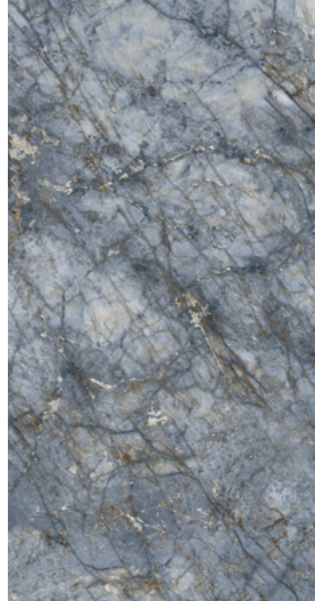

**BLUE ANDE**  
POLISHED

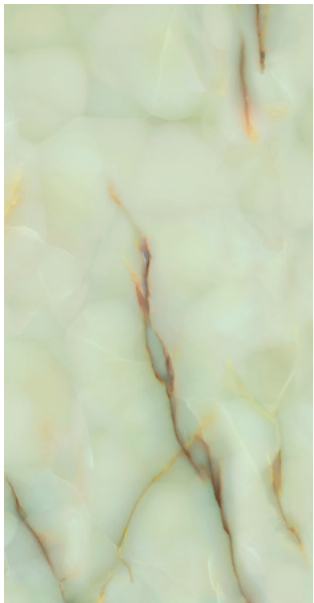

**SMERALDO**  
POLISHED

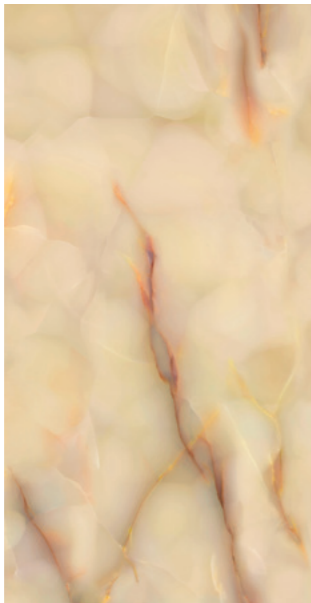

**DOLCE**  
POLISHED



**MALAGA**  
POLISHED

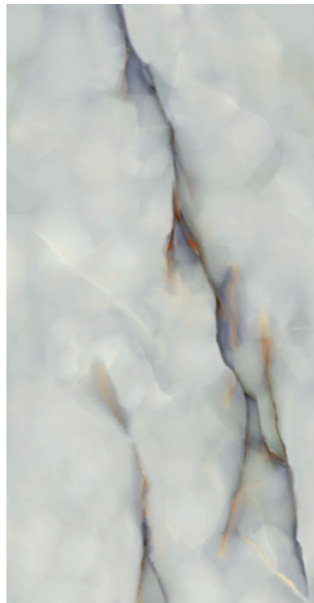

**VIOLET**  
POLISHED

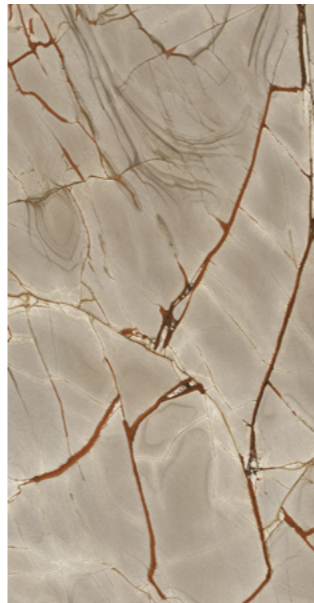

**RAINFOREST**  
POLISHED | NATURAL



**PATAGONIA VITRUM**  
POLISHED | NATURAL



**TUNDRA**  
POLISHED | NATURAL



**MOKA FLAME**  
NATURAL | POLISHED



# 6 mm SLABS

All items 6 mm unless specified

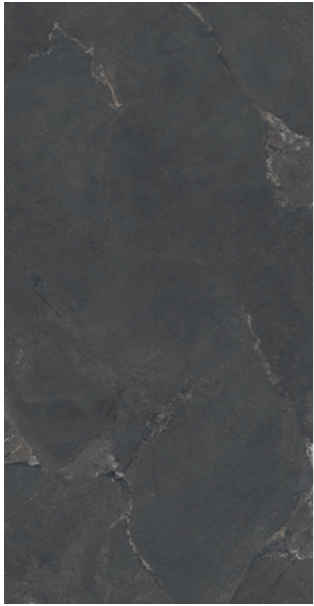

**EBONY**  
NATURAL



**SLATE**  
NATURAL



**TAN**  
NATURAL



**ALABASTER**  
NATURAL



**BLACK**  
POLISHED | NATURAL



**AGED BRONZE**  
NATURAL



**RUSSET**  
NATURAL





## 6 mm SLABS

All items 6 mm unless specified



CARAMEL  
POLISHED

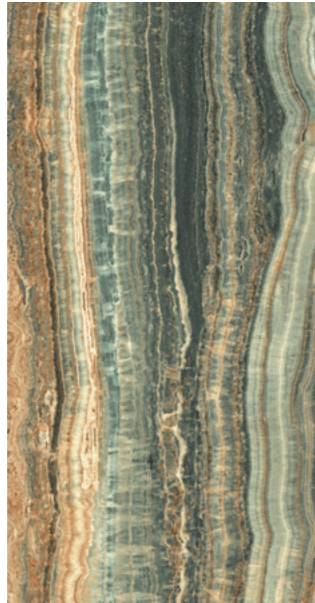

MINT  
POLISHED



SAGE  
POLISHED



ALMOND  
POLISHED





# 6 mm SLABS

All items 6 mm unless specified



**SABBIA**  
POLISHED | NATURAL



**CALCE BIANCA**  
POLISHED | NATURAL



**ROCCIA DUNE**  
NATURAL



**ROCCIA PEARL**  
NATURAL



**LATTE VEIN**  
POLISHED | NATURAL

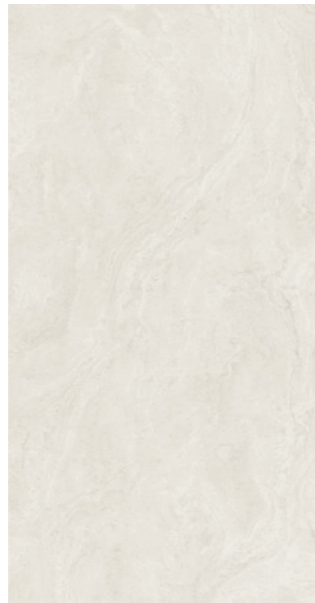

**LATTE CROSS**  
NATURAL



**MINIMA DUNE**  
NATURAL



**MINIMA PEARL**  
NATURAL





# 6 mm SLABS

All items 6 mm unless specified

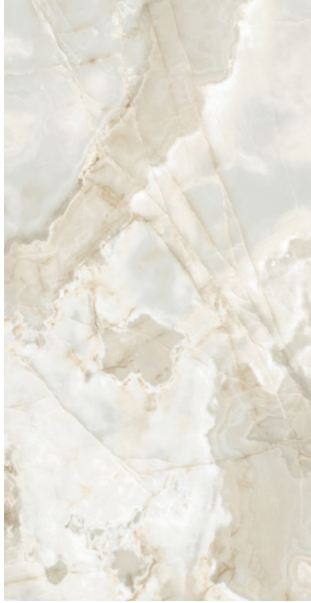

**IVORY**  
POLISHED | NATURAL



**JADE ONYX**  
POLISHED | NATURAL

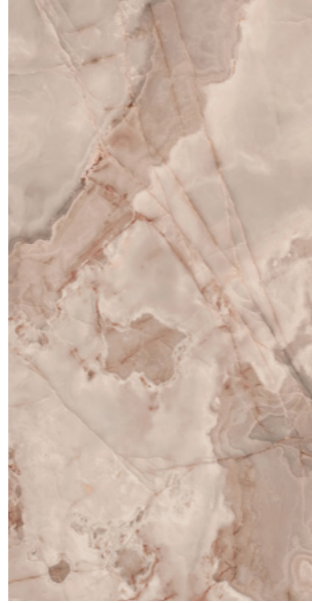

**ROSE ONYX**  
POLISHED | NATURAL



**LUXURIA**  
POLISHED | HONED

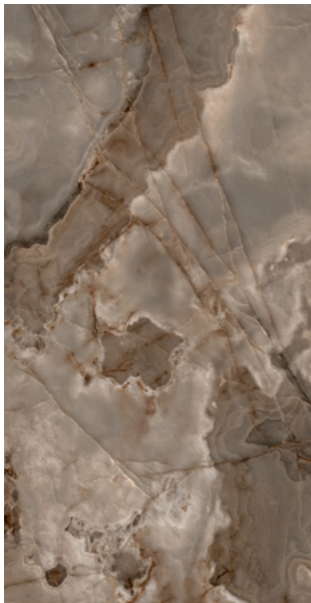

**BROWN ONYX**  
POLISHED | NATURAL



**HAZELNUT**  
POLISHED | NATURAL



**OYSTER**  
POLISHED | NATURAL





## 6 mm SLABS

All items 6 mm unless specified



MOGANO  
NATURAL



MORO  
NATURAL



MULBERRY  
NATURAL



MAPLE  
NATURAL



ACACIA  
NATURAL



COBOLO  
NATURAL





# 12 mm SLABS

All items 12 mm unless specified



**MARBLE MARQUINIA**  
POLISHED | NATURAL  
\*ALSO AVAILABLE IN 6 mm

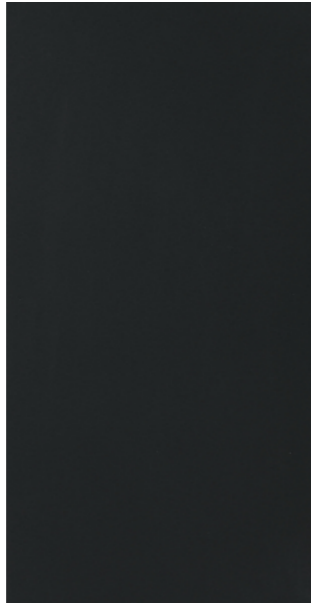

**COLOR BLACK**  
POLISHED | NATURAL

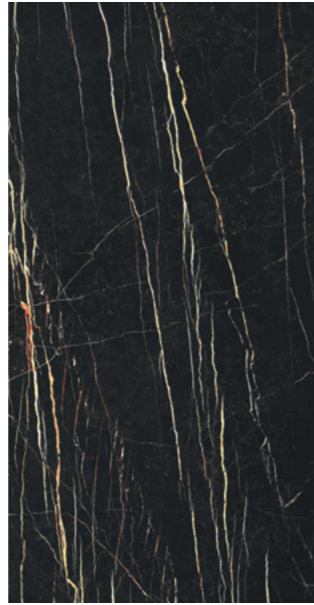

**NOIR DORATO**  
POLISHED | NATURAL  
\*ALSO AVAILABLE IN 6 mm

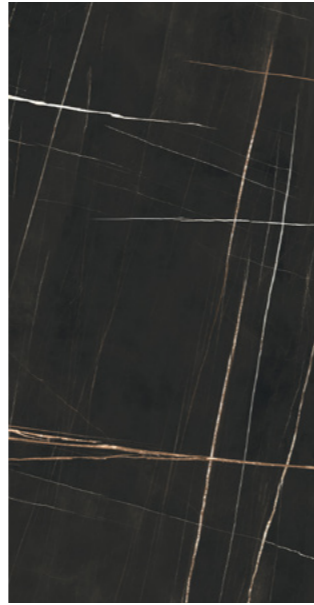

**STONE SAHARA NOIR**  
POLISHED | NATURAL  
\*ALSO AVAILABLE IN 6 mm



**PURPLE STONE**  
SILK  
\*ALSO AVAILABLE IN 6 mm



**SLATE BLACK**  
NATURAL



**SLATE GREY**  
NATURAL

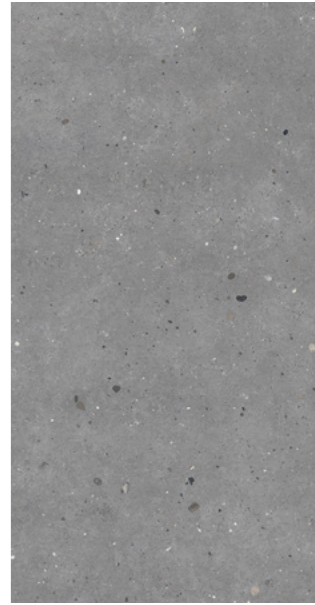

**CANTERA LIGHT**  
NATURAL



**BASALTO**  
NATURAL



**METAL BURNISHED**  
NATURAL  
\*ALSO AVAILABLE IN 6 mm



**SAINT LAURENT**  
POLISHED | NATURAL  
\*ALSO AVAILABLE IN 6 mm



**TORTORA TAFU**  
POLISHED | NATURAL  
\*ALSO AVAILABLE IN 6 mm



**BLONDE OAK**  
NATURAL



**BIANCO LASA**  
POLISHED | NATURAL  
\*ALSO AVAILABLE IN 6 mm

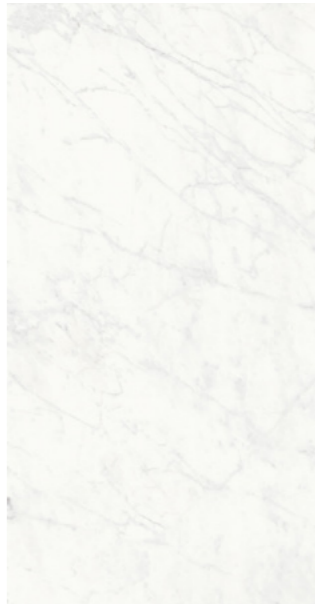

**STONE\_01**  
POLISHED | NATURAL  
\*ALSO AVAILABLE IN 6 mm



# 12 mm SLABS

All items 12 mm unless specified



**SHAKE TRAVERTINE**  
SOFT  
\*ALSO AVAILABLE IN 6 mm



**MARFIL**  
POLISHED | NATURAL  
\*ALSO AVAILABLE IN 6 mm



**NOBLE WHITE**  
NATURAL



**TRAVERTINO MINIMAL WHITE**  
NATURAL  
\*ALSO AVAILABLE IN 6 mm



**PEARL TRAVERTINE**  
NATURAL | HONED  
\*ALSO AVAILABLE IN 6 mm



**GOLD TRAVERTINE**  
SOFT  
\*ALSO AVAILABLE IN 6 mm



**TRAVERTINO ROMANO**  
NATURAL  
\*ALSO AVAILABLE IN 6 mm



**TRAVERTINO VEIN WHITE**  
NATURAL  
\*ALSO AVAILABLE IN 6 mm





# 12 mm SLABS

All items 12 mm unless specified



**VERDE ALPI**  
POLISHED | NATURAL



**MARBLE AUBISQUE**  
POLISHED | SILK  
\*ALSO AVAILABLE IN 6 mm



**QUARZITE ENIGMA**  
POLISHED | NATURAL  
\*ALSO AVAILABLE IN 6 mm



**BALTIC BROWN**  
POLISHED | NATURAL  
\*ALSO AVAILABLE IN 6 mm



**CONCRETE DARK GREY**  
NATURAL  
\*ALSO AVAILABLE IN 6 mm



**CONCRETE TAUPE**  
NATURAL  
\*ALSO AVAILABLE IN 6 mm



**CONCRETE ASH**  
NATURAL  
\*ALSO AVAILABLE IN 6 mm



**CONCRETE WHITE**  
NATURAL  
\*ALSO AVAILABLE IN 6 mm



**MARBLE CAPRAIA**  
POLISHED | NATURAL



**YAMUNA**  
POLISHED | NATURAL



**ICEBERG**  
NATURAL  
\*ALSO AVAILABLE IN 6 mm

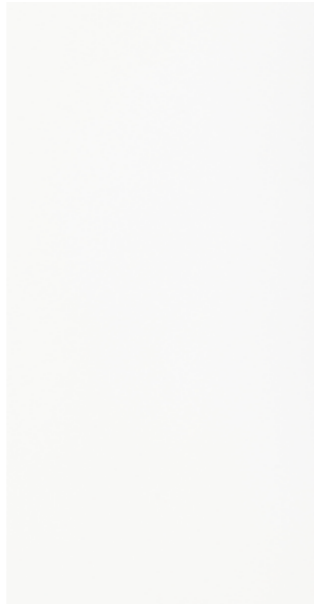

**PURE WHITE**  
POLISHED | NATURAL



**FOSSIL GREY**  
NATURAL



**STONE MONTPELLIER**  
MATTE LEATHER  
\*ALSO AVAILABLE IN 6 mm



**STONE DORDOGNE**  
MATTE LEATHER  
\*ALSO AVAILABLE IN 6 mm



**STONE CHABLIS**  
MATTE LEATHER  
\*ALSO AVAILABLE IN 6 mm



# 12 mm SLABS

All items 12 mm unless specified



**STONE NOIR**  
NATURAL



**STONE GRIS**  
NATURAL



**STONE BROWN**  
NATURAL



**STONE JURA**  
HONED  
\*ALSO AVAILABLE IN 6 mm



**BLACK GRANITE**  
MATTE LEATHER  
\*ALSO AVAILABLE IN 6 mm



**BLUE GRANITE**  
NATURAL  
\*ALSO AVAILABLE IN 6 mm



**FOSSIL IVORY**  
NATURAL





# BOOKMATCHED COLOURS

All items 12 mm unless specified

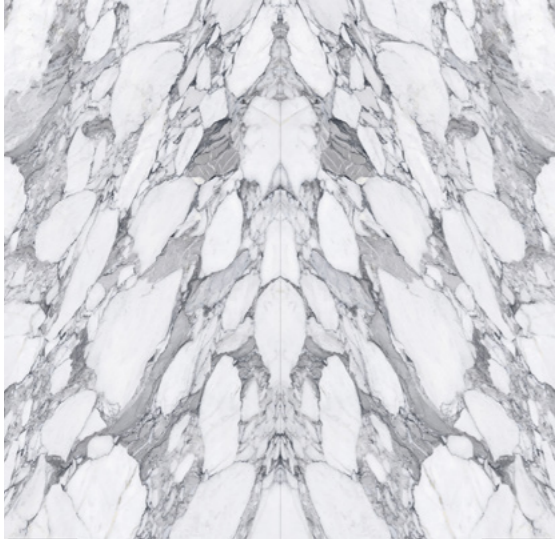

**CORCHIA ARABESCATO BOOKMATCHED**  
POLISHED

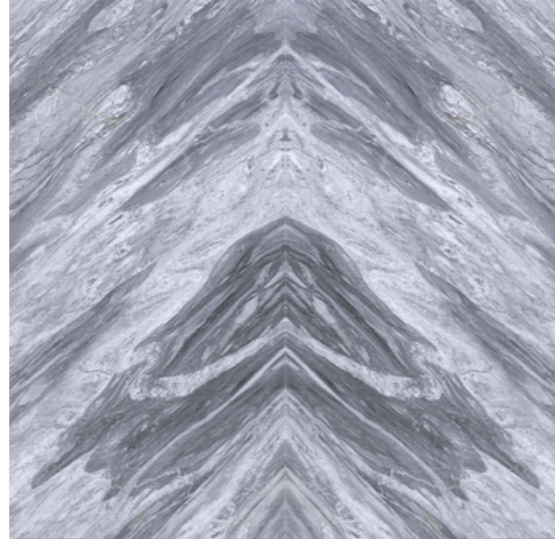

**BORDIGLIO MANHATTAN BOOKMATCHED**  
POLISHED | NATURAL



**BLACK CALACATTA BOOKMATCHED**  
POLISHED | NATURAL

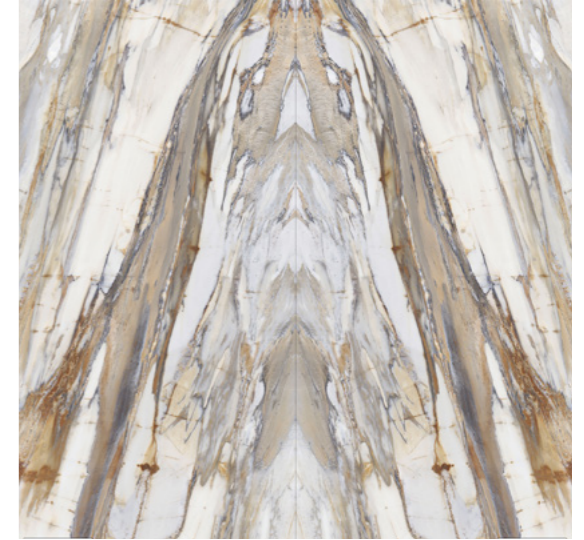

**CALACATTA FOSSIL BOOKMATCHED**  
POLISHED | NATURAL

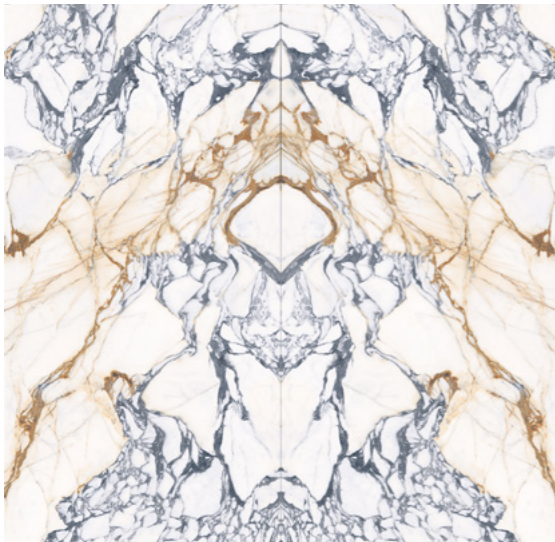

**PAONAZZO BOOKMATCHED**  
POLISHED

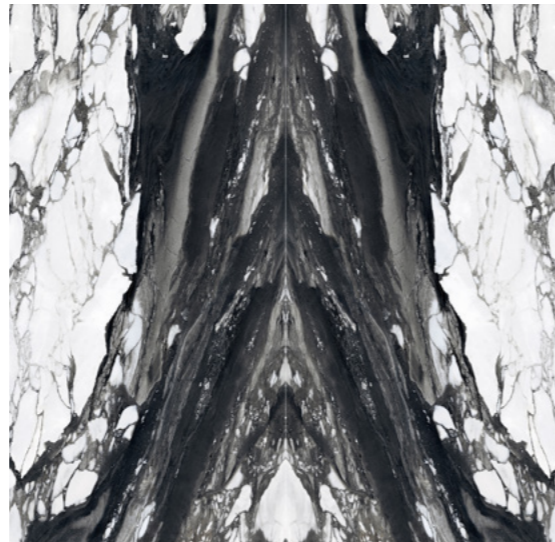

**RENOIR CALACATTA BOOKMATCHED**  
POLISHED

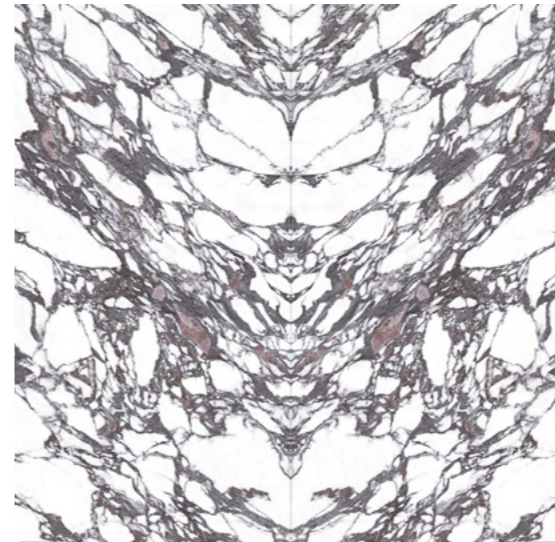

**CALACATTA VIOLA BOOKMATCHED**  
POLISHED | NATURAL



**GRANITE STONE BOOKMATCHED**  
NATURAL



# BOOKMATCHED COLOURS

All items 12 mm unless specified

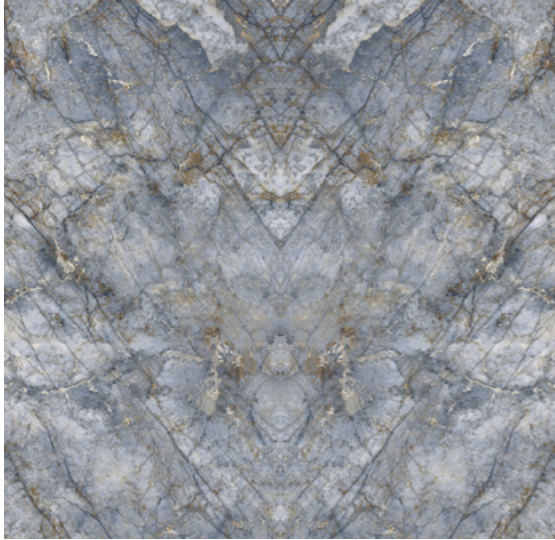

**BLUE ANDE BOOKMATCHED**  
POLISHED



**EBONY BOOKMATCHED**  
BRUSHED | NATURAL

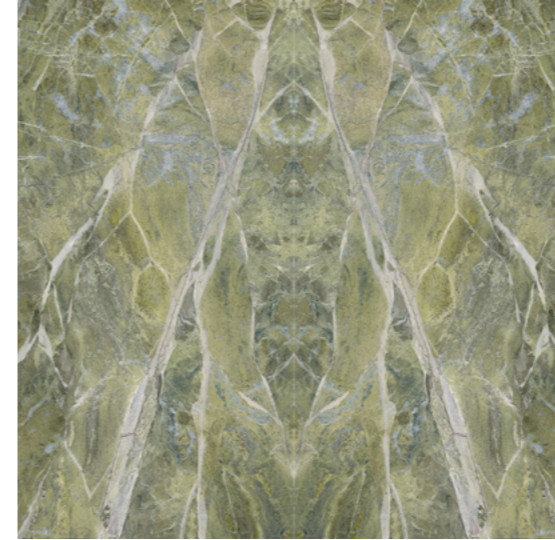

**IRISH GREEN BOOKMATCHED**  
POLISHED



**LAGUNA BLANCA BOOKMATCHED**  
POLISHED



**LUMIX BOOKMATCHED**  
POLISHED | NATURAL

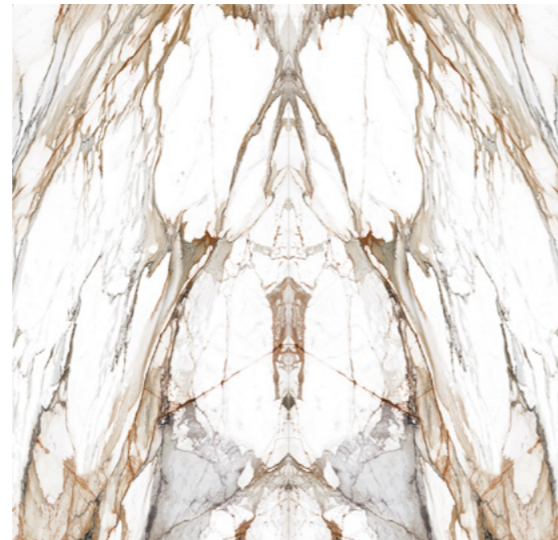

**MACCHIA VECCHIA BOOKMATCHED**  
POLISHED | HONED  
\*ALSO AVAILABLE IN 6 mm SLAB



**MOON GREY BOOKMATCHED**  
POLISHED | NATURAL

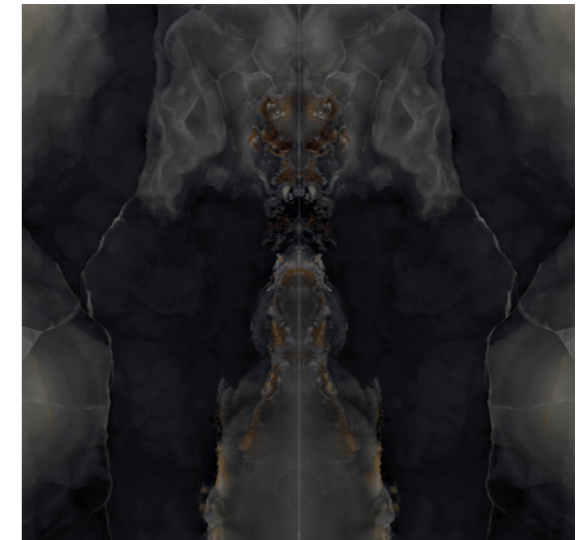

**JET BOOKMATCHED**  
POLISHED  
\*ALSO AVAILABLE IN 6 mm SLAB



# BOOKMATCHED COLOURS

All items 12 mm unless specified



**KLIMT BOOKMATCHED**  
POLISHED  
\*ALSO AVAILABLE IN 6 mm SLAB

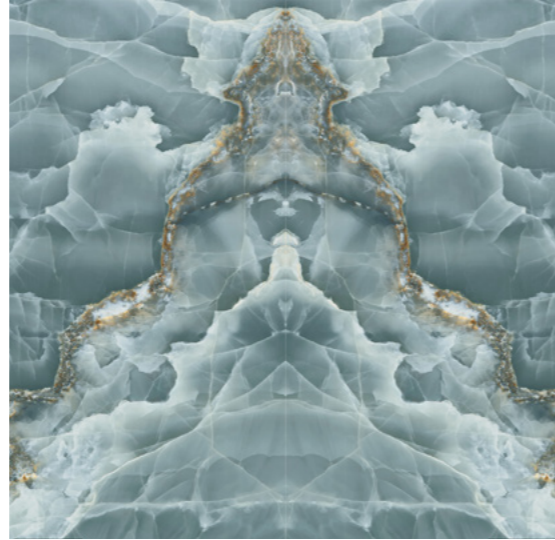

**CYAN BOOKMATCHED**  
POLISHED  
\*ALSO AVAILABLE IN 6 mm SLAB



**BRIGHT BOOKMATCHED**  
POLISHED  
\*ALSO AVAILABLE IN 6 mm SLAB

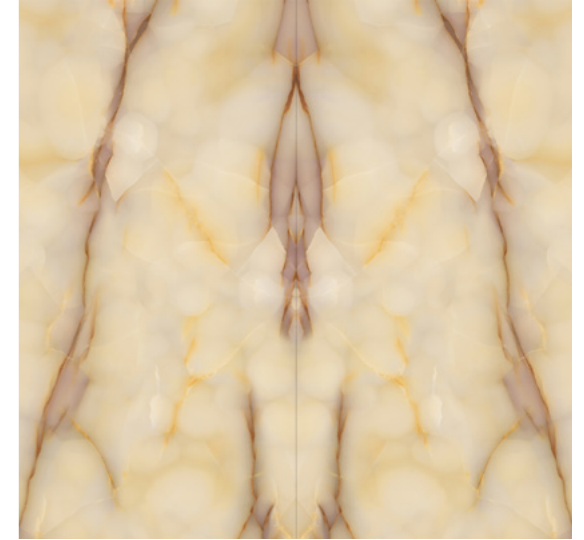

**DOLCE BOOKMATCHED**  
POLISHED | HONED

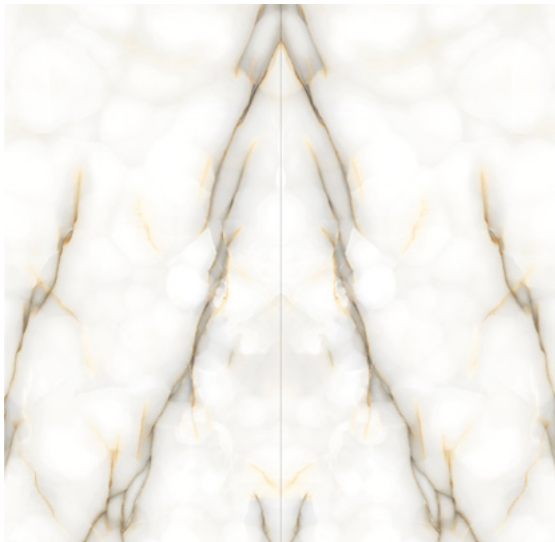

**PURO BOOKMATCHED**  
POLISHED | HONED  
\*ALSO AVAILABLE IN 6 mm SLAB



**PANDA BOOKMATCHED**  
POLISHED | HONED

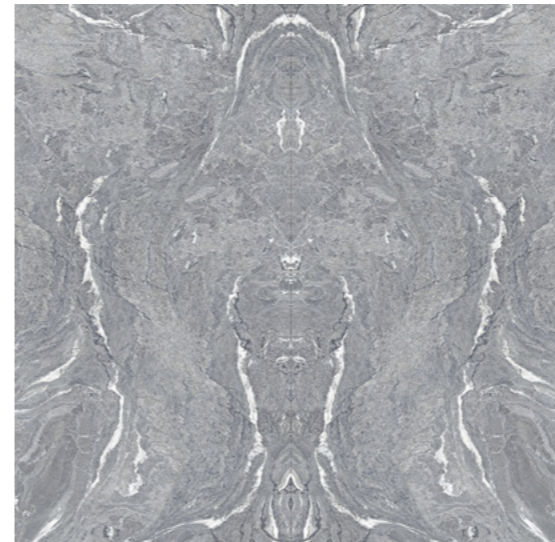

**PIETRA DI VALS BOOKMATCHED**  
STRUCTURED



**PORTLAND BOOKMATCHED**  
NATURAL



# BOOKMATCHED COLOURS

All items 12 mm unless specified

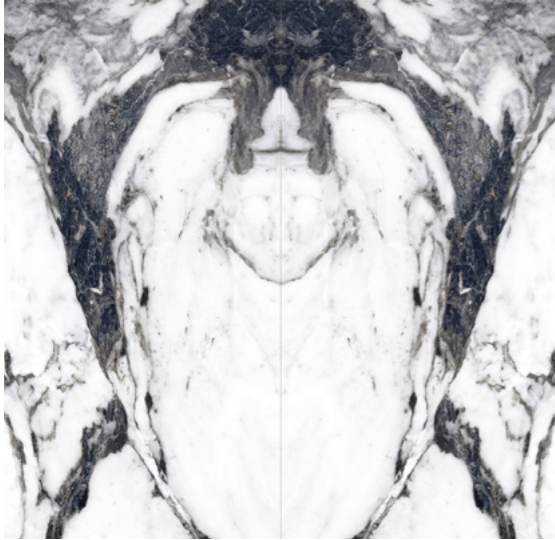

WHITE SIENA BOOKMATCHED  
POLISHED

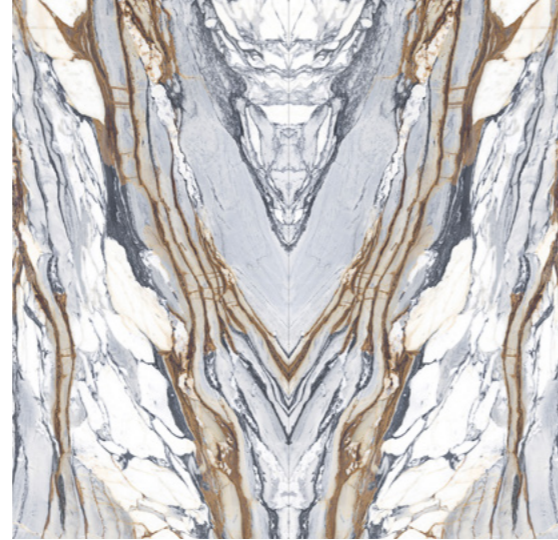

CALACATTA PICASSO BOOKMATCHED  
POLISHED | NATURAL

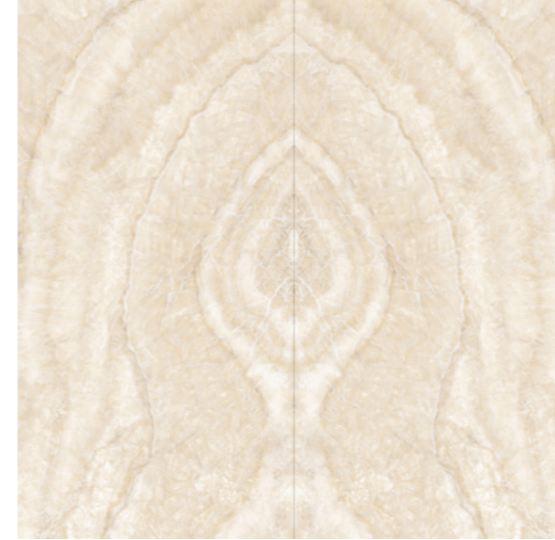

IVORY GIOIELLO BOOKMATCHED  
POLISHED



GOLDEN AMBRA BOOKMATCHED  
POLISHED



SUPER WHITE BOOKMATCHED  
POLISHED | NATURAL



LABRADORITE BOOKMATCHED  
POLISHED | HONED

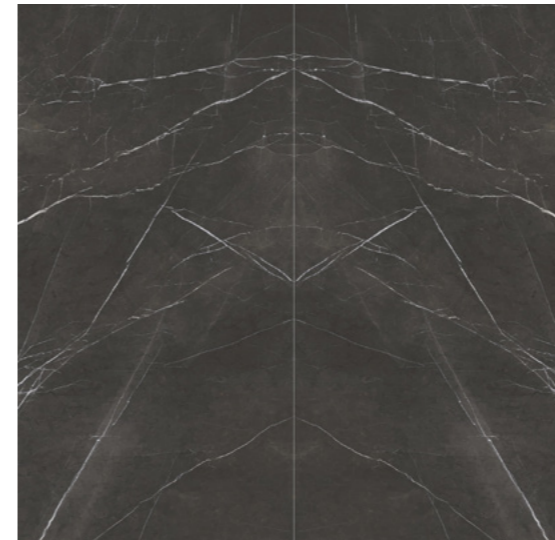

IMPERIAL BLACK SELECT BOOKMATCHED  
POLISHED | NATURAL

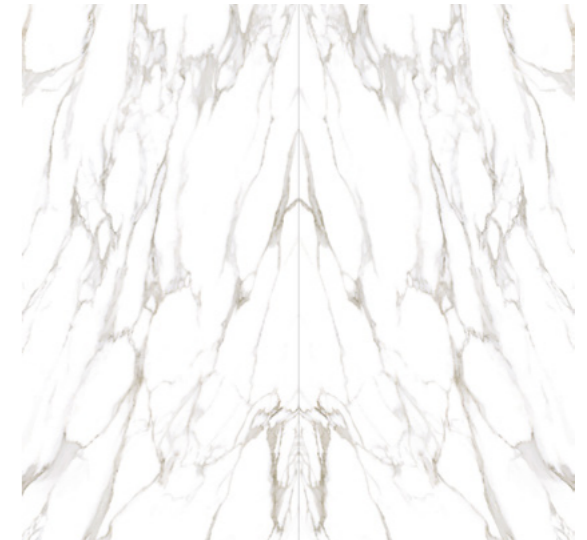

STATUARIO REALE BOOKMATCHED  
POLISHED | NATURAL



# BOOKMATCHED COLOURS

All items 12 mm unless specified



**LEVEL CALACATTA BOOKMATCHED\***  
POLISHED | NATURAL  
\*ALSO AVAILABLE IN 6 MM

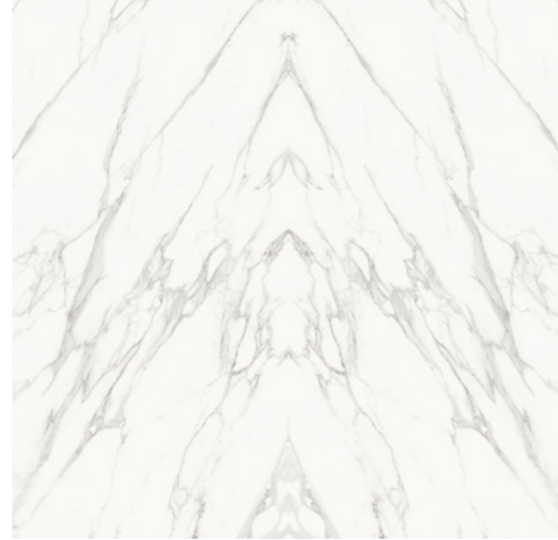

**STATUARIO MICHELANGELO BOOKMATCHED**  
POLISHED | NATURAL  
\*ALSO AVAILABLE IN 6 mm SLAB



**QUARZO BOOKMATCHED**  
POLISHED | NATURAL



**WHITE PARADISE BOOKMATCHED**  
POLISHED





# BOOKMATCHED COLOURS

All items 12 mm unless specified



**CALACATTA GOLD BOOKMATCHED**  
POLISHED | NATURAL  
\*ONLY AVAILABLE IN 6 MM

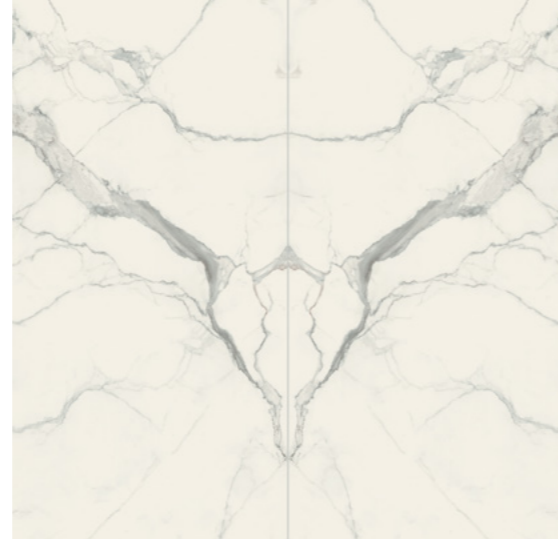

**STATUARIO BOOKMATCHED**  
NATURAL  
\*ONLY AVAILABLE IN 6 MM



**LUX GREEN BOOKMATCHED**  
POLISHED | NATURAL



**BLUEDEEP BOOKMATCHED**  
POLISHED | NATURAL



**CALDIA BOOKMATCHED**  
POLISHED | HONED

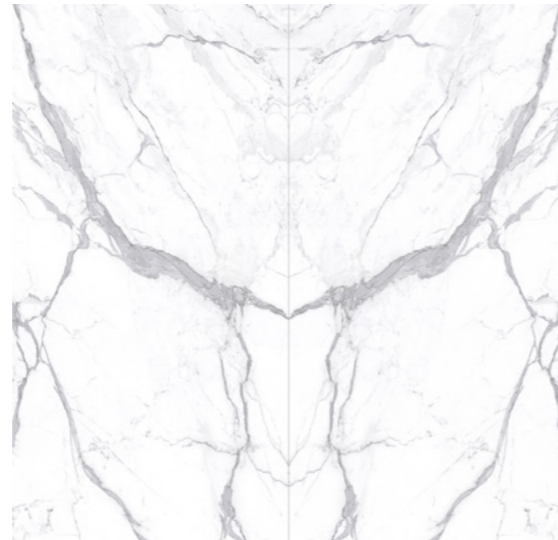

**STATUARIO EXTRA BOOKMATCHED**  
POLISHED | SILK



**CALACATTA CANOVA BOOKMATCHED**  
POLISHED



**MARBLE CALACATTA BOOKMATCHED**  
POLISHED | NATURAL



# BOOKMATCHED COLOURS

All items 12 mm unless specified



**MARBLE CALACATTA GOLD BOOKMATCHED**  
POLISHED | NATURAL  
\*ALSO AVAILABLE IN 20 MM

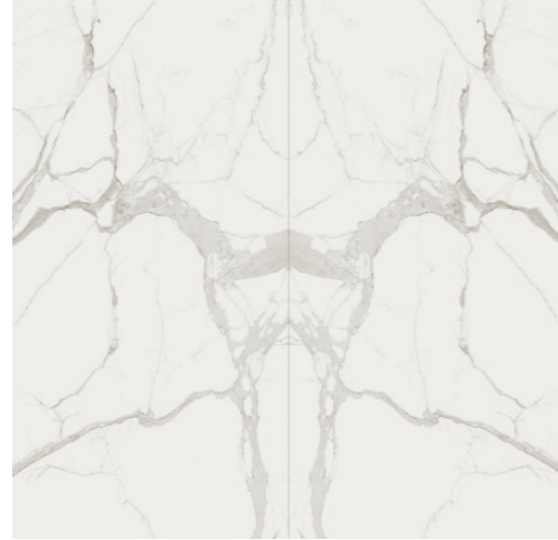

**MARBLE STATUARIO BOOKMATCHED**  
POLISHED | NATURAL  
\*ALSO AVAILABLE IN 20 MM



**QUARZITE TAJ MAHAL BOOKMATCHED**  
POLISHED | NATURAL | SILK



**PATAGONIA VITRUM BOOKMATCHED**  
POLISHED | NATURAL  
6 MM

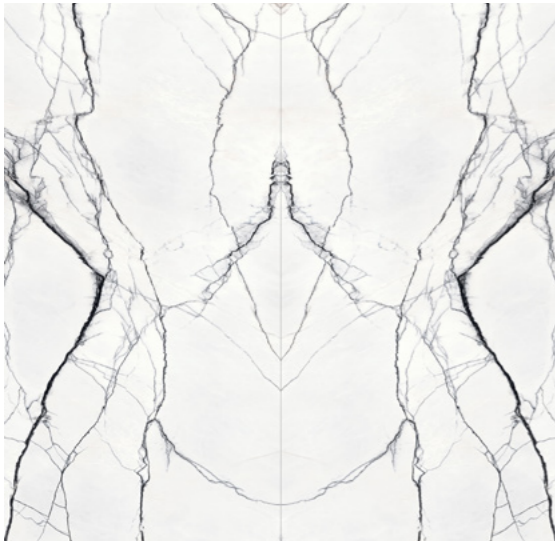

**MARBLE BREACH WHITE BOOKMATCHED**  
POLISHED | NATURAL



**CALACATTA DORATO BOOKMATCHED**  
POLISHED



**ETERNAL WHITE BOOKMATCHED**  
POLISHED

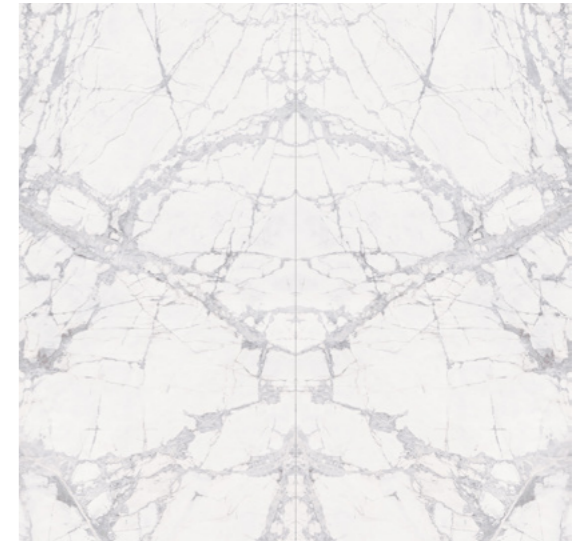

**MARBLE WHITE BOOKMATCHED**  
POLISHED



## SUSTAINABILITY

All porcelain surfaces are manufactured using sustainable processes that minimise environmental impacts, conserving energy & natural resources. Produced without the use of any harmful or radioactive materials, no hazardous emissions are emitted and they will not affect air quality. All waste material that is associated with the supply of the tile surface

is fully recyclable and all packing material is produced with recycled material. This means that all surfaces have a reduced environmental impact throughout their lifespan. With no toxic or polluting substances used in their composition and production they meet the highest standards of quality and environmental regulations, conforming to the following certifications:



BREEAM®



P O R C E L A I N T I L E S

## CONTACT

020 3141 3337

[enquiry@porcelaintiles.co.uk](mailto:enquiry@porcelaintiles.co.uk)

### **North London Showroom**

23 Temple Fortune Parade  
Finchley Road  
London  
NW11 0QS

### **South London Showroom**

88 High Street Wimbledon  
London  
SW19 5EG





The information printed in this brochure is as accurate as possible at the time of printing, but should not be considered as legally binding. The company reserves the right to modify, change, or cancel the content of this brochure without prior notice. The technical details mentioned cancel and replace the ones reported previously and where dimensions or sizes are specified, they shall be deemed to be nominal. The images, colours and finishes featured are for illustrative purposes only and may feature products that are not currently available. Quoted prices correct at time of printing. All rights reserved. V.24.302