

Highway Accident Report - Multiple-Vehicle
Collision and Fire, U.S. Route 101, Los Angeles,
California, March 3, 1980

(U.S.) National Transportation Safety Board
Washington, DC

9 Sep 80

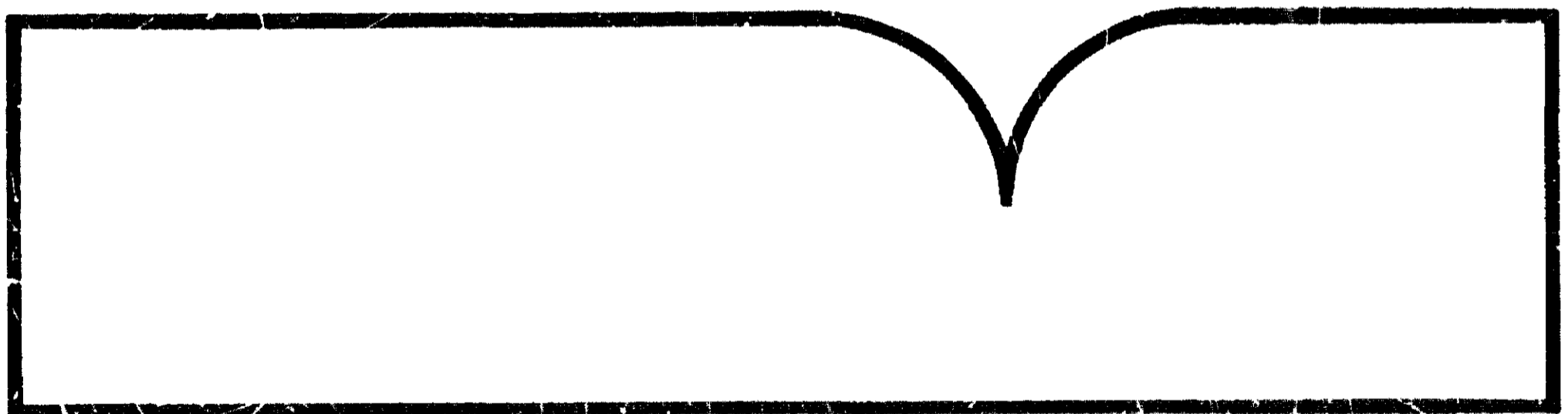

U.S. Department of Commerce
National Technical Information Service

NTIS.

TECHNICAL REPORT DOCUMENTATION PAGE

1. Report No. NTSB-IIAR-80-5	2. Government Accession No.	3. Recipient's Catalog No. PB81 104762	
4. Title and Subtitle Highway Accident Report--Multiple Vehicle Collision and Fire, U.S. Route 101, Los Angeles, California, March 3, 1980		5. Report Date September 9, 1980	
		6. Performing Organization Code	
7. Author(s)		8. Performing Organization Report No.	
9. Performing Organization Name and Address National Transportation Safety Board Bureau of Accident Investigation Washington, D.C. 20594		10. Work Unit No. 3048	
		11. Contract or Grant No.	
12. Sponsoring Agency Name and Address NATIONAL TRANSPORTATION SAFETY BOARD Washington, D. C. 20594		13. Type of Report and Period Covered Highway Accident Report March 3, 1980	
		14. Sponsoring Agency Code	
15. Supplementary Notes			
<p>16. Abstract</p> <p>On March 3, 1980, at 9:05 p.m., Pacific standard time, a sedan had just entered U.S. Route 101, (the Ventura Freeway) westbound from the Laurel Canyon on-ramp. It was traveling in the far right lane of the four-lane roadway, changed lanes to the left, and hit the right front of a gasoline cargo tank truck pulling a gasoline cargo tank trailer westbound in the No. 3 traffic lane. Both vehicles moved left and the tank truck sideswiped a westbound pickup truck in the No. 2 lane. The tank truck forced the pickup left into the median barrier. The tank trailer rolled over the median barrier, was ruptured, and its contents spilled and ignited. The pickup truck and the tank truck, with tank trailer, were destroyed in the fire. Of the seven occupants in the pickup, five died of thermal injuries and the other two were burned severely. The drivers of the sedan and tank truck received minor injuries.</p> <p>The National Transportation Safety Board determines that the probable cause of this accident was the improper lane change by the driver of the sedan which hit the tank truck and caused it to move to the left and strike the pickup truck forcing it into the median barrier. The fatalities and injuries were caused by the fire which ensued immediately when gasoline was released from the ruptured tank trailer.</p>			
17. Key Words Tank truck, tank trailer, median barrier, pickup truck, fire, gasoline, tank rupture, lane change, emergency response, glare screen, barrier penetration, hazardous materials, rear-view visibility, vapor vents, emergency communications system		18. Distribution Statement This document is available to the public through the National Technical Information Service, Springfield, Virginia 22161	
19. Security Classification (of this report) UNCLASSIFIED	20. Security Classification (of this page) UNCLASSIFIED	21. No. of Pages 30	22. Price

CONTENTS

SYNOPSIS	1
INVESTIGATION	1
The Accident	1
Injuries to Persons	4
Vehicle Information	4
Driver Information	7
Highway Information	11
Physical Evidence	13
Hazardous Materials Information	13
Emergency Response Sequence	17
Medical and Pathological Information	19
Rescue Operations	20
ANALYSIS	21
Vehicle Dynamics	21
Highway Design	21
Hazardous Materials and Emergency Response	22
CONCLUSIONS	24
Findings	24
Probable Cause	25
RECOMMENDATIONS	25
APPENDIXES	27
Appendix A--Investigation	27
Appendix B--Product Loading Data	28

THE NATIONAL TRANSPORTATION SAFETY BOARD
WASHINGTON, D.C. 20594

HIGHWAY ACCIDENT REPORT

Adopted: September 9, 1980

MULTIPLE-VEHICLE COLLISION AND FIRE
U.S. ROUTE 101,
LOS ANGELES, CALIFORNIA
MARCH 3, 1980

SYNOPSIS

On March 3, 1980, at 9:05 p.m., Pacific standard time, a sedan entered U.S. Route 101, (the Ventura Freeway) westbound from the Laurel Canyon on-ramp. It was traveling in the far right lane of the four-lane roadway, changed lanes to the left, and collided with the right front of a gasoline cargo tank truck pulling a gasoline cargo tank trailer westbound in the adjoining No. 3 traffic lane. Both vehicles moved left and the tank truck sideswiped a westbound pickup truck in the No. 2 lane. The tank truck forced the pickup left into the median barrier. The tank trailer rolled over the median barrier, was ruptured, and its contents spilled and ignited. The pickup truck and the tank truck, with tank trailer, were destroyed in the fire. Of the seven occupants in the pickup, five died of thermal injuries and the other two were burned severely. The drivers of the sedan and tank truck received minor injuries.

The National Transportation Safety Board determines that the probable cause of this accident was the improper lane change by the driver of the sedan which hit the tank truck and caused it to move to the left and strike the pickup truck forcing it into the median barrier. The fatalities and injuries were caused by the fire which ensued immediately when gasoline was released from the ruptured tank trailer.

INVESTIGATION

The Accident

On March 3, 1980, at 9:05 p.m., ^{1/} a sedan merged from the Laurel Canyon Road on-ramp to the westbound Ventura Freeway. It was traveling about 45 mph in the far right (No. 4) lane of the four-lane roadway. (See figure 1.) It moved left to the No. 3 lane to pass a vehicle ahead and in doing so, hit the right front of a westbound cargo tank truck pulling a gasoline cargo tank trailer in the No. 3 lane.

^{1/} All times herein are Pacific standard time.

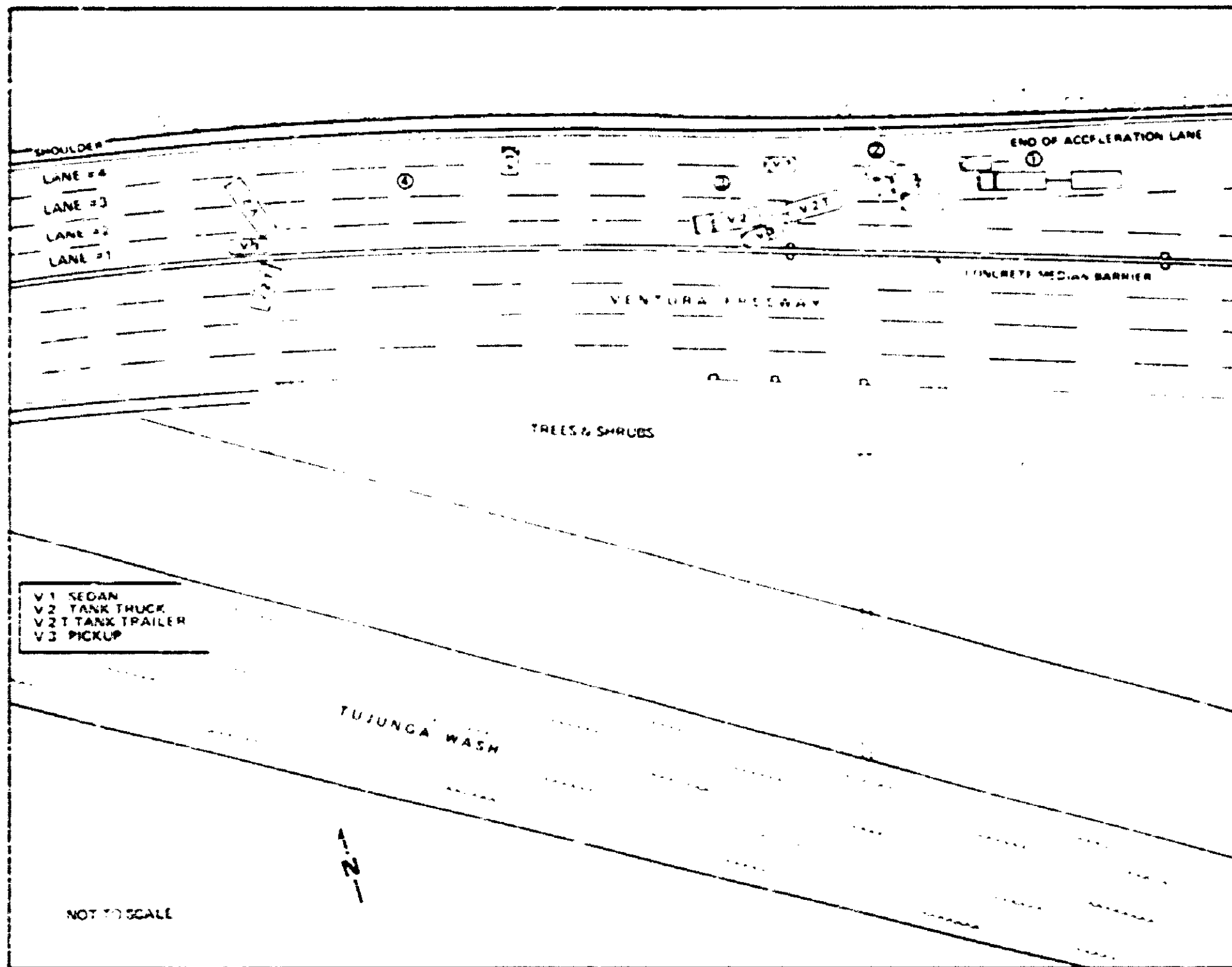

Figure 1.--Sequence of events.

The sedan driver and a witness in a car behind her stated that she used her left turn signal. The driver stated that she looked to the left but did not see the tank truck and was not aware of its presence until the vehicles made contact. The tank truck was traveling about 55 mph. The tank truck driver acknowledged that he saw the sedan's turn signal, but stated that the lane change followed so quickly there was no opportunity for him to avoid the impact.

The sedan and the tank truck both moved to the left after the left side of the sedan collided with the right front of the tank truck. The hub of the truck's right front wheel tore into the sedan body from a point behind the left rear wheel forward to a point just forward of the rear of the left door. Black rubber tire transfer marks were visible along the left side continuing forward of the gouged metal area.

The sedan and the tank truck moved to the left into lane No. 2 where the tank truck sideswiped the right side of a pickup truck with a small camper shell installed in the truck bed. The pickup was also traveling about 55 mph.

As the three vehicles moved to the left across lane No. 1, the sedan separated from the tank truck, spun clockwise 100°, and came to rest straddling the lane-dividing line between lanes No. 3 and No. 4.

The tank truck and pickup continued to the left onto the shoulder, and the left side of the pickup scraped against the 32-inch-high concrete, New Jersey-type median barrier. The pickup was squeezed between the barrier and the tank truck for a short distance until the tank truck started to rotate clockwise away from the pickup. The tank trailer behind the tank truck continued to the left toward the barrier. The left side of the tank trailer hit the barrier, and the tank, which was higher than the barrier, rolled to the left and over the barrier. The tow bar between the truck and the trailer did not separate. The trailer rolled onto its upper left side with the rear falling to the eastbound side of the barrier and the forward portion scraping along the top of the barrier. The top of the concrete barrier supported a 24-inch-high metal glare shield, held in place by vertical angle iron posts bolted into the concrete at 12-ft intervals. The cargo tank displaced the glare shields and iron posts for 165 ft as it scraped along the top of the median barrier. This friction provided both a source of tank penetration and a source of sparks for ignition of the gasoline flowing from the ruptured tank, down both sides of the median barrier, and onto the pickup truck. Witnesses stated that the gasoline ignited immediately after the tank started scraping along the top of the barrier. Burning fuel was thrown onto a fourth vehicle, an eastbound 1973 Volkswagen, that was destroyed by the fire. The driver, the only occupant, was not injured.

As the vehicles came to rest, the pickup was parallel to and against the median barrier facing west; the tank truck was at right angles to the freeway with the rear of the overturned trailer in the eastbound travel lanes No. 1 and No. 2 and the front of the trailer on top of the median barrier. The tow bar between the tank truck and trailer was across the back of the pickup truck near the tailgate, and the tank truck had rolled to the left onto its top straddling westbound lanes No. 1, No. 2, and No. 3.

The sedan driver exited her vehicle as soon as it came to rest. The truck driver escaped from the tank truck after it overturned.

The rear of the pickup was enveloped in flames and the inside of the cab was burned out, the rear window of the cab having broken during the collision which permitted gasoline to flow into the interior. One occupant of the camper, his hair and clothing aflame, escaped from the rear of the camper. He suffered severe burns and died on March 31. After kicking out the windshield of the pickup, two occupants climbed out across the hood, their clothes and hair aflame. Four occupants of the pickup were unable to escape and died. When the rear bulkhead of the tank truck ruptured, additional gasoline and flames were thrown over the area and a fireball rose skyward.

The weather was clear and dry. It was dark, but the area was illuminated by overhead artificial light. The temperature was 57° and winds were from 210° at 3 knots.

Injuries to Persons

<u>Injuries</u>	<u>Drivers</u>			<u>Passengers</u>			<u>Total</u>
	Sedan	Truck	Pickup	Sedan	Truck	Pickup	
Fatal	0	0	0	0	0	5	5
Nonfatal	1	1	1	0	0	1	4
None	0	0	0	0	0	0	0

Vehicle Information

The sedan was a 1978 Toyota Celica GT Liftback, VIN RA42018916, owned by a friend of the driver and was used regularly by her. It was equipped with a 133.6-cubic-inch, 4-cylinder gasoline engine, a 5-speed transmission, power front disc and rear drum brakes, power steering, and air conditioning. The speedometer showed 23,451 miles. It was equipped with belt restraints in the front and rear. It weighed 2,750 pounds.

The left door and quarter panel had been penetrated along a line 16 to 22 inches above the ground from the rear to a point forward of the rear of the left door. Circumferential tire marks also extended over this area for about 50 inches. A 6-inch circular dent, forward of the rear of the door, had compressed the door panel inward 3 inches. The left window was broken and missing. (See figures 2.) All plastic and paint areas at the rear were scorched or melted by the fire. The brakes were found to be operational, and the tires were in good condition and properly inflated. The right front tire head was reported to have been displaced near a rim abrasion and deflated, but when it was remounted it was found to retain air. The undercarriage, suspension, and steering were not damaged.

The tank truck, a 1978 White Freightliner three-axle tank truck, VIN CA 513-HL140588, was owned by Gasco Gasoline, Inc., of Fresno, California, and operated by the Thompson Petroleum Tank Lines, Inc, of Oxnard, California. It was equipped with a 350-cubic-inch, 6-cylinder, Cummings diesel engine and Fuller Ranger 13-speed RTO 9513 transmission. It had a gross vehicle weight rating of

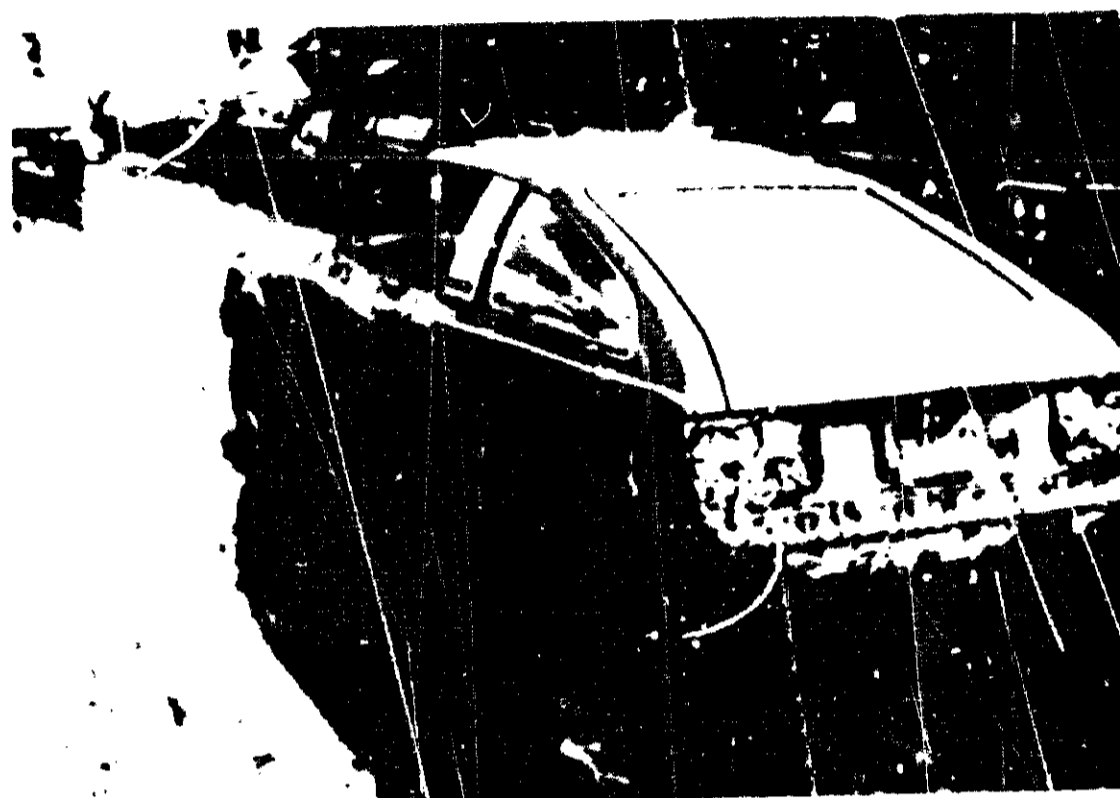

Figure 2.--Left side and rear damage to the sedan.

44,000 pounds and was equipped with drum-type air brakes and a Federal Motor Vehicle Safety Standard (FMVSS) 121 skid control system. The owner stated that he "assumed" the 121 brake system was operational since no one had ever ordered it removed. The odometer had been destroyed by fire. The aluminum tank capacity was 4,800 gallons. The Clough cargo tank trailer, VIN C-1396, was also owned by Gaseo Gasoline, Inc., and operated by Thompson Petroleum Company. It was also equipped with drum-type air brakes and an FMVSS 121 system. The aluminum tank capacity was 5,400 gallons. The two vehicles were loaded with about 9,000 gallons of gasoline, with an approximate gross weight of 79,441 pounds. (See appendix B.) The tank truck and trailer were built and certified to meet the U.S. Department of Transportation Standard No. 306.

About 80 percent of the tank truck was destroyed by fire. (See figures 3 and 4.) All of the drive train components separated from the body and chassis. The majority of the suspension components were intact, but the circular hub of the right front wheel was fractured. The transmission drive shafts and axles were separated and sustained fire damage. The tires were burned and some wheels partially melted.

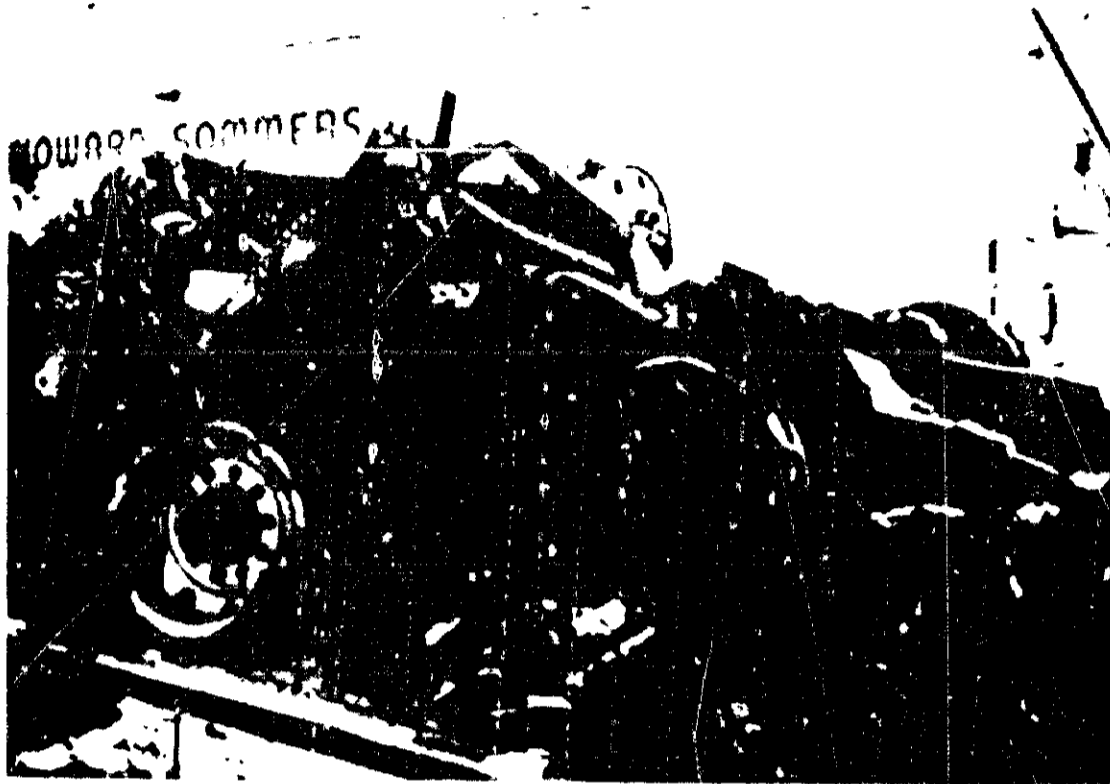

Figure 3.--Remains of
tank truck.

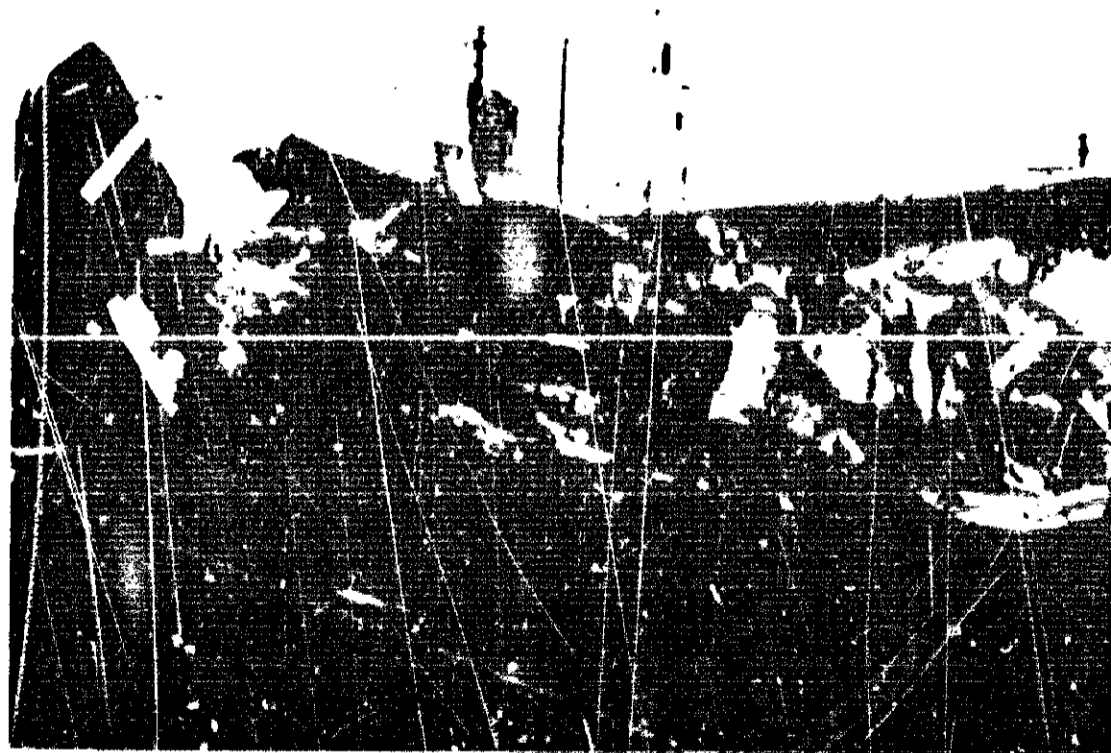

Figure 4.--Remains of
truck tank

The cargo tank itself was melted to the fluid level, about 14 inches remaining in the tank. The manhole covers were not damaged. The discharge manifold had separated from the tank and was distorted.

The trailer had similar damage with about 65-percent of the tank melted; portions of the suspension members were damaged. (See figures 5 and 6.) The drawbar was still attached at the truck and the trailer. It was not twisted, because it was fitted with a rotating ring. The tank's rear bulkhead was intact but had heavy abrasions on the lower left portion. The trailer tank's front manhole cover dome cap and a portion of the cover plate were missing. Any hazardous material placards that may have been on the two vehicles were destroyed in the fire.

The pickup was a 1977 Dodge, VIN D27BF78180968, and was owned by the driver. It was equipped with a club cab, 360-cubic-inch gasoline V8 engine, automatic transmission, power hydraulic front disc-rear drum brakes, and power steering; it weighed about 5,125 pounds and carried a cab-height camper shell.

All flammable components on the pickup, including the camper, were consumed by fire and all soft metals were melted. The engine and drive train components only sustained fire damage. (See figure 7.)

The front right side was crushed inward 3 to 4 inches aft of the front of the door. The cab was crushed inward on the right side behind the "B" pillar and buckled vertically. The pickup bed was distorted at the rear. The left front was crushed inward and to the rear, and the left door was dented inward about 4 inches. The left rear panel of the pickup bed was buckled outward 4 inches over the wheel housing. (See figure 8.)

The eastbound 1973 Volkswagen, which was not involved in the accident but was sprayed by burning gasoline as it drove past the accident site, was completely destroyed by fire.

Driver Information

The Sedan Driver.--The sedan driver was 25 years old. She had been driving since age 16 and was familiar with the area. She traveled this route each day from home to school and was familiar with Los Angeles freeway traffic. She had frequently driven the accident vehicle.

She possessed a valid Class 3 California drivers license which will expire in 1982. Her driving record disclosed a previous accident on March 22, 1977, and two citations for exceeding the 55 mph speed limit--one on April 2, 1978, and the other on July 16, 1978.

No known unusual activities preceded her driving, and there was no indication at the scene that caused the investigating officer to request an alcohol or drug test.

She refused an interview beyond the initial on-scene interview with the California Highway Patrol (CHP) investigating officer.



Figure 5.--Remains of trailer tank.

The Tank Truck Driver.--The tank truck driver was 29 years old. He had been driving since age 16, but his truck driving experience began in 1975. He had worked for Gasco about 3 months and was familiar with the vehicle and the route traveled.

He possessed a valid Class 1 California operators license that will expire in 1983. His California driving record showed no violations and no accidents. His Arizona record during the previous 3 years reports no accidents and one citation for exceeding 55 mph (October 18, 1978). His license had no restrictions, and he was in good health at the time of the accident.

No known unusual activities preceded his work shift which began at 8 p.m., and there was no indication at the scene to cause the California Highway Patrol officers to request alcohol or drug tests.

The Pickup Driver.--The pickup driver was 32 years old. He had spent most of his life in Mexico and had been driving only about 2 years. He held a valid Class 3 California drivers license that will expire in 1982. His California driving record indicates a violation of the 55 mph limit on October 24, 1979, and no record of previous accidents. There were no known problems with alcohol, drugs, or unusual activities before the accident.

DCA-80-A-H002

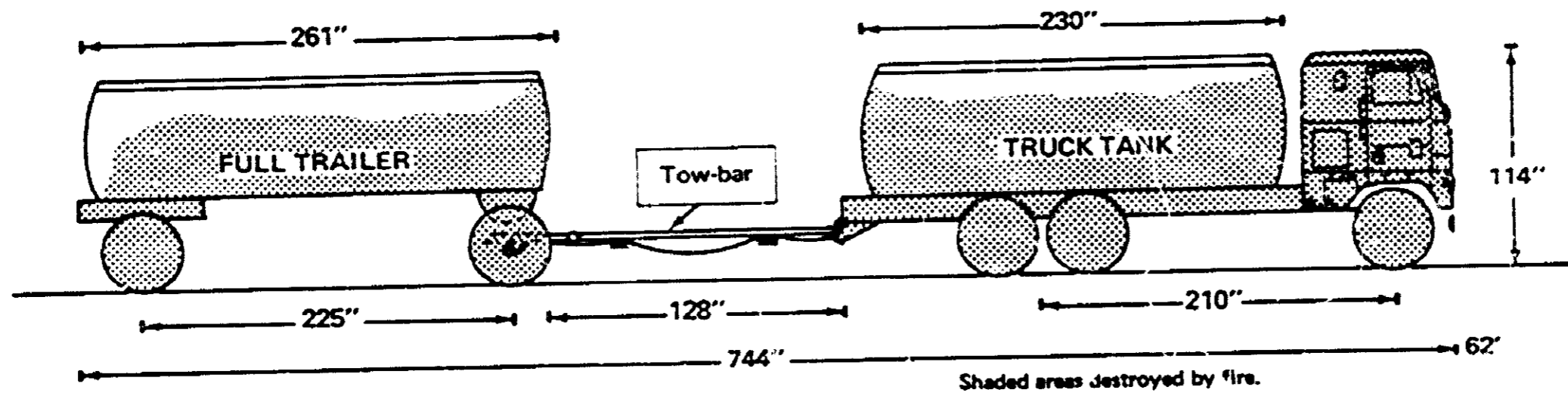

Figure 6.--Diagram of damaged areas of tank truck and tank trailer.
Lined area destroyed by fire.

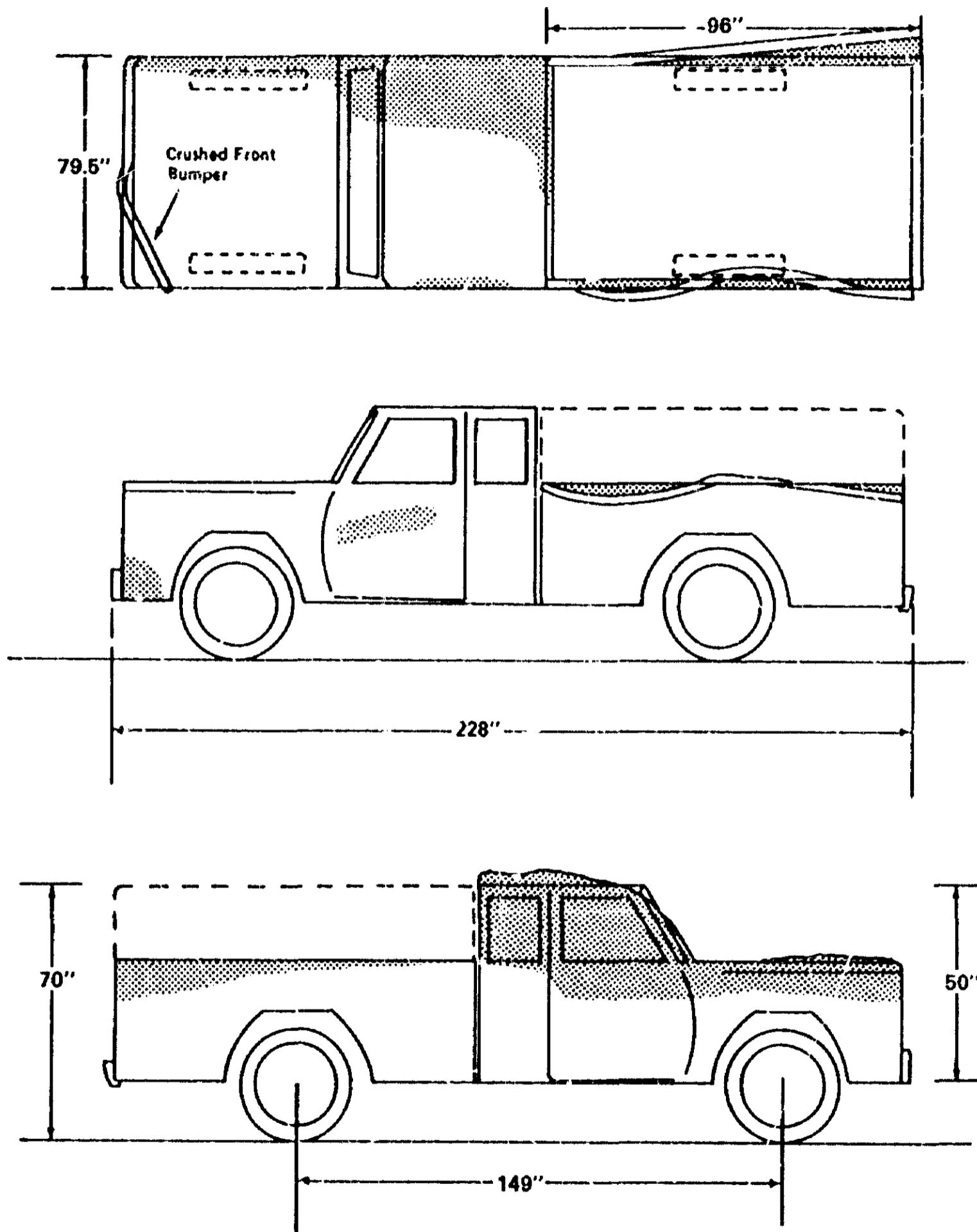

Figure 7.--Diagram of impact damage to pickup truck.

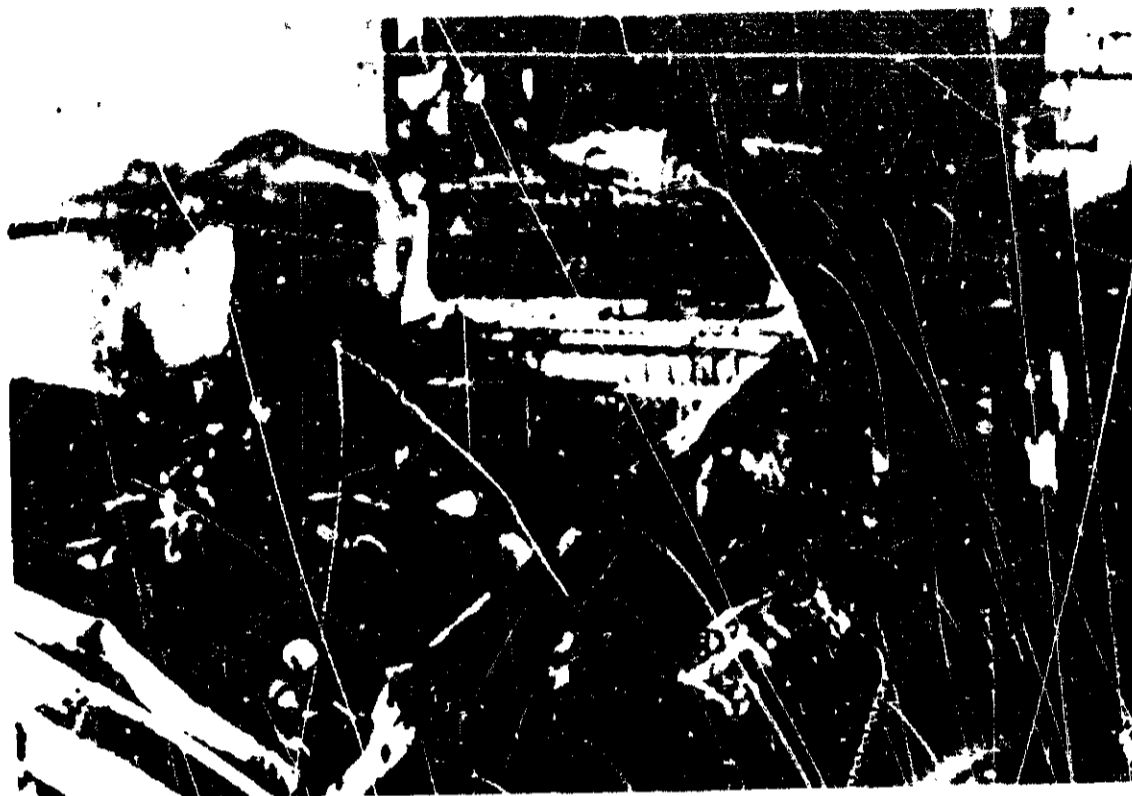

Figure 8.--Right rear of pickup showing fire and impact damage.

Highway Information

U.S. Route 101 is a Federal-aid primary highway. It has four 12-ft-wide concrete travel lanes, a 10-ft-wide flush asphalt median shoulder, and a 5-ft-wide asphalt right shoulder in each direction. A 32-inch-high concrete median barrier (New Jersey-type) with a 2-ft-high glare shield mounted on top, separates opposing traffic. The barrier is compatible with the current state-of-the-art and was designed to contain and redirect vehicles in the 4,000- to 4,500-pound category. Barrier tests have been completed with heavy vehicles, but standards have not yet been established to contain heavy trucks and buses.

Lane delineation is provided by a broken white line and ceramic buttons. A solid yellow line delineates the left pavement edge and a solid white line delineates the right pavement edge. Additional delineation is provided along the lane lines and the left edgeline by reflective markers placed every 48 ft. (See figure 9.)

A 55-mph-speed-limit sign was posted 0.8 mile east of the collision site, and a large merge symbol sign with a supplementary merge plaque below it was located on the channelizing island which separates the traveled way from the on-ramp. Four overhead mercury vapor lights illuminated the merge area and partially lighted the accident site. Signs and road markings met the standards of the Manual of Uniform Control Devices. The installed porcelain ceramic buttons and reflectors along the painted lane markers exceeded those recommendations.



Figure 9.--Aerial view of Ventura Freeway showing accident site.

The highway at the accident site is a straight section between a large radius curve to the right and a large radius curve to the left. The approach to the accident site is on a slight downgrade (-2 percent). This downgrade transitions into a slight upgrade (+2 percent) at the accident site. Superelevation was a maximum of 6 percent. Catch basins at the low point along the median diverted runoff from the westbound lanes into concrete pipes and under the pavement to the south side of the freeway into an open channel which emptied into a flood control channel. Runoff from the eastbound side ran across the pavement to the south shoulder, where it followed a gutter to a catch basin which emptied into the same pipe and open channel as the westbound runoff. The drainage system exceeded the American Association of State Highway Officials standards and led to the rapid runoff of the burning liquids spilled in this accident.

The 1978 average daily traffic (ADT) along this route was 214,000 vehicles. Trucks made up 5.1 percent of the traffic. The westbound traffic between 9 and 10 p.m. was about 3,000 vehicles. A 1979 speed study by California Department of Transportation disclosed that vehicles averaged 54 mph at this location.

The accident rate for this area is 1.30 accidents per million miles. This is less than the 1.57 expected accident rate for 8-lane urban freeways in California and about one-half of the 2.5 accident rate for the urban interstate system in the United States. The median barrier had been hit 129 times in a 5-mile segment including the accident site over a 3-year period ending December 31, 1979. None of these hits resulted in crossovers into opposite lanes. Ten percent of these hits involved trucks.

Physical Evidence

Two closely adjacent tire marks began in the No. 3 lane and continued to the left 120 ft across the No. 2 and No. 1 lanes to the edge of the burned asphalt shoulder. About 50 ft beyond the beginning of these marks and about 7 ft to the left, another set of tire marks paralleled the first set. Tire marks on the side of the barrier were found in line with these marks. Near this point, the glare shield and 2-inch angle-iron support posts were sheared off the top of the median barrier for a distance of 165 ft.

The road surface was spalled and chipped by heat all along the median in this area. The road surface on both sides of the median was heat damaged. Burn stains were found along drainage routes to the catch basins and also where underground pipes surfaced to carry fluid to the flood channel, where the gasoline was dispersed in the water. (See figures 10, 11, and 12.)

Hazardous Materials Information

Thompson Petroleum Tank Lines, Inc., operated the truck under intrastate hazardous material carrier permits CT 15885 and CT 23072. Thompson has a Class A rating for transporting hazardous materials and is restricted to transporting refined petroleum products within a 200-mile radius of Los Angeles.



Figure 10.-- Westbound fire damage area and tank trailer skid marks at right.

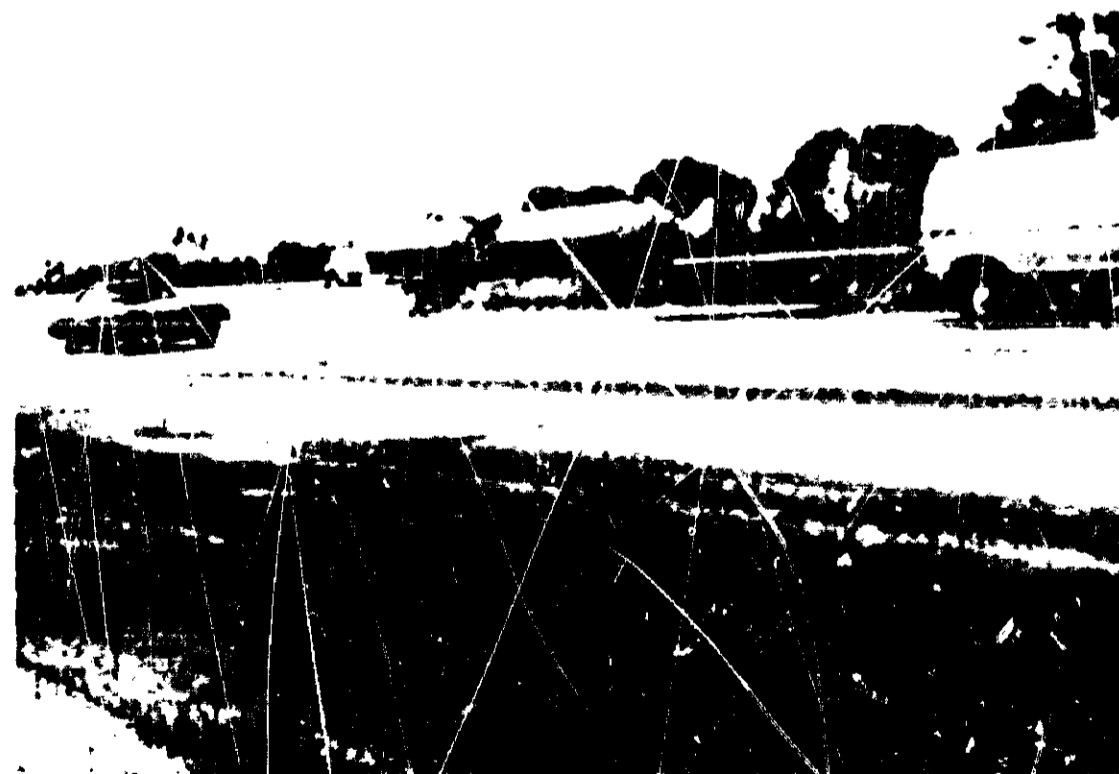

Figure 11.-- Eastbound lane in foreground; tank trailer at rest, center. Tank truck in background similar to accident vehicle. Note height in relation to median barrier.



Figure 12.--Point of rest in foreground. Westbound traffic at left.

The gasoline was loaded at an ARCO facility in Los Angeles at 8:30 p.m., for transport to Lompoc, California, 115 miles northeast of Los Angeles. Fuel carriers are required^{2/} to use the freeways as travel routes and then the most direct surface routes to their destinations that do not take them through tunnels, narrow streets, or heavily populated areas.

Regulations further require that all trucks travel in the far right lane unless there are more than three lanes; then they are permitted to travel in the lane next to the right lane.

Witnesses stated that, almost immediately after the trailer tank rolled over the median barrier, they saw fuel flowing down both sides of the barrier and onto the highway. The fuel was on fire and flowing south across both the eastbound and westbound lanes. The fuel on the westbound side flowed to the median barrier then east to catch basins. The fuel on the eastbound side flowed to a gutter at the shoulder and then eastward to catch basins. The catch basins discharged into an open concrete ditch south of the freeway that carried the burning fuel across an open area into the Tujunga Wash flood control channel. (See figure 13.)

^{2/} Rules and Regulations for Transportation of Dangerous Materials--Los Angeles. (Title 13, California Code of Regulation for Hazardous Material Transportation.)

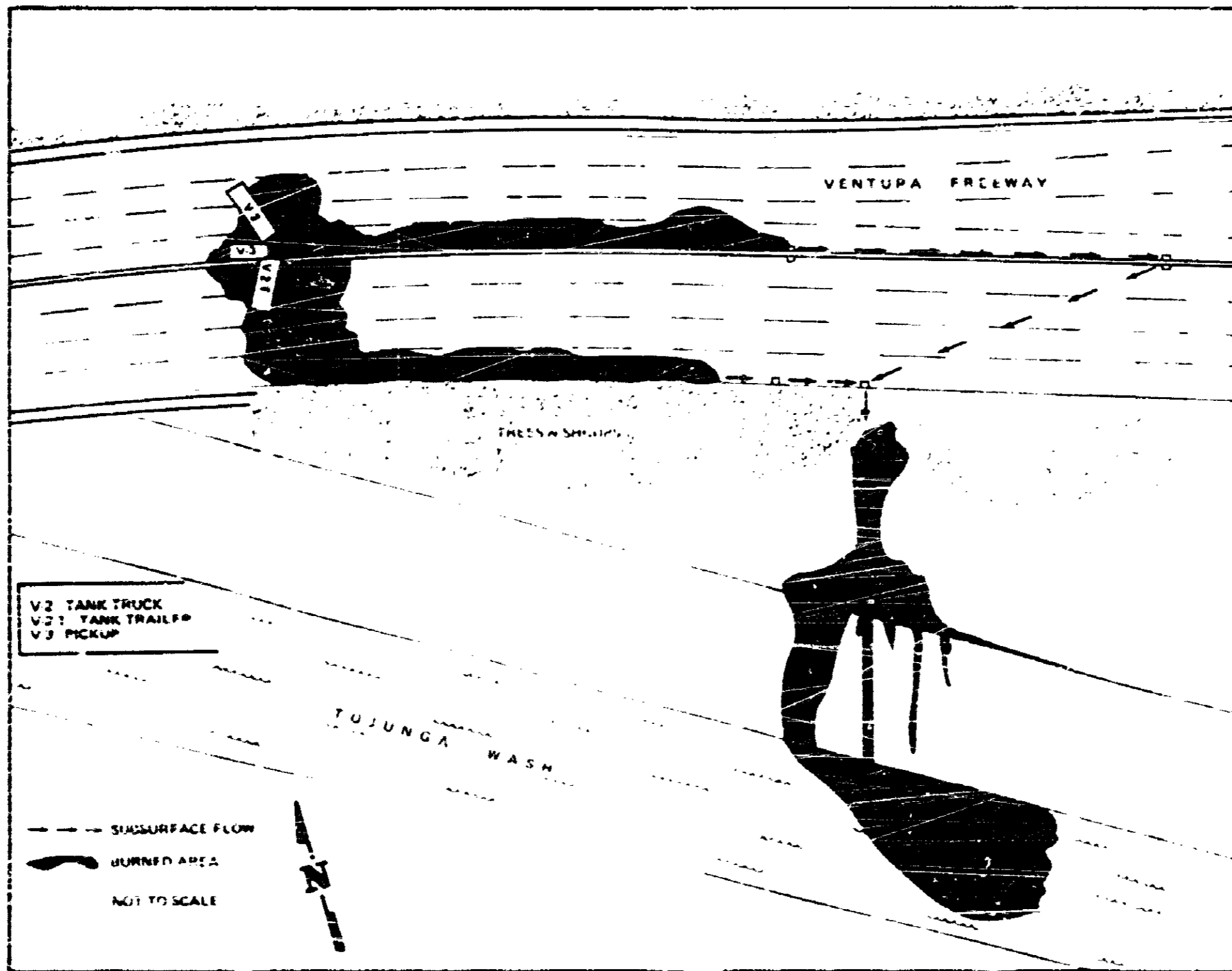

Figure 13.--Gasoline dispersal.

Emergency Response Sequence

The following is the sequence of events which took place after the truck and trailer came to rest:

- o About 30 seconds after the truck and trailer came to rest, the truckdriver crawled out of his truck cab and ran east for several hundred feet.
- o About 30 seconds after the truck and trailer came to rest, a 17-year-old male with his hair and clothes aflame was seen running through the flames at the rear of the trailer. He ran about 300 ft east along the westbound lanes where the truckdriver and a parked motorist extinguished the flames and wrapped him in a blanket.
- o About 1 minute after the truck and trailer came to rest, the rear of the pickup and the camper shell were enveloped in fire and the pickup cab was filled with smoke.
- o About 1 minute after the truck and trailer came to rest, occupants of the cab of the pickup kicked out the windshield and two adults managed to escape and ran west where bystanders extinguished the flames on their hair and clothing and led them to safety.
- o About 1 minute 30 seconds after the truck and trailer came to rest, a third adult occupant of the pickup cab was seen attempting to exit through the windshield area, but fell back into the cab. The heat was too intense for bystanders to attempt a rescue.
- o About 2 minutes after the truck and trailer came to rest, a California Highway Patrolman approaching the scene, saw the blaze and smoke, radioed his dispatcher, and reported an explosion and fire. The dispatcher notified surrounding Los Angeles fire units.
- o About 2 minutes after the truck and trailer came to rest, Los Angeles Fire Units 78, 86, and 60 were dispatched to the scene.
- o Between 2 and 3 minutes after the truck and trailer came to rest, the pickup truck and tank trailer were completely engulfed in flames. Because of the extreme heat, rescuers could not approach the vehicles.
- o About 3 minutes after the truck and trailer came to rest, the rear head of the truck tank ruptured, spewing gasoline over the area and causing a large fireball to rise into the air. The flames mushroomed around the vehicles.

- o About 3 minutes after the truck and trailer came to rest, Fire Unit No. 78 approached the scene and saw a "200-ft fireball" over the Ventura Freeway and flaming liquid flowing 100 to 200 ft east toward the Tujunga Wash Basin. Fire Unit No. 78 was delayed at the entrance to the on-ramp by standing traffic which was quickly cleared away by California Highway Patrol officers.
- o About 5 minutes after the truck and trailer came to rest, the first California Highway Patrol officer arrived on scene. He parked on the shoulder just west of the accident vehicles. The normal procedure was for this officer to be in charge. He was to attach a pennant to his radio antenna, establish a command post, and direct the activities of the various emergency units. Although he did not attach a pennant to his radio antenna, he directed the activities of the arriving highway patrol units as they directed traffic around the emergency scene and moved vehicles away from the immediate proximity of the fire to permit the unimpeded approach of the firefighting units. Most of the firefighting units arrived at the scene on the east side of the fire. At this time the California Highway Patrol officer had been unable to locate and contact the driver of the tank truck to obtain information about the nature and quantity of the product involved. Shortly thereafter, other highway patrol units arrived on both sides of the accident vehicles. Traffic flow was rerouted off the freeway and stopped vehicles were moved from the vicinity of the accident to open access for arriving fire units.
- o About 7 minutes after the truck and trailer came to rest, a fire rescue unit arrived on scene. It stopped east of the accident vehicles and began to attend to burn victims.
- o About 10 minutes after the truck and trailer came to rest, Fire Unit No. 78 arrived on scene and parked east of the accident vehicles. The fire was burning across all east and westbound lanes, blocking the fire units from proceeding farther. This blockage prevented the firefighting officer from contacting the patrol officer in charge, and the two agencies did not have common on-scene radio frequencies. Delayed communication through dispatchers was available but was not used to exchange information. The highway patrol officer did not have much useful information at this time, but conversation may have generated further search for the driver, who could have provided information concerning the type and quantity of burning product. Firefighters, therefore, would not have had to rely on the appearance and odor of the product in order to determine how to deal with the emergency.
- o About 11 minutes after the truck and trailer came to rest, the fire officer in charge of Unit 78 requested fire dispatchers to change the designation to a three-alarm, which would ultimately involve 16 fire companies and more than 50 firefighters.

- o About 12 minutes after the truck and trailer came to rest, a fire unit applied water to the fire.
- o About 50 minutes after the truck and trailer came to rest, Fire Unit 86 began applying foam to the flaming gasoline.
- o About 55 minutes after the truck and trailer came to rest, the fire was extinguished (about 10 p.m.). Fire Unit 78 remained on scene until 4 a.m. March 4, and at 8 a.m. March 4, the freeway was reopened to traffic.

After assisting in the rescue of the 17-year-old male who escaped from the camper shell on the pickup, the truckdriver contacted a highway patrol officer who was directing traffic. He identified himself, his company, and the product he was transporting. He was directed to the fireman in charge. Later, as the fire subsided somewhat, he made his way to a fire unit, identified himself, and gave a fireman the information concerning the product involved in the fire and the name of his employer. By this time, however, the fire was being brought under control and the information was no longer critical.

Because of delays in reaching the fire, the officer in charge of Fire Unit No. 78 decided he had to attack the fire immediately on arrival, based on his observations of the fire situation. He did not ask highway patrol personnel about events which preceded his arrival. Thus, he had no immediate knowledge of earlier rescue efforts, the exact nature or quantity of the hazardous material involved, the number of vehicle occupants still in the fire, or the whereabouts of the truckdriver.

As additional fire units arrived at the scene, they took positions in the vicinity of the Fire Command Post.

Medical and Pathological Information

The driver of the sedan suffered a cut to her left hand when the window glass on the driver's side was broken. She was transported from the scene by private vehicle and obtained her own medical aid.

The driver of the tank truck complained of pain in his right leg. He remained at the scene until the fire was extinguished and was then transported to Sherman Oaks Hospital by a highway patrol unit. He was examined and released. Examination revealed "... traumatic insult to the cervical and lumbar areas, associated spasm and radicular pain. ... experiencing dizziness and headaches, further evaluation is indicated. No fracture or bone pathology." The driver was off work for 5 days following the accident and continuing back problems resulted in additional periodic work loss into the latter part of May 1980.

The driver of the pickup sustained burn injuries to his hands, arms, chest, and face areas. He was transported to Sherman Oaks Hospital by ambulance and was admitted to the hospital in stable condition. He was released from the hospital on March 31, 1980. Another occupant of the pickup cab, who exited through the

windshield area, suffered burns on her hands, arms, face, chest, and back areas. She was transported to Sherman Oaks Hospital by ambulance and was admitted to the hospital in critical condition. She was released on April 8, 1980.

The person who was riding alone in the camper on the back of the pickup sustained third-degree burns over most of his body. He was transported to Sherman Oaks Hospital and was admitted in critical condition; he died on March 31, 1980.

The four persons who did not escape from the pickup were almost entirely consumed by fire. It was not possible to determine if they had suffered other trauma. The coroner's report listed the cause of death of all four victims as "extensive thermal burns."

The driver, the only occupant of the 1973 Volkswagen, escaped from his vehicle uninjured by the fire.

Rescue Operations

The driver of the sedan exited from her car without assistance.

The driver of the tank truck was tumbled within the cab of his truck as it rolled onto its top, but he escaped through the driver's window without assistance and moved away from the immediate vicinity of the fire. He was able to assist in extinguishing the fire which was consuming the clothing of the victim who had fled from the rear of the camper shell. This occupant escaped from the camper shell without assistance and ran through the burning gasoline with his hair and clothes aflame. Others at the scene assisted in smothering the flames and in removing his burning and melting clothing before medical assistance arrived at the scene. He would not have escaped had he not been able to act on his own. The camper shell was completely engulfed in flames and no one knew it was occupied. Puddled burning gasoline around the rear of the camper discouraged anyone approaching the vehicle and the immediate outbreak of flame did not allow time for exploration and rescue activities.

The other six occupants were in the cab of the pickup. Outside observers could only see smoke inside the pickup before the occupants forced the windshield outward over the hood. Two passersby then started toward the pickup to aid the occupants, but did not get close enough to the cab to assist until the occupants climbed across the hood and to the highway. The passersby assisted the victims by smothering the fire on their clothing and in their hair and leading them away from the fire. The passersby could not get close enough to the cab to help a third occupant as she attempted to climb out of the pickup cab; she was overcome and fell back inside. One occupant was an infant incapable of helping itself, and the other two adults were apparently overcome before the windshield was removed.

As rescuers moved away from the burning pickup with the two victims, another explosion occurred, additional fuel and flame engulfed the pickup, and no one could get near the fire. These events all occurred before any emergency agency arrived at the scene.

There was no evidence that any of the occupant restraints available in the sedan, truck, or pickup truck were in use at the time of the accident. Considering the crash dynamics, the use or non-use of restraints by the occupants of the pickup would not have had any influence on their fatal injuries. However, use of restraints by the truckdriver would have prevented his being tumbled about within the truck cab. It could not be determined what effect this would have had on his injuries.

ANALYSIS

Vehicle Dynamics

There was no evidence that any of the vehicles had any precrash vehicle defects or that a malfunction contributed to the collision. The observed damage was consistent with the statements of witnesses as to the collision sequence. The damage to the sedan's left door matched the size and shape of the tank truck's damaged right front hub and tire. It is not likely that the small sedan displaced the tank truck to the left, but the tire marks on the sedan were made by the leading arc of the tank truck tire, and this may have forced the front wheels of the tank truck to the left. It is also possible that the tank truckdriver made a reflex movement to the left when the sedan turned in front of him, but he denied this and stated that he was only attempting to steer the tank truck in a straight line. Both vehicles moved to the left and the tank truck struck the pickup; the damage to the right rear of the pickup cab matched the curvature of the left front of the cargo tank on the tank truck.

Damage to the left front of the pickup established that the pickup struck the median barrier at a 25° angle. When the pickup struck the median barrier, the tank truck was redirected to the right by the driver steering away from the pickup and by the trailer unit's continuing to the left of the tank truck and striking the median barrier. The high center of gravity of the tank trailer and the centrifugal forces exerted at 50 mph caused the tank trailer to roll left onto and over the median barrier. The connecting drawbar provided two dynamic functions: one, it allowed the tank truck to continue to rotate clockwise until it rolled over, and two, it provided downward pressure to create a sawing, abrasive action as the upside down tank trailer slid along the top of the median barrier. This force stripped the glareshield from the top of the barrier. The 2-inch angle iron posts held by supporting bolts provided the ignition sparks and combined with the abrasive action of the concrete to rupture the cargo tank and the spilling of the gasoline. The heat of the abrasion, and sparks generated when the side of the pickup truck scraped against the median barrier, ignited the fuel.

Highway Design

The speeds of all three vehicles involved were below the freeway design speed. The horizontal and vertical alignment of this highway was designed to permit vehicles to operate at speeds considerably greater than the posted speed.

This section of freeway provided adequate visibility for both overtaken and overtaking traffic. But the heavy traffic and high speeds required extra vigilance when changing lanes. In the previous 3 years, 21 percent of the accidents in this area were the result of lane changes.

The sedan driver stated that she had looked to her left without seeing the truck. She did not mention if she had used the left outside mirror. Use of a properly adjusted mirror should have made her aware of the approaching truck, although it is possible, depending upon the position of the truck, that she would have seen only a portion of the right side of the truck.

The need for improved rearview visibility has been recognized by the National Highway Traffic Safety Administration. A Notice of Proposed Rulemaking proposing an amendment to the FMVSS No. 111, Rear View Mirrors, was published in the fall of 1978. A final ruling is expected in the spring of 1981.

The accident rate for this area is about one-half the rate for the urban Interstate system in the United States. The accident statistics also point out that over a 3-year period not one vehicle had penetrated the median barrier in 129 recorded hits. The New Jersey-type barrier, reinforced with longitudinal steel bars 6 inches and 12 inches from the top, apparently is functioning as intended.

In view of the above, the Safety Board concludes that neither highway design nor vehicle speed contributed to the accident.

Hazardous Materials and Emergency Response

The tank trailer came to rest with the front resting on the median barrier and discharging fuel on top of the pickup and under the rear of the tank truck. The "unwetted" vapor space above the gasoline in the overturned truck tank was exposed directly to flames. Within minutes after the fire erupted, the rear of the tank truck ruptured. During the fire, the internal vapor relief vents did not function to reduce the internal pressure buildup as much as necessary. Because the tank was inverted, the vapor vents released liquid instead of vapor. The vapor built up faster than the vents could void the liquid, and the tank ruptured due to the pressure buildup. The rupture did not add to injury or cause additional damage because all possible rescue efforts had already been completed and bystanders were not close to the fire.

When the firefighting units arrived, they had no direct contact with the California Highway Patrol command post or the driver of the gasoline tank truck. They were without benefit of placards or waybills and were concerned about victim rescue, vehicle information, and the quantity and positive identity of the hazardous material. They made assumptions based on past experience and immediately attacked the flames.

The shipping papers were destroyed in the fire and the truckdriver was on the opposite side of the fire from the highway patrol command post. The tank truckdriver had been helping one of the fire victims until the ambulance arrived and then he contacted an officer who was busy moving traffic away from the fire

to make space for arriving fire trucks. He identified himself and the officer told him to give his information to the firemen. By the time the driver talked to firemen, his information about his cargo was no longer critical. He stated the firemen seemed to know they were fighting a gasoline fire and did not need the information. However, the first responding city fire and State police units did not pass and coordinate this information between their respective command posts so that each could act on the best information. Because of this lack of communication, the fire department had to attack the fire relying on assumptions on past experience and without the benefit of information available from the driver at the scene.

The fire resulting from the burning gasoline which had flowed underground in the storm drains to the Tujunga Wash was in effect a separate flammable liquid fire in a remote location. This required police and firefighting personnel to disperse to control the flaming runoff and to monitor the progression of the flaming liquid as it floated on the water in the flood control channel. This complicated the operational procedure.

As the cargo tanks melted down and the fire progressed, the spread of burning gasoline made the application of foam difficult. Black smoke partially obscured the scene and the end of the burning truck, and made communication around the fire perimeter difficult. Despite these obstacles, the fire department was able to control and put out the fire.

However, the Safety Board is concerned that there was no reliable procedure or system to link the first police and firefighting personnel arriving on the scene with those that arrived later. A common communications system should be available so information can be exchanged during situation evaluation and first actions. Without such a procedure, the fire and police units are not able to pass and coordinate information so that each can effectively assess the situation and minimize exposure to unnecessary danger.

Such communications are important because firefighting and enforcement organizations complement each other during an emergency. During a fire emergency, enforcement personnel typically control vehicular traffic to permit fire department access. The fire departments concentrate efforts on combating and alleviating the effects of the fire. An effective control effort can only be assured if the fire and enforcement units maintain continuing liaison from the beginning of the emergency to the end.

The separate agencies at an emergency require not only oral communications but also a preplanned agreement on a command structure governing all units. The units at this accident appeared to be operating as two separate agencies, each interested in its own responsibilities. There is no evidence that either made any attempt to coordinate activities or establish either of the two command posts as the principal coordinator. While this did not have any adverse effects in this case, under circumstances involving a cargo which was incompatible with water, the results could have been disastrous.

The State of California and the City of Los Angeles are working to resolve the types of problems encountered during this emergency, and the Safety Board encourages them to seek a prompt solution. The problem of lack of communication can arise in any major emergency regardless of location. Improved communications during emergency response operations has previously been addressed by the Safety Board, and this accident reinforced its concern that many local governments are not ready to deal effectively with emergency response operations.

Currently, the Safety Board is pursuing 19 open safety recommendations related to the improvement of emergency response capabilities; 10 of these address the more specific area of improved on-scene emergency response procedures. (Safety Recommendations Nos. I-75-7, I-76-8, I-77-2, I-77-3, I-79-5, I-79-6, I-79-8, I-79-9, I-79-10, and I-79-11.) The 19 recommendations encompass all phases of the actual emergency, all modes of transportation, and all regulated commodities. The recommendations have been made over a 5-year period, yet no final action has been taken by the Department of Transportation on any of them.

The response to this accident reinforces the importance of the efficient handling of the early stages of a highway hazardous materials emergency and points to the need for a pre-planned emergency response plan which is continuously updated. The Safety Board strongly reaffirms its position regarding the need for pre-planned emergency response measures.

CONCLUSIONS

Findings

1. A postcrash examination of the three vehicles revealed no precrash mechanical discrepancies which contributed to the accident.
2. The sedan sideswiped the tank truck when the sedan changed lanes to the left.
3. The tank truck sideswiped the pickup as the tank truck moved to the left following the initial collision.
4. The pickup was forced into the median barrier at an impact angle of 25°.
5. The tank trailer struck the median barrier at an estimated speed of 50 mph.
6. The tank unit of the tank truck hit the highway concrete surface during rollover.
7. There is no evidence that occupant restraints were used by any of the accident victims.

8. An evaluation of the highway failed to disclose any design problems that would cause the tank truck to strike the median barrier.
9. The tank trailer overturned on top of the median barrier and protruded into the opposing traffic because the center of gravity of the tank trailer was higher than the design parameters of the barrier.
10. The first responding city fire and highway patrol units did not exchange information with the command posts so that each could fully assess the situation.
11. Despite the lack of specific information concerning the spilled cargo, the firefighters successfully extinguished the fire with a minimum of delay after their arrival.
12. Fire and law enforcement units responding to hazardous materials emergencies should have coordinated plans and a capacity for rapid exchange of information throughout such emergencies.
13. The communications difficulties identified in this accident should be studied by all fire, police, and rescue units; a model procedure should be developed utilizing common frequencies, proven dispatcher-relay techniques, or alternative means to pass and coordinate information through a single command post throughout an emergency.

Probable Cause

The National Transportation Safety Board determines that the probable cause of this accident was the improper lane change by the driver of the sedan which hit the tank truck and caused it to move to the left and strike the pickup truck forcing it into the median barrier. The fatalities and injuries were caused by the fire which ensued immediately when gasoline was released from the ruptured tank trailer.

RECOMMENDATIONS

As a result of a special investigation of the emergency response following a March 31, 1977, railroad accident near Rockingham, North Carolina, the Safety Board concluded that "the implementation of an effective hazardous materials emergency response network in combination with adequate on scene communications should provide emergency response personnel with the information needed to adequately assess the dangers involved." As a followup of that special investigation the Safety Board made the following recommendation on September 13, 1979:

--to the U.S. Department of Transportation

"... develop and disseminate guidelines for planning emergency responses to transportation accidents involving hazardous

materials. These guidelines should clearly delineate the on scene command structure, establishment of a command post and communications, and structure of the coordination of efforts, and require control of access to the accident site. Furthermore, the relationships and responsibilities of the responding Federal, State, Local and private agencies should be clearly identified. (Class II, Priority Action) (I-79-5)."

The Department of Transportation endorsed the recommendation; however that recommendation has not been implemented. The Safety Board; therefore, reiterates that recommendation and urges prompt DOT implementation.

BY THE NATIONAL TRANSPORTATION SAFETY BOARD

/s/ JAMES B. KING
Chairman

/s/ FRANCIS H. McADAMS
Member

/s/ PATRICIA A. GOLDMAN
Member

/s/ G. H. PATRICK BURSLEY
Member

ELWOOD T. DRIVER, Vice Chairman, did not participate.

September 9, 1980

APPENDIXES

APPENDIX A
INVESTIGATION

1. Investigation

The National Transportation Safety Board was notified of this accident at 6:10 a.m., on March 4, 1980. An Investigator-in-Charge was dispatched from the Los Angeles Field Office and arrived at the scene at 7:30 a.m., on March 4, 1980. An investigative team to work under the IIC arrived on scene at 8:30 p.m., on March 4, 1980.

Investigative groups were formed for Human/Injury Causative Factors, Highway/Environment Factors, Vehicle Factors, and Hazardous Materials Factors. Representatives of the Bureau of Motor Carrier Safety, State of California, Los Angeles Fire Department, California Department of Transportation (CALTRANS), and the California Highway Patrol participated in the investigation.

2. Deposition/Hearing

There were no depositions taken or hearings held in connection with this investigation.

**APPENDIX B
PRODUCT LOADING DATA**

	<u>Gross Weight</u>	<u>Compartments</u>	<u>Actual Load (Gals)</u>	<u>Density</u>
<u>Trailer Truck</u>				
Chassis	13,620 lbs.	1 front	2,050 gals.	.57 API*
Cargo Tank	2,860 lb	1 rear		
Product	<u>25,594 lbs.</u>	---	<u>2,050 gals.</u>	<u>.57 API*</u>
Sub Total	42,064 lbs.		4,100 gals.	
 <u>Full Trailer</u>				
Tank and Chassis	6,920 lbs.	1 front	1,800 gals	..57-.55 API*
Product	<u>30,457 lbs.</u>	<u>1 rear</u>	<u>3,081 gals.</u>	<u>.57 API*</u>
Sub Total	37,377 lbs.		4,881 gals.	
TOTAL	79,441 lbs.	4 Compartments	8,981 gals.	.574 API*

*Specific density = $\frac{46.1}{62.4} = .749$

Density of Water = $\frac{62.4 \text{ lb/ft}^3}{7.48 \text{ gal/ft}^3} = 8.34 \text{ lbs/gal.}$

Density of Gasoline = $.748 (8.34 \text{ lbs/gal}) = 6.24 \text{ lbs/gal.}$