

**Strategic  
Plan**  
2011-2016

**FOM Institute  
for Subatomic Physics**

**Nikhef**

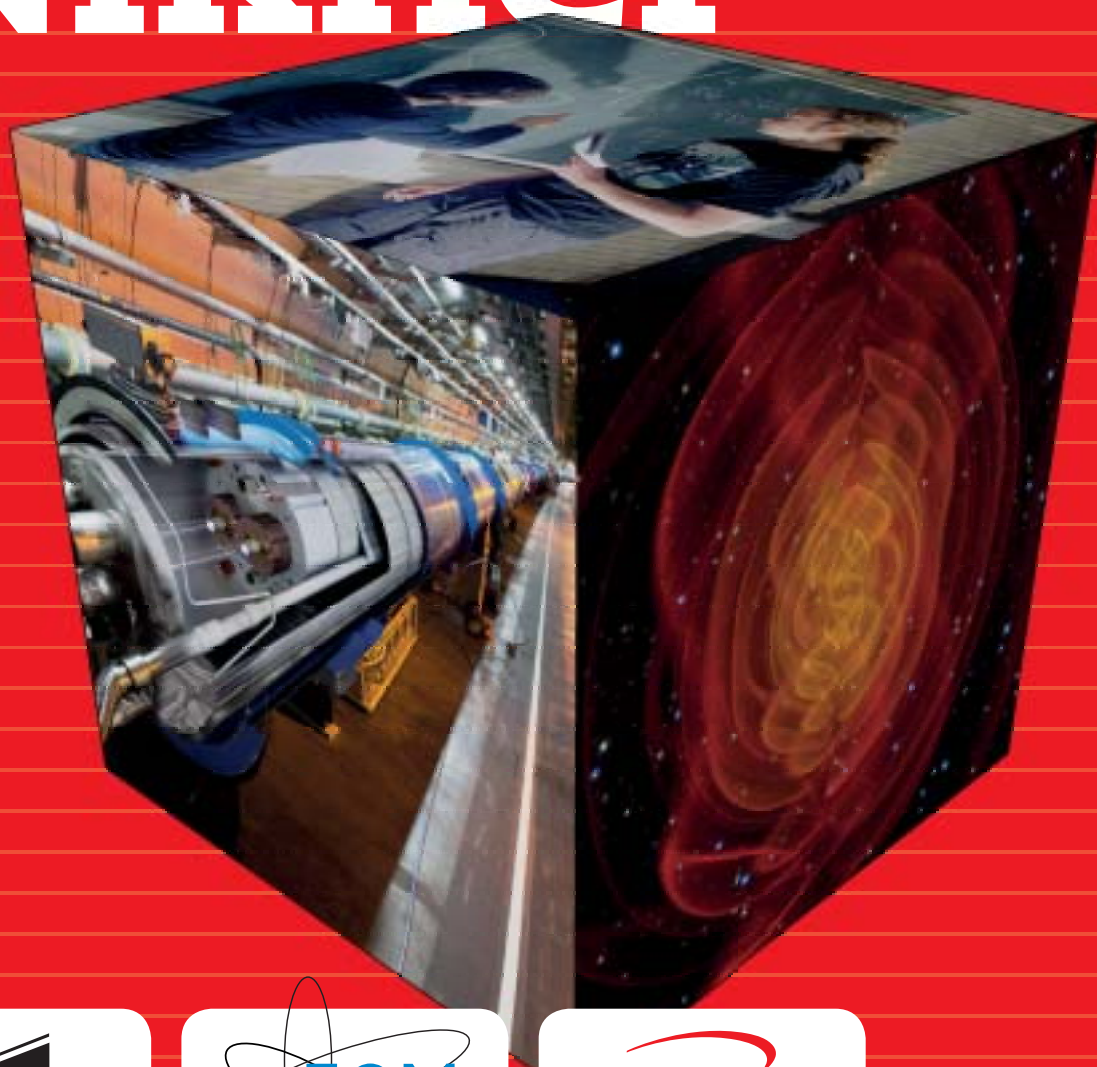

**NIKHEF**

**FOM**

**NWO**



Strategic Plan  
2011-2016

FOM Institute  
for Subatomic Physics  
Nikhef



# Colophon

**Publication edited for Nikhef**  
**Nationaal instituut voor subatomaire fysica**  
**National Institute for Subatomic Physics**

Address: Postbus 41882, 1009 DB Amsterdam  
Science Park 105, 1098 XG Amsterdam

Telephone: +31 20 592 5001

Fax: +31 20 592 5155

E-mail: [directie@nikhef.nl](mailto:directie@nikhef.nl)

URL: <http://www.nikhef.nl>

Editors: Patrick Decowski, Kees Huyser, Frank Linde, Vanessa Mexner, Arjen van Rijn, Leo Wiggers

Layout/art-work: Kees Huyser, Drukkerij Badoux - Houten

Photos: Kees Huyser, Jan Koopstra, Marco Kraan, Charles Timmermans, ARCADIS Nederland BV, CERN, Erasmus MC, Nikhef

Cover: Kees Huyser

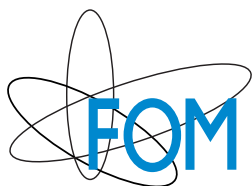

This document is produced for the NWO evaluation of the FOM Institute for Subatomic Physics. It describes the strategy for the period 2011–2016 and beyond. Nikhef is the National Institute for Subatomic Physics in the Netherlands, in which the Foundation for Fundamental Research on Matter, the University of Amsterdam, VU University Amsterdam, Radboud University Nijmegen and Utrecht University collaborate. Nikhef coordinates and supports the activities in experimental particle and astroparticle physics in the Netherlands. The Foundation for Fundamental Research on Matter (FOM) is part of the Netherlands Organisation for Scientific Research (NWO).

Nikhef participates in experiments at the Large Hadron Collider at CERN, notably ATLAS, LHCb and ALICE. Astroparticle physics activities at Nikhef are fourfold: the ANTARES and KM3NeT neutrino telescope projects in the Mediterranean Sea; the Pierre Auger Observatory for cosmic rays, located in Argentina; gravitational-wave detection via the Virgo interferometer in Italy, and the projects LISA and Einstein Telescope; and the direct search for Dark Matter with the XENON detector in the Gran Sasso underground laboratory in Italy. Detector R&D, design and construction take place at the laboratory located at Science Park Amsterdam as well as at the participating universities. Data analysis makes extensive use of large-scale computing at the Tier-1 facility operated by the Grid group. Nikhef has a theory group with both its own research programme and close contacts with the experimental groups.

# Contents

<b>Preface</b> .....	4
<b>1 Introduction</b> .....	7
1.1 Introduction .....	8
<b>2 Physics Programmes</b> .....	17
2.1 Accelerator-based particle physics .....	19
2.1.1 Physics at the TeV scale: ATLAS .....	23
2.1.2 Physics with b-quarks: LHCb .....	27
2.1.3 Relativistic heavy-ion physics: ALICE .....	31
2.2 Astroparticle physics .....	34
2.2.1 Neutrino telescopes: ANTARES and KM3NeT .....	36
2.2.2 Gravitational physics: Virgo, LISA & ET – the dynamics of spacetime .....	39
2.2.3 Ultra high-energy cosmic rays: Pierre Auger Observatory .....	42
2.2.4 Dark matter: XENON .....	45
2.3 Enabling physics programmes .....	48
2.3.1 Theoretical physics .....	49
2.3.2 Detector R&D .....	52
2.3.3 Physics data processing: Grid computing .....	56
<b>3 Technical Skills and Infrastructure</b> .....	59
3.1 Introduction .....	60
3.2 Facilities .....	61
3.3 Technical departments .....	63
<b>4 Outreach, Education and Knowledge Transfer</b> .....	67
4.1 Outreach and education .....	68
4.2 Knowledge transfer .....	72
<b>5 Finances 2011–2016 and beyond</b> .....	75
5.1 Finances 2011–2016 and beyond .....	76
5.2 Mission budget increase .....	80
<b>Appendices</b> .....	81
A SWOT analysis .....	82
B National & international context .....	84
C Organigram .....	87
D Glossary .....	88

# Preface

Scientifically, the time frame covered by Nikhef's "Strategic Plan 2011–2016" promises to become *the* most exciting period in the history of Nikhef.

Foremost, because of CERN's *Large Hadron Collider* (LHC) program which, after a false start in 2008, made a superb comeback in 2010: a 100,000-fold increase in the peak luminosity and essentially a rediscovery of half a century of elementary particle physics ( $K_S^0$ ,  $J/\psi$ ,  $W$ ,  $Z$  and top). Unless Nature is completely uncooperative, the ATLAS and LHCb experiments will –with the data of the 2011–2012 proton-proton LHC run– finally shed light on two long-standing dilemmas in elementary particle physics:

- *Does the Standard Model Higgs particle exist?*
- *Do we live in a supersymmetric world?*

When the Higgs particle will indeed be found, this will be the first step towards a better understanding of the masses of the elementary particles. If supersymmetry is discovered, this will unveil an entirely new direction in elementary particle physics research, including new particles explaining the mysterious dark matter in the Universe. Moreover, if Nature is really kind, even completely unexpected new phenomena could be discovered at the LHC. Finally, with the LHC in heavy-ion, lead-lead, instead of proton-proton mode, the ALICE experiment will study the *quark-gluon plasma*, a state of matter common in the very early stage of the Universe.

Secondly, because Nikhef's four *astroparticle physics* endeavours are also entering an extremely exciting era. Front-line research questions in this emerging interdisciplinary field:

- *Do gravitational waves exist?*
- *What is the nature of dark matter?*
- *Do high-energy neutrino point sources exist?*
- *What is the origin of high-energy cosmic rays?*

The *Virgo gravitational-wave interferometer* near Pisa (Italy) will –after the completion of the advanced Virgo upgrade project in 2015 (the centenary of Einstein's theory of general relativity)– reach sensitivities corresponding to tens of observable sources per year. The *XENON100 direct dark matter detection experiment* at the deep-underground Gran Sasso laboratory near L'Aquila (Italy) recently published the best upper limit on the cross section of WIMPs



Discussion on long-term strategy at the annual meeting 2006, well before the start of LHC.

(Weakly Interacting Massive Particles), the most plausible candidate explaining the dark matter in the Universe. Its scaled-up successor XENON1T (1000 kg fiducial mass) will come online in 2014 with a 1000 times better sensitivity than XENON100 (100 kg fiducial mass) thereby covering almost the entire parameter space of supersymmetric WIMPs. The *ANTARES neutrino telescope* in the Mediterranean Sea of the coast of Toulon (France) and the *Pierre Auger Cosmic-Ray Observatory* on the Pampa Amarilla (Argentina)

are both fully operational since 2007 and frantically searching for point sources of high-energy neutrinos and cosmic rays, respectively. Once discovered, this will open a completely new perspective on the Universe.

Progress in elementary particle physics has always been made thanks to a strong interplay between experiment and theory. Therefore, Nikhef not only participates in the aforementioned experiments, but also has a *theory group*. Its members often collaborate closely with Nikhef's experimentalists, but also pursue their own independent research program. I can not resist mentioning here that the world's most powerful *symbolic manipulation program* (FORM) is a product of Nikhef's theory group.

Technologically, Nikhef's field of research offers challenges (and solutions) that often surpass imagination. Dealing with GHz proton-proton collision rates in a harsh radiation environment at the LHC. Measuring relative length differences better than  $10^{-22}$  to detect the space-time ripples left by a passing gravitational wave in the Virgo laser interferometer. Designing a cost-effective and easy to deploy concept to instrument multi-cubic kilometres of sea water in the Mediterranean Sea for KM3NeT, the successor of the ANTARES neutrino telescope. Separating the ambient radio noise from the minute radio signals left by cosmic rays in the Earth's atmosphere to enhance the duty cycle of the Pierre Auger Observatory. Mastering radiation backgrounds to incredibly low levels to reach the less than  $10^{-46}$  cm<sup>-2</sup> cross-section regime to observe direct dark matter particle interactions in XENON1T. Not surprisingly, Nikhef has excellent *technical (mechanics, electronics and computing) departments* as well as a strong *detector R&D group* to cope with these challenges. Together with SARA, the Dutch national computer centre, Nikhef houses a large *grid infrastructure*, including an 'LHC Tier-1' site.

The curiosity driven nature of Nikhef's research activities exposes Nikhef physicists to a plethora of *education and outreach* activities. Ranging e.g. from Sunday morning performances for children in Amsterdam's NEMO science museum to evening lectures for senior citizens with regular university teaching as main activity.

In the last years *knowledge transfer* has received more emphasis at Nikhef. An early non-planned example is the *World Wide Web* developed by the particle physics community in the early nineties that has led to the thriving (and still expanding) internet exchange, AMS-IX, at Nikhef. Similarly, Nikhef is helping diverse research communities to make use of the national grid infrastructure. Also, collaboration with private industry is gaining ground at Nikhef. In addition to the long-established collaboration with PANalytical in the field of X-ray detection, e.g. two Nikhef start-up companies (Sensiflex and ASI) are being set up and Nikhef brainstorms with several large industrial research laboratories about the possibilities of joint projects.

Having stated all this, it should not come as a surprise that I am extremely proud to be the director of Nikhef. This, not only because of Nikhef's exciting research agenda, but also because of the many different personalities working at (and shaping!) Nikhef. And all these individuals have one common desire in view of the challenging environment: to stay at Nikhef until or even beyond their retirement. I am no exception.



Thanks to all of you!  
Frank Linde  
Nikhef director



Nikhef staff are present with an information stand at Physics@FOM Veldhoven, the yearly get-together for physicists from the Netherlands.



# 1 Introduction

ANTARES

KM3NeT

VIRGO

LISA

ET

AUGER

XENON100 → XENON1T

THEORY

R&D

GRID

ATLAS

LHCb

ALICE

New FOM programme  
LHC physics

LHC phase II

e<sup>+</sup>e<sup>-</sup> Linear Collider

2005

2010

2015

2020

2025

# 1.1 Introduction



The FOM-Institute for Subatomic Physics Nikhef ('FOM-Nikhef'), located at the Science Park Amsterdam, is the flagship of the Nikhef Collaboration. The other four Nikhef Collaboration members are: the Utrecht University (UU), the VU University Amsterdam (VU), the University of Amsterdam (UvA) and the Radboud University Nijmegen (RU). Nikhef coordinates and supports experimental subatomic (particle and astroparticle) physics in the Netherlands. FOM-Nikhef is an integral part of the FOM organisation, the Foundation for Fundamental Research on Matter.

Nikhef employs currently about 165 fte (full-time-equivalent) physicists (about 60 fte staff physicists, 30 fte postdocs and 75 fte PhD students). Technical support is provided by well equipped mechanical, electronic and information technology departments with a total staff of about 80 fte. Management and general support is realised by a staff of about 28 fte.

This document presents in Chapter 2 the experimental research, theory, detector R&D and grid computing programmes Nikhef in-

Figure 1.1.1. (opposite page) Timeline of approved (green border) and anticipated research programmes. The fill colours refer to programmes in the design and building (blue), and running (dark blue) phase. The width of the bars are an estimate of the relative weight of these programmes in 2011. The  $e^-e^-$  linear collider bar (purple) is given for informational purposes only.

## Nikhef's mission statement

The mission of Nikhef is to study the interactions and structure of all elementary particles and fields at the smallest distance scale and the highest attainable energy.

Two complementary approaches are followed:

- **Accelerator-based particle physics**  
*Experiments studying interactions in particle collision processes at particle accelerators, in particular at CERN;*
- **Astroparticle physics**  
*Experiments studying interactions of particles and radiation emanating from the Universe.*

Nikhef coordinates and leads the Dutch experimental activities in these fields.

tends to pursue in the coming decades. Chapter 3 deals with the technical skills and infrastructure to maintain and where needed to expand Nikhef's strong track record in designing and building state-of-the-art experiments. Chapter 4 deals with Nikhef's vision on and activities in the important areas of education, public outreach, and collaboration with industry. In chapter 5 the funds required to realise the ambitions laid down in this strategic plan are presented, as well as how Nikhef foresees to acquire these funds. An analysis of the strengths, weaknesses, opportunities and threats (SWOT), the (inter)national environment Nikhef operates in, an organisation diagram, and a glossary are given in the appendices A, B, C, and D, respectively. This chapter includes Nikhef's "Mission statement" and concludes with a brief overview of the fields of particle- and astroparticle physics and the strategic choices Nikhef has made herein that have led to the "Strategic Plan 2011-2016".

## Research focus

### Overview

Throughout the 20<sup>th</sup> century immense progress has been made in unravelling and understanding the structure of elementary particles and fields: from the chemical elements to three families of quarks and leptons and their antiparticles; from the classical theory of electromagnetism to relativistic quantum field theories culminating in the Standard Model of the electroweak- and strong interaction. Throughout, accelerator-based experiments have played a decisive role: from Thomson's discovery of the electron using cathode rays in 1897 to the discovery of the top-quark at Fermilab's Tevatron in 1995. At the end of the 20<sup>th</sup> century the Standard Model not only very successfully described a plethora of high-precision data from particle-physics experiments all around the world, but also was crucial for a qualitative and quantitative description of the evolution of our Universe, starting from a minute fraction of a second after the Big Bang until today, about 13.7 billion years later. Linking apparently completely unrelated

	Accelerator-based particle physics			Astroparticle physics			
	ATLAS	LHCb	ALICE	Neutrino Telescopes	Cosmic Rays	Gravitational Waves	Dark Matter
Origin of mass?	•••	•					•
Antimatter?	•	•••					
Quark-gluon plasma?			•••				
Supersymmetry?	•••	••		•	•		••
Dark matter?	•	•		••	••		•••
Dark energy?							
Nature of neutrinos?				•	•		•
Extra dimensions?	••	•					••
Gravitational waves?						•••	
Magnetic monopoles?	•			••			
Origin of cosmic rays?				••	•••	•	
Early Universe?	•	•	••			••	••
<b>Unexpected phenomena!</b>	•••	••	•	•••	••	•	•

Table 1.1.1. The cross correlation (••• large, •• medium, • small) between research questions and the actual experiments in which Nikhef participates.

observations like the disappearance of antimatter and the abundance of the natural elements in our Universe as observed by astronomers, and the number of particle families (i.e. the number of light neutrino species) as measured in particle accelerator experiments, connecting the sciences of the infinitely large (astronomy) and the infinitesimally small (particle physics). The only critical ingredient of the Standard Model lacking experimental verifica-

tion appears to be the Higgs particle, hypothesised to exist to explain the origin of the masses of all particles in the Standard Model. Not surprisingly, the Higgs particle has become and still is the holy grail of particle physics.

Experiments, observations and theoretical speculations in more recent years, however, have revealed a Universe far stranger and even more wonderful than predicted by the Standard Model. A Universe that, if the Higgs hypothesis is correct, should shrink to the size of a football due to the vacuum energy in the Higgs field; posing a hard problem to be solved. A Universe, in which neutrinos oscillate, i.e. change flavour. A Universe, in which theorists predict each Standard-Model particle to be accompanied by a supersymmetric partner and a Universe, in which at least one magnetic monopole needs to exist in order to understand the quantisation of electric charge. A Universe, filled with dark matter and dark energy, where ordinary matter (quarks and leptons) constitutes only a tiny 4% fraction. A Universe, in which theorists, in their attempts to reconcile the theory of gravitation with the principles of quantum mechanics, predict the existence of curled up extra spatial dimensions invisible in our everyday world. This is the Nikhef research arena!

Despite the often impressive theoretical ingenuity of the models and despite the quantitative accuracy of some of the predictions, we know amazingly little about the real nature (or the existence) of e.g. Higgs particle(s), neutrinos, supersymmetric particles, magnetic monopoles, dark matter, dark energy and extra spatial dimensions. Answers are likely to come from both dedicated and

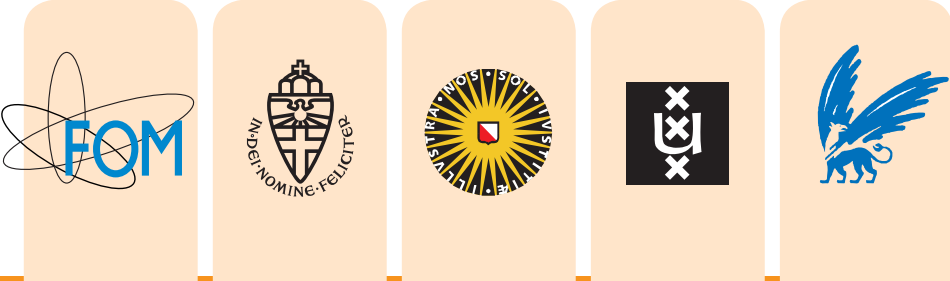

	FOM	RU	UU	UvA	VU
ATLAS	••••	••		••	
LHCb	••••				••
ALICE	••••		•••		
Neutrino Telescopes	••••		•	••	
Cosmic Rays	••	••			
Gravitational Waves	••				••
Dark Matter	••			•	
Theoretical Physics	••••	••	•	•	•
Detector R&D	••••				
Grid Computing	•••				

Table 1.1.2. Projected number of physicists (staff, post-docs and PhD students) at each Nikhef partner working in 2011 on the various Nikhef research programmes:  
 • <3 fte  
 •• 3-6 fte  
 ••• 6-9  
 •••• >9 fte.

general purpose experiments. The latter category of experiments is conceived such that they also allow the discovery of the truly unexpected. When this happens, our view of the Universe changes dramatically as occurred following the discovery of neutral currents in 1973, the discovery of the charm-quark in 1974 and the announcement of neutrino oscillations in 1998.

Nikhef decided to confront these scientific challenges by means of two complementary lines of approach coined *accelerator-based particle physics* and *astroparticle physics*. The cross correlation between the actual experiments Nikhef participates in and the aforementioned research questions is shown in Table 1.1.1.

### Accelerator-based particle physics

#### Large Hadron Collider

After decades of preparations and a serious incident in 2008 the Large Hadron Collider (LHC) truly established itself as the world's highest-energy particle collider project in 2010. At 50% of the design energy (3.5 TeV instead of 7 TeV proton-beam energy) and with a steep increase of the luminosity over the year, the LHC experiments have measured and published in the space of around eight months just about all the particle physics' discoveries of the last half-century. Here, the undisputed highlight was the observation of the first top-quarks at CERN. Other remarkable LHC achievements in 2010 were the smooth transition from proton to heavy-ion collisions, the excellent performance of all four LHC detectors in terms of detector resolution, efficiency and readiness and the overall speed and reliability at which the grid computing concept helped scientists to convert the massive raw data samples

to physics results. With these assets the LHC is ready to unveil the physics at an hitherto unexplored energy scale: *the TeV scale*.

The first challenge will be to discover the last missing member of the Standard Model particle family: *the Higgs particle*. In the unlikely event that the Higgs particle is not discovered at the LHC, not only the origin of mass should be sought for beyond the Standard Model, but also the interpretation of the much heralded data of CERN's previous project, the Large Electron Positron (LEP) collider must be revisited. The observation of extra spatial dimensions, possibly via the creation and subsequent decay of so-called mini-blackholes, will have profound influence on attempts to reconcile gravity with quantum mechanics. The observation of new particles, e.g. a supersymmetric partner of one of the quarks, leptons or gauge bosons, not predicted by the Standard Model, could elucidate the nature of dark matter in the Universe. Physics beyond the Standard Model could furthermore manifest itself in precision measurements of CP-violation effects in heavy quark interactions at the LHC, thereby possibly deepening our understanding of the minute differences between matter and antimatter. Finally, heavy-ion collisions in the LHC will yield detailed measurements on a state of matter assumed to have filled the Universe directly after the Big Bang: a plasma of free quarks and gluons at extremely high temperature and pressure. Because of this tremendous discovery potential, the LHC is consistently ranked as the top priority project in particle physics by roadmap committees <sup>[1]</sup>.

To fully exploit the LHC discovery potential, Nikhef early on decided to participate in the general-purpose ATLAS experiment

(1991), the LHCb experiment (1994) dedicated to the study of CP-violating effects in the B-system, and the ALICE experiment (1994) optimised to study the quark-gluon plasma. Together with the national computer centre SARA, Nikhef houses and operates one of 11 LHC Tier-1 grid compute centres in the world. Supported by in-house theorists, the experimental scientists at Nikhef are thereby in a perfect position to extract the first signs of new physics from the wealth of LHC data. Complementary to these physics data analysis prospects, several original Nikhef R&D ideas are considered for the future upgrades of the LHC experiments to cope with radiation damage and the desire to run the LHC at very high instantaneous luminosity. All in all, Nikhef is in a good position to play an important role in exploiting in all aspects the LHC, the world's largest scientific endeavour, for many years to come and certainly well beyond the scope of this Strategic Plan 2011–2016.

#### **Beyond the Large Hadron Collider**

The future of accelerator-based particle physics at the high-energy frontier critically depends on the findings (Higgs, supersymmetry, etc.) at the LHC. In 2012, with a significant fraction of the first long LHC run analysed, this will be extensively discussed in a series of town meetings leading to an update of the “European strategy for particle physics”<sup>[1]</sup> from 2006. Like in 2006, Nikhef intends to play a prominent role in this process. Meanwhile, Nikhef keeps its options open with: a vigorous detector R&D programme anticipating an LHC luminosity upgrade (up to  $10^{35}$  cm<sup>-2</sup>s<sup>-1</sup>) and/or energy upgrade (factor 2) in the next decade; a participation in the time projection chamber R&D for the e<sup>+</sup>e<sup>-</sup> linear collider (ILC or CLIC); prototype systems for the high-precision alignment of the critical parts of the CLIC accelerating structures as an in kind contribution to the “CLIC Test Facility 3” (CTF3); and a modest contribution to the Muon Ionisation Cooling Experiment (MICE) in view of future high intensity neutrino beams and possibly a  $\mu^+\mu^-$  collider in the far future.

Even though it is premature to speculate now about future LHC (and other) discoveries in particle physics, it is taken for granted that in almost all imaginable scenario's the two general purpose LHC experiments, ATLAS and CMS, continue to at least 2030, to extend the discovery potential for new particles and new phenomena to the highest attainable energies. Nikhef certainly expects to continue on ATLAS. Similarly, it is inconceivable to expect that Nikhef will not participate in an experiment at a future e<sup>+</sup>e<sup>-</sup> linear collider, *provided this e<sup>+</sup>e<sup>-</sup> linear collider gets built*. 16 Nikhef staff physicists already signed the Letter of Intent submitted by the International Large Detector (ILD) consortium in 2010. While the LHC is the instrument of choice for exploring the high-energy domain, the e<sup>+</sup>e<sup>-</sup> linear collider is essential to chart in detail the properties

#### **Knowledge transfer**

Experiments in particle physics critically depend on state-of-the-art technology with discoveries often following a technological breakthrough. Vice versa, particle physics technology can revolutionise society as e.g. CERN's invention of the World Wide Web did. AMS-IX, one of the world's largest internet exchanges, started at Nikhef and the societal impact of Nikhef's AMS-IX location is regretfully best assessed when the service breaks down! Grid computing, in the Netherlands pioneered by Nikhef within the context of the BiG Grid project, could very well become an equally successful future technology. Other spin-offs arise from Nikhef's R&D activities as best exemplified by the commercial use of silicon pixel detectors in roentgen diffraction diagnostic equipment and, at a more modest scale, the recent commercial application of Nikhef's RASNIK alignment technology in civil engineering. Medical instrumentation is an area where Nikhef aspires to contribute too. Whenever the occasion arises, Nikhef encourages its staff to explore industrial collaboration.

of the new particles and fields that will hopefully be discovered at the LHC. Examples are: accurate measurements of the Higgs couplings, the Higgs self-interaction, and the masses and couplings of supersymmetric particles.

#### **Astroparticle physics**

##### **Past and near future**

In the past decade astroparticle physics, experiments using particle-physics techniques and instrumentation to explore the Universe, established itself as a mature research discipline addressing tantalizing scientific questions like:

- *the origin of cosmic rays;*
- *the existence of high-energy neutrino point sources;*
- *the direct detection of gravitational waves;*
- *the mysteries of dark matter, and*
- *dark energy.*

At Nikhef, astroparticle physics research took off substantially in 2001 when Nikhef embarked on the ANTARES project, a prototype neutrino telescope at the bottom of the Mediterranean Sea off the French coast to search for high-energy neutrino point sources. Driven not only by the excellent discovery potential of astroparticle physics, but also by a strong desire (and need) to develop an experimental activity complementary to Nikhef's LHC



Figure 1.1.2. Different strategies for finding dark matter.

programme, Nikhef initiated in 2004 a national platform (CAN, *Committee for Astroparticle Physics in the Netherlands*) to promote astroparticle physics in the Netherlands. In particular, a programme aimed at a better understanding of the origin of cosmic rays via a so-called multi-messenger approach. As a result, Nikhef joined in 2005, together with other Dutch research institutes, the Pierre Auger collaboration operating a huge cosmic-ray observatory located on the Argentinean Pampa Amarilla. In 2007, Nikhef joined the Virgo collaboration to search for gravitational waves with a large laser interferometer near Pisa in Italy. In each of these three experiments, Nikhef not only participates in data analysis, but Nikhef also soon played and continues to play a pioneering role in the development of key technologies like: the ‘all-data-to-shore’ concept for ANTARES; radio detection of cosmic-rays for the Pierre Auger Observatory; and multi-payload suspension tables for Virgo. Complementary to these three large-scale experiments, Nikhef decided in 2010 to also participate in a small scale, underground experiment. Nikhef joined in 2010 the XENON collaboration operating a xenon-filled time projection chamber, coined XENON100, deep underground the Gran Sasso mountain near L’Aquila in Italy with the aim to observe dark matter particles scattering on xenon atoms. Hereby, astroparticle physics activities have within a decade become a mature and thriving activity

at Nikhef. These experiments will enable Nikhef to contribute to several scientific breakthroughs in the coming years as summarised e.g. in an excellent manner in 2008 in “*Astroparticle Physics: the European strategy*”<sup>[2]</sup>.

#### Next generation experiments

A common feature of all four running Nikhef’s astroparticle physics experiments is their exploratory character, i.e. their main aims are discoveries: the origin (and composition) of cosmic rays (Pierre Auger Observatory); the detection of gravitational waves (Virgo); the identification of high-energy neutrino point sources (ANTARES); or the direct observation of dark matter particles (XENON100). Once established, future generation experiments will follow, either to study these new phenomena in detail or to use these phenomena as a new window on our Universe as e.g. is happening today already in the field of high-energy gamma rays with the Fermi space telescope and ground-based Cherenkov telescope arrays. Nikhef has the ambition to play a leading role in the development of these next generation instruments as is outlined below. To realise these ambitions, Nikhef initiated or joined, often within the context of the *EU Framework Programmes*, several projects.

The KM3NeT consortium plans in order to explore the physics of cosmic rays to design, construct and operate a multi-kilometre cube neutrino telescope in the Mediterranean Sea as a follow-up of the pilot ANTARES project. In view of the marine sciences opportunities offered by a deep-sea cabled infrastructure like KM3NeT, Nikhef initiated collaboration with NIOZ (*Royal Netherlands Institute for Sea Research*). This allowed NIOZ to develop and test a simple and efficient deployment scheme for the 900 metre long KM3NeT detector units. Nikhef’s proposal to equip the KM3NeT optical modules with many 3” photomultipliers instead of a single 9” photomultiplier was recently adopted as the KM3NeT baseline design.

#### Experimental research activities at Nikhef are typically drawing funds from three sources:

- **FOM mission budget**  
For permanent scientific and technical staff positions, travel expenses and membership fees;
- **FOM research programmes**  
For temporary scientific staff positions (PhD students and postdocs);
- **NWO & FOM investment subsidies**  
For the construction of the experiments.

Nikhef also pursues options to establish a collaboration between the Icecube collaboration (operating a neutrino telescope on the South pole) and the KM3NeT collaboration.

In the field of gravitational-wave detection Nikhef's main focus is on Virgo. In particular, data analysis and the advanced-Virgo upgrade project which should boost the sensitivity by an order of magnitude by 2015. Provided the theory of general relativity and stellar population models are correct, advanced-Virgo should register tens of gravitational-wave events per year thus paving the road towards a truly new window on our (early) Universe: *gravitational-wave astronomy*. For this, Nikhef is involved in the EU-supported design study for an underground laser interferometer (ET, Einstein Telescope) and Nikhef participates in the LISA laser interferometer space mission.

Since the Pierre Auger Observatory established the field of charged particle astronomy, it is clear that much more and better precision data are needed to fully exploit this entirely new window on the Universe. This will require more precise detection techniques with a higher efficiency, covering a much larger area. The aim is to

extend the Auger South site and in due course establish a much larger Auger North site in the Northern hemisphere. Resolving the intriguing change of composition from light (protons) to heavy (iron nuclei) elements towards the highest energies may well impact both our knowledge of astrophysical objects as well as of the interaction of particles with the Earth's atmosphere with invariant masses that exceed those explored at the LHC experiments by orders of magnitudes. Radio detection is a promising technique to achieve the goal of 100% duty cycle and accurate measurement of the extended air shower properties to determine the energy and chemical composition of ultra high-energy cosmic rays. Nikhef has the ambition to continue to play the leading role in radio detection development; paving the way for its successful large scale implementation.

To cover a large part of the parameter space predicted for dark matter candidates in supersymmetric theories, it is necessary to exploit detectors with a fiducial mass of at least one ton. For this Nikhef embarked on XENON1T. Nikhef notably took responsibility for the design of the large cryostat housing the dual-phase xenon filled time projection chamber (TPC) and Nikhef studies novel



Figure 1.1.3. Science Park Amsterdam with the Nikhef building. In the foreground the construction site of Amsterdam University College.



### Nikhef selects!

World-wide the number of running accelerator-based particle physics experiments (i.e. at hadron colliders,  $e^+e^-$  factories, neutrino beams, heavy-ion beams and fixed target facilities) and astroparticle physics experiments (the ‘magnificent seven’: high-energy neutrinos, gammas and cosmic rays; dark matter; neutrino mass; proton decay and neutrino properties; and gravitational waves) is several hundreds. Out of this plethora of opportunities, Nikhef engages in those activities that match Nikhef’s mission and weights whether:

- *Nikhef really makes a difference i.e. can contribute significantly to both the detector hardware (design and construction) and scientific exploitation;*
- *Nikhef numerically constitutes a fraction (people- and funding wise) commensurate with the Dutch CERN contribution;*
- *A Nikhef partner university can claim national leadership.*

In addition Nikhef strives to achieve a good match between experiments in the exploitation phase and experiments in the preparation phase as long as the physics justifies this: discovery potential is a sine-qua-non! As an illustration, in astroparticle physics most activities are still targeted at their first discoveries (as opposed to more accurate measurements) and hence in parallel to a running experiment Nikhef is also working on upgrades or next generation experiments. This is clearly exemplified by the ‘tandem’ experiments: ANTARES-KM3NeT; Virgo-ET/LISA; XENON100-XENON1T or by the development of the cosmic-ray radio detection technology for the Pierre Auger Observatory. Regarding accelerator-based experiments Nikhef decided long ago to fully concentrate on the LHC experiments. LHC discoveries will determine Nikhef’s future involvement in accelerator-based particle physics.

The key issue is of course:

*Is the number of experiments with Nikhef involvement in balance with Nikhef’s resources?*

Nikhef is engaged in seven experiments. In the most recent ones, gravitational waves (Virgo, since 2007) and direct dark matter (XENON, since 2010), Nikhef established itself very quickly (i.e. within a year) as a key partner, without compromising other Nikhef activities. This demonstrates the strength of Nikhef. In view of Nikhef’s national role and in comparison to similarly sized institutes abroad, a broader experimental research programme could be justified easily. However, further expansion of Nikhef’s experimental research programme will only be considered once new university partners join the Nikhef Collaboration.



Figure 1.1.4. International Women’s Day at CERN: enhance the visibility of women working at CERN. Here an all female ATLAS shift crew, with in the middle Nikhef PhD student Lucie de Nooij.

TPC-read-out technologies. XENON1T is scheduled to start data taking in 2014 and is expected to run for about five years.

Together, these four astroparticle physics programmes position Nikhef physicists in an excellent way to be among the first to discover, for example, dark matter, gravitational waves, high-energy neutrino point sources, and/or high-energy cosmic-ray point sources, and to subsequently explore these new phenomena in detail well into the next decade.

### References

- <sup>1</sup> The European strategy for particle physics, July 2006.  
[http://council-strategygroup.web.cern.ch/council-strategygroup/Strategy\\_Brochure.pdf](http://council-strategygroup.web.cern.ch/council-strategygroup/Strategy_Brochure.pdf)
- <sup>2</sup> Astroparticle physics: the European strategy, September 2008.  
[http://www.aspera-eu.org/images/stories/roadmap/aspera\\_roadmap.pdf](http://www.aspera-eu.org/images/stories/roadmap/aspera_roadmap.pdf)



Many happy physicists witnessing the LHC start-up in November 2009. At bottom left is Nikhef PhD student Ido Mussche.

## 2 Physics Programmes



Figure 2.1.1. Welding of magnet interconnections during LHC repair in 2009.

## 2.1 Accelerator-based particle physics

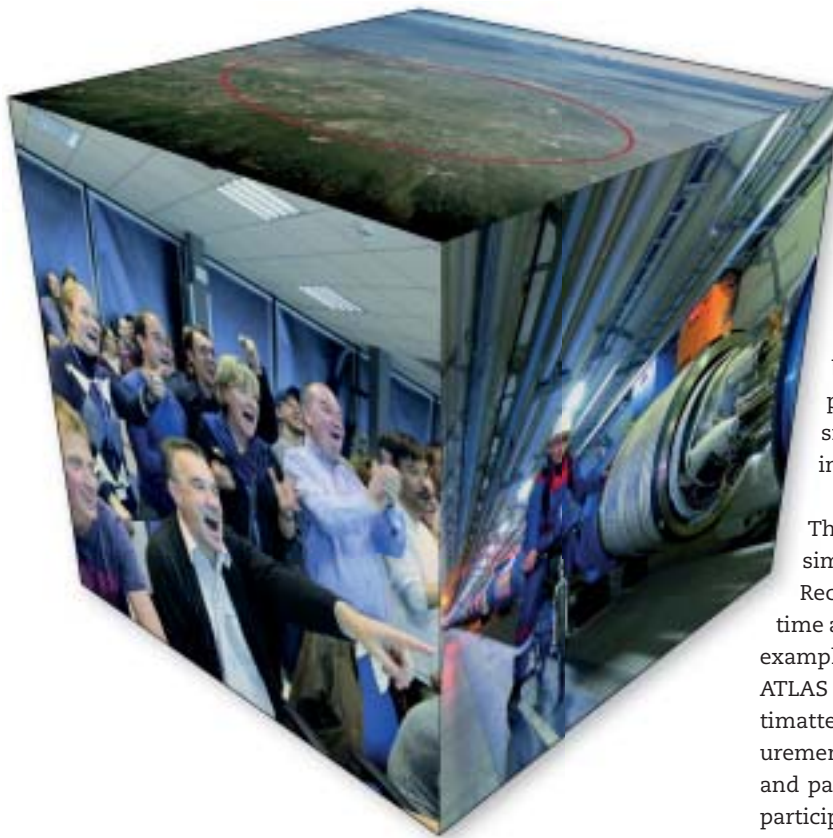

### LHC

The Large Hadron Collider (LHC) at CERN has become operational on 20 November 2009. Located in a tunnel 27 km in circumference (the former LEP ring), it boosts two beams of particles travelling in opposite directions to high energies, before they are made to collide with each other. On 30 November 2009, the LHC became the world's highest energy particle accelerator when protons in each beam reached an energy of 1.18 TeV. This exceeded the previous world record of 0.98 TeV, which had been held since 2001 by the Tevatron collider at the Fermi Laboratory in the U.S.

The energy density generated in a single LHC collision is similar to that existing a few instants after the Big Bang. Recreating such conditions provides a method to look back in time and find answers to fundamental questions concerning, for example, the origin of mass (searching for the Higgs particle at the ATLAS and CMS detectors), the balance between matter and antimatter in the Universe (at the LHCb experiment) and the measurement of conditions of the early Universe at high temperatures and particle densities (at the ALICE detector). Nikhef groups are participating in ATLAS, LHCb and ALICE, thereby covering the above mentioned research topics.

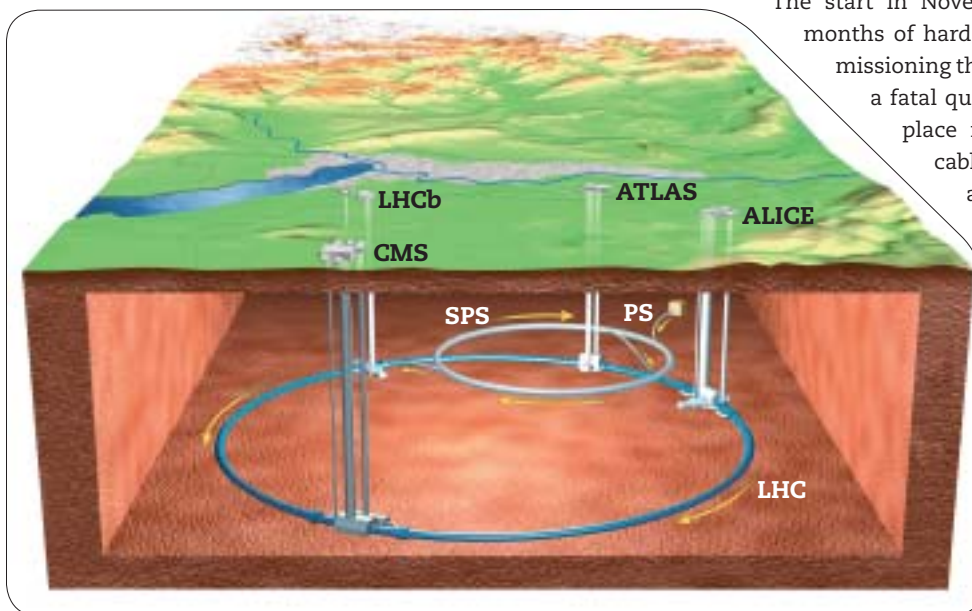

The start in November 2009 was the culmination of 14 months of hard work repairing, consolidating and commissioning the machine and preparing the beams after a fatal quench in September 2008. A quench takes place in a superconductor when part of the cable loses its superconducting properties and becomes resistive. The incident was caused by a resistance that exceeded the specifications in an interconnection between two sets of superconducting bus-bars (which convey the current from one magnet to the next). The bus-bar heated up, generating an electrical arc, which punctured the magnet's helium enclosure. The sudden increase in helium pressure caused most of the damage along 700 m of the machine. In early 2009, the 53 mechanically damaged magnets were removed from the tunnel and the repair work began. The last magnet was re-installed underground on 30 April and the last interconnection

Figure 2.1.2. The accelerator chain of LHC, with a Linear Accelerator for protons or ions, the Proton Synchrotron (PS) and the Super Proton Synchrotron (SPS). The locations of the four experiments (ALICE, ATLAS, CMS and LHCb) around the LHC-ring are indicated.

was restored on 17 June. 4800 m of beam pipe in the affected sectors were polluted with soot and debris and had to be cleaned in a major operation.

Having learned the lessons from the incident, the LHC teams developed and installed mechanical and electronic systems designed to make the machine more robust and reliable. A new quench detection system was installed together with a new system to detect abnormally high resistances.

The beam energy of the LHC is limited to 3.5 TeV in 2010 and 2011. The number of colliding particle bunches will increase gradually. Meanwhile the nominal intensity per bunch has been achieved. The total integrated luminosity is planned to be several  $\text{fb}^{-1}$  at the end of 2012. A long period of work on accelerator and detector systems has been planned for 2013 and 2014. For the experiments this stop means that subdetectors can be upgraded or completed, for the accelerator that upgrades of cavities, collimators and cryosystem can be implemented. After the necessary checks and repairs the beam energy is foreseen to be the design energy of 7 TeV in 2014.

### ILC and CLIC

The International Linear Collider (ILC) is a proposed linear electron-positron accelerator. It is planned to have a collision energy of 500 GeV initially, and, if approved, could be completed in the 2020s. A later upgrade to 1 TeV is possible. A host country for the accelerator has not been selected. At the end of the Technical Design Phase, planned for late 2012, a Technical Design Report (TDR) will be pub-

lished, which will document an integrated engineering design of the accelerator. This design should satisfy the energy, luminosity, and availability outlined in the earlier Reference Design Report of 2007, and should include a more complete and accurate costing estimate. It will also include thoughts on possible governance models for the International Linear Collider as an international research facility. It should demonstrate that the project can be built within the specified budget and that it can deliver the required performance. A decision to build the ILC can only be expected after the Higgs particle has been discovered with a mass within the range of the new accelerator.

Three detector-concept groups submitted letters of intent: the *International Large Detector* (ILD), the *Silicon Detector* (SiD) and the *4<sup>th</sup> Concept Detector* (4<sup>th</sup>). All three groups were composed of large international teams. Several Nikhef physicists have signed the ILD letter. Two concepts were accepted by the International Detector Advisory Group: the ILD and the SiD. These validated detectors will aim their efforts to complete the essential design and R&D by the end of the Technical Design Phase-II, which ends in 2012.

The competing CLIC project, a CERN-based worldwide collaboration, is investigating the possibility of building an electron-positron collider with a centre-of-mass energy of several TeV using a different accelerating technique. The aim is to present a feasibility study in 2011 and a Technical Design Report in 2016. With this in mind, CLIC's two-beam acceleration scheme is being tested in a special test facility at CERN. The acceleration scheme makes use of a drive beam that powers the accelerating structures. These ac-

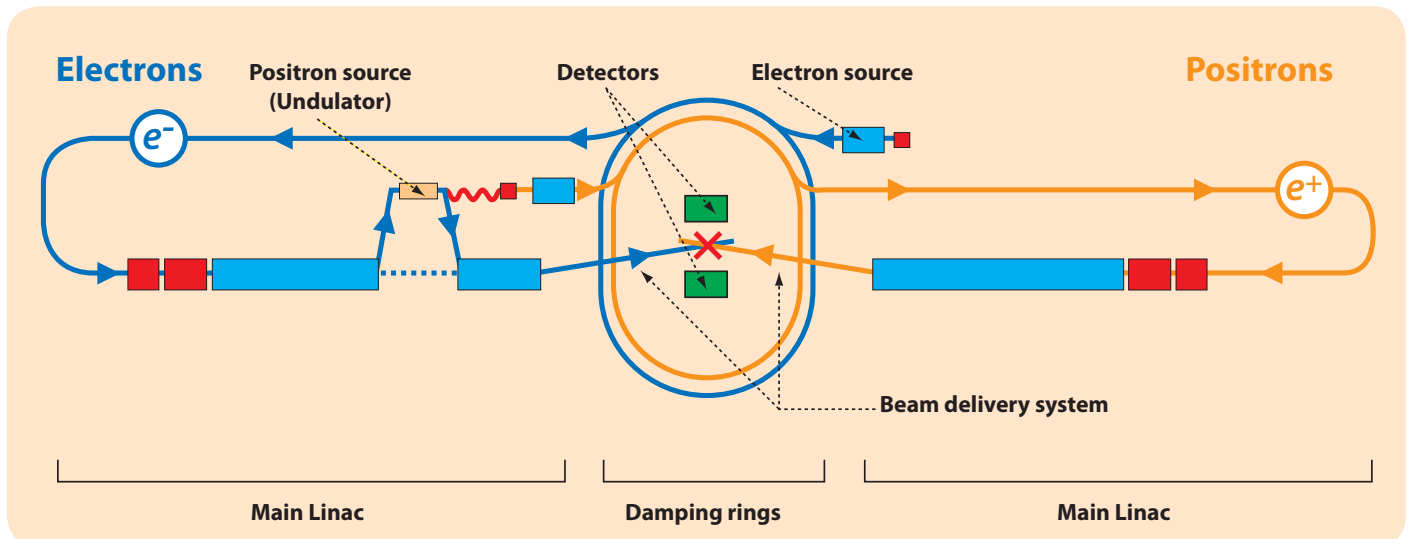

Figure 2.1.3. Proposed ILC with a total length of 31 km.

Figure 2.1.4.  
CLIC's two-beam test set-up  
at CERN.



celerate the main beam using very powerful fields of 100 MV/m. The production of the high-intensity, high-frequency drive beam is itself based on an innovative principle. In 2009, a drive beam with an intensity and frequency eight times greater than the initial beam, reaching 28 A and 12 GHz, was generated running at nominal performance. At the same time, the prototypes of the components that accelerate the main beam using the drive beam were successfully installed and tested. The next stage is to test the whole process in so-called two-beam modules, incorporating all of the individual components.

ILC and CLIC have started a close association on an official footing by signing a cooperation agreement. The collaborations' seven working groups, set up in 2009, have been working on common topics, thereby forming a single Linear Collider community. Studies on detectors for linear colliders at 1 TeV or more have begun, and a working group on this topic has been set up at CERN.

### Other accelerator developments

There is a large number of ambitious ongoing accelerator projects with promising features for the near and long term future. The requirements are usually extremely demanding requiring global collaboration to achieve the necessary innovation and R&D. Many studies are part of the EU Framework 7 programme.

The high-luminosity Large Hadron Collider upgrade (HL-LHC or sLHC) includes the upgrade of specific elements of the LHC accelerator, major upgrades in the accelerator injector complex, as well as upgrades to the two high-luminosity experiments ATLAS and CMS. It should result in a tenfold increase of the LHC luminosity. The purpose is for the sLHC to remain the most powerful particle accelerator in the world for at least two decades.

Another approach is to increase the energy of the LHC to 33 TeV (eLHC). This requires higher field dipoles in the ring making this option more difficult (and more expensive!) to achieve than the luminosity upgrade of the machine.

Other developments include studies for a lepton-hadron collider, by e.g. connecting a linear electron accelerator to the LHC ring (LheC), for B-factories in Japan or Italy and for a muon collider at Fermilab. At Nikhef there is for the moment no interest in such a lepton-hadron collider and just potential interest in B-factories in relation with the LHCb programme. Nikhef has a low-level involvement in the MICE muon beam cooling tests aimed at high intensity muon beams for high intensity neutrino beams and eventually a muon collider.

### LHC programme funding

FOM-Nikhef's LHC-staff physicists are funded from the long-term (structural) Nikhef mission budget. PhD students and postdocs, both essential for the proper exploitation of the LHC's discovery potential, are predominantly funded from matching (ATLAS, LHCb and ALICE) FOM-programme funds, each running typically for six years. In the 2013–2015 period (see Fig. 1.1.1) the ATLAS, LHCb and ALICE FOM-programmes run out. Starting directly after the NWO evaluation of Nikhef in 2007, Nikhef and FOM have discussed how to continue the LHC experiments without a major disruption of the annual FOM-programme call. This because the continuation of the ATLAS, LHCb and ALICE FOM-programmes until the end of the first phase of the LHC (2020) will require the sum of 18 M€. FOM has already started to reserve funds in anticipation of a Nikhef proposal for the continuation of its LHC programmes. Nikhef will submit its proposal early in 2013, i.e. directly after the completion of the 2011–2012 LHC run and after the approval of the update of the European strategy for particle physics by the end of 2012.

### LHC detector upgrade funding

Given the foreseen increase in the LHC peak luminosity and the degradation in LHC detector performance due to radiation damage, it is crucial to upgrade notably the central trackers and data-acquisition electronics of the LHC detectors. Several Nikhef physicists already play a prominent role in the coordination of

this process. Moreover, Nikhef's R&D department is working on several very promising and innovative design concepts (e.g. 'gossip'-based tracking with first level triggering capabilities and CO<sub>2</sub>-cooling). For the upgrade of the LHCb detector we certainly will be a key contributor. In ATLAS we will continue our strong contribution to the tracker and data-acquisition. For ALICE we want to take a leading role in the development of electronics for the new forward calorimeter. The detailed timescales of these projects depend on the exact LHC schedule. We anticipate the LHCb and ALICE upgrades around 2017-2018 and the major ATLAS central tracker upgrade somewhere in 2021-2022 (see Table 2.1.1).

Whereas detector R&D is relatively cheap and can often be financed from internal Nikhef funds and/or modest (EU) subsidies, real detector construction requires substantial investments. The Dutch government recently opened a dedicated budget line for the funding of large research infrastructures. Only projects listed on the Dutch national roadmap are eligible for funding. At this moment our priority is to get the upgrade of the LHC detectors, without differentiating between the three experiments we are involved in, on this roadmap. Once achieved we expect to apply for funding in 2013 or 2014. These funds also might include funding for the continuation of the Dutch LHC Tier-1.

	LHC Machine	Experiment upgrades
2011–2012	Run 1: 7 TeV centre of mass energy, luminosity ramping up to few $10^{33} \text{ cm}^{-2}\text{s}^{-1}$ , few $\text{fb}^{-1}$ delivered	
2013–Q2/2014	LHC shut-down to prepare machine for design energy and nominal luminosity	ATLAS: phase-0 (a.o. new pixel detector layer) LHCb: consolidation ALICE: detector completion
Q3/2014–2016	Run 2: Ramp up luminosity to nominal ( $10^{34} \text{ cm}^{-2}\text{s}^{-1}$ ), 50–100 $\text{fb}^{-1}$	
2017–Qx/2018	Injector and LHC phase-1 upgrades to ultimate luminosity	ATLAS: phase-1 (detectors for ultimate luminosity: muon chambers, trigger and data-acquisition) LHCb: full trigger upgrade, new vertex detector ALICE: new inner vertex system, forward detectors (part 1)
Qy/2018–2020	Run 3: Ramp-up luminosity to 2.2x nominal, reaching 100 $\text{fb}^{-1}$ /year; accumulate few hundred $\text{fb}^{-1}$	
2021–2022	LHC phase-2 upgrade: high-luminosity LHC. New focussing magnets and CRAB cavities for very high luminosity with levelling	ATLAS: phase-2 (new inner detector) ALICE: second vertex detector upgrade, forward detectors (part 2)
2023–2030	Run 4: collect data until >3000 $\text{fb}^{-1}$	

Table 2.1.1. Provisional LHC timeline (March 2011).



## 2.1.1 Physics at the TeV scale: ATLAS

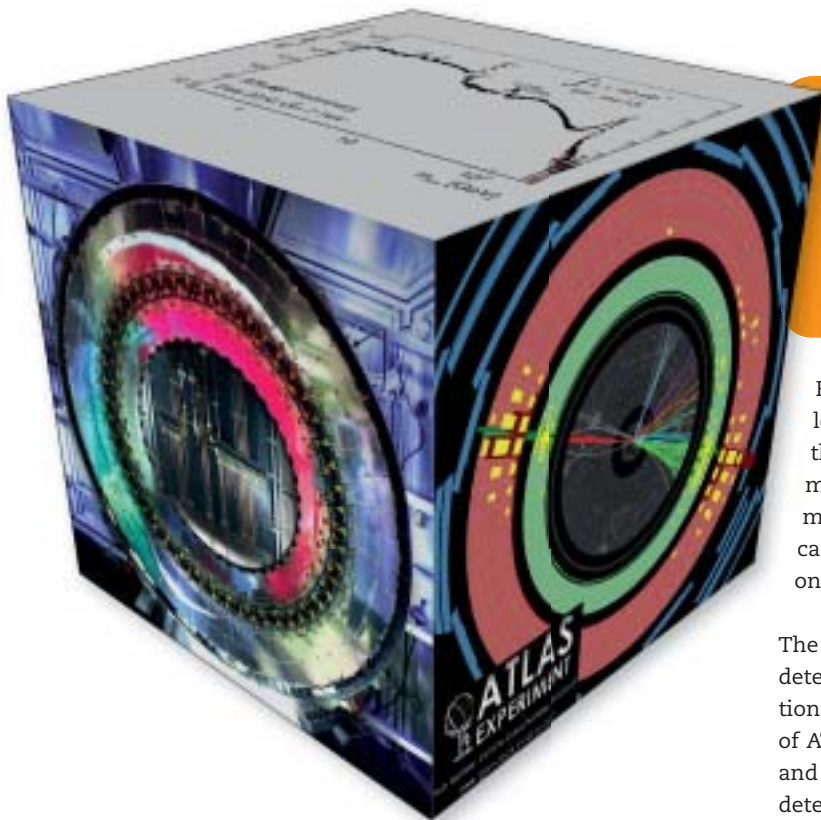

### Mission

To find and study the Higgs particle(s) responsible for the generation of mass. To search for physics beyond the Standard Model, such as supersymmetry, large extra space-time dimensions, or unexpected phenomena.

Furthermore, recent dramatic advances in cosmology have led to a new and surprising picture of our Universe, in which the majority of the energy in the Universe is contained in dark matter and dark energy. There are both theoretical and experimental reasons to assume that first answers to these questions can be found in experiments at an energy scale of the order of one TeV, or  $10^{12}$  eV.

The ATLAS collaboration has constructed a general-purpose detector, with excellent capabilities to study the physics questions mentioned above. Nikhef is one of the founding members of ATLAS. We have constructed large precision muon chambers, and we have assembled one complete section of the silicon strip detector (SCT). We have designed and produced muon read-out electronics, we are involved in alignment and monitoring, and we have designed and produced magnetic field sensors. Together with Dutch industries, we have delivered two huge superconducting toroidal magnet cryostats. We play a significant role in track reconstruction software, in trigger and computing operations and physics analysis, and we have provided technical assistance to the pixel detector construction and commissioning.

To gain experience in hadron collider physics analysis before the LHC started, and to profit from the opportunities at the Tevatron, a 2 TeV proton-antiproton collider at Fermilab (Chicago), Nikhef joined the  $D\bar{0}$  experiment in 1998. Since 2007 the Nikhef effort in  $D\bar{0}$  is decreasing. At present one PhD student is still active in  $D\bar{0}$  plus two staff members for a small fraction of their time. The Nikhef participation in  $D\bar{0}$  is foreseen to conclude effectively in 2012.

### LHC startup and running schedule.

The first 7 TeV collisions at the LHC were recorded in March 2010, and the 2010–2012 run is aimed towards collecting several  $\text{fb}^{-1}$  with an instantaneous luminosity in 2011 of about  $10^{33} \text{ cm}^{-2}\text{s}^{-1}$ . The commissioning of the ATLAS detector is progressing well, with Nikhef concentrating on operation of muon and SCT detectors, trigger, and tracking in muon system and inner detector. A rich physics programme has started, with strong Nikhef participation in t-quark detection, cross section and property measurements,

### Introduction

The formulation and experimental consolidation of the Standard Model of particle physics is one of the major scientific achievements of the past 40 years. Central to the Standard Model is the Higgs mechanism. Experimental data from LEP are consistent with a relatively light Higgs boson, in the 114–200 GeV mass range, and the Tevatron experiments are starting to exclude a Higgs boson mass around 160 GeV, but a reconstruction of a Higgs boson signal is so far lacking. Clearly, confirming the Higgs mechanism by finding the Higgs boson and studying its properties is important and, in a certain sense, the completion of the Standard Model.

However, the Standard Model is not a complete and definitive theory of all interactions of fundamental particles. We need to understand more about the deep origin of symmetry breaking (including the possibility of a more complicated Higgs sector), the gauge structure of forces, the family structure of quarks and leptons and the underlying symmetries, and quantum gravity. As potential answers to these questions, theoretical models have emerged: Grand Unified Theories (to extend Maxwell's unification to all gauge interactions), supersymmetry (to complete the set of mathematically allowed symmetries of space-time), extra space-time dimensions, and dynamical frameworks for electroweak symmetry breaking, such as technicolour and little Higgs models.

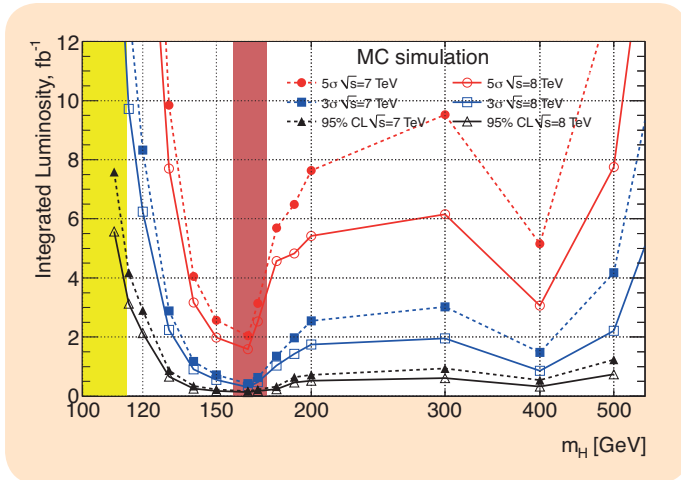

Figure 2.1.1.1. The luminosity required to give exclusion, evidence or discovery sensitivity for a Standard Model Higgs particle at beam energies of 3.5 and 4 TeV. The yellow band represents the LEP limit, the red band the Tevatron limit.

supersymmetry searches, and early physics measurements with muons to prepare for Higgs boson searches.

The LHC running plan for the next years is schematically shown in Table 2.1.1. In 2013, a 18-month shutdown is foreseen to start for LHC splice repair and magnet training. This will be used by ATLAS for detector consolidation and so-called Phase-0 upgrade. Further longer shutdowns are planned around 2017-2018, with a Phase-1 upgrade for ATLAS, and after 2020, with a larger Phase-2 upgrade for ATLAS to prepare for a High-Luminosity LHC (HL-LHC).

### 2013: Detector consolidation and Phase-0 upgrade

In 2013, ATLAS intends to complete the installation of the muon chambers, replace a part of the beam-pipe in the calorimeter endcap region, upgrade the trigger/DAQ system for higher luminosities, make modifications to the inner detector cooling system, and replace elements of the optical read-out system in pixel- and SCT detector. In this system, the VCSELs (Vertical Cavity Surface Emitting Laser) have shown a mortality rate beyond expectation. Possibly, the pixel detector will be taken out of ATLAS and brought to the surface for repair, and re-installed. Nikhef technical manpower is likely to be needed for the muon system, cooling upgrade, and optical read-out repair.

However, the main foreseen upgrade of ATLAS in Phase-0 will be the installation of the IBL, or insertable B-layer. To maintain

b-tagging capabilities when the inner layer of the current pixel detector will be affected by the accumulated radiation dose, the current beam-pipe will be replaced by a smaller-diameter beam-pipe, with silicon pixel sensors mounted on it. Nikhef is involved in the design and characterisation of the FE-I4 read-out chip, and in the detector cooling system.

Nikhef is a leading institute for research on thermal management of vertex detectors, and for the IBL we are participating in the thermal characterisation of CO<sub>2</sub>-cooled staves. We have developed and constructed a CO<sub>2</sub> test facility at Nikhef for this purpose. These activities are embedded in a project with a wider scope, namely to investigate the cooling of pixel detectors in general: to test solutions for cooling pipes; cooling blocks and assembly techniques; to optimise the material budget; and to measure heat transfer and compare to simulations.

### Preparations for the 2014-2016 physics run

The goal of the 2014–2016 run is to provide well over 10 fb<sup>-1</sup> at 13–14 TeV, with instantaneous luminosity well above 10<sup>33</sup> cm<sup>-2</sup>s<sup>-1</sup>. This is expected to be sufficient to be able to discover the Higgs boson over its full allowed mass range. If the Higgs boson is found, its properties will be studied to confirm its nature. Apart from sensitivity to the Higgs boson, the 2014–2016 run will have sensitivity to new physics beyond the Standard Model (BSM) in a large mass range.

The physics analysis plans of the Nikhef ATLAS group are a logical evolution from our activities in the 2010–2012 run. We foresee to remain prominently active in t-quark physics, notably in the measurement of t-quark production cross sections and t-quark properties. The emphasis in our t-quark activities will gradually shift towards looking for signs of ‘beyond the Standard Model’ physics in top production and decay; such contributions could come, for example, from the decay of supersymmetric partners of t-quarks, or from t-quark or W boson partners in Little Higgs models.

Our activities in understanding muon production in ATLAS will evolve from understanding inclusive prompt- and non-prompt production and production from resonance (J/ψ, Υ, Z) decays, and focus more on Higgs boson decay in WW and ZZ channels, and possibly also on associated WH and ZH production. We are also preparing for a study of WW scattering, which is extremely interesting in scenarios that a Higgs is found or no Higgs is found.

We foresee to remain active in searches for supersymmetry, concentrating on scenarios with R-parity conservation, leading to final states with energetic jets and missing transverse energy, and possibly isolated leptons. Our focus is on better data-driven

Figure 2.1.1.2. Candidate for a  $WZ \rightarrow e\nu\mu\mu$  decay, collected on 7 October 2010. The invariant mass of the two muons is 96 GeV. The transverse mass of the candidate W boson is 57 GeV.

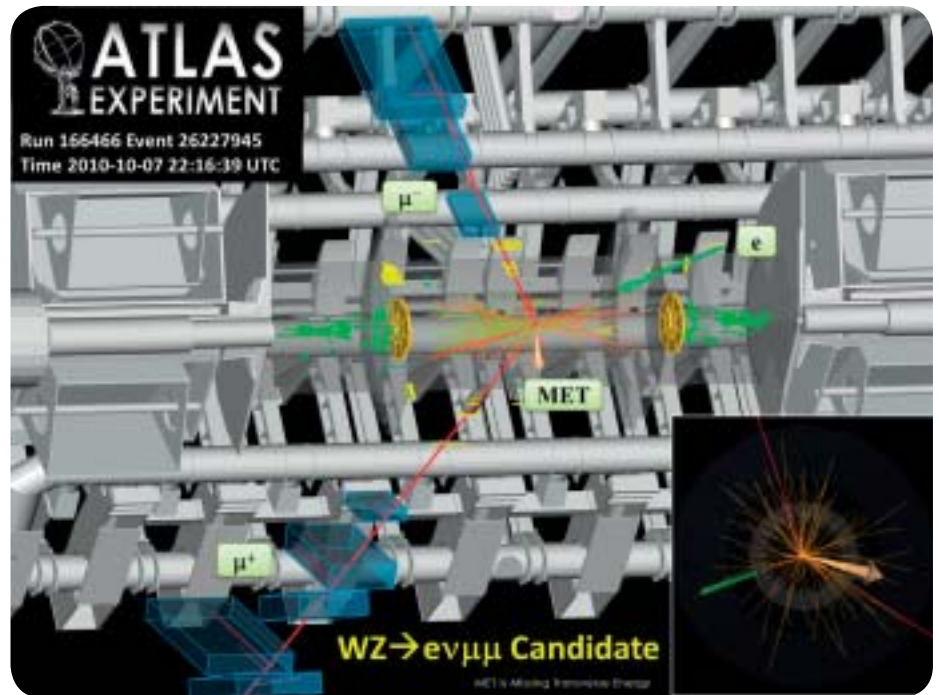

background determinations in the form of combined fits to multiple control regions, on a more general search strategy for non-standard particle spectra, and on supersymmetry searches with b-jets and  $\tau$ -leptons, possibly with lepton flavour violation. Since final states in supersymmetry analyses closely resemble t-quark production, there is a clear overlap with our t-quark analyses. Furthermore, good b-tagging and  $\tau$ -identification rely on good tracking, and through our SCT expertise we study and improve the tracking performance by looking at resonance reconstruction. Finally, we will keep an open mind to be able to shift our focus to wherever surprises in data may appear.

### 2017-2018: Phase-1 upgrade

After 2018, the LHC is expected to reach its full design luminosity of more than  $10^{34} \text{ cm}^{-2}\text{s}^{-1}$ . It is foreseen to upgrade a number of detector elements in ATLAS around 2017-2018, to be able to sustain the higher rates, but also to improve the trigger. For the muon system, the inner forward wheels (“small wheels”) will be replaced, the detector technology for this upgrade is yet to be decided. The new system will be important in keeping Level-1 trigger rates low, and in sharpening the trigger thresholds. Nikhef is interested in the read-out of this new system, which could be a prototype for a later Phase-2 system, and in the interface with the trigger system. Further elements of the Phase-1 upgrade include new calorimeter read-out and trigger electronics, a fast track trigger, and an extension of the trigger/DAQ system. A replacement of the whole pixel detector is being considered, this needs further study and any Nikhef involvement in this project is closely tied to our Phase-2 upgrade ambitions.

### R&D for a Phase-2 upgrade for the high-luminosity LHC

At the end of the decade ATLAS could have collected some  $300 \text{ fb}^{-1}$  of data. Any further exploitation of the LHC would need an order of magnitude more luminosity, and therefore the goal of the High-Luminosity LHC (HL-LHC) is to provide  $3000 \text{ fb}^{-1}$  before 2030, with an instantaneous luminosity above  $5 \times 10^{34} \text{ cm}^{-2}\text{s}^{-1}$ . The physics motivation lies mainly in measurements that are statistically limited. These include Higgs couplings to gauge bosons and fermions, Higgs self-couplings, rare Higgs, t- and b-quark decays and WW scattering. A tenfold luminosity increase provides a new physics discovery potential that is typically 30% larger in terms of new particle mass reach than at the nominal LHC.

A HL-LHC will require a significant upgrade of ATLAS. The inner detector must be replaced by a new detector that is more radiation hard, and finer segmented. Probably, new muon chambers in the forward direction are required. Calorimeter and muon read-out electronics, and the data acquisition system, must be upgraded.

At Nikhef we are focussing on the following projects:

- Continuation of the pixel cooling project for a much larger Phase-2 pixel detector upgrade, with characterisation of staves with various sensors, including Gossip (see below). Ultimately we are interested in designing a pixel endcap;
- Studies for an endcap strip detector with a petal design. We are investigating material choices, thermal behaviour, assembly methods and integration, and support structures. If an ATLAS Phase-2 upgrade is approved, we are interested in construction of one endcap at Nikhef;
- Gossip: a gas gain grid on a slimmed CMOS pixel detector, further explained in the R&D chapter of this document. This detector could be an accurate, thin, low-power and radiation-hard tracking detector. Furthermore, a single Gossip detector delivers track segments, not just hits, which has advantages for pattern recognition in high-luminosity environments, and is interesting for its use in the trigger. ATLAS-specific research includes interface to support and cooling, and performance in ATLAS via test-beam and simulation studies;
- For trigger and data-acquisition upgrades we are studying trigger strategy evolution, high-level trigger architecture, data flow optimisation, and detector read-out via optical links. We are also interested in a new Level-1 track trigger, and the evolution of the Level-1 muon trigger;
- We will further investigate what parts of the muon chamber hardware and read-out electronics will need to be upgraded.

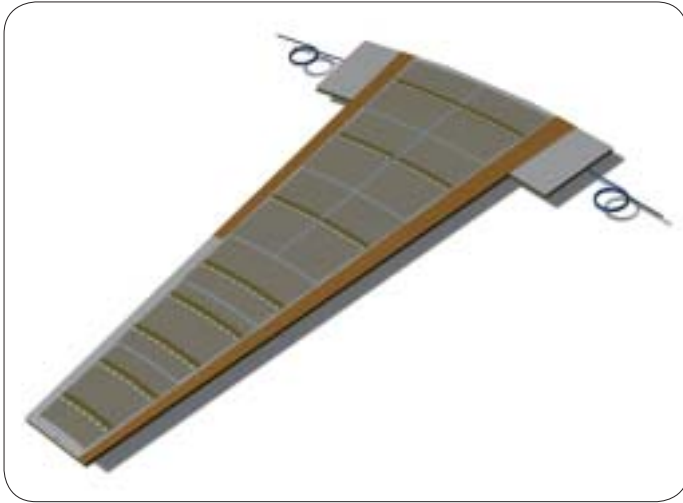

Figure 2.1.1.3. Design of ultra low-radiation length supports with integrated CO<sub>2</sub> cooling for an ATLAS Inner Detector upgrade.

### International position and ambition

The maximal exploitation of the TeV scale is widely regarded as the number one priority in particle physics worldwide. The European strategy for particle physics, as adopted by CERN council in 2006, explicitly lists LHC exploitation and R&D towards a luminosity upgrade, as number one scientific priority. In the U.S. the High Energy Physics Advisory Panel (HEPAP) is charged by DOE and NSF to provide a roadmap for particle physics. In the October 2006 report, HEPAP lists the study of the high energy frontier with LHC as its number one opportunity. Also ICFA, ECFA and ACFA, the international, European and Asian committees on future accelerators, share this prioritisation.

ATLAS is a collaboration of 174 institutions from 38 countries. Nikhef has the ambition to continue to have a leading role in ATLAS data taking and analysis and in R&D for upgrades. This ambition is reflected in the following facts. In Amsterdam, we have established a full-scale Tier-1 data analysis centre, NL/Tier-1, as part of the BiG Grid initiative. We take active leadership roles in ATLAS: Nikhef physicists are (or have recently been) top-quark physics group convener (W. Verkerke); supersymmetry physics group convener (P. de Jong); combined muon performance group convener (W. Liebig); computing operations coordinator and computing coordinator (K. Bos); detector upgrade coordinator (N. Hessey); trigger menu co-coordinator (O. Igonkina); and member of the speakers bureau (P. Ferrari). We foresee to keep playing such

roles in the future. The technical expertise of Nikhef is widely recognised in ATLAS, as proven by our work on muon chambers, the silicon strip detector, the pixel detector, the data acquisition system, and the detector control system (DCS).

### Knowledge transfer and partnerships

Outreach and education are important elements of the ATLAS experiment. We foresee to continue our activities of the past years: to organise and guide visits of individuals, high school classes and university students to CERN, write popular science articles and give lectures, and contribute to movies, videos and television programmes. In the context of European particle physics master classes, we organise such classes for high school students at Nikhef, and these will be using actual LHC data in the future.

### New Investments

The ATLAS FOM programme ends in 2015. In order to ensure our continuation in ATLAS physics analysis and upgrade R&D a new LHC physics programme is prepared (see Section 2.1. and Chapter 5). New investments are related to the activities for a detector upgrade. In the R&D phase these investments are still modest; they are included in the detector R&D chapter of this document or they are funded from the running budget. However, when we are going to produce detector components for an ATLAS upgrade at Nikhef, an investment grant proposal will be submitted (see Section 2.1 and Chapter 5).

### Personnel

ATLAS data analysis will be performed by physicists: PhD-students, postdocs and staff. These will be funded from the programme exploitation budget as well as from further project-oriented funding sources, such as FOM projectruimte, NWO grants (in the past years we were awarded one Rubicon, one Veni, two Vidi and two Vici-grants) and EU programmes (FP7/Marie Curie).

The R&D activities for a detector upgrade will be guided by six staff physicists (part-time), and will need technical support in the next years. During the shorter winter shutdowns, detector maintenance and repair must be performed; we expect to need four technicians for this during four months every year.

## 2.1.2 Physics with $b$ -quarks: LHCb



### Mission

To search for new particles and interactions that affect the observed matter-antimatter asymmetry in the Universe, by making precision measurements of B-meson decays.

Although such an asymmetry is established in the Standard Model, its effect falls many orders of magnitude short to explain the observed asymmetry: the current Standard-Model description of the weak interaction does not allow for enough asymmetry between quarks and antiquarks. Using B-meson decays as a laboratory, additional new complex interactions can be searched for. In addition, these new physics contributions can exhibit quantum-mechanical interference with the Standard-Model processes such that the nature of these new phenomena can be studied. Theoretical models motivated by supersymmetry and grand unification involve new particles which can have observable effects in various B decays. Especially the coupling between the third generation  $b$ -quark and the second generation  $s$ -quark is where these models predict observable effects. For instance, the existence of supersymmetric partners of quarks can modify the phase of the mixing diagram of the  $B_s$ -meson. The Nikhef group will focus in particular on this topic. The common element of the experimental effort of the Nikhef group is tracking; i.e. hardware as well as software development and analysis.

### Physics programme

Motivated by the experience gained at BaBar, the preparation for the analysis of LHCb data is predominantly aimed at the study of the transition between the heavy  $b$ -quark and the light  $s$ -quark. In this respect, LHCb has an advantage over BaBar: it has access to decays of the so-called  $B_s$ -meson, a bound state of a  $b$ - and  $s$ -quark. The planned research is focused on four ways to search for physics beyond the Standard Model.

First, we will determine the phase of the quantum mechanical amplitude that is responsible for the rapid oscillation of a  $B_s$ -meson into its anti-particle (and vice-versa) by measuring the time-dependent CP-asymmetry of the decay  $B_s \rightarrow J/\psi \phi$ . This asymmetry is a sensitive probe of the interference between the known Standard-Model contributions and additional, as yet unknown amplitudes.

Secondly, we plan to measure the CP-asymmetry between  $B_s$ -mesons decaying into final states  $D_s^\pm K^\mp$ . This measurement allows for a theoretically clean method to extract the value of the cur-

### Introduction

A complementary way to look for manifestations of physics beyond the Standard Model is to exploit the quantum nature of elementary particle physics. Particles that are (far) too massive to be directly produced can manifest themselves in quantum loops occurring in lower energy processes. A well known example of such an effect is the prediction of the mass of the heavy  $t$ -quark (in 1987 from the observation of  $B^0$ -mixing in the ARGUS experiment as well as from precision measurements of the Z-boson decay at LEP).

Due to the suppressed strength of the Standard-Model coupling between quarks of the second and third generation,  $b$ -quarks decay relatively slowly, and so-called virtual contributions from new particles can play a relatively large role. For example the decay rate of a B-meson into two muons is strongly suppressed in the Standard Model, but can be amplified due to the contribution of supersymmetric Higgs particles.

Since quantum interference of several processes can occur in B decays, the complex nature of coupling constants can be studied. The BaBar and Belle experiments have observed that the coupling constants of the weak force between quarks indeed have complex values; i.e. the interaction involves an irreducible complex phase. The presence of such a complex coupling constant is required in the early Universe to explain the observed asymmetry between

rently least-known CP-phase parameter in the Standard Model: the CKM angle  $\gamma$  (see Figure 2.1.2.3). Due to the fact that the  $B_s$  and anti- $B_s$ -mesons are predicted to decay with amplitudes of comparable size to the  $D_s^*K^*$  final states, a sizeable interference effect is expected leading to a precise determination of the amount of CP-violation.

Thirdly, we aim to observe the rare decay of a  $B_s$ -meson to two muons ( $B_s \rightarrow \mu^+\mu^-$ ). This decay, where the  $b$ -quark annihilates an  $s$ -quark, is almost forbidden in the Standard Model, but in various scenarios for ‘physics beyond the Standard Model’ it can be enhanced by an order of magnitude. In case supersymmetry plays a role, this decay can be mediated by a supersymmetric partner of the Higgs boson, and as a result the rate for this decay can be used to determine the ratio of the vacuum expectation values of this supersymmetric Higgs and the Standard-Model Higgs.

Finally, we will consider the transition of a  $b$ -quark into an  $s$ -quark, accompanied by the emission of two leptons. In this case, the angular distribution of the two leptons is a sensitive observable to the interference effects between the various intermediate particles contributing to this decay.

### Analysis

In the Nikhef LHCb group for every selected physics topic a small working group has been formed of one or two PhD students together with a postdoc and a staff member. The present topics are:

- $B_s \rightarrow J/\psi \phi$  with a first start on the analysis of  $B \rightarrow J/\psi K$ ;

- the angle  $\gamma$  from analysing  $B_s \rightarrow D_s^* K$  and  $B_s \rightarrow D_s^* \pi$  in the first year;
- rare decays studied with  $B_s \rightarrow \mu\mu$ , with a study of charm decays in the first year and
- $B \rightarrow K^* \mu\mu$  with additional charm studies in the first year.

With the theory department a project has started to overcome the barrier between theory and experiment in CP-violation analysis.

### Tasks and responsibilities

In practice, all our planned analyses at LHCb rely heavily on the reconstruction of charged-particle tracks from the decay of the heavy meson. This is the reason why the Nikhef group has been heavily involved in the design and construction of the tracking detectors of the LHCb experiment, the Outer Tracker (OT) and the Vertex Locator (VELO), and in the development of the software needed to reconstruct these particle tracks. As a result of this effort the group is currently well positioned to perform the planned measurements.

The Outer Tracker detector consists of 12 double layer planes of straw tubes with a detection surface of 28 m<sup>2</sup> in each plane. Previous worries about degradation of performance due to radiation have been removed after adding oxygen to the gas mixture. Nikhef is co-responsible for the maintenance of detector, electronics, alignment and calibration for the Outer Tracker.

The Vertex Locator measures the particle tracks in the region surrounding the interaction point. It serves to accurately measure the flight length of the B-mesons before they decay. The detector consists of 21 planes of silicon strip detectors arranged in an r-phi geometry. The Nikhef contributions comprise the vertex tank, housing the VELO and separating the primary beam pipe vacuum from secondary vacuum of the VELO environment, including a precise detector retraction system, a CO<sub>2</sub>-cooling system, and vacuum technology. The operation of the vertex tank under vacuum as well as the positioning mechanism have been fully commissioned. Also the cooling control system is now routinely operating. The responsibility for the control systems (apart from the cooling) has been transferred to the CERN safety group. The Nikhef group is co-responsible for the running of the VELO detector.

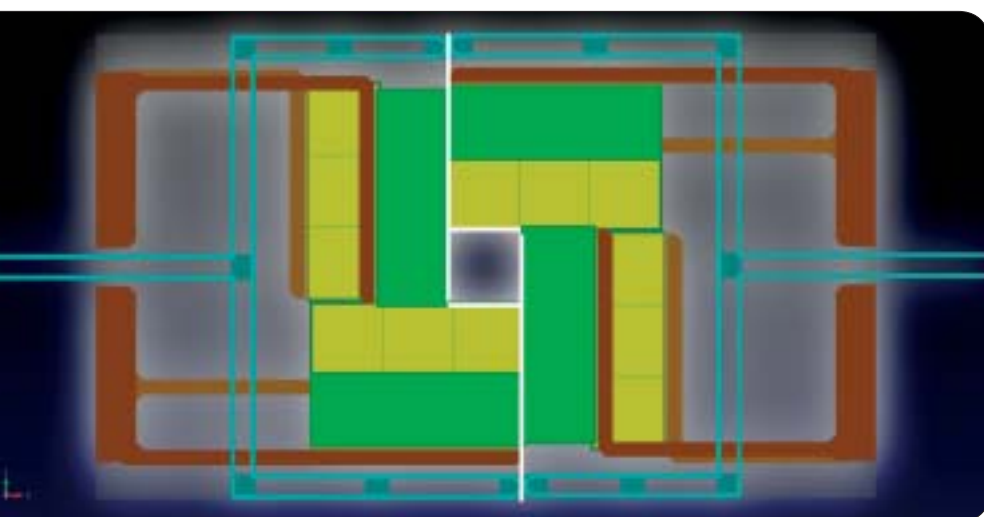

Figure 2.1.2.1. Design of VELO modules for the upgrade. Two hybrids are shown, opening to the left and right around the beam pipe. Tile pixel sensors are mounted to the front (yellow) of a diamond substrate or to the back (green). CO<sub>2</sub> cooling pipes are indicated in blue.

Figure 2.1.2.2.  
The Beauty 2011  
Conference, organised  
by Nikhef at Felix  
Meritis, Amsterdam;  
discussing a.o. the  
first results of the  
successful LHC runs  
in 2010.



The trigger is a key element in collecting relevant data of the experiment. Nikhef people play a leading role in the design, configuration and implementation of the higher-level trigger running on a large computing farm. The task also comprises checking of the results and evaluating the correct behaviour, in relation to the particular requirements of the physics groups.

The hardware responsibilities are reflected in a software effort as Nikhef contributes to the charged-particle track reconstruction, both in pattern recognition, track alignment and in track fitting.

The Nikhef PhD students also perform service tasks for the experiment as a whole by running general and subdetector specific shifts and in analysing and calibrating detector data together with staff members.

### **Long term prospects: detector upgrade and new B-factories**

Running the LHCb experiment under the same beam conditions for more than 5 years with a total luminosity reaching  $10 \text{ fb}^{-1}$  without an upgrade will be less profitable, since by running at constant peak luminosity the statistical precision on the measurements improves just slowly. An upgrade of the detectors and trigger is then neces-

sary, such that LHCb can operate at about a factor of ten above the original design luminosity, i.e. at about  $2 \times 10^{33} \text{ cm}^{-2}\text{s}^{-1}$ . The present hadron trigger is a limiting factor and therefore the experiment should be able to run without. A read-out speed of 40 MHz and a trigger searching directly for detached vertices by processing the VELO data in the first trigger level are then necessary ingredients.

So, all read-out should be upgraded to be able to run at 40 MHz, the Vertex Locator (VELO) detector should be replaced and the other detectors should be able to run at a higher luminosity without serious degradation due to radiation. This upgrade should take place in the 2017-2018 shutdown. The Nikhef group is studying the upgrade for the Outer Tracker electronics and is involved in the development of a read-out chip for a pixel design for the VELO. A modified version of the Timepix chip (VELOPix) is foreseen to be used for this purpose. The LHCb upgrade does not require the planned LHC luminosity upgrade (sLHC) since the LHC design luminosity is high enough at  $10^{34} \text{ cm}^{-2}\text{s}^{-1}$ . However it is compatible with and could operate at the sLHC.

Developments at KEK, Japan, where the present B-factory machine will be upgraded ('SuperKEKB') and at Frascati, Italy, where the SuperB facility has been recently approved, are interesting and will be fol-

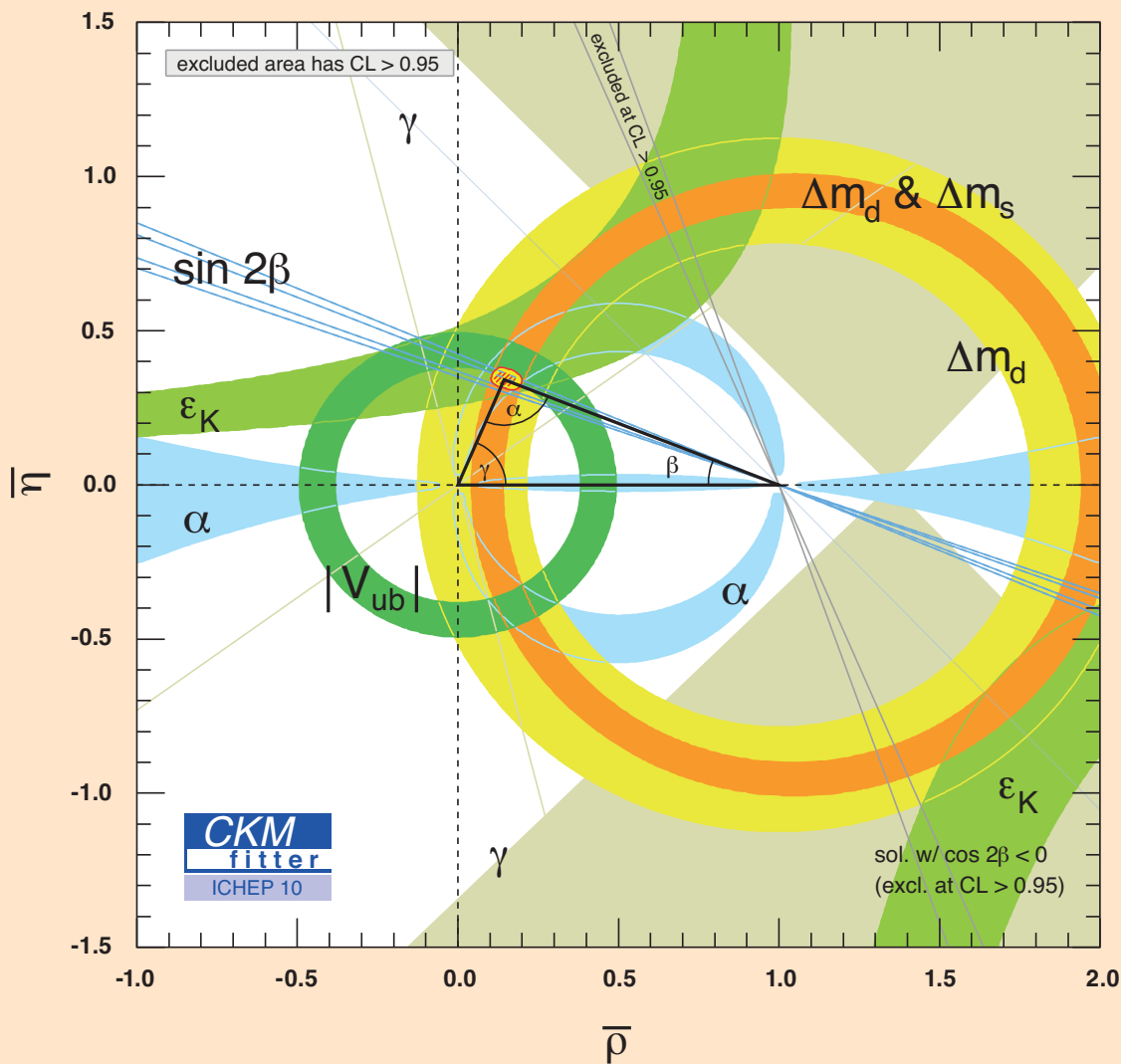

Figure 2.1.2.3. The Standard-Model predictions of many (independent) observables in B decays depend on two fundamental parameters, known as  $\bar{\rho}$  and  $\bar{\eta}$ , of the CKM matrix. This figure shows the constraints imposed on these two parameters by the latest set of measurements. With the current precision, all measurements are still compatible with one single point in the  $\bar{\rho}$ - $\bar{\eta}$  plane. A precision measurement of the angle  $\gamma$ , as will be performed by LHCb, could give indications for new physics beyond the Standard Model.

lowed closely. The experimental programmes will probably overlap with LHCb in time. The physics potentials are complementary.

### (Inter)national position and ambition

The LHCb collaboration consists of 54 institutes from 15 countries. The Nikhef group had a large responsibility in detector construction and still has in detector maintenance with project leadership of the Outer Tracker detector (A. Pellegrino) and deputy project leadership of the Vertex Locator detector (M. van Beuzekom). In addition, the group has the ambition to continue to play a leading role in the exploitation phase. For the data taking and analysis phase the Nikhef group is providing the deputy coordinator for the trigger project (G. Raven), the coordinator of one of the physics working groups (W. Hulsbergen) and of Operations (P. Koppenburg).

### Knowledge transfer

A novel cooling technique, based on the use of binary-phase CO<sub>2</sub> has been applied to keep the silicon sensors at a temperature below 0 °C. This technology was developed at Nikhef in cooperation with the National Aerospace Laboratory (NLR), and was presented at several international technology conferences. This technique is planned to be used by ATLAS as well as by other experiments.

The development of a thin aluminium corrugated RF-foil of 0.3 mm thickness to separate the Vertex Locator detector volume from the beam vacuum has initiated a PhD research project in cooperation with University Twente on the topic of superplastic deformation of lightweight metallic materials.

### New investments

The LHCb experiment is designed to operate with a luminosity of  $2 \times 10^{32} \text{ cm}^{-2} \text{ s}^{-1}$ . An upgrade of the experiment is foreseen at the time of the machine stop in 2017–2018. Continued participation of the Nikhef group (otherwise ending in 2014) in the upgraded LHCb experiment is part of the new Nikhef LHC physics programme proposal (see Section 2.1 and Chapter 5). Investments will be applied for together with the other Nikhef LHC programmes.

### Personnel

The exploitation of the LHCb experiment will be performed by physicists. PhD students, postdocs and staff physicists will ensure successful operation of the detector and will analyse the collected data. We foresee a stable level of scientific manpower, which currently includes 10 fte staff physicists, three postdocs and 12 PhD students. Funding for temporary scientific staff is both on a structural (FOM and VU) as well as on a project basis.



## 2.1.3 Relativistic heavy-ion physics: ALICE

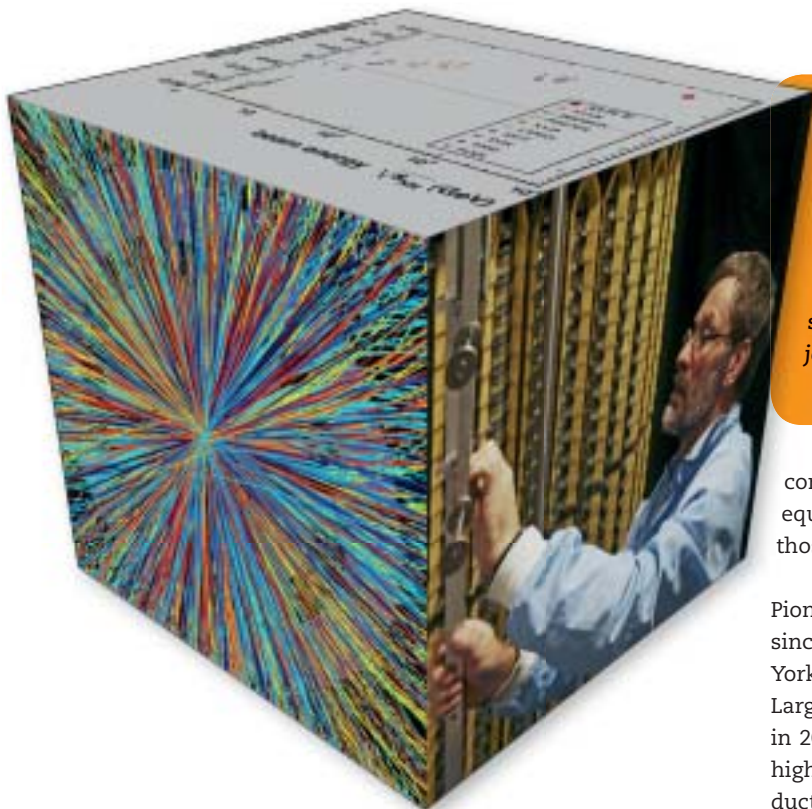

### Mission

To study the physics of strongly interacting matter at extreme energy densities, where the formation of a new phase of matter, the quark-gluon plasma, is expected. Particles and jets produced in collisions of heavy nuclei are measured in detail (in comparison with proton-proton collisions) and phenomena such as elliptic-flow and correlations of charmed hadrons or di-jets are studied.

compared to the interaction time scales to reach local thermal equilibrium and provide observable signals distinguishable from those originating from the later, cooler hadronic phase.

Pioneering experiments with heavy ions have been performed since 1986 at accelerators at CERN, Geneva, and BNL near New York, and first hints for this new state of matter were found. The Large Hadron Collider (LHC), where measurements have started in 2009, delivers heavy-ion beams of unprecedented energy. The higher beam energy will result in much more copious particle production, and the larger number of particles will make all measurements statistically more significant. In addition, it will lead to a much higher initial energy density and temperature of the system, and to significantly larger volume and lifetime. Heavy-ion collisions at the LHC are therefore presently by far the best laboratory to study the quark-gluon plasma.

Measurements are performed in the ALICE experiment at the LHC – it provides a versatile detector for heavy-ion reactions, allowing to study all relevant observables. It is equipped to study rare probes such as high-momentum hadrons, heavy quarks, jets and high-energy photons, and its particular strength lies in the combination of these special probes with excellent measurement capabilities of low momentum particles, which define the thermodynamic environment of the system.

### Physics programme

The Nikhef group studies the collective properties of hot and dense strongly interacting matter via the measurement of single-particle and multi-particle distributions, in particular of elliptic flow, jet-like particle production, and the production of heavy quarks. The main goals are to characterise the properties of the produced hot and dense matter via its equation of state and its colour charge density. This requires both measurements in heavy-ion collisions and, as a reference, in proton-proton collisions.

### Introduction

The theory of the strong force, quantum chromodynamics (QCD), provides a very good description of small-scale phenomena in collision experiments in high-energy physics. Phenomena at larger distances, most notably the confinement of quarks in hadrons and the spontaneous breaking of chiral symmetry, which set QCD apart from other interactions, are more difficult to treat. The theory in its numerical formulation has also been applied to such non-perturbative problems, in particular to thermodynamic systems of quarks and gluons under extreme conditions of temperature and/or density. At high temperatures a new phase of matter is expected to exist, in which quarks and gluons are no longer confined inside hadrons such as the proton. This new phase is known as the quark-gluon plasma (QGP). The study of this new phase will provide important insight into the strong interaction and its non-perturbative features. Cosmologists believe that all strongly interacting matter went through such a phase in the very early Universe, a fraction of a second after the start of its expansion (the Big Bang).

The experimental studies of these extremely dense and hot systems seek evidence for the QGP phase and are performed in collisions of heavy atomic nuclei accelerated to very high energies. In these collisions the colliding matter is heated to temperatures that should allow the creation of the QGP. However, the volume



Figure 2.1.3.1.  
Tracks in the ALICE detector from a Pb-Pb interaction at the first heavy-ion run of the LHC in 2010.

Measurements to be performed are:

- elliptic flow of a variety of identified particles as a function of momentum and collision centrality;
- the energy loss of partons via suppression of inclusive hadrons and correlations of hadron pairs and via the modification of jets, and
- heavy quark production via charmed and bottom hadron reconstruction and via their decay electrons, including the elliptic flow and energy loss of those particles carrying heavy flavour.

Elliptic flow is sensitive to pressure gradients in the initial state and thus probes the equation of state. Performing the measurement with identified hadrons provides important mass-dependent information, which constrains the fluid velocities in the final state. Jets and heavy quarks are produced in hard scatterings in the initial collision and probe the medium density as they propagate outwards.

In addition there is a growing interest in the Nikhef group in the physics of small Bjorken- $x$  partons. First such measurements have been performed in the STAR experiment with a strong participation from our group. The density of partons with small momentum fraction in protons and nuclei is important for the assessment of the initial state in hadronic collisions, however it is also of scientific interest in its own right, because qualitatively new behaviour is expected of dense gluon matter (strong gluon fields) at low  $x$ , sometimes referred to as the Colour Glass Condensate (CGC). A project has been started with the goal to explore the possibility of such measurements within the ALICE experiment in the future.

### Analysis

Currently ongoing are elliptic flow measurements of non-identified charged hadrons, which will very soon be extended to identified hadrons. With increasing statistics this will be developed further towards more differential measurements. As a first step for parton energy loss studies momentum distributions of hadrons are obtained. This is currently being done in proton-proton collisions

and will soon be extended Pb-Pb collisions. Also two-particle correlation measurements are under way. In the heavy flavour studies work concentrates now on the reconstruction of charmed mesons such as the  $D^*$ , and again the early effort is to demonstrate this measurement in proton-proton collisions. Analysis in Pb-Pb and other heavy flavour channels are obvious next steps.

For small- $x$  physics we perform Monte Carlo simulations to develop and optimise the design of a possible forward electromagnetic calorimeter (FoCal), that should allow to measure neutral pions and direct photons at rapidities which are currently not reachable in experiment.

### Tasks and responsibilities

The Nikhef ALICE group still shares the responsibility for the Silicon Strip Detector (SSD), the hardware contribution to ALICE, where we have played a leading role in design and construction. Particular attention will be paid to the performance of the detector and its electronics in the radiation environment of the experiment, in order to spot radiation damage as early as possible. The group will contribute to efforts to solve any such problems in the read-out electronics. However, so far the detector functions extremely well in general and only requires moderate attention.

### Longer term prospects

The main topics of the group, *elliptic flow*, *parton energy loss* and *heavy flavour*, provide an extensive physics programme for the next five years and beyond. After the early phase discussed above, more differential studies and measurements requiring a larger data sample will become important. A particular role will be played by analyses combining the different tools, which are already being studied in the group at present. This involves e.g. studies of various observables relative to the reaction plane as defined by elliptic flow, the correlation of charm with jets, all aspects of bottom quark production, and in general more sophisticated multi-particle correlations.

In addition, our group is the driving force behind the development of a forward calorimeter for ALICE to be installed possibly in 2017. This calorimeter will cover large (pseudo-)rapidities, i.e. small momentum fraction  $x$  of the involved quarks and gluons and to look for phenomena related to *gluon saturation*. Because the detector will have to measure photons and neutral pions of very high energy in a high particle density environment, its capabilities will have to go significantly beyond the state of the art. The detector will also enhance measurements in other areas, it will e.g. allow to study jet-like correlations at large rapidity difference or collective flow of direct photons.

### (Inter)national position and ambition

The Dutch activity in heavy-ion physics is relatively small, but its impact is larger than may be expected for a small country as the Netherlands. We have been able to achieve a significant visibility in ALICE, a collaboration of 115 institutes from 33 countries. One of our group members (G.J. Nooren) is project leader of one of the crucial detectors for ALICE, the SSD. Recent and present roles of scientists of the group include deputy spokesperson (P. Kuijer), members in the ALICE management board (R. Kamermans† until 2010, T. Peitzmann from 2011), in the editorial board (P. Kuijer) and conference committee (R. Kamermans† until 2010), coordinator of the particle identification taskforce (M. van Leeuwen), and upgrade coordinator (T. Peitzmann from 2011).

We intend to ensure and strengthen our position in the exploitation phase of the ALICE experiment. In particular one of our scientists (R. Snellings) has taken the leadership in the elliptic-flow analysis within ALICE, and we play a significant role in analysis related to parton energy loss (M. van Leeuwen) and heavy flavour production (A. Mischke), as apparent from the strong contribution to the first publications related to these topics.

The publication record of the group is extremely good both in comparison to groups in the same field and to other groups at Nikhef, as well as compared to other research groups in physics in the Netherlands. This can certainly be attributed to the high quality of the research, but is also due to an excellent scientific strategy, which has led to participation in high-profile research activities at the right moment. We intend to ensure and further strengthen our excellent position.

### New investments

The first heavy-ion collisions in LHC have been measured in the fall of 2010. Therefore even the baseline physics potential of the ALICE experiment will extend significantly beyond the duration of the current FOM programme, which is scheduled to terminate

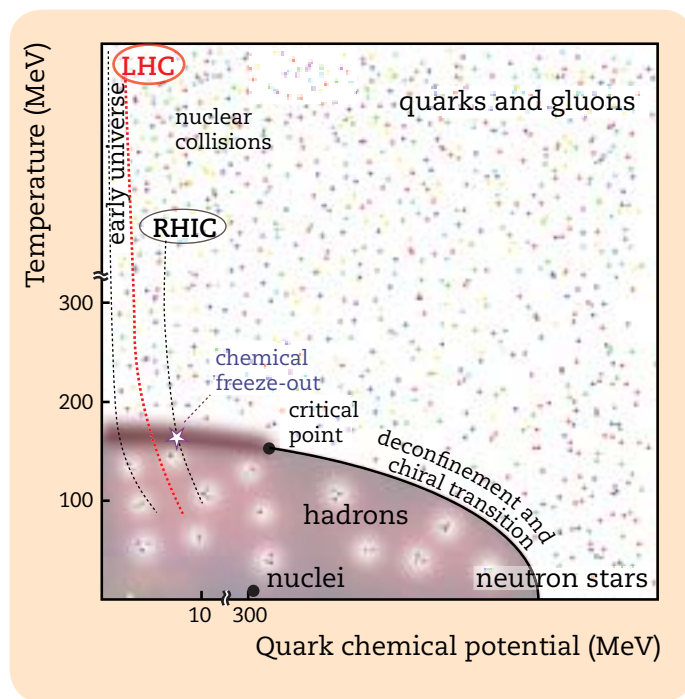

Figure 2.1.3.2. The QCD phase diagram as a function of temperature and quark chemical potential (related to net quark density). From recent theoretical calculations the transition between the quark-gluon-plasma phase and the hadronic phase is expected to be a first order transition for high density (solid line) and a transition without discontinuity at high temperature (dark band). The dashed lines indicate the trajectories the heavy-ion collider experiments at RHIC and LHC are exploring; at LHC the initial state already accesses much higher temperatures than at RHIC. The star is at the measured location of the state when hadrons are formed (chemical freeze-out) at RHIC.

in 2013. A continuation of the ALICE activities is part of the new Nikhef LHC program (see Section 2.1 and Chapter 5). A detector upgrade with a forward calorimeter provides a good opportunity for the Dutch ALICE contribution to play a major role in small- $x$  physics. A significant contribution would however require a major investment contribution for the production of that sub-detector. Also this will be part of a combined Nikhef LHC investment proposal.

### Personnel

The programme currently consists of eight fte permanent staff scientists, one postdoc, 11 PhD students and three fte technicians stationed at Nikhef and at Utrecht University. Positions are also funded from incidental funds like the FOM 'projectruimte' or recently acquired NWO Vidi (3) and ERC (1) grants. We envisage a continuation on a similar scale.

## 2.2 Astroparticle physics

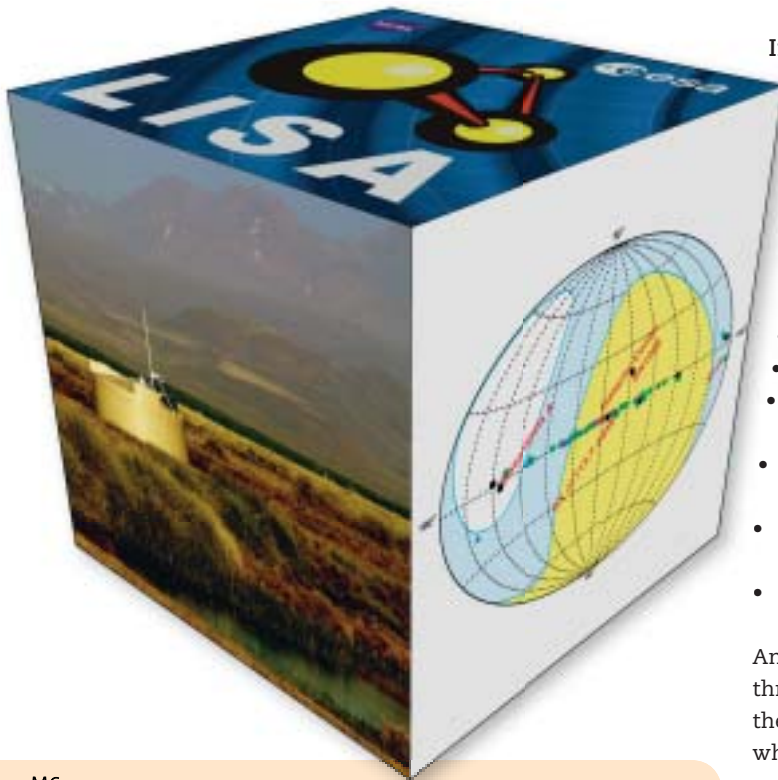

### Introduction

Astroparticle physics is a rapidly evolving interdisciplinary research domain at the interface of particle physics, astrophysics and cosmology. This field of research is addressing a number of issues that may revolutionise our scientific view of the Universe. The general objectives of astroparticle physics are best summarised by listing the six basic research questions from the European Astroparticle Physics Strategy document (September 2008):

- What is the Universe made of? In particular: What is dark matter?
- Do protons have a finite lifetime?
- What are the properties of neutrinos? What is their role in cosmic evolution?
- What do neutrinos tell us about the interior of the Sun and Earth, and about supernova explosions?
- What is the origin of cosmic rays? What is the view of the sky at extreme energies?
- What will gravitational waves tell us about violent cosmic processes and about the nature of gravity?

An answer to any of these questions would mark a major breakthrough in our understanding of the Universe. To investigate these questions, novel experimental techniques are needed which typically combine techniques developed in particle physics and astronomy. Examples include the development of neutrino telescopes, high-energy cosmic ray observatories, ground and satellite-based Cosmic Microwave Background Radiation observatories and gravitational wave detectors. These detectors allow the exploration of new phenomena in the Universe, which – in some cases – give access to energy domains well beyond those being probed by human-made particle accelerators.

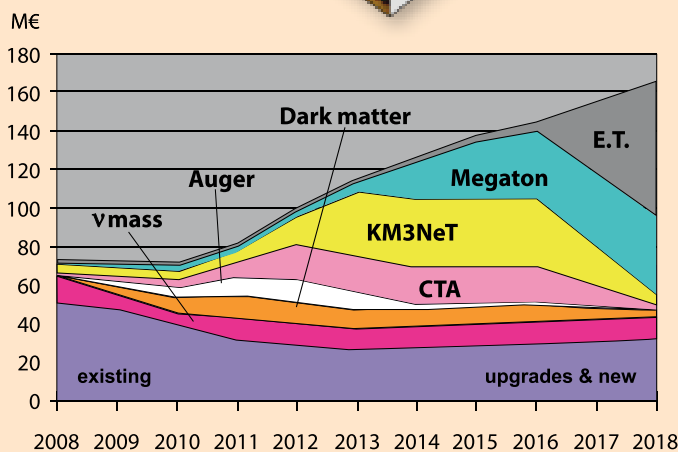

Figure 2.2.1. Funding scenario for seven selected astroparticle physics projects in the 2008 European Roadmap for Astroparticle Physics: CTA (array of Cherenkov Telescopes for detection of cosmic high-energy gamma rays); KM3NeT (cubic kilometre-scale neutrino telescope in the Mediterranean Sea); ton-scale detector for dark matter search; ton-scale detector to study the fundamental nature and mass of neutrinos; Megaton-scale detector for proton decay; neutrino astrophysics & investigation of neutrino properties; large array for the detection of charged cosmic rays and the Einstein Telescope (third-generation underground gravitational antenna).

### Recent history

A big step towards establishing astroparticle physics as a new research field in the Netherlands was taken in the year 2001 with the dual approval of a FOM programme and an NWO investment proposal for the development of a prototype high-energy neutrino telescope in the Mediterranean Sea. These efforts resulted – within the framework of the European ANTARES collaboration – in the largest neutrino observatory in the Northern Hemisphere.

Nationally, astroparticle physics started emerging as a distinct research community since about 2004. During that year, Nikhef physicists took the initiative to organise a series of national symposia, still ongoing, discussing astroparticle physics research in the Netherlands. At about the same time, the Committee for Astroparticle Physics in the Netherlands (CAN) was established with participation of four research institutes (ASTRON, KVI, Nikhef and SRON) and six university groups (based in Amsterdam,

Figure 2.2.2. GRAPPA (Gravitational AstroParticle Physics Amsterdam) is a collaboration between the Astronomical Institute Anton Pannekoek, the Institute for Theoretical Physics and the UvA-groups within Nikhef (IHEF) with the intention to create a central, focused research centre.

Groningen, Leiden, Nijmegen and Utrecht). CAN published a “Strategic Plan for Astroparticle Physics in the Netherlands” in 2005, which guided many of the astroparticle physics initiatives in the past five years.

The first step in the realisation of the Strategic Plan was for Nikhef, KVI and (the astronomy group of) the Radboud University Nijmegen to formally join the Pierre Auger Observatory (PAO) in Argentina in 2005. Europe-wide preparations for the next-generation deep-sea neutrino telescopes were initiated in 2006, with the formation of the KM3NeT collaboration. The goal of this design study, supported under the 6<sup>th</sup> EU framework programme, was to arrive at a cost-effective design of a deep-sea neutrino telescope in the Mediterranean Sea that surpasses ANTARES by a factor of 20 or more in effective volume. Nikhef is an important participant in the KM3NeT design study.

The Dutch astroparticle physics research was further expanded in 2007, when Nikhef joined the Virgo gravitational wave interferometer. In that same year, the KM3NeT project obtained additional EU funds by appearing on the list of recommended facilities prepared by the European Forum for Research Infrastructures (ESFRI). The scientific exploitation of ANTARES and PAO for the period 2008–2013 was secured by the approval of a joint FOM research programme, “The origin of cosmic rays” with a budget of 3.4 M€.

Investments funds for KM3NeT were acquired in 2008. SenterNovem, an agency of the Dutch Ministry of Economic Affairs, awarded 8.8 M€ for the proposal “The next-generation neutrino telescope: KM3NeT”. In addition, 0.45 M€ was obtained for the KM3NeT Preparatory Phase Study under the 7<sup>th</sup> EU framework programme. The gravitational research programme was secured in 2009 with the approval of the “Gravitational physics – the dynamics of spacetime” FOM programme. The award was 2.9 M€ for the period 2010–2015.

Finally, after establishing the long-term prospects of the initial suite of astroparticle physics programmes, Nikhef joined the XENON direct detection of dark matter effort in 2010. An initial investment of 0.5 M€ is being financed from the Nikhef mission budget. A FOM programme proposal has been submitted.

### Longer term prospects

Given the strategic choices made by the astroparticle physics community in the Netherlands in the past five years, the outline of future research plans is clear. In all cases, i.e. for neutrino telescopes, air shower arrays, gravitational wave and dark matter detectors, a recently built observatory is being exploited, while

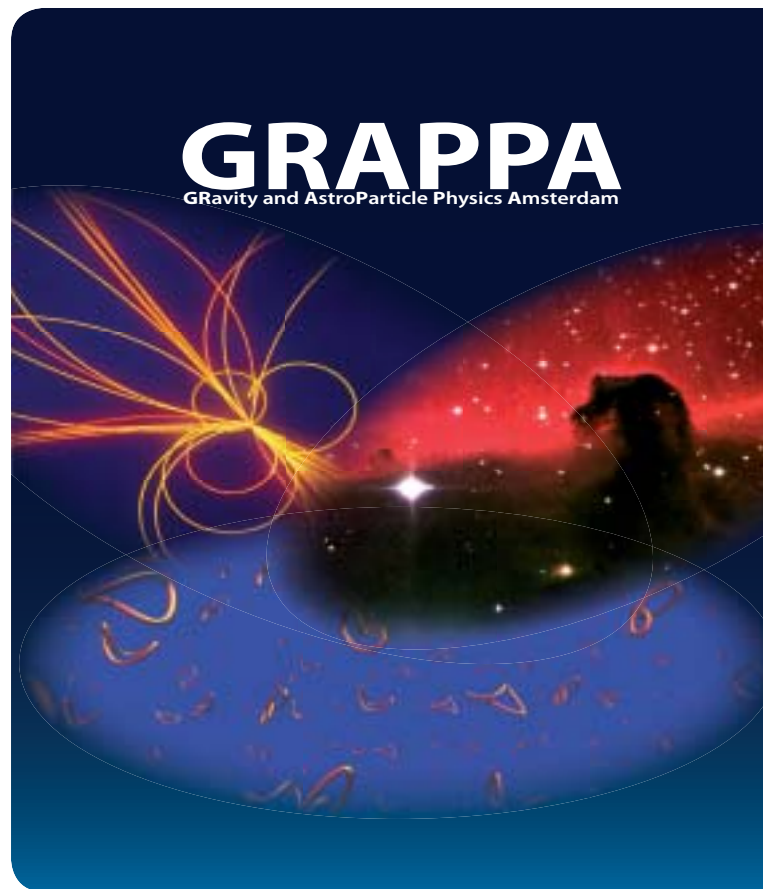

–at the same time– development and engineering work is carried out for future observatories, significantly expanding the scientific reach in each of these areas. The various plans are discussed in more detail in the next four subsections.

### (Inter)national position

A network between European funding agencies supporting astroparticle physics research was established in 2006. This network, called ASPERA, initially received support as an ERA-NET activity in the 6<sup>th</sup> EU framework programme and has been extended for another three-year period under the 7<sup>th</sup> EU framework programme. The Netherlands is represented in ASPERA by providing a member in the Science Advisory Committee (P.Kooijman) and a member of the Governing Board (F. Linde).

The Netherlands is also represented in the steering and science advisory committees of the Astroparticle Physics European Collaboration (ApPEC) committee (F. Linde and J. de Kleuver). Nikhef will continue to play an active role in the expanding astroparticle physics research at the European level, of particular importance for the realisation of large European infrastructure projects such as KM3NeT.

Astroparticle physics research will provide an enduring contribution to all stages of the multidisciplinary education of scientists and engineers. This is probably best illustrated by the prize-winning HiSPARC outreach project, which enables secondary-school students to build their own cosmic-ray air shower array.

## 2.2.1 Neutrino telescopes: ANTARES and KM3NeT



### Mission

To discover neutrino sources in the Universe. The observation of cosmic neutrinos will provide information about the origin of cosmic rays, the mechanism of particle acceleration and transient astrophysical phenomena.

### Introduction

Ever since Markov discussed the possibility of detecting cosmic neutrinos using the Cherenkov effect in sea water, many experimental groups have attempted to perform such an experiment. The DUMAND collaboration pioneered the technique in an experiment off the coast of Hawaii. This was followed by the Baikal collaboration that built the first full detector in the fresh water of Lake Baikal. Since then, the AMANDA and IceCube collaborations have installed and operated sequentially a prototype and a cubic kilometre neutrino detector in the ice of Antarctica. More recently several collaborations have begun to investigate the Mediterranean Sea as a place to install a neutrino detector. A neutrino telescope in the Mediterranean Sea complements the sky coverage of the IceCube detector and it is ideally situated to search for neutrino sources near the galactic centre. The very large scattering length of the Mediterranean seawater allows the telescope a pointing accuracy expected to be better than  $0.1^\circ$  at neutrino energies of 10 TeV and above.

### Physics programme

The collaboration searches for neutrino sources in the sky. Evidence for the existence of cosmic neutrinos is also sought by looking for an excess of events in the energy spectrum of neutrinos. A direct search for the origin of cosmic rays is made correlating ANTARES and Pierre Auger Observatory (PAO) data. Transient

phenomena in the Universe are studied correlating ANTARES data with gamma-ray bursts. A first analysis of the ANTARES data taken in the period 2007–2008 has been made. The search for neutrino point sources will be enhanced when more analysed data becomes available. A boost for the search for cosmic neutrinos and the discovery of astrophysical sources will be given by the construction of the KM3NeT detector.

### Tasks and responsibilities

The group continues to carry the responsibility for the operation of the data acquisition system of the ANTARES detector. Some maintenance is provided for the repair of detector elements and upgrades of the soft- and hardware in the shore station. The group also is a leading contributor to the design, prototyping, and construction of the KM3NeT detector.

### Longer term prospects

Since the completion of the ANTARES detector in 2008, data are taken routinely, 24 hours per day and 365 days per year. Several maintenance operations have been performed in the meantime to keep the average operating efficiency of the detector at the 90% level. A memorandum of understanding for the operation of the ANTARES detector for the five years to come (followed by a possible decommissioning) is in preparation. This memorandum will also state how the ANTARES data will be made public and will formalise the (already active) collaboration with other groups, including IceCube, Virgo, PAO, ROTSE and TAROT.

In 2006, a design study (EU FP6) was initiated by a joint venture of the ANTARES, NEMO and NESTOR groups for a cubic kilometre scale neutrino detector in the Mediterranean Sea. This study has culminated in a Technical Design Report. The main conclusion is that for a total cost of about 220 M€, a detector with 50 times the sensitivity of ANTARES and about five times the sensitivity of IceCube can be realised. In 2009, a preparatory phase study (EU FP7) has started that should be completed in 2012. A result of the two studies is that a large European consortium has been formed, known as KM3NeT, with the ambition to build the most sensitive neutrino telescope in the world.

## Cosmic neutrinos

The only cosmic neutrinos that have been detected so far are neutrinos from the Sun and from the supernova SN1987a. These neutrinos have energies of the order of a few MeV. The angular resolution of a neutrino telescope is limited for those energies to about  $10^\circ$ . With the advent of a new generation of neutrino telescopes, the study of high-energy cosmic neutrinos with an angular resolution of  $0.1^\circ$  becomes possible. This would allow a detailed position identification of neutrino sources on the sky and an accurate correlation with observations from other instruments.

In Europe, the realisation of this perspective started with the successful commissioning and operation of a prototype detector by the ANTARES collaboration. With the next step, KM3NeT, the most sensitive neutrino telescope in the world will be built. KM3NeT makes it possible to confirm or reject the hadronic origin of high-energy gamma rays from supernova remnants in a short data-taking period of 2–3 years. Studies are on going to extend the sensitivity of the KM3NeT neutrino telescope to indirect dark matter detection at low energy and neutrinos due to the GZK cutoff at very high energy. Preliminary results indicate that -within the foreseen live time of the experiment- several neutrinos from the GZK cutoff can be detected unambiguously. It is also possible to build a smaller but much denser detector inside KM3NeT to enhance significantly the sensitivity for low-energy neutrinos, e.g. those from neutralino annihilation in the Sun.

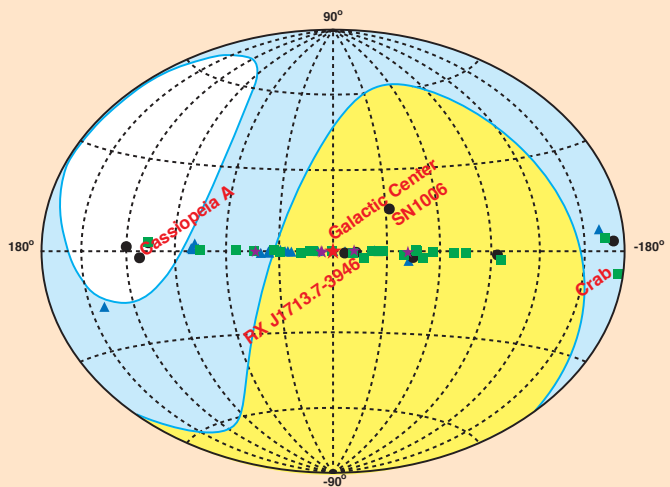

Fig. 2.2.1.1. Sky map of the field of view of KM3NeT (yellow and blue) and IceCube (blue and white) in galactic coordinates. The most promising candidate neutrino sources are indicated: shell-type SNR (black), molecular cloud (purple), pulsar wind nebula (green) and unidentified TeV gamma-ray sources (dark blue). As an example, three years of operation of the KM3NeT neutrino telescope will yield a  $3\sigma$  signal from RXJ1713.

## (Inter-)national position and ambition

The Netherlands participate strongly in ANTARES (Nikhef provides two members of the steering committee) and KM3NeT (Nikhef coordinates three work packages and provided the main editor of the technical design report). The data-acquisition concept ('All-data-to-shore') has become a general standard. Nikhef is leading the development of the high-bandwidth data transmission system for KM3NeT. The deep-sea power system developed by Dutch industry under supervision of Nikhef is also under consideration. Nikhef has introduced a new design of the optical module. Previously, the approach to Cherenkov light detection was based on the use of the largest possible photo-multiplier tube that can be housed in a pressure resistant glass sphere. The alternative put forward by the Nikhef group consists of putting many small ( $3''$ ) photo-multiplier tubes inside the same glass sphere. This will not only maximise the total photo-cathode area in a single sphere; it improves photon counting purity at the same time. The classical approach relies on the accurate integration and digitisation of a slow analogue pulse, whereas the new approach makes use of discrete photon detection (after all, a photon is a single quantum and hence digital by nature). The initial lack of experience with deep-sea deployment technology has been compensated by collaboration with NIOZ, the Dutch institute for oceanographic research. As a result, a complete design of a detection unit has been worked out and several deployment tests have been made at the end of 2009 and the beginning of 2011.

For doing astronomy with a neutrino telescope, the analysis software developed by Nikhef is shown to yield the best performance, i.e. the highest neutrino detection efficiency and the best angular resolution. For ANTARES, the angular resolution reached at present is  $0.4^\circ$ . This may improve with further calibration of the detector and tuning of the parameters in the analysis, evidencing already now the superior angular resolution that can be obtained with seawater compared to ice. For KM3NeT, the angular resolution is expected to be  $0.05^\circ$ .

## Knowledge transfer

The (Dutch) industry is involved, amongst other things, in the development of deep-sea cables, DC-DC power convertors, fibre optics, and feedthroughs for KM3NeT. As an example, Nikhef has developed a high voltage circuit for photo-multiplier tubes that consumes ten times less power than the current world's best. Various companies have shown interest in this technology. Furthermore, the IceCube collaboration has shown interest in the new design of the optical module for the envisaged upgrade of its detector towards a more efficient detection of low energy neutrinos. Through KM3NeT, Nikhef also contributes to the 'White

Rabbit' project that will bring a new standard in data transmission and sub-nanosecond timing to life.

### International context

KM3NeT is a large international effort with a challenging and compelling objective: The discovery of neutrino sources in the Universe. It has grown out of several preparatory projects in the Mediterranean Sea, most notably the ANTARES experiment of which Nikhef is a long-standing member. The consortium has designed and is planning to build a neutrino telescope of such a size and positioned in such a location that the detection of Galactic sources of neutrinos is a distinct probability.

Nikhef is one of the co-founders of KM3NeT and has contributed several cost-effective design innovations which have been adopted in the final technical solution for the telescope. The total cost of the infrastructure is estimated at 220 M€. This sizeable amount requires contributions from regional, national, and European funds. The currently secured funds are insufficient for the immediate start of construction. However, proposals are being submitted in France, Greece and Italy to acquire funding out of the European FP7 structural funds for regional development in addition to national funds. These proposals bring about a distributed neutrino-telescope network based on a common technology. If successful, half of the required funding will be in place by the end of 2012. In anticipation of this, the first steps are taken towards a legal framework by establishing KM3NeT as a European Research Infrastructure Consortium (ERIC).

In March of 2010, the Administrative Standing Committee (ASC) was installed. It consists of representatives from all funding agencies and it is chaired by F. Linde. The ASC stimulated the technical convergence, embraced the solution of a distributed neutrino-telescope network and encourages the establishment of an ERIC. Recently, the ASC instated the Scientific Standing Committee, chaired by G. Bellettini.

In the direction of a world-wide organisation of the neutrino telescope community ("Global Neutrino Observatory") joint meetings of the ANTARES and IceCube collaborations are held once a year, to which KM3NeT members are invited. In addition, a workshop on possible upgrades of the IceCube detector was held at Nikhef in spring 2011. Nikhef is also the initiator of the bi-annual series of workshops on very large volume neutrino telescopes (VLVVT).

Today, the technical design has converged, the legal framework of the consortium is imminent and the funds to start the construction are anticipated. The real scientific promise is in the realm of

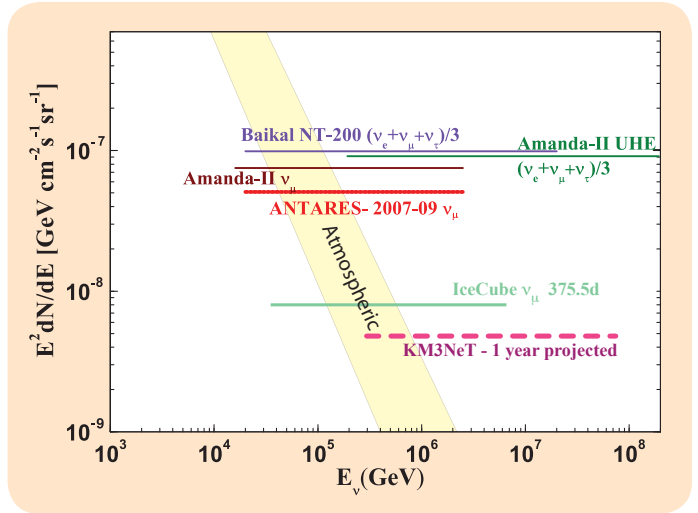

Figure 2.2.1.2. Measured 90% c.l. upper limits on an astrophysical  $\nu_\mu$  flux with an  $E^{-2}$  spectrum for ANTARES, AMANDA, Baikal and IceCube. The band of atmospheric  $\nu_\mu$  flux is shown as well. The projected limit for KM3NeT for one year running is drawn for comparison.

genuine discoveries, thereby establishing neutrino astronomy as a new, viable and exciting field of research.

### New Investments

Once sufficient funding for KM3NeT is secured, additional funding might be requested from the Netherlands, in particular for the real-time computing farm, the spearhead of the present Dutch contribution to ANTARES.

### Personnel

At present, the ANTARES/KM3NeT group consists of five permanent staff scientists, three postdocs, five PhD students and about 12 engineers. The personnel contribution to ANTARES is secured through the FOM programme "Origin of cosmic rays". Additional funding is currently available in the form of one Veni (one postdoc) and one Vidi grant (one postdoc and two PhDs). The personnel contribution to KM3NeT is supported by the EU FP7 programme and the mission budget of Nikhef. It is foreseen to request a new FOM programme for continued support of ANTARES exploitation and KM3NeT development after the current programme expires in 2013.



## 2.2.2 Gravitational physics: Virgo, LISA & ET the dynamics of spacetime

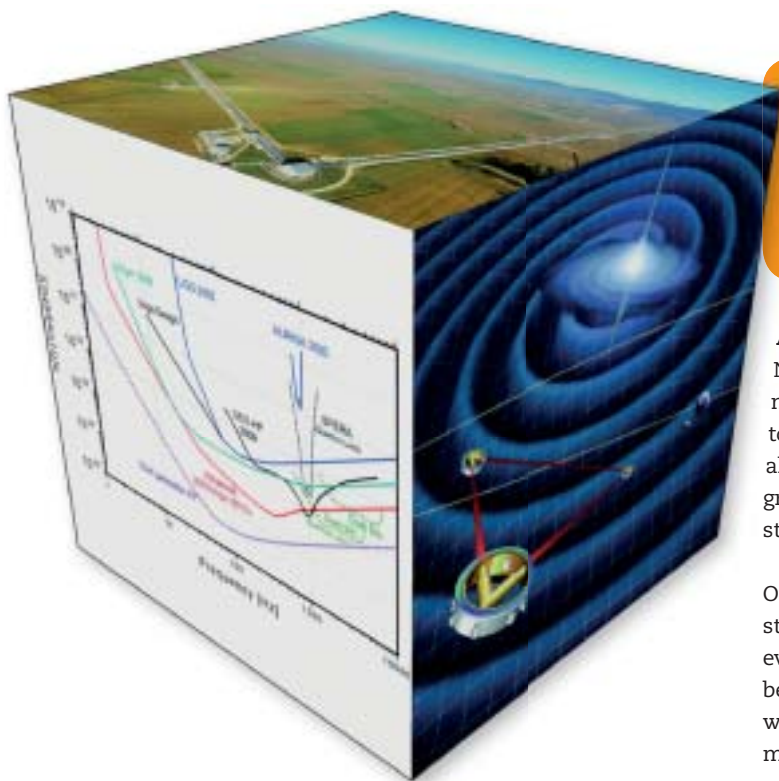

### Mission

To detect gravitational waves, or ripples in the fabric of spacetime, that are produced by violent events throughout the Universe.

### Analysis

Nikhef scientists study the inspiral and merger of compact binary objects (neutron stars and black holes). This will enable us to test general relativity in an unprecedented way and constrain alternative theories of gravity, such as scalar-tensor and massive-graviton theories, and models that arise as low-energy limits of string theory.

Our cosmological studies employ inspiralling binary neutron stars (BNS) as ideal standard candles. A population of BNS merger events observed in coincidence with short, hard  $\gamma$ -ray bursts can be used to measure cosmological parameters, with gravitational-wave observations providing accurate measurements of the luminosity distance and Gamma-Ray Burst (GRB) hosts giving the source's redshift.

Besides signals from compact binary coalescence, Nikhef contributes to the search for signals from periodic sources. A hierarchical search pipeline, the so-called *polynomial search*, has been developed. It constitutes an all-sky search for continuous gravitational waves emitted by non-axial symmetric neutron stars in binary systems. Polynomial Search is based on a Taylor expansion of the phase of the detected gravitational-wave signal and allows the various Doppler induced phase modulations of the signal to be taken into account. It heavily relies on Nikhef's grid infrastructure.

### Introduction

The prime goal of the programme is to obtain first direct experimental proof for the emission of gravitational waves by accelerated bodies. This would confirm once and for all that gravity is a fundamental dynamical phenomenon and would lead to discoveries that impact general relativity, quantum gravity, astrophysics of extreme objects and cosmology. The Virgo collaboration has developed a sensitive interferometer located within the site of the European Gravitational Observatory (EGO), near Pisa. On 2 July 2009, Nikhef became an associate member of the EGO Council.

### Physics programme

The interferometers will be sensitive to gravitational waves produced over a wide frequency range, for example, by massive black holes, binary white-dwarf stars and phase transitions in the early Universe. Gravitational-wave detection opens up the possibility to test general relativity itself in the strong-field regime, to study questions about spacetime, cosmology and structure in the Universe, and would be a first step on the experimental road to quantum gravity.



Figure 2.2.2.1.  
A Virgo scientist working on the Input Mode Cleaner mirror.

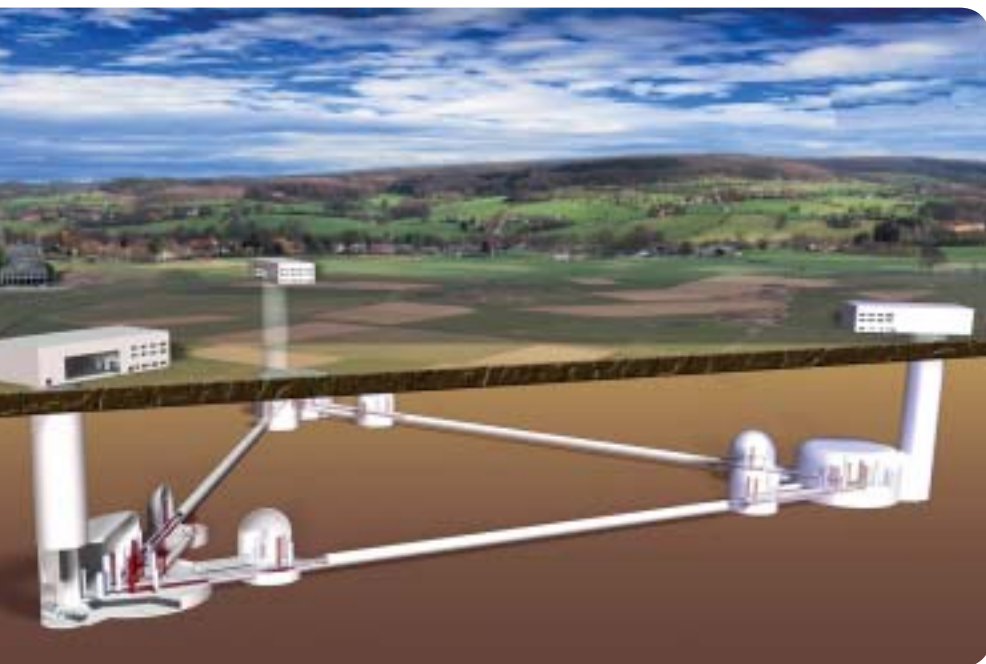

Figure 2.2.2.2. Artistic impression of the Einstein Telescope. The observatory has a triangular configuration that can house three xylophone (i.e. multiband) detectors. Each detector is composed of a low-frequency cryogenic interferometer and a high-frequency interferometer operated at room temperature. The corner stations are connected by 10 km long tunnels.

### Tasks and responsibilities

The Advanced Virgo upgrade will allow Virgo to scan a 1000 times larger volume of the Universe than initial Virgo. Numerous systems need to be improved. Nikhef has responsibility for *vacuum-cryolinks* (separating the towers enclosing the mirror suspensions, from each other) to obtain the required sensitivity of  $3 \times 10^{-24} / \sqrt{\text{Hz}}$  at 200–400 Hz. These links are realised in close collaboration with Dutch industry:

- *Suspended benches and mirrors*: with the use of non-degenerate power recycling cavities the injection and detection benches as well as the recycling cavity mirrors will have to be suspended in vacuum. Moreover, Nikhef will develop seismic attenuation systems for various external benches (not located in vacuum) that host optical tables;
- *Optical systems*: front-end optical systems will be redesigned in order to work with the new modulation frequencies and to provide all the needed demodulated signals for optical alignment. Phase cameras will image amplitude and phase of carrier wave and sidebands.

### Longer term prospects

The search for gravitational waves belongs to the field of astroparticle physics, a rapidly growing research field at the interface of astronomy, cosmology and physics. ApPEC announced a roadmap in which the scientific exploitation of Virgo figures prominently. A third generation gravitational-wave antenna initiative is Einstein Telescope (ET), a multi-national project of eight European research institutes and listed in the ASPERA Roadmap as one of the ‘Magnificent Seven’.

A conceptual design study for ET was submitted to an EU-FP7 call. It received the maximum score for scientific content and the design study formally started on 5 May 2008. It will be comprised of three interferometers with 10 km arms that are placed underground to suppress seismic and gravity-gradient noise. Optical components are placed in an ultra-high vacuum and cryogenic environment. The release of the ET conceptual design study document and the corresponding cost evaluation is scheduled for July 2011.

The Laser Interferometer Space Antenna (LISA) is due to launch about 10 years from now and consists of three spacecrafts five million kilometres apart. It does not suffer from unwanted vibrations that plague similar instruments on the ground.

LISA is currently a candidate for the first large mission in ESA’s Cosmic Vision 2015–2025 programme and is part of NASA’s Beyond Einstein programme. The latter was recently reviewed by the Beyond Einstein Program Assessment Committee (BEPAC) that strongly recommended LISA as ‘*the flagship mission of a long-term program addressing Beyond Einstein goals*’. A large LISA community has formed over the years, organised in the LISA International Science Community (LISC) and bi-yearly symposia are attended by over 200 scientists, with the number of LISA related papers exceeding 1000 (more than 500 refereed papers).

### (Inter)national position and ambition

Nikhef only recently entered the field of gravitational waves. Consequently, the Dutch activity in this line of research is still relatively small, but its impact is becoming significant. Nikhef leads the Advanced Virgo subsystem on suspended benches and vertical

Figure 2.2.2.3. Artistic impression of equipment in a main cavern of the Einstein Telescope. Cryogenic and room temperature suspension chains isolate the test-masses located at the bottom of these superattenuators from seismic disturbances.

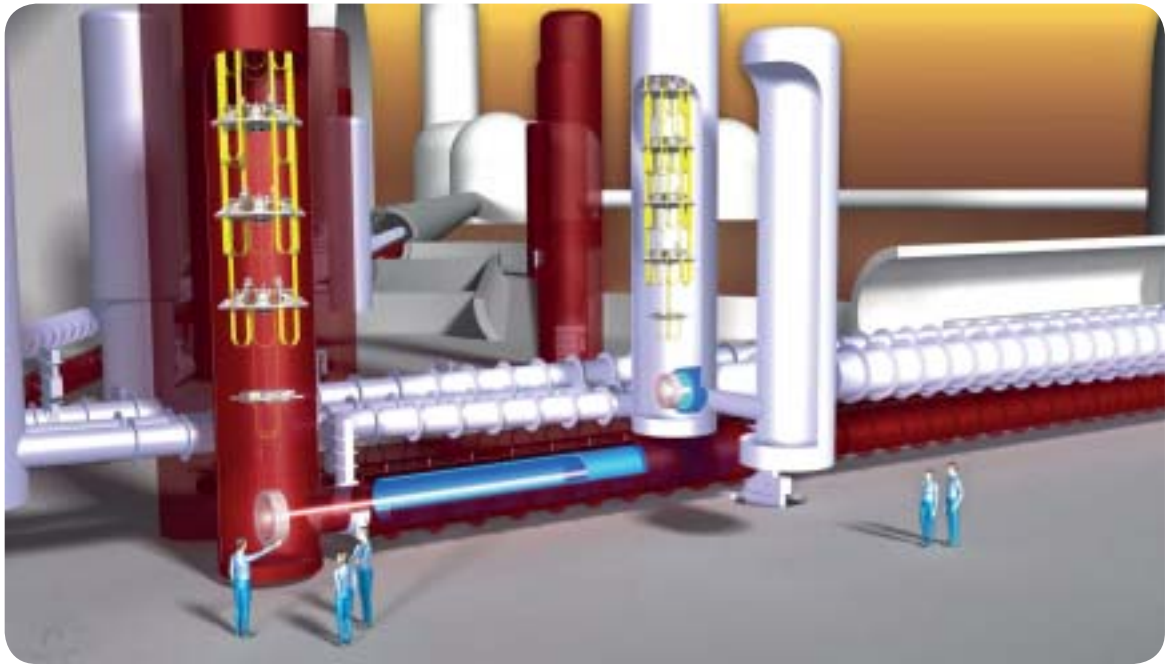

payloads. This includes multiple optical components suspended from single superattenuators for both power and signal recycling, and is judged to be among the greatest challenges of Advanced Virgo. Nikhef participates in the Virgo Council, Advanced Virgo Program Supervisory Board, Virgo Editorial Board, and the LIGO–Virgo Communications committee.

In Einstein Telescope, Nikhef is the leading institute in coordinating the work package on site selection and infrastructure. Nikhef scientists participate in finalizing the design study within the Transversal Writing Team and contribute to the science case and instrumentation. In November 2010 the ETnet proposal was submitted to EU-FP7 INFRA as a coordination tool.

Last year, the Large Scale Cryogenic Gravitational Wave Telescope (LCGT) has been funded in Japan. LCGT will be an underground interferometer with 3 km arms, constructed in Kamioka. It can be considered a prototype for Einstein Telescope. Nikhef collaborates with LCGT on seismic attenuation systems (an EU-FP7 IRSES proposal was submitted in March 2011).

Together with colleagues from the astronomy group of the Radboud University, Nikhef contributes to the LISA science case.

### Knowledge transfer

The programme has various valorisation aspects. The sophisticated seismic isolation systems and ultra sensitive accelerometers find many applications in other fields of science and industry. ET will house the largest ultra-high vacuum chamber in Europe with vessels tens of kilometres long. The construction will require the

development of special metallurgical production processes and the realisation of large welded tube assemblies with high accuracy.

For Virgo a special optical coating facility was realised in Lyon, France, which also attracts industrial clients.

### New investments

An NWO-Groot proposal has been submitted to request investment funds for the Advanced Virgo upgrade. This complements the contributions that have already been secured from other sources (e.g. 500 k€ investment funds are part of the approved FOM program). The resources will be used for the design and construction of cryogenic links in the interferometer arms to reduce optical path-length fluctuations, for the developments of linear-alignment electronics, and for the realisation of optical payloads and seismic-attenuation systems.

### Personnel

The programme currently consists of three fte permanent staff scientists, three postdocs and five PhD students, supported by six fte engineers. It is important to strengthen the group with a senior instrumentation physicist. In addition, the engineering contribution must be significantly strengthened in order to handle Nikhef's responsibilities in Advanced Virgo. Another contribution to the programme comes from the astronomy department of the Institute for Mathematics, Astrophysics and Particle Physics at the Radboud University Nijmegen, with an effort of 0.5 fte permanent staff, a postdoc and a PhD student.

## 2.2.3 Ultra high-energy cosmic rays: Pierre Auger Observatory



### Mission

To study the origin and composition of ultra high energy cosmic rays, their interpretation and consequences for the understanding of astrophysical objects, and the interaction of these ultra high energy particles with the Earth's atmosphere.

### Introduction

Because of the galactic and intergalactic magnetic fields the electrically charged cosmic rays are hard to trace back to their sources, except when their energy exceeds about  $10^{19}$  eV, where the bending of the cosmic rays in the (inter)galactic magnetic fields becomes small, even over intergalactic distances. At cosmic ray energies above  $10^{19.7}$  eV they start to interact resonantly with the cosmic microwave background photons –the Greisen–Zatsepin–Kuzmin (GZK) limit– meaning that cosmic rays of that high energy are likely to come from relatively nearby extra-galactic sources. It is therefore that ultra-high-energy cosmic rays (UHECRs) have attracted a lot of attention over the past few decades. The energy distribution of cosmic rays follows a steeply falling spectrum, with a rate of about 1 event per  $\text{km}^2$  per century for energies above  $10^{19}$  eV, requiring a large area observatory to detect them in sufficient quantity. The Pierre Auger Observatory (PAO) covers such a large area ( $3000 \text{ km}^2$ ) and has shown a clear suppression of cosmic rays at ultra high energies, which can be attributed to the GZK cut-off. However, it cannot be excluded that the sources of UHECRs run out of steam around the same energy. The break-through observation by the PAO was that ultra high energy cosmic rays do not come from all directions isotropically. The data shows a

correlation to areas in the Universe with a larger matter density, and possibly to active galactic nuclei. Furthermore, the PAO established that with increasing energy towards the highest energy cosmic rays, the air shower profile of their interactions with the Earth's atmosphere changes from what is expected for cosmic ray protons. This change is compatible with an increase of (average) atom number of the detected nuclei, but a change in the physics of the collision, in energy several of orders of magnitude above the LHC energy, also cannot be excluded.

The PAO uses two complementary detection techniques: a measurement of air shower particle flux at ground level (1400 m above sea level) with water-Cherenkov counters (SD) and the imaging of the air shower with fluorescence telescopes (FD). The current results allow for a number of questions that can be addressed with the PAO:

- Is the drop-off in the energy spectrum the GZK effect, or do cosmic sources run out of steam at these energies?
- What are the cosmic sources of these ultra high energy particles and how are these particles accelerated to the observed energy?
- What is the chemical composition of the ultra high energy cosmic rays?
- Can the interactions of cosmic particles with the Earth's atmosphere be described by the Standard Model physics we know, or do we need to invoke new physics?

All these questions need much more data and more accurate measurements on the highest-energy cosmic rays.

### Physics programme

The construction of the PAO was completed in 2008, already taking data with a partial detector earlier. Efficient data taking will require a continued effort of all partners in the PAO and clearly also involves a Dutch contribution. To increase the amount of data the observatory will be run over many years to come. But answering the questions raised in the introduction will require much more data and also improved measurements of air shower properties to accurately determine the chemical composition of the ultra high

energy cosmic rays. The recent addition of an infill region both for the surface detectors and the fluorescence telescopes allows a reduction of the lower energy threshold of the observatory. Redistributing a fraction of the water-Cherenkov tanks with a larger inter-tank spacing will allow to cover a larger area with existing equipment, thereby increasing the acceptance for ultra high energy cosmic rays by about a factor of 1.5.

The fluorescence telescopes, providing detailed information on the properties of air showers, can only be operated in moonless, clear nights, limiting their duty factor to about 10%. A new technique using the observation of air showers using their emission of radio waves is being developed that allows imaging of the full air shower. Nikhef is a leading partner in developing this radio detection of cosmic rays. Several test setups in the PAO have verified the principle of radio detection of cosmic rays. This led to the design and current implementation of the Auger Engineering Radio Array (AERA), of which by the time of writing this report 21 of the 159 detector stations have been commissioned. The AERA is placed in the infill region of the PAO to overlap in the energy range of observable cosmic rays with the other two detection techniques in this area. The ultimate aim is radio detection of UHECRs over the entire area of the PAO, covering 3000-5000 km<sup>2</sup> with a near to 100% duty cycle to address the questions in the introduction.

### Analysis

The analysis of cosmic-ray radio detection data is led by the combined Dutch Nikhef and KVI group. They have been the first to observe a coincidence between a radio detector event and a surface detector event in the PAO. Recently they have also been the first to observe that not only geo-synchrotron radiation provides a radio detection signal, but also the charge excess mechanism can give a sizable contribution to the signal. This leads to major progress in understanding the full radio wave signal from cosmic rays. More detailed analysis is needed to gain a complete understanding of the radio wave signals that are emitted by air showers from cosmic rays and this will remain an important analysis topic for the coming years. Matching of the UHECR PAO data is also under investigation, with an emphasis on the role of Cygnus A, the nearest active galactic nucleus, for these data. There is also



Figure 2.2.3.1. Prototype radio antenna deployed on the Pampa.

an effort to match the directions of ultra high energy cosmic rays from the PAO with neutrino arrival directions as measured with the ANTARES neutrino telescope.

### Tasks and responsibilities

The Nikhef, KVI and Radboud University astronomy group are jointly responsible for the electronics, system integration, deployment, commissioning and data acquisition of the AERA. These groups also play the leading role in analysing the radio detection data. Furthermore, the groups are responsible for maintenance of the SD communication system and outreach tasks in the collaboration.

### Longer term prospects

Since the detection of ultra high energy cosmic rays is hardly hampered by background, the discovery opportunities grow approximately linear with exposure, hence with time. Therefore, data should be collected with the PAO over many years to come, at least over a decade. At the same time commissioning the radio detection of cosmic rays will significantly enhance the research potential. This will require between 5 and 10 years to mature and to cover the entire area of the PAO after which at least 5 more years of data taking are necessary to fully exploit the combined set-up. This means that we foresee a useful lifetime of the PAO of between 15–20 years to come. In the second half of this lifetime we will consider joining follow-up experiments.

### (Inter)national position and ambition

The joint Dutch groups in the Pierre Auger Collaboration aim to be and remain the leading partner in the radio detection of cosmic

rays and exploiting its results. The group is quite well positioned to achieve these ambitions, already playing a leading role in the development of the radio detection technique and in the study of sources of UHECRs. However, to maintain this leading position in radio detection, to match increased effort from other labs and to extend the physics analysis, reinforcement of staff, postdocs and PhD students is needed.

### **Knowledge transfer**

The need for a highly distributed sensor network of several thousands of completely autonomous detector stations is not exclusive to (radio detection in) the PAO. Therefore, the development of a robust, maintenance free, ultra-low power sensor network may well be a joint enterprise for our group and commercial partners. There is a continuous effort to identify possible (commercial) partners for this development. So far this has bounced on lack of interest from industry to really invest in these techniques, but new initiatives are under consideration.

### **New investments**

There will be large investments needed to scale the radio detection of UHECRs in the PAO from the presently funded AERA to full coverage of the observatory. This is likely to happen in two steps, scaling from the 20 km<sup>2</sup> AERA to an approximately 300 km<sup>2</sup> array and from there in a second step to the full coverage of 3000–5000 km<sup>2</sup>. The Dutch groups aspire to be the largest partner in the 300 km<sup>2</sup> array, requiring a considerable investment (see Chapter 5).

### **Personnel**

Currently the Dutch groups (including KVI and the astronomy group of Radboud University) comprise of four fte staff, four post-docs and 10 PhD students. Increasing the group in staff by at least two fte and increasing the number of postdoc and PhD student appropriately allows a significant Dutch imprint on a completely new and complementary detection technique, opening many new research venues in the Pierre Auger Observatory.

## 2.2.4 Dark matter: XENON



### Mission

To identify and study the particle responsible for dark matter in the Universe.

The search for dark matter through direct detection is timely since these investigations are also being conducted at the LHC and through indirect methods (e.g. detection of high-energy neutrinos from the Sun) with neutrino telescopes. There is significant complementarity between these and direct dark-matter detection experiments and a reasonable chance exists that dark matter will be observed by all three detection methods more or less simultaneously in the following decades.

### Introduction

One of the most exciting topics in physics today is the nature of dark matter in the Universe. Although indirect evidence for dark matter is well established, its composition is not yet known. Current evidence disfavors astronomical bodies as the major contributor to dark matter and favors models in which the primary components are one or more elementary particles, collectively called non-baryonic (cold) dark matter. No currently known particle in the Standard Model has the right properties to be dark matter. One of the most compelling candidates is the Weakly Interacting Massive Particle (WIMP), since it naturally leads to the right dark matter abundance and is part of many of proposed Standard Model extensions. WIMPs could be detected directly by their collisions with nuclei in underground experiments. The predicted interaction rates in these so-called direct detection experiments are very low ( $< 1$  event/kg-day) and detectors with significant mass with ultra-low backgrounds are necessary. A relatively new and promising technique is to use noble liquids such as xenon in a dual-phase time projection chamber (TPC) to investigate these WIMP-nucleus collisions.

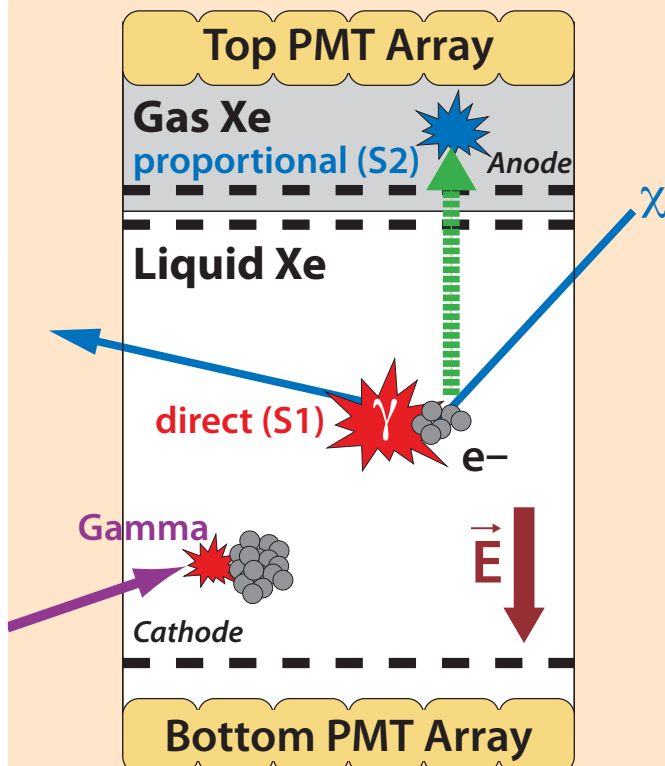

Figure 2.2.4.1. Schematic diagram of a dual-phase xenon Time Projection Chamber. The time correlation of the primary (S1) and secondary (S2) scintillation light allows the identification of recoil events in the detector. The relative amount of S1 and S2 light provides discrimination of background events from scattering of WIMPs (denoted by the symbol  $\chi$ ) off nuclei.

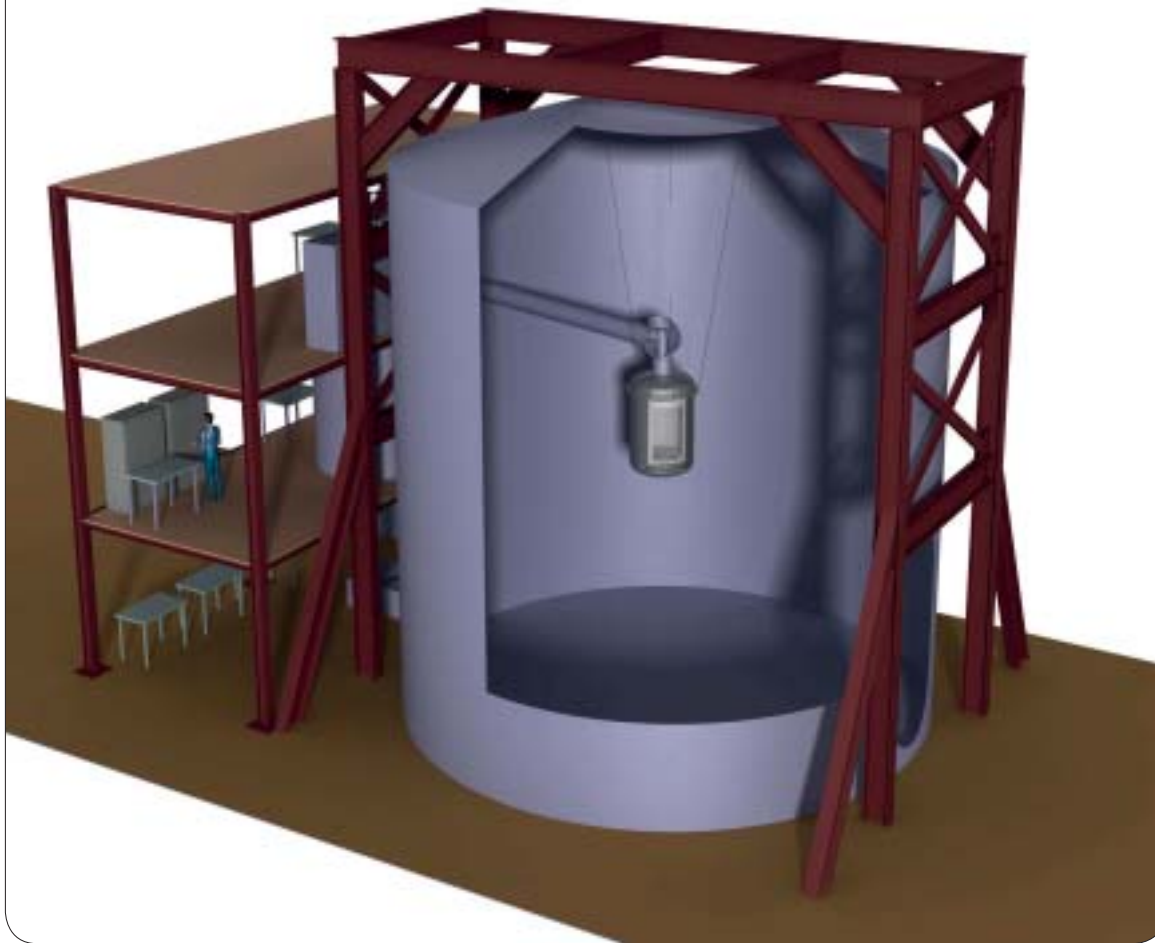

Figure 2.2.4.2. A rendering of the next-generation XENON1T experiment. Nikhef is designing the cryostat (middle of the figure) containing 2.4t of liquid xenon and the detector. The cryostat is inside a 11m diameter water tank for shielding from background. The experiment is planned to be sited at the Gran Sasso underground laboratory in Italy.

### Physics programme

The goal of the Nikhef Dark Matter programme is to become a strong participant in one of the leading direct-detection dark-matter experiments. Nikhef joined two noble-liquid dark-matter efforts in 2010: the XENON collaboration and the DARWIN design study. The XENON collaboration is operating the running 100-kg XENON100 experiment with the aim of exploring the spin-independent (SI) WIMP-nucleon cross section down to  $\sigma_{\text{SI}}$  of about  $10^{-45} \text{ cm}^2$  (for a WIMP of 100 GeV mass). The collaboration is also planning the next-generation XENON1T ton-scale experiment that will probe the majority of the theoretical favoured WIMP parameter space with science running starting in 2014. The DARWIN design study, funded through the ASPERA EU framework, aims to design a multi-target experiment with both a 5 ton xenon target and a 10 ton argon target.

### Analysis

In the running XENON100 experiment the Nikhef group is aiming to contribute to dark matter analysis. We will gain experience in the analysis and develop new statistical tools (e.g. a likelihood analysis) to extract additional information. This will position us well for the analysis of the XENON1T data. Separately, we will contribute to Monte Carlo background studies for the XENON1T detector to optimise the read-out geometry.

### Tasks and responsibilities

The Nikhef group has the following responsibilities in the XENON1T experiment: designing the cryostat and cryostat support structure, providing the photon-sensor preamplifiers and co-developing the data acquisition system. For the DARWIN design study, we are performing detector R&D by testing the Nikhef-developed GridPix detector in liquid xenon and argon and participate in the background and science impact work packages.

### Longer term prospects

The dark matter field is rapidly evolving. We are focusing on extracting the directly available science with the XENON experiments in the coming 3–5 years. At the same time we are also participating in the DARWIN design study to perform R&D for a future dark matter detector. The design study runs until mid-2013 and a DARWIN-like detector could start operation in 2016–2018.

### (Inter)national position and ambition

We are still in the start-up phase of the direct detection dark matter activity in the Netherlands. Internationally, there is much interest in developing these detectors and many groups are expanding in Europe and in the U.S. By joining XENON, one of the leading and most sensitive dark matter experiments, we want to play a major role in the field. In the XENON experiment we participate in the Executive Committee (M.P. Decowski). The DARWIN activity



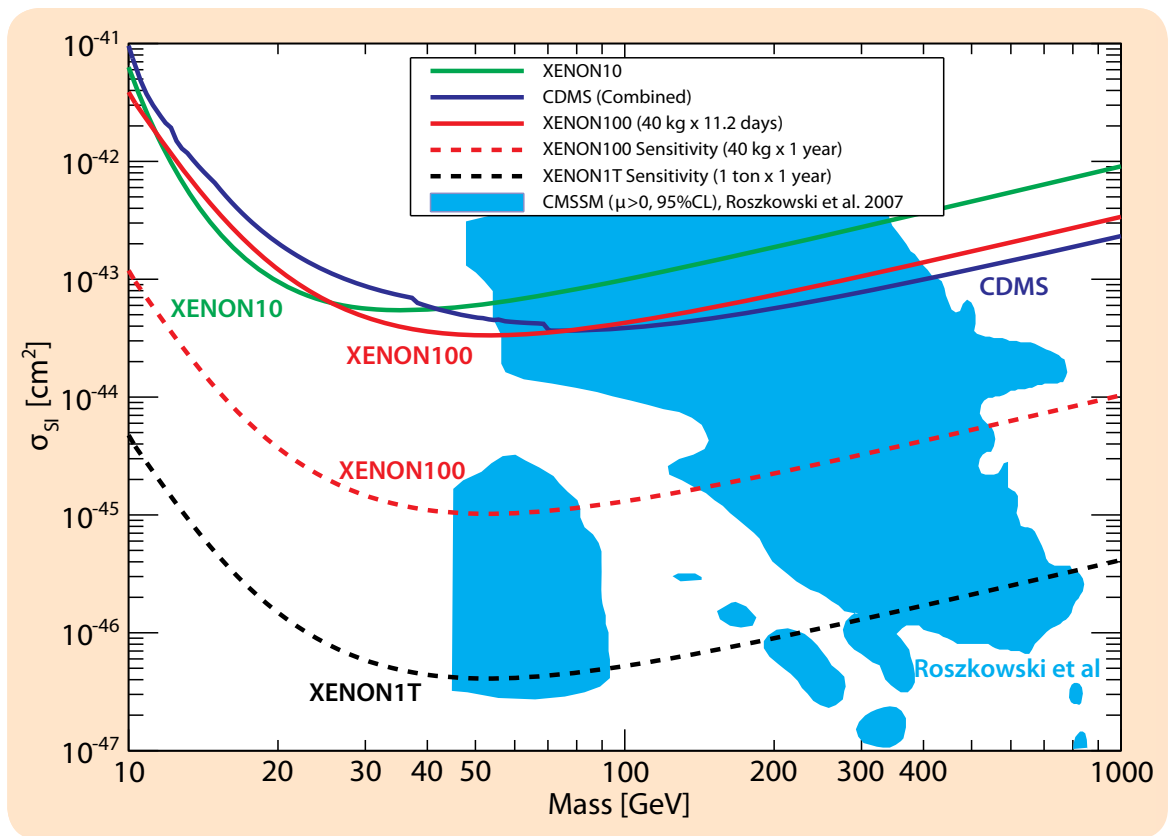

Figure 2.2.4.3. Spin-independent cross section for scattering of a WIMP off a nucleon, as a function of the WIMP mass. The solid lines show the exclusion limits obtained by the XENON10 (green), CDMS (blue) and early XENON100 data (red). The dashed lines show the expected sensitivities for 1 year of running for XENON100 and XENON1T. The blue area represents the expected cross section in the cMSSM model.

will position us for the next step in the dark matter field. It will be the most sensitive detector that can be built and will explore all the theoretically favoured WIMP parameter space. In case of discovery, it will allow us to study the dark matter particle with two different targets (argon and xenon). In DARWIN, we lead one of the charge-read-out task groups (M. Alfonsi) and the science impact working group (M.P. Decowski).

### Knowledge transfer

Medical imaging could profit from R&D developments in noble-liquid time-projection chambers, in particular in the field of positron-emission tomography (PET).

### New investments

The current investment in the dark matter effort is carried by Nikhef funding. We envision additional funding through a Dark Matter FOM-programme (under review), and EU and NWO personal subsidy instruments.

### Personnel

The Nikhef Dark Matter programme is in the starting phase and currently consists of 1.5 fte permanent staff scientists, one post-doc, one PhD student and 1.5 fte technical staff from Nikhef. We would like to expand this to a larger contribution of permanent staff and add another 2-3 PhD students and a postdoc.

## 2.3 Enabling physics programmes

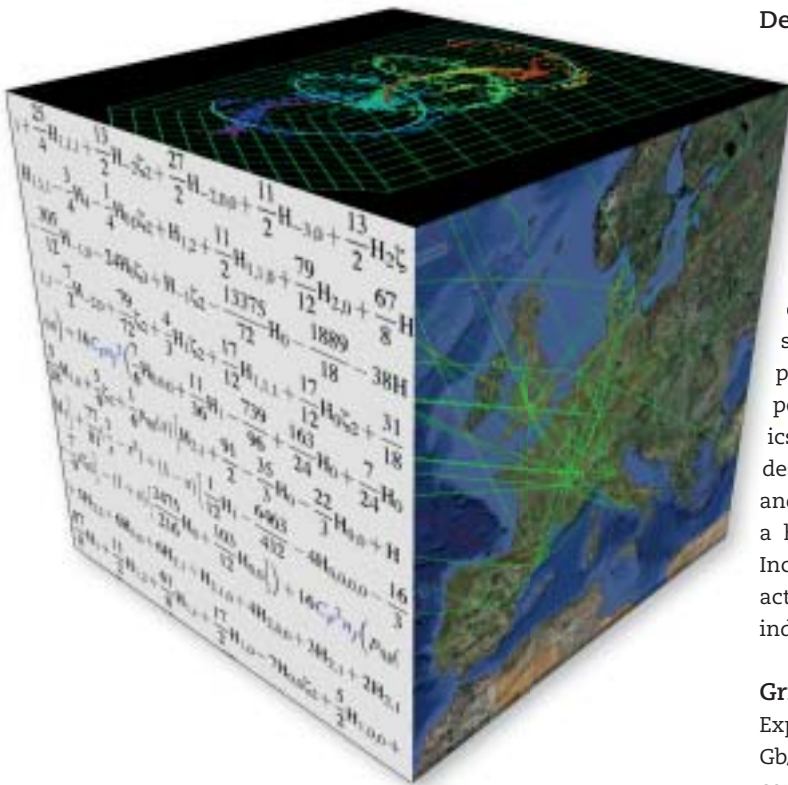

The experimental research programmes described in the previous sections, accelerator-based particle physics and astroparticle physics, are, also in view of the substantial direct Dutch contribution to CERN, the *raison d'être* of Nikhef. They are the focus of Nikhef's mission statement (Section 1.1) and this is where Nikhef coordinates Dutch activities. Not surprisingly, these programmes together take up 2/3 of Nikhef's research expenditures. The remainder is spent on research which, despite its modest financial share, is of crucial importance to the past and future successes of Nikhef's core experimental programmes, namely:

### Theoretical physics

Throughout history, progress in physics has always been the result of interplay between experiment and theory with either the theorists or the experimentalists in the driving seat. For Nikhef's experimentalists it is extremely beneficial to have in-house theorists, notably phenomenologists, available for discussions and new analysis ideas. In a broader sense, theoretical physics is a research discipline in its own right, with its own research programme, and PhD students. As such the Nikhef theory group is embedded in a larger national theory network, coordinated by E. Laenen from Nikhef.

### Detector R&D

Cutting edge experiments require state-of-the-art particle detection technologies rarely available as off-the-shelf products. The combination of an excellent technical infrastructure (people-wise and facility-wise) and presence of a modest-size core group of particle detector R&D scientists explains Nikhef's strong position in the arena of development and subsequent realisation of detector concepts. This strong presence covers diverse technologies, ranging from precision mechanical structures to high-level read-out and trigger electronics and software. This in turn attracts highly-motivated technicians and provides Nikhef's physicists with detailed knowledge of detector performance characteristics, which is invaluable in the physics data analysis phase. Nikhef's technical capabilities allow the design and construction at Nikhef of major detector components and sub-systems for large scale experiments. This makes Nikhef a highly welcome participant in the associated collaborations. Increasingly important spin-off effects of Nikhef's detector R&D activities in the past years are the emerging joint ventures with industrial partners and start-up companies.

### Grid computing

Experiments with many millions of read-out channels, multi-Gb/s data rates and mind-boggling analyses require innovative computing concepts. Grid computing, a large geographically distributed computer network, is such a concept. Nikhef is a leading player in the field of grid computing. This is demonstrated by the 'BiG Grid' facility, one of the 11 world-wide grid ('Tier-1') centres for LHC data analysis, located at the Science Park Amsterdam. Also, the European Grid Infrastructure (EGI) is located here. For the ATLAS experiment, this Tier-1 grid compute centre is the largest European centre. Its computing contributions make Nikhef a highly respected partner in high energy physics data handling. Besides LHC data analysis, the BiG Grid facilities will also serve many other research communities and industries throughout the Netherlands. Clearly ICT has become an integral part of Nikhef's research agenda.

## 2.3.1 Theoretical physics

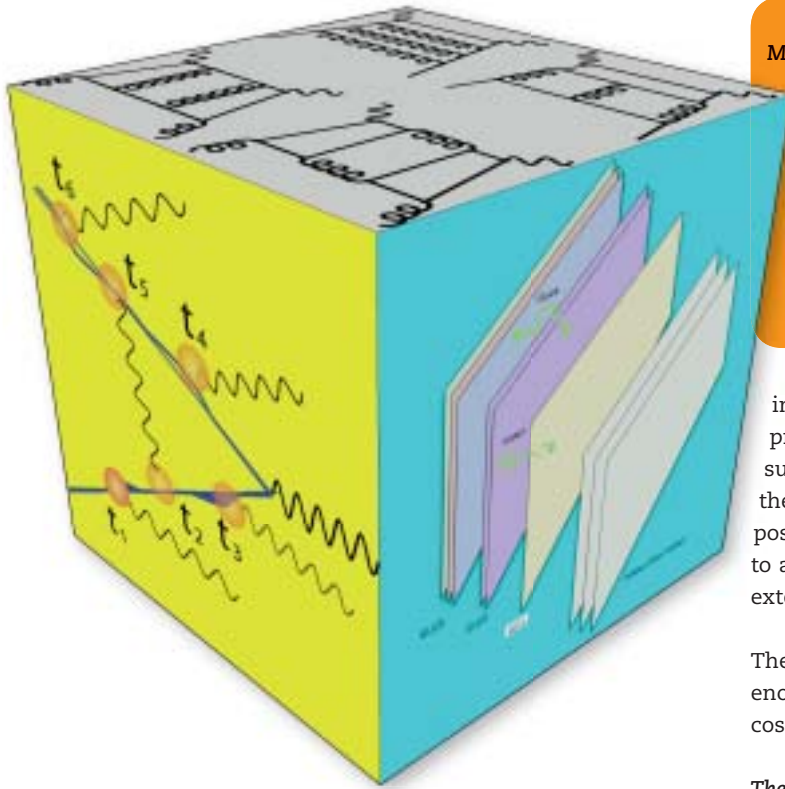

### Mission

- To describe and explain the properties and interactions of subatomic particles;
- To study theoretical models, such as the Standard Model, for predicting and describing new and existing experimental or observational results, mostly in the framework of quantum field theory;
- To develop analytical and computational tools for these studies.

ing of Master students, PhD students and postdocs. Its research programme must be both deep and broad, and allow for difficult, sustained efforts (carried out by permanent staff, FORM being the prime example), as well as be nimble and flexible (through postdoctoral appointments and PhD projects). With possibilities to appoint new staff, and with flexible funding from Nikhef, and external funding both requirements are well-met.

The main research themes in the programme will be the phenomenology of the Standard Model and beyond, astroparticle physics, cosmology and string theory.

### The Standard Model and beyond

The main expertise in collider phenomenology in the group lies in providing precise predictions, involving higher order calculations. With the LHC now taking data, the focus in the next few years will increasingly shift to actual confrontations of precise calculations with data, in collaboration with experimental colleagues. Specifically, predictions for vector boson plus multi-jet production and for t-quark production plus associated jets or vector bosons are key signals where the group has significant expertise. In B-physics and CP-violation, such close interactions have already started.

The past few years have also seen remarkable progress in field-theoretical methods for computing scattering amplitudes, both exact at finite order in perturbation theory, and approximate all-order results, many of whom were developed by Nikhef group members. It is expected that these will see further application, as well as further development.

While stringent testing of the Standard Model is a long-standing forte of the group, recent research in the theory group has increasingly involved building models beyond the Standard Model (supersymmetric and extra-dimensional models) and providing signal predictions for them. This trend will continue, especially in the wider context of the national programme.

### Introduction

Theoretical particle physics has arrived, in its joint journey with experiment, at the cusp of a new era. With the LHC now taking data, and with cosmological observations and astrophysical data from the Planck satellite and earth-bound observatories imminent, theoretical physics will be challenged to synthesise a coherent understanding out of these, leading to a deeper understanding of Nature at the smallest and largest scales, of elementary particles and their interactions, the structure of space and time and the structure of the cosmos.

The Nikhef theory group is well-prepared for this era of opportunities, and is ready to play a major role in answering the challenge. Its approach will involve building on existing strengths as well as striking out into new directions, forging new links between fields and new collaborations with other theory groups in the Netherlands and abroad.

### Physics programme

Situated at a laboratory of experimental physics, the theory group at Nikhef plays various roles, pursuing its own research objectives, supporting, informing and learning from experimental efforts, and teaching through lab-wide lecture courses and mentor-



Figure 2.3.1.1. The 4-loop QCD beta-function: Nikhef staff member Jos Vermaseren (right) together with the authors of the one- two- and three-loop calculations. Second from the left is 2004 Nobel Laureate David Gross, responsible for the first one-loop result. Jos Vermaseren was honoured with the Humboldt Research Award in 2006.

### Astroparticle physics, cosmology and string theory

Among the most interesting questions in astroparticle physics is whether gravitational waves indeed exist and can be detected on Earth. Nikhef is involved in the Virgo interferometer. In the theory group there is a long-standing interest in gravitational wave physics. New modelling methods for predicting signals from likely sources are being developed in the group. Data from the cosmic microwave background and other observations have clear impact on inflation scenarios. The extreme circumstances of that epoch provide a wonderful testing ground of particle physics models. Work in the group has led to sharpening or rejection of several models already, and with Planck data imminent, more progress is expected. Work here is also embedded in national efforts such as the Theory Centre Meetings, as well as a regular Cosmology Meeting among the groups at Nikhef, and the universities of Amsterdam, Leiden and Utrecht.

Group member Schellekens was the first string theorist to point out and take seriously the existence of a large multitude of solutions (also known as the landscape) of string theory. Powerful conformal field theory techniques, developed in the group, have allowed a very fruitful approach in studying the particle physics models in these 'vacua' and given insight into how special certain characteristics, such as Majorana neutrinos, are. This work has gained much attention, while much remains to be done.

### Tools

Group members have (co-)developed a number of important software tools for theorists and experimenters. By far the most conspicuous is the symbolic manipulation program FORM of Vermaseren. Continuously developed and refined by Vermaseren over 20 years, it has become a truly indispensable tool for higher order calculations. Very recently it has been released as open source, allowing for the first time others to directly contribute to the code. Nikhef has funded two postdoctoral fellows for the

express purpose of developing and open-sourcing FORM. Other programs are MC@NLO, in particular the single t-quark processes; GOLEM and SAMURAI for one-loop calculations; BLACKHAT for V+jets at NLO; RAMBO and SARGE for phase space integration; and the program Kac by Schellekens, that computes fusion rules in conformal field theory.

### National centre

A large part of the groups' research ambitions for the foreseeable future has been aligned with those of university groups, supported by the FOM programme "Theoretical particle physics in the era of the LHC". This part of the Dutch theoretical particle physics community collaborates to focus on a central question, from various perspectives. The central question is: *which particle physics model will consistently describe the data from colliders and cosmological observations?* The collaboration, coordinated by Laenen, includes mechanisms to ensure interaction and coherence of efforts, as well as training efforts for junior scientists. The three perspectives adopted are:

- the precision comparison of high-quality collider data with precise theoretical predictions;
- the violation of discrete symmetries such as C, P and T;
- the prediction of new particles and symmetries at the LHC.

Expertise in these areas is available in the programme members that also comprise the universities of Groningen, Leiden, Nijmegen, Utrecht, Amsterdam, and the KVI institute in Groningen.

The programme functions in practice quite coherently. About 10 PhD students and postdocs have been appointed at the various sites. They, as well as the various group members, get together once a month at Nikhef for Theory Centre Meetings, where much fruitful interaction occurs. As a result, the theory group at Nikhef functions increasingly as a national centre for collaborative research in phenomenology in a broad sense, with interfaces to cosmology, astroparticle physics and experiment. PhD students and

Figure 2.3.1.2. Evolution of the universe over 13.7 billion years. The far left depicts a period of 'inflation' that produced a burst of exponential growth in the universe. For the next several billion years, the expansion gradually slowed down. More recently, the expansion has begun to speed up again as the repulsive effects of dark energy have come to dominate the expansion. The afterglow light (cosmic microwave background) as seen by satellites like WMAP (NASA) and Planck (ESA), is emitted 380,000 years after inflation.

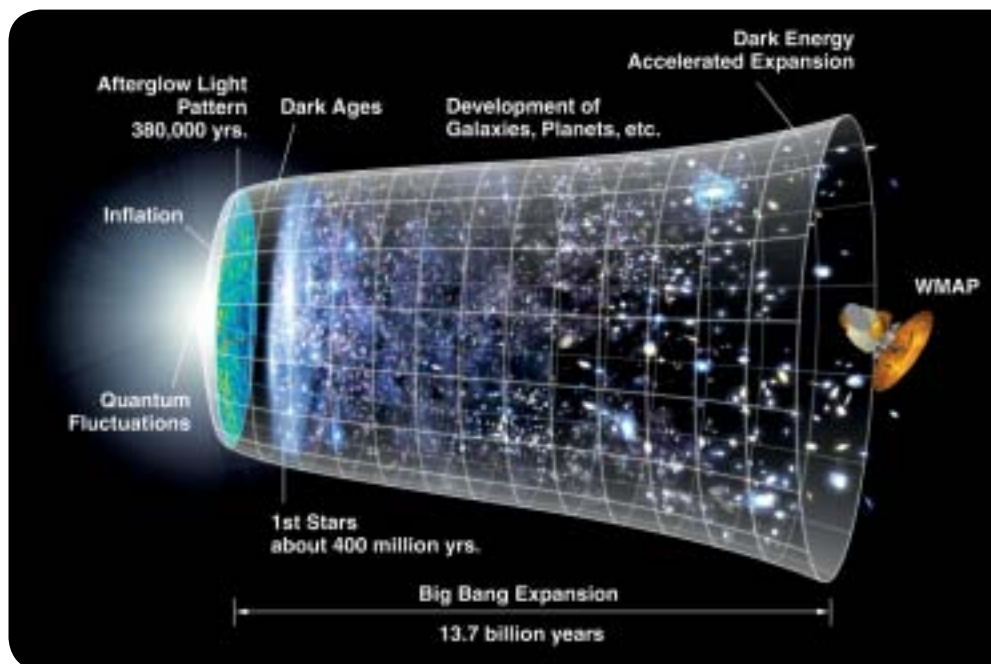

postdocs are particularly active during these meetings. Recently, advanced topical lectures have started, beginning with FOM programme member Gerard 't Hooft.

#### Cooperation with experiments

The interactions of the theory group with the Nikhef experimental groups are and will be intense. In B-physics, group member Fleischer has authored joint publications with LHCb colleagues, and is closely involved in analysis discussions. t-quark physics is of special interest for both the D0/ATLAS group and the theory group, and discussions involving staff members and PhD students are taking place. It already led to the implementation of higher order processes of single top production at hadron colliders in a Monte Carlo program. There is also much interaction in the astroparticle physics programme. Van Holten is a member of a national FOM programme on this topic, and is directly involved in analysis discussions, especially regarding gravitational waves. Continuing close contacts are foreseen with the heavy-ion physics experimental groups at Nikhef and Utrecht, in particular for gluon saturation physics and Colour Glass Condensates.

#### (Inter)national position and ambition

The theory group attracts visitors and postdocs from all over the world. Members of the theory group collaborate with theorists in Europe, the U.S., Asia, and Australia, as well as with experimenters. Many of these are informal, as is customary. The group is also a full member of the FP7 Marie Curie Initial Training Network LHCPhenoNet, due to start in 2011. In the past few years, the group was a member of the FP7 HEPTOOLS training network, with the Nikhef theory group at the RU in Nijmegen being the main node. Nationally, the group acts as a centre for particle physics phenomenology.

The research conducted in the group is well-appreciated internationally, and well-cited. Justly famous is the calculation of the NNLO splitting functions by Vermaseren and his colleagues in 2004. Also very noteworthy are the calculations of particle physics models from string theory by Schellekens and collaborators in 2005, the resummation studies and the single-top production calculations in the context of MC@NLO by Laenen and colleagues in 2006.

#### Knowledge transfer

In 2010 the symbolic manipulation program FORM has become open source. Until then, only free binaries were available. A comprehensive framework was set up involving a download site at Nikhef, as well as forum discussion software. The open sourcing of FORM is a key step in future-proofing this software tool indispensable for challenging higher order calculations. Moreover, FORM is also excellently usable for intensive symbolic computation in many other fields of science.

#### Personnel

One new staff member was recently appointed: Robert Fleischer from CERN, who joined in 2009. Fleischer is a world-leading expert on CP-violation and B-physics, enabling for the first time high-quality collaboration with the LHCb physics group at Nikhef. In 2008 Marieke Postma from DESY joined the group on a five year Vidi fellowship, adding through her research an interface from particle physics to cosmology and inflation physics. Jos Vermaseren was awarded a Humboldt Research Prize in 2007. In recent years the number of postdoctoral fellows and PhD students has seen increases, partly due to success in attracting external funding. Many theory group members hold special university chairs, and as such the group hosts a number of master and bachelor students. Recently, some master students have been able to co-author papers with group members. They often continue as PhD students in the theory group, or in one of the Nikhef experimental groups.

## 2.3.2 Detector R&D

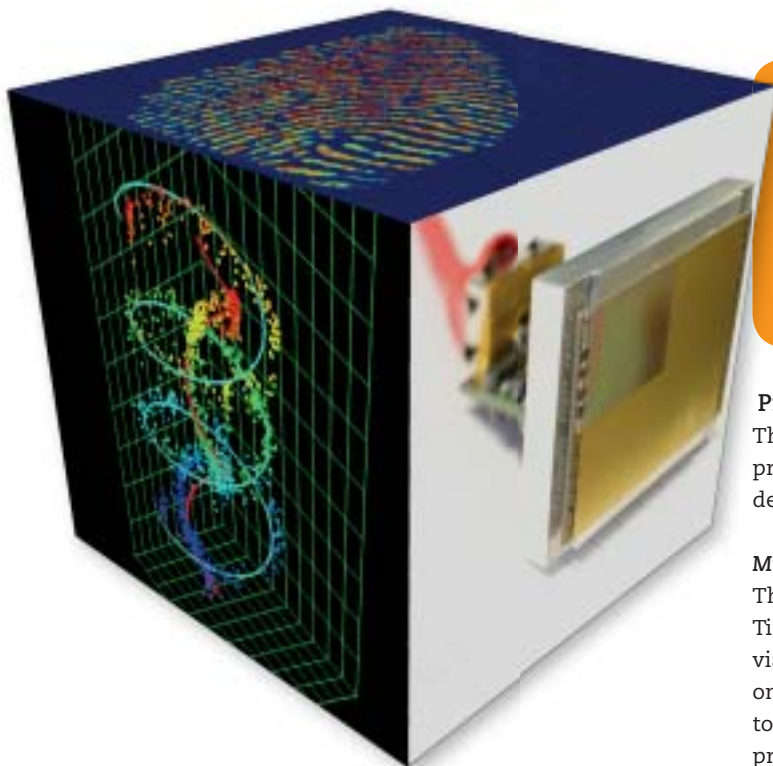

### Introduction

The context of the programme is intrinsic detector R&D with foreseen applications on a longer time scale: the preparation for LHC detector upgrades, a new generation of accelerator based experiments and new detection systems for astroparticle physics experiments.

To be able to exploit the high luminosity provided by LHC upgrades, the LHC detectors need to be upgraded. For instance, the existing vertex detector granularity is insufficient to cope with the high occupancy and demands extensive detector R&D. The realisation of a future linear collider requires new accelerator technology, excellent 3D tracking detectors and finely-grained calorimetry systems.

Optical techniques gain importance in different scientific disciplines at Nikhef. Therefore, gaining expertise in applied optics, photonics and optoelectronics will be an important asset in future detector development.

Nikhef expands its activities in the emerging interdisciplinary field of astroparticle physics. A new generation of experiments based on improved detection techniques is needed to investigate these physics phenomena: water Cherenkov neutrino detectors; radio detection of extended air showers; dual phase xenon time projection chambers for dark matter searches; and interferometric gravitational wave detectors.

### Mission

To develop state-of-the-art detector technologies to advance future particle and astroparticle experiments. To take a leading role implementing these technologies in next generation experiments via (inter)national partnership. Collaborations with industrial partners are actively pursued.

### Programme

The activities in the R&D group extend from building innovative prototype detectors to exploring new enabling technologies for detector development.

#### Micro Pattern Gas Detectors

The Nikhef Detector R&D group proposed the development of a Time Projection Chamber (TPC), where gas multiplication is done via a Micro Pattern Gas Detector (MPGD). The MPGD is integrated on top of a read-out chip with a high-resistivity protection layer to withstand discharges. These so-called GridPix detectors are produced with wafer post processing technologies in an ongoing collaboration with several European nano-fabrication laboratories and universities since 2007. A variety of communities gained interest in this type of gaseous TPCs and several applications are studied within the Detector R&D group.

Such a pixelated gas detector could be used as vertex detector for e.g. ATLAS when LHC reaches extreme radiation levels after luminosity upgrades. Tests with a GridPix with a gas layer of only 1 mm (called Gossip) have shown good detection efficiencies. Another application is for the ILC detector, a large gaseous Time Projection Chamber for 3D tracking of charged particles produced in  $e^+e^-$  interactions. A prototype made up of eight GridPix assemblies has been built within the EUDET collaboration (for ILC detector R&D) and this work will continue within the AIDA collaboration. Other applications include measuring the polarisation of cosmic X-rays, measuring the angular correlation of an  $e^+e^-$  internal pair conversion, and using GridPix in dark-matter detectors, as will be described in more detail later. The latter is a new research activity at Nikhef within the DARWIN collaboration, a design study of next generation noble liquid dark matter facility in Europe as part of the ASPERA roadmap.

#### Medipix

Nikhef participates in the international Medipix collaboration, that has developed a high-contrast resolving CMOS pixel chip for X-ray imaging applications. The Timepix chip evolved from

Figure 2.3.2.1. PhD student Marten Bosma, probing chips in 45 nm technology on a 300 mm wide test wafer from NXP Semiconductors.



this Medipix chip. In addition to a precise 2D pixel coordinate it measures the arrival time of detected charges, thus enabling 3D hit reconstruction in a TPC. In a joint effort with Bonn University, new ASIC circuitry is developed for a new version of the Timepix chip. This chip will provide better energy resolution, improved timing resolution and fast & sparse read-out for both gaseous and semiconductor detectors. This chip can be used for further tests for the LHCb VELO-upgrade chip design plans.

Further R&D is needed to reduce the inactive chip edge and to make better use of 3D integration. Novel 3D technologies have to be considered. This can be by implementing new sensor technologies, away from the present planar structures, by applying multiple ASIC layers to avoid periphery electronics and to increase functionality, or even by 3D-stacking of sensors. Key technologies for 3D integrated circuits are: wafer-to-wafer bonding, wafer thinning, through-wafer via formation and surface metallisation, and high-precision alignment.

#### **CO<sub>2</sub> cooling**

Nikhef has developed detector cooling based on an evaporating cooling cycle with CO<sub>2</sub>. Using liquid CO<sub>2</sub> as a cooling fluid, allows high-pressure, small sized tubing and thus low-weight systems. As a consequence of working with high pressure it is possible to regulate the cooling temperature of the detector to 0.3 °C over a distance of 60 meters. CO<sub>2</sub> detector cooling systems have been successfully applied in LHCb and the Alpha Magnetic Spectrometer (AMS) in the International Space Station (ISS). CO<sub>2</sub> cooling has acquired popularity at institutes and universities, and a compact cooling system has been designed for the European XFEL.

#### **White Rabbit**

A collaboration between CERN and GSI Darmstadt, called White Rabbit, works on a fully deterministic Ethernet-based network for general purpose data transfer and synchronisation. The aim is to be able to synchronise about 1000 nodes with sub-ns accuracy over fibre and copper lengths of up to 10 km. This technology is of special interest for the data-acquisition system of KM3NeT and timing systems for future colliders and FELs.

#### **Tasks and responsibilities**

In the next two to three years the group will be involved mainly in the further development of large position sensitive sensors for both X-rays and charged particles and the development of robust detector systems for leading-edge experiments, that are read-out by pixelated CMOS ASICs as active anode. The main research topics are semiconductor detectors, gas and noble liquid detectors, microelectronics, applied optics and enabling technologies.

#### **AIDA**

The Advanced European Infrastructures for Detectors at Accelerators (AIDA) proposal has received top grades from the European Commission. This detector development project will start in 2011 and Nikhef has responsibilities within the Advanced Infrastructure for Detector R&D work package. The first task on Gaseous Detector Facilities includes the upgrade of the existing Large TPC Prototype infrastructure at DESY, the production of large area MPGDs and the development of a common read-out system for gaseous detectors. The second task on Precision Pixel Detectors includes a versatile beam telescope and the evaluation of thermo-mechanical properties of Vertex Detector prototypes. The Detector R&D group has proposed an R&D programme to develop and optimise gaseous pixel detectors for use in the ATLAS Inner Tracker upgrade and linear collider TPC. This requires performance demonstrations and developing large-scale manufacturing techniques. The ATLAS Executive Board supports this R&D effort and will in 2013 review the results and consider if there are sufficient elements for further pursuit of this technology. Hence, Nikhef is very active in the RD51 collaboration to advance technological development and applications of MPGDs and associated electronic-read-out systems.

#### **RasCLIC in CTF3 (CLIC)**

The CLIC pre-alignment study is a collaboration between Nikhef and CERN and will run through 2013. The proposal requires the design, construction and calibration of short and long range optical alignment systems, based on RASNIK and called RasCLIC, monitoring the position of the final focus quadrupoles on each side of the interaction point. The target accuracy is a few microns over a sliding window of 200 m with respect to a straight line, along the whole 20 km long linacs. The two alignment systems will be validated through inter-comparison tests in the two-beam 8 m long CLIC Experimental Area and in a 500 m CERN accelerator environment with nominal radiation fluencies and magnetic fields.

#### **Hidralon**

Nikhef is involved in the characterisation of various sensor materials for X-rays with energies higher than 20 keV, commonly used

in medical and industrial applications (Hidralon project). Materials with better absorption than silicon are considered, such as gallium-arsenide and cadmium-telluride. However, the growth of monocrystalline high-Z materials is still an immature technology and the influence of various fabrication steps on the detection properties need to be investigated. To enlarge the sensitive area by means of tiling, the amount of dead material and the inactive sensor area along the edges needs to be minimised. Hence processes like Through-Silicon-Via (TSV) for 3D assembly and novel dicing techniques to reduce charge injection via edge-defects are under development to form so-called 'edgeless' sensors.

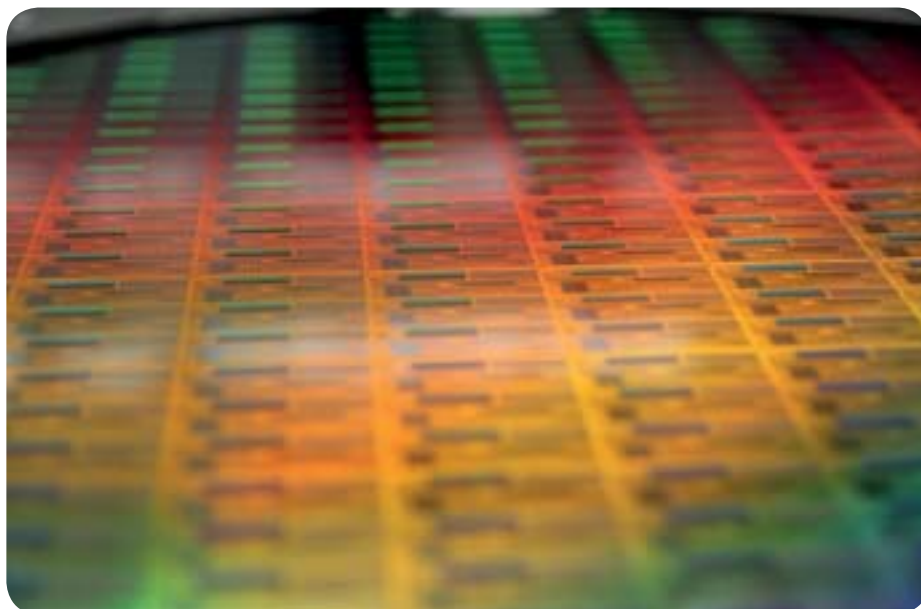

Figure 2.3.2.2. A close-up of chips in 45 nm technology on a 300 mm wide test wafer from NXP Semiconductors.

## Potential applications

### LHC upgrade plans

For the LHC upgrade plans, the LHCb and ATLAS vertex detector groups are considering to build new faster read-out to be able to use detached vertex information at an early trigger stage. As a consequence, at the LHCb experiment the entire pixel vertex detector needs to be read out at 40 MHz. This requires a new read-out chip, called VELOpix that will be derived from the Timepix chip. The R&D group will be involved in the chip development and testing of this advanced detector concept. An important aspect is the radiation hardness of the semiconductor devices, which will be studied within the CERN RD50 collaboration. Another challenging obstacle of CMOS scaling is a rapid increase of power dissipation per chip area. Here, Nikhef can build on the extensive experience with CO<sub>2</sub> cooling.

### Next generation noble liquid TPC

The Dark Matter activity at Nikhef requires R&D in noble-liquid detector technology. The R&D group will get involved in the development of a dual-phase MPGD with low-background requirements, cryogenic operation and shielding. For the DARWIN design study noble liquid will be studied as detection medium. Nuclear recoils caused by WIMP scattering can be distinguished from background induced electron recoils via efficient detection of both the scintillation light and ionised electrons. A dual-phase xenon TPC using GridPix for direct electron detection, will be built to explore the potentially better background discrimination and lower intrinsic background compared to PMTs.

### X-ray, ion and electron imaging using the Medipix chip

In a joined project with AMOLF, the R&D group plans to develop detector systems with increased sensitivity and better spatial resolution for biomedical imaging based on the Medipix chip family. Two areas in biomedical imaging are targeted: molecular histology of biomedical tissue sections and energy dispersive X-ray imaging. A Timepix based pixel detector together with centroiding algorithms provides an ion imager with sub-pixel precision. The timing information allows each pixel to act as a time-of-flight mass spectrometer. For energy dispersive X-ray imaging, the new Medipix3 chip allows separation of incoming X-rays based on their energy, where each energy range defines a specific element.

### (Inter)national position and ambition

With its tradition and expertise in development and construction of (large) particle detectors, Nikhef is well placed for the future. At present, the Nikhef R&D group participates in the LCTPC collaboration for the read-out of a large volume TPC as main tracker for the ILC. As mentioned, Nikhef joined the CLIC test facility programme CTF3 at CERN via the RasCLIC alignment proposal. We will exploit a potential collaboration with KVI in Groningen on their plans to build a soft X-ray facility (ZFEL). Nikhef received funding from the European ASPERA programme for the DARWIN project. The R&D group is also exploring the possibilities of contributing to Nikhef's Advanced Virgo/Einstein Telescope responsibilities.



It is our ambition to keep this leading role in the development and application of pixelated read-out of gaseous detectors, both at the ILC and as possible detector upgrades for the ATLAS experiment, and strengthen our role in detectors for astroparticle physics experiments. J. Timmermans is spokesperson of the LCTPC and E. Koffeman is the national contact for the AIDA project in The Netherlands. J. Visser is a member of the Medipix and Hidralon collaborations. E. Heijne is a board member of the IEEE Nuclear and Plasma Sciences Society (NPSS). M. van Beuzekom is deputy project leader of the LHCb vertex detector and involved in associated detector upgrades. N. van Bakel is involved in Amsterdam Scientific Instruments.

### Knowledge transfer

Nikhef has a long-standing expertise in the development of radiation detectors, necessary to carry out research at the scientific frontier. This expertise is to be maintained and exploited for scientific purposes and is a contribution of particle physics to technological innovation. With their expertise, R&D group members are frequent consultants to industrial companies and to scientists in other fields.

The cost of prototyping, even for R&D purposes, can become prohibitive when one needs to use the newest semiconductor processing technologies. To continue R&D at the technological frontier, collaborations have been set up with several (technical) universities in the Netherlands and abroad, with the KVI in Groningen, and with specialised microelectronics institutions like IMEC in Belgium. Close ties are maintained with the CERN microelectronics group. The strong generic detector R&D activity at Nikhef has been successful in acquiring external support when industrial applications seem feasible. This includes the transfer of Nikhef's Medipix technology to Dutch industry (PANalytical) and the European Hidralon project to develop a new generation of CMOS imagers for healthcare and industrial safety.

Cross-disciplinary projects have evolved in collaborations with e.g. AMOLF to develop detectors for biomedical imaging, CO<sub>2</sub>-based cooling technology for the European XFEL, and in the near future within the Dutch Innovative Medical Devices Initiative (IMDI) on radiotherapy and diagnostic imaging. Several other smaller scale industrial partnerships and/or contacts exist with the Fraunhofer IZM and IIS Institutes (Germany), VTT Technical Research Centre (Finland), Philips and PANalytical (Netherlands), Canberra (Belgium) and others.

Valorisation of two innovative concepts developed in the R&D group resulted in two high-tech start-ups. Sensiflex is marketing high-precision displacement monitoring systems using RASNIK technology and Amsterdam Scientific Instruments will build Hybrid Pixel Detector Arrays for industrial and photon science instrumentation, based on the Timepix chip and edge-less sensor development.

### New investments

Nikhef has a cleanroom infrastructure well suited for developing radiation detectors with an emphasis on testing and prototyping. Most of the investment money in the R&D phase of detector development will go into CMOS chip design via 'multi-project wafer' submits and in developing the fabrication process for MPGD. The current CMOS technology test runs are rather expensive, about 30 k€ for a test circuit surface of 2×3 mm<sup>2</sup>. Expensive engineering runs of a few 8" wafers clearly need to be funded within a larger collaboration (e.g. ATLAS upgrade) or larger R&D collaborations like Medipix or AIDA. It is estimated that two to three such test runs per year and per project would be needed.

Testing cryogenic detector concepts requires a considerable investment in the coming years to set up an infrastructure, ranging from elementary cold tests of detectors and materials to a full-scale operation of detector prototypes in a dual-phase noble-liquid environment.

### Personnel

It is our ambition that the detector R&D group would consist of about 15 academic staff: research and instrumentation physicists, postdocs and PhD students. Currently the group consists of four fte permanent staff physicists, one postdoc, six PhD students and several undergraduate students and visiting scientists. Three staff positions have been refilled in the last two years after retirement of senior staff. The retired staff is still part-time available. For technical support, at least two fte, well experienced chip designers should be available, in addition to about two fte general purpose electronic engineers. For mechanics design and construction one engineer is available, while about one fte designer and 1.5 fte technician are needed. Finally, one fte is needed for computing support in areas like DAQ, slow controls, Medipix/Timepix software and controls (FPGAs). On project basis members of the physics programmes collaborate with the R&D group.

## 2.3.3 Physics data processing: Grid computing



### Mission

Operation of state-of-the-art computing resources for Nikhef physicists, participation in national and international distributed computing infrastructures, and R&D on large-scale scientific computing.

mation of the facility, in an effort to increase reliability (average in 2010: 96%); secondly, improvements of the infrastructure to keep pace with increasing demands from the experiments and physicists (for example the recent increase from 10 to 160 Gb/s internal bandwidth to support physics analysis) and finally our efforts at a national level to arrange for sustained funding of the Dutch e-science infrastructure (including the Tier-1).

Our 'security' project line will continue; security remains an aspect of distributed computing that tends to touch all areas of the system, meaning expertise here has real strategic value. It is also an area that can have a large (often detrimental) effect on computing performance. Our group is committed to finding the opti-

### Introduction

Most high-energy physics (HEP) being done today would be impossible without computers. LHC data analysis is done on a worldwide computing-grid infrastructure, the LOFAR project in the Netherlands uses a supercomputer to convert a large collection of networked radio antennas into a telescope pointing simultaneously in eight different directions, and experiments at accelerators typically have a 'trigger farm' of hundreds or even thousands of computers, used to select the interesting data out of the deluge (tens to hundreds of terabits per second) of incoming detector information.

Nikhef has a history of leadership in HEP computing, extending at least as far back as its early participation in the internet (RARE/Terena, RIPE, the Amsterdam Internet Exchange) and WWW (Nikhef's site was world's third one created). Nikhef began work on building the LHC distributed computing infrastructure in 2001, with three staff members. This initial investment developed into a Tier-1 LHC computing facility in Amsterdam (partly housed at Nikhef), a 5 M€/year national grid project, and a large group of talented people working in close collaboration with colleagues from other sciences and with ICT resource providers.

### Programme

The basis of the Tier-1 infrastructure has been realised. Efforts in this area are threefold: firstly, improving the monitoring and auto-

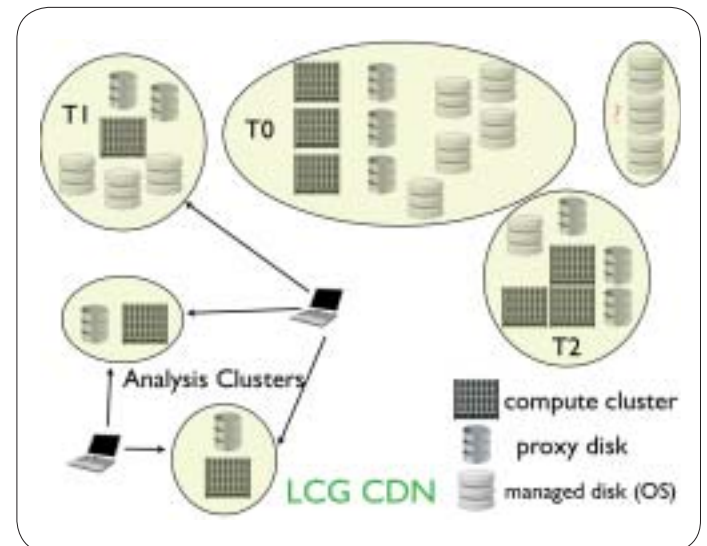

Figure 2.3.3.1: LHC Computing Grid 'Content Delivery Network' (CDN), a new idea for HEP Data Management (i.e. using local proxy disks), discussed at the Jamboree on LCG Data Access and Management in Amsterdam, June 2010. It shows how CDN ideas could be used to re-implement what we currently call Tier-0, Tier-1, and Tier-2 centres, as well as how we could connect local analysis facilities to the grid, and implement archive facilities without associated computing (upper-right oval with question mark).

mum balance between the security needed to prevent break-ins or misuse of the system, and the excellent performance needed by our physicists.

In 2010 we started a new project line in the area of grid data management. Now that the LHC is running, we have observed that the experiment 'production' activities work relatively well, but user analysis often suffers from poor performance, which is nearly always traceable to a mismatch between what the user is attempting to do and what the grid data storage is able to provide. We intend to expand our efforts in this area in the coming years.

### Analysis

With the LHC grid in full operation, we are making measurements of the response of the distributed system to the user activities. This effort has just started in 2010 and could be classified as 'experimental computer science'. The first measurements involve data flows in LHCb and will be part of the thesis work of a student.

### Tasks and responsibilities

Continuing operation of the Dutch Tier-1 grid computing facility.

### Longer term prospects

Many unknowns should be answered in the coming years and those answers will determine to a large extent the direction in which our group will move, aside from the move already being started now in the area of grid data management. Questions are: how will grid computing interface to the 'cloud'? Will the experiments be able to rewrite portions of the experiment frameworks in order to be able to utilise Graphics Processing Unit (GPU) clusters? How will the new work in the area of data management affect the data storage requirements of the experiments? As processor clock speeds stabilise and the number of cores per chip increase, how will HEP codes scale?

Given the history of HEP computing (and computing in general), we can be virtually assured of a good supply of interesting and relevant computing issues to study and develop. Which ones we choose to pursue is largely a question of funding. Our group's current strong focus on grid computing and e-science is not only due to HEP's choice of grid computing as a platform, but also our success in acquiring funding in this area. Success in our efforts towards sustained funding for the national e-science infrastructure would likely result in a continuation of the current research lines, with gradual evolution, such as the current move towards R&D in data management.

### e-science in the Netherlands

Grid computing –and its kid brother Cloud computing– are not specific to high-energy physics. Nikhef has collaborated on grid computing with scientists in other fields since the start of our grid project. Through a series of national e-science projects, mostly notably the Virtual Laboratory (VL-e), a major e-science infrastructure project, BiG Grid, was realised in 2007, with Nikhef playing several key roles: membership on the directorate, expertise in 'gridification' of new use cases, and functioning as one of the largest operational partners of the BiG Grid infrastructure. The Dutch Tier-1 is a service provided by the BiG Grid infrastructure. The majority of our staff is funded at least partially through BiG Grid, and several staff members are working primarily on collaborations with scientists from other fields.

BiG Grid is a 28,8 M€ project that runs from 2007 through the end of 2012. The scientific community and the government have recognised the value and need for this infrastructure, resulting in a national infrastructure plan that would bring sustained funding and operation for most of the BiG Grid activities, including housing and operations of the Tier-1, under the SURF Foundation (that currently runs the excellent Dutch research network SURFnet). The more research-oriented Dutch e-science activities are being brought under the national eScience Center (located close to Nikhef in the Amsterdam Science Park); this will include some of the HEP computing R&D projects done by our group.

### (Inter)national position and ambition

Nikhef is well represented at both the national and international level in grid computing. At the national level, Nikhef supplies one of the three directors of the national grid project, and plays an important role as a provider of both expertise and computing resources. At an international level, Nikhef benefits greatly from having the European Grid Infrastructure (EGI) main offices located in the building next door. Nikhef staff members also occupy key roles in the experiments' computing (K. Bos, ATLAS computing coordinator) and in international standards organisations (D. Groep, director of both EUGridPMA and IGTF).

### Knowledge transfer

Knowledge transfer proceeds mostly through our active involvement in the national e-science project 'BiG Grid'. In the past year we have completed a joint project with the Max Planck Institute



Figure 2.3.3.2: LHC Tier-1 machines in the new Nikhef data centre, commissioned in 2009.

for Psycholinguistics, and have started a new collaboration with the Dutch Royal Library. The Nikhef grid cluster that supplies part of the Dutch LHC Tier-1 resources also routinely serves other communities, a recent example being the eNMR project.

#### **New investments**

As mentioned above, the group is very active in securing sustained funding for Dutch e-science infrastructure. Such funding will comprise not only the funds needed to purchase the hardware, but also those needed to pay for operations personnel and for R&D/support manpower.

#### **Personnel**

The permanent staff consists of excellent people and the size is adequate. There is a sizeable number of temporary staff on contract. For the moment funding is adequate to hire these people as needed. It remains a challenge to find suitably qualified candidates. Future prospects are dependent on the sustained funding mentioned above.

## 3 Technical Skills and Infrastructure

## 3.1 Introduction

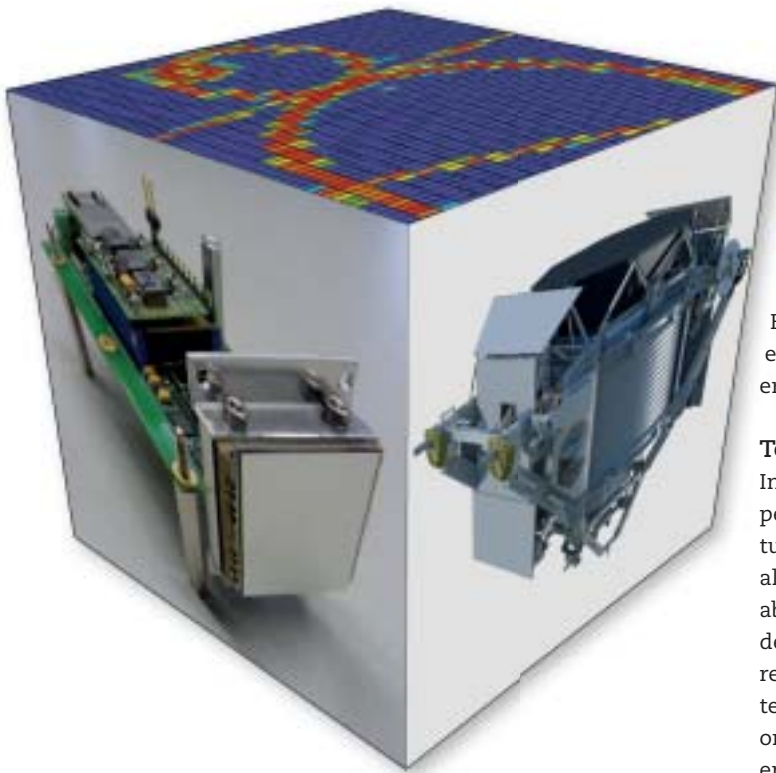

State-of-the-art accelerator and detector technology is of crucial importance for our participation in international collaborations, preparing new experiments or upgrades of existing experiments. For each new endeavour the technologies are only defined after a highly competitive international selection process. In many cases scientific discoveries follow technological breakthroughs: subatomic physics is typically a technology enabled science. A typical example is the discovery of the W and Z bosons, the mediators of the weak interaction, which only became feasible after the development of stochastic cooling by Nobel-prize winner Simon van der Meer. In here, technology refers not only to the 'standard' disciplines like mechanics and electronics, but includes computing as well, as best illustrated by the development of the World Wide Web at CERN in the past and the recent development of the grid compute technology in view of the large data volumes (20 PB per year) and high CPU requirements needed for the analysis of the measurements at CERN's Large Hadron Collider.

### Partners in technology

The experiments Nikhef is engaged in are without exception large and international. Nikhef's scientific and technical staff collaborate not only with the personnel at the large international accelerator centres but also with colleagues from institutes and universities, in Europe and in the U.S. On a national level, Nikhef

has, in particular in the field of astroparticle physics, contacts with institutes like KVI (Groningen), ASTRON (Dwingelo), SRON (Utrecht), NIOZ (Texel) and with the optical data transmission group of the TU/e (Eindhoven). In the field of grid computing, Nikhef collaborates with SARA (Amsterdam), RC-Groningen (Groningen) and academic research groups. On microelectronics Nikhef has a close collaboration with CERN and the MESA+ institute of the University Twente (Enschede). Because of their neighbourness Nikhef and AMOLF make use of each other's infrastructure for specialised equipment like spark erosion and 3D metrology.

### Technical departments

In general, Nikhef has highly motivated and experienced technical personnel, working in an outstanding local technical infrastructure. This attracts many apprentices and applicants for vacancies, also stimulated by a PhD track for technical personnel. We were able to temporarily increase the number of technical positions to deal with the high workload for the LHC experiments and plan to repeat this policy if needed. To date, technicians employed on a temporary contract have easily found employment in industries or at other institutes as skilled technicians. Hiring of new experienced personnel can be difficult, especially for the computing and electronic departments. The age profile of the technical personnel is still rather unbalanced. Moreover, insufficient funding in this area risks the size of the Nikhef technical departments to become sub-critical. We plan to strengthen the know-how in Nikhef's technical departments further through industrial partnerships in the areas of pixel detectors, optical communication, grid computing and possibly CO<sub>2</sub>-based cooling applications. Maintaining and upgrading the excellent cleanroom facilities will give us good opportunities to participate in the forefront of technological developments in the future. The technical departments are the place where expertise is developed and maintained. This knowledge must be preserved and extended with new techniques by keeping up with professional literature, intensifying collegial contacts within and outside FOM, by visiting exhibitions and companies and by exploiting other national and international contacts.

## 3.2 Facilities



Nikhef has a number of facilities (laboratories, cleanrooms, special equipment) to support its scientific mission. For decades, the excellent infrastructure has enabled us to build detectors, from small to very large size. Having production lines for quality detectors will remain important in the future. This section describes the ambitions and planning with respect to maintaining and upgrading our facilities.

### Cleanrooms

Detector R&D makes use of technically advanced methods like custom chip-design, wafer-scale processing, die-bonding, wire-bonding, flip-chip bonding, 3D interconnections, integrated detector micro-systems, super-light materials, and CO<sub>2</sub>-cooling technologies.

To stay at the forefront of these technologies, Nikhef has upgraded the facilities for all chip- and wafer-(post)processing. The upgrade included a refurbishment of the 'Silicon Alley' area and re-installing one of the smaller cleanrooms to its original class 1.000 status. In Silicon Alley most of our detector R&D for LHC detector upgrades, for ILC detectors and for contributions to astroparticle-physics experiments will be concentrated. These facilities are on a cost recovery basis also available to our technology transfer partner PANalytical and the wafer prober is used occasionally by other companies.

Since CMOS electronics wafers will be produced in large semiconductor foundries, and high-resistivity sensor wafers will be obtained from specialised detector companies, the Nikhef investments have been concentrated in wafer post-processing and die-processing, as well as on wafer inspection and die inspection, quality assessment, fault analysis, and small to medium-volume detector-module production.

Nikhef can access specialised technologies, like photo-lithography, chemical processing and ion-implantation, through contacts at MESA+ (University of Twente), Dimes (University of Delft), and IMEC (Leuven, Belgium).

In total, Nikhef has seven cleanrooms with all in all 740 m<sup>2</sup> floor space. The large 170 m<sup>2</sup>, class 10.000 cleanroom, constructed inside the big assembly hall, is reserved for large detector construction tasks, currently for the Advanced Virgo experiment.

### Computing/housing

After the 2009 expansion Nikhef avails over computer infrastructure space up to 500 m<sup>2</sup> on the first floor, housing the Amsterdam Internet Exchange (AMS-IX) customers (about 260 racks) and about 150 m<sup>2</sup> on the second floor, housing its own computing, storage and networking equipment and the grid/Tier-1 resources (about 60 racks). The expansion also included a thorough upgrade of the facility to meet current standards with regard to redundancy. In December 2010 the facility obtained the 'AMS-IX certified' accreditation by the Amsterdam Internet Exchange.

Figure 3.2.1.  
The AMS-02 project logo. A CO<sub>2</sub>-cooling system for the silicon trackers of this experiment – on the last Endeavour shuttle mission to the International Space Station – was developed by Nikhef.



### Former accelerator and experimental buildings

From its past activities with the MEA/AmPS accelerator Nikhef has inherited a complex of buildings with a total floor space of about 10,000 m<sup>2</sup>. A little less than half of the building area is leased to a UK-based data centre company (TeleCity), which has in 1999 chosen this location specifically because of the nearby Internet Exchange facilities at Nikhef and SARA. The lease contract covers a period until 2015 with an option to extend to 2020. About 1,200 m<sup>2</sup> (called the 'Atenlab') is leased to Grontmij|AquaSense, a company on water quality assessment. This lease contract has ended per 31 March 2011. The Atenlab most likely will be torn down.

The largest experimental hall, called the Emin hall, has currently no particular destination, although two ideas exist: to house the assembly station for the KM3NeT strings and to install a semi permanent attenuator test-tower for Advanced Virgo.

The complex of buildings also contains a large, class 10.000 cleanroom (270 m<sup>2</sup> divided over four separate rooms), which has been used for the assembly of the LHCb Outer Tracker straw tubes. As long as there is a possibility, that due to the ageing issues these modules need to be rebuilt, Nikhef is very careful in committing this cleanroom to external parties.

The future of the former accelerator building complex is to be decided by the landowner (NWO), which is currently discussing with our tenant TeleCity the option to build a new data centre facility, adjacent to their current one.



Figure 3.2.2: KM3NeT optical-module prototype –built in the Nikhef workshop– consisting of a 17 inch pressure resistant glass sphere and 31 small photo-multiplier tubes (the pressure gauge is used to measure the applied under-pressure required for water tightness of the two hemispheres at all depths).



## 3.3 Technical departments



### Mechanical technology

On 1 January 2011 the mechanical engineering department and the mechanical workshop have merged into one department of Mechanical Technology. This department will be the key partner for designing, developing and realizing mechanical solutions for the subatomic physics projects at Nikhef.

The integration aims at synergy between different competences of technicians and engineers to achieve better teamwork and hence better performance. To accommodate the different projects at Nikhef many different types of knowledge are needed as well as congruence between the manufacturing and engineering domains. Important focus points for the group are to develop a broad and deep knowledge base, a high-absorption capacity, broad thinking and a higher-order learning capacity. Flexibility is also an important focus point and in combination with established routine should increase overall efficiency. This is particularly important to be able to cope with increased regulatory pressure, like personnel safety and CE (EU safety) marking requirements, but also to implement best practices.

To achieve integration and synergy within the mechanical technology department the housing of the group will be adapted. The plan is to bring engineers and technicians physically closer together to

enhance internal communication and hence the teamwork. Within the group plans are being made and proposals prepared for the directorate.

The mechanical workshop will be investing in new equipment in the coming year to modernise the machine park. We anticipate replacing the CNC lathe and the large milling machine and acquiring a 5-axis simultaneous milling machine for complex structures with double curved surfaces. These new machines will help increasing quality and flexibility. New techniques, like rapid manufacturing and using composite materials have our attention and will be closely followed. With the new generation of machinery, the digital exchange by means of Computer Aided Manufacturing (CAM) techniques should be brought to a higher level.

Within the engineering group Computer Aided Design (CAD) and Computer Aided Engineering (CAE) are the main working tools for developing products. Usually, during the development of complex products, many propositions need to be worked out and tested before a good idea is turned into a successful product. To efficiently manage changes, an explicit design methodology is important and the design process has to be managed properly. Product Lifecycle Management (PLM) has the ability to control product information throughout its complete lifecycle. The last year the mechanical engineering group has started the implementation of PLM. CAD and engineering data are now controlled in the PLM system and in the coming period it will be made available for employees throughout Nikhef.



Figure 3.3.1. The automatic bonding machine, operated by Joop Rövekamp.



Figure 3.3.2.  
Bases and HV power supplies  
for a KM3NeT detector.

synthesis with automated software tools into hardware is increasing. New enhanced design verification methodologies for IC- and FPGA design will be explored to handle the increasing complexity.

The design of printed circuit boards (PCBs) is becoming more and more complex, with increasing density and higher frequencies (high-speed communication) on the board. Therefore, investing in advanced tooling and skills of the designers is a necessity. In this area close contacts with industry will be established.

Technologies in which we have invested heavily and will keep investing in, are: special connection and bonding techniques, 3D (and other) measuring devices, wire bonding, CO<sub>2</sub> refrigerating and thermodynamics, light and rigid structures, composites and plastics, vacuum, and welding techniques.

### Electronics technology

To support the experimental programmes effectively in their search for subatomic particles with complex detectors, specific electronic equipment needs to be developed continuously. Experience with those detector systems and its equipment has led to new ideas for improvements. New technologies offer higher granularity detectors when full custom IC design is used, and offer higher data-rate capabilities for the data acquisition when using advanced FPGAs and fibre optic communication.

The use of flexible FPGAs (programmable logic) with built-in high-speed serial communication links is growing. These devices can communicate with commercial products as well as ICs that are specifically designed as detector front-end chip. It is likely that more data processing will be implemented inside the data-acquisition path, and thus inside FPGAs that make this possible. FPGA firmware design will be a major activity in the department. Therefore, the necessary design skills shall be developed further.

Data communication through copper cables is often a bottleneck, but the use of fibre optics opens new possibilities and so, investments in knowledge and instruments in this field will continue.

Developments of new detector types require very specific electronic circuits, often with high integration density and with low power consumption in particular in the area of detector R&D. In these cases the use of IC design is inevitable, and therefore this technology will remain a major expertise area of the department. In addition, design methodologies are also evolving. The use of abstract hardware description languages to model a system, and for

To ensure that electronic components close to each other in detector environments will operate correctly, Electro-Magnetic Compatibility (EMC) characteristics must be verified, and taken into account during the engineering phase of the projects.

The electronic engineering work, together with the responsibility to keep the present systems up-and-running for over a 10 year period are challenging tasks, but can be achieved by a close collaboration between researchers and the technology department, and by maintaining good contacts with industry. The goal at Nikhef is to focus on the core expertise and outsource production work.

### Computer technology

The computer technology department (CT) is responsible for the information and computing technology (ICT) infrastructure at Nikhef and contributes with technical manpower to the scientific programmes. Beside these tasks the CT has taken responsibility for the daily operational support of the AMS-IX housing facility at Nikhef.

### System and network management

Nowadays users of Nikhef ICT services demand a 24x7 availability of these services, like they are used to do from the commercial parties which provide internet banking, web shops and so on. The Nikhef CT system-management group is only able to offer a 24x7 support for the Nikhef ICT services on a best-effort base. Especially outside office hours we cannot guarantee a prompt reaction within a reasonable time frame. We benefit from the presence of LCG Tier-1 infrastructure, which shares basic elements with the local Nikhef ICT infrastructure. Operators of the LCG Tier-1 infrastructure do monitor their services outside office hours on a best effort base as well and by doing this they take part in the outside office hours support for the Nikhef local ICT services.

Our policy is to implement as much as possible redundant systems for critical services, like the recently renewed high-availability mail clusters, a robust central file server and a fail-over 10 Gb/s connection with our internet provider SURFnet. In our recently built new data centre on the second floor in the Nikhef building we take enormous advantage of the state of the art no-break power and cooling systems that have been built for the internet exchange data centre on the first floor of the building.

Nevertheless, we will be more and more confronted with the question whether we want to build and operate the services ourselves or outsource it to 'the cloud' operated by commercial parties. Our strong point is the presence of the LCG Tier-1 resources at Nikhef, including a group of experts designing and operating these resources. A major point of concern is that the average age of the members of the local ICT operations group is somewhere between 55 and 60 years. Rejuvenation of this group by hiring young people is the challenge for the coming years.

Nikhef is a member institute of the SURFnet federation. Employees of a member institute may use their own local computer account to subscribe to all kind of services in the federation offered by third-parties. Examples are the SURFspot webshop, the Elsevier ScienceDirect articles database and the EduRoam wifi infrastructure. To become a member of the SURFnet federation, one has to deploy a user identity management system which has to be approved before it is accepted as trusted. Nikhef runs an identity management system centred on an OpenLDAP repository connected to the database maintained by the personnel department.

Nikhef operates a small compute cluster with storage servers. This set up is integrated in the Nikhef desktop environment and intended for small-scale analysis of data sets. We will continue the operation of this cluster and expand it even somewhat more, but at the same time we will facilitate and stimulate the usage of LCG Tier-1 grid resources. For the massive analysis and storage of LHC data, the distributed grid is the only way to go. A substantial CT manpower effort (8 fte) is dedicated to grid computing, not only for LHC, but also for the Dutch scientific community in general (BiG Grid). More information can be found in the chapter about the Physics Data Processing programme.

#### **Instrumentation projects**

A small section of the computer technology group is assigned to instrumentation projects at Nikhef (3-4 fte). Apart from the maintenance and support provided to the running LHC experiment are the members of the 'software-engineering' section involved in design and testing laboratory activities at Nikhef, especially on the

borders of the ICT infrastructure and the electronic and mechanic equipment developed at Nikhef. Although this activity is small in terms of the number of fte involved, it is recognised as useful to overcome the bridge between hardware and software and to sustain continuity in the instrumentation projects in this 'grey area' between technologies.

#### **Internet exchange housing services**

In the previous strategy report we did foresee a necessary upgrade of our data centre to a 'professional level'. Remember that Nikhef started facilitating customers of the Amsterdam Internet Exchange about 15 years ago. In these early days of operating internet exchanges, the demands put on the availability were very modest compared to today's standards. Recently we have finished the data centre upgrade project. Almost all key components of the data centre infrastructure have been replaced by modern and above all redundant systems: a cooling plant on the roof of the building, a second no-break power feed, a gas suppression system, a monitoring system exclusively for the data centre, etc. Moreover, we have adapted our organisation to the new situation by outsourcing almost all 24x7 standby services to external companies and by creating a new function in the organisation, i.e. head data centre services, with responsibility of daily operations of the data centre infrastructure. As a kind of bonus of this upgrade we have created our own state-of-the-art data centre on the second floor dedicated to Nikhef local ICT and LCG/BiG Grid resources. Very recently the AMS-IX organisation has audited our datacentre, which resulted in a formal certification of the site conforming to their high standards.

As agreed upon with the Nikhef management, the housing activity will be evaluated every five years. The next evaluation is scheduled for 2011. The options we have are either not to extend anymore (leave it to what it is) or to expand the data centre one more time by constructing a hall upon the roof of the mechanical workshop. The outcome of this discussion is still open at the moment.



Team de Jong after winning the € 100,000 Academic Year Prize in 2009. Centre-front is Sijbrand de Jong, holding the cup is Charles Timmermans. The award –an initiative of the Dutch newspaper ‘NRC Handelsblad’ in cooperation with NWO and other organisations– honours the best proposal to make scientific research accessible to a broad audience. The prize money was used to host a dance event during the Nijmegen 2010 Summer Festival in which cosmic rays triggered live dance music.

## 4 Outreach, Education and Knowledge Transfer

## 4.1 Outreach and education



Nikhef acknowledges the responsibility to convey its research not only within the scientific community but also to a broader audience. The main target audiences Nikhef strives to address with a variety of activities are: the general public, the media, science and technology decision makers, potential industrial partners and the educational system, in particular at secondary school and university level.

The general objectives as stated in the mission, translate into specific aims regarding different target audiences. Based on the deep-rooted interest of society in frontier science, Nikhef informs and entertains the general public to encourage engagement with scientific issues. Nikhef establishes and maintains good relationships with the media that function as an important vector (multiplier) to reach the general public. Nikhef aspires to be appreciated by the media as a reliable source of information. To promote Nikhef's research activities in particular and particle physics in general, science and technology decision makers are routinely informed about the successes of research conducted at Nikhef and Nikhef's future ambitions. Nikhef investigates possible partnerships with industry to incorporate the advanced technological solutions developed in the framework of fundamental research into other applications. To stimulate young people's interest in science and technology and to ensure a sufficiently large influx of new physics students, Nikhef engages in sci-

### Mission

- To foster appreciation and support for Nikhef and (astro)particle physics in particular, and science in general;
- To convey the importance of fundamental research fulfilling the intrinsic desire of mankind to explore;
- To position fundamental research as a driving force for knowledge increase, technological innovation, and scientific education.

ence education at all levels, in particular at secondary school and university level, passing on the fascination of science research.

For a broad assistance by its own staff in achieving these goals, Nikhef assures comprehensive internal communication and encourages extensive involvement of the Nikhef community, recognizing that every member of Nikhef is a potential ambassador for the institute and particle physics.

Nikhef collaborates with both national and international communication networks to achieve these goals. To this end, the Nikhef communication department works together with:

- The communication staff of the other institutes at the Science Park Amsterdam;
- The communication staff of the FOM organisation and the FOM-institutes AMOLF and Rijnhuizen;
- The Platform for Science Communication in the Netherlands ('Platform Wetenschapscommunicatie PWC');
- The European Particle Physics Communication Network (EPPCN);
- The International Particle Physics Outreach Group (IPPOG);
- The outreach committee of the ASPERA European network for astroparticle physics;
- The InterAction collaboration of communicators for particle physics laboratories worldwide.

Over the past years, Nikhef has developed new and improved existing communication activities for all its target audiences. This has resulted in a strong and continuous interest in and support for Nikhef's research. Especially for the general public, the media, and schools, there has been a variety of activities. In particular the start-up of the Large Hadron Collider at CERN has generated much attention, and in its wake Nikhef has been able to establish a successful platform for communication.

The challenge of the nearby future will be to maintain and possibly even increase the current level of interest and support among all target audiences. To achieve this, Nikhef's communication strategy envisages to concentrate on the following approach:

Figure 4.1.1. A half life-size photo of the ATLAS detector at the façade of the Nikhef workshop. This way visitors to the Science Park get a impression of the size of the experiment.



- To keep up providing continuous updates on results from the LHC;
- To enhance communication on topics from the field of non-accelerator physics research;
- To investigate the possibilities of interactive social media communication;
- To increase communication activities aimed at decision makers, industry and the Nikhef community.

A rich palette of activities for all target audiences is to be organised in the coming years. In the following, the activities that have proven successful in the past and are intended to be followed up in the future as well as planned new activities, are listed.

### General activities for all target audiences

Nikhef is continuously improving its website ([www.nikhef.nl](http://www.nikhef.nl)). A completely new website launched in 2008 provides communication platforms for all target groups. Both for external and internal communication, there is general background information available as well as lots of up-to-date news and event announcements. Since the modern web-users are more and more graphically and visually oriented, Nikhef makes an effort to meet the increased need for photo and video material.

To distribute relevant information even more actively to a larger audience, a format for a regular email newsletter with frequent and up-to-date information is currently being developed. The newsletter is supposed to be launched in two versions, namely one for an external audience and one for the internal Nikhef community.

### Outreach to the general public

The general public is informed about the research done at Nikhef in various ways. During the yearly open day, visitors can explore Nikhef and learn more about the research conducted at this institute by means of exhibits, demonstrations, lectures or simply by chatting to scientists and technicians. Moreover, interested people are invited to attend the Friday afternoon visits programme including a lecture, a film and a guided tour at Nikhef, which is routinely offered twice a month

On a regular basis, Nikhef scientists give lectures for the general public. This takes place in the context of science cafes, on request by associations and organisations like museums, or at internationally coordinated outreach events such as the European Researchers' Night.

Furthermore, Nikhef keeps developing new exhibits and improving existing ones like detector displays or dedicated demonstration experiments, shown at Nikhef or provided to museums or schools. For example, a new spark chamber installation built by Nikhef is included in the recently opened permanent exhibition about cosmic rays at the NEMO science centre. Currently, a new exhibit is being developed and built at Nikhef which will demonstrate the spatial distribution of cosmic rays.

In 2009 the project Cosmic Sensation won the academic year award. This project was realised in September/October 2010, making cosmic rays visible and audible with dome projected video images and dance music. This attracted a whole new audience of 18-28 year olds that would normally not visit scientific exhibitions.

### Media relations

Nikhef interacts regularly with journalists from print media, radio and TV stations in order to pro-actively provide information on recent research developments or to react to journalists' requests for interviews or background information. For all new research results and other interesting developments, Nikhef issues press releases, often in collaboration with science communication officers from other institutes like CERN or the Dutch universities.

Nikhef scientists frequently give radio and TV interviews. Especially the start of the LHC has attracted enormous media attention. The relationships established with the media during this period still bear fruit. Another boost of interest is expected as soon as the LHC delivers the anticipated discoveries. Furthermore, there is increasing public interest in the results from the growing field of astroparticle physics.

Wherever possible, journalists are also invited to visit experiments and facilities for a real (live) experience of recent research. There have been numerous guided tours organised to the LHC. With the tunnel now closed most of the time because of the op-



Figure 4.1.2. Nikhef staff member Ivo van Vulpen giving a presentation at the European Researcher's Night.

eration of the LHC, alternative attractive programmes need to be developed. On Nikhef's invitation, journalists have also visited the Pierre Auger Observatory in Argentina.

### Communication with decision makers

Strategic decisions regarding the funding of future research programmes or investments are made by the boards of the funding agencies and high-level civil servants after an assessment of all proposals by fellow scientists. Hence, Nikhef considers it very important to inform all these decision makers on a frequent basis about its research successes and ambitions.

The annual report is one means of communication towards fellow scientists and the various agencies. It features reports of all research programmes as well as several additional review articles, complete output and resources summaries, and an overview of Nikhef & society activities. Moreover, Nikhef staff members serve on several national committees, boards and review panels. This helps to foster mutual appreciation among fellow scientists from neighbouring fields of physics. Fellow scientists in the Netherlands are furthermore informed about Nikhef's research activities within the framework of the Dutch Physical Society. Regularly, members of the boards of Nikhef, FOM, NWO, Dutch universities and of the Dutch Ministry of Education, Culture and Science, are invited for dedicated visits to CERN.

### Education

Nikhef engages in science education at all levels, that is for primary and secondary school pupils and their teachers as well as for bachelor and master students.

#### Primary-school children

For primary school children between age four and twelve, Nikhef scientists participate in the organisation of the 'Techniek Toernooi', a yearly science tournament where the children compete in making simple constructions or carry out simple experiments.

#### Secondary school students

For secondary school students there is a variety of possibilities to interact with Nikhef scientists and to take part in research. Every year Nikhef welcomes a few hundred school students for visits at the institute, including a lecture, the showing of a short film and a guided tour. In addition, Nikhef scientists regularly give lectures at schools. Nikhef scientists also actively participate in the development of the new physics curriculum for secondary schools and the new secondary school topic of Nature, Life and Technology.

Several dozen school students every year carry out their 'profielwerkstuk' (dedicated science project in their final school year) on a topic within the Nikhef research programme and under the supervision of Nikhef staff. One of the projects developed for this purpose is measuring the muon life time with a detector set-up at Nikhef. Another project under consideration for the future is building a small simple cloud chamber. Also individual ideas of students are facilitated whenever feasible. School students between 16 and 18 can participate in an international 'Masterclass on Particle Physics' at Nikhef, an event organised every year in the framework of IPPOG and held simultaneously at many particle physics institutes world-wide. From 2011 onwards this Masterclass will include hands-on exercises on LHC data. Furthermore, there are plans to develop a new Masterclass on astroparticle physics.

The 'High School Project on Astrophysics Research with Cosmics' (HiSPARC), coordinated by Nikhef, aims at involving Dutch school students in all aspects of a true research project: from building a cosmic ray detector which is then installed on the roof of the schools, to data acquisition, calibration, analysis and reporting. Currently, there is a newly revived European initiative to tighten the collaboration of this kind of projects within a European network. Furthermore, Nikhef supports CERN visits of school students by providing Dutch guides for these tours.



### **Secondary school teachers**

Nikhef offers opportunities for school teachers as well. Nikhef scientists organise every year a one-day master course on particle physics for school teachers. As a follow-up, several school teachers get the possibility to participate in a CERN excursion of a few days. The past few excursions have been largely organised and financed by Nikhef. Since last year there is an ongoing effort to embed these excursions in the official CERN teachers programme. Furthermore, a few school teachers every year are enabled to take part in scientific research via the FOM teacher-in-research programme ('Leraar in Onderzoek'). Many of these teachers choose Nikhef as the institute where they spend one day a week working on research.

### **Bachelor & master students**

Nikhef is also involved in education at the bachelor and master level. Many staff members have appointments to give lectures and laboratory courses at one of the Dutch universities. Furthermore, a special Master's programme in Particle and Astroparticle Physics is jointly offered by Nikhef and its university partners, and firmly embedded in the research at Nikhef.

### **Graduate school**

All PhD students at Nikhef receive academic training through the Research School Subatomic Physics ('Onderzoeksschool Subatomaire Fysica', OSAF).

The mission of OSAF is the training of PhD candidates in subatomic physics to the highest international standard. OSAF is part of Nikhef and the scientific focus of the research training offered to the PhD candidates therefore coincides with the mission and research programme of Nikhef. OSAF is one of the ten research schools in the Netherlands that received a grant from the new NWO Graduate Programme in 2010. The grant, worth 0.8 M€, will be used for the appointment of four extra PhD students who will carry out their research within the school.

OSAF is furthermore currently working on a better integration of the Master education into the PhD phase. Although the success rate is high, with 93% obtaining their PhD, the average PhD duration of about five years is considerably longer than the planned duration of four years. Measures are therefore taken to encourage students (and their supervisors) to finish earlier.



Figure 4.1.3. Nikhef staff member Els Koffeman instructing secondary school students in a Nikhef Masterclass.

## 4.2 Knowledge transfer



### Mission

To seize opportunities to make the connection between our activities and 'third parties', be it industrial, societal or scientific.

becomes aware of the possibilities of using Nikhef technology in other scientific, industrial or commercial domains. One R&D staff member is appointed for setting up and maintaining industrial contacts as an explicit part of his task description.

Nikhef will continue to explore and use funding possibilities outside the regular FOM channels for this, in particular with STW ("Technological Sciences"), *Agentschap NL* (linked to the Dutch ministry for Economic Affairs, Agriculture and Innovation) and European framework funding. Attempts to obtain funding in the NWO framework of new instruments for health care have not yet succeeded, but will be pursued.

Nikhef will also actively take part in setting up spin-offs, if and when Nikhef staff and technology is involved in such enterprise, as recent examples have shown (*Sensiflex* and *Amsterdam Scientific Instruments*). In such cases Nikhef is prepared to take a (financial) share in such an enterprise, usually in the form of an in-kind contribution. Depending on the situation Nikhef might opt to also participate in the management of the enterprise.

Currently we have one Dutch patent (on *RASNIK*) and another patent on  $\text{CO}_2$  cooling, shared with CERN, is under consideration. Nikhef does not pursue a patent portfolio. Whenever we believe a Nikhef 'invention' might have a future outside particle physics, we prefer to find an industrial partner as soon as possible to accomplish this.

Although Nikhef's primary focus is and will always be curiosity driven research, there is an increasing awareness within Nikhef to seize opportunities to make the connection between our activities and 'third parties', be it industrial, societal or scientific. The words used for this are *knowledge transfer* or more trendy *valorisation*: the translation of knowledge into technology in order to create commercially viable products or services. In the Self Evaluation Report (chapter 'Knowledge transfer') we describe the valorisation activities that have taken place in recent years, along the lines of instrumentation (detector R&D), internet, networking and grid computing. In this chapter we describe how we see the evolution of these activities in the coming years.

### Instrumentation

Our detector R&D has been an extremely fruitful breeding ground for valorisation activities, such as those on pixel detectors and read-out with *PANalytical* (*RelaXd*-project), edgeless sensors with a.o. *Philips Research* (*Hidralon*-project), alignment (*RASNIK*, *Sensiflex*),  $\text{CO}_2$ -cooling and chip design (*Bruco*). Some of these initiatives are in the process of being transformed into spin-off businesses.

The detector R&D group has been strengthened considerably in recent years, with new staff appointed. We stimulate, that staff

### Internet Exchange housing (and data centre activities)

Housing a large share of the *AMS-IX* customers and many other Internet Service Providers has been part of Nikhef for over 15 years. In these years the number of differ-

ent customers has grown to around 120 companies, representing a sizable portion of the total public and private peering traffic in the Netherlands. Nikhef assesses on a five year basis how it will continue with this activity. Based on such assessment the decision has been taken in 2007 to upgrade and expand the data centre facility and build a separate computer room for Nikhef's own services



Figure 4.2.1. CO<sub>2</sub> evaporator cooling blocks of LHCb VELO modules with temperature sensors.



and for the grid services. This work has been carried out until the end of 2010, when our data centre facility was audited and labelled 'AMS-IX certified'.

In the coming one or two years Nikhef has again to assess how to proceed with this ever increasing and successful activity. With the current growth we might need to expand the facility again in 2013 or 2014. Technically this option has already been prepared as part of the recent upgrade. Ingredients for the upcoming assessment are a.o. the involvement of Nikhef staff (some of whom are about to retire within five years), the evolution of the service level as expected by the customers, the operational synergy with our grid activities (see next paragraph) and of course the balance between turnover and (investment and running) costs.

### Grid computing

In the last 10 years Nikhef has built up a very prominent position in the grid world, serving not only the particle physics community, but also many other sciences. We house and operate a significant fraction of the central grid facilities (including a share of the Dutch LHC Tier-1), as part of our BiG Grid responsibilities. We contribute significantly to the BiG Grid Support and Development activities and to middleware development. Until now Nikhef has been able to cover these activities for more than 75% from external (both national and European) funding.

In the next years it must become clear if and how the grid infrastructure, that has been built up, becomes funded permanently as part of the total ICT research infrastructure in the Netherlands, together with the research network (SURFnet) and the super-computer. The locus of control will shift to SURF, under which organisation a new entity will be created for computing and data facilities. In this new context and if so proposed by this new entity, Nikhef will be prepared to continue providing significant operational services to the Dutch research community, not limited to particle physics.

With regard to the grid development activities, Nikhef will enter into agreements with the freshly established eScience Center. The focus will be on Nikhef's unique capability to address scaling and validation issues in large distributed infrastructures. Furthermore, Nikhef will continue to pursue funding for its development activities (notably on community management middleware and grid security mechanisms) in the EU Framework programmes.



Figure 4.2.2. Network topology of a major international Nikhef AMS-IX client (Hurricane Electric).

### Industrial 'networking'

Next to the activities mentioned above, Nikhef interfaces in many more ways with the 'outside world'. Our industrial liaison officer informs Dutch industrial parties about upcoming CERN-tenders. He has also organised a successful 'Holland@CERN' symposium. It is relevant to mention here, that the 'return on investment' in CERN to Dutch based industry has been a sizable 286 million CHF in the period 1996-2008, usually on cutting edge technology, thus broadening the Dutch technology base. Furthermore, our technical groups (mechanics, electronics, computing) have regular contacts with industrial parties. With some frequency industrial networking meetings are organised to inform each other on recent technological advances. Finally, Nikhef has an open policy with regard to giving external parties access to the Nikhef technical facilities, on a cost recovery basis. In this way, our 'Silicon Alley' facilities for semiconductor detectors, containing equipment for probing, bonding, precision measurement and diagnostic EM, have been used by several companies, notably PANalytical.



the dutch e-science grid



sense and simplicity



AMSTERDAM  
SCIENTIFIC  
INSTRUMENTS

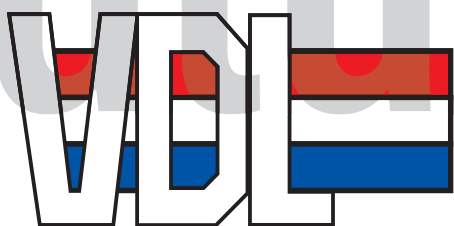

Figure 4.2.3. Some of Nikhef's knowledge transfer partners from the world of science and industry.

## 5 Finances 2011–2016 and beyond

## 5.1 Finances 2011–2016 and beyond



### Funding perspective – ‘secured’

The funding (Table 5.1.1) of Nikhef’s joint research programme originates from five distinct sources. The first source (I) is the ‘base’ funding for FOM-Nikhef; this base funding is the sum of the programme budgets and the mission budget. The second source (II) is the FOM programme funding for the three university groups (RU, UU, VU) that are part of Nikhef. For historical reasons the FOM funds for the fourth university group (UvA) are included in the institute’s budget. The third source (III) is project funding from either FOM or third parties (such as the EU, NWO or the Ministry of Economic Affairs, Agriculture and Innovation). The fourth source (IV) is the (net) income the institute generates from the lease of the former accelerator buildings and from housing a large part of the Amsterdam Internet Exchange (AMS-IX). The last source is the budget, mainly personnel and a modest material budget, provided by the four university partners. This source, amounting to about 3.3 M€, is not further discussed in this section and not included in the budget tables discussed below.

The top half of Table 5.1.1 shows the current perspective of the funding sources, that are ‘secured’. These figures are indexed regularly to account for inflation. As none of the source IV income is really guaranteed it does not appear in the upper half of the table. As can be concluded from this part of the table

Nikhef’s programme and mission funding (sources I and II) will drop from the current 16.1 M€ to 10.5 M€ in 2016. Nikhef’s mission budget has grown the past years due to the positive results of the last mission evaluation (2007) with a structural amount of about 0.5 M€ funded by FOM and a temporary increase during the years 2008–2010 of another 0.45 M€ per year from NWO. On top of this in 2009 another temporary increase was granted (called ‘Dynamisering instituten’), which led to an extra 3.4 M€, spread over the years 2009–2011. This explains the decrease of the mission budget per 2012. The biggest part of the decrease in ‘base’ funding however, is caused by the fact, that all current FOM-programmes (ATLAS, LHCb, ALICE, Cosmic Rays, Gravitational Waves and Theory) will have ended in 2016, so that the funding will drop to 10.5 M€ (mission budget only), if no new programme funding is acquired.

By definition the project funding (source III) is temporary and it is therefore evident that the presently secured budgets will decrease in the near future, from the current 2.7 M€ to 0 M€ in 2016.

### Funding perspective – ‘projected’

Without acquiring new programmes and projects Nikhef’s funding will drop dramatically, which will jeopardise essentially all temporary positions at Nikhef resulting in a sharp decline of the scientific output. Since this is clearly not acceptable, the bottom half of the table indicates the plans, expectations and ambitions of Nikhef regarding new funding, divided over the four funding sources.

### Programme funding (I and II)

#### Accelerator-based experiments

Programme funding for the three LHC experiments, both through the FOM institute (source I) and FOM support for the university groups (source II) is secured until 2013–2015. Ending these programme lines, when the LHC is successfully running would not only be a waste of the investments of the last 15 years, but also would deprive Nikhef from possible Nobel-prize winning discoveries (e.g. Higgs boson). Therefore –following the last evaluation (2007)– the Nikhef-directorate has put this issue to the attention of the Executive Board of FOM. As a result in the recent FOM-Strategic plan (2010–2015), the so-called ‘strategic component’ of the budget for FOM programmes will be increased in the next years to allow for a decision around 2013 on the continuation of the LHC-programmes. Nikhef will apply for a programme budget of 18 M€ early 2013. After evaluation and approval by the FOM board this new programme will give an excellent prospect on the LHC-physics continuation until 2020, with a budget that will be devoted to ATLAS, LHCb and ALICE in roughly the current ratio (3:2:1).

<b>Running Budgets</b>	2011	2012	2013	2014	2015	2016	2017	2018	2019	2020	2025
<b>I.a FOM-Nikhef – programs</b>	<b>2,767</b>	<b>2,497</b>	<b>2,554</b>	<b>2,071</b>	<b>1,305</b>						
ATLAS	1,020	1,021	1,023	1,022	1,022						
ALICE	168	169	169								
LHCb	716	716	717	716							
Cosmic rays (ANTARES/PAO)	456	311	214								
Gravitational waves	183	183	333	333	283						
Theoretical physics	224	97	98								
<b>I.b FOM-Nikhef – Mission budget</b>	<b>11,696</b>	<b>10,481</b>	<b>10,497</b>	<b>10,498</b>	<b>10,500</b>	<b>10,500</b>	<b>10,500</b>	<b>10,500</b>	<b>10,500</b>	<b>10,500</b>	<b>10,500</b>
<b>II. FOM-univ. groups – programs</b>	<b>1,673</b>	<b>1,505</b>	<b>1,335</b>	<b>773</b>	<b>363</b>						
ATLAS	361	362	362	364	363						
ALICE	474	477	477								
LHCb	409	408	409	409							
Cosmic rays (ANTARES/PAO)	168	115	70								
Theoretical physics	261	143	17								
<b>III. Acquired projects</b>	<b>2,683</b>	<b>1,941</b>	<b>675</b>	<b>438</b>	<b>231</b>						
FOM-Nikhef – projects	510	342	221	171	71						
FOM-univ. groups – projects	125	26									
NWO (VENI/VIDI/VICI-scheme)	814	581	152	185	160						
EU	354	386	302	82							
BiG Grid (running costs)	480	480									
Other projects	400	126									
<b>Nikhef - 'secured'</b>	<b>18,819</b>	<b>16,424</b>	<b>15,061</b>	<b>13,780</b>	<b>12,399</b>	<b>10,500</b>	<b>10,500</b>	<b>10,500</b>	<b>10,500</b>	<b>10,500</b>	<b>10,500</b>
<b>I.a+II. FOM: New programs</b>		<b>366</b>	<b>588</b>	<b>1,839</b>	<b>3,104</b>	<b>4,863</b>	<b>4,756</b>	<b>4,725</b>	<b>4,475</b>	<b>4,300</b>	<b>4,200</b>
LHC physics			100	550	1,500	3,100	3,200	3,200	3,200	3,200	1,600
Linear collider physics											1,500
Direct dark matter searches		166	288	439	354	288	81	PM	PM	PM	PM
Neutrino detection (KM3NeT)				400	450	500	500	500	500	500	500
Cosmic rays (PAO)					250	275	275	275	275	250	250
Gravitational waves (Virgo/LISA)						150	300	350	350	350	350
Theoretical physics				250	400	400	400	400	150	PM	PM
Industrial partnership program		200	200	200	150	150					
<b>I. FOM: Increase Mission budget</b>		<b>1,000</b>	<b>1,000</b>	<b>1,000</b>	<b>1,000</b>	<b>1,000</b>	<b>1,000</b>	<b>1,000</b>	<b>1,000</b>	<b>1,000</b>	<b>1,000</b>
<b>III. Projects to be acquired</b>		<b>100</b>	<b>1,350</b>	<b>1,500</b>	<b>1,700</b>	<b>2,000</b>	<b>2,000</b>	<b>2,000</b>	<b>2,000</b>	<b>2,000</b>	<b>2,000</b>
<b>IV. Housing &amp; lease (net income)</b>	<b>700</b>	<b>900</b>	<b>900</b>	<b>900</b>	<b>900</b>	<b>900</b>	<b>900</b>	<b>900</b>	<b>900</b>	<b>900</b>	<b>900</b>
<b>Nikhef - projected</b>	<b>19,519</b>	<b>18,790</b>	<b>18,899</b>	<b>19,019</b>	<b>19,103</b>	<b>19,263</b>	<b>19,156</b>	<b>19,125</b>	<b>18,875</b>	<b>18,700</b>	<b>18,600</b>

Table 5.1.1 Funding perspectives (k€). Mission budget depending on the outcome of the 2011 evaluation.

The prospects for a running new linear accelerator in the coming decade have diminished. Nikhef will however increase –from its mission budget– its involvement in the R&D for the next linear collider (ILC or CLIC). We judge this to be vital for Nikhef's long-term physics programme and for the prospects of Dutch industry, when the accelerator is built. At the end of the decennium it will have become clearer, whether joining a new ILC- or CLIC-based experiment is feasible.

#### **Astroparticle physics**

Nikhef is very grateful for the prospect provided by FOM for the continuation of the LHC physics programmes. For the future of the astroparticle physics programmes, which have been recently acquired and which will also end during 2013–2015, there will be no other way than proposing new programmes to be acquired in competition with other physics disciplines. The Nikhef ambition is to acquire an astroparticle physics programme of about 1 M€ per year for the years 2014–2020. We recently submitted a small FOM-programme on direct dark-matter searches (notably XENON).

#### **Enabling physics programmes**

A new Theory programme will be submitted to guarantee continuation of the present successful activities. Detector R&D activities, which have grown in recent years, will stabilise and evolve into more concrete LHC detector upgrade projects. We expect to maintain our grid/e-Science (manpower) efforts at the current level. In the near future these efforts will hopefully be partly funded from the national eScience Center programme budget (a joint NWO-SURF initiative) and from the continuation of BiG Grid (under a new SURF entity for computing and data facilities).

#### **Industrial partnerships**

Nikhef has many technical activities with heavy industrial involvement (in particular grid research and detector R&D), many of which are already funded from external sources. Nevertheless, Nikhef aims for a moderately sized FOM Industrial Partnership Programme (IPP) in the coming years, particularly around its pixel detector R&D involvement. Discussions are currently taking place with Shell and Philips.

#### **Project funding (III)**

In recent years the institute has been very successful in obtaining project funding (about 2.5 M€ annually), especially from NWO-*Vernieuwingsimpuls* (for the LHC activities) and EU funds (notably for theory, grid and detector R&D activities). In light of the less

favourable funding perspective for these budgets, we take into account a somewhat lower amount in our projection: 2.0 M€ of project funding per year, which is already 0.5 M€ higher than our ambitions in the last strategic plan (2007–2012).

#### **Net income from lease and housing activities (IV)**

The institute generates a considerable turnover with building lease activities and internet exchange (AMS-IX) housing activities (around 3 M€ in 2010). After deduction of costs (including depreciation on investments and upgrades) we expect –based on our experience in recent years– to be able to generate a net income of about 900 k€ yearly from these activities. These activities, however, are subject to market conditions, involving risks and can therefore not be taken for granted. Lease turnover depends on the continued activity of the tenants. One of the tenants has ceased renting as per March 2011, leading to a decrease of about 130 k€ in turnover (and about 50 k€ in net income). The other tenant has an option (and a wish) to continue the lease to at least 2020. The turnover from the data centre (internet exchange housing) activity has shown a steady growth, but although market perspectives for data centres are still quite favourable, also in this case there is no guarantee beyond a horizon of about five years, as the internet infrastructure world may undergo significant changes.

#### **Investments**

Table 5.1.2 shows our plans and ambitions with regard to investment budgets, which naturally follow the research ambitions described above. Nikhef typically should spend in this decade on average about 4 M€ per year on investments (with 1 M€ for computing infrastructure), including the compartment for medium scale investments, labelled FOM-Middelgroot (around 0.71 M€/year, that is now part of the mission budget). Around 0.39 M€ from this will be used for the technical infrastructure of the institute (local computing equipment and workshops) with an extra investment in 2011 in modern mechanical machinery. The other 0.32 M€ has been allotted to gravitational wave detection (Advanced Virgo, totalling 2.0 M€). From 2015 onwards this budget is available for other purposes. The investment for the neutrino observatory (KM3NeT, 8.8 M€) has been secured and will be spent in the coming years.

The table also shows the anticipated, virtually secured investments (and associated housing costs, totalling about 2.8 M€ for the years 2011–2013) at Nikhef, funded from BiG Grid and transitional financial support from SURF. These investments relate to the Dutch wLCG Tier–1 pledges.



<b>Investments</b>	2011	2012	2013	2014	2015	2016	2017	2018	2019	2020	2025
<b>Mission budget</b>	<b>1,000</b>	<b>389</b>	<b>389</b>	<b>389</b>	<b>389</b>	<b>389</b>	<b>389</b>	<b>389</b>	<b>389</b>	<b>389</b>	<b>389</b>
Technical infrastructure	200	389	389	389	389	389	389	389	389	389	389
Mechanical technology	800										
<b>FOM-M</b>	<b>444</b>	<b>444</b>	<b>444</b>	<b>319</b>	<b>319</b>	<b>319</b>	<b>319</b>	<b>319</b>	<b>319</b>	<b>319</b>	<b>319</b>
Advanced Virgo	444	125	125								
Detector R&D		319	319	319							
APP and LHC detector upgrades					319	319	319	319	319	319	319
<b>NWO</b>	<b>2,420</b>	<b>2,870</b>	<b>3,110</b>	<b>3,450</b>	<b>3,390</b>	<b>2,350</b>	<b>3,000</b>	<b>3,300</b>	<b>3,400</b>	<b>3,300</b>	<b>2,500</b>
NWO:KM3NeT	1,420	1,970	1,710	1,800	890						
NWO Groot: Advanced Virgo			500	750	750						
NWO Groot: PAO					750	750	500				
NWO BIG: LHC detector upgrade & Tier1@Nikhef				900	1,000	1,600	2,500	3,300	3,400	3,300	
NWO BIG: Linear Collider Tier-1@Nikhef	1,000	900	900								2,500
<b>Investments: projected</b>	<b>3,864</b>	<b>3,703</b>	<b>3,943</b>	<b>4,158</b>	<b>4,098</b>	<b>3,058</b>	<b>3,708</b>	<b>4,008</b>	<b>4,108</b>	<b>4,008</b>	<b>3,208</b>

Table 5.1.2 Investments (k€). The investment level on average is 4 M€ of which about 1 M€ is related to computing.

For large-scale investments we anticipate two major opportunities: the NWO-Groot-scheme (every two years, total budget about 18 M€) and NWO-BIG-scheme (large research infrastructures, every two or four years; total budget about 80 M€). For the first scheme we will propose in 2011 an investment related to Advanced Virgo. In 2013 we aim to (re)submit an investment proposal on the Pierre Auger Observatory (PAO). In conjunction with the LHC-physics programme to be acquired at FOM, Nikhef aims to direct a proposal to the largest of these funds (NWO-BIG) for the upgrades of the LHC detectors. We consider a proposal of about 16 M€, including a continuation of the Tier-1 computing infrastructure. Upgrade costs will be about 10 M€ (which is about half of the 18 M€ of original detector investments by Nikhef in the period 1996–2010), whilst in addition about a million euro annually is needed for the Tier-1 at Nikhef. It is yet unknown whether this NWO-BIG-scheme will have a 2 or 4 year period. The scheme starts in 2011, which is early for an LHC upgrade project; however, 2015 would certainly be quite late.

## 5.2 Mission budget increase

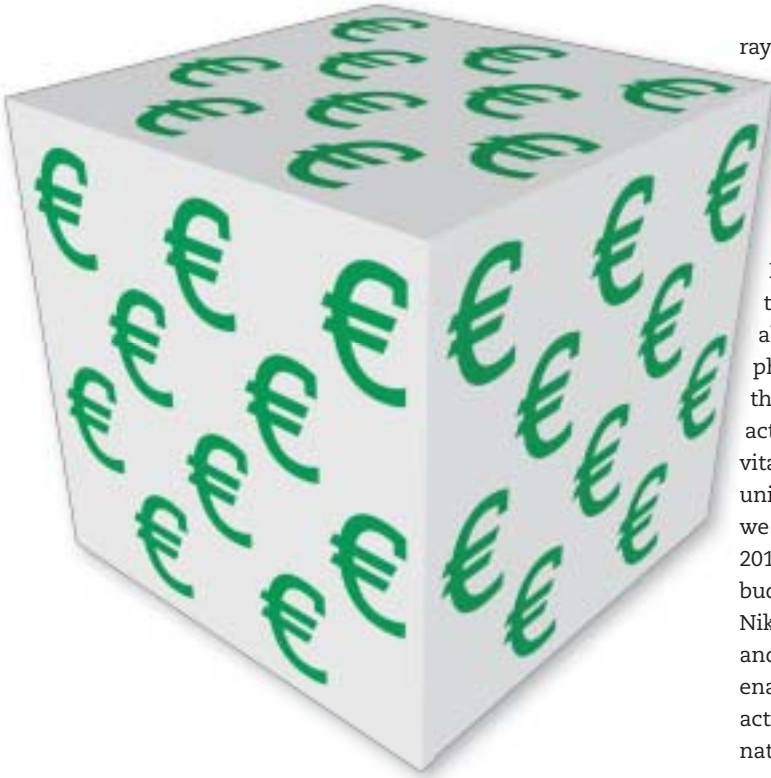

After the mission evaluation in 2007, Nikhef has expanded with great enthusiasm in the exciting new field of astroparticle physics. Now, in 2011 Nikhef has achieved prominent positions in the neutrino observatory world (ANTARES and KM3NeT), in cosmic

ray detection (Pierre Auger Observatory) and in gravitational wave detection (notably Virgo). The recent (2008–2011) increases in mission budget have enabled Nikhef to fully exploit this potential. Furthermore, Nikhef has thereby also been able to expand on its other activities, as shown by its increasing earning power (see Self Evaluation Report).

However, due to the temporary nature of most of the increase, the mission budget will drop from the current 11.7 to 10.5 M€ already in 2012. Obviously, the LHC-physics or astroparticle-physics part of the mission budget should not suffer, therefore the decrease will endanger first and foremost the enabling activities (theory, detector R&D and grid), which are nevertheless vital to the institute's ability to innovate. While it is very difficult to uniquely define the level of appropriate mission budget for Nikhef, we anticipate in Table 5.1.1 a mission budget increase of 1 M€ as of 2012, equivalent to maintaining the current (2011) level of mission budget of around 11.5 M€. Such a mission budget size would allow Nikhef to maintain its current strong position in accelerator based and astroparticle physics experiments, supported by well staffed enabling activities. It would allow Nikhef to keep a discrete Theory activity running, that would position Nikhef as host and coordinator for the national theoretical activities in phenomenology and cosmology. It would allow Nikhef to continue with its grid and detector R&D projects, which have shown to be excellent breeding ground for valorisation activities and to be successful in acquiring additional funding, thus contributing heavily to Nikhef's earning power.

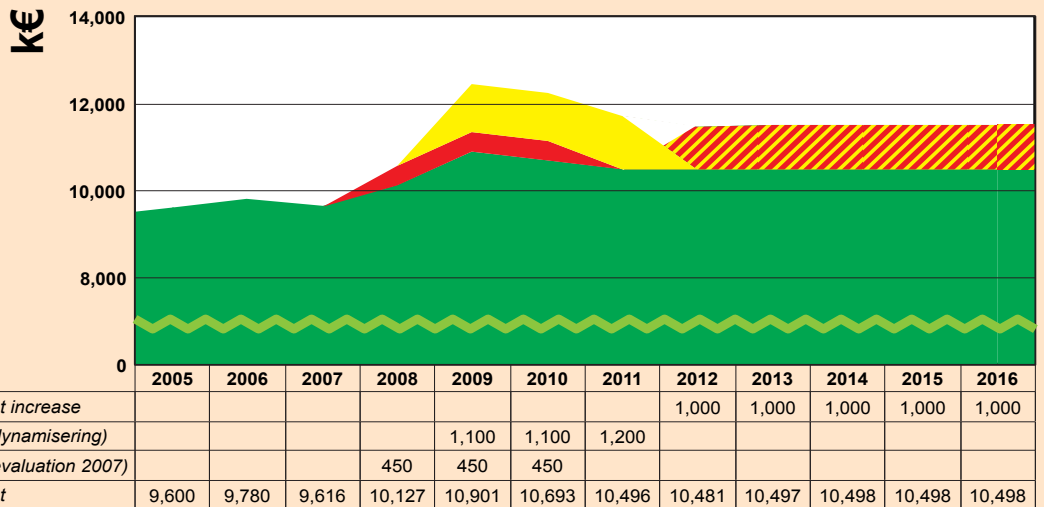

Figure 5.2.1: Projected mission budget; indicated in red and yellow is temporary NWO funding. The hatched area indicates the requested mission budget increase.

# Appendices

# A SWOT analysis

Based on discussions with the Nikhef scientific staff a self-analysis of Strengths, Weaknesses, Opportunities and Threats (SWOT) has been made. The main conclusions of this analysis are listed below.

## Strengths

- 1 Proven initiative and leadership in large and challenging international projects in a competitive and high-tech, internationally oriented, research arena.
- 2 Excellent scientific publication and citation records.
- 3 Highly motivated and experienced technical personnel, outstanding local technical infrastructure and R&D environment.
- 4 Collaborations with groups at renowned international accelerator centres (in particular CERN) and other physics laboratories.
- 5 The way Dutch activities are organised with the Nikhef laboratory as a focal-point, well connected to universities, and with a university faculty member often in a coordinating role.
- 6 Nikhef's strong position in the strategic scientific developments in the field, which makes Nikhef an attractive partner in new large-scale research initiatives.
- 7 Large interest of the general public, media and even artists (movie makers) in Nikhef's field of research.

## Weaknesses

- 1 The number of female staff scientists has grown but is still low (10%).  
*Nikhef benefits from various (FOM and 'Sector Plan Natuurkunde') subsidy programmes for women and Nikhef has as standard practice to also offer a female candidate who comes second to the top candidate (male or female) a staff position (at the expense of the next vacancy).*
- 2 The average PhD duration is longer than desirable.  
*Nikhef is under the scrutiny of FOM to shorten its PhD track. Strict performance and progress reviews are being implemented. An earlier installed award for PhD students graduating within 4.5 years will be re-evaluated.*
- 3 Nikhef lacks detailed knowledge of accelerator physics and technology.  
*Nikhef joined CERN's CLIC Test Facility 3 (CTF3) project to work on alignment and Nikhef established contacts with a very promising supplier (VDL, Eindhoven) of the CLIC RF-structures. Nikhef also introduced the KVI (Groningen) accelerator experts to the CLIC experts at CERN and as a result the baseline technology for KVI's compact soft X-ray Free Electron Laser (ZFEL) is now the CLIC technology.*

### Opportunities

- 1 LHC running is a treasure cove! Its huge discovery potential attracts scientists at all levels (master students, PhD students, postdocs and staff physicists alike). Moreover, the substantial media exposure of the LHC has brought our research field and Nikhef to the attention of a large fraction of the Dutch population in general and high-school physics teachers in particular.  
*See for actions Section 2.1 and Chapter 4.*
- 2 Nikhef's astroparticle physics experiments often require completely new and challenging technologies (deep-sea operation, vibration damping, material screening, very low-power electronics, etc.) and thereby offer Nikhef's technical departments exciting possibilities and contacts with entirely new research communities.  
*See for actions Section 2.2.*
- 3 The 'Sector Plan Natuurkunde', a 10 M€/year incentive from the Dutch Ministry to increase the number of physics students, allows most partner universities of Nikhef to hire extra staff physicists, thereby strengthening the Nikhef collaboration.
- 4 The BiG Grid –the Dutch e-science grid– project (largely housed at Nikhef and the national computing centre SARA) provides researchers at Nikhef with state-of-the-art computing services and an opportunity to establish contacts and/or collaborations with many other research disciplines.  
*See for actions Section 2.3.3.*

### Threats

- 1 Project delays due to lack of international funding for large projects (>100 M€ investment cost) such as e.g. the KM3NeT neutrino telescope detector and the  $e^+e^-$  linear collider.  
*Nikhef physicists are very active in the relevant KM3NeT committees that should mobilise KM3NeT-funding in the participating countries.*
- 2 Difficulties in securing multimillion Euro investment funds in the Netherlands for large projects like the important upgrades of the LHC detectors.  
*Nikhef has already brought the LHC upgrade plans to the attention of NWO and FOM.*
- 3 Funding cuts at universities and research in relation with budget policies of the Dutch government.  
*Nikhef is profiting on the University level from the budgets created by the Physics Sectorplan.*

To mitigate possible risks associated with the various weaknesses and threats several actions have been undertaken, that are briefly mentioned above and presented in more detail, where appropriate, in the corresponding sections of this document. Similarly, the strategic choices described in the various sections of this document are based on the strengths and opportunities listed here.

## B National & international context

FOM-Nikhef, located at Science Park Amsterdam, is the flagship of the Nikhef Collaboration, with as other members four universities: the Utrecht University (UU), the VU University Amsterdam (VU), the University of Amsterdam (UvA) and the Radboud University Nijmegen (RU). In addition Nikhef has informal contacts with all other Dutch universities with a physics department and several national science-oriented research institutes. Nikhef coordinates and supports the activities in experimental subatomic (particle and astroparticle) physics in the Netherlands. A detailed description of the organisational aspects of the Nikhef Collaboration is given in Section 1.6 of the “Self-evaluation Report 2005–2010” document (FOM-11.0936). FOM-Nikhef is an integral part of the FOM organisation, the Foundation for Fundamental Research on Matter. The Nikhef Collaboration agreement, i.e. a joint venture between a national funding agency and several universities, is often regarded as exemplary within as well as outside the Netherlands.

Particle- and astroparticle-physics projects fall in the realm of ‘big science’. As such they require long-term planning, international collaboration, and often significant investments. Nikhef scientists actively participate in the relevant (inter)national committees, contribute or lead (inter)national roadmap initiatives, and are well informed about (inter)national funding opportunities. Nikhef draws its funding from diverse sources. Structural funding is provided by FOM, the participating universities (UU, VU, UvA and RU), and lease activities (notably the Amsterdam internet exchange, AMS-IX). The Ministry of Education, Culture and Science (OCW) is responsible for the annual Dutch CERN contribution. Incidental (project) funding is acquired through (inter)national open competition calls: e.g. by FOM, the Netherlands Organisation for Scientific Research (NWO), the Ministry of Economic Affairs, Agriculture and Innovation (EL&I), and the European Union (EU). Below, the relation between Nikhef and the aforementioned bodies will be described with special attention, if applicable, to funding opportunities.

### FOM

FOM, Nikhef’s main funding agency, published its strategic plan aptly titled “*Topfysica midden in de wereld, Strategisch Plan FOM/N 2010-2015*” in 2010. FOM’s highest priority is to maintain the excellence of fundamental curiosity driven physics research in the Netherlands: ‘physics for science’ i.e. Nikhef’s core business! As a result, FOM e.g. sets aside funds to be able to decide on the continuation of Nikhef’s LHC programmes in 2013. Other FOM priorities are: ‘physics for society’ i.e. research addressing global challenges like climate change, healthcare, energy, security and durability as well as research in collaboration with industrial partners to eventually increase the economic activity in the Netherlands. Herein Nikhef plays a more modest role with well-established and

### Importance of the Nikhef collaboration

A quote from the letter of the Minister of OCW of 8 April 2011 to parliament concerning the NWO and Academy Strategic Agenda:

*“It is important to keep an eye on the special position of the institutes of NWO and the Academy. The long-term commitment of national research resources to research areas that are important for our country, implies a national function that is incompatible with an exclusive arrangement with just one university or university research group. The aim should be to cooperate at a national level. NIKHEF, in which the NWO-FOM foundation works together with four universities, could be a model to follow. The universities participate in funding and are represented in the NIKHEF-board. NIKHEF scientists do not only teach at the participating universities but at all nine universities with a physics department. The NIKHEF-model can be an example how universities, also financially, could take their responsibility in their cooperation with institutes of NWO and KNAW.”*

emerging activities in the fields of instrumentation (medical- and material diagnosis) and ICT (grid computing and large sensor networks). FOM strongly encourages the hiring of female staff, e.g. via the FOM/v subsidy-programme, to increase the fraction of female staff to the target of 20% by 2020. Finally, FOM supports outreach activities by subsidizing e.g. the HiSPARC project and internships for high-school teachers.

### NWO

NWO is the main funding agency of FOM and thereby indirectly of Nikhef. NWO summarised its strategy in 2010 in “*Groeien met kennis, strategienota NWO 2011-2014*”. NWO intends to continue funding for excellent individuals and curiosity-driven research at the present level and NWO plans to invest, together with other partners, in areas like sustainable energy, water & climate; and health which almost certainly will have a crucial impact on the quality of life of future generations of mankind. Furthermore NWO stimulates international collaboration; access to state-of-the-art research facilities; and NWO expects its institutes to coordinate the Dutch research in their domain of expertise. For Nikhef it is important that the ‘*Veni-Vidi-Vici programme*’ which funds excellent individual scientists (at present Nikhef has 1 Veni, 8 Vidi and 2 Vici recipients) will be continued. Another important NWO programme is the bi-annual call for ‘*NWO-Groot*’ grants, which typically provide 2-10 M€ of investment money. Recently, Nikhef (FOM) did submit a NWO-Groot proposal to partially fund the advanced Virgo upgrade project. In the coming years Nikhef

Figure B.1. The three other research institutes (apart from Nikhef) participating in CAN, the “Commissie voor de Astrodeeltjesfysica in Nederland”.



will seek investment funds for the upgrades of the three LHC detectors in which Nikhef participates.

Of special interest is ‘BiG Grid’ initiated by NWO in 2007 with a high-profile incidental 29 M€ grant to build the Dutch e-Science infrastructure for a variety of sciences, including a Tier-1 facility for the LHC experiments. The BiG Grid subsidy runs out in 2012. As a first step towards structural funding of the Dutch e-Science infrastructure NWO decided in 2010, together with other funding agencies, to set up a Dutch “eScience Center” (eSRC) at the Science Park Amsterdam, adjacent to the already existing headquarter of the “European Grid Initiative” (EGI). Nikhef plays and aspires to keep on playing a leading role in setting up, housing, and exploiting grid-compute facilities in the Netherlands.

#### OCW

The Dutch Ministry of Education, Culture and Science (OCW) finances the annual CERN contribution from the Netherlands. The Dutch delegates to CERN Council are appointed by OCW. This delegation interacts with the Dutch particle-physics community on a regular basis via the so-called ‘CERN Contact Committee’ (see section about CERN below) and on an ad-hoc basis, when required, with the Nikhef director. OCW also coordinates the Dutch input to ESFRI.

In 2010, OCW approved the “Actieplan Natuur- en Scheikunde” thereby granting a structural increase of physics funding of 10 M€ per annum as explained in more detail in the section about Dutch universities and research institutes below.

#### EL&I

The Ministry of Economic Affairs, Agriculture and Innovation (EL&I) stimulates joint ventures between knowledge institutes (such as Nikhef) and industrial parties with substantial subsidies, mainly originating from natural gas revenues. Nikhef collaborates with PANalytical and Philips-Healthcare on the development of X-ray instrumentation for analytical and medical instrumentation. PANalytical uses Nikhef infrastructure (cleanrooms, chip-handling and -testing equipment) and personnel to run a production line for Medipix chip-assemblies. VLSI-engineers from the Brucco chip-design house collaborated with Nikhef engineers on faster read-out electronics for these X-ray detectors.

#### Dutch universities and research institutes

Naturally, the four universities participating in Nikhef play an important role in the research activities. Each university partner focuses on one or two Nikhef programmes, and a university professor often leads such a programme. Almost all of the 80 PhD

students of the “Research School for Subatomic Physics” (coordinated by Nikhef) receive their PhD degree from one of the four partner universities. Via professors by special appointment and other affiliations, Nikhef scientists not only teach at the four partner universities, but also at most other Dutch universities with a physics department. These teaching activities provide a constant influx of master- and PhD students. Via Nikhef, most master students specialising in particle- or astroparticle physics get the opportunity to spend 1-2 months as a summer student at CERN.

Additional university funding (notably staff positions) became available in 2010 within the context of the so-called “Actieplan Natuur- en Scheikunde” aimed at a structural increase of the number of science students in the Netherlands and a boost for selected research areas, including Nikhef’s research activities. Within this scheme already one new professor in Nikhef’s field of research has been appointed and another 4-5 staff appointments are expected in the coming years. Preference is given to female physicists. Moreover, the UU, UvA and RU universities have chosen particle physics to be one of their priority items in their long-term strategy.

In addition the UvA selected astroparticle physics as a priority field of research, which will generate additional (structural) funding for the UvA group at Nikhef.

Already in 2004 Nikhef took the initiative to create a broad national network (universities and research institutes) coordinated by the “Commissie voor de Astrodeeltjesfysica in Nederland” (CAN) to promote astroparticle physics in the Netherlands by means of regular symposia and a roadmap. In this network, apart from Nikhef, three institutes KVI (Kernfysisch Versneller Instituut), ASTRON (Netherlands Foundation for Research in Astronomy), SRON (Netherlands Institute for Space Research) and six universities RU, RUG (Groningen), UL (Leiden), UU, UvA, and VU participate. Today, astroparticle physics is with four lines of research a thriving and recognised activity at Nikhef. As a CAN spin-off, the technical departments of the participating institutes started to collaborate more closely. These interinstitutionary contacts complement the already long-established technical contacts between Nikhef and the two other FOM institutes, AMOLF (FOM Institute for Atomic and Molecular Physics) and Rijnhuizen (FOM Institute for Plasma Physics Rijnhuizen).

## CERN

The Netherlands was a founding member of CERN and since the beginning Dutch physicists are very well connected to CERN. The Dutch input to the bi-annual CERN Council meetings with deciding power is prepared by the ‘CERN Contact Committee’ (CCC) of the Royal Netherlands Academy of Arts and Sciences. Dutch funding agencies (OCW, NWO and FOM), the Dutch CERN Council members, and two selected Dutch CERN staff physicists are represented in the CCC as well as the top echelon of Nikhef, i.e. the programme leaders of the CERN experiments, the leaders of the four university groups participating in Nikhef, and the Nikhef director. When required, a delegation of the CCC meets the research director of OCW for consultation.

Together with the directors of the main European particle physics research institutes, the Nikhef director prepares input to the European session of CERN Council to keep the “European Particle Physics Strategy” as formulated in 2006 on track.

In 2010 Nikhef joined CTF3 (‘CLIC Test Facility 3’, an accelerator R&D project aimed at the eventual construction of a multi-TeV linear  $e^+e^-$  collider) and took responsibility for various alignment challenges.

## ECFA & ApPEC

The ‘European Committee for Future Accelerators’ (ECFA) was set up in 1963 to deal with the long-range planning of the (high-energy) accelerator facilities in Europe. Another major (and rewarding) activity of ECFA is the regular (once every seven years) evaluation of particle physics in its member states. The ‘Astroparticle Physics European Coordination’ (ApPEC) was established in 2001 to promote astroparticle physics in Europe. FOM was one of the five founding members. ECFA and ApPEC organise workshops and publish roadmaps. With the gradually increasing importance of EU-funding programmes, both ECFA and ApPEC started to encourage and, where needed, prioritise these requests. Via ECFA (with four representatives from the Netherlands) and ApPEC (with two representatives from the Netherlands) Nikhef is well informed about emerging funding opportunities.

## EU

With many different programmes, the EU is an important source of Nikhef funding. Through its many contacts at CERN, ECFA, and ApPEC, Nikhef has become a regular partner in EU-funding proposals. As a result a substantial number of EU-funded projects (FP7) run already at Nikhef: KM3NeT/PP (2008-2011), ET/DS (2008-2011), MC-PAD (2008-2012), ASPERA-2 (2009-2012), IGE (2010-2012), EMI (2010-2013), EGI InSPIRE (2010-2014), AIDA (2011-

2015), LHCPhenoNet (2011-2015). One Nikhef staff physicist is the recipient of an ERC awarded Starting Independent Researchers Grant (SIRG). KM3NeT is one of the prestigious projects listed in the “European Roadmap for Research Infrastructures” updated by ESFRI (“European Strategy Forum on Research Infrastructures”) in 2008. In 2009 Amsterdam was selected as the location to host the ‘European Grid Initiative’ (EGI); the organisation that should pave the road towards a sustainable European grid infrastructure.

## Industry

Nikhef’s technical departments maintain networks with their suppliers and regularly organise informative meetings. ‘Dutch Scientific’, an association of manufacturers of scientific equipment in the Netherlands, occasionally visits Nikhef to brainstorm about future endeavours in the field of (astro)particle physics. In 2010 Nikhef organised, supported by the Ministry of Economic Affairs, Agriculture and Innovation, the ‘Holland@CERN’ event where 27 Dutch companies displayed their products and expertise at CERN. Nikhef and PANalytical have a long-standing collaboration within the context of CERN’s Medipix consortium. Nikhef’s grid computing activities have led to many contacts with industrial parties (computer hardware suppliers and grid compute service users). Nikhef has numerous commercial clients using its AMS-IX internet exchange housing facilities. Nikhef’s RASNIK alignment technology has finally found its first commercial application thanks to the efforts of the Sensiflex B.V. start-up company. In the area of (silicon) pixel detectors another start-up is emerging. Nikhef is looking into possibilities to market its in-house developed CO<sub>2</sub>-based refrigeration technology and Nikhef tries to identify industrial partners to set up together a FOM-supported “Industrial Partnership Program” (IPP). At this moment exploratory contacts with both Philips (medical instrumentation) and Shell (large sensor networks and/or massive data handling) have been established.



# C Organigram

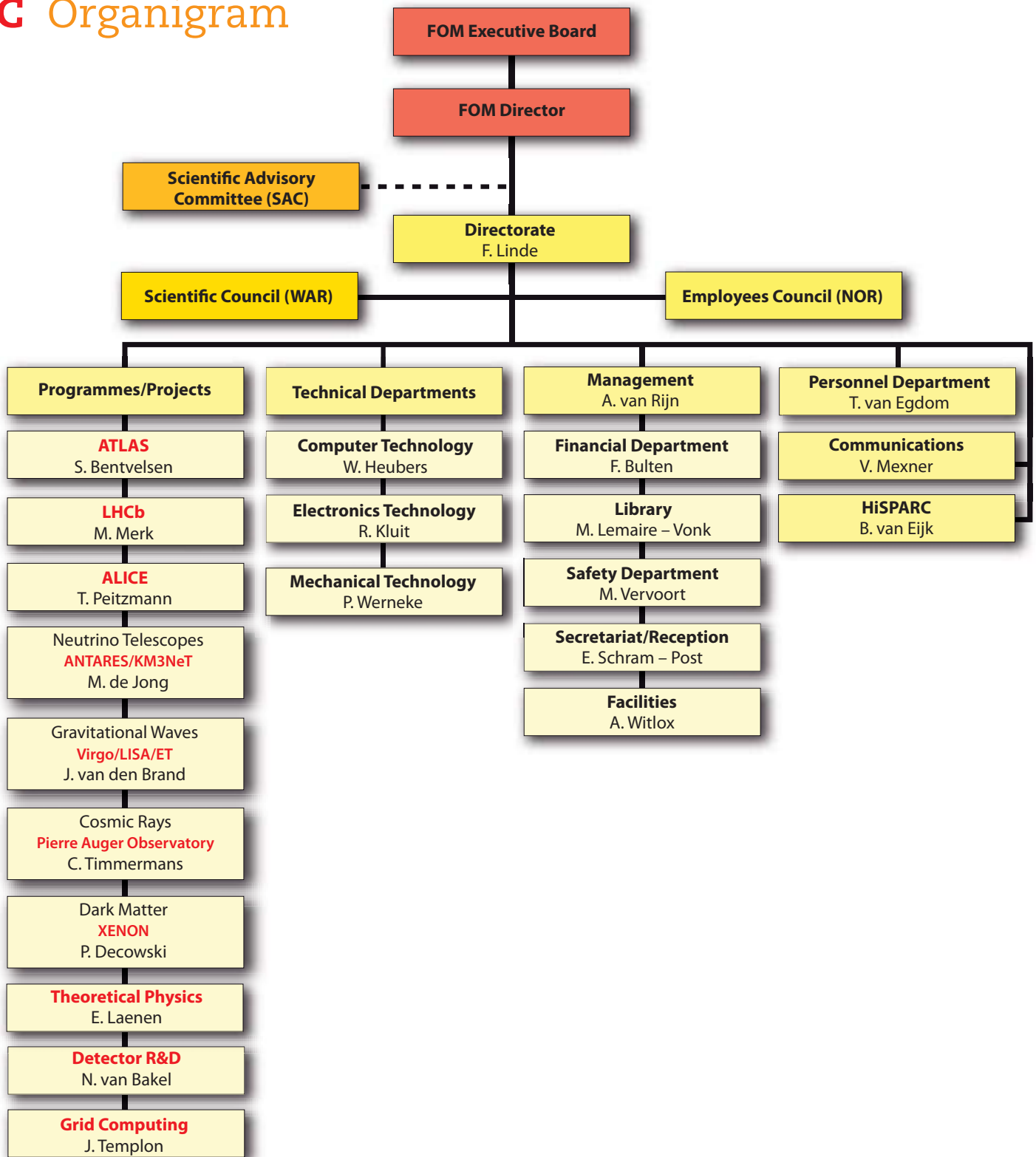

Fig. C.1. Organigram of FOM-Nikhef.

# D Glossary

## **Accelerator**

A machine in which beams of charged particles are accelerated to high energies. Electric fields are used to accelerate the particles whilst magnets steer and focus them. A collider is a special type of accelerator where counter-rotating beams are accelerated and interact at designated collision points. A synchrotron is an accelerator in which the magnetic field bending the orbits of the particles increases with the energy of the particles. This keeps the particles moving in a closed orbit.

## **ALICE (A Large Ion Collider Experiment)**

One of the four major experiments that uses the LHC.

## **AMS-IX (Amsterdam Internet Exchange)**

The main place in the Netherlands for Internet Service Providers to interconnect and exchange IP traffic with each other at a national or international level.

## **Annihilation**

A process in which a particle meets its corresponding antiparticle and both disappear. The resulting energy appears in some other form: as a different particle and its antiparticle (and their energy), as many mesons, or as a single neutral boson such as a Z boson. The produced particles may be any combination allowed by conservation of energy and momentum.

## **ANTARES (Astronomy with a Neutrino Telescope and Abyss Environmental Research)**

Large area water Cherenkov detector in the deep Mediterranean Sea near Toulon, optimised for the detection of muons resulting from interactions of high-energy cosmic neutrinos.

## **Antimatter**

Every kind of matter particle has a corresponding antiparticle. Charged antiparticles have the opposite electric charge as their matter counterparts. Although antiparticles are extremely rare in the Universe today, matter and antimatter are believed to have been created in equal amounts in the Big Bang.

## **Antiproton**

The antiparticle of the proton.

## **ASPERA**

Sixth Framework Programme for co-ordination across European funding agencies for financing astroparticle physics. The seventh Framework Programme started in 2009 and is called ASPERA-2.

## **ATLAS (A Toroidal LHC ApparatuS)**

One of the four major experiments that uses the LHC.

## **BaBar**

Detector at SLAC's B-Factory. Named for the elephant in Laurent DeBrunhoff's children's books.

## **Baryon**

See *Particles*.

## **Beam**

The particles in an accelerator are grouped together in a beam. Beams can contain billions of particles and are divided into discrete portions called bunches. Each bunch is typically several centimetres long and can be just a few  $\mu\text{m}$  in diameter.

## **Big Bang**

The name given to the explosive origin of the Universe.

## **BNL (Brookhaven National Laboratories)**

Laboratory at Long Island, New York, where the RHIC accelerator is located.

## **Boson**

The general name for any particle with a spin of an integer number (0, 1 or 2...) of quantum units of angular momentum (named for Indian physicist S.N. Bose). The carrier particles of all interactions are bosons. Mesons are also bosons.

## **Calorimeter**

An instrument for measuring the amount of energy carried by a particle.

## **Cherenkov radiation**

Light emitted by fast-moving charged particles traversing a medium faster than the speed of light in that medium.

## **CLIC (Compact Linear Collider)**

A feasibility study aiming at the development of a realistic technology at an affordable cost for an electron-positron linear collider for physics at multi-TeV energies.

## **Collider**

See *Accelerator*.

## **Colour glass condensate**

Representation of atomic nuclei travelling near the speed of light as Lorentz contracted spheres along the direction of motion

before collision, where 'colour' refers to the type of charge that quarks and gluons carry as a result of the strong nuclear force and 'glass' to the behaviour of this disordered state: a solid on short time scales but a liquid on longer time scales.

### **Cosmic ray**

A high-energy particle that strikes the Earth's atmosphere from space, producing many secondary particles, also called cosmic rays.

### **CP-violation**

A subtle effect observed in the decays of certain particles that betrays Nature's preference for matter over antimatter.

### **DØ (named for location on the Tevatron Ring)**

Collider detector, studies proton-antiproton collisions at Fermilab's Tevatron.

### **Dark matter**

Only 4% of the matter in the Universe is visible. The rest is known as dark matter and dark energy. See also WIMP.

### **Decay**

Any process in which a particle disappears and in its place two or more different particles appear.

### **Detector**

A device used to measure properties of particles. Some detectors measure the tracks left behind by particles, others measure energy. The term 'detector' is also used to describe the huge composite devices made up of many smaller detector elements. Examples are the ATLAS, the ALICE and the LHCb detectors.

### **Dipole**

A magnet with two poles, like the north and south poles of a horseshoe magnet. Dipoles are used in particle accelerators to keep the particles on a closed orbit.

### **EGEE (Enabling Grids for E-Science)**

An EU-funded project led by CERN, involving more than 90 institutions over 30 countries worldwide, to provide a grid infrastructure, available to scientists 24 hours a day. The programme ended on April 30 2010. Its tasks are taken over by the European Grid Infrastructure (EGI), located at Science Park Amsterdam.

### **Electron**

See *Particles*.

### **End cap**

Detector placed at each end of a barrel-shaped detector to provide the most complete coverage in detecting particles.

### **EGI**

A foundation to create and maintain a pan-European Grid Infrastructure (EGI) in collaboration with National Grid Initiatives (NGIs) and European International Research Organisations (EIROs), to guarantee the long-term availability of a generic e-infrastructure for all European research communities and their international collaborators. Its mission is to enable access to computing resources for European researchers from all fields of science, from high-energy physics to humanities.

### **EUDET (European Detector R&D towards the International Linear Collider)**

EU-funded R&D project for research on future ILC detectors, ending in 2011.

### **eV (Electronvolt)**

A unit of energy or mass used in particle physics. One eV is extremely small, and units of million electronvolts, MeV, thousand MeV = 1 GeV, or million MeV = 1 TeV, are more common in particle physics. The latest generation of particle accelerators reaches up to several TeV. One TeV is about the kinetic energy of a flying mosquito.

### **Fermion**

General name for a particle that is a matter constituent, characterised by spin in odd half integer quantum units (named for Italian physicist Enrico Fermi) Quarks, leptons and baryons are all fermions.

### **Forces**

There are four fundamental forces in Nature. Gravity is the most familiar to us, but it is the weakest. Electromagnetism is the force responsible for thunderstorms and carrying electricity into our homes. The two other forces, weak and strong, are connected to the atomic nucleus. The strong force binds the nucleus together, whereas the weak force causes some nuclei to break up. The weak force is important in the energy-generating processes of stars, including the Sun. Physicists would like to find a theory that can explain all these forces in one common framework. A big step forward was made in the late 1970s when the electroweak theory uniting the electromagnetic and weak forces was proposed. This was later confirmed in a Nobel prize-winning experiment at CERN.

**fte (Full Time Equivalent)**

Unit of manpower.

**Gluon**

See *Particles*.

**Gravitational wave**

The gravitational analog of an electromagnetic wave whereby gravitational radiation is emitted at the speed of light from any mass that undergoes rapid acceleration.

**Grid**

A service for sharing computer power and data storage capacity over the Internet.

**Hadron**

A subatomic particle that contains quarks, antiquarks, and gluons, and so experiences the strong force (see also *Particles*).

**High-Energy Physics**

A branch of science studying the interactions of fundamental particles; called 'high-energy' because very powerful accelerators produce very fast, energetic particles probing deeply into other particles.

**Higgs boson**

A particle predicted by theory, linked to the mechanism by which physicists think particles acquire mass.

**HiSPARC (High School Project on Astrophysics Research with Cosmics)**

Cosmic-ray experiment with schools in the Netherlands.

**ILC (International Linear Collider)**

A possible future electron-positron accelerator, proposed to be built as an international project.

**Jet**

The name physicists give to a cluster of particles emerging from a collision or decay event all traveling in roughly the same direction and carrying a significant fraction of the energy in the event.

**Kaon**

A meson containing a strange quark (or antiquark). Neutral kaons come in two kinds, long-lived and short-lived. The long-lived ones occasionally decay into two pions, a CP-violating process (see also *Particles*).

**KM3NeT (Cubic Kilometre Neutrino Telescope)**

Planned European deep-sea neutrino telescope with a volume of at least one cubic kilometre at the bottom of the Mediterranean Sea.

**LCG (LHC Computing Grid)**

The mission of the LCG is to build and maintain a data-storage and analysis infrastructure for the entire high-energy physics community that will use the LHC.

**LEP**

The Large Electron-Positron collider at CERN which ran until 2000. Its tunnel has been reused for the LHC.

**Lepton**

A class of elementary particles that includes the electron. Leptons are particles of matter that do not feel the strong force (see also *Particles*).

**LHC (Large Hadron Collider)**

CERN's accelerator that started in 2008.

**LHCb (Large Hadron Collider beauty)**

One of the four major experiments that uses the LHC.

**Linac**

An abbreviation for linear accelerator.

**LIGO (Laser Interferometer Gravitational-wave Observatory)**

A facility to detect astrophysical gravitational waves consisting of two widely separated installations in Hanford, Washington, and Livingston, Louisiana, operated in unison as a single observatory.

**LISA (Laser Interferometric Space Array)**

ESA/NASA mission, the first space-based gravitational wave observatory; three spacecraft, orbiting around the Sun as a giant equilateral triangle 5 million km on a side. The exploratory LISA Pathfinder is due to be launched in 2011.

**LOFAR (Low Frequency Array)**

First radio telescope of a new generation of astronomical facilities, mainly in the Netherlands. Started in 2010.

Figure D.1. The Standard Model particles (neutrino masses indicative only).

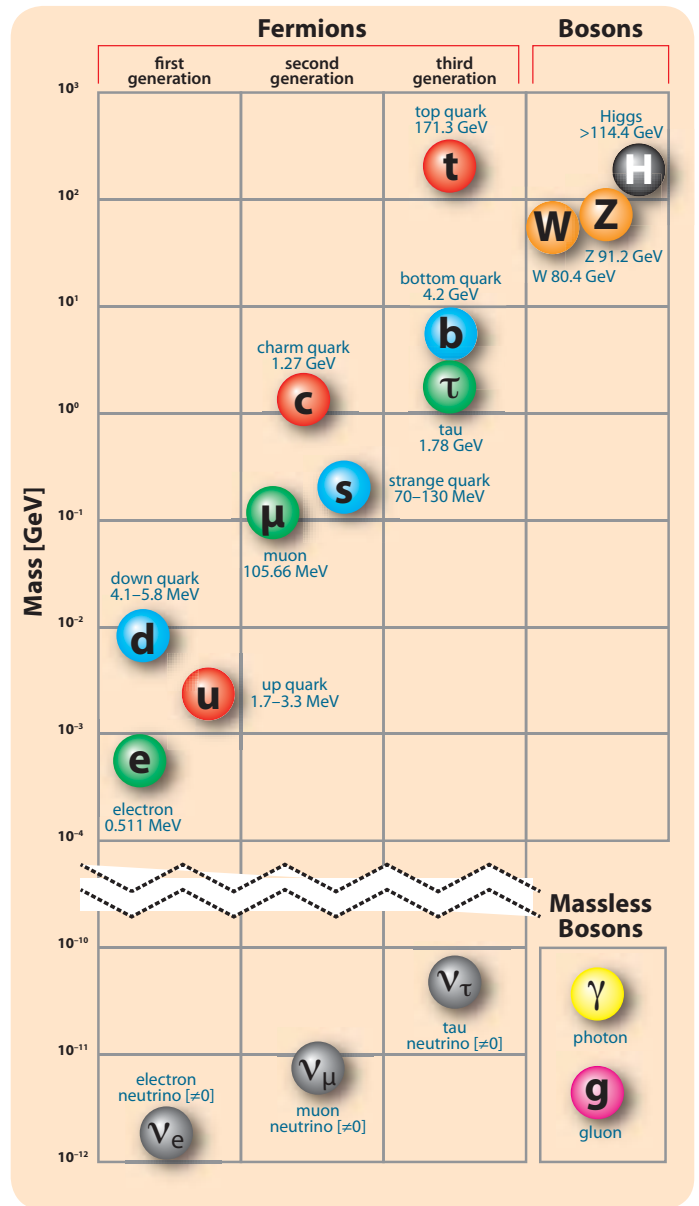

### Medipix

A family of photon counting pixel detectors based on the Medipix CMOS read-out chips that can be provided with a signal from either a semi-conductor sensor or ionisation products in a gas volume. The detectors are developed by an international collaboration (including Nikhef), hosted by CERN. Medipix3 is the prototype that is currently in the development phase.

### Meson

See Particles.

### Momentum

Momentum is a property of any moving object. For a slow moving object it is given by the mass times the velocity of the object. For an object moving at close to the speed of light this definition gets modified according to Relativity Theory. The total momentum is a conserved quantity in any process.

### Muon

A particle similar to the electron, but some 200 times more massive (see also Particles).

### Muon chamber

A device that identifies muons, and together with a magnetic system creates a muon spectrometer to measure momenta.

### Neutrino

Uncharged, weakly interacting lepton, most commonly produced in nuclear reactions such as those in the Sun. There are three known flavours of neutrino, corresponding to the three flavours of leptons. Recent experimental results indicate that all neutrinos have tiny masses (see also Particles).

### NLO (Next-to-Leading Order)

Second order calculations in perturbative QED and QCD.

### NWO

The Netherlands Organisation for Scientific Research is funding thousands of top researchers at universities and institutes and is steering Dutch science by means of subsidies and research programmes

### Nucleon

The collective name for protons and neutrons.

### Particles

There are two groups of elementary particles, quarks and leptons, with three families each. The quarks are named up and down, charm and strange, top and bottom (or beauty). The leptons are electron and electron neutrino, muon and muon neutrino, tau and tau-neutrino. There are four fundamental forces, or interactions, between particles, which are carried by special particles called bosons. Electromagnetism is carried by the photon, the weak force by the charged W and neutral Z bosons, the strong force by the gluons and gravity is probably carried by the graviton, which has not yet been discovered. Hadrons are particles that feel the strong force. They include mesons, which are composite particles made up of a quark-antiquark pair, and baryons, which are particles containing three quarks. Pions and kaons are types of meson. Neutrons and protons (the constituents of ordinary matter) are baryons; neutrons contain one up and two down quarks; protons two up and one down quark.

**Photon**

See *Particles*.

**Pierre Auger Observatory (PAO)**

International experiment in Argentina to track down the origin of ultra-high-energy cosmic rays.

**Pion**

See *Particles*.

**Positron**

The antiparticle of the electron.

**Quantum electrodynamics (QED)**

The theory of the electromagnetic interaction.

**Quantum chromodynamics (QCD)**

The theory for the strong interaction analogous to QED.

**Quark**

The basic building blocks of matter (see also *Particles*).

**Quark–gluon plasma (QGP)**

A new kind of plasma, in which protons and neutrons are believed to break up into their constituent parts. QGP is believed to have existed just after the Big Bang.

**RASNIK (Red Alignment System Nikhef)**

Optical alignment system where a pattern is projected by a lens on a CCD and deviations measured.

**RelaXd**

EU-funded development of the large area fast detector system using Medipix technology.

**RHIC**

Brookhaven's Relativistic Heavy Ion Collider; began operation in 2000. RHIC collides beams of gold ions to study what the Universe looked like in the first few moments after the Big Bang.

**Scintillation**

The flash of light emitted by an electron in an excited atom falling back to its ground state.

**Solenoid**

An electromagnet produced by current flowing through a single coil of wire. Many particle detectors are surrounded by a solenoidal magnet, since this produces a fairly uniform magnetic field within.

**Spectrometer**

In particle physics, a detector system containing a magnetic field to measure momenta of particles.

**Spin**

Intrinsic angular momentum of a particle.

**Standard Model**

A collection of theories that embodies all of our current understanding about the behaviour of fundamental particles.

**STAR**

Experiment at RHIC.

**String Theory**

A theory of elementary particles incorporating relativity and quantum mechanics in which the particles are viewed not as points but as extended objects. String theory is a possible framework for constructing unified theories that include both the microscopic forces and gravity (see also *Forces*).

**Superconductivity**

A property of some materials, usually at very low temperatures, that allows them to carry electricity without resistance. When starting a current flow in a superconductor, it will keep flowing for ever –as long as it is kept cold enough.

**Supersymmetry**

Supersymmetry (often abbreviated SUSY) is a theory that predicts the existence of heavy 'superpartners' to all known particles. It will be tested at the LHC.

**SURFnet**

Organisation providing the research network in the Netherlands.

**Tevatron**

Fermilab's 2-TeV proton–antiproton accelerator near Chicago.

**Tier-1**

First tier (category) in the LHC regional computing centres. Tier-0 is the facility at CERN collecting, reconstructing and storing the data.

**Trigger**

An electronic system for spotting potentially interesting collisions in a particle detector and triggering the detector's read-out system.

**Vertex detector**

A detector placed close to the collision point in a colliding beam experiment so that tracks coming from the decay of a short-lived particle produced in the collision can be accurately reconstructed and seen to emerge from a 'vertex' point that is different from the collision point.

**Virgo**

Detector near Pisa for gravitational waves: a Michelson laser interferometer made of two orthogonal arms, each 3 km long.

**W-boson**

A carrier particle of weak interactions; involved in all electric-charge-changing weak processes (see also *Particles*).

**WIMP (Weakly Interacting Massive Particle)**

A hypothetical particles that has a non-zero mass and only participates in weak nuclear interactions. Dark matter may be composed of WIMPs.

**XENON**

The XENON experiment searches for dark matter with liquid xenon as target material for finding WIMPs; is installed at the Gran Sasso underground laboratory in Italy.

**Z-boson**

A carrier particle of weak interactions; involved in all weak processes that do not change flavour and charge (see also *Particles*).







Bo  
s  
w  
k



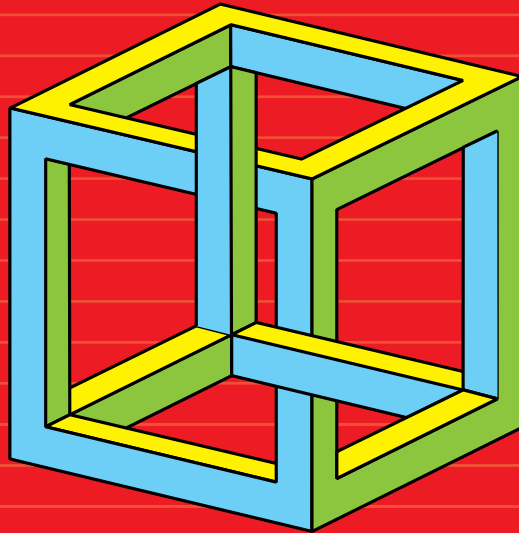

*Above all, it's creative thinking that lies at the basis of discoveries. You must dare to think differently, see things from different sides, in order to come across fortuitous new ideas frequently. You should develop even the most stupid ideas and when you do this systematically, there will always come something useful out of it.*

— Simon van der Meer (1925–2011)

**NIKHEF**

**FOM**

**NWO**