	GLOBAL STANDARD	Page 1 of 134
	Protection and control device for MV substation – RGDM control unit	GSTP011 Rev. 01 26/07/2019

Protection and control device for MV substation – RGDM control unit

This global standard defines the characteristics for the Protection and control devices for MV substation – RGDM control unit.

Countries' I&N	Elaborated by	Collaborations by	Verified by	Approved by
Argentina	Darío Burgo	Javier Bonaventura/Marcelo Clemente	Luis Laufer	Carlos Espinoza
Brazil	-	Hamilton Guilherme Bueno De Souza Kennedy Alves Martins Shiguelo Yonashiro Neto	Ricardo De Oliveira Brandao	Darcio De Souza Dias
Chile	-	-	-	Daniel Gonzalez
Colombia	-	-	-	Juan Gomez
Iberia	-	-	Carmen Ranea	Maria Avery
Italy	Luca Delli Carpini Pietro Paulon	-	Luca Delli Carpini	Gianluca Sapienza
Peru	-	-	-	Robert Sanchez
Romania	-	-	-	Vasilica Obrejan

	Elaborated by	Collaborations by	Verified by	Approved by
Global I&N – NTI	Giorgio Scrosati	Michele Negro	Giorgio Scrosati	Fabio Giammanco

This document is intellectual property of Enel Spa; reproduction or distribution of its contents in any way or by any means whatsoever is subject to the prior approval of the above mentioned company which will safeguard its rights under the civil and penal codes.

It is for internal Use. Each Country can provide a translation in local language but the official reference document is this GS English version.

Revision	Date	List of modifications
00	26.03.2019	First draft
01	26.07.2019	First Approved edition

	GLOBAL STANDARD	Page 2 of 134
	Protection and control device for MV substation – RGDM control unit	GSTP011 Rev. 01 26/07/2019

INDEX

1	ACRONYMS	10
2	LIST OF COMPONENTS, PRODUCT FAMILY OR SOLUTIONS TO WHICH THE GS APPLIES	12
3	NORMATIVE REFERENCES AND BIBLIOGRAPHY	13
3.1	For all countries	13
3.2	For EU countries	14
3.3	For Colombia	14
4	REPLACED STANDARDS	15
5	APPLICATION FIELDS	16
6	RGDM GENERAL REQUIREMENTS	17
6.1	Environmental requirements	17
6.1.1	Enclosure	17
6.1.2	EMC	18
6.1.3	Electrical safety	19
6.1.4	Climatic conditions	19
6.1.5	Network conditions	19
6.1.6	Installation conditions	19
6.2	Electrical, electronic and measurement characteristics	23
6.2.1	Power supply	24
6.2.2	CT/VT Sensors	24
6.2.3	Measurement Inputs	26
6.2.4	Physical and virtual inputs	34
6.2.5	Virtual outputs	35
6.2.6	Terminal boards	36
6.2.7	Connection to the RTU	42
6.2.8	Relay command contacts	44
6.2.9	Memory	44
6.3	Layout of the RGDM	46
6.4	Display	46
6.5	Reliability requirements	48
7	CONFIGURATION AND COMMUNICATION REQUIREMENTS	49
7.1	Device software	49
7.1.1	Configuration functionality	49
7.1.2	Monitoring and diagnostic functionality	51
7.1.3	Revision functionality	51
7.2	Communication Ports	51
7.2.1	Ethernet ports	51
7.2.2	Auxiliary communication ports	52
7.2.3	Synchronization and precision of times	52
8	SELF-DIAGNOSIS AND CONTROL LOGICS	54
9	FUNCTIONAL REQUIREMENTS	55
9.1	Definitions	56
9.2	Measurement and Monitoring Functions	56
9.2.1	Measuring methods	56
9.2.2	Measurement functions	59
9.2.3	Quality Monitoring Function	61
9.3	Electrical protection functions (FdP)	61
9.3.1	Logic structure for an FdP function	61

	GLOBAL STANDARD	Page 3 of 134
	Protection and control device for MV substation – RGDM control unit	GSTP011 Rev. 01 26/07/2019

9.3.2	Inverse time overcurrent protection function	62
9.3.3	Directional overcurrent protection function IEEE 67 and overcurrent protection function IEEE 51 64	
9.3.4	Residual overcurrent protection function IE 51N	65
9.3.5	Directional earth overcurrent protection function IEEE 67N	66
9.3.6	Directional intermittent arcs to earth detection	68
9.3.7	Directional Maximum Active Power	70
9.3.8	Discrimination of INRUSH currents	72
9.3.9	Voltage detection function	72
9.3.10	Protection blocking function	75
9.3.11	Cycle direction checking function	75
9.3.12	59N Function.....	75
9.3.13	59V2 Function.....	76
9.3.14	VSS (Voltage Sensor Supervision) function	76
9.3.15	Cold Load Pick Up	76
9.3.16	Skip Shot function	76
9.3.17	Second tripping time protection Function (or contract time).....	77
9.3.18	Protection Function of Broken Conductor I2/I1.....	77
9.3.19	Extension of protection function 46.....	77
9.3.20	Protection Function of Breaker Failure	78
9.3.21	Frequency protection function EAC	78
9.3.22	Management on single-phase and two-phase network	82
9.3.23	Overvoltage detection protection function (ES59B).....	83
9.3.24	Hot Line Tag function.....	83
9.4	Automation Functions	84
9.4.1	Functioning in basic configuration	85
9.4.2	Functioning in extended configuration	87
9.4.3	FSL automation.....	88
9.4.4	FRT Function	92
9.4.5	Automatic Re-Closing Function (ARF).....	92
9.4.6	Sectionalizer Automation Logic	96
9.4.7	ZSC – Zone Sequence Coordination.....	99
9.5	Automatic Parallel Function (Synchro-check IEEE 25).....	101
9.5.1	Checking of parallel conditions between synchronous networks (PS)	102
9.5.2	Checking of parallel conditions between asynchronous networks (PA)	103
9.6	Functions to command the OdM	103
9.7	Auxiliary Functions	104
9.7.1	PLC Function	104
9.7.2	Disturbance Recording (Oscilloperturbography)	105
10	RGDM ADVANCED REQUIREMENTS	107
10.1	DNP3 Communication protocol	107
10.2	DG Management Functions	109
10.3	UPG Function.....	109
11	TESTING AND CERTIFICATIONS	110
11.1	Overview Technical Conformity Assessment (TCA) Process	110
11.1.1	TCA documents	110
11.1.2	Quality	110
11.1.3	Safety warnings on Plate	110
11.1.4	Device tracking	110
11.1.5	Tests required to complete the TCA	110
11.1.6	Type Tests list.....	111
11.1.7	Acceptance Tests	111
11.1.8	Laying method of sensors with RGDM	111
11.1.9	Visual inspection	113

	GLOBAL STANDARD	Page 4 of 134
	Protection and control device for MV substation – RGDM control unit	GSTP011 Rev. 01 26/07/2019

11.1.10	Isolation and dielectric strength tests	114
N°	114
Description	114
Standard	114
Class	114
Level	114
11.1.11	Out-of-limit Power Supply Tests	115
11.1.12	Electromagnetic Compatibility Tests	115
11.1.13	Thermal behavior tests	115
11.1.14	Mechanical compatibility tests	116
11.1.15	Climate compatibility tests	116
11.2	Compatibility tests with CT-VT approved sensors	117
11.2.1	CT-VT Voltage sensor	118
11.2.2	Verification of the constancy of the module and of the phase as the frequency changes	118
11.3	Checking Of All the Functions	119
11.3.1	Testing detection of the presence / absence of voltage	119
11.3.2	Checking the function for detecting a single-phase fault to earth	119
11.3.3	Checking the maximum residual current function	122
11.3.4	Checking the maximum phase current function	123
11.3.5	Transient tests	123
11.3.6	Checking the measurement function	128
11.3.7	Checking continuous voltage compensation	129
11.3.8	Checking continuous current compensation	129
11.3.9	Checking the performance of the 61850 protocol	130
11.4	Pilot installation tests	130
11.5	Individual tests	130
11.6	Certifications and self-certifications	131
12	MISCELLANEOUS	132
12.1	Required documentation	132
12.2	Clarification during procurement process	132
12.3	Procurement management	132
12.4	Receipt of material	133
12.4.1	Reception tests	133
12.4.2	Warranty	133

FIGURES

Figure 1	– Drilling template and fixing diagram of the RGDM	17
Figure 2	– RGDM installed on output busbar	20
Figure 3	– RGDM installed on input busbar	20
Figure 4	– RGDM installed on shunt line	20
Figure 5	– Basic Configuration RGDM UP	22
Figure 6	– Connection Diagram of the RGDM	23
Figure 7	– Extended configuration	25
Figure 8	– Basic configuration	25
Figure 9	– Schematic principle for the instrumentation amplifier (IA)	27
Figure 10	– Schematic principle for the current input	28
Figure 11	– Schematic principle for the voltage input	28

	GLOBAL STANDARD	Page 5 of 134
	Protection and control device for MV substation – RGDM control unit	GSTP011 Rev. 01 26/07/2019

Figure 12 – Linear voltmetric inputs	31
Figure 13 – Main electrical Terminal boards of the RGDM	36
Figure 14 – Signals Output Terminal Board (MB)	37
Figure 15 – Diagram for inversion of direction command for detecting single-phase faults to earth	38
Figure 16 – OdM command output terminal board.....	39
Figure 17 – Fixed part installed on the MV RMU (according to GSCM004)	40
Figure 18 – Loose part installed on the cable	41
Figure 19 – Connection cable with the MV RMU (according to GSCM004) for OdM	41
Figure 20 – MU Terminal Board	42
Figure 21 – Connection cable for Indoor RGDM	42
Figure 22 – Connection cable for Outdoor RGDM	43
Figure 23 – Rectangular connector to the RTU.....	43
Figure 24 – External layout of the RGDM	46
Figure 25 – Phase Current	57
Figure 26 – Residual Current	57
Figure 27 – Phase Voltages	58
Figure 28 – Phase to Phase voltages	58
Figure 29 – Residual Voltage	59
Figure 30 – Correlation of phase and phase-to-phase voltages	60
Figure 31 – Logic Diagram for an FdP	62
Figure 32 – Example of user defined curve configuration interface	63
Figure 33 – Activation sectors for the directional fault to earth function	67
Figure 34 – Intermittent arc selection logic.....	68
Figure 35 – Start of the single-phase fault on NC (compensated neutral) network	69
Figure 36 – Real intermittent arc event (gap between arcs < T1).....	69
Figure 37 – Definition of power directions	71
Figure 38 – Power direction convention	71
Figure 39 – Voltage On/Off function automation	73
Figure 40 – Example of functioning of the Voltage On/Off logic	74
Figure 41 – Protection blocking function	75
Figure 42 – Logical scheme: 46	78
Figure 43 – EAC Logic	82
Figure 44 – Self producer cogeneration automatism	83
Figure 45 -Example of timers signaling.	87
Figure 46 - Behavior of the signaling.....	87
Figure 47 – FSL functioning logic.....	89
Figure 48– FSL functioning logic.....	89

	GLOBAL STANDARD	Page 6 of 134
	Protection and control device for MV substation – RGDM control unit	GSTP011 Rev. 01 26/07/2019

Figure 49– FSL functioning logic	90
Figure 50– FSL functioning logic	90
Figure 51 – RGDM Remote trip Logic	91
Figure 52 – RGDM Remote Close Logic	92
Figure 53 – Re-closing enabling logic	95
Figure 54 - Example of the operation of the Automated Switch as Sectionalizer with N=3	97
Figure 55 - Reset Counter	98
Figure 56 - Alarm Permanent Fault	99
Figure 57 – Diagram of protection devices in series along a distribution feeder	99
Figure 58 – Overcurrent protection coordination between RGDM1 and RGM2 of the case in question	100
Figure 59 – Operation of devices with the use of the ZSC function in RGDM1	101
Figure 60 – Wiring to the OdM	104
Figure 61 – Laying method of the conductors	112
Figure 62 - Example of test circuit for current channels (test box mode).....	112
Figure 63 – Example of test circuit for current channels (power transformer method)	113
Figure 64 – Test circuit to verify angle error voltmetric transducer	118
Figure 65 – Reference Network for TEST cases RGDM	126
Figure 66 – Cases for closing due to fault.....	127
Figure 67 – Impulse test, T = 1 ms.....	127
Figure 68 – Impulse test, T = 2 ms.....	128
Figure 69 – Impulse test, T = 4 ms.....	128
Figure 70 – Impulse test, T = 8 ms.....	128

TABLES

Table 1 – GSTP01X product family and description	12
Table 2 – Immunity tests.....	18
Table 3 – Standards for Electrical Safety.....	19
Table 4 – Climatic Conditions	19
Table 5 – Network Conditions	19
Table 6 – GSCT005 Sensor Pin Table.....	27
Table 7 – Smart Termination Derivative Sensor Pin Table.....	27
Table 8 – Pass-band (for all of the analog inputs) and anti-aliasing filter.....	29
Table 9 – Example of Current Signal Integration Filters (For Derivative Current Signal).....	30
Table 10 – RJ45 Characteristics of the voltmetric circuits	31
Table 11 – GSCT005 Voltmetric sensor electrical characteristics	31
Table 12 – Voltage Measurement Inputs	31

	GLOBAL STANDARD	Page 7 of 134
	Protection and control device for MV substation – RGDM control unit	GSTP011 Rev. 01 26/07/2019

Table 13 – Characteristics of the amperometric circuits	33
Table 14 – GSCT005 sensor electrical characteristics	33
Table 15 – Current Measurement Inputs	33
Table 16 – Calibration coefficients	33
Table 17 – Input Functions	34
Table 18 – Programming Input	35
Table 19 – Functions associated to Vout	35
Table 20 – MB terminal board	37
Table 21 – MI terminal board	39
Table 22 – Connector pinout for Odm	41
Table 23 – 9 pole Connector table	44
Table 24 – Code and event to save	45
Table 25 – Inverse time curve parameters	62
Table 26 – Inverse time settings	64
Table 27 – Angular sector settings	64
Table 28 – Base time	64
Table 29 – Independent time settings	64
Table 30 – Delay times settings	64
Table 31 – Error settings	64
Table 32 – Time errors	65
Table 33 – Inverse time settings	65
Table 34 – Base time	65
Table 35 – Independent time settings	65
Table 36 – Delay times settings	65
Table 37 – Error settings	65
Table 38 – Time errors	65
Table 39 – Inverse time parameters	66
Table 40 – Base times for independent time 67N	67
Table 41 – Independent time 67N activation levels setting	67
Table 42 – Threshold 67N delay times setting	68
Table 43 – Error settings	68
Table 44 – Time errors	68
Table 45 – Time errors	70
Table 46 – Base times	70
Table 47 – Activation level settings	70
Table 48 – Activation threshold settings	70
Table 49 – Delay times settings	70

	GLOBAL STANDARD	Page 8 of 134
	Protection and control device for MV substation – RGDM control unit	GSTP011 Rev. 01 26/07/2019

Table 50 – Error settings	71
Table 51 – Time errors	72
Table 52 – Activation threshold settings	72
Table 53 – Settings for blocking time T_ini_2ndH	72
Table 54 – Error settings	72
Table 55 – Time errors	72
Table 56 – Configuration parameters	73
Table 57 – Error settings	74
Table 58 – Time errors	74
Table 59 – Setting parameters	75
Table 60 – 59N setting parameters	75
Table 61 – 59Vi setting parameters	76
Table 62 – Setting parameters	77
Table 63 – “Under/overvoltage blocking stages” setting parameters ranges	79
Table 64 – Accuracy of the intervention times for the “Under/overvoltage blocking stages”	79
Table 65 – “β blocking stage” setting parameters ranges	79
Table 66 – Accuracy for the intervention times for the “β blocking stage”	79
Table 67 – “γ blocking stage” setting parameters ranges	80
Table 68 – Accuracy for the intervention times for the “γ blocking stage”	80
Table 69 – “Under/over frequency stages” setting parameters ranges	80
Table 70 – “Rate of change of frequency stages” setting parameters ranges	80
Table 71 – FdP ES59B behavior	83
Table 72 – Legends of commands and signals used by RGDM	85
Table 73 – Legends of Interface MI connector towards MV RMU	87
Table 74 – Legends of the timers used for the automatic re-closing function	93
Table 75 – Legends of the Configuration possibilities for RR + RL program re-closings	93
Table 76 – Configurable Parameters for the 79 Skip-Shot Autoreclose Blocking Function	96
Table 77 – Box test characteristics	113
Table 78 – Box test characteristics	113
Table 79 – Isolation and dielectric strength tests	114
Table 80 – List of tests to check the 67N.S1 directional earth function	120
Table 81 – List of tests to check the 67N.S1 directional earth function	120
Table 82 – List of tests to check the 67N.S1 directional earth function	120
Table 83 – List of tests to check the 67N.S2 directional earth function	121
Table 84 – List of tests to check the 67N.S2 directional earth function	121
Table 85 – List of tests to check the 67N.S2 directional earth function	121
Table 86 – Checking the measurement function	129



	GLOBAL STANDARD	Page 9 of 134
	Protection and control device for MV substation – RGDM control unit	GSTP011 Rev. 01 26/07/2019

Table 87 – Checking continuous voltage compensation129

Table 88 – Checking current compensation130

	GLOBAL STANDARD	Page 10 of 134
	Protection and control device for MV substation – RGDM control unit	GSTP011 Rev. 01 26/07/2019

1 ACRONYMS

- a. **ARF** Automatic reclosing function
- b. **CID** Configured IED Description
- c. **CT** Current Transformer
- d. **CT-VT** Current and Voltage Transformer
- e. **DER** Distributed Energy Resources
- f. **DG** Distributed Generation
- g. **DSU** Distribution Substation Unit
- h. **E_m** Rated Residual Voltage
- i. **FdP** Protection Function
- j. **FFT** Fast Fourier Transform
- k. **FRT** Timed Re-closing Function
- l. **FSL** Logic Selectivity Function
- m. **GOOSE** Generic Object Oriented Substation Events
- n. **GS** Enel Global Standard
- o. **ICD** IED Capability Description (XML file)
- p. **MV RMU** Enel Standardized Circuit Breaker for MV/LV substations
- a. **IDC** Interoperability Device with the Customer
- q. **IDC_DER** IDC (functions) related to the DER resources
- r. **IDC_PROT** IDC (functions) related to the DER plant Protections
- s. **IED** Intelligent Electronic Device
- t. **MMS** Manufacturing Message Specification
- u. **MV** Medium Voltage
- v. **OdM** Device for changing the electric connections (e.g. switch, breaker)
- w. **PG** General Protection
- x. **PI** Interface Protection
- y. **RGDAT** Enel Standardized Voltage Presence and fault detector for MV lines
- z. **RTDS** Real Time Digital Simulator

	GLOBAL STANDARD	Page 11 of 134
	Protection and control device for MV substation – RGDM control unit	GSTP011 Rev. 01 26/07/2019

- aa. RTU** Remote Terminal Unit
- bb. RVL** Line voltage detection
- cc. RVS** Busbar voltage detection
- dd. ATS** Automatic Test System
- ee. UP** RTU of a Secondary Substation
- ff. VCS** Central Voltage Regulating System
- gg. VT** Voltage Transformer

	GLOBAL STANDARD	Page 12 of 134
	Protection and control device for MV substation – RGDM control unit	GSTP011 Rev. 01 26/07/2019

2 LIST OF COMPONENTS, PRODUCT FAMILY OR SOLUTIONS TO WHICH THE GS APPLIES

The RGDM described in this GS can be classified in several products provided in Table 1.

Table 1 – GSTP01X product family and description		
GSTP01X type	Product family code	Description
GSTP011- RGDM	GSTP01X	Protection and control device for MV substation – RGDM control unit.
GSTP011- RGDM DNP3	GSTP01X	Protection and control device for MV substation – RGDM control unit – DNP3 enhancement
GSTP012- DG enhancement	GSTP01X	Protection and control device for MV substation – RGDM customer interoperability enhancement
GSTP013	GSTP01X	Protection and control device for MV substation – Communication profile according to the IEC 61850 for the RGDM control unit.

	GLOBAL STANDARD	Page 13 of 134
	Protection and control device for MV substation – RGDM control unit	GSTP011 Rev. 01 26/07/2019

3 NORMATIVE REFERENCES AND BIBLIOGRAPHY

All the references in this GS are intended in the last revision or amendment.

3.1 For all countries

IEC 61850	Communication protocols for IED at electrical substation
IEC 61000 series	Electromagnetic compatibility
IEC 60255 series	Measuring relays and protection equipment
IEC 61243-5	Live working - Voltage detectors – Part 5: Voltage detection systems (VDS)
IEC 60204-1	Safety of machinery – Electrical equipment of machines – Part 1: General requirements
IEC 60529	Classification of degrees of protection provided by enclosures for electrical equipment
IEC 60695-1-10	Fire hazard testing - Part 1-10: Guidance for assessing the fire hazard of electrotechnical products - General guidelines
IEC 60050-192	International electrotechnical vocabulary – Part 192: Dependability
IEC 60068 series	Environmental testing
IEC 61010-1	Safety requirements for electrical equipment for measurement, control and laboratory use – Part 1: General requirements
IEC 62689	Current and voltage sensors or detectors, to be used for fault passage indication purposes
IEC 61869-7	Additional Requirements for Electronic Voltage Transformers
IEC 61869-8	Additional Requirements for Electronic Current Transformers
IEC 61869-10	Additional Requirements for low-power passive current transformers
IEC61869-11	Additional Requirements for low-power passive voltage transformers
CISPR 32	Electromagnetic compatibility of multimedia equipment - Emission requirements
CISPR 11	Industrial, scientific, and medical (ISM) equipment - Radio frequency disturbance characteristics - Limits and methods of measurement
GSTP901	Cyber security requirements for protection and control devices
GSTR001	Remote Terminal Unit for secondary substations (UP)
GSTR002	Remote Terminal Unit for MV/LV substation – UP2020 Lite
GSTC005	Technical characteristics of Ipits for RGDM/RGDAT
GSCM004	MV RMU
Smart Termination	Smart Termination specification

	GLOBAL STANDARD	Page 14 of 134
	Protection and control device for MV substation – RGDM control unit	GSTP011 Rev. 01 26/07/2019

RFC3164	BSD syslog Protocol
RFC 3195	Reliable Delivery for syslog

3.2 For EU countries

CENELEC HD 186 S2	Marking by inscription for the identification of cores of electric cables having more than 5 cores
EN 50160	Voltage characteristics of electricity supplied by public distribution systems.
EN 14399	High Strength Structural Bolting assemblies for preloading.

3.3 For Colombia

NTC2050 + RETIE	Reglamento Técnico de Instalaciones Eléctricas – Colombiano.
-----------------	--

	GLOBAL STANDARD	Page 15 of 134
	Protection and control device for MV substation – RGDM control unit	GSTP011 Rev. 01 26/07/2019

4 REPLACED STANDARDS

Codification	Country	Title
DV7070	Italy	RGDM ST PRESCRIZIONI PER LA COSTRUZIONE E METODI DI PROVA
DV7070 RO	Romania	Detector de defect direcțional și de măsurare tip RGDM ST Prescripții pentru construcție și metode de încercare

	GLOBAL STANDARD	Page 16 of 134
	Protection and control device for MV substation – RGDM control unit	GSTP011 Rev. 01 26/07/2019

5 APPLICATION FIELDS

This document standardizes the functional, construction and testing requirements for the RGDM control unit used for protection and control in MV substation.

The RGDM is a device designed to be installed in the medium voltage compartment, with an SF₆ or air isolated switch, air isolated line and earth disconnecting switch, situated in remote controlled secondary substations, for protection, measurement, remote control and monitoring.

Particularly the RGDM purposes are:

- a. detecting any multi-phase and single-phase faults to earth, irrespective of how the MV neutral operates;
- b. voltage detection on the line;
- c. measuring the currents, voltages, active and reactive power on the MV line;
- d. dealing with faults when required, or using a remote control from UP, and opening and closing the MV RMU (according to GSCM004);
- e. interfacing with generators in the MV network, in order to coordinate voltage regulation along the line, and the remote disconnection signals (by according to GSTP012);

The device is connected to three integrated phase current/voltage sensors, CT-VT, from which the residual quantities V_0-I_0 , V_2-I_2 and V_1-I_1 can also be obtained.

In order to guarantee full compatibility with the RTU already in the secondary plants, the RGDM is always equipped with a double interface, able to dialogue with both the previous generation UPs and with future communications equipment.

The RGDM will be able to implement functionalities compliant to the requirements defined in IEC 62689; therefore, it is considered as a Distribution Substation Unit (DSU).

The device has an evolved Ethernet type communication interface, by means of which it is able to exchange information in accordance with the suite of protocols provided by the IEC 61850 standard. The communication profile is defined in GSTP013 and is compliant with IEC61850 1st Edition. The product is intended to migrate with easiness to IEC61850 2nd Edition when ENEL will decide for this migration to apply.

Security by design is mandatory for any devices developed to be installed in the ENEL premises. The requirements from GSTP901 must be adopted.

	GLOBAL STANDARD	Page 17 of 134
	Protection and control device for MV substation – RGDM control unit	GSTP011 Rev. 01 26/07/2019

6 RGDM GENERAL REQUIREMENTS

This chapter presents all the mandatory requirements for the RGDM hardware.

6.1 Environmental requirements

6.1.1 Enclosure

The container, which must have maximum dimensions of 300 x 200mm, must be made for surface mounting, to be fixed vertically using 4 x M5 screws, positioned as shown in the fixing template shown in Figure 1, and fitted with a cover that is easy to remove.

Fixing must be done with supports in PVC or some other material between the container and the compartment of the OdM, with characteristics that provide sufficient damping of the vibrations produced by the OdM, and adequate electrical isolation for the RGDM's electronics, from the rest of the compartment. The cover must also have an M8 or higher, by according to EN 14399, grounding bolt positioned on the right of the equipment at the bottom.

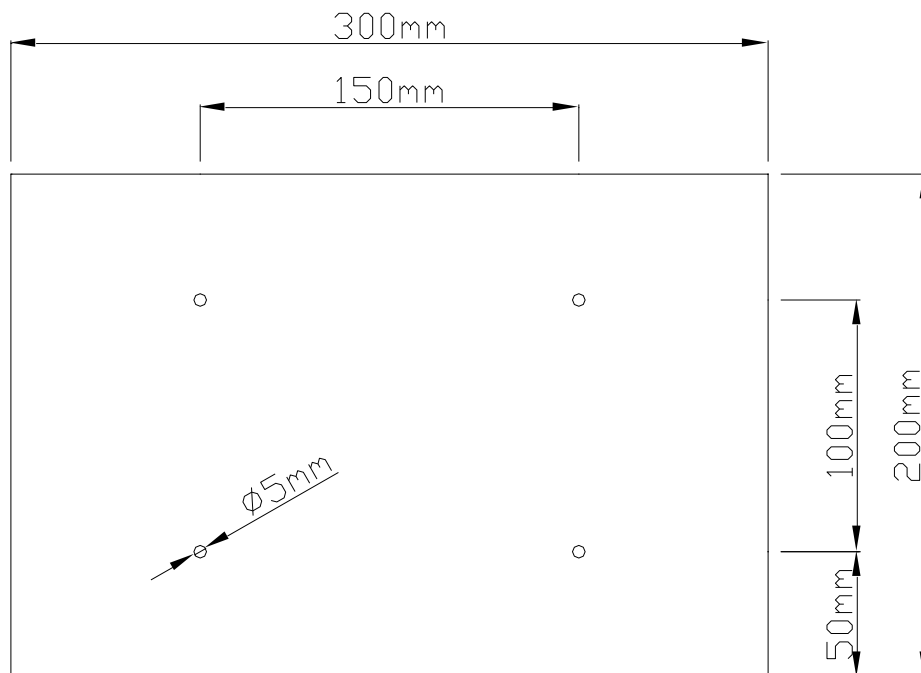

Figure 1 – Drilling template and fixing diagram of the RGDM

The entrance with a suitable cable gland for the connections to the CT-VT must be provided on the lower side of the RGDM.

The front door of the RGDM must have the following components installed on it:

- a. 2 buttons to open and close the OdM, with the following color coding:
 - Closing button: white pushbutton with “I” on it in black.
 - Opening button: black pushbutton with “O” on it in white.

Different color will be declared during the procurement process (par. 12.2).

Before sending the command to the OdM, it must requested a confirmation on the display by pushing the button.

	GLOBAL STANDARD	Page 18 of 134
	Protection and control device for MV substation – RGDM control unit	GSTP011 Rev. 01 26/07/2019

- b. N°1 rotating selector switch, with two positions, for activating / deactivating rapid re-closing of the switch.
 - c. N° 1 alphanumeric display, multi-line 20x4, with 4 touch buttons, for browsing the RGDM's menus.
- All the components must be connected to the RGDM's electronics board, by means of multiple connectors for a printed circuit.

6.1.2 EMC

The RGDM must comply with the EMC requirements defined in IEC 60255-26, with the following additions:

- a. Emission, CISPR32 must be adopted instead of CISPR22 cited in IEC 60255-26;
- b. Immunity, requirements by Table 2 must be adopted in addition to the one cited in IEC 60255-26.

Table 2 – Immunity tests									
N°	Description	Standard	Class	Level	Ports being tested				
					Casing	Vaux	Local	Range	Earth
1	Ring waves (100kHz)	IEC 61000-4-12	3	2kV CM (1)				X	
2	EM fields at radio frequency (80 - 3000MHz)	IEC 61000-4-3 IEC 61000-4-3/S1	3	10V/m (2)	X				
3	EM fields due to digital radio telephones (900 - 1890MHz)	IEC 61000-4-3 IEC 61000-4-3/S1	3	10V/m	X				
4	Interruptions and fluctuations in auxiliary power supply (3)	IEC 61000-4-29 IEC 61000-4-11		0% 50ms, 50% 100ms		X			
5	Magnetic fields from damped oscillators	IEC 61000-4-10	4	30A/m	X				
6	High energy surges 1.2/50us (SURGE)	IEC 61000-4-5 IEC 61000-4-5/A1	3	2kV phase-ground 1kV phase-phase		X (4)			
7	Conductor EM disturbance in common mode (15Hz -150kHz)	IEC 61000-4-16 IEC 61000-4-16/A1	3	10-1-1-10V 50Hz 100V (60s) 50Hz 300V (1s)		X	X	X	

(1): This test is only applicable in common mode towards PE.

(2): Since a return interval of 1 sec is set for the EUT measurements, the persistence of each RF disturbance step must be at least 2 sec. If, due to the stimulator's switching transistors, a phenomenon of transient turbulence occurs in the EUT measurements, identify the critical frequencies and apply them persistently, in order to check their effect.

(3): Besides the tests are required by the norm, check correct functioning by applying a power supply at the extremes of the operating range, that is: 15V DC for at least 15 minutes and 35V DC for at least 15 minutes.

(4): The test done is applied directly to the power supply terminals, with a maximum of 0.5 m of wiring from the EUT.

	GLOBAL STANDARD	Page 19 of 134
	Protection and control device for MV substation – RGDM control unit	GSTP011 Rev. 01 26/07/2019

6.1.3 Electrical safety

The insulation properties must be compliant with the standards on electrical safety referred in Table 3.

Table 3 – Standards for Electrical Safety	
IEC 60255-27	Measuring relays and protection equipment - Part 27: Product safety requirements
IEC 61243-5	Live working - Voltage detectors Part 5: Voltage detection systems (VDS)
IEC 60204-1	Safety of machinery - Electrical equipment of machines Part 1: General requirements
IEC 60529	Degrees of protection provided by enclosures (IP Code)

6.1.4 Climatic conditions

The Table 4 lists the environmental conditions the device specified in this document must comply to:

Table 4 – Climatic Conditions		
Description	Rated Values	Tolerance
Operating temperature	20°±3°C	from -25 to 85[°C]
Relative humidity		0% ÷ 95% RH, non condensing
Atmospheric pressure		860 ÷ 1060 [hPa]

6.1.5 Network conditions

The MV networks on which the RGDM units are installed, can be operated with an isolated neutral, a neutral connected to earth via an impedance (Petersen coil with additional resistance), with the neutral connected to earth via a resistance, with the neutral directly grounded or with the neutral connected by grounding transformer using or not a resistance

The network conditions for which it must be possible to use the RGDM device are specified in Table 5:

Table 5 – Network Conditions	
Operating voltage (primary concatenated values)	6 ÷ 36 kV ±10% (MV) 230 ÷ 400 V ±10% (LV)
Rated operating frequency:	50 ÷ 60 Hz ± 5%
Maximum three-phase short-circuit current	16 kA
Maximum single-phase fault to earth current (with isolated neutral)	500 A
Maximum peak value of the one-way current component, superimposed on the single-phase fault to earth current (with compensated neutral):	$\sqrt{2} \times 500 \text{ A}$
Maximum value of the decay time constant τ , for the one-way component:	150 msec
Residual voltage in the network in the absence of a fault	0 ÷ 10% Vn
Voltage harmonic content:	within the limits prescribed by EN 50160
Degree of dissymmetry of voltages	≤ 5%

6.1.6 Installation conditions

An example of the possible installation conditions for the RGDM device are illustrated in Figure 2, Figure 3 and Figure 4.

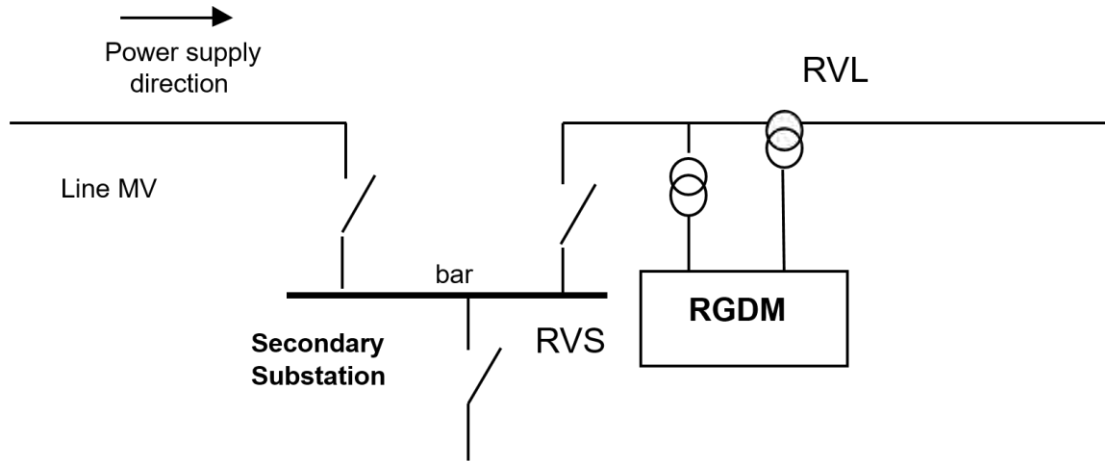

Figure 2 – RGDM installed on output busbar

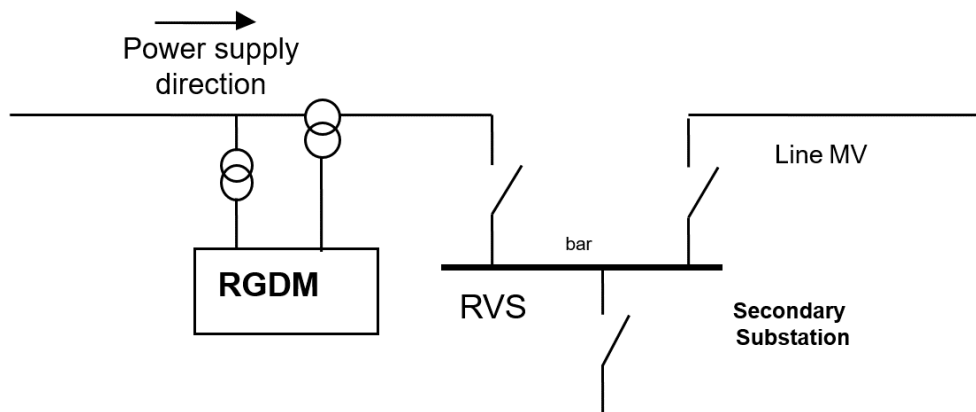

Figure 3 – RGDM installed on input busbar

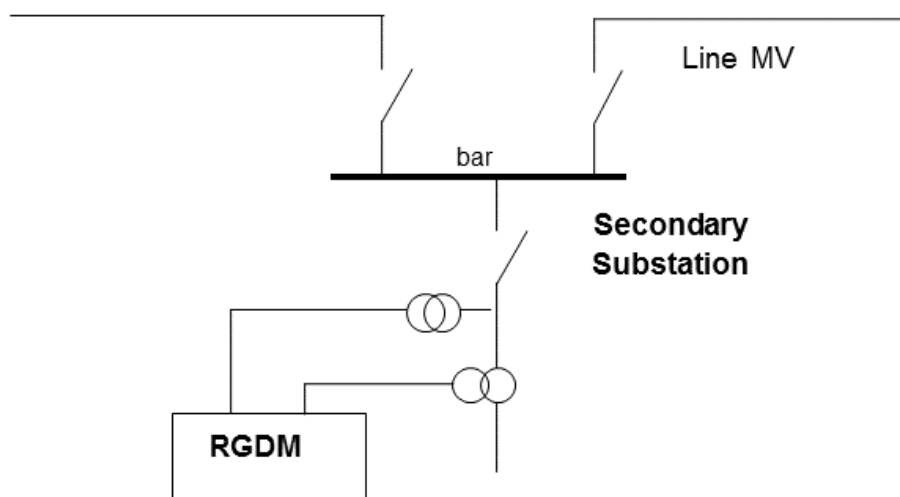



Figure 4 – RGDM installed on shunt line

	GLOBAL STANDARD	Page 21 of 134
	Protection and control device for MV substation – RGDM control unit	GSTP011 Rev. 01 26/07/2019

In the figures, the voltage:

- a. In the secondary sub-station is indicated by **RVS**.
- b. On the line on which the RGDM is installed, it is indicated as **RVL**.

The RGDM device has to detect fault conditions downstream of its installation point, in relation to the direction of the power supply in the line. In order to satisfy this requirement, in all the cases listed in the previous figures, and for all power supply conditions for the MV line, a specific function is required, hereinafter referred to as inversion. An inversion of direction is controlled remotely, using a UP remote control peripheral unit, or by means of the IEC 61850 protocol.

An inversion of direction is received by the RGDM and results in:

- c. A change in the angular sector of the 67N.S1, 67N.S2 and 67N.S3 thresholds.
- d. A change in the angular sector of the 67.S1, 67.S2, 67.S3, and 67.S4 thresholds.
- e. Use of the RVS or RVL signal, as a signal on which automatic selection of the faulty section is based.

Under no circumstances, the direction of measurement must be changed.

The inversion command can be received, either by means of the IEC 61850 protocol, or via digital input, as described in Figure 15.

6.1.6.1 Particular installation

The RGDM is also used in the MV ring networks, and in the EasySat Satellite Centers. The installation, configuration or communication modes must not change for these.

6.1.6.2 Condition for Interfacing with the RTU

The RGDM is an evolution of the RGDAT, and has inherited some of its operating logics from it. Evolved functions have been added, made necessary by the increasing need for automation and logical selection of the fault section, the need to know the values for power passing through the network, and for managing distributed generation.

The RGDM provides the possibility of functioning in IP type communication networks by according to the IEC 61850 standard.

In order to allow the component to also be installed in secondary sub-stations not equipped with or not reached by an IP communication network, the possibility of interfacing with the equipment already in the field has been provided. There are therefore two possible configurations, known as “**basic**” and “**extended**”.

These two configurations are defined below:

a. Extended configuration:

In an extended configuration the RGDM dialogues with the UP/Primary RTU using an Ethernet cable with an LC connector (multimode fiber optic).

Via the RTU, the RGDM:

- a.1 Sends signals and measurements.
- a.2 Receives remote control signals from the remote control system.
- a.3 Is able to activate the selectivity logic for the faulty section, for 67, 67N, 51 and 51N protections.

In this configuration, the RGDM is fitted inside the switch housing and manages the open and close commands autonomously, as it is connected to the connector available, via a cable attached to the terminal board for the commands to the OdM (Par.6.2.6).

The power source in the UP/Primary RTU provides power to both the RGDM and from it to the OdM (GSCM004).

b. Basic configuration:

The RGDM is interfaced with the current UP (most common scenario). In this case the hw interface must also be guaranteed towards this (UP) and to the switch, so that, even in plants in which the extensive management of the RGDM is not possible, it can dialogue with the UP in any case, and coexist with it. In this case, the RGDM communicates with the UP via a wired connection, and the UP implements the commands on the MV RMU (according to GSCM004).

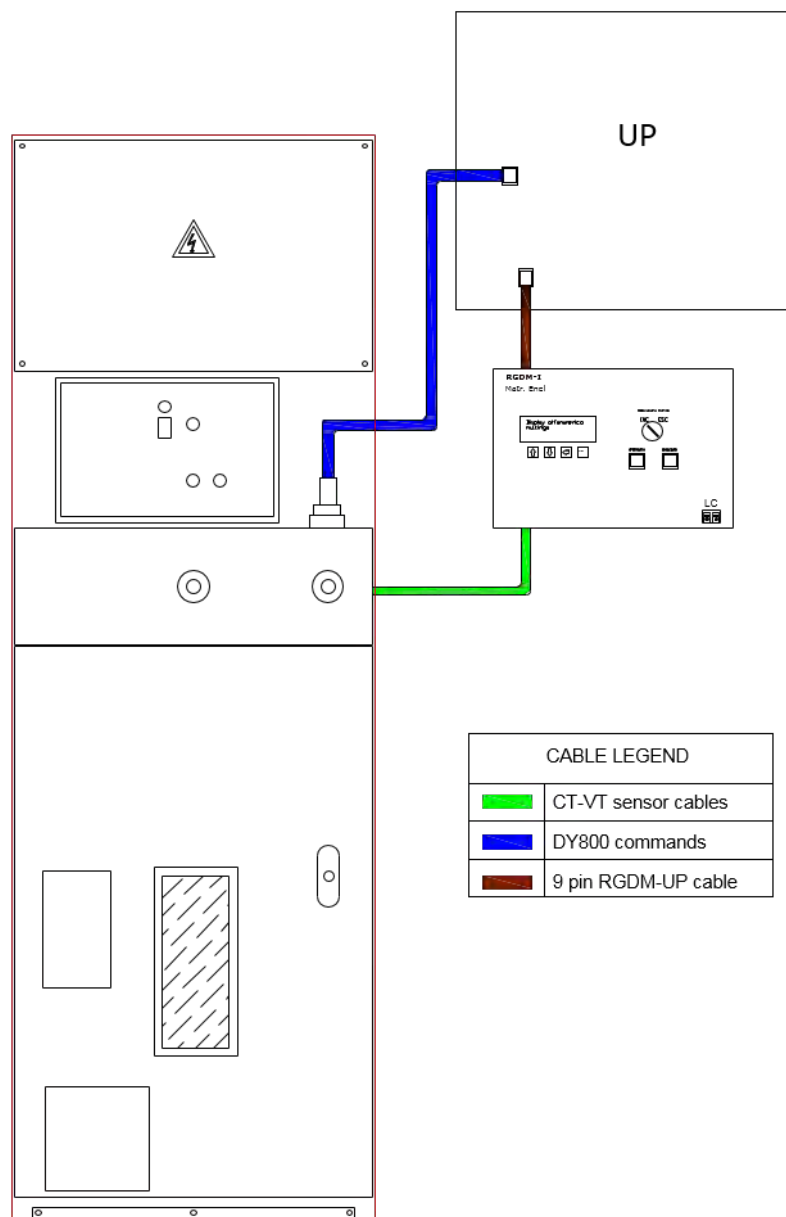

Figure 5 – Basic Configuration RGDM UP

6.2 Electrical, electronic and measurement characteristics

The RGDM is the electronic processing unit for current and voltage signals coming from three Smart Termination sensors or equivalent, known as CT-VT which are not part of the supply. These sensors are connected to the RGDM by means of three suitable screened cables, with RJ45 terminations (CAT6 industrial).

The terminals on the RGDM must be positioned low down, screened, related to earth, and positioned on the device so that the release tab is facing frontwards. In addition to the terminal board for the sensor cables, the RGDM also has a series of inputs and outputs, so that the unit can be made compatible with both the current UP and the future UP.

In addition, the RGDM has a terminal board for direct interfacing with the OdM. Access to these terminal boards must be from the right hand side, not reachable with a closed casing. The terminal boards in question, called MU, MI, MB, must be of a screw-fixed extractable type, with a 5.08mm pitch. A code must be indicated clearly next to these terminal boards, that identifies each input.

The RGDM's mother board houses the CPU, and the RAM and ROM memories. It also houses all the active and passive electronic components that the equipment requires to function. The Ethernet communication connector, the events display, and a series of buttons for browsing the equipment's menus.

In Figure 6 is shown a connection diagram of the RGDM.

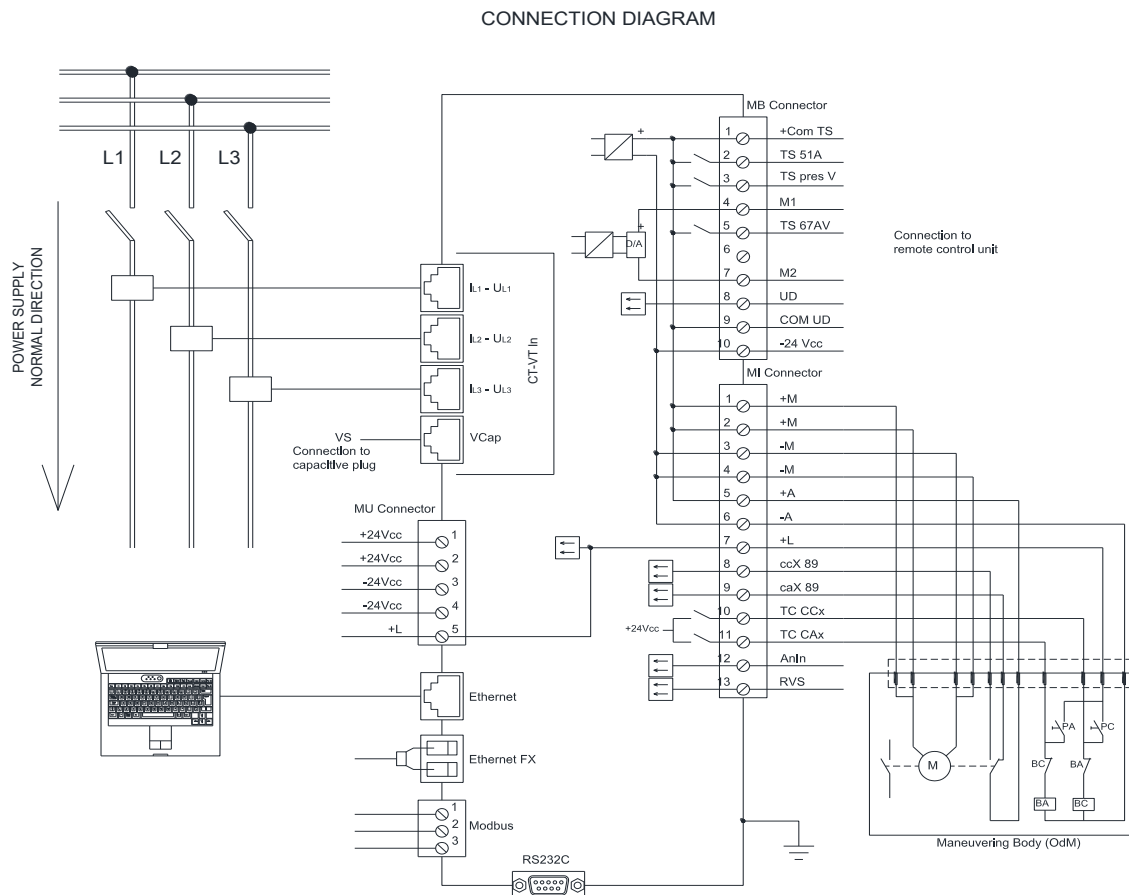



Figure 6 – Connection Diagram of the RGDM

For the configuration of the voltmetric measuring channels with capacitive partition, it is necessary to make accessible suitable bistable switches on the circuit, clearly indicated on the device. The graphic indications inside the metalwork casing, must include “R” for resistance, and “C” for capacitive provisions.

	GLOBAL STANDARD	Page 24 of 134
	Protection and control device for MV substation – RGDM control unit	GSTP011 Rev. 01 26/07/2019

The device's casing must be in steel or aluminum (the plate must be at least 1mm thick), in terms of electromagnetic compatibility and rigidity of the structure, and must have a hinged front panel that does not require the use of screws to secure it. At any points at which outside wiring is in contact with the casing, they must be protected by suitable cable glands or some similar solution to avoid friction.

With the exception of the side affected by the MU, MI and MB the entire casing must ensure a protective level of IP30, Any ventilation holes are to conform to the protection level required, and such that they prevent penetration of dripping water.

Suitable solutions must be adopted on the back of the casing to reduce the mechanical vibrations transmitted by the frame on which the RGDM is to be mounted. These solutions must be assessed and approved by Enel.

6.2.1 Power supply

The nominal power supply voltage is 24 Vcc, and the power supply circuit must be isolated from the earth. Correct functioning must be guaranteed within a minimum range of 15 V ÷ 35 V, with nominal temperatures and also in presence of alternating voltage component $\leq 10\%$.

The power supply circuit must be protected against inversion of polarity.

When there are no faults (to earth or for short circuits) and in the presence or absence of voltage, the RGDM, including the CT-VT, must have a consumption ≤ 15 W.

For power supply voltage values lower than the minimum operating range, the RGDM device must not emit any local or remote signal.

The 24 Vcc power supply circuits on PCB must ensure that the RGDM is used both in the basic configuration and in the extended configuration, continuing to feed the OdM until a continue current of at least 8 A.

6.2.2 CT/VT Sensors

The RGDM elaborate signals received by CT and VT transducers. These sensors can be assembled both in one component for each phase or in two component for each phase.

6.2.2.1 Combinations between electronics and sensors

The RGDM can interface integrated CT-VTs, or Rogowski coils and capacitive plugs compliant with the RGDAT. The transition from one configuration to the other must be done through software/ hardware setup, and after setting the capacitive partition selectors on the electronics.

In the **extended configuration**, the device combines with three CT-VTs and a synchronous voltage transducer (VS), as described in Figure 7.

EXTENDED CONFIGURATION

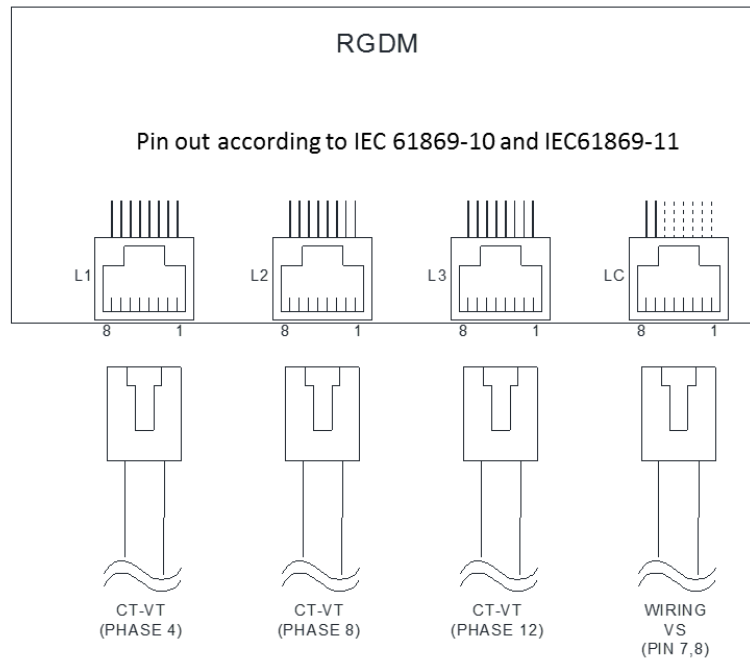

Figure 7 – Extended configuration

In the **basic configuration**, the device combines with three Rogowski coils and a capacitive plug, as described in Figure 8.

BASIC CONFIGURATION

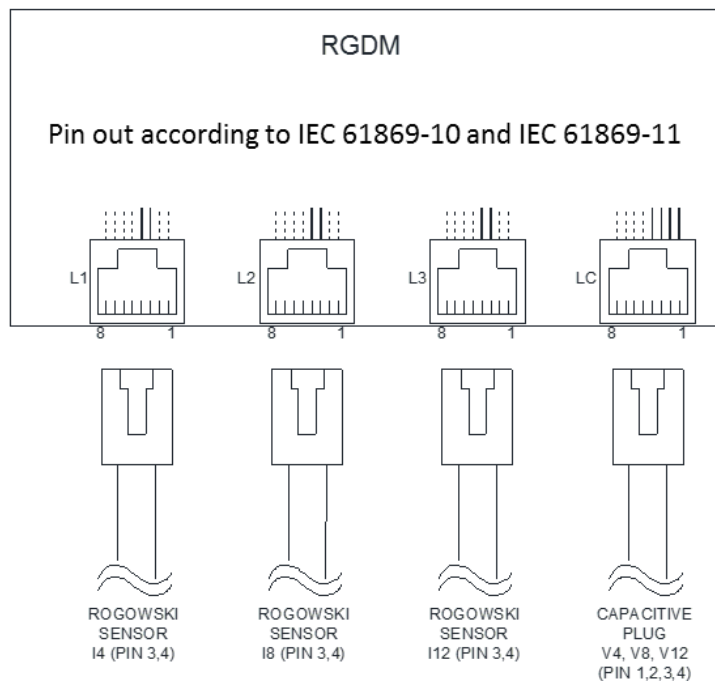



Figure 8 – Basic configuration

	GLOBAL STANDARD	Page 26 of 134
	Protection and control device for MV substation – RGDM control unit	GSTP011 Rev. 01 26/07/2019

Both for the extended configuration and for the basic configuration, it will be possible to set, by software, the operation of the RGDM also for single-phase and two-phase networks.

Moreover, for the three-phase operating mode, it will be possible to combine two line CT-VT sensors with a homopolar CT-VT sensor, with the same transformation ratio between primary and secondary.

6.2.2.2 Sensor polarity

The device software must provide the possibility of configuring the polarity of both current and voltage sensors.

6.2.3 Measurement Inputs

The analog inputs are connected by specific conductors to the CT-VT sensors and then to the ground collector of the distributed system. Therefore, they must be protected from transient overvoltage during the fault.

Overvoltage protection shall comply to the following requirements:

- The analog inputs shall withstand overvoltages caused by network transients
- The suppressors shall have voltage characteristics such as to protect the analogue inputs
- Peak current shall be 34 A with a pulse width of 8 μ s on the rising edge and 20 μ s on the falling edge.
- In general, the suppressors shall match with the impedances cited in GSCT005.

Connection of measure sensors to the RGDM must be in the form of 3 female RJ45 connectors, which will be used to send the CT-VT signals and the direct current auxiliary power supply for the active sensors.

The auxiliary power supplies of the active sensors must be isolated from primary power supply, from electrical ground and ground (ref to IEC 61869-7 and IEC 61869-8).

On the internal board of the RGDM the measurement points must be accessible, to make any measurements. The measurement inputs must be connected to differential instrumentation amplifiers (IA). The schematic principle is described in Figure 9; it is detached from the ADC power supply ground and from the ground. The ADC resolution must be at least 16 bit. Furthermore, the common mode rejection (CMR) of the differential instrumentation amplifier must be at least 100 dB.

For current input, the schematic principle is reported in Figure 10 (it is important to note that the figure represents a schematic principle: the manufacturer can modify it and discuss the architecture with Enel, that must approve it in any case. Moreover the schematic doesn't contain several components, like overvoltage suppressors or any other necessary component). Resistor R1 has double effect: 1) loading common-mode signals, trying to attenuate them, and 2) create a stable input impedance. The dip switch DS1 is normally open and it can be used to connect the input electronic ground to the earth (normally the electronic ground must be insulated from the ground).

For voltage input, the schematic principle is reported in Figure 11 (it is important to note that the figure represents a schematic principle: the manufacturer can modify it and discuss the architecture with Enel that must approve it in any case. Moreover the schematic doesn't contain several components, like overvoltage suppressors or any other necessary component). Resistor R2 creates a stable input impedance. The dip switch DS2 is normally open and it is used to connect the input electronic ground to the earth (normally the electronic ground must be insulated from the ground).

Any alternative solution to those implemented in the specifications, must be discussed beforehand and approved by Enel.

The MA pinout for the three RJ45 connectors **L₁**, **L₂**, **L₃** is shown in IEC 61869-10 and IEC 61869-11.

With a software configuration, RGDM must have the possibility to be connected to both sensors compliant with:

- the GSCT005 specification
- the Smart Termination specification

PIN specification of the RJ45 connector are reported in Table 6 and Table 7. Signal levels and impedances are reported in the follow.

Table 6 – GSCT005 Sensor Pin Table								
RJ45 PIN	1	2	3	4	5	6	7	8
Current Sensor	S1 (IL+)	S2 (IL-)						
Voltage Sensor						a (UL+)	n (UL-)	
Transducer Electronic Data Sheet (TEDS)			+			-		
Power Supply				+	-			

Table 7 – Smart Termination Derivative Sensor Pin Table								
RJ45 PIN	1	2	3	4	5	6	7	8
Current Sensor			S2 (IL-)	S1 (IL+)				
Voltage Sensor					n (UL-)	a (UL+)		
Power Supply	0 V Power Supply Reference	0 V Power Supply Reference					+	-

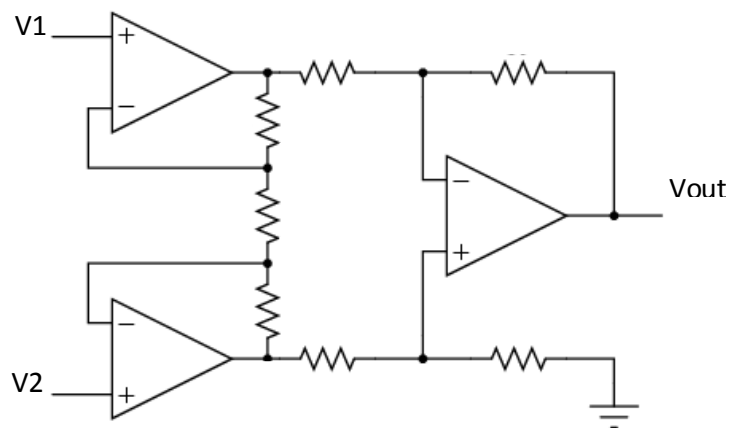

Figure 9 – Schematic principle for the instrumentation amplifier (IA)

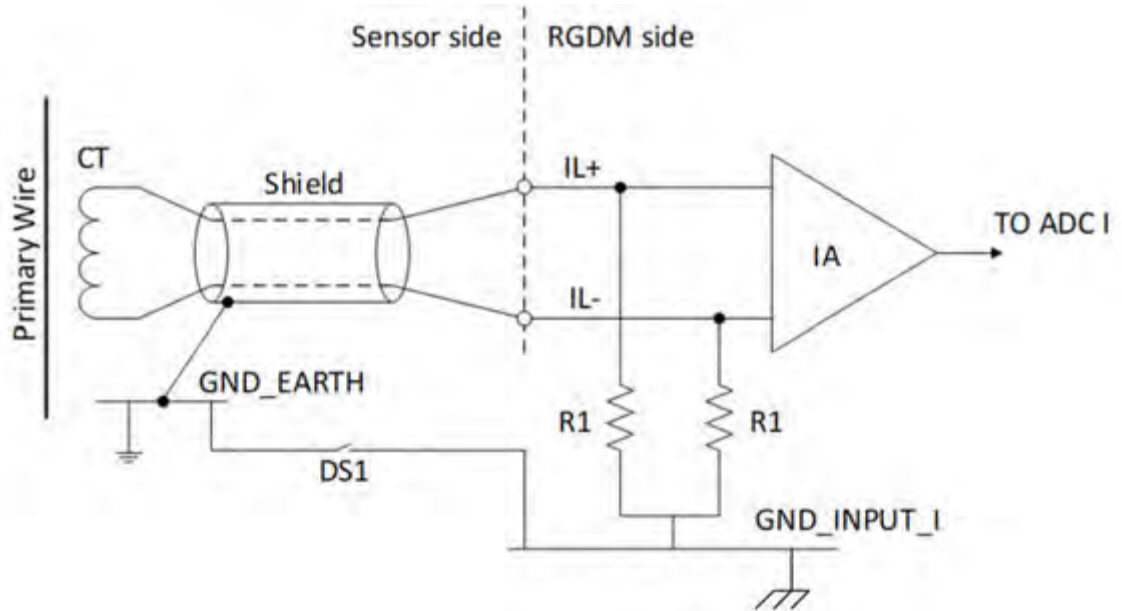

Figure 10 – Schematic principle for the current input

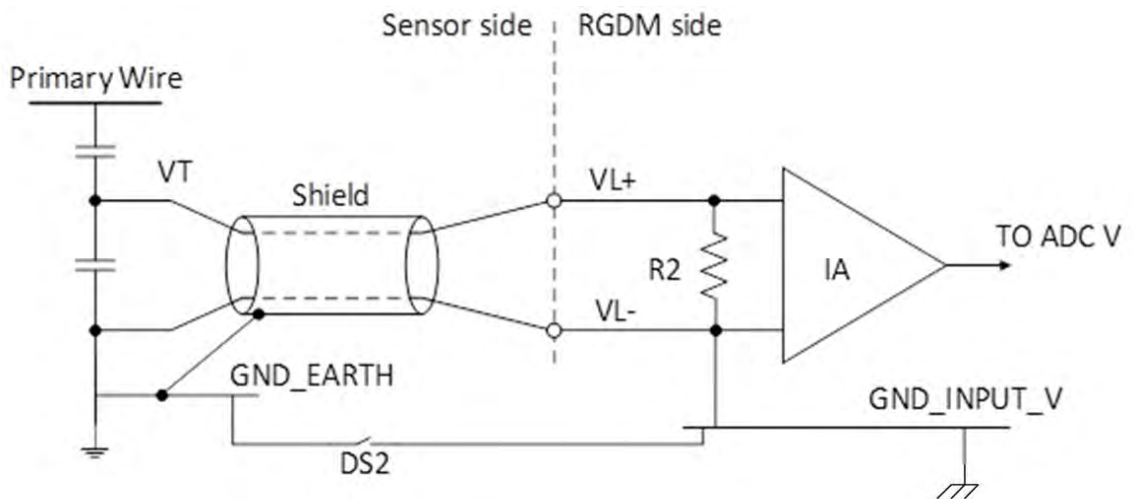

Figure 11 – Schematic principle for the voltage input

Following tables summarize pass-band, anti-aliasing filter main characteristics, sampling characteristics, including COMTRADE files sampling.

	GLOBAL STANDARD	Page 29 of 134
	Protection and control device for MV substation – RGDM control unit	GSTP011 Rev. 01 26/07/2019

Table 8 – Pass-band (for all of the analog inputs) and anti-aliasing filter		
PASS-BAND	Flat in the interval from 0,5 Hz to 6 kHz	Mandatory
<p>MANDATORY NOTES:</p> <ol style="list-style-type: none"> 1. the pass-band must be flat and linear in the interval from 0,5 Hz to 6 kHz. This requirement must be verified with connected sensors (GSCT005 and Smart Termination), in particular for current sensors, feeding the test quantity on the primary sides. Test sensors must be compliant with the GSCT005. Manufacturer will choose the internal architecture that ensure this requirement. This architecture must be shared with Enel and validated by Enel. 2. In the interval from 0,5 Hz to 6 kHz, no saturations of the acquiring stadium are allowed, for any type of power network transient. 3. Manufacturer will give to Enel the frequency response of the device, in order to prove the requirement compliancy. Frequency response can be generated applying a frequency sweep on the primary side, at constant current amplitude. 4. Manufacturer will choose a sampling architecture that must ensure a correct sampling synchronization with the signal to be sampled. This architecture must be shared with Enel and validated by Enel. 5. Manufacturer will choose a sampling architecture that must ensure a correct sampling frequency, oriented to ensure the required pass-band and avoid sampling aliasing, filters aliasing, filter incorrect behavior (e.g. in case of fast power network transients), "sample losing" phenomena, etc. This architecture must be shared with Enel and validated by Enel. 6. COMTRADE files must contain all of the samples, to avoid loss of information. "Under-sampling" of COMTRADE files is allowed, but also under an enable/disable option. COMTRADE files must contain also ADC current channels before integration, even if analogue integrator is implemented. 7. Every numerical filter inside the device must be elaborated with a time-step equal to the sampling period (sampling time-step) and all of the filters must be synchronized each other. 8. The entire acquisition cycle, filtering and numerical calculation (including the DFT elaboration) of all the analog inputs (3 currents, 4 voltages) and software built inputs (residual current, residual voltage) must be synchronous to the sampling period (sampling time-step) and then to numerical filters. 9. Aliasing any numerical filter is not allowed. Then the sampling frequency must be choose also in according to this requirement. 		
ANTI-ALIASING FILTER		
ARCHITECTURE	Hardware filter	
ORDER	≥ Second	Recommended
TYPE	Butterworth	Recommended

Table 9 reports an example of internal architecture, in terms of filters, to elaborate current derivative sensors signal. The transfer function parameters indicated in the table must be configurable.

	GLOBAL STANDARD	Page 30 of 134
	Protection and control device for MV substation – RGDM control unit	GSTP011 Rev. 01 26/07/2019

Table 9 – Example of Current Signal Integration Filters (For Derivative Current Signal)	
HIGH-PASS FILTER	
TYPE	Numeric filter
ORDER	First
CUT-OFF FREQUENCY	0,5 Hz
LOW-PASS FILTER	
TYPE	Numeric filter
ORDER	First
CUT-OFF FREQUENCY	5 Hz
MANDATORY NOTES Using an integrator cut-out frequency equal to 5 Hz, it is necessary to integrate frequencies in the band 0, 5 Hz to 5 Hz to “rebuild” the signal in this band. The RGDM must also sample the derivative current signal before integration; in order to detect high impedance fault and for predictive logic. The manufacturer will propose a technical solution to satisfy these requirements.	

6.2.3.1 Analog Input from the voltmetric sensors

The analogue voltmetric inputs are used to measure the secondary signal coming from the CT-VT sensors, in order to convert it into a digital signal, suitable for the protection and measurement functions. The secondary signal from the CT-VT sensors is a signal that is directly proportional to the primary voltage, in terms of a constant multiplier coefficient, equal to the ratio between Primary and Secondary.

The RGDM's analog inputs must have a secondary signal measurement range of 0 Vrms to 3, 96 Vrms to which the following primary values correspond: 0 kV and $\frac{68,6 \text{ kV}}{\sqrt{3}}$, which corresponds to a ratio between the primary and secondary value of $\frac{10000 \text{ V}}{1 \text{ V}}$.

The precision of each individual input must be less than 0,2%, and the standard deviation between the three voltmetric inputs must be less than 0,02.

The scale range is 39,6 kVrms per phase.

The device must be able to measure voltages from voltmetric sensors for the RGDAT device, with an automatic calibration function for the three voltages. In this case, the precisions are linked to the tolerance of the primary capacitors.

The RGDM's partitioning capacities must ensure a tolerance of 5% and a thermal drift better than 50ppm/°C, when used with RGDAT sensors.

The RGDM must be able to be configured using software, so that the type of reading on a purely resistive load or with capacitive partition can be established. In the capacitive case, the selection on the three diverters on the board must then be set unequivocally.

The nominal value for the primary voltage must be able to be configured within a range of:

- a. Minimum calibration value = $\frac{6 \text{ kV}}{\sqrt{3}}$
- b. Maximum calibration value = $\frac{36 \text{ kV}}{\sqrt{3}}$
- c. Calibration steps 0,5 kV

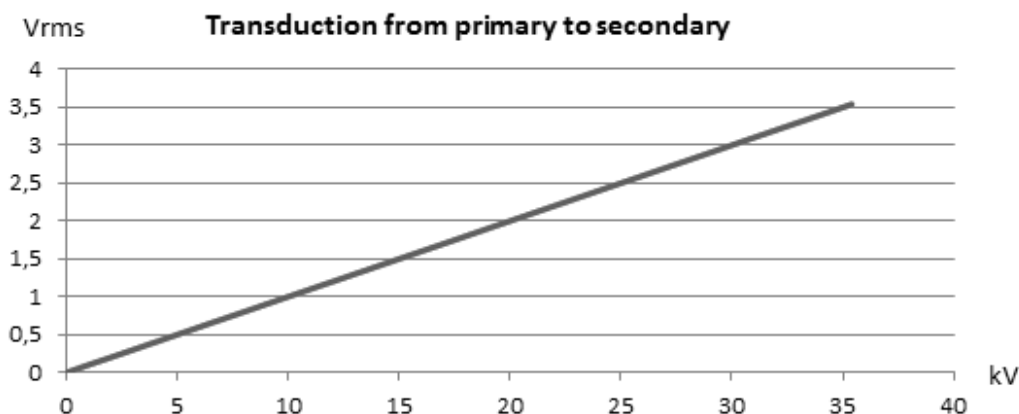

Figure 12 – Linear voltmetric inputs

In addition, the RGDM must be able to handle a further transformation ratio of $\frac{230V}{1V}$, configurable by software, for the low voltage measurements.

With a software configuration, RGDM must have the possibility to be connected to both sensors compliant with:

- the GSCT005 specification
- the Smart Termination specification

The PIN specification of the RJ45 connector are reported in Table 6 and Table 7. Electrical characteristics for voltage sensors are reported in Table 10 and Table 11.

The analog voltage input type, is reported in Table 12.

For the Smart Termination the resistance that analogue input must offer to the sensor must be $2\text{ M}\Omega \pm 5\%$, without introducing eddy reactors. In particular, the eddy capacity value must be less than 50 pF. In the case of capacitive partition, the load condenser's value must be between 100 and 1000 nF.

Table 10 – RJ45 Characteristics of the voltmetric circuits	
	Reference
Peak-peak value	11,68 V ($\pm 5,84V$)
Nominal effective secondary voltage (RMS)	1V
Input resistance	$2\text{ M}\Omega \pm 5\%$
Input capacity	$< 50\text{pF}$
Maximum admissible measurement error ϵ	$< 0,2\%$
Admissible standard deviation between the Voltmetric inputs	$< 0,02$
Maximum admissible angle error	$< 0,5^\circ$

Table 11 – GSCT005 Voltmetric sensor electrical characteristics	
Voltage Sensor Ratio	$10000\text{ V} / 1\text{ V}$
Voltage Sensor Burden (input impedance of the RGDM)	Resistance = $2\text{ M}\Omega$
	Capacitance $\leq 50\text{ pF}$

Table 12 – Voltage Measurement Inputs		
TYPE	Pure differential balanced input, based on instrumentation amplifier with negative input connected to the ground (see Figure 12)	Mandatory

	GLOBAL STANDARD	Page 32 of 134
	Protection and control device for MV substation – RGDM control unit	GSTP011 Rev. 01 26/07/2019

6.2.3.2 Analog voltmetric Inputs for the RGDM sensors

The device must provide the possibility to measure voltages from voltmetric sensors used for RGDM device. The selection of these channels must be setting by SW, with voltages calibration function trough the method used by the RGDM.

6.2.3.3 Analog Input from the amperometric sensors

The analogue amperometric inputs are used to measure the secondary signal coming from the CT-VT sensors, in order to convert it into a digital signal, suitable for the protection and measurement functions (the input schematic principle is reported in Figure 10).

With a software configuration, RGDM must have the possibility to be connected to both sensors compliant with:

- the GSCT005 specification
- the Smart Termination specification

PIN specification of the RJ45 connector are reported in Table 6, and Table 7.. Electrical characteristics for current sensors are reported in Table 13 and Table 14.

The analog current input type, is reported in Table 15.

The secondary signal coming from the CT-VT sensors is a signal that can be proportional:

- a. directly, to the current value transduced by the sensor, with three different scales;
- b. Directly to the current derivative, in relation to the time $L \frac{di}{dt}$, with three different scales.

It must be possible to select the six input modes, using configuration software.

Depending on the measurement mode chosen, the RGDM will have the following ranges of variation of the primary current and relative secondary input voltage:

- c. (case 1, linear) the current measuring range must be between 0 and 8800 A, with a primary secondary ratio of $\frac{1000A}{31mV}$ which corresponds to a maximum RMS voltage of 272,8 mV;
- d. (case 2, linear) the current measuring range must be between 0 and 8800 A, with a primary secondary ratio of $\frac{1000A}{100mV}$ which corresponds to a maximum RMS voltage of 880 mV;
- e. (case 3, linear) the current measuring range must be between 0 and 8800 A, with a primary secondary ratio of $\frac{1000A}{300mV}$ which corresponds to a maximum RMS voltage of 3,96 Vrms;
- f. (case 1, derivative) the current measuring range must be between 0 and 8800A, with a primary secondary ratio of $\frac{1000A}{31mV}$ which corresponds to a maximum RMS voltage of 272,8 mV;
- g. (case 2, derivative) the current measuring range must be between 0 and 8800A, with a primary secondary ratio of $\frac{1000A}{100mV}$ which corresponds to a maximum RMS voltage of 880mV;
- h. (case 3, derivative) the current measuring range must be between 0 and 8800 A, with a primary secondary ratio of $\frac{1000A}{300mV}$ which corresponds to a maximum RMS voltage of 3,96 Vrms;

For the RGDM, the nominal primary current value to be used as a reference for measurements in p.u. must be 500 A. It must be possible to set the nominal current values between 0 and 500 A in 1 A steps.

The precision of each individual input must be less than 0,2%, and the standard deviation between the three amperometric inputs must be such that on the 3Io it guarantees a resultant $\leq 0,3$ A, with a positive current sequence of 300 A.

The resistance value, that must offer analogical input to the sensor, must be $20 \text{ k}\Omega \pm 5\%$, without introducing eddy reactors. In particular, the eddy capacity value must be less than 500 pF.

	GLOBAL STANDARD	Page 33 of 134
	Protection and control device for MV substation – RGDM control unit	GSTP011 Rev. 01 26/07/2019

Due to the nature of the transducers with derivation, the signals acquired will be proportional to the frequency, and must therefore be integrated analogically or numerically. The measurements and graphic reconstructions must guarantee a higher response linearity in relation to the scale range, up to the 3rd harmonic (8800 A at 150 Hz). Current gradients, up to a ratio of 1000 A / 0,2 ms, shall also be linearly transduced.

Table 13 – Characteristics of the amperometric circuits	
	Reference
Peak-peak value	11,68 V (\pm 5,84V)
Nominal effective secondary voltage (RMS)	1V
Input resistance	20 k Ω \pm 5%
Input capacity	< 500pF
Maximum measurement error from 550 to 8800 A	< 3,0%
Maximum measurement error from 50 to 550 A	< 0,2% ¹
Maximum measurement error from 1 to 50 A	< 0,5%
Maximum admissible angle error	< 0,5°

Table 14 – GSCT005 sensor electrical characteristics	
Current Sensor Ratio	500 A / 150 mV
Current Sensor Burden (input impedance of the RGDM)	Resistance = 20 k Ω
	Capacitance: \leq 10 pF

Table 15 – Current Measurement Inputs		
TYPE	Pure differential balanced input, based on instrumentation amplifier with common-mode signal suppression (see Figure 10)	Mandatory

The precisions relate to the read value, for measurements sampled at 200ms and averaged at 10s and for the amplitudes indicated.

6.2.3.4 Calibration of Analog Inputs

The RGDM must be able to use software to calibrate each individual input, both amperometric and voltmetric, with a complex coefficient represented in modulus and phase.

The modulus represents the ratio between the theoretical signal modulus and the real value measured. This coefficient multiplies the input signal, whereas the angle must be expressed in sexagesimal degrees, and must be added algebraically to the angle measured in relation to an absolute phase within the RGDM.

Table 16 shows the regulation fields for the software. The calibration coefficients must not be taken as increasing or decreasing the measurement dynamic, but as compensation for the errors of the CT-VT sensors themselves.

Table 16 – Calibration coefficients		
	Range	Step
Gain calibration coefficient	0,5 – 1,5	0,0005
Phase coefficient	-180 - +180	0,025

¹ P and Q indirect measurements shall assure in the whole range from 0% to 110% nominal values a maximum amplitude error < 0,5% and a maximum phase angle of 0,5°. In case of necessity a double acquisition chain may be adopted, using 2 ADCs with different purposes: one for measurement and one for protection.

	GLOBAL STANDARD	Page 34 of 134
	Protection and control device for MV substation – RGDM control unit	GSTP011 Rev. 01 26/07/2019

The precision and standard deviation requirements are there to satisfy the dual need for:

- a. Guaranteeing adequate precision for the measuring and protection functions.
- b. Calculating the values of $3V_o$ and $3I_o$ as the sum of the individual measurements for the three phase voltages measured and the three phase currents measured, without introducing $3V_o$ and/or $3I_o$ values that are not real. The test methods are explained in Chapter 11.

6.2.3.5 Measurement Inputs for Synchronism Function

The RGDM device must have a voltmetric measuring input; the characteristics must be selected between:

- a. characteristics similar to those described in par.6.2.3
- b. characteristics indicated in the specification of the RGDAT device

The input is used for the measurement of the reference voltage for the automatic parallel function. The input must automatically calibrate when the switch position is close and set its voltage equal to that of the corresponding phase.

Any alternative solution to that implemented in the specification must be previously discussed and approved by Enel.

6.2.3.6 Measurement Converter

All the measurements done by the RGDM can be sent by a 4÷20 mA transducer. There is only one transducer and so one of the n measurements can be sent. All the measurements must be able to modulate the measurement scale range to 20 mA , with these characteristics:

- | | |
|---|-----------|
| a. Output level (terminals 4 and 7 in Figure 14): | 4 ÷ 20 mA |
| b. Precision not taking the measurement sensors into account: | ±1% |
| c. Maximum load impedance on the measurement converter: | 720 Ω |
| d. Remote measurement update time: | 100 msec |

Both output poles to the UP must be not connected to ground. The power supply of the converter must be isolated from the internal supply and 24 Vdc power supply.

6.2.4 Physical and virtual inputs

It must be possible to programme the physical and virtual inputs, and to associate any of the functions shown in Table 17. If more than one variable is selected, the input status will enable all the enabled functions.

Each input must be programmed for direct or inverted logic, and it must be possible to associate a t_{ON} and t_{OFF} timer, as indicated in Table 18.

For the protection function blocks:

- a. The block for the individual protection function started by the trip with the timers in reset state, and therefore the start-up circuits will not be blocked.
- b. The “*block all*” function, blocks all the protection functions, as well as the start-up circuits.

Table 17 – Input Functions
FUNCTION
Block 51.s1
Block 51.s2
Block 51.s3
Block 51.s4
Block 51N.s1

	GLOBAL STANDARD	Page 35 of 134
	Protection and control device for MV substation – RGDM control unit	GSTP011 Rev. 01 26/07/2019

Block 51N.s2
Block 51N.s3
Block 67N.s1
Block 67N.s2
Block 67N.s3
Block 67N.s4
Remote Trip
Reset signals
Reset counters
Reset CB Monitor
Averaged reset measurements
52a
52b
Switch opening
Switch closing
FSL/SFS enabling
Switch fault
Trigger fault
Ext prot. trigger
Re-closing enabling
Re-closing block
External re-closing trigger
Include re-closing
Exclude re-closing
Inversion
RVS
Local
Block All
Include 25
Exclude 25
Relays 1- 51
Relays 2- 51
Relays 3- 67
Relay 4 - opening 52
Relay 5 - closing 52
Remote Close

Table 18 – Programming Input		
Description	Value	Um
IN1		
Logic	DIRECT	
IN1 t _{ON}		
Value	0,00	s
IN1 t _{OFF}		
Value	0,00	s

6.2.5 Virtual outputs

It must be possible to associate the functions shown in Table 19 as well as the functions programmed by the PLC to the virtual outputs.

It must be possible to configure the Vout signal to continue for the time established beforehand, or for the duration of the associated function.

It must be possible to associate a test function to the Vout in order to generate GOOSE or Report signals.

Table 19 – Functions associated to Vout

Functions	
Trigger	51.s1
Trigger	51.s2
Trigger	51.s3
Trigger	51.s4
Trigger	51N.s1
Trigger	51N.s2
Trigger	51N.s3
Trigger	67N.s1
Trigger	67N.s2
Trigger	67N.s3
Trigger	67N.s4
Start-up	51.s1
Start-up	51.s2
Start-up	51.s3
Start-up	51.s4
Start-up	51N.s1
Start-up	51N.s2
Start-up	51N.s3
Start-up	67N.s1
Start-up	67N.s2
Start-up	67N.s3
Start-up	67N.s4

6.2.6 Terminal boards

The RGDM must have four terminal boards, as shown in the main diagram illustrated in Figure 13.

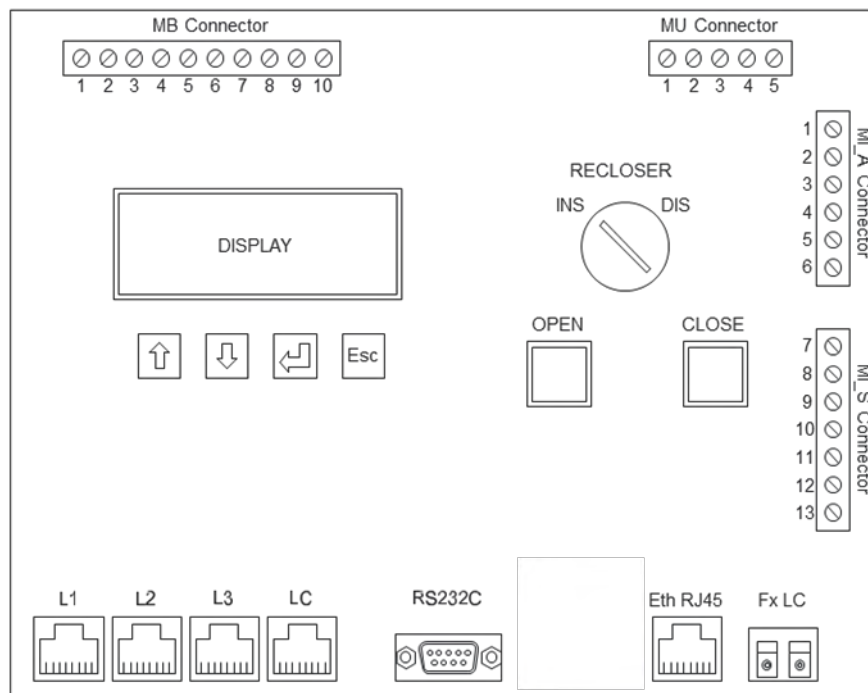

Figure 13 – Main electrical Terminal boards of the RGDM

As shown in the above figure, the MI connector are divided into MI_A (1.....6) and MI_S (7.....13).

Besides the digital terminal boards, the RGDM must have four analogue terminal boards, named: MA (a triad of RJ45 connectors for L1,L2,L3 and LC for synchronism voltage).

The MA terminal board for the CT-VT triad, wired independently of the configuration on which the RGDM is installed (Basic or Extended).

The MB terminal board, relates to the RGDM's connection to the current UP. The 9 pole cable with rectangular connector must be connected to this terminal board (Figure 23).

The MU and MI terminal boards are only used for installation in an extended configuration. In this case, the power supply cables of the RGDM must be connected on the MU terminal board; furthermore, the connection of the local switch command is also provided. The MI terminal board is located to the interface between the RGDM and the MV RMU (according to GSCM004). The first 6 terminals relate to the RGDM's power supply and the switch spring loading motors power supply. Terminal n° 7, marked +L, is always located to the remote control signal, and if already wired to MU, this can remain free. The remaining terminals are to be connected to acquire the switch's status and to send the OdM's open and close commands.

The two relays used to command the OdM must also be fitted on the RGDM's board.

All the terminal boards must be of an extractable type, with a 5.08mm pitch, and it must be possible to extract them from the equipment without disconnecting the wiring (without fixing flanges).

The type of terminal to be used will be provided by ENEL during the procurement process (par.12.2).

6.2.6.1 MA Terminal Board

Four RJ45 female connectors must be set up inside the RGDM, conform to IEC 61869-10 and IEC 61869-11.

6.2.6.2 MB Terminal Board

A terminal board must be set up inside the RGDM (Figure 14), named MB, suitable for housing conductors with a section up to 2.5 mm², to which the connection cable must be connected for the remote control peripheral unit (UP).

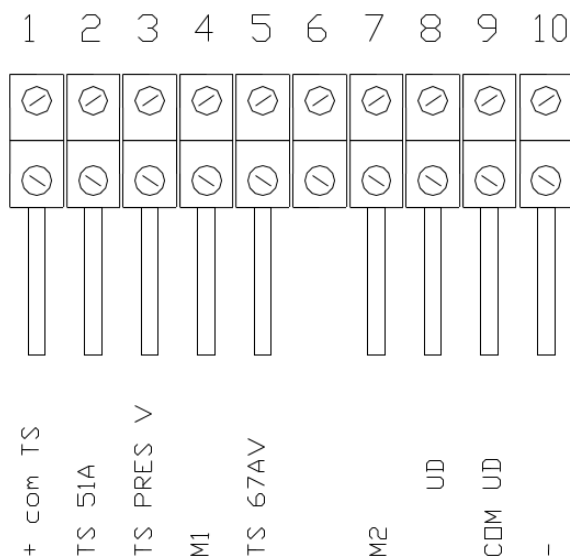

Figure 14 – Signals Output Terminal Board (MB)

The electrical characteristics of the MB terminal board are shown in Table 20.

Table 20 – MB terminal board

1	+ com TS	Power supply (+24Vcc) and Common remote signals
2	TS 51A	Multi-phase or double single-phase fault
3	TS PRES V	MV voltage on (level)
4	M1	Remote measurement - pole 1 (positive)
5	TS 67AV	Single-phase and intermittent arc (downstream) fault
6		
7	M2	Remote measurement - pole 2 (negative)
8	UD	Inversion of direction command 67 AV (common)
9	COM ID	Inversion of direction command 67 AV
10	-	Power supply (-24Vcc)

The command for inversion of direction, UD, must be formed as indicated in Figure 15.

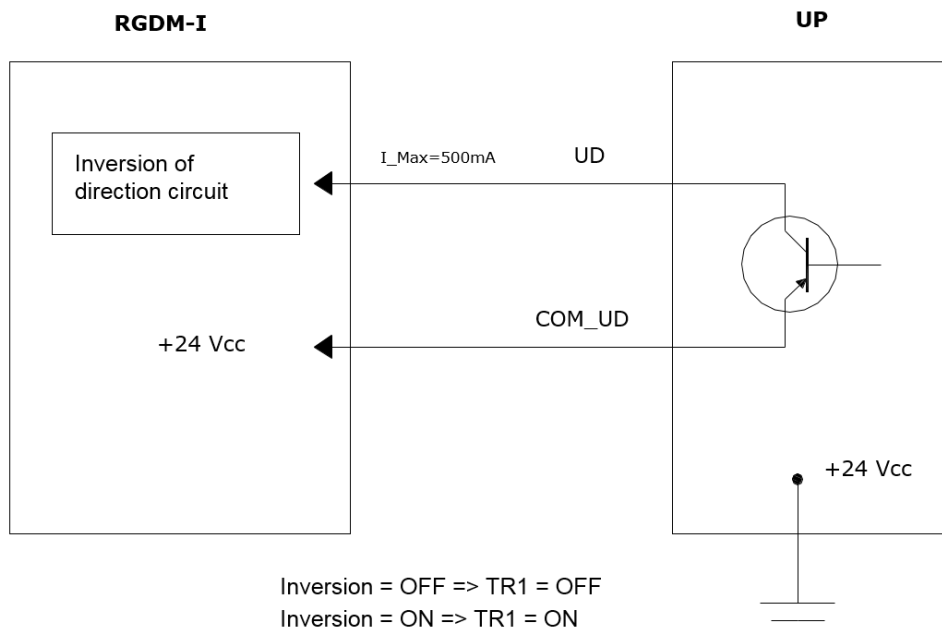

Figure 15 – Diagram for inversion of direction command for detecting single-phase faults to earth

6.2.6.3 MI Terminal Board

A terminal board must be set up inside the RGDM (Figure 16), named MI, suitable for housing conductors with a section up to 2.5 mm², to which the connection cable must be connected for the OdM. All the digital inputs must provide protection against inversion of polarity.

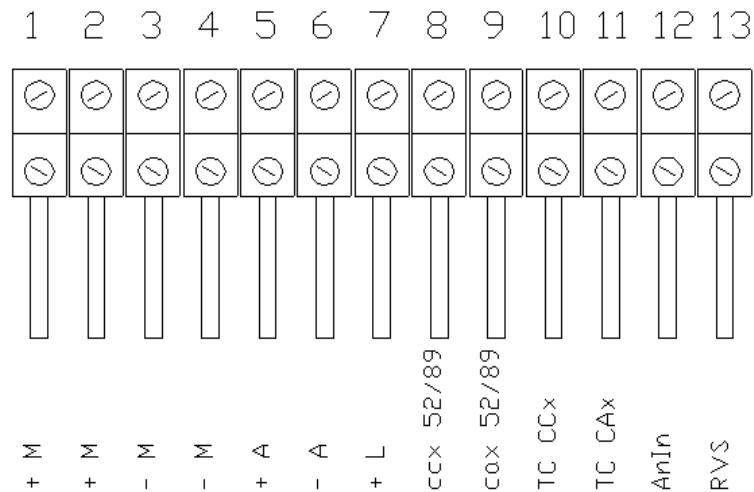

Figure 16 – OdM command output terminal board

The electrical characteristics of the MI terminal board are shown in Table 21.

Table 21 – MI terminal board			
1	MI_A	+M	Power supply, motors OdM (+) 24 Vdc
2	MI_A	+M	Power supply, motors OdM (+) 24 Vdc
3	MI_A	-M	Power supply, motors OdM (-) 24 Vdc
4	MI_A	-M	Power supply, motors OdM (-) 24 Vdc
5	MI_A	+A	Power supply RGDM and MV RMU command circuits (+) 24 Vdc
6	MI_A	-A	Power supply RGDM and MV RMU command circuits (-) 24 Vdc
7	MI_S	+L	MV/LV substation in local command (enabling buttons on RGDM and OdM)
8	MI_S	ccX 89	OdM closed signal
9	MI_S	caX 89	OdM open signal
10	MI_S	TC CCx	OdM Closing Command
11	MI_S	TC CAx	OdM Opening Command
12	MI_S	AnIn	Switch fault
13	MI_S	RVS	Bar power on

Each command must be sent to the field by means of actuator relays, with armed +24V contacts. The section and isolation of the circuits and conductors must be suitable for handling 10A direct current and a voltage of 24 V.

The relays must have the following characteristics:

- Rated contacts current: 5 A
- Isolation between contacts and coils: 3 kV
- Breaking capacity: 10 A with L/R = 40 ms
- Duration: 1×105 maneuvers at the rated breaking capacity

It must be possible to enable or disable the relays from the “Remote control enabling” switch, activated by the “Local / Remote Control” switch on the UP/Primary RTU.

	GLOBAL STANDARD	Page 40 of 134
	Protection and control device for MV substation – RGDM control unit	GSTP011 Rev. 01 26/07/2019

The activation time must be programmable between at least 0.0 (minimum relay time) and 2 seconds in 0,01 sec steps.

The MI terminal board must be wired using a cable with the following characteristics:

- e. Rated isolation voltage: 300/500 V
- f. Formation: 4x2+7x1 mm²
- g. Flexible annealed, not tinned, copper conductors
- h. R2 quality PVC insulation
- i. Outside diameter (of the insulation) of the cores: Ø 3 mm
- j. Distinction of the cores by marked numbers (according to CENELEC HD 186 S2), connecting the marked numbers with the identifying numbers on the conductor's pins
- k. Rz quality PVC sheath
- l. Flameproof characteristics in accordance with IEC 60695-1-10

A belt-type marking device must be fitted at both ends of the cable, made of PVC, to be used, during installation, to indicate the number and name of the compartment it relates to.

The cable must have a terminal that is suitable for being inserted into the connector on the MV RMU (according to GSCM004). Both the fixed part, installed on the MV RMU (according to GSCM004), and the loose part of the cable, are shown below:

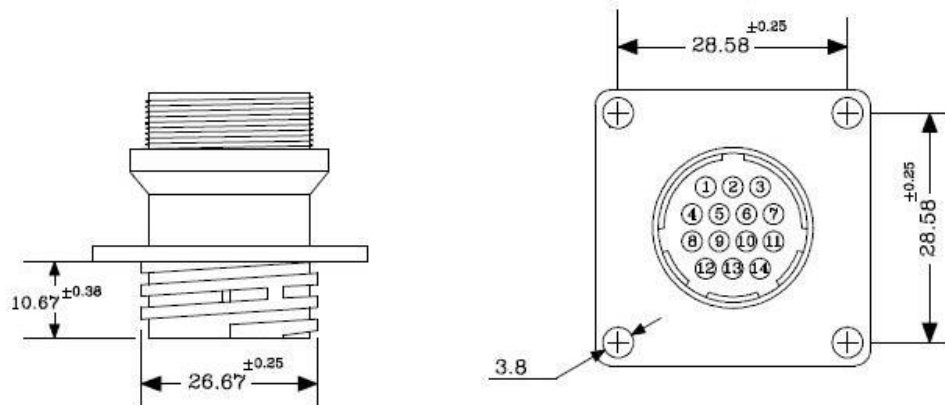
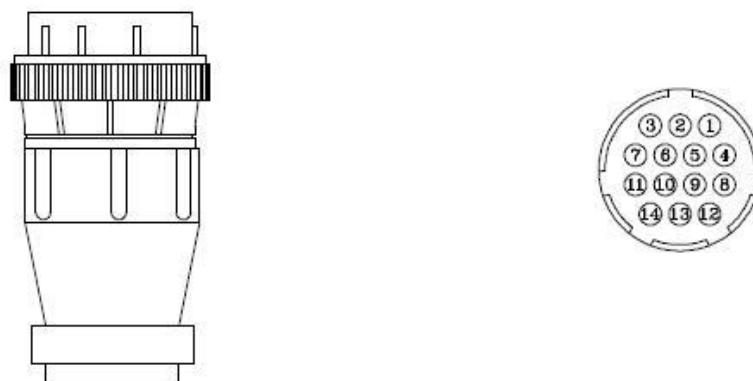

Figure 17 – Fixed part installed on the MV RMU (according to GSCM004)



	GLOBAL STANDARD	Page 41 of 134
	Protection and control device for MV substation – RGDM control unit	GSTP011 Rev. 01 26/07/2019

Figure 18 – Loose part installed on the cable

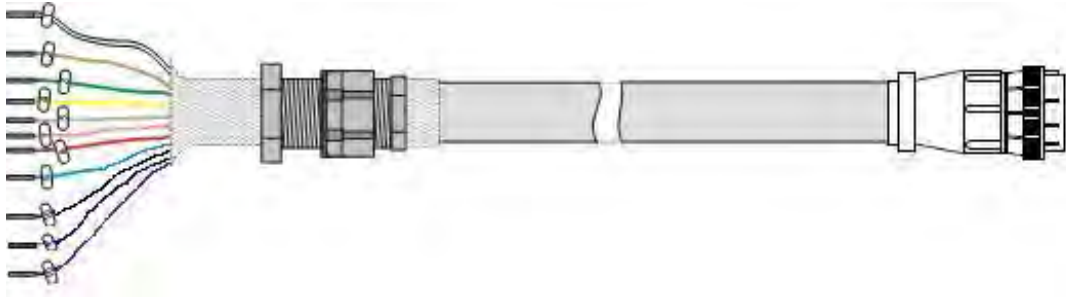

Figure 19 – Connection cable with the MV RMU (according to GSCM004) for OdM

The connector's pinout is shown in Table 22.

Pin	Signal	Description
1	+M	Supply (+24Vdc) motor
2	...	(not used)
3	-A	Common (- 24Vdc) commands
4	+M	Supply (+24Vdc) motor
5	Com TS	Common signals, OdM status
6	+L	Local commands (+24Vdc)
7	-M	Supply (-24Vdc) motor
8	89caX	IMS Open-state signal
9	...	(not used)
10	-M	Supply (-24Vdc) motor
11	CCX	Remote Close Command
12	89ccX	OdM Closed-state signal
13	...	(not used)
14	CAX	Remote Open Command

6.2.6.4 MU Terminal Board

The MU terminal board connects the power cables between the UP/Primary RTU and the RGDM in extended configuration. The power supply cables of the RGDM (at least 2.5 mm²) must be connected to this terminal board. In addition, a +L signalling cable will make it possible to set the MV/LV substation equipment locally or by remote control, via a selector located on the UP/Primary RTU.

When the local command is activated, the RGDM will enable the open and close buttons on the board and, if applicable, those replicated in the GSCM004.

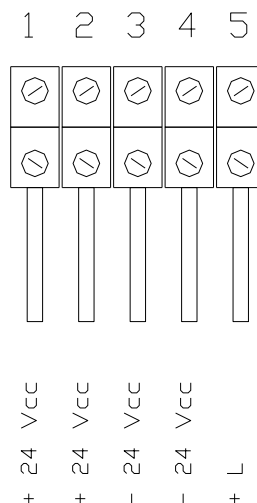

Figure 20 – MU Terminal Board

6.2.7 Connection to the RTU

For the electrical connection between the indoor RGDM and the remote control unit (device power supply and signal transfer) a cable must be provided (Figure 21) that is 9 m long, in the form of 9 x 1mm². The connection cable for the outdoor RGDM is shown in Figure 22.

One end of the cable must be fitted with the rectangular connector shown in Figure 21. The other end must be set up for connecting the MB terminal board in the RGDM. Each cable conductor must be equipped with tip ends, as well as indelible identifying markings, according to the numbering of the MB connector.

Type of installation	Cable length	Termination
Indoor RGDM for MV/LV substation	9 m	Figure 19
Outdoor RGDM	1,10 m	Figure 20

The connector must be made of isolating material with adequate electrical, mechanical, and climatic characteristics. It must also be complete with a cable clamp.

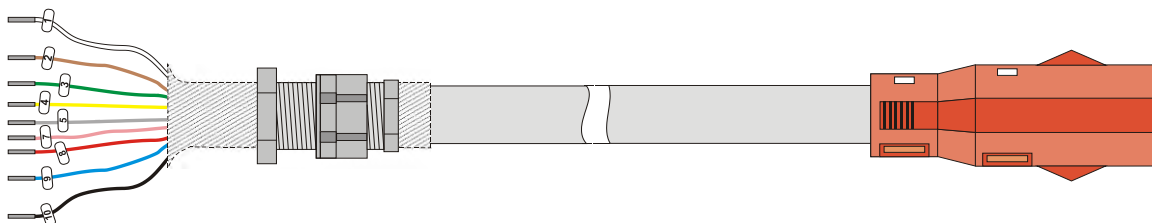



Figure 21 – Connection cable for Indoor RGDM

	GLOBAL STANDARD	Page 43 of 134
	Protection and control device for MV substation – RGDM control unit	GSTP011 Rev. 01 26/07/2019

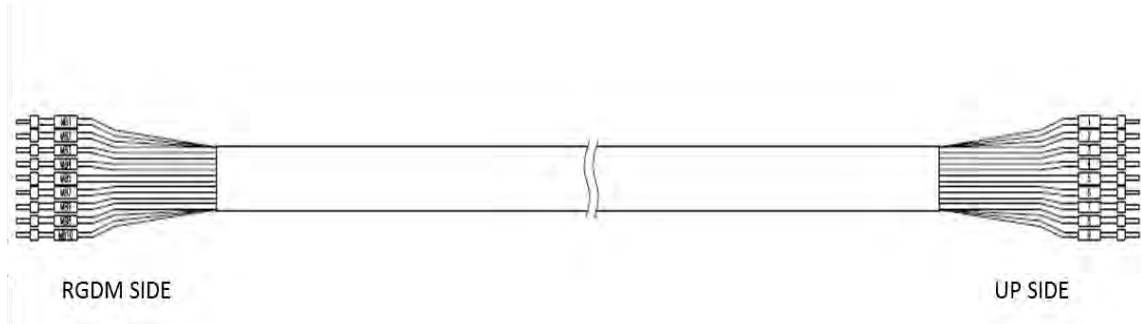

Figure 22 – Connection cable for Outdoor RGDM

The male contacts (the female contacts are part of the fixed part installed on the UP - not included in the supply), must be able to accept conductors with a section of up to 2 mm², and guarantee the following characteristics:

- | | |
|---|--------------------|
| a. Nominal operating voltage | 24 V |
| b. Nominal current | 13 A |
| c. Voltage drop over a male-female pair crossed by a 5A current | ≤50 mV |
| d. Insertion/extraction force | 0,40 ±10 N/contact |

The cable's characteristics must be as follows:

- | | |
|--|-----------------------|
| e. Nominal voltage: | 300/500 V |
| f. Formation: | 9 x 1 mm ² |
| g. Flexible annealed, not tinned, copper conductors | |
| h. R2 quality PVC insulation | |
| i. Outside diameter (of the insulation) of the cores: | ≤3 mm |
| j. Rz quality PVC sheath | |
| k. Flameproof characteristics in accordance with IEC 60695-1-10 | |
| l. Cores distinguished by colors, according to CENELEC HD 186 S2 | |

Cores of the same color can also be accepted, provided the reference numbers for the MB terminal board are stamped on the core itself.

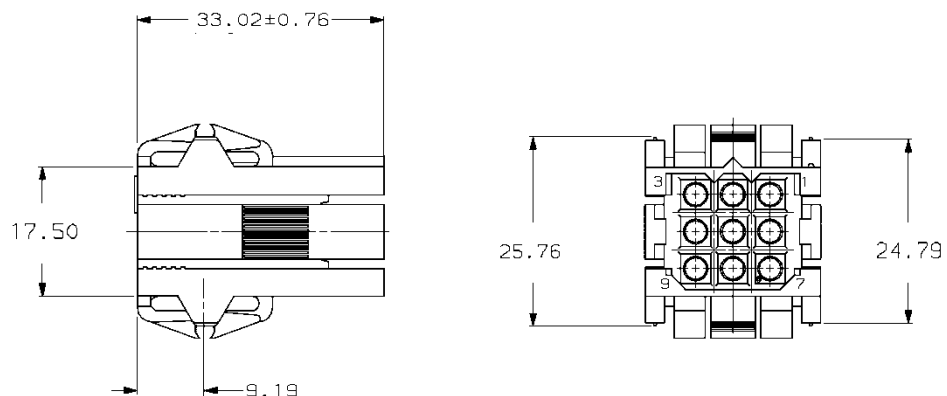



Figure 23 – Rectangular connector to the RTU

	GLOBAL STANDARD	Page 44 of 134
	Protection and control device for MV substation – RGDM control unit	GSTP011 Rev. 01 26/07/2019

A belt-type marking device must be fitted at both ends of the cable, made of PVC, to be used, during installation, to indicate the number and name of the compartment it relates to.

1	Com TS	Power supply (+24Vcc) and Common remote signals
2	TS 51 A	Multi-phase or double single-phase fault
3	TS PRES V	MV voltage on (level)
4	+M1	Measurement - pole 1
5	TS 67AV	Single-phase fault (downstream)
6	-M2	Measurement - pole 2
7	COM ID	Inversion of direction command 67 AV (common)
8	UD	Inversion of direction command 67 AV
9	-	Power supply (-24Vdc)

6.2.8 Relay command contacts

The characteristics of the five relays differ for command and signaling relays.

Command relays:

- a. Nominal current $\geq 5 \text{ A}$
- b. Disconnection power at 24 Vdc $\geq 10 \text{ A}$ (with L/R = 40 ms)
- c. Coil / contacts insulation $\geq 3 \text{ kVdc}$
- d. Number of guaranteed electrical manoeuvres $\geq 10^5$
- e. Number of guaranteed mechanical manoeuvres $\geq 10^6$

Signaling relays:

- f. Nominal current $\geq 2 \text{ A}$
- g. Disconnection power at 24 Vdc $\geq 0,5 \text{ A}$ (with L/R = 40 ms)
- h. Coil / contacts insulation $\geq 3 \text{ kVdc}$
- i. Number of guaranteed electrical maneuvers $\geq 10^5$
- j. Number of guaranteed mechanical maneuvers $\geq 10^6$

6.2.9 Memory

The RGDM must be able to store a series of fault events and signals locally, as well as the measurements taken. The memory for each type of event must be created with a circular buffer with FIFO (First In First Out) type operating logic.

The device must store the following information in a non-volatile type memory, broken down by operating groups:

- a. **Faults Register:** 200 activation events (cause of the action, date & time, all the measurements at 20ms)
- b. **Events Register:** 1024 generic events (list of start-ups, actions, digital status, date & time, info)
- c. **Measurement functions:**
 - 4320 measurements (one every 10 minutes, for 30 days) for P, Q, I and V (magnitude and angle values, date & time). In particular, the RGDM must store the value calculated as the minute average, which is also sent to the centre using the data network in place.
 - 200 events of max THD (max. THD, date & time)

	GLOBAL STANDARD	Page 45 of 134
	Protection and control device for MV substation – RGDM control unit	GSTP011 Rev. 01 26/07/2019

d. DG management functions: (if requested ref. to par.10.2 and par.10.3)

- 10080 measurements for P, Q, and V respectively (date & time value), sent using the UPG function, by the generator to the RGDM.
- 10080 measurements for P, Q, and V respectively (date & time value), detected using the UPG function, by the RGDM at the delivery point.

It must be possible to view and export all the data saved using the SW provided, while the export format can be either .txt or .xls.

The events must be stored in the following page format:

Event code	dd/mm/yyyy	hh:mm:ss.000
Example: 67_S2	26/03/2009	21:06:37.000

The events to be stored in the circular memory, in the format indicated above, are listed in Table 24. The event log must also show the state of the variable with timestamp. All the I/Os both physical and virtual must be recorded. Each event must be written using the code indicated in the same table:

Table 24 – Code and event to save	
67N_S1	Directional earth trigger for first threshold
67N_S2	Directional earth trigger for second threshold
67N_S3	Two-way trigger for double single-phase fault to earth
67N_S4	Trigger for intermittent fault to earth
51_S1	Maximum phase current trigger
67_S2	Maximum directional phase current trigger
67_S3	Maximum directional phase current trigger
67_S4	Maximum directional phase current trigger
32P.S1	Maximum power trigger
79_RR	Rapid re-closing commanded
79_RL	Slow re-closing commanded
79_RM	Saved re-closing commanded
79_FR	Re-closing failed
59N_S1	Maximum single-pole voltage trigger
59Vi_S1	Maximum inverse voltage trigger
59N_S1Avv	Maximum single-pole voltage start-up
59Vi_S1Avv	Maximum inverse voltage start-up
AnPa	Panel Anomaly
AnCT-VT	Sensor Anomaly
67N_S1Avv	Directional earth start-up for first threshold
67N_S2Avv	Directional earth start-up for second threshold
67N_S3Avv	Double single-phase to earth threshold directional start-up
67N_S4Avv	Intermittent fault to earth start-up in S1 and S2
51_S1Avv	Maximum phase current start-up
67_S2Avv	Maximum directional phase current start-up
67_S3Avv	Maximum directional phase current start-up
67_S4Avv	Maximum directional phase current start-up
87_R2H	INRUSH current protection trigger
87_R2HAvv	INRUSH current protection start-up
47_S1	Voltage cyclical direction inversion trigger
47_S1Avv	Voltage cyclical direction inversion start-up
Max THD_V	Exceeding voltage THD threshold
Max THD_I	Exceeding current THD threshold
32P.S1Avv	Maximum active power start-up
RVL	Voltage presence

	GLOBAL STANDARD	Page 46 of 134
	Protection and control device for MV substation – RGDM control unit	GSTP011 Rev. 01 26/07/2019

Remote reading and extraction of data saved on the RGDM must be possible, and transmission of data in the RGDM must be handled using the SFTP protocol.

The RGDM must include a double backup memory (one for the protection functions, and one for the measurement and DG management functions if requested, ref. par. 10.2) in which previous configuration data must be stored.

This is done to avoid situations in which, during an unsuccessful update that could also be sent by the center by SFTP, the previous configuration is lost.

Each pair of memories must work using the following logic:

- a. The first modulus must be used to store the calibration values and any operating parameter.
- b. The second modulus must be used when updating or reprogramming the equipment.

In these cases, the new data must be stored temporarily in this memory, and transferred to the first when the transfers are complete. This means that the second will always act as a backup for what the equipment is busy doing.

6.3 Layout of the RGDM

The RGDM's layout must be, as far as possible, as shown in Figure 24.

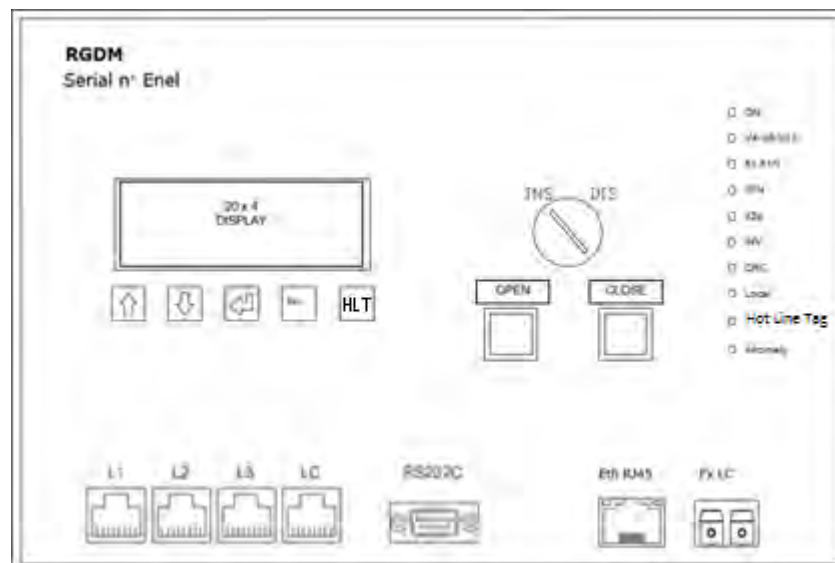



Figure 24 – External layout of the RGDM

6.4 Display

The RGDM is to have an alphanumerical display with 4 lines and with 20 characters per line (20x4), that is back-lit and white and blue in color.

Besides the display, the device must also have n° 10 programmable LEDs on the front that meet the following requirements by default:

- a. ON (green)
- b. V4-V8-V12 (green)
- c. 51-51N (red)
- d. 67N (red)
- e. 32p (red)

	GLOBAL STANDARD	Page 47 of 134
	Protection and control device for MV substation – RGDM control unit	GSTP011 Rev. 01 26/07/2019

- f. INV (green)
- g. CRC (yellow)
- h. Local (green)
- i. Hot Line Tag (red)
- j. Anomaly (red)

At any led can be assignable any signal or event that the RGDM manage with a binary output. Also the color of the programmable leds must ne settable via software.

In front of the display on the programmable LEDs must be positioned a little label pocket.

“FAIL” is to be indicated by all the LEDs flashing.

In addition, the display must show the following events:

- k. Fault events
- l. Inversion activated
- m. Voltage presence for the individual phases
- n. RGDM anomaly
- o. Measurements
- p. Display of configuration parameters
- q. Clock with calendar.
- r. SNTP status.

According to the specifications below:

- s. A fault event must be indicated by displaying the relevant ANSI code, along with the date and time of the event.
- t. If the inversion command is active, the display must read `INVERS_ACTIVE`.
- u. If there is an internal anomaly, the red LED must switch on, and the display must read `ANOMALY_RGDM`.
- v. Under normal operating conditions, on the main screen of the display must be displayed: V, I, IP address RJ45, clock with date; by scrolling with the navigation arrows, other screens described below should be available.
- w. Second display screen, with: P and Q, Fiber IP address, SNTP server status;
- x. Third display screen, with: switch status (BLIND and SyncroCheck), ARF, phase sense anomaly, UD presence;
- y. Fourth screen, if the UPG function (ref. par.10.3) is enabled, with: V_{MT} , P_{MT} and Q_{MT} measurements;
- z. Fifth screen, if UPG function is enabled:
 - Generator running (out of order);
 - Activation status of the UPG algorithm (associated with the status of the `UPGon` variable);
 - UPG active locally conditions (associated with the status of the `UPGact` variable);
 - VFLS or VFLI condition present.
- aa. Sixth screen, if the UPG function is enabled (variables communicated to possible `IDC_PROT`):
 - 81P Threshold Settings;
 - PI open / closed status;
 - PG open / closed status.
- bb. Seventh screen (fourth if UPG is not enabled), with: all active trip thresholds.

	GLOBAL STANDARD	Page 48 of 134
	Protection and control device for MV substation – RGDM control unit	GSTP011 Rev. 01 26/07/2019

In addition, the four touch buttons below the display must be able to display the following parameters set in the RGDM:

- | | | |
|--|-------------|--------------------|
| a. Date & Time | [dd/mm/yyyy | hh:mm:ss] |
| b. Activation thresholds and times | [e.g. 51.S3 | hh:mm:ss:mmm] |
| c. Actions stored in the circular memory | | |
| d. IP addresses stored | [e.g. | 192.168.1.52] |
| e. Network port MAC Address | [e.g. MAC | 00-17-42-37-52-CF] |
| f. Fw for the CPU & date | [vers. FW. | 01.00 dd/mm/yyyy] |
| g. CT-VT triad serial numbers | | |
| h. RGDM serial n° | | |

When in stand-by mode, the display's back lighting must be off, and it must switch on when any of the four buttons is pushed, or if a fault appear. In both cases, the display must stay on for a period of 3 minutes.

6.5 Reliability requirements

By according to the terms and definitions from IEC 60050-192, the RGDM useful life (or lifetime), is the time interval, from first use until user requirements are no longer met, due to economics of operation and maintenance, or obsolescence. In this context, "first use" excludes testing activities prior to hand-over of the item to the end-user.

The useful life must exclude the early life failure period (infant mortality period); the Supplier must perform all necessary tasks to eliminate the "child mortality" of the devices before the delivery and these activities must be fully described in the documentation, which must accompany the device. Accordingly, the Supplier must certify that the equipment, when delivered, has commenced its constant failure rate period.

The Supplier must declare the failure rate of the device to ensure that it is consistent with the project specifications (the underlying calculation method will be reported in the documentation) and must not exceed 0,3% per year failure and the 4.5% cumulative failure in the lifetime, when the device is installed and operated the required environmental conditions.

The "constant fault-rate" period means the "lifetime" of the device and must be greater than 15 years, with the exception of batteries, displays and Flash E2PROM, for which "life cycle" must not be less than 10 years.

For the purpose of fault analysis, a possible restoration (reparation or maintenance) doesn't affect the error rate during "lifetime".

A fault is defined as the loss of operation of the device that requires its removal from the substation or the change of the SW on board to eliminate the defect.

For the purpose of the analysis of the device's reliability during its lifetime, the "pertaining faults" exclude improper use or a wrong operation; accordingly, the Supplier must define in detail the usage conditions and the correct operation of the equipment.

The RGDM must be designed for an expected mean operating time between failures (MTBF) longer than 30 years.

The RGDM must be designed for an expected mean time to restoration (MTTR) smaller than 3 h.

	GLOBAL STANDARD	Page 49 of 134
	Protection and control device for MV substation – RGDM control unit	GSTP011 Rev. 01 26/07/2019

7 CONFIGURATION AND COMMUNICATION REQUIREMENTS

In this chapter are specified all the configuration and communication requirements of the RGDM control unit.

7.1 Device software

The RGDM must be equipped with SW that allows it to be connected to a PC for configuring, monitoring, and diagnostics on the equipment. The configuration software included in the supply (with an unlimited number of user's licenses), must be compatible with the actual operating system in Enel when the tender is released..

All the SW supplied must be able to work in a NOT administrator context, and taking Microsoft's guidelines for compatibility for Windows systems into account.

The application package must be silent and unattended, and must only create working folders that can be accessed without administrator's rights. The application package must provide standard installation methodology (rather Windows Installer, Install Shields etc).

It must be possible to use the SW for viewing and saving all the measurements taken by the RGDM, in both modulus and phase, with the relevant time (hh:mm:ss.000) and date (dd:mm:yyyy). It must be possible to export the measurements in .xls and .txt format.

The device software architecture must provide separation between machine database and 61850 database, in order to manage separately the two sections.

The software must be able to manage dual-mode configuration of the RGDM - one extended, if the device is used in the RGDM version, whereas it must be possible to activate an SW template for setting and configuring the device as RGDAT. A further template must be available for the programming modes for the UPG function (ref. par.10.3) and for the ARF functions, etc.

The SW must include the graphic interface templates, from which it must be possible to program and enable the RGDM's various functions.

The unit's firmware must be equipped on a not-volatile memory that can be updated in the field.

It must be possible to execute at least the following operations for the UPG functions (ref. par.10.3):

- a. Parameter management.
- b. Displaying UPG date and time
- c. Displaying digital statuses
- d. Displaying measurements
- e. UPG diagnostics

It must be possible to view:

- f. The version of the firmware currently installed.
- g. The instantaneous data for the $V_{MT} - P - Q$ measurements, updated at a frequency of 1 second.
- h. The values saved for the $V_{MT} - P - Q$ measurements, recorded at 1 minute intervals, and contained in the panel's memory buffer.
- i. The current status of all the signals managed by the UPG.

7.1.1 Configuration functionality

All the parameters referred to in the specifications below, must be able to be edited via the web server interface. The default configuration of the parameters is to be according to the default values indicated in these specifications.

	GLOBAL STANDARD	Page 50 of 134
	Protection and control device for MV substation – RGDM control unit	GSTP011 Rev. 01 26/07/2019

The parameters included in the IEC 61850 model are also to be viewable and editable, as specified in the GSTP013.

The supplier is to provide a configuration file that is suitable for storing and for loading configuration information again. This includes both information editable via the web interface, and that editable via the 61850 protocol. It must be possible to use this option for both downloading and uploading a configuration when the equipment is replaced, or for uploading a new configuration. It must be possible to send the file from a remote location.

7.1.1.1 Remote configurability via 61850

The RGDM device must allow remote configuration of its configuration parameters, via the relevant IEC 61850 protocol functions. The parameters configurable remotely via 61850 are listed in the GSTP013.

The IED must be able to receive the CID configuration files by 61850 file transfer and via SFTP. The CID file must be activated by a 61850 command, and by a command from the configuration software.

The CID file must be managed by the IED and, once implemented, it must configure the communication part of the IED. The CID file must also be able to configure any parameters related to the protection functions, but this functionality must be subject to an enabling flag, which must be present on the web page and in the configuration software.

It must be possible to take the CID file from the device, via configuration software, via 61850 transfer files and by SFTP.

The name of the file will be defined by the ENEL operator, and must be kept the same when withdrawing the file itself. The CID file has no default name, and must be accepted by the receiving IED.

If taking on the CID file involves rebooting the equipment, this rebooting must ensure that the protection functions are available within 30 sec, and the communication server is available within 1 minute.

The performance of the protection functions, emitting / subscribing of GOOSE, and issuing of reports, must not be affected by the maximum number of subscribed BLIND GOOSE protocols.

The IED must ensure that, after a client has been disconnected (or physically switched off), the reports enabled by the same client are issued. This implies introducing a keep alive mechanism towards the client, implemented by the IED.

Normally, the rebooting time for a client can be estimated to be 20 sec.; therefore, the IED must recognize disconnection of a client within a time at least shorter than 15 sec, in order to present the reports in a not-reserved state, when the client is connected again.

7.1.1.2 Configuration via software

The configuration software must:

- a. Allow the procedure to be launched for entering parameters for the CT-VT sensor. If the calibration procedure fails, the program must provide an indication of the type of error encountered.
- b. Allow setting of the thresholds, times, and activation sectors for all the protection functions.
- c. Guarantee the integrity of the data to and from the calibration program, by checking coherence of the data.
- d. Allow setting towards the RTU to which it is interfaced that may be an UP/Primary RTU. If the RGDM is set for connection to a UP, the SW must be able to mask all the functions / parameters not necessary for the UP to function.
- e. Allow setting and enabling of the UPG function (ref. par. 10.3).
- f. Allow setting of the ARF parameters (this function is enabled electro-mechanically, via a selector on the electronics board).
- g. Allow the CID files made available by the TMF 2020 configuration device to be loaded.
- h. Allow management and creation of GOOSE Control Blocks and Report Control Blocks.

	GLOBAL STANDARD	Page 51 of 134
	Protection and control device for MV substation – RGDM control unit	GSTP011 Rev. 01 26/07/2019

- i. Allow CID files and other IEDs to be loaded, in order to configure subscriptions between GOOSE protocols. The subscription technique to be adopted is described in the “GOOSE Subscription Technique” document.

7.1.2 Monitoring and diagnostic functionality

The configuration software must allow:

- a. The reference phase for calculating all the other phases is established, by convention, on voltage V4.
- b. Monitoring of the phase current.
- c. Monitoring of residual voltage and residual current (in modulus and related phase delay).
- d. Launching of a diagnostic test for the equipment.
- e. Simulation of the action of each of the signals provided by the equipment to the Remote Control Peripheral Unit.
- f. Viewing of the recorded events buffer (min 128).
- g. The possibility, by means of a SW setting, to save not only the triggers but also the start-ups in a circular buffer.

7.1.3 Revision functionality

The device must allow its own firmware to be updated in the field, via the Ethernet port, with the possibility of this update being done from a remote location, if necessary, via SFTP and SCP and using the IED WebServer.

If even only one of the three sensors is changed in the field (this possibility is required in any case), a function must be provided for resetting the characteristic parameters of the CT-VT sensor, and resetting all the functions. Such an action must be carried out and started by the configuration SW, by means of a specific routine, to be implemented in the SW itself.

7.2 Communication Ports

7.2.1 Ethernet ports

Two Ethernet ports must be provided in copper (RJ45 console port), and another optic type 100base-FX with LC connector. The Ethernet interfaces must support the TCP/IP-UDP protocol. It must be possible to set and edit the IP address, the Subnet Mask, the board's default gateway, as well as all the parameters in general, in order to configure the latter in a LAN (ref. 7.2.1.1). Both ports must be able to have the same services, including IP (static/dynamic) flexibility, and to support IEC 61850 services. Setting of the static 61850 IP may be assigned to only one of the two ports.

Via the Ethernet port, all the measurements taken by the RGDM must be accessible, as well as all the trigger signals (including those put in common on the MB terminal board, such as 67.S4 trigger, for example), and the fault signals.

The RGDM must implement a network architecture, and so it must be possible to manage communication of data in both GOOSE and client/server mode.

It must also be possible to programme the device, via the Ethernet port.

The Ethernet port must support the IEC 61850 standard, with the signals indicated in GSTP013.

The RGDM must have Web-Server functionality, so that remote interrogation and re-programming of the device is possible.

	GLOBAL STANDARD	Page 52 of 134
	Protection and control device for MV substation – RGDM control unit	GSTP011 Rev. 01 26/07/2019

7.2.1.1 Configuration of communication addresses

The RGDM must support both Internet Protocol IPV4 and IPV6 versions, in native mode, and all application messages are to use the IEC 61850 protocol.

The RGDM must have:

- a. A static address (192.168.1.1) not associated with any gateway (for local connection)

Therefore, before it is activated, the operator (local configurer) must configure the following fields:

- b. Static address
- c. Netmask
- d. Default gateway.

The following services must be available:

- e. WEB server
- f. SNTP client
- g. SSH server

File transfer procedures are to be managed using the related functions provided by the IEC 61850 protocol. These references are to be configured manually, or they will be provided by a configuration server, at the time of activating the RGDM, and subsequently, following changes to the consistency of the network, line set-ups, etc.

The algorithm for determining these addresses, is to be located in the Server, which will be the only one from which the RGDM can receive configuration data. Therefore, its address is also to be configured by the operator before starting up the RGDM (configuration server address).

The configuration server must be able to configure the list of IEDs subscribed within each RGDM, made up of a maximum of 100 IED elements.

The RGDM must therefore be able to store:

- h. 1 remote server (Primary RTU) address
- i. 1 static IP address 192.168.1.1
- j. 1 default gateway IP address
- k. 1 Netmask IP address
- l. 100 GOOSE to configure the list of IEDs subscribed

7.2.2 Auxiliary communication ports

The RGDM must be equipped with two auxiliary serial ports, RS232 to interface local PC and remote systems.

The RS232 port must have a standard DB9 connector, arranged at the bottom. Through this local port, or with a different solution approved by ENEL, it must be possible to recover the device boot. RS232 port shall be insulated from 24Vdc.

7.2.3 Synchronization and precision of times

The RGDM must be able to receive configuration packages on IEC 61850, called CID. The average size of a CID package is 1 MB. The memory buffer dedicated to this data must therefore be suitably oversized.

The time measurement for both protection functions and more general purposes such as DG management, for example, must all refer to the same time reference.

	GLOBAL STANDARD	Page 53 of 134
	Protection and control device for MV substation – RGDM control unit	GSTP011 Rev. 01 26/07/2019

This must be calculated starting from a quartz oscillator, with the following characteristics:

- | | |
|--------------------------|----------------|
| a. Frequency stability: | 10 ppm |
| b. Frequency Aging | 5 ppm/year |
| c. Operating temperature | -25°C to +70°C |

Synchronization of the clock and calendar must be done by means of a specific message sent periodically by the center (Primary RTU server). The synchronization protocol for the various devices is NTP.

When the equipment is started again, the clock and calendar must show updated values for at least 24 hours after being switched off. Accumulation subsystem must be used for this purpose. When the power supply is restored, if the interruption has exceeded the autonomy time provided for, the clock and calendar can present two conditions:

- d. Resetting with events already recorded in the logger.
- e. Resetting with no event recorded in the logger.

In the former case, the clock and calendar must be reset according to the most recent chronological reference, stored in the logger. In the second, case, however, the values must be started as follows:

- f. Time 00:00:00,000
- g. Date 01/01/2016.

	GLOBAL STANDARD	Page 54 of 134
	Protection and control device for MV substation – RGDM control unit	GSTP011 Rev. 01 26/07/2019

8 SELF-DIAGNOSIS AND CONTROL LOGICS

At start-up and cyclically, the RGDM device must carry out a watchdog activity, in order to allow the detection CPU to detect an infinite program loop or a deadlock situation.

The red LED switching on and a suitable message must indicate any error condition, following detection of a fault by the CPU. If location allows detailed information, this must be displayed clearly or using a suitable code. The same information must be made available on the PC.

When there is a fault on the panel, the self-diagnosis system must ensure that untimely commands and misleading signals are not emitted, to the greatest degree possible.

The fault status of the RGDM or one of its accessory functions, must result in a signal being emitted to the center. In addition, the three sensors must be checked to ensure they are working properly, and the correctness of the power supply must be checked.

Any anomaly found must result in:

- a. All the outputs being opened, including that related to the Power On signal (TS PRES V) which, in such a case, is forced to an OFF status.
- b. Local indication of the fault by the relevant flashing red LED switching on, and showing the cause of the anomaly on the display.
- c. If the anomaly relates to one or more sensors, which sensor is out of order must be shown on the display and via the interface software.

All anomaly states on the device, both partial and total, must be saved on a specific Log text file, not on a volatile memory, and must allow detailed analysis of the causes of software and hardware anomalies.

It must be possible to download the file both using the configuration software, and by means of emergency procedures if irreversible blocks occur on the machine. The LOG information must be able to be sent (ref. SysLog RFC3164, RFC3195).

	GLOBAL STANDARD	Page 55 of 134
	Protection and control device for MV substation – RGDM control unit	GSTP011 Rev. 01 26/07/2019

9 FUNCTIONAL REQUIREMENTS

The RGDM is an evolved instrument, designed to protect, automate, monitor, and measure of network quantities and distributed generation (DG) management by according to GSTP012 (ref. to par. 10.2).

It must be able to measure:

- a. Line currents and the residual (calculated) current by means of three analogue input channels, one for each line current.
- b. Line voltages and the residual (calculated) voltage by means of three analogue input channels, one for each phase voltage.

By means of the measurements indicated above, the RGDM must detect the following events:

c. Protection functions:

- c.1 Four, independent time or inverse time settable as NIT, VIT, EITLIT, SIT directional phase overcurrent **67.S1/S2/S3/S4** thresholds.
- c.2 Four, independent time or inverse time settable as NIT, VIT, EIT LIT, SIT phase overcurrent **51.S1/S2/S3/S4** thresholds. These thresholds must be selectable exclusively with 67 thresholds.
- c.3 Three, independent time or inverse time settable as NIT, VIT, EIT LIT, SIT directional earth overcurrent **67N.S1/S2/S3** thresholds.
- c.4 Three, independent time or inverse time settable as NIT, VIT, EIT, or LIT, earth overcurrent thresholds **51N.S1/S2/S3**.
- c.5 Maximum active power directional threshold **32P**.
- c.6 Second harmonic return, for inrush currents **2ndH REST**.
- c.7 Two threshold of 59N
- c.8 One threshold of 59V2
- c.9 Directional intermittent earth arc detection **67N.S4**
- c.10 Frequency protection
- c.11 Discrimination between voltage present/absent (27)

All the protection functions, excluding 32P and 47, must have the “Breaker Failure” control, for monitoring the circuit breaker opening / closing times. The control timer TBF must be set from 60ms to 10s, in steps of 10ms. Exceeding the time required for the command must produce a logic status of “Breaker Failure”, recorded in the event log and sent to IEC61850.

All the maximum current thresholds (51/51N and 67/67N) must have the “Cold Load Pickup” function, by means of a TCLP timer that allows delaying the intervention from non-energized lines. The control timer TCLP must be set from 0ms to 100s, in steps of 10ms (until 10s) and 100ms (10s to 100s).

d. Automation function:

- d.1 Quick re-closing cycle for the switch; selectable for all thresholds protection.
- d.2 Logic selectivity of the faulty section.
- d.3 Sending / receiving signals and commands, via evolved IP type networks, in accordance with the IEC 61850 standard.

e. Quality and measurement monitoring functions:

- e.1 Measurement of electrical V, I, P, Q and $\cos\phi$ quantities.
- e.2 Monitoring of currents and voltages (harmonics in the node).

f. DG management functions (if requested ref. to par. 10.2):

	GLOBAL STANDARD	Page 56 of 134
	Protection and control device for MV substation – RGDM control unit	GSTP011 Rev. 01 26/07/2019

- f.1 Regulation of the voltage profile along the line, by means of static converter control.
- f.2 PI control and remote disconnection of DG.
- f.3 Prevention of PG tripping for DG logic selectivity.

9.1 Definitions

Start-up time is the time lapse between detection of the fault conditions, and when the start-up completed command is sent, if required.

Activation time is the time (including the start-up time) lapse between detection of the fault conditions, and when the protective device commands opening of the OdM.

Delay time, when set, is the time, including the activation time that the protective device waits before sending the command to open the OdM; used to create chronometric selectivity between the various protective devices in the network.

Return ratio: The relay acts when the quantity in action reaches and exceeds the preset calibration value, and returns to stand-by when the quantity acting reaches a value, referred to as the return, which depends on the relay's construction characteristics. The ratio between the return value and the activation value, is said to be the relay's return ratio.

Return time: The time elapsed between the acting quantity reaching the return value, and when the relay is released.

Start time: The time interval between the moment the input quantity (ies) is/are applied, removed, or changed under specified conditions, and the moment the start output circuit changes status.

Base tripping time: The minimum time the protective device takes to detect the fault and emit the command, without any intentional delay.

Tripping time: The time interval between the moment the input quantity (ies) is/are applied, removed, or changed under specified activation conditions, and the moment the Trip output circuit changes status.

Effective value: In this document and for the RGDM device, the effective value of a quantity must be taken to be the component's actual value at the basic frequency before the fault, calculated with a mobile window of corresponding amplitude.

Residual voltage: Value of the vectorial sum of the phase voltages.

Residual current: Value of the vectorial sum of the phase currents.

9.2 Measurement and Monitoring Functions

9.2.1 Measuring methods

Some definitions and measuring methods are listed below. All the measurements used for the protection functions must be processed using a high-pass filter that removes its continuous component.

a. Phase current measurement

This function must provide the effective value for the phase currents. For all thresholds, this measurement is based on calculating the basic harmonic component, at 50/60 Hz, excepting for when second harmonic retention is enabled for inrush currents.

In this case, the calculation must take the basic and all the higher harmonics into consideration, up to the 25th.

Measurement of the harmonic components of current must take the real network frequency into account, with automatic adaptation within the useful basic interval, that is 50/60 Hz $\pm 5\%$.

	GLOBAL STANDARD	Page 57 of 134
	Protection and control device for MV substation – RGDM control unit	GSTP011 Rev. 01 26/07/2019

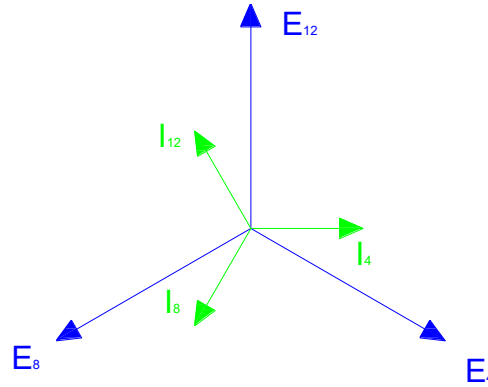

Figure 25 – Phase Current

b. Residual current measurement

This function must provide the actual value for the residual current, which is obtained from the vectorial sum of the three phase currents (Holmgreen insertion). This sum must take suitable calibration coefficients into account, in module and phase, added by means of software, to compensate for the CT-VT sensors.

$$3\vec{I}_0 = \vec{I}_4 + \vec{I}_8 + \vec{I}_{12}$$

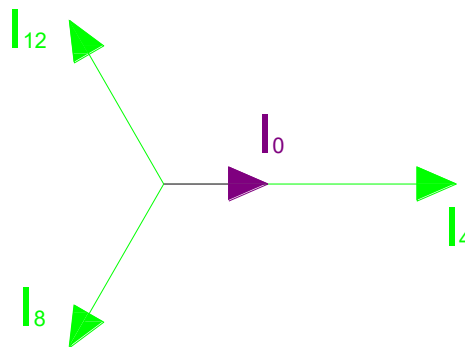



Figure 26 – Residual Current

This is based on the basic harmonic component measurement.

c. Phase voltage measurement

This function must provide the actual basic value at 50/60 Hz of the three phase voltages. E₁₂ voltage on phase 12, E₄ voltage on phase 4 and E₈ voltage on phase 8.

Measurement must take the real network frequency into account, with automatic adaptation within the useful basic interval, that is 50/60 Hz ±5%.

	GLOBAL STANDARD	Page 58 of 134
	Protection and control device for MV substation – RGDM control unit	GSTP011 Rev. 01 26/07/2019

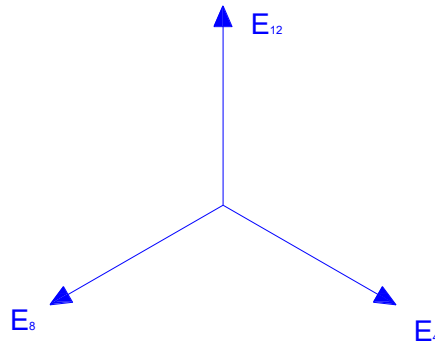

Figure 27 – Phase Voltages

d. Phase-to-phase voltage measurement

This function must provide the actual basic value at 50/60 Hz of the three phase-to-phase voltages. V_{12-4} voltage between phases 12 and 4; V_{8-12} voltage between phases 8 and 4; V_{4-8} voltage between phases 4 and 8.

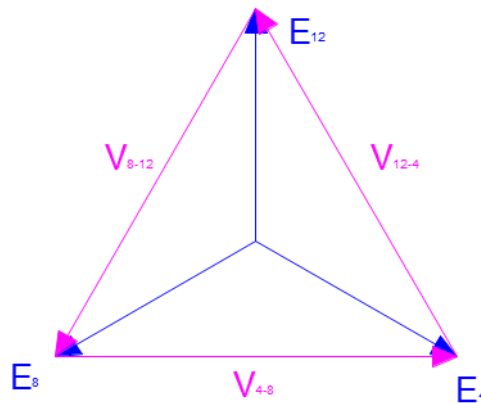



Figure 28 – Phase to Phase voltages

e. Residual voltage measurement

This function must provide the actual value for the residual voltage, which is obtained from the vector sum of the three line voltages.

This sum must take suitable calibration coefficients into account, in module and phase, added by means of software, to compensate for the CT-VT sensors.

	GLOBAL STANDARD	Page 59 of 134
	Protection and control device for MV substation – RGDM control unit	GSTP011 Rev. 01 26/07/2019

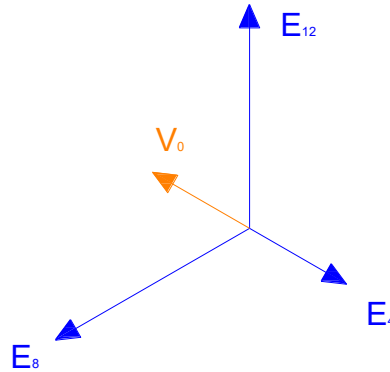

Figure 29 – Residual Voltage

This is based on the basic harmonic component measurement.

9.2.2 Measurement functions

The measurements handled by the RGDM can be acquired using 2 different methods:

- a. By means of messages coming from the IDC_DER, and sent using the 61850 (goose) protocol.
- b. By means of the RGDM equipment's own measuring inputs.

At intervals equal to T_m (typically 10 sec), the IDC_DER will send to the RGDM a package of data (goose), containing the “instantaneous” plant measurements, the structure of which is defined in the IDC_DER specifications and, in any case, are described in the *-icd file associated with the IDC_DER device. These instantaneous measurements must be processed to be sent to the Primary RTU as MMS spontaneous reporting messages (refer to the file *-icd related to the RGDM).

In addition, the measurements acquired in transit, must be averaged over 10 min, to be sent to Primary RTU as MMS spontaneous report messages (averaged measurements).

NB: The icd profile distinguishes the instantaneous from the averaged measurements.

The samples in transit must be discarded if not qualified in the goose messages (see quality and availability bits), and begin again automatically, when normal operation conditions are reinstated. The measurements averaged over 10 minutes and also saved in a dedicated circular type log file (capacity: at least two days), which can be consulted locally.

The device must detect the VRMS value of the real voltages and currents for each phase.

The measurements always refer to the basic, at 50/60 Hz, with related frequency adaptation within limits of $\pm 5\%$. If 2nd harmonic retention for inrush currents is enabled, on the other hand, the measurements for the three phase currents must take all the harmonics up to 25° into account.

These measurements must be used to detect the active and reactive power transiting the section in which the RGDM is installed.

The active power P and reactive power Q must be calculated as:

$$P = E_4 \cdot I_4 \cdot \cos \varphi_{E_4 I_4} + E_8 \cdot I_8 \cdot \cos \varphi_{E_8 I_8} + E_{12} \cdot I_{12} \cdot \cos \varphi_{E_{12} I_{12}}$$

$$Q = E_4 \cdot I_4 \cdot \sin \varphi_{E_4 I_4} + E_8 \cdot I_8 \cdot \sin \varphi_{E_8 I_8} + E_{12} \cdot I_{12} \cdot \sin \varphi_{E_{12} I_{12}}$$

The measurements of E_4 , E_8 , E_{12} , I_4 , I_8 , I_{12} , P, Q related to the primary values (kV, A, kW, kVAr) must be able to be viewed on the display. For the vectorial references ref. to Figure 29.

	GLOBAL STANDARD	Page 60 of 134
	Protection and control device for MV substation – RGDM control unit	GSTP011 Rev. 01 26/07/2019

When the RGDM is in basic configuration (connected to UP), it must be possible to use the relevant analogue output set aside for measurement on the MB terminal board, in order to be able to send the UO one of the following measurements: P, Q, V, I.

For the P and Q measurements, the sign must also be sent, according to the convention described below, and using the following principle:

Since the output on terminals 4 and 7 of the MB are of a 4-20 mA type, then RGDM must be set using a PC to transmit one of the measurements listed above, using the convention below:

For the P and Q measurements, 4-12 mA for negative values and 12-20 mA for positive values, taking 12 mA as the null value and 4mA as the negative scale range and 20mA as the positive scale range.

For the I and V measurements, the output must set 4 - 20 mA for the entire measurement range.

The measurements acquired directly by RGDM must be calculated in terms of their actual value, with sampling at 200 ms. The samples must be discarded if a fault occurs, and restart automatically when the normal operating conditions are reinstated.

The measurements sampled at 200 ms must be averages on a time basis T_m , typically 10 sec, and processed to be sent to the Primary RTU as MMS spontaneous reporting messages (see file *.icd related to the RGDM). The same measurements sampled at 200 ms must be averaged on a first time base of 60 sec, and averaged again at 10 minutes, to be sent to the Primary RTU as spontaneous reporting messages (averaged measurements).

NB: The icd profile distinguishes the instantaneous from the averaged measurements.

The measurements averaged over 10 minutes and also saved in a dedicated circular type log file (capacity: at least two days), which can be consulted locally

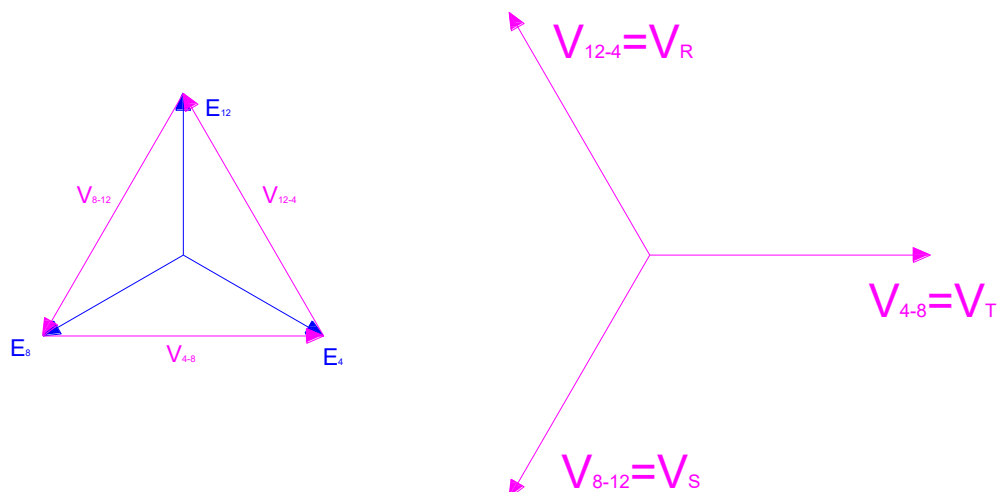



Figure 30 – Correlation of phase and phase-to-phase voltages

Measurement of the active and reactive power must be done with the possibility of estimating the direction of the power, according to the following convention: (with inversion mode deactivated)

- Positive when passing from the sub-station to the user.
- Negative when passing from the user to the sub-station.

The units of measurement that have to be handled and used to display the quantities are:

- Voltage kV
- Current A

	GLOBAL STANDARD	Page 61 of 134
	Protection and control device for MV substation – RGDM control unit	GSTP011 Rev. 01 26/07/2019

- e. Active power kW
- f. Reactive power kVAr

The maximum scale range for the various quantities is:

- g. Voltage 36 kV
- h. Current 500 A
- i. Active power 15000 kW
- j. Reactive power 15000 kVAr

The configuration program must make it possible to set lower scale range values, with the following steps:

- k. Voltage 1 kV
- l. Active power 150 kW
- m. Reactive power 150 kVAr

Note: In addition to sending the measurements to Primary RTU, using the IEC 61850 protocol, RGDM must send the IDC_DER the three measurements V, P and Q at intervals that can be set of between 200ms and 60s with a default of 10s.

9.2.3 Quality Monitoring Function

At the measuring point, the device must determine the harmonic content (up to the 25th harmonic) for both the line voltage and the current. In order to guarantee only the band pass harmonic content, the voltage and current measurements will be those obtained downstream of the anti-aliasing filter provided at the input.

For each of the line's three voltages and the three line currents, the THD must be calculated according to the following formulas respectively:

$$THD_V = \frac{\sqrt{\sum_{i=2}^{25} (V)_i^2}}{V_1} \qquad THD_I = \frac{\sqrt{\sum_{i=2}^{25} (I)_i^2}}{I_1}$$

The two THD measurements must be processed for sending to the Primary RTU, like for the other measurements acquired locally by the RGDM (calculation every 200ms, first average at 60 sec and second average at 10 minutes, to be sent as part of the spontaneous reporting, and saved in a log file).

9.3 Electrical protection functions (FdP)

The remote calibration mechanism for protection setting parameters must be intrinsically safe, which means that editing of parameters must be done in blocks, by means of a swap commanded by the Primary RTU, according to the IEC 61850 standard. All the protection functions (FdP) must be activated or deactivated.

The architecture of the RGDM shall allow a decoupling between the Protection Functions DataBase and the IEC61850 DataBase. This is to guarantee an easy modification of the two part independently.

9.3.1 Logic structure for an FdP function

In Figure 31 the logic diagram for an FdP (Protection Function) is shown. For functions not used in the FSL the back-up timer and the FSL enable logic mustn't be considered.

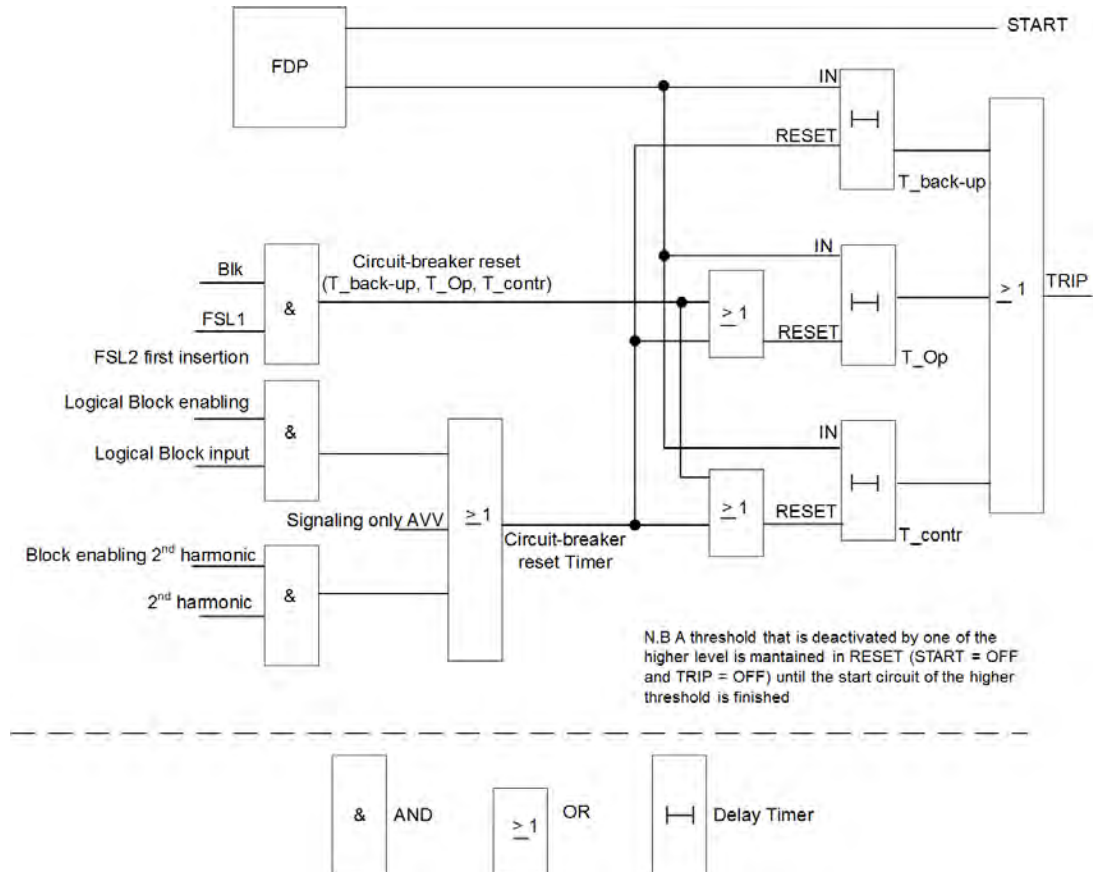

Figure 31 – Logic Diagram for an FdP

In the figure above:

- a. T_{back-up} is the “free time”
- b. T_{contr} is the contract time
- c. T_{Op} is the normal time between start and trip commands

9.3.2 Inverse time overcurrent protection function

All the phase/earth overcurrent protection functions must be inverse time or independent time. The inverse time threshold refer to IEC 60255 and must be settable between one of the following types of curves:

- a. **NIT** (Normal Inverse Time)
- b. **VIT** (Very Inverse Time)
- c. **EIT** (Extremely Inverse Time)
- d. **LTI** (Long Inverse Time)
- e. **STI** (Short Time Inverse)

Table 25 – Inverse time curve parameters		
	Operating time	Reset time
NIT (Normal Inverse)	$t = \frac{0,14}{(I/I_p)^{0,02} - 1} \cdot T_p$	$t = \frac{13,5}{1 - (I/I_p)^2} \cdot T_p$

VIT (Very Inverse)	$t = \frac{13.5}{(I/I_p)-1} \cdot T_p$	$t = \frac{47,3}{1 - (I/I_p)^2} \cdot T_p$
EIT (Extremely Inverse)	$t = \frac{80}{(I/I_p)^2 - 1} \cdot T_p$	$t = \frac{80}{1 - (I/I_p)^2} \cdot T_p$
LTI (Long Time Inverse)	$t = \frac{120}{(I/I_p)-1} \cdot T_p$	$t = \frac{120}{1 - (I/I_p)} \cdot T_p$
STI (Short Time Inverse)	$t = \frac{0,05}{(I/I_p)^{0,04} - 1} \cdot T_p$	$t = \frac{4.85}{1 - (I/I_p)^2} \cdot T_p$
t = activation time (or reset time); I = fault current; I _p = current set (default 20 A in 5 A steps) T _p = time multiplier (default 0,12 s)		

Inverse Time curves shall also be defined as a **custom curves defined by the user**, by the entry of at least 32 points (composed by relation - Multiple I_{cc}/I_{pickup} versus Time) according to figure Figure 32 below, due to many situations of feeder topologies:

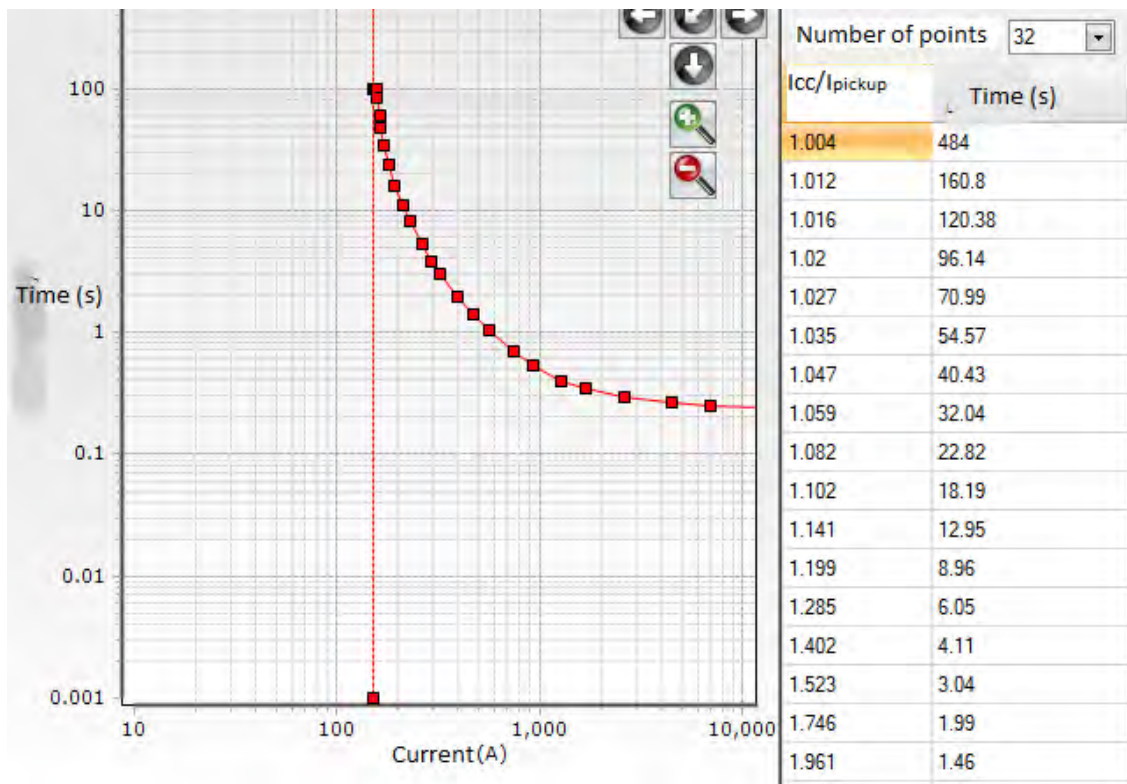



Figure 32 – Example of user defined curve configuration interface

	GLOBAL STANDARD	Page 64 of 134
	Protection and control device for MV substation – RGDM control unit	GSTP011 Rev. 01 26/07/2019

9.3.3 Directional overcurrent protection function IEEE 67 and overcurrent protection function IEEE 51

The device must detect overcurrents that exceed the threshold set, also due to closing proceedings due to a fault, as well as starting from a zero current and voltage condition at the point at which the RGDM is installed.

It must be possible to set the thresholds to directional or not directional and enabled/disabled.

Phase directionality implies an angular reference between currents and voltages, as indicated:

- a. **I4** in relation to **V8-12** (+90° in balanced conditions)
- b. **I8** in relation to **V12-4** (+90° in balanced conditions)
- c. **I12** in relation to **V4-8** (+90° in balanced conditions)

9.3.3.1 Setting parameters

The default value of the thresholds must be OFF and not directional. Below are listed the tables that synthesized the calibration parameters of the phase overcurrent protection functions.

All the calibration tables are drawn up taking $I_n = 500\text{ A}$ into account.

Table 26 – Inverse time settings			
		Range	Step
- I_p	0,04 I_n	0,02 ÷ 3 I_n	0,001 I_n
- T_p	0,12 s	0,02 ÷ 60 s	0,01 s

Table 27 – Angular sector settings			
		Range	Step
Bisector		0° - 360°	1°
Semi-amplitude		0 – 180°	1°

Table 28 – Base time		
	Start-up	Activation
Threshold 51/67.Sx	20 ms ± 3%	40 ms ± 3%

Table 29 – Independent time settings				
	I default	T default	Range	Step
Threshold 51/67.S1	0,04 I_n	0,12 s	0,02 - 3 I_n	0,02 I_n
Threshold 51/67.S2	0,72 I_n	1 s	0,02 - 3 I_n	0,02 I_n
Threshold 51/67.S3	2,8 I_n	0,25 s	0,02 - 3 I_n	0,02 I_n
Threshold 51/67.S4	1 I_n	0,05 s	0,02 - 3 I_n	0,02 I_n

Table 30 – Delay times settings			
		Range	Step
T_delay_67.Sx		0,05 – 200 s	0,01 s

The delay times must include the basic activation time. It must be possible to contract the intervention time of the 4 phase overcurrent thresholds, with a double calibration table 51 / 67 and 51_c / 67_c.

9.3.3.2 Accuracy of the measurements

Table 31 – Error settings	
Amperometric error	≤ 3% in the range 1 – 5A

	GLOBAL STANDARD	Page 65 of 134
	Protection and control device for MV substation – RGDM control unit	GSTP011 Rev. 01 26/07/2019

	$\leq 1\%$ in the range 5 - 50A. $\leq 0,2\%$ in the range 50 – 550 A $\leq 3\%$ 550 – 8800 A
Error limit variation	$\leq 3\%$

Table 32 – Time errors	
Error limit	$\leq 3\%$
Error limit variation	$\leq 1,5\%$
Return time	$\leq 100\text{msec}$
Return ratio	$\geq 0,90$ and $\leq 0,95$

9.3.4 Residual overcurrent protection function IE 51N

These thresholds can be inverse-time or independent-time. They must be enabled or disabled. They must be not directional and with the following setting parameters:

9.3.4.1 Setting parameters

Table 33 – Inverse time settings			
	Default 51N.S1	Range	Step
- I_p	0,04 In	0,02 ÷ 3 In	0,001 In
- T_p	0,12 s	0,02 ÷ 60 s	0,01 s

Table 34 – Base time		
	Start-up	Activation
Threshold 51N.Sx	20 ms \pm 3%	40 ms \pm 3%

Table 35 – Independent time settings			
	I_{trip}	Range	Step
Threshold 51N.S1	0,3 In	0,01 - 2 In	0,02 In
Threshold 51N.S2	1 In	0,01 - 2 In	0,02 In
Threshold 51N.S3	1 In	0,01 - 2 In	0,02 In

Table 36 – Delay times settings			
	Default	Range	Step
T delay 51N.S1	0,15 s	0,05 - 60 s	0,01 s
T delay 51N.S2	0,15 s	0,05 - 60 s	0,01 s
T delay 51N.S3	0,15 s	0,05 - 60 s	0,01 s

NOTE: The delay times must include the basic activation time.

9.3.4.2 Accuracy of the measurements

Table 37 – Error settings	
Amperometric error	$\leq 0,2\%$ in the range 50 - 550 A. Over 550 A and up to 9 kA only tripping at the required activation time must be ensured, without a precision measurement.
Error limit variation	$\leq 3\%$

Table 38 – Time errors	
Error limit	$\leq 3\%$
Error limit variation	$\leq 1,5\%$

	GLOBAL STANDARD	Page 66 of 134
	Protection and control device for MV substation – RGDM control unit	GSTP011 Rev. 01 26/07/2019

Return time	$\leq 100\text{msec}$
Return ratio	$\geq 0,90$ and $\leq 0,95$

9.3.5 Directional earth overcurrent protection function IEEE 67N

The device must detect earth faults downstream of where it is installed for networks with the following grounding systems:

- a. insulated neutral;
- b. neutral grounded through an inductor with in parallel a resistor;
- c. neutral grounded through a resistor;
- d. neutral directly grounded
- e. neutral grounded using zig-zag transformer

In the case of pure grounding reactance, detection of single-phase faults occurs after intentional closing of a parallel resistor.

The activation and deactivation of the protection functions must be independently of the kind of the grounding system. The device must detect earth faults without requiring changes to the provisions from switching from one type of network to the other.

Directional earth protection must include three activation thresholds, 67N.S1, 67N.S2 and 67N.S3 (default, included) aimed at selecting single and dual-phase faults to earth: one for operating with a network with neutral to earth with impedance, the second with an isolated neutral, and the third for detecting double single-phase faults to earth. Faults to earth in networks with a simple earthing resistance, can be selected from both thresholds, depending on the resistance current value resulting from the resistance itself.

Each 67N threshold must be:

- f. Able to be set and deactivated individually, that is, when deactivated it must not produce the external trip command, but must work together for internal logics.
- g. Able to be set to independent time or dependent time (NIT, VIT, EIT curves).

When set to dependent time, the thresholds must conform to the logics indicated in IEC 60255 and already explained for the 67.S1 threshold. If inverse time operation is selected for the 67Ns, the default settings are listed in Table 39.

	Default setting 67N S1	Default setting 67N S2	Default setting 67N S3	Range	Step	
Operation	Directional	Directional	Directional	Enabled/Disabled Directional No-directional	--	
Type of curve	Normal /Inverse	Normal /Inverse	Normal /Inverse	NI, VI, EI	--	
I_p	3	Very Inverse	Time independent	1 – 500 A (Primary values)	0,5 A	
T_p	0,87	30	150	0,02 s ÷ 1 s	0,01 s	
V_0	6 % En	0,08 En	0,01 En	1 ÷ 100% En	0,5 % En	
Intervention sector	60° - 250°	6 % Vn	6 % Vn	0° ÷ 360°	1°	Settable with bisector and semi-amplitude

The output command must continue for as long as the fault conditions continue, with a minimum duration of 150 msec.

9.3.5.1 Setting parameters

Table 40 – Base times for independent time 67N		
	Start-up	Activation
Threshold 67N.S1	20ms ±3%	150ms ±3%
Threshold 67N.S2	20ms ±3%	150ms ±3%
Threshold 67N.S3	20ms ±3%	70ms ±3%

Table 41 – Independent time 67N activation levels setting				
	$3I_0$	$3V_0$	Activation sector	Notes
Threshold 67N.S1	1-20A (primary values) Default: 2A in steps of 0,5A	1-100%En Default 6%En in steps of 0,5%En	Default: 60° - 250° Settable from 0° - 360° in steps of 1°	The sector must be defined in dual sector and semi-amplitude
Threshold 67N.S2	1-20A (primary values) Default: 2A in steps of 0,5A	1-100%En Default 2%En in steps of 0,5%En	Default: 60° - 120° Settable from 0° - 360° in steps of 1°	The sector must be defined in dual sector and semi-amplitude
Threshold 67N.S3	1-600A (primary values) Default: 150A in steps of 0,5A	1-100%En Default 6%En in steps of 0,5%En	Default: 190° - 10° Settable from 0° - 360° in steps of 1°	The sector must be defined in dual sector and semi-amplitude

Figure 33 explains the activation sectors for the 67N, depending on whether or not the inversion logic input is present.

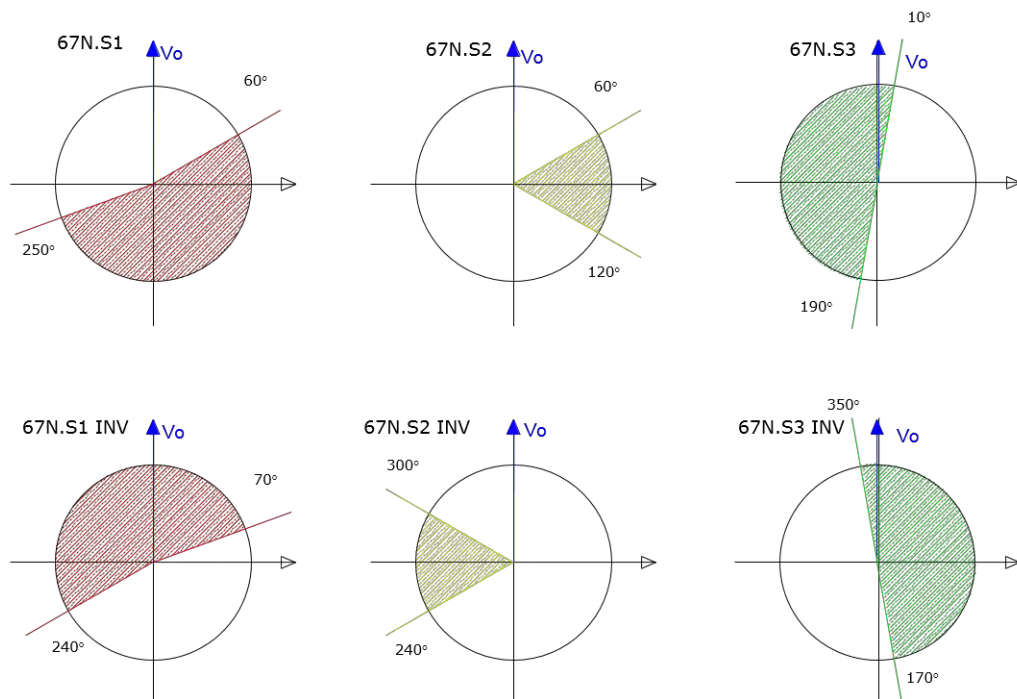

Figure 33 – Activation sectors for the directional fault to earth function

The activation sectors must be taken with I_0 as a reference in relation to V_0 , or V_0 in advance in relation to I_0 .

The effect of inversion must be that the activation sector is rotated through an angle of 180° (Figure 15).

Table 42 – Threshold 67N delay times setting			
	Default	Range	Step
T_del_67N.S1	1s	0,05 - 60s	0,05s in (0,05 -10) s 0,5s in (10-30) s
T_del_67N.S2	0,3s	0,05 - 60s	0,05s in (0,05 -10) s 0,5s in (10-30) s
T_del_67N.S3	0,1s	0,05 - 60s	0,05s in (0,05 -10) s 0,5s in (10-30) s

9.3.5.2 Accuracy of the measurements

Table 43 – Error settings	
Total error	amperometric $\leq 2\%$ voltmetric $\leq 2\%$
Error limit variation	$\leq 3\%$
Angle error	$0,5^\circ$
Sector exit hysteresis	3°

Table 44 – Time errors	
Error limit	$\leq 3\%$
Error limit variation	$\leq 1,5\%$
Return time	$\leq 100\text{msec}$
Return ratio	$\geq 0,90$ and $\leq 0,95$

9.3.6 Directional intermittent arcs to earth detection

Directional earth protection must include a function that can be deactivated, for detecting the intermittent arcs (67N.S4) according to the principle logic indicated in Figure 34.

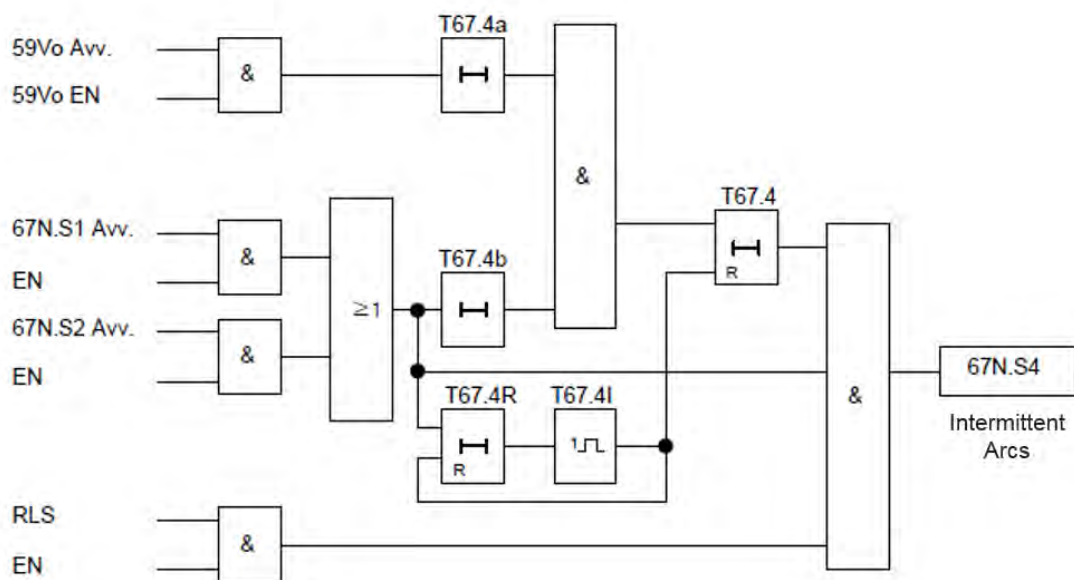



Figure 34 – Intermittent arc selection logic

	GLOBAL STANDARD	Page 69 of 134
	Protection and control device for MV substation – RGDM control unit	GSTP011 Rev. 01 26/07/2019

The RLS (Healthy Line Detection) function must stop the logic if the current line is not related to a fault. In particular:

- a. Logic state must be 0 for healthy line
- b. Logic state must be be 1 for faulty line
- c. The logic is based on the analysis of the first samples between $3V_o$ and $3I_o$ at the beginning of the fault; if the samples are in phase opposition then the line will be faulty, otherwise it will be healthy, as shown in Figure 35.
- d. The logic stage must be stored as long as $3V_o$ and $3I_o$ are over the threshold and it is maintained for the specific time $T67.S4b$.

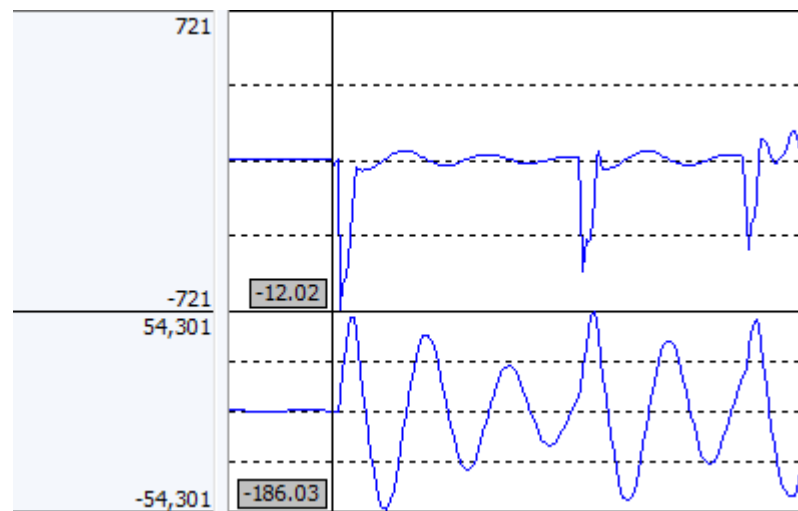

Figure 35 – Start of the single-phase fault on NC (compensated neutral) network

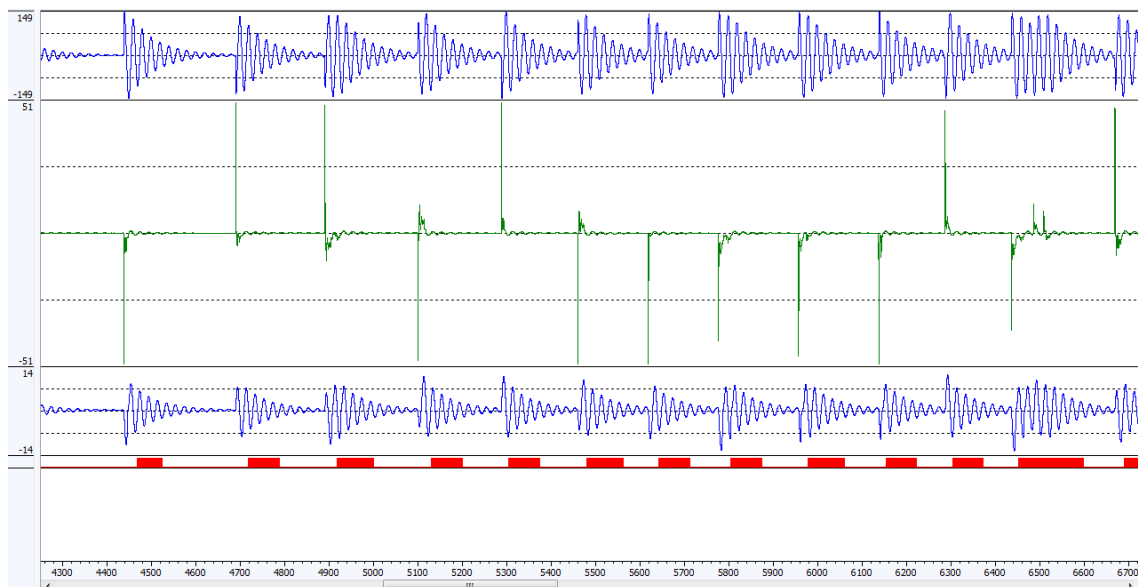



Figure 36 – Real intermittent arc event (gap between arcs < $T1$)

	GLOBAL STANDARD	Page 70 of 134
	Protection and control device for MV substation – RGDM control unit	GSTP011 Rev. 01 26/07/2019

Default parameters:

T67.4a = T67.4b =	0,1s
T67.4 =	10s
T67.4R =	9,5s
T67.4I =	0,02s

Table 45 – Time errors	
Error limit	≤3%
Error limit variation	≤1,5%
Return time	≤100msec
Return ratio	≥0,90 and ≤ 0,95

9.3.7 Directional Maximum Active Power

The device must detect the maximum active power passing through the node it monitors. It must be possible to deactivate this function when the default state is deactivated.

The threshold must work in three different ways:

- Taking a positive direction of P as an activation reference.
- Taking a negative direction of P as an activation reference.
- Taking only the P modulus as an activation reference.

For each of these three modes, it must be possible to set three different reactions, if the threshold is exceeded:

- Only indication to the centre.
- Sending of an alarm signal to the centre and one for a reduction in active power to the generation unit monitored; if the 32P threshold continues to be exceeded for a period of time equal to 30 sec, the RGDM sends the trip command to the OdM.
- Trip command to the OdM and related indication.

The default operating mode must be d., whereas the reference direction must be a.

9.3.7.1 Setting parameters

Table 46 – Base times		
	Start-up	Activation
Threshold 32P.S1	50 ms ± 3%	150 ms ± 3%

Table 47 – Activation level settings			
	Default	Range	Step
Threshold 32P.S1	20 MW	0 – 30 MW	0.1 MW

Table 48 – Activation threshold settings		
	Default	Range
Threshold 32P.S1	Positive	Positive / Negative / Absolute

Table 49 – Delay times settings			
	Default	Range	Step
Delay time	30s	0 – 100s	0,01s

Delay time for the reset value	0s	0 – 100s	0,01s
---------------------------------------	----	----------	-------

The positive activation threshold is taken to be that in which the active component (I_a) of the current is in phase with the reference voltage (Figure 37).

The negative activation threshold is taken to be that in which the active component is opposite to the phase with the reference voltage (Figure 37).

The direction of the current is taken to be positive, when it comes out of the secondary sub-station towards the user, and negative when entering the secondary sub-station from the generator.

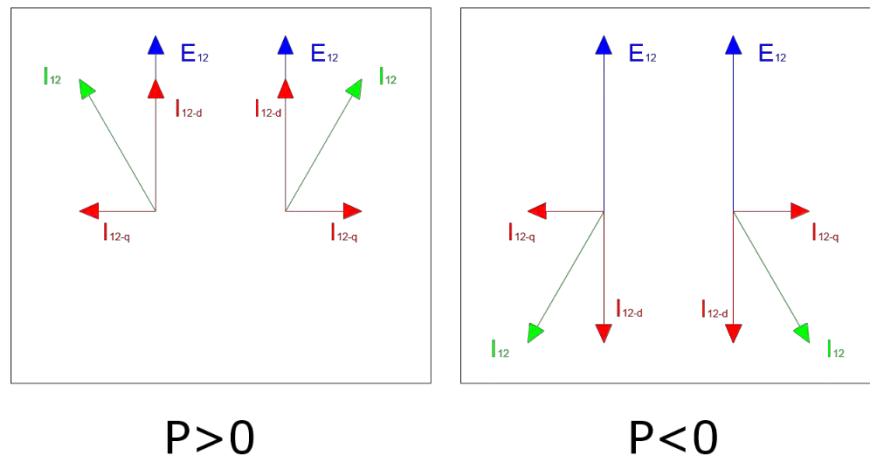

Figure 37 – Definition of power directions

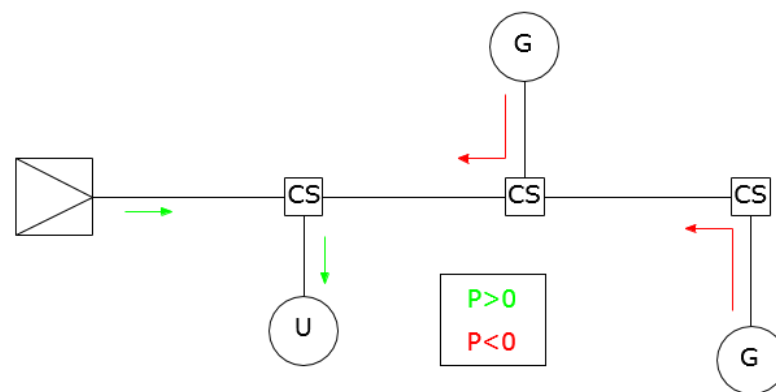

Figure 38 – Power direction convention

9.3.7.2 Accuracy of the measurements

Table 50 – Error settings	
Total error	Voltmetric $\leq 2\%$ Amperometric $\leq 2\%$
Error limit variation	$\leq 3\%$
Angle error	$\pm 2^\circ$
Sector exit hysteresis	3°

	GLOBAL STANDARD	Page 72 of 134
	Protection and control device for MV substation – RGDM control unit	GSTP011 Rev. 01 26/07/2019

Table 51 – Time errors	
Error limit	≤3%
Error limit variation	≤1,5%
Return time	≤100msec
Return ratio	≥0,90 and ≤ 0,95

9.3.8 Discrimination of INRUSH currents

In order to avoid untimely activations due to the transformers downstream of the device being energized, the device must block itself in relation to 51/51N and 67/67N threshold start-ups, when the second harmonic current (of any of the phases) exceeds the preset fraction of the basic current.

By means of the FFT, the function must compare the value for the 2nd harmonic with that of the threshold. If the value measured exceeds the threshold, it must block triggering for all the overcurrent (both phase and earth) protection function for the time set.

The logic must provide an OR for all phases, and it must be possible to deactivate the blocking function via the SW.

If, when the time set is exceeded, the overcurrent protection functions are still activates, even if the value of the 2nd harmonic is still higher than the threshold, the RGDM must recommence the normal protection logic and, where necessary, command triggering of the OdM.

9.3.8.1 Setting parameters

Table 52 – Activation threshold settings			
	Default	Range	Step
2ndH REST	25 % I _{50 Hz}	10 – 50 % I _{50 Hz}	5 %

Table 53 – Settings for blocking time T _{ini_2ndH}			
	Default	Range	Step
2ndH REST	450ms	50 – 3000ms	10ms

During blocking of the protection functions involved with the INRUSH currents, the related triggering timers must be reset.

9.3.8.2 Accuracy of the measurements

Table 54 – Error settings	
Total error	Amperometric ≤ 2%
Error limit variation	≤ 3%

Table 55 – Time errors	
Error limit	≤3%
Error limit variation	≤1,5%
Return time	≤100msec
Return ratio	≥0,90 and ≤ 0,95

9.3.9 Voltage detection function

The RGDM device must be able to indicate voltage presence/absence on MV line (RVL signal), based on the following output signal logic:

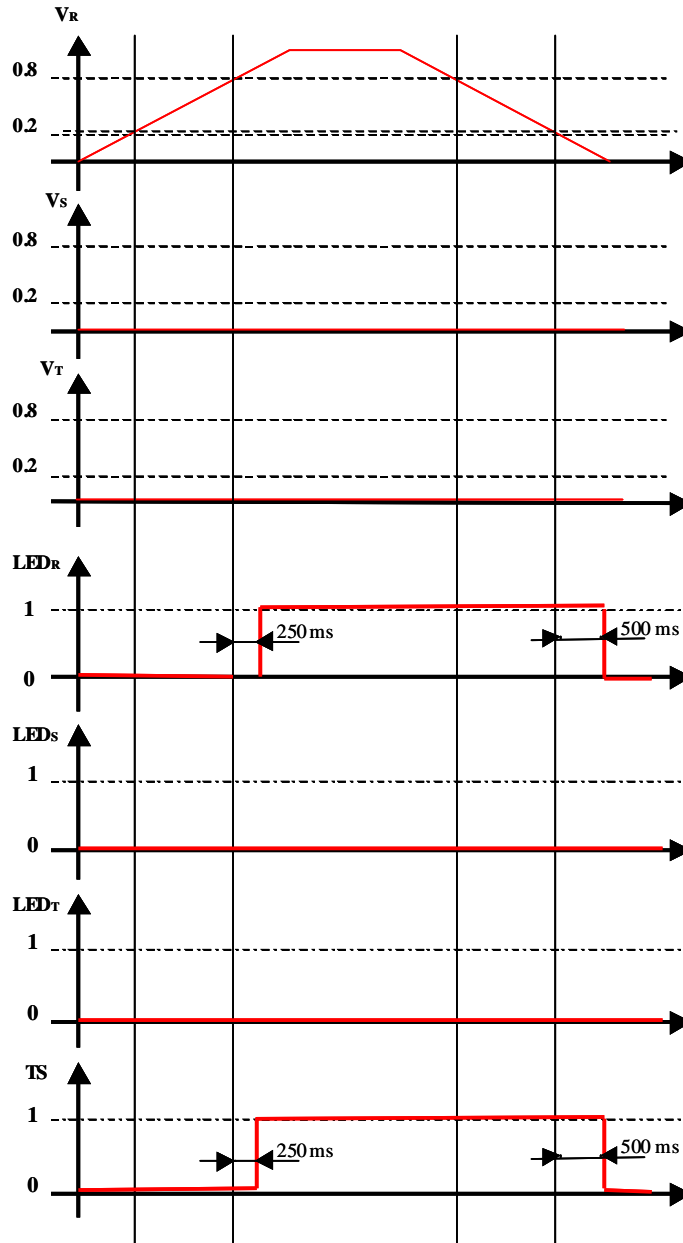

Figure 40 – Example of functioning of the Voltage On/Off logic

9.3.9.1 Accuracy of the measurements

Table 57 – Error settings	
Total voltmetric error	$\leq 2\%$ in the range $2\% \div 190\% V_n$ $\leq 0,5\%$ in the range $80\% \div 120\% V_n$
Error limit variation	$\leq 3\%$

Table 58 – Time errors	
Error limit	$\leq 3\%$
Error limit variation	$\leq 1,5\%$
Return time	$\leq 100\text{msec}$
Return ratio	$\geq 0,90$ and $\leq 0,95$

9.3.10 Protection blocking function

The protection functions must have a virtual input, which can be configured on both physical and virtual inputs, in order to take the intentional delay timer to 0, and to keep the triggering command blocked. In this case, only start-ups are emitted. Figure 41 shows an example of blockage of the protection function.

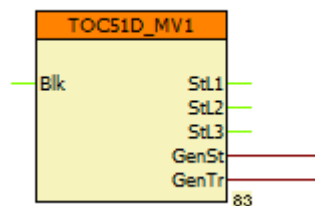

Figure 41 – Protection blocking function

9.3.11 Cycle direction checking function

The device must have a function that uses the display and SW to indicate whether the voltage triad connected to the RGDM is activated in the direct cyclical direction.

If the triad is activated in the inverse cycle direction, the RGDM must block the directional protection functions, and notify the operator via the display.

The function set up is an ANSI 47 protection system, that uses a triad of voltages to measure the direct sequence voltage (positive sequence U1) and the inverse sequence voltage (negative sequence U2).

Thresholds	Setting range	Step
Us1<	From 0,05 – 0,3 En	0,01 En
Us2>	From 0,7 - 1 En	0,01 En

9.3.12 59N Function

The device must include a 59N function, which can be associated with any relay or Vout. The measurement for 59N is provide by calculating the residual voltage as the vectorial sum of the three phase voltages at industrial frequency. The thresholds must be two:

- a. The first one, must be inverse or independent time
- b. The second one, must be independent.

Thresholds	Setting range	Step
59N1	From 0.01 - 1 Ern	0.01 Ern
59N2	From 0.01 – 1 Ern	0.01 Ern
59N delay time	From 1000 – 60000 ms	10 msec

	GLOBAL STANDARD	Page 76 of 134
	Protection and control device for MV substation – RGDM control unit	GSTP011 Rev. 01 26/07/2019

9.3.13 59V2 Function

The device must include a 59Vi function, which can be associated with any relay or Vout. The 59Vi measurement is provide from the calculation of the inverse sequence voltage, as the vectorial calculation at industrial frequency of the three phase voltages measured.

Table 61 – 59Vi setting parameters		
Thresholds	Setting range	Step
59Vi	From 0.01 – 1.3 En	0.01 En
59Vi delay time	From 1000 – 60000 ms	10 msec

9.3.14 VSS (Voltage Sensor Supervision) function

By means of algorithms, the device must diagnose circuitual switching off of the sensors in the RGDM's direction, and block the protection functions. This function must contain algorithms that are able to analyse coherence of the analogue quantities, associated with a real electricity network.

If the Vss detects an error in the measurements, the function must block the protection functions and deactivate the RVL function.

The measurement functions must continue working. The algorithms will be assessed and approved by ENEL.

9.3.15 Cold Load Pick Up

Every FdP must be according to the Cold Load Pik Up (CLP) function. The Cold Load Pickup function must have two different operation mode. The first one, the pickup value of the 51 function must be equal a user defined parameter during a configurable time. The second mode, the 51 function must follow a specific curve during a configurable time. The kind of curve could be time defined or inverse time (IEC and ANSI Curves as specified). The CLP has following characteristics:

- a. The CLP function must be Enabled/Disabled inside the FdP
- b. The CLP function is activated when the circuit-breaker switch from open to close
- c. It must be possible closing or changing the intervention value of the protection for a settable duration time
- d. When the function is blocked, it maintains the delay time at 0s and continue to return the start-up stage of the FdP.

9.3.16 Skip Shot function

This function is used to reduce the recloses attempts in case of high level of fault currents, which minimize stress or damage to substation transformer, underground cables, jumpers or connections cables of the feeder. Another benefit is the optimization of fault location for such defect levels, that only occur in stretches next substation.

Its operation consists of acting/trip instantaneously if the magnitude of the fault current reaches a preset value, in the sequence, the RGDM can jump reclose attempt according to a predetermined setting, regardless of the function 79.

This function must be a function embedded by the manufacturer, with parameters bellow adjustable:

- a. Number of jumps of reclosing according to reclosing sequence (79);
- b. Pickup of current (A) to phase-phase and phase-ground;

	GLOBAL STANDARD	Page 77 of 134
	Protection and control device for MV substation – RGDM control unit	GSTP011 Rev. 01 26/07/2019

9.3.17 Second tripping time protection Function (or contract time)

Each protection must be able to be configured with a second intervention time for the defined time functions.

The second tripping time is typically used as a contracted time, the main features are:

- c. The function must be include / exclude,
- d. If the CLP function is included, the second response time function has priority over the CLP function,
- e. The second tripping time function is activated on the status change from open to closed of the slave switch,
- f. The second tripping time remains enabled for a settable time, the same as the CLP function,
- g. It must be provided a function which can be enabled or disabled, with the following behavior: in case of automatic reclosing excluded, the second tripping time is kept active for functions in which it was enabled.

Table 62 – Setting parameters		
Minimum time (s)	Maximum time (s)	Step (s)
0,05	9,99	0,01
10	99,9	0,1
100	200	1

9.3.18 Protection Function of Broken Conductor I2/I1

The broken conductor (phase interruption) function is based on exceeding of the ratio between the negative sequence current and direct sequence current.

The main features are:

- a. The function must be Enabled/Disabled
- b. The function must have a overcurrent threshold; after which the I2/I1 is active
- c. The function must have a discrimination current threshold, under this the function is inhibited
- d. If the I2 / I1 exceeds the set threshold, it must be able to activate a relay or a virtual output or both to send its status.
- e. A time defined setting with a range 0 to 60 seconds and step 0,1 seconds;
- f. A positive sequence voltage threshold that will avoid the operation for phase-to-phase short-circuits, with range 0 to 0.9 Vn and step 0.01.
- g. A zero sequence voltage threshold that will avoid the operation for phase-to-ground short-circuits, with range 0.1 to 1.3 Vn and step 0.01.

9.3.19 Extension of protection function 46

This function can be configured to trip the circuit-breaker or just to send an alarm (without tripping the circuit-breaker). Due to a possible malfunction when loads are low, it must be possible to activate the following logic to avoid incorrect operations:

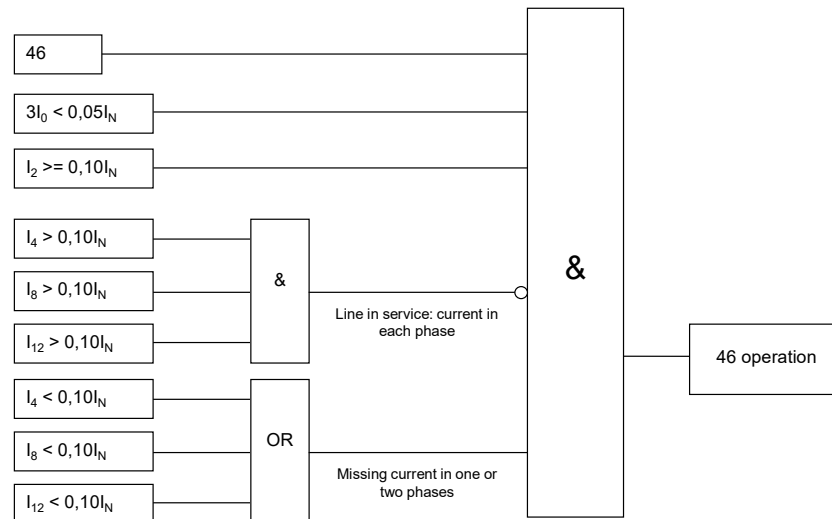

Figure 42 – Logical scheme: 46

Every level used in this logic can be set by the user. Other solutions will be subject to approval by ENEL.

9.3.20 Protection Function of Breaker Failure

The breaker failure function consist of two overcurrent directionless function, one for poly-phase faults and other for single-phase faults. The function is used to signal the lack of opening of the circuit breaker.

The main features are:

- The function must be Enabled/Disabled,
- It must be associable with an OR matrix to the protection functions to be monitored,
- The function is activated at the trigger command of the associated protections in the matrix,
- If the protection functions activated do not fall within the set time, a relay or a virtual output associable via SW must be command.

9.3.21 Frequency protection function EAC

The frequency measurement must be performed on the three phase voltages monitored by the device.

9.3.21.1 EAC blocking stages

The function must be equipped with blocking stages that guarantee the reliability of the measurements and the correct behavior of the protections. The blocking stages are able to inhibit the operations based on the frequency measurement.

9.3.21.2 Undervoltage and overvoltage blocking stages

The three (V4, V8, V12) voltages must be monitored to support the operation of the device; if one falls below or rises above the preset minimum and maximum voltage thresholds respectively, the operation of all the tripping stages will be inhibited. This blocking stage must have two timers:

- Stage activation delay,
- Stage reset delay.

	GLOBAL STANDARD		Page 79 of 134
	Protection and control device for MV substation – RGDM control unit		GSTP011 Rev. 01 26/07/2019

Stage	Active State	Blocking settings		Blocking Time	
		Range	Step	Range	Step
27	Ena/Dis	0 ÷ 1.4 Vn	0,05 Vn	0 ÷ 60 s	0,05 s
59	Ena/Dis	0 ÷ 1.4 Vn	0,05 Vn	0 ÷ 60 s	0,05 s

Stage	Measurement Accuracy	Minimum intervention Time	Time measurement error
27	0,01 Vn	±50 ms	±50 ms
59	0,01 Vn	±50 ms	±50 ms

9.3.21.3 Maximum unbalance β blocking stage

It is required to implement stages based on the maximum difference between the magnitude of the single monitored voltages and their average value in order to preclude the operation of the RGDM in case of unbalanced voltages.

The unbalance stage must have a reset delay time. This stage inhibits the operation of all tripping stages when the β ratio goes above a set value which value is so calculated as follows:

$$\mu = (V4+V8+V12) / 3$$

$$\beta = \frac{\max[abs(V4 - \mu); abs(V8 - \mu); abs(V12 - \mu)]}{\mu}$$

Stage	Active State	Blocking settings		Blocking Time	
		Range	Step	Range	Step
β	Ena/Dis	0,05 ÷ 1	0,05	0 ÷ 60 s	0,05 s

Stage	Measurement Accuracy	Minimum intervention Time	Time measurement error
β	0,01 Vn	±50 ms	±50 ms

9.3.21.4 Max frequency difference γ blocking stage

This stage inhibits the operation of all the tripping stages when the maximum difference between the recorded frequencies of the monitored signals exceeds the preset γ value. The Max frequency difference blocking threshold must have a reset delay time.

	GLOBAL STANDARD	Page 80 of 134
	Protection and control device for MV substation – RGDM control unit	GSTP011 Rev. 01 26/07/2019

$$\gamma = \max ((\text{frequency } V_4 - \text{frequency } V_8); (\text{frequency } V_8 - \text{frequency } V_{12}); (\text{frequency } V_{12} - \text{frequency } V_4))$$

		Blocking settings		Blocking Time	
Stage	Active State	Range	Step	Range	Step
γ	Ena/Dis	10 ÷ 100 mHz	0,10 mHz	0 ÷ 60 s	0,05 s

Stage	Measurement Accuracy	Minimum intervention Time	Time measurement error
γ	10 mHz	≤100 ms (4 cycles)	±50 ms

9.3.21.5 Maximum variation allowed between consecutive periods Maxdt blocking stage

The Maxdt blocking stage uses the following mechanism to inhibit the frequency measurements:

- When Δt is greater than a value pre-set via the configuration SW (range 100÷7000 μ s) it detects a perturbation on the phase and blocks the frequency (tripping) stages and the rate of change of frequency (tripping) stages,
- EAC continue to measures the cycles and compare the last one with the second-last; only when Δt falls below the pre-set value via the configuration SW the perturbation on the phase is over and the frequency measurement must be re-established,
- to restart and pass the frequency and the rate of change of frequency measurements to the (tripping) stages, it must properly fill the memories of the moving average (e.g. if N is the number of the cycles of the average calculation, then the frequency will be available after N cycles and the rate of change of frequency after N+N).

9.3.21.6 EAC tripping stages

The EAC will implement under frequency, over frequency and rate of change of frequency protection functions. These can be simultaneously/selectively enabled and can send the trip command towards the controlled circuit-breaker. The setting parameters ranges are specified in the Table 69 and Table 70, where the operating time are measured in a sliding temporal window of 5 cycles.

stages settings			Operation Time		
Active State	Range	Step	Range	Step	cycles
Ena/Dis	0.9fn ÷ 1.1fn Hz	0,0002fn Hz	0 ÷ 3000 cycles	0,5 cycles	5 cycles

stages settings			Operation Time		
Active State	Range	Step	Range	Step	cycles
Ena/Dis	±(0,1÷ 10) Hz/s	0,01 Hz/s	0 ÷ 3000 cycles	0,5 cycles	5 cycles

	GLOBAL STANDARD	Page 81 of 134
	Protection and control device for MV substation – RGDM control unit	GSTP011 Rev. 01 26/07/2019

9.3.21.7 Frequency and voltage measurements

The frequency and voltage measurements must refer to the fundamental component and to the effective value. Suitable filtering systems must ensure the measured values are unaffected by any electromagnetic disturbances.

The frequency and rate of change of frequency measurements must be carried out with the required accuracy in the 45 - 65 Hz operating range, for voltage values 0.3 times greater than the rated one.

The voltage measurements must be carried out with the required accuracy in the 45 - 65 Hz operating range, for values from 0 to 1.4 times greater than the rated one. In the case of signals with a THD < 10% the frequency measurements must be adjusted.

The frequency stages must be immune to the most common transients on the HV grid and ENEL will provide the related digital recordings (transformers energization, lines reclosing, short-circuits).

Note that the RGDM must base the frequency measurement by measuring the time between two zero crossings of a period and summing the N measured intervals, with N = number of periods to be integrated.

It is necessary that the number of samples used per period be sufficiently dense to approximate the curve between two consecutive samples by a straight-line segment. This means that the errors inserted in the time measurement between the zero-crossing and the sample position must be compensated by means of linear interpolation.

The manufacturer must clearly indicate the methodology and the calculation algorithm implemented in the RGDM (including also algorithms based on moving averages, sampling frequency, number of processed samples and the filtering systems) for making the following measurements:

- a. Frequency,
- b. Rate of change of the frequency,
- c. Voltage,
- d. Rate of change of the voltage.

9.3.21.8 EAC Function

The EAC function is made up of two protection stages based on EQUATION below and must be activated upon detecting the sign of active power.

The operation of the stages will be communicated according to the IEC 61850 series and must be associated with Vout virtual outputs.

EQUATION 1

$$81_S_x = (((f_{x1} \text{ and } \frac{df}{dt}) \text{ and } (ON / OFF)) \text{ or } (f_{x2} \text{ and } (ON / OFF)) \text{ and } \overline{P})$$

ENEL will provide the details for the implementation of the EAC FdP during the development phase.

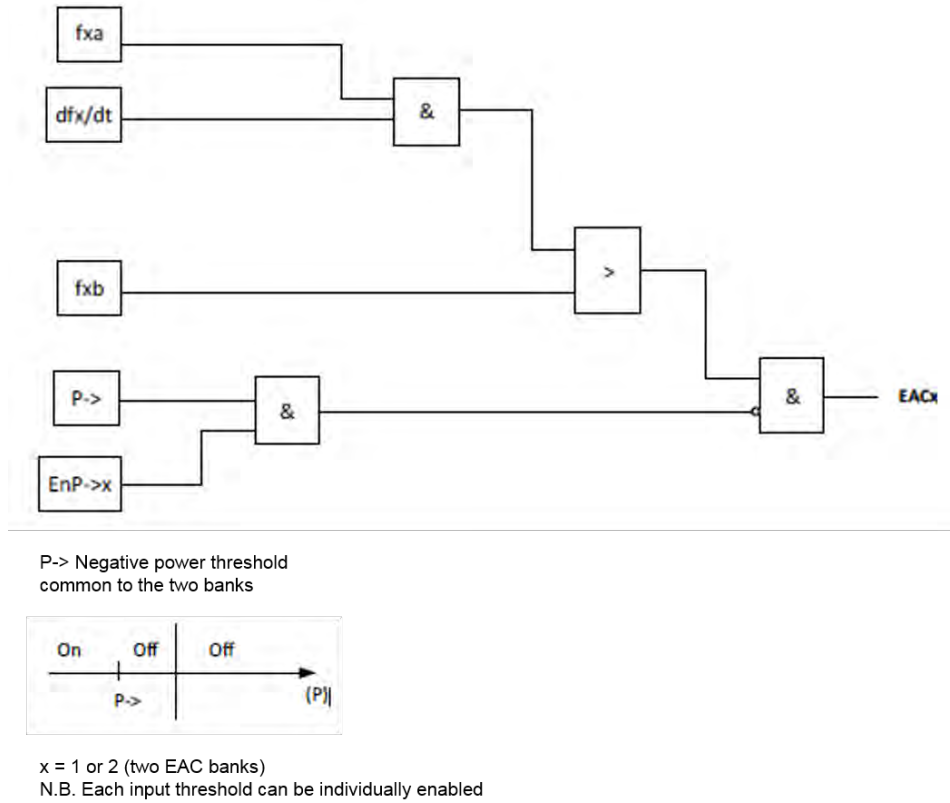

Figure 43 – EAC Logic

9.3.22 Management on single-phase and two-phase network

The device must have three different operating modes, depending on the network characteristics. In particular, it will be necessary to be able to set the operation of the RGDM also for single-phase and two-phase networks.

It will be possible to select one of the three operating modes using the SW configurator, indicating which of the three phase lines will be wired. For three-phase networks, it will be possible to wire both three single phases and two phases plus the residual components.

According to the actual network characteristics, therefore, the device must exclude the protection functions not applicable, as described in the following table.

	51	67	51N	67N	32P	RVL
Three Phase	●	●	●	●	●	●
Two Phase	●	●	○	○	●	●
Single Phase	●	●	○	○	○	●

● = Available

○ = Not Available

9.3.23 Overvoltage detection protection function (ES59B)

The overvoltage detection/supervision function ES59B is used for lines with connected co-generation plants.

9.3.23.1 Protection behavior

This function can be Enabled and Disabled via SW configuration and inhibited by a Digital Input. The RGDM will assume that the protection is in service if the Digital Input is activated, and out of service when the Digital Input is deactivated.

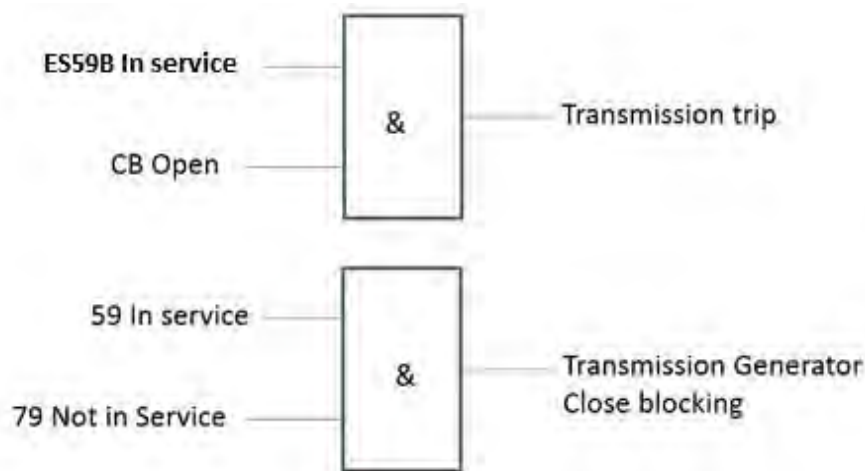

Figure 44 – Self producer cogeneration automatism

The ES59B protection performs also the following functions:

- Supervision of the line voltage to determine the operation of the self-producer user, when the breaker is opened,
- Block all attempts at closing the circuit-breaker according to the voltage presence on the line,
- Block all attempts at closing of the circuit-breaker due to the fall of the magneto-thermal voltages,
- Emission of the trip signal to the external communications equipment. When the circuit-breaker is disconnected and ES59B is in service this Digital Output will be activated;
- Emission of the tele-blocking signal to the external communications equipment. When the auto-reclosing automatism is out of service and ES59B is in service this Digital Output will be activated.

FdP logical state	Displayed message	IEC 61850 Report to the RTU	Internal Logging	Disturbance recording
Operate/Trip	ES59B.Sx	Yes	Yes/No	Yes/No

9.3.24 Hot Line Tag function

This function activates more sensitive overcurrent protection elements than your currently settings on the normal sequence reclosing, due to security purposes in the case of services in energized networks carried out by crews. Therefore, RGDM must allow dedicated overcurrent settings 50/50N and 51/51N (with the possibility of choosing time-current curves) with automatic reclose function (79) blocked.

	GLOBAL STANDARD	Page 84 of 134
	Protection and control device for MV substation – RGDM control unit	GSTP011 Rev. 01 26/07/2019

When the equipment is in local mode, this function can only be enabled or disabled by the dedicated physical button (independent of the physical button of the reclosing function) on front panel of RGDM, and when in remote mode this function can only be enabled or disabled through the software or by means of a dedicated DNP3 command.

It should be noted that the hot-line-tag function differs from that of only blocking the reclosing because the latter remains with the overcurrent settings of the first operation of the reclosing sequence, which is used to maneuver the equipment into the system.

9.4 Automation Functions

As described in par. 6.1.6.2, the RGDM has 2 different ways of interfacing with the other equipment in the secondary sub-station:

In its **basic configuration**, RGDM will indicate the fault conditions, the voltage presence, and will send only one measurement to the Remote Control Peripheral Unit (UP). RGDM delegates opening and closing maneuvers, to the automatic re-closing function and to the UP itself, which will be directly connected to **Enel standardized Circuit Breakers (MV RMU according to GSCM004)** or other compatible devices. RGDM must be able to use the IEC 61850 protocol towards the router installed in the secondary sub-station, in order to make it possible to use the BLIND function described in par. 9.4.3 and 9.4.4.

In its **extended configuration**, RGDM will be connected directly to both the UP/Primary RTU, and the MV RMU. The evolution of the automations on the UP/Primary RTU will cause a series of IEC 61850 messages to be sent to the RGDM, in order to guide it to send command to the MV RMU and in executing the reclosing cycle, if necessary.

In the extended configuration for Easy Sat, the RGDM will be like a subservient protection of automatic reclosing and communicates through the RTU of secondary substation Primary RTU.

Using the local configuration software on a PC, it must be possible to select:

a. Basic Configuration or Extended Configuration

Irrespective of the type of configuration used, the type of functioning must also be selected, from:

b. FSL

c. FRT

	GLOBAL STANDARD	Page 85 of 134
	Protection and control device for MV substation – RGDM control unit	GSTP011 Rev. 01 26/07/2019

Table 72 – Legends of commands and signals used by RGDM		
	Signal name	Description
MB pin 1	+ com TS	Power supply (+24Vcc) and Common remote signals
MB pin 2	51 A	Detection of multi-phase fault
MB pin 3	PRES V	Power on, line side, detected by the CT-VT sensors.
MB pin 4	TM (pole 1)	Pole 1 TM
MB pin 5	67 A	Detection of single-phase fault to earth
MB pin 6		
MB pin 7	TM (pole 2)	Pole 2 TM
MB pin 8	COM ID	Inversion of direction command 67 A (common)
MB pin 9	ID INV (UD)	Inversion of direction command 67 A
MB pin 10	-	Power supply (-24Vdc)
MI pin 1	+M	Power supply, motors OdM (+) 24 Vdc
MI pin 2	+M	Power supply, motors OdM (+) 24 Vdc
MI pin 3	-M	Power supply, motors OdM (-) 24 Vdc
MI pin 4	-M	Power supply, motors OdM (-) 24 Vdc
MI pin 5	+A	Power supply RGDM and MV RMU (according to GSCM004) command circuits (+) 24 Vdc
MI pin 6	-A	Power supply RGDM and GSCM004 (according to GSCM004) command circuits (-) 24 Vdc
MI pin 7	+L	MV/LV substation in local command (enabling buttons on RGDM and OdM)
MI pin 8	ccX 89	OdM closed signal
MI pin 9	caX 89	OdM open signal
MI pin 10	TC CCx	OdM Closing Command
MI pin 11	TC CAx	OdM Opening Command
MI pin 12	AnIn	Switch fault
MI pin 13	RVS	Bar power on
IEC 61850	TC AP	Opening remote control from the central system
IEC 61850	TC CH	Closing remote control from the central system
IEC 61850	BLIND	BLIND signal from IED downstream or emitted to IED upstream.
IEC 61850	INCL	Remote inclusion of the Re-closing function
IEC 61850	ESCL	Remote exclusion of the Re-closing function
IEC 61850	FSL/FRT	Automation type choice
IEC 61850	RVS	Bar power on
IEC 61850	Switch fault	Switch fault on the MV RMU
IEC 61850	INVERSION	Command to invert the angular sector on which threshold 67 acts.

The automation function includes a general activation / deactivation command via 61850.

9.4.1 Functioning in basic configuration

This operating mode will be used when the RGDM device is connected, to the Peripheral Unit for remote control of the secondary sub-stations (UP described in the GSTR001 Enel Global Standard), via the MB terminal board. In this configuration, the MI connector will be free, that is, not connected to any equipment.

The UP, guided by the signals coming from RGDM will, by means of its own local automations, take on executing the automatic movements of the Circuit Breaker (MV RMU). In the same way, the UP will also take on execution of the automatic re-closing function.

When the device is configured for FSL automation, the BLIND logic, which delays indication of the fault to the UP, must be managed. On the other hand, when the device is configured for FRT automation, the BLIND logic must be excluded permanently (there will be no intentional delay in communicating the fault condition to the UP).

A router, in the secondary sub-station and connected to the RGDM's Ethernet interface, is required to be able to receive or transmit BLIND signals, as explained more fully in par.9.4.3.

	GLOBAL STANDARD	Page 86 of 134
	Protection and control device for MV substation – RGDM control unit	GSTP011 Rev. 01 26/07/2019

The signals emitted from the RGDM are sent to the Remote Control Peripheral Unit, which processes those using suitable automations, in order to execute automatic selection of the faulty section.

The logic state for the power on/off must be sent on the output contact (PRES V), with a logic value of 1, when the CT-VT detects that the power is on.

All outgoing logic signals must have a value of (0) or must remain in the last logical status (it must be configurable), if the RGDM's internal diagnostics detect a problem in the device itself.

When there is no power supply to the device (+ 24 Vdc) any signal must not being emitted.

The remote measurement to be sent to the UP, which can be selected from:

- a. Line voltage
- b. Line current
- c. Active transient power
- d. Reactive transient power

The device must have a 4-20 mA configurable field, in accordance with the UP's input channel.

Ultimately, with basic configuration, an RGDM must:

- e. Indicate the presence / absence of 51 A, 67 A and PRES V signals to the UP.
- f. Invert the action sector for a single-phase fault to earth, if it sends an ID INV signal from the UP.
- g. Send the configured remote measurement to the UP's analogue input.

9.4.1.1 Optional timers signaling

Normally the behaviour of the signalling TS67 and TS51 is as above described.

The RGDM shall permit, through a flag (see red circle in Figure 45), the switch on other behaviour.

In detail:

- The command of relay 51 must be issued only when, after tripping of thresholds 51, 51N or 67NS2, the condition of "Voltage Absent" is detected within a certain time (T1, programmable, default setting: 0.5 s).
- The command of relay 67 must be issued only when, after tripping of thresholds 67NS1 or 67NS2, the condition of "Voltage Absence" is detected within a certain time (T1, programmable, default setting: 0.5 s).
- The return to quiescent status of relays 51 and 67 must occur when "Voltage Presence" condition is detected and that condition holds for a certain time (T2, programmable, default setting: 10 s).
- If there is no return of power within a certain time (T3, programmable, default setting: 4 hours), output contacts 51 and 67 return to quiescent status anyway.
- The signal of present voltage and absence voltage must be instantaneous value

According to the previous points:

- LEDs 51 and 67 must follow the state of respective relay.

- Event logging must also records the issuance of commands to relays 51 and 67, in addition to tripping of various thresholds.

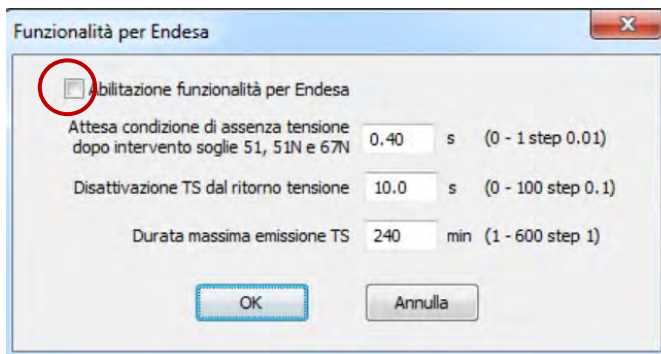

Figure 45 -Example of timers signaling.

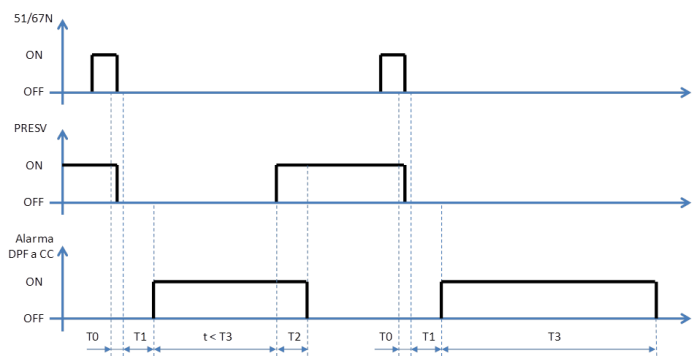

Figure 46 - Behavior of the signaling.

9.4.2 Functioning in extended configuration

In this configuration, the RGDM is not connected to the UP, and so the MB terminal board will not be used. It will be connected, via the Ethernet port, to a UP/Primary RTU, which will implement the automation logics, and via which it can receive BLIND signals.

The MI connector will also be used for direct interfacing with the Enel Standardized MV RMU (according to GSCM004).

Table 73 shows the signals conveyed via the MI connector:

Table 73 – Legends of Interface MI connector towards MV RMU			
MI Connector	Signal name	Description	Signalling direction
1	+M	Power supply, motors OdM (+) 24 Vdc	RGDM → MV RMU
2	+M	Power supply, motors OdM (+) 24 Vdc	RGDM → MV RMU
3	-M	Power supply, motors OdM (-) 24 Vdc	RGDM → MV RMU
4	-M	Power supply, motors OdM (-) 24 Vdc	RGDM → MV RMU
5	+A	Power supply RGDM and MV RMU (according to GSCM004) command circuits (+) 24 Vdc	RGDM → MV RMU
6	-A	Power supply RGDM and MV RMU (according to GSCM004) command circuits (-) 24 Vdc	RGDM → MV RMU
7	+L	MV/LV substation in local command (enabling buttons on RGDM and OdM)	RGDM → MV RMU
8	89ccX	OdM closed signal	MV RMU → RGDM
9	89caX	OdM open signal	MV RMU → RGDM
10	CH	OdM Closing Command	RGDM → MV RMU

	GLOBAL STANDARD	Page 88 of 134
	Protection and control device for MV substation – RGDM control unit	GSTP011 Rev. 01 26/07/2019

11	AP	OdM Opening Command	RGDM → MV RMU
12	AnIn	Switch fault	MV RMU → RGDM
13	RVS	Bar power on	Ext → RGDM

9.4.3 FSL automation

With implementation of the IEC 61850 protocol, the IEDs are to exploit the real-time communication capacity to exchange blocking (goose) signals, referred to as BLIND. These signals temporarily block opening orders given by the FdPs, therefore allowing only the section of the line affected by the fault, or, in the case of a short-circuit at the MV line's terminals, they make it possible to avoid cases of simultaneous triggering of the MV line's and the transformer's protection.

The Blind signals are conveyed in multi-casting in the Primary Sub-Station's LAN and in the VLAN, where the Secondary Sub-Station's IEDs are involved (RGDM), via the IEC 61850 (Goose) protocol.

It must be possible to select the FSL function in local configuration or activated, by means of a suitable IEC 61850 message.

This logic selectivity is based on comparing the information content of the BLIND message, sent by the IEDs, following detection of a fault condition. This information content is topological code (TAG) calculated by the remote control system, and written within the IED by the Primary RTU client. To make comparison of the topological codes possible, the system uses the Primary RTU to send the definite identifier ADRLEVBN, which defines the composition of the TAG code, by means of the number of bits.

Once written by the client, the information related to the logic selectivity (TAG, ADRLEVBN, etc.) must be kept in the IED's memory until something else is written, even if the IED is rebooted.

The comparison algorithm that the IED must implement, and the format of the "tag" are described in the specifications: "Algorithms for assigning and comparing TAGS for FSP automation and remote disconnection.doc".

The details associated with the IEC 61850 profile are contained in the technical specifications GSTP013.

The IED must be able to process at least 30 BLIND messages sent at the same moment when the fault occurs. That is, the configuration must provide at least 30 IEDs installed along the medium voltage line.

During the procurement process, Enel will provide additional details for the implementation of the FSL function.

Some cases, in which the FSL function is used, are indicated below:

Figure 47 shows a case of use when a fault occurs along the MV line, and an IED located upstream electrically, sends a BLIND message. When this occurs, the BLIND message is ignored, because it has been sent by an IED located upstream electrically. Therefore, the FdP completes its intentional Top-fdp delay time, and sends the triggering command to the MV switch.

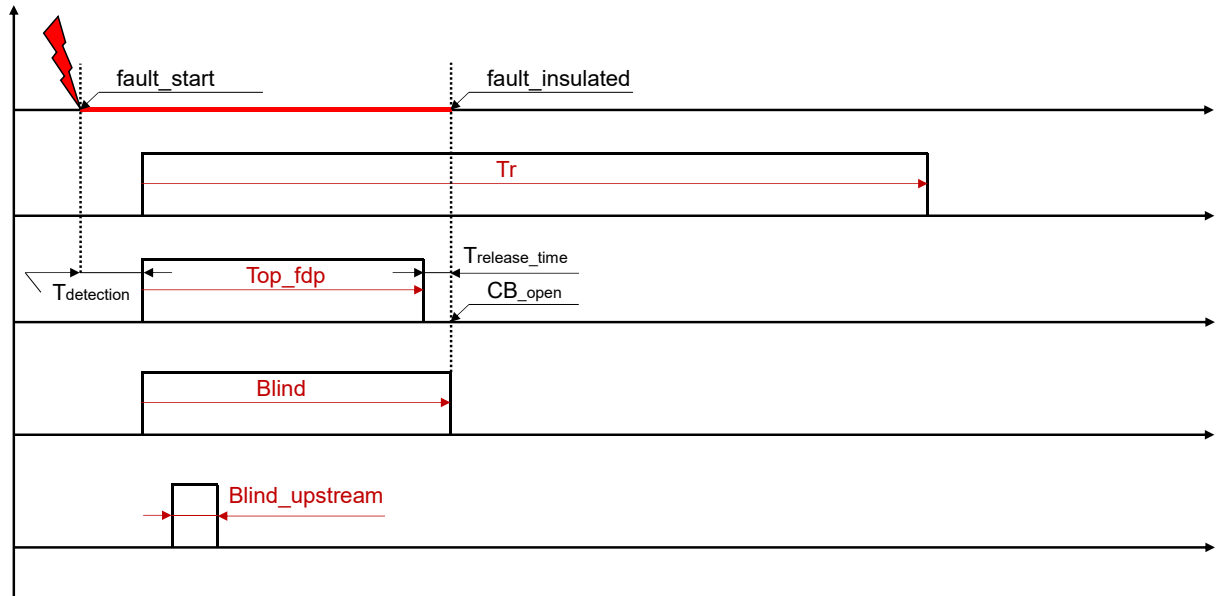

Figure 47 – FSL functioning logic

Figure 48 shows a case of use when a fault occurs along the MV line and an IED located downstream electrically, sends a BLIND message. When this condition occurs, the BLIND message is ignored, since it has been received after the moment at which the triggering command is sent to the MV switch.

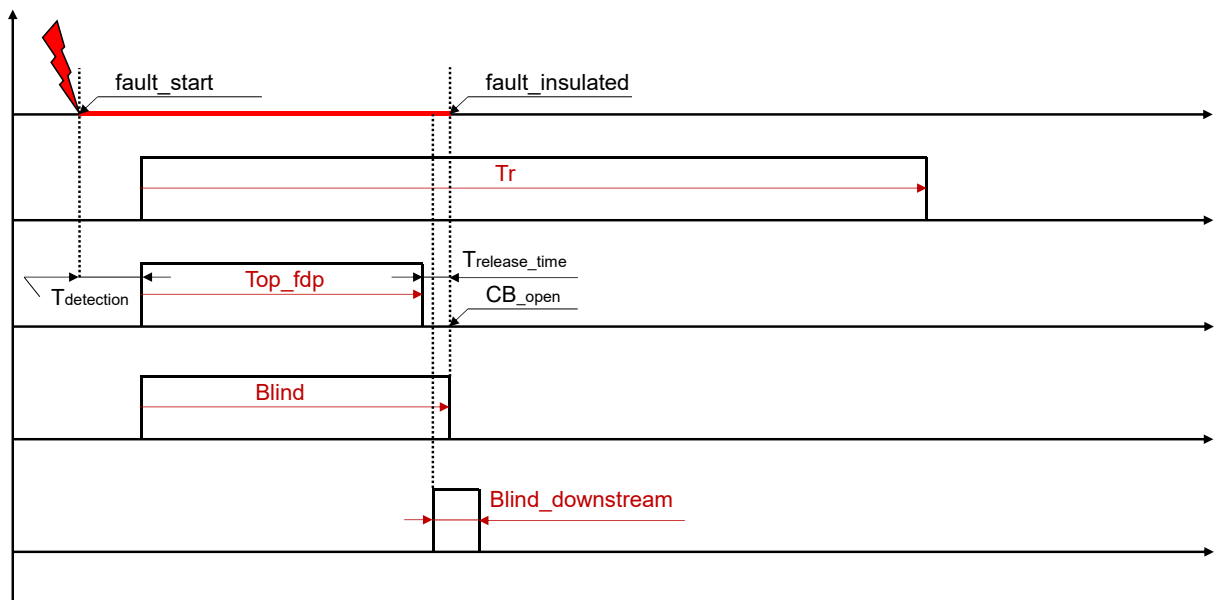

Figure 48– FSL functioning logic

Figure 49 shows a case of use when a fault occurs along the MV line and an IED located downstream electrically, sends a BLIND message. When this occurs, the BLIND message is accepted, because it has been sent by an IED located downstream electrically. When this condition occurs, the FdP is kept in a reset state ($Top_fdp=0$) until the condition for receiving a valid BLIND signal is confirmed. If, as shown, the BLIND condition sent by the IED downstream lapses, the Top_fdp timer is started again, until the triggering condition arises in which the triggering command is sent to the MV switch.

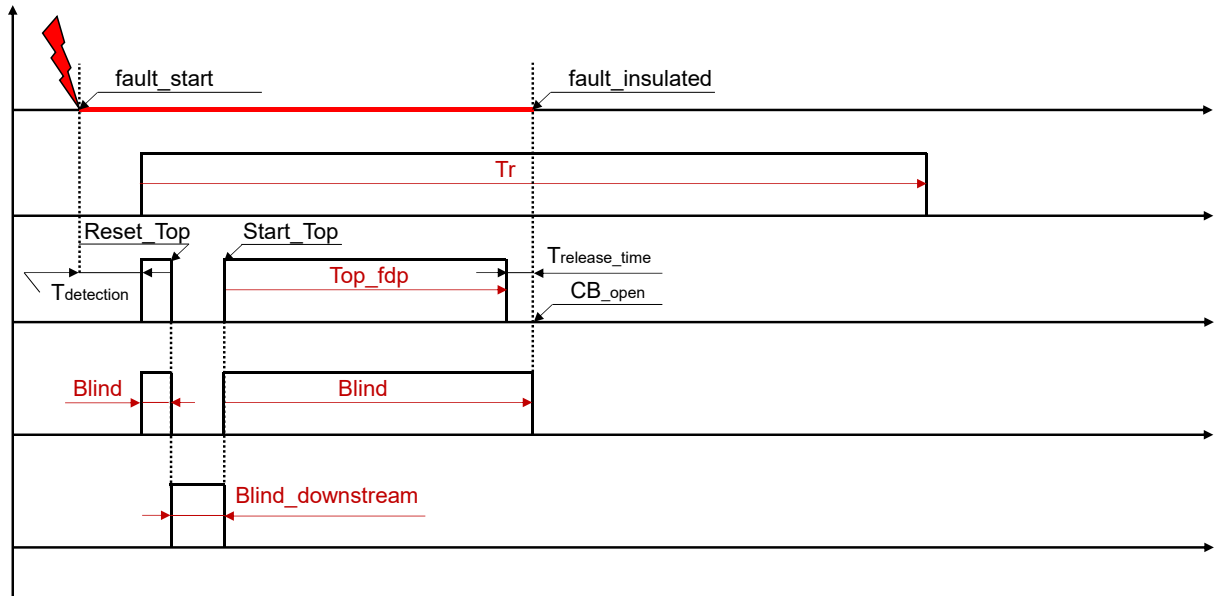

Figure 49– FSL functioning logic

Figure 50 shows a case of use when a fault occurs along the MV line, and an IED located downstream electrically, sends a BLIND message a number of times. When this occurs, the BLIND message is accepted, because it has been sent by an IED located downstream electrically. When this condition occurs, the FdP is kept in a reset state ($Top_fdp=0$) until the condition for receiving a valid BLIND signal is confirmed. If, as shown, the BLIND condition sent by the IED results in the Tr back-up timer time being exceeded, the IED moves on to the triggering condition, and sends the triggering command to the MV switch.

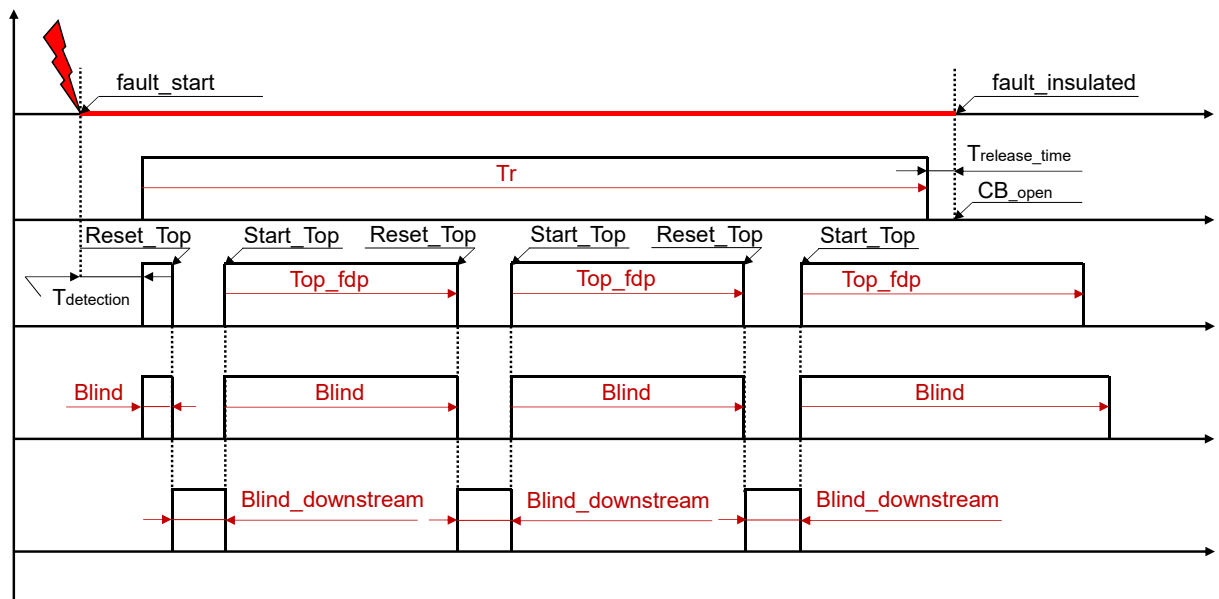

Figure 50– FSL functioning logic

9.4.3.1 SFS automation: Remote Trip Function

In the FSL function must be provide an algorithm able to transmit (through a Boolean variable contained within the TAGs or through Vout) to the RGDM placed downstream of the one that sent the signal, the opening of the circuit-breaker.

In Figure 51 is shown an example of the Remote Trip Logic of the RGDM.

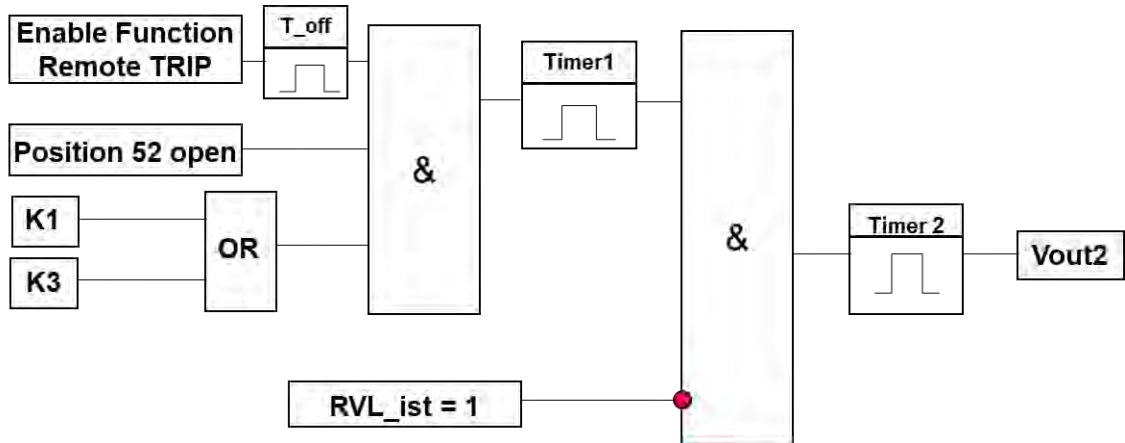
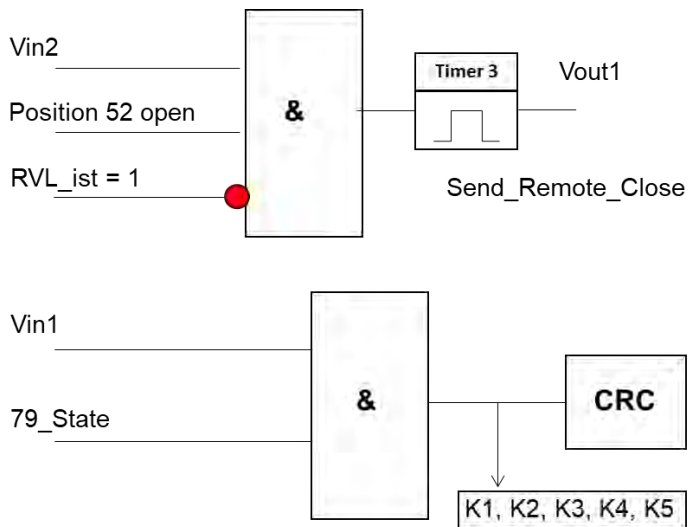

Figure 51 – RGDM Remote trip Logic

9.4.3.2 SFS automation: Remote Close Function

In the FSL function must be provide an algorithm able to send (through a Boolean variable contained within the TAGs or through Vout) to the RGDM downstream of the one that sent the signal, the closing of the circuit breaker.



In

Figure 52 is shown an example of the Remote Close Logic of the RGDM.

	GLOBAL STANDARD	Page 92 of 134
	Protection and control device for MV substation – RGDM control unit	GSTP011 Rev. 01 26/07/2019

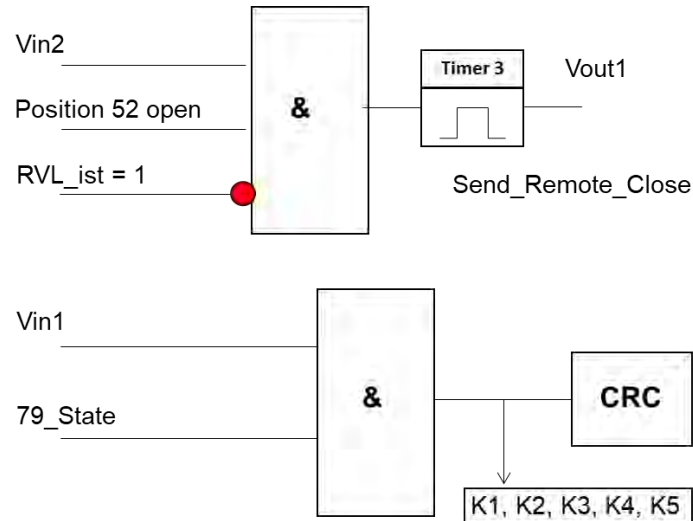

Figure 52 – RGDM Remote Close Logic

9.4.3.3 SFS automation: “Boundary function”

In the FSL function must be designed an algorithm called the “boundary function”, with the following features:

- a. Possibility of association of the input “boundary variable” to a physical or virtual input.
- b. If the function 79 is included when the function variable is passed from 0 to 1, the closing command must be implemented.
- c. If the function 79 is excluded the passage from 0 to 1 of the border variable must be ignored.

9.4.4 FRT Function

The automatic fault section selection function, FRT, must be able to be selected as a configuration parameter, when setting the unit, or activated by a suitable IEC 61850 message.

If this type of functioning is selected, the BLIND logic must not be used. Therefore, when the RGDM detects one of the fault conditions, it must emit a signal (and open command in the case of extended configuration), after an intentional delay time equal to that configured in the “protection function” section, unless the fault condition has lapsed in the meantime.

The signalling (and trigger in case of extended configuration) must therefore be done of the delay time for the FdP.

9.4.5 Automatic Re-Closing Function (ARF)

This function is normally managed by the UP/Primary RTU, however, it must be possible to enable the automatic re-closing function for local use, and only when the RGDM is in extended configuration.

Configuration of the automatic re-closing function via the RGDM, must require programming of a series of timers, presented briefly in Table 74 and set in terms of default values, increment steps, and admissible range. A brief description is also given of the role of each of these timers.

Each re-closing must occur when the power is on upstream (high RVS signal). It must be possible to ignore this parameter, by means of software exclusion.

After triggering, that result in opening of a switch, the absence of RVS inhibits the re-closing cycle.

When the reclosing of the switch is executed, the TN timer is started. The expiration of TN occurs if in closed state, no faults are detected within the TN period. When TN expires the re-closing cycle is cancelled

	GLOBAL STANDARD	Page 94 of 134
	Protection and control device for MV substation – RGDM control unit	GSTP011 Rev. 01 26/07/2019

9.4.5.2 Functioning when the re-closing program is not configured

When the RGDM detects activation conditions in relation to one of the thresholds 67.S1 (51.S1), 67.S2 (51.S2), 67.S3 (51.S3), 67.S4 (51.S4), 67N.S1, 67N.S2, 67N.S3, 67N.S4, 51N.S1, 51N.S2, 59N.S1, 59N and the automatic re-closing program is not configured, it must send the triggering command to the MV RMU causing definitive opening. The FR signal must also be emitted, using the IEC 61850 protocol.

9.4.5.3 Rapid re-closing program (RR)

Rapid re-closing (RR) must be done when the switch is activated and opens due to one of the FdP's thresholds triggering it.

Once the rapid re-closing command has been emitted, the RGDM must start the timer, TN. Thereafter, if:

- a. A new fault detection occurs within the TN, a triggering command/signal must be emitted to the MV RMU, and indication of failed FR re-closing must be enabled.
- b. No fault is detected within the TN, the re-closing cycle automation must go back into stand-by mode.

Manual or remote control closing of the switch, using the program provided in RR, must start the TN. Any triggering during this time frame must result in emission of the opening command for the MV RMU, in the basic time, without re-closing, and the indication of failed FR re-closing must be enabled.

9.4.5.4 Rapid + Slow + Saved (RR+RL+RM) program

Once the trigger command/signal has been emitted to the MV RMU, rapid closing must be activated, and the neutralization time TN must be started.

If no new triggering occurs within TN, the RGDM must go back to stand-by mode.

If, during TN a new trigger is activated in relation to one of the FdP thresholds, the TRL time must be started, at the end of which slow re-closing (RL) must be carried out. Once the resulting closing of the switch has occurred, the following must be started:

- a. Discrimination time TD1
- b. Neutralization time TN

In the case of a MIXED line, TD1 = 0; if the fault recurs immediately, a new not definitive trigger must be activated, after the waiting time for the first saved re-closing.

In the case of a line deemed to be CABLE, TD1 = 5; if the fault recurs within the TD1 time, a new not definitive trigger must be activated, with FR signaling.

In the case of a MIXED line, if a fault occurs within TN, opening of the switch must be commanded, and subsequent saved re-closing RM must be done when TN expires. For each subsequent saved re-closing, timers TN and TD2 must be started. If a fault occurs within TN, but after TD2, opening of the switch must be commanded, and subsequent saved re-closing RM is done when TN expires. If, on the other hand, the fault is detected within time TD2, a definitive trigger is activated, with indication of failed FR re-closing.

[*] In the case of a CABLE line, if a fault occurs within TN, but after TD1, opening of the switch must be commanded, and subsequent saved re-closing RM is done when TN expires. If, on the other hand, the fault is detected within time TD1, a definitive trigger is activated, with indication of failed FR re-closing.

This step [*] is repeated for the number of saved re-closings configures, using TD2 in place of TD1.

After a definitive trigger, any voluntary closing (local or remote) must start TN. If no trigger condition occurs within T, the automation goes back to stand-by mode, and the device is ready to carry out a new cycle.

9.4.5.5 Common function of the RR and RR+RL programs

The voluntary closing commands must reset the memory registers of the counter for saved closings.

Manual or remote control opening must always result in the automation going to stand-by mode, with definitive interruption of any re-closing cycle in progress.

	GLOBAL STANDARD	Page 95 of 134
	Protection and control device for MV substation – RGDM control unit	GSTP011 Rev. 01 26/07/2019

It must be possible to indicate the cause of the failed re-closing, by correlating the indications, in order to make the failed re-closing information available in MMI / events register and 61850 messages.

The non-volatile memory must have a totalizer for the number of automatic (RR, RL, RM) re-closings done, and the number of failed re-closings (FR).

Remote commands must be provided, conveyed using the IEC protocol for inclusion (INCL) or exclusion (ESCL) of the re-closing function.

Execution of re-closing must only occur if all the conditions indicated below are true simultaneously (Figure 53):

- a. Re-closing program enabled via software (RR or RR+RL)
- b. Bistable relay in re-closing included position.
- c. The last remote enabling command for Re-closing was “INCL”.

If even just one of these conditions is false, the device will not carry out any re-closing.

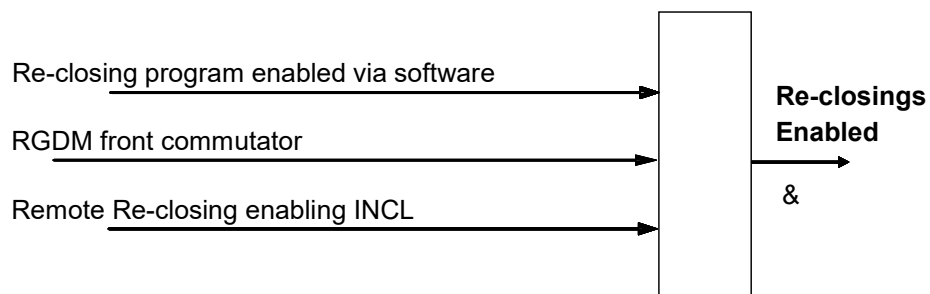

Figure 53 – Re-closing enabling logic

The automatic reclosing function must inhibit the closing if, following a manual closing, a fault occurs inside a control time window defined by the TDCM parameter.

A manual closing will trigger the TN, for the faults check while TN is active and the TDCM has expired, the automatic reclosing function will perform the first closing after the TRL expiration and then, according to the settings, the subsequent ones.

A (settable) recovery time is needed to consider the auto-reclosing cycle as finished. After this time expires, a trip will activate again a complete auto-reclosing cycle.

After a manual closing, the automatic reclosing function will be inhibited for a selectable time. After this time expires, the automatic reclosing function will be ready to operate in case there's no other blocking condition

The status of reclosing included/excluded must be maintained in case of shutdown and subsequent restart of the device.

In addition to the automatic Re-closing functions available in the Figure 53 two inputs are required for Inclusion / Exclusion of Re-closing. It must be possible to configure these inputs on both physical and virtual inputs.

9.4.5.6 79 Skip-Shot Autoreclose Blocking Function

A high-set instantaneous element can be used to block autoreclosing for close-in, high-magnitude faults. This auto reclosing function blocking is typically applied where these faults are likely to be permanent or in the substation equipment or exit cables, or exceed the damage rating of the source transformer or other equipment.

The functionality shall be enabled or disabled [default] and the following parameters shall be configured:

	GLOBAL STANDARD	Page 96 of 134
	Protection and control device for MV substation – RGDM control unit	GSTP011 Rev. 01 26/07/2019

Table 76 – Configurable Parameters for the 79 Skip-Shot Autoreclose Blocking Function	
79 SK enabling	OFF, ON
79 SK Current fault intensity thresholds	500 – 20000 A
Selection of Protection Functions	Es. 51.S3, 67.S3, ecc...

9.4.6 Sectionalizer Automation Logic

This automation technique shall be disabled by default. It can be enabled by a remote command from the SCADA using DNP3, from proprietary software or directly from the panel selecting from:

1. Sectionalizer Automation Logic OFF
2. SECTIONALIZER mode
3. SWITCHER mode

When enabled, other automation functions shall be inhibited to avoid superimposed ways of operation. Hot Line Tag condition must be considered as illustrated in this chapter.

The equipment must make the selection available between the sectionalizer or switcher mode via the supervisor (SCADA), proprietary software or the operator directly from the panel.

In the switcher mode, the RGDM will open and lock after reaching a configurable number of counts (one, two or three). Each count consists of a momentary overcurrent (phase or neutral pick-up) followed by the simultaneous absence of voltage across the three phases.

The IMS cannot operate or count an event with only one of two isolated variables (overcurrent or undervoltage).

Systemically, such counts are originated by the protection detect (openings) of an equipment upstream in the circuit, which is operating due to a defect in the main protection zone of the sectionalizing mode. When completed accountant, the RGDM must open before the upstream equipment performs the next reclosing of its cycle.

	GLOBAL STANDARD	Page 97 of 134
	Protection and control device for MV substation – RGDM control unit	GSTP011 Rev. 01 26/07/2019

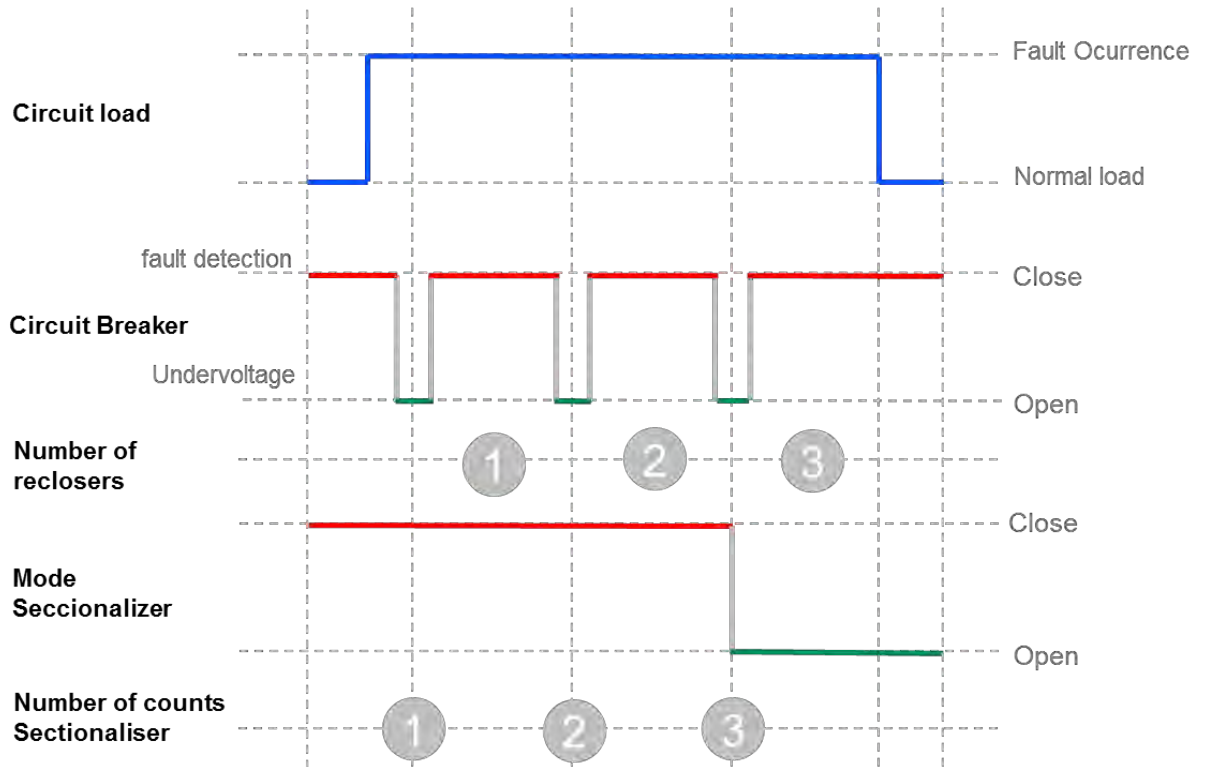



Figure 54 - Example of the operation of the Automated Switch as Sectionalizer with N=3

The reset process must be parameterized (normally used 60 seconds), after normalization of the voltage magnitude (above 0.8 pu) and without overcurrent presence it starts at the reset time, where after this time expires, the logic restarts the number of counts. The reset shall also be performed by local or remote opening/closing command.

	GLOBAL STANDARD	Page 98 of 134
	Protection and control device for MV substation – RGDM control unit	GSTP011 Rev. 01 26/07/2019

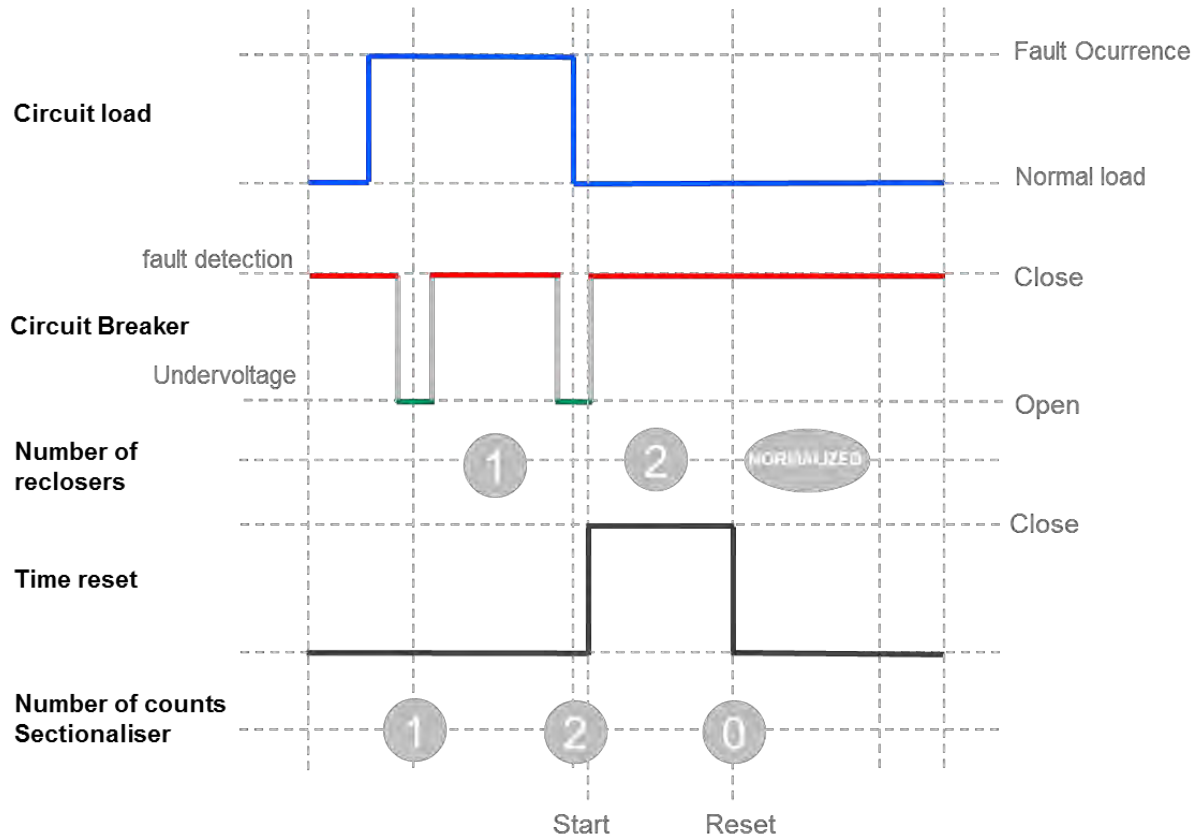

Figure 55 - Reset Counter

Cases in which RGDM is controlling a switch gear able to interrupt fault currents:

- In case of Hot-line-tag service by crews, there must be a logic (with enable/disable option) that must disable the sectionalizer mode and activate the dedicated protection overcurrent settings as described in the Hot Line Tag paragraph;
- Additionally, must be implemented a logic (with enable/disable option), that after the start of a sectionalizer count cycle, if there is a three-phase voltage absence for more than 60 seconds before reaching the complete cycle of counting, the logic disables sectionalizer mode and activates the same settings protection described in the Hot Line Tag paragraph. The protection mode is disabled after 60 seconds of the three-phase voltage normalization (above 0,8 pu) and enables the sectionalizer mode reseted, since/once this logic has been triggered by absence of voltage as described in this paragraph.

In switcher mode the IED must work as a fault detector, being able to identify short and overload individually by phase and neutral, must also identify a permanent fault (lockout)

To identify the permanent fault, the IED must identify a momentary overcurrent (phase or neutral pick-up) followed by the simultaneous absence of voltage in the three phases to initiate the confirmation time, after expiry of the configured time and the absence of voltage remains the IED must send a "permanent alarm" (lockout) over the DNP3 protocol.

The reset process must be parameterized (normally used 60 seconds), after normalization of the voltage magnitude (above 0.8 pu) and without presence of overcurrent it starts the reset time, where after this time expires, it normalizes the alarm.

	GLOBAL STANDARD	Page 99 of 134
	Protection and control device for MV substation – RGDM control unit	GSTP011 Rev. 01 26/07/2019

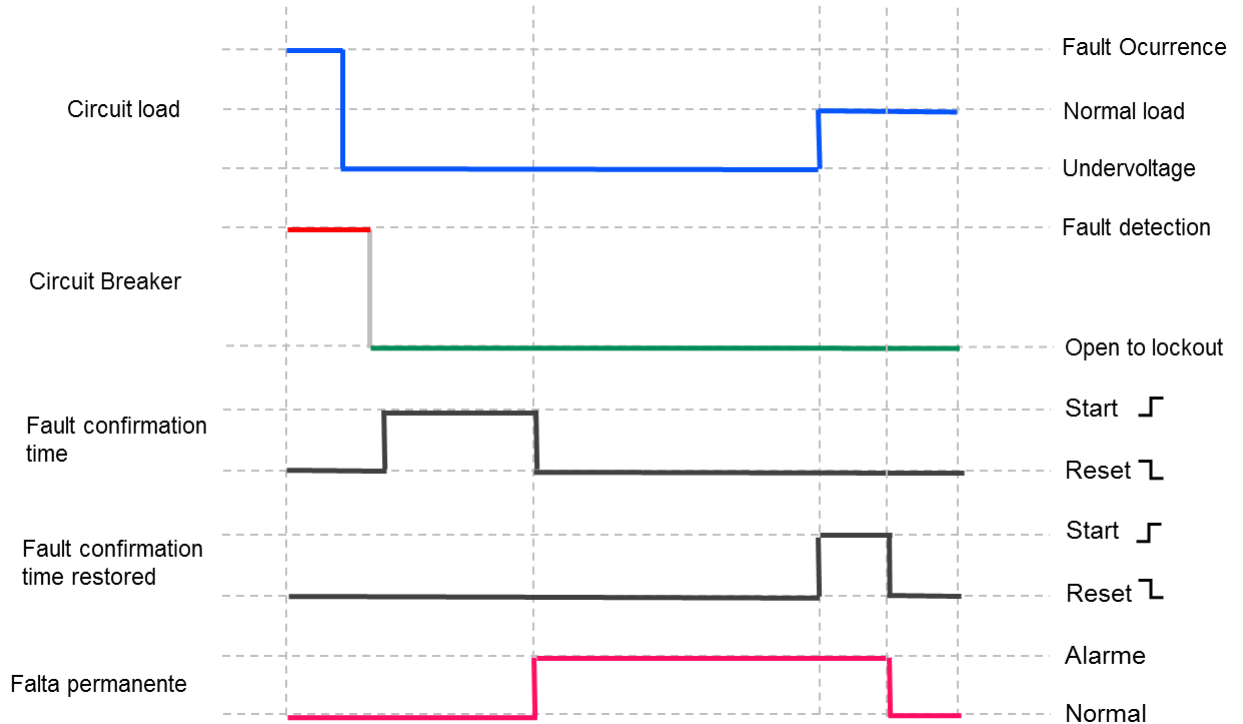

Figure 56 - Alarm Permanent Fault

9.4.7 ZSC – Zone Sequence Coordination

This automation technique shall be disabled by default. It can be enabled by a remote command from the SCADA using DNP3 or from proprietary software.

When enabled, other automation functions shall be inhibited to avoid superimposed ways of operation.

This function is used when it has two or more protective devices in series, which is activated in the upstream equipment. The aim is to prevent upstream equipment from operating for a fault located beyond the equipment downstream, which could cause a number of reclosing attempts to exceed the permitted, or even worsen the quality of energy for a larger number of consumers than it should.

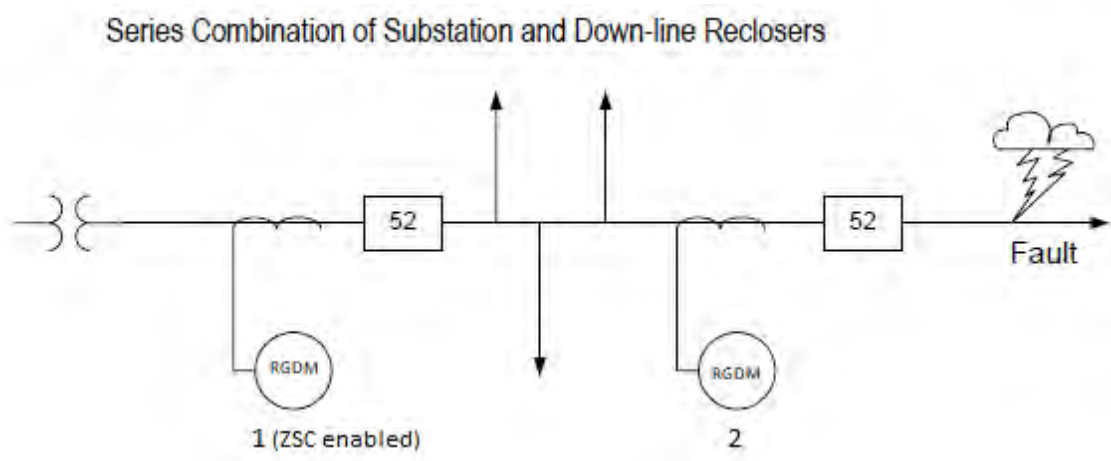



Figure 57 – Diagram of protection devices in series along a distribution feeder

	GLOBAL STANDARD	Page 100 of 134
	Protection and control device for MV substation – RGDM control unit	GSTP011 Rev. 01 26/07/2019

According to the figure Figure 57 (above), its operation consists in sensitizing both equipments (RGDM 1 and 2) to the indicated fault, however, only RGDM2 will trip operate (by 50/50N or 51/51N), while RGDM1 will only be sensitized by the current fault, because its tripping time won't be reached (its 50/50N function must be adjusted with defined time around 100ms of difference of similar function in RGDM2). The protection settings overcurrent of devices must conform the figure Figure 58 below:

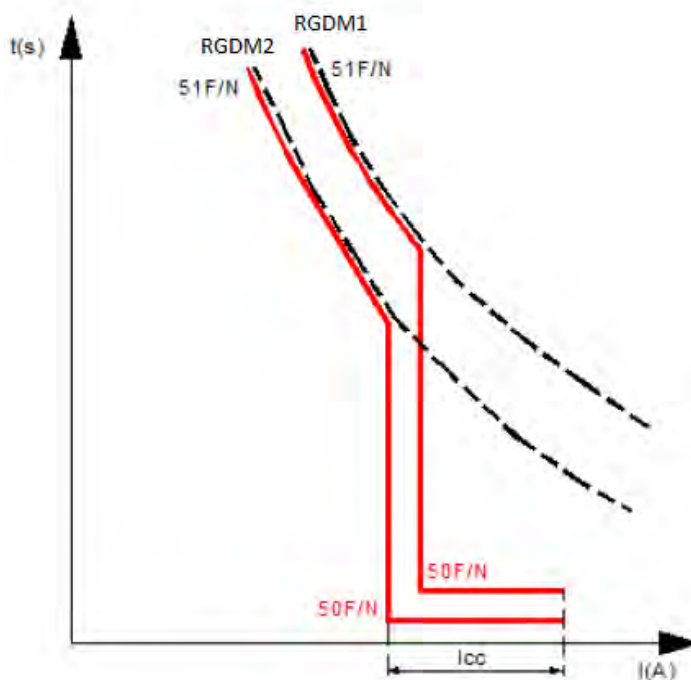

Figure 58 – Overcurrent protection coordination between RGDM1 and RGM2 of the case in question

Therefore, according to figure 8 below, at moment of the fault, in RGDM1 it occurred pick-up (PU) followed by drop-out (DO) of the overcurrent functions (e.g. 50), thus, the ZSC function will advance/step from first (1°) to second (2°) reclosing sequence (no trip), so, in the next sequence the function 50 is disabled (51 remains), resulting in maintaining the selectivity between the time overcurrent curves (51) of devices along the reclosing sequence attempts of the RGDM2 for the fault.

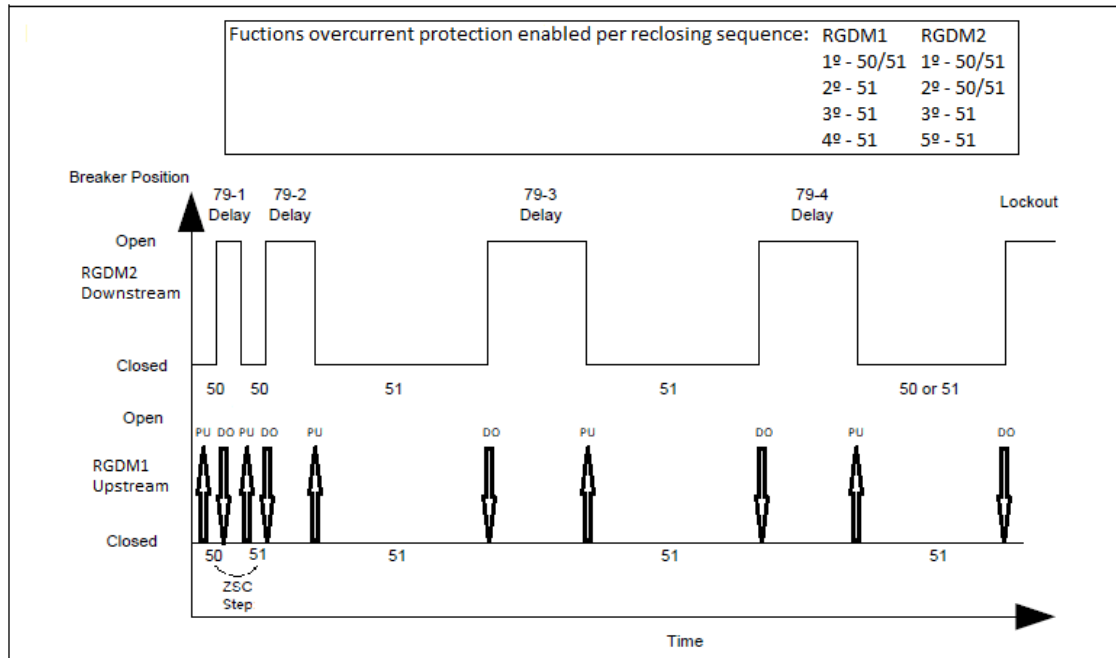

Figure 59 – Operation of devices with the use of the ZSC function in RGDM1

In other cases of configuration regarding of overcurrent protection per reclosing sequence to RGDM1, it can be that is necessary the ZSC function advance/step more than one reclosing sequence.

This function must be a function embedded by the manufacturer, with parameters bellow adjustable:

- Option to enable/disable;
- Number of reclosing sequence steps: 1 or 2;

9.5 Automatic Parallel Function (Synchro-check IEEE 25)

Closing of the switch served by the RGDM, with a local or remote control, must be possible in one of the alternative ways, that can be selected using the SW parameter.

- a. Without checks of line voltages (downstream of the switch) and reference voltages (upstream of the switch).
- b. With checks if the line and reference voltages are in parallel.

In the former case, the command received will always be transmitted to the switch directly. In the second case, the command must set the time δ_{TRCM} , and check that the line and reference voltages are in place, after which the second parallel condition must be checked, as described below.

The δ_{TRCM} (hereinafter T) is a discrimination time, during which the synchronizer checks the synchronism status of the two networks. If, on expiry of this time, the parallel conditions are no longer in place, the device must reset the synchronism requests, until a new closing command is emitted.

Closing of the switch will always be allowed, in the absence of one or both of the voltages checked (line and reference).

For this function, the phase voltage must be used, the SW makes it possible to select which of the line voltages ($V_4 V_8 V_{12}$) must be closed, and a corresponding reference voltage taken upstream of the switch.

There are 2 modes in which this function must emit a closing command:

	GLOBAL STANDARD	Page 102 of 134
	Protection and control device for MV substation – RGDM control unit	GSTP011 Rev. 01 26/07/2019

- c. Synchronous mode (PS)
- d. Asynchronous mode (PA)

It must be possible to select the two modes separately or jointly (PS or PA or PS + PA), independently, for Voluntary Manual Closing and for Automatic Slow Re-closing, according to the diagram below.

Voluntary Closing:

- e. PS (parallel synchronous)
- f. PA (parallel asynchronous)
- g. PS + PA

Automatic Slow Re-closing:

- h. PS (parallel synchronous)
- i. PA (parallel asynchronous)
- j. PS + PA

When this parallel check function is enabled, but is unavailable due to the absence of the parallel conditions, the UP/LAT must not emit any closing command (voluntary or automatic).

Inclusion / exclusion of the parallel check must be provided for, by configuring the programming parameters, and by means of commands sent using the IEC 61850 protocol.

9.5.1 Checking of parallel conditions between synchronous networks (PS)

This function is provided to connect two networks characterized by synchronous conditions, or by a very small shifting defined as the percentage difference between the line voltage frequency and the reference voltage frequency.

The very low shifting condition must be defined, according to the following condition:

- a. Shifting: $ISI < S_{sin}$

Evaluation of the shifting must be done by means of suitable filtration, in order to introduce sufficient attenuation of the component related to stable electromagnetic oscillations of the networks, which could obstruct recognition of the synchronous situation. The electromagnetic oscillations have the following characteristics:

- b. $\omega_E = 5 \div 10 \text{ s}^{-1}$
- c. $\Delta f_E = \pm 0.1\%$

Therefore, a filter is required on the frequency measurement, with integration times $\geq 2s$.

When synchronous conditions are checked, a time T is assigned during which, in addition to shifting, the following are also checked:

- d. Value of the difference between the line and reference voltage modules, lower than a maximum value ΔV_{sin}
- e. Value of the phase difference between the line and reference voltages, less than a maximum value of $\Delta \varphi$

Where the reference voltage is a voltage upstream of the switch to be closed, which is occurs on the MV terminals of the RGDM.

The regulation ranges for checking asynchronous parallel, are as follows:

Quantity	Range	Step
----------	-------	------

	GLOBAL STANDARD	Page 103 of 134
	Protection and control device for MV substation – RGDM control unit	GSTP011 Rev. 01 26/07/2019

Voltage module difference (ΔV_{sin}) [% Vn]	5 ÷ 40	1
Phase difference between the voltages ($\Delta\phi$) [°]	0 ÷ 60	1
Shifting (S_{sin}) [% fn]	0 ÷ 0,2	0,05
discrimination time δ_{TRCM} [s]	0÷600	1

9.5.2 Checking of parallel conditions between asynchronous networks (PA)

The quantities to be checked in order to emit a close command between asynchronous networks, must be:

- Phase angle between the line and the reference voltage decreasing: $d\phi/dt < 0$
- Shifting less than a maximum shifting of S_{asin}
- Difference between the line and reference voltage modules, lower than a maximum value ΔV_{asin}
- Shifting acceleration between the line and reference voltage frequencies, $(dS/dt) < dS_{asin}/dt$ on completion of evaluation of the shifting constancy. The acceleration limit value is: $dS_{asin}/dt = 0.01 \cdot (0.5 - T_a)$

When these conditions are in place, the device must determine the advance time (T_a) for emitting the closing command, in relation to the closing time for the switch and the shifting, so that closing occurs when the line and reference voltages are almost in phase with each other.

Quantity	Range	Step
Voltage module difference (ΔV_{asin}) [% Vn]	5 ÷ 40	1
Shifting (S_{asin}) [% fn]	0 ÷ 0,2	0,05
Advance time (T_a) [ms]	0 ÷ 200	1

The regulation ranges for checking asynchronous parallel between the networks, are as follows:

The advance time T_a must be evaluated in the field by the RGDM, by means of a counter than measures the delay between the command given and the actual change of state of the limit switch. This measurement must be included in those for diagnosing the device.

9.6 Functions to command the OdM

When installed in extended configuration, the RGDM must be able to send open and close commands to the OdM, and so the MI terminal board must be set up on the RGDM's board, for that purpose. This will be used to manage the open and close contacts, as well as the logic signals related to the limit switches, in order to detect the open/closed status, and deal with any incongruities.

A connecting cable will be connected to that terminal board, with a connector on the MV RMU (according to GSCM004). Note: the OdM can be powered and commanded directly from the GSTR002 RTU (UP2020 Lite) or future generation RTUs, without connecting the MI terminal board to the OdM, which will be connected directly to the RTU.

The circuits must be able to carry a constant 8A current without getting damaged, and the maximum temperature of the same within the circuitry must not exceed 40°C at an ambient temperature of 20°C.

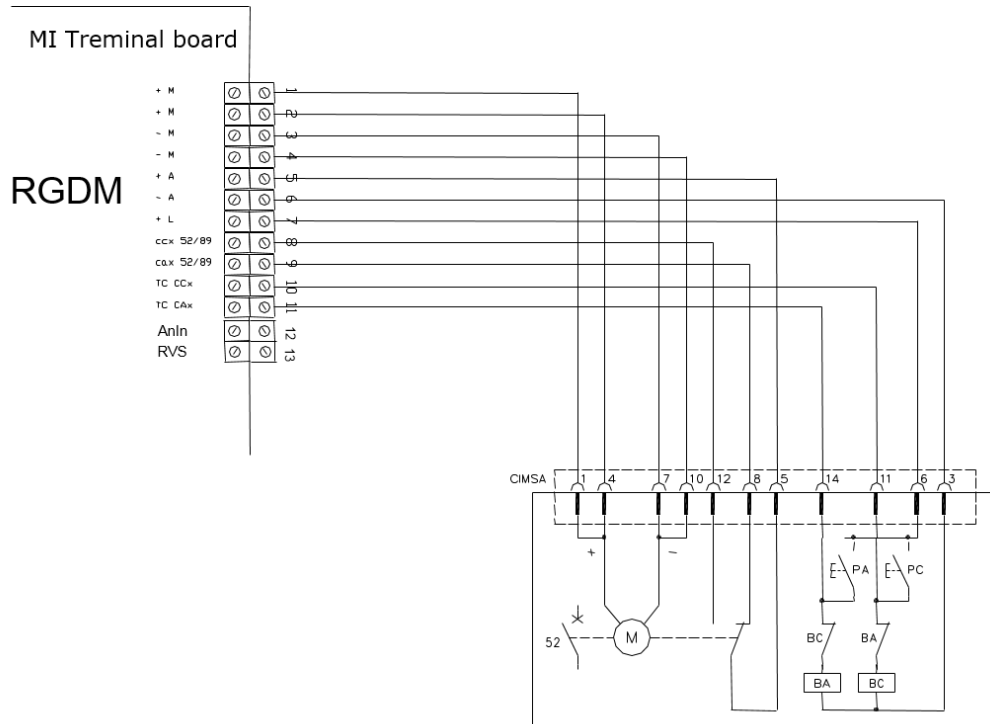

Figure 60 – Wiring to the OdM

9.7 Auxiliary Functions

Any alternative solution to those implemented in the specifications, must be discussed beforehand and approved by Enel.

9.7.1 PLC Function

It must be possible to use configuration software to configure a PLC on board the device, able to create a boolean link between physical and virtual inputs, internal statuses of the device, and physical and virtual outputs. The minimum characteristics must be:

- Basic boolean functions with n° 4 inputs and one output, plus a timer.
- Minimum number of boolean functions = 30.
- Maximum execution time for a single boolean function = 10ms.
- Structure able to allow interconnection between boolean functions (out_A => in_B).
- Minimum operators required = OR(4in), AND(4in), NOT, XOR(2in), FF_RS, FF_Q, Comparator, Rising Edge sensibility, Falling Edge sensibility, Counters.
- Each internal timer in the basic boolean functions must be able to be of a Drop_On (delayed activation), Drop_Off (delayed deactivation), PULSE (impulse) type.
- The setting range for the timers must be 0ms ÷ 60000 ms.
- Boolean link between virtual inputs and outputs shall be possible, not only to be assigned to physical I/O.
- Programming must be in a CFC, ST or LD language.

	GLOBAL STANDARD	Page 105 of 134
	Protection and control device for MV substation – RGDM control unit	GSTP011 Rev. 01 26/07/2019

9.7.2 Disturbance Recording (Oscilloperturbography)

The RGDM must have a Disturbance Recording function that allows the storage of fault-related events in a circular memory of, at least, 1000s.

The sampling frequency of the analog and digital quantities requested in paragraph 6.2.3, allows the processing of signals up to 2.5 kHz by applying an anti-aliasing filter; a resolution of 1ms is required for the logic channels.

The RGDM device must be able to record the following signals in COMTRADE format:

- a. All the instantaneous analogue inputs (v4, v8, v12, i4, i8, i12, 3vo and 3io).
- b. The quantities calculated (in relation to the basic).
- c. The digital Input and Output statuses (all physical, starts, and activations), minimum number = 100.

A record in COMTRADE format must be kept of the driving currents of the circuit-breaker control coils (opening and closing) and a minimum of 10 records of each command must be stored in a circular buffer.

The reconstructed quantities, 3vo and 3io, must guarantee a correct phase relation with the source signals (v4, v8, v12 and i4, i8, i12) in order to allow off-line analysis of transient phenomena. The harmonic content of the 3vo and 3io signals must replicate that of the source signals.

Various solutions are provided for starting recordings, beginning from the intentional request made via software. It must be possible to activate recordings by virtual inputs enabled on IEC61850, via enabled physical inputs, via enabled PLC logic states, and by means of state triggers for the protections enabled. Especially for the latter, it will be possible to record events when enabled start-up thresholds are exceeded, and if the enabled thresholds are triggered.

The recording must last until the last triggering signal releases plus configurable (via SW) post-trigger and pre-trigger times. The recording must never exceed the maximum time configured via software.

The total time of the recording is equal to the sum of the:

- d. Pre-fault recording (duration configurable via software [0 ÷ 2000 ms]),
- e. Recording of the disturbance event (duration configurable via software [0 ÷ 70 s]),
- f. Post-trigger recording (duration configurable via software [0 ÷ 2000 ms]).

In any case the recording must last until the last configured trigger has released, which must happen inside the maximum limits set in the configuration.

Records storage: minimum 48 hours with loss of power supply.

In the case of the maximum fault duration (1s pre + 60s post) the minimum number of recordings must be 10. The number of recordings in the case of short duration faults, must guarantee a total of at least 600 sec saved in the device.

The non volatile memory must be managed in a circular manner.

The event that **triggers** recording, enabled via software, must not interfere with the device's protection and automation functions. Similarly, also queuing of a number of recordings to be saved in the non volatile memory, must guarantee correct functioning of the device, and the absence of voids in the events recorded.

The events recording logic will be as follows:

The **post_trigger** must be activated when a trigger event occurs (OR all the triggers activated), giving rise to a recording duration that is the same as the duration of the event, plus the **pre_trigger** time, up to the maximum set for a single recording.

A single recording must indicate, on the same temporal diagram: instantaneous values, calculated values (every 5 ms), and digital values (every 5 ms). The resolution must be at least 64 samples for period.

This data must be saved without being compressed, in COMTRADE 1999 and 2013 format.

	GLOBAL STANDARD	Page 106 of 134
	Protection and control device for MV substation – RGDM control unit	GSTP011 Rev. 01 26/07/2019

The records must be accessible using the software provided, via SFTP and via the WebServer using cyber secure protocols.

The duration of the recording must last until the fallout of the last active trigger, and in any case does not exceed the maximum recording time set.

When the trigger expires, the device must record for a time equal to the set post-trigger.

	GLOBAL STANDARD	Page 107 of 134
	Protection and control device for MV substation – RGDM control unit	GSTP011 Rev. 01 26/07/2019

10 RGDM ADVANCED REQUIREMENTS

The requirements for this chapter must be respected just if expressly requested during the procurement process (ref. par. 12.2).

10.1 DNP3 Communication protocol

The DNP3 communication profile must be implemented for enabling straightforward integration of the RGDM into existent SCADA/RTU solutions.

the DNP3 protocol, on Ethernet Port, shall meet the following requirements:

- Level of implementation of the DNP3.0: Level 2
- Transport Layer: TCP/IP
- Binary Input:
 - Time stamp event buffer capacity: 120
 - Time Stamp Accuracy: 1ms
 - Order of points: Sequential and configurable by the user;
- Analog Input:
 - The buffer management method must allow the configuration to only send the last update of the point value or quality. Method also known by:
 - Last Value
 - Most Recent Value
 - One event per point
 - Order of points: Sequential and configurable by the user;
- Control Relay:
 - Order of points: Sequential and configurable by the us;
- Support for the following functions:
 - Confirm
 - Read
 - Write
 - Enable Unsolicited
 - Disable Unsolicited
 - Direct Operate
 - Select Before Operate
 - Delay Measurement
 - Record Current Time
- Support the following controls:
 - Reset Link (Data Link Control)
 - Clear Restart (Request Write IIN1.7)
 - Delay Measurement (Obj 52)

	GLOBAL STANDARD	Page 108 of 134
	Protection and control device for MV substation – RGDM control unit	GSTP011 Rev. 01 26/07/2019

- Write Time Date (Obj 51)
- Support the following general questions:
 - Binary Input All (Obj 1 Var 0)
 - Analog Input All (Obj 30 Var 0)
 - Counter Input All (Obj 20 Var 0)
- Support the following events of questions:
 - Class 1 (Obj 60 Var 2)
 - Class 2 (Obj 60 Var 3)
 - Class 3 (Obj 60 Var 4)
- Support sending events through unsolicited messages;
- It should present mechanisms to deactivate the unsolicited messages after failure to send them;
- Allow configuration of the following parameters for DNP3 configuration:

ITEMS AVAILABLE FOR CONFIGURATION	CONFIGURABLE VALUES
IP Address, Mask, and Gateway	Defined in purchase order
DNP service port on TCP	7000 to 65.000
Equipment DNP Address	1 a 9999
DNP reporting address (SCADA)	1 a 9999
Standard variation for general interrogations of digital inputs	Binary Input With Status (Obj 1 Var 2)
Standard event variation for digital inputs	Binary Input Change With Time (Obj 2 Var 2)
Class Assignment to Digital Input Group	1
Individual noise filter for each digital input (debounce)	0 to 100ms [step 5ms]
Standard variation for general analog input interrogations	Analog Input 16Bits With Flag (Obj 30 Var 2)
Standard event variation for analog inputs	Analog Change 16 Bits Event Without Time (Obj 32 Var 2)
Class Assignment to the analog input group	2
Deadband for each analog input (deadband)	In engineering or gross values
Individual scale for each analog input (Multiplier / Splitter)	0,001 a 1000
Individual zero range for each analog input (suppress zero)	In engineering or gross values
Standard variation for general counter interrogations	Counter Input 32Bits With Flag (Obj 20 Var 1)
Standard event variation for counters	Counter Input Change 32 Bits Event Without Time (Obj 22 Var 1)
Class Assignment to the group of counters	3
Date and time synchronization via protocol	Yes, on request initiated by SCADA
Enable sending unsolicited messages	Yes, with activation and deactivation of the service by SCADA
Enable verification for unsolicited messages	Yes

	GLOBAL STANDARD	Page 109 of 134
	Protection and control device for MV substation – RGDM control unit	GSTP011 Rev. 01 26/07/2019

Time for retransmission of unsolicited messages (Confirmation Timeout)	1 a 30s [step 1s]
Number of unsolicited messages transmission retries	Always 1 a 60 [step 1]
Required amount of events for transmission of an unsolicited message per class	1 a 50 [step 1]
Maximum age of an event for transmission of an unsolicited message per class	0 a 30s [step 100ms]

Providing Information to the Supervisor

The conditioning and mapping of information for digital, analog, counter inputs and controls will be agreed with the supplier according to the need of the site to be installed. The supplier must provide the minimum number of configurable points as follows:

- Digital Input: 40
- Analog Input: 20
- Digital Output: 10
- Counter: 10

10.2 DG Management Functions

The RGDM's distributed generation management functions are specified in GSTP012.

10.3 UPG Function

The RGDM must implement a function to control and manage the generators connected to the MV Network. The characteristics of this function are specified in GSTP012.

	GLOBAL STANDARD	Page 110 of 134
	Protection and control device for MV substation – RGDM control unit	GSTP011 Rev. 01 26/07/2019

11 TESTING AND CERTIFICATIONS

All the requirements from this chapter must be respected. ENEL has the right to ask a prototype for any kind of verification testing. These tests must be performed in the provider factory or third party laboratories (by according to ENEL or relevant standards provision), with no cost participation by ENEL.

The RGDM will be subjected to an ENEL Technical Conformity Assessment (TCA) process, by according to GSCG002, that is intended to verify if the supplied device meets regulatory standards and specifications.

11.1 Overview Technical Conformity Assessment (TCA) Process

The information of this paragraph are only indicative and may change by according with ENEL TCA management; final TCA organization will be discussed during the TCA kick off meeting.

11.1.1 TCA documents

The ENEL technical organization unit in charge of the Technical Conformity Assessment of the RGDM will supervise the technical documentation and the execution of the tests required to receive the “Statement of Conformity”, according to GSCG002 prescriptions.

All the technical documentation required during that process shall be in English or in the local language of ENEL technical organization unit in charge of the TCA.

The TCA documents that shall be delivered include:

- a. Type A documentation (Not confidential documents used for product manufacturing and management from which it is possible to verify the product conformity to all technical specification requirements, directly or indirectly).
- b. Type B documentation (Confidential documents used for product manufacturing and management where all product project details are described, in order to uniquely identify the product object of the TCA). This type of documentation must be delivered **only to the ENEL technical organization unit in charge of the TCA**
- c. TCA dossier (Set of final documents delivered by the Supplier for the TCA)
- d. The supplier shall provide the TCA Dossier on digital support.

11.1.2 Quality

During the TCA, the supplier shall provide the technical documentation listed in ENEL Quality Specification for Electronic Assemblies.

11.1.3 Safety warnings on Plate

The safety warnings required in the plate of the RGDM and its components must be written in the local language of the device destination Countries.

11.1.4 Device tracking

All the RGDM samples shall be provided with a rating plate as specified by ENEL during the procurement process (par.12.2).

11.1.5 Tests required to complete the TCA

This process consists of the following tests cases:

- a. static accuracy/precision tests,
- b. real-world tests cases (in COMTRADE format, supplied by ENEL)
- c. approximately 300 laboratory tests cases.

	GLOBAL STANDARD	Page 111 of 134
	Protection and control device for MV substation – RGDM control unit	GSTP011 Rev. 01 26/07/2019

The manufacturer must have a valid and product specific homologation before he may supply devices to ENEL. In compliance with this technical specification, the manufacturer must satisfactorily pass, within a maximum period of 6 months after contract award, all the tests described in the following sections.

Once these tests have been successfully completed, an approved manufacturer's RGDM will be subject to ad-hoc reception tests.

In addition, ENEL reserves the right to request the repetition of the type tests at any time to ensure that the devices continue to meet the standards achieved by the initial testing and certification programs at the time the contract was awarded.

Type tests will be carried out in Official Laboratories or Laboratories recognized by ENEL, or in the workshops of the manufacturer. ENEL reserves the right to attend any or all of these tests and must be kept informed of the manufacturer's testing programs, schedules and result.

The manufacturer will bear the cost for type tests and for pilot installation tests.

11.1.6 Type Tests list

- a. Compatibility tests with CT-VT approved sensor
- b. Visual examination
- c. Isolation and dielectric strength tests
- d. Checking of all the functions
- e. Checking precision, only at the nominal voltages.
- f. Out-of-range power supply tests
- g. Electromagnetic compatibility tests
- h. Thermal behavior tests
- i. Mechanical compatibility tests
- j. Climate compatibility tests

The supplier must retain all the documentation proving the successful results of the type tests and all data must be made available to ENEL in real time.

At ENEL's discretion, these tests may be completely or partially repeated during the lifetime of the contract as continuing evidence of type conformity.

11.1.7 Acceptance Tests

The acceptance tests are those indicated in Par. 11.1.6 clause b, c, d and e.

The acceptance tests must be carried out using specifically designed and automated test equipment (SCA). Each device must be accompanied by a report stating that all SCA tests have been concluded successfully.

11.1.8 Laying method of sensors with RGDM

The tests can be carried out, with the laying method indicated in Figure 61 according to what is indicated below.

	GLOBAL STANDARD	Page 112 of 134
	Protection and control device for MV substation – RGDM control unit	GSTP011 Rev. 01 26/07/2019

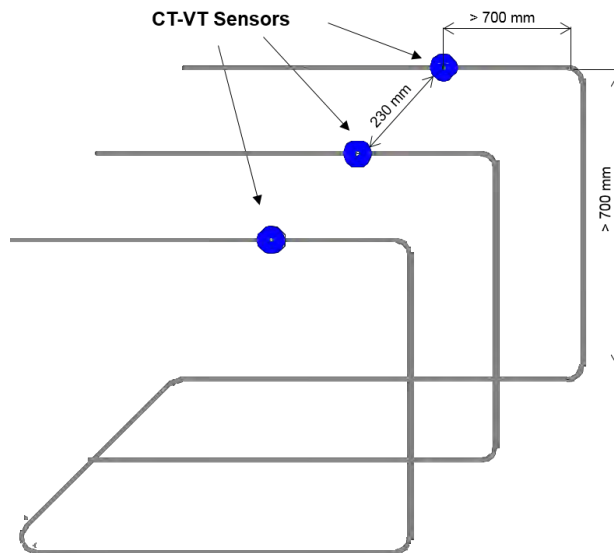

Figure 61 – Laying method of the conductors

The current supply (to be carried out always at the primary of the current sensors) can be obtained by means of multi-turn test circuits (series conductors concatenated with the toroidal sensors) provided that the equivalence of the necessary primary amperes / turns is respected at the different tests.

Examples of possible power modes (current) are shown in Figure 62 and Figure 63. In both proposed configurations, a circuit independent of the “main” circuits that supply only a balanced current provides the residual current component (in reality, only the residual component must be absent, while balanced triads of direct and inverse sequence may be present). This arrangement allows the currents to be supplied to the device under test with the precision required for the different functional checks described below.

In the first case (Figure 60) reference is made to test methods using the test box, through circuits consisting of an appropriate number of turns. The power supply of the balanced triad is obtained by imposing the current of two phases (with currents at 120 ° to each other) and supplying the third sensor with the common return current ($I_T = -(I_R + I_S)$).

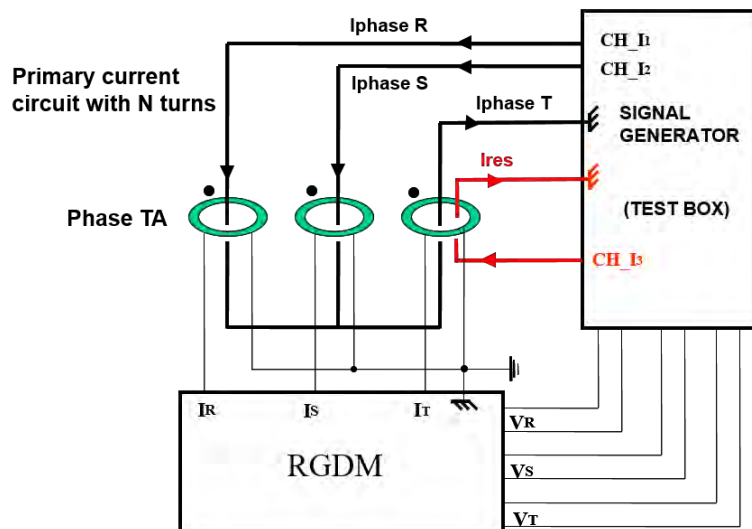

Figure 62 - Example of test circuit for current channels (test box mode).

Observe the orientation of the current sensors with respect to the direction of the primary conductors.

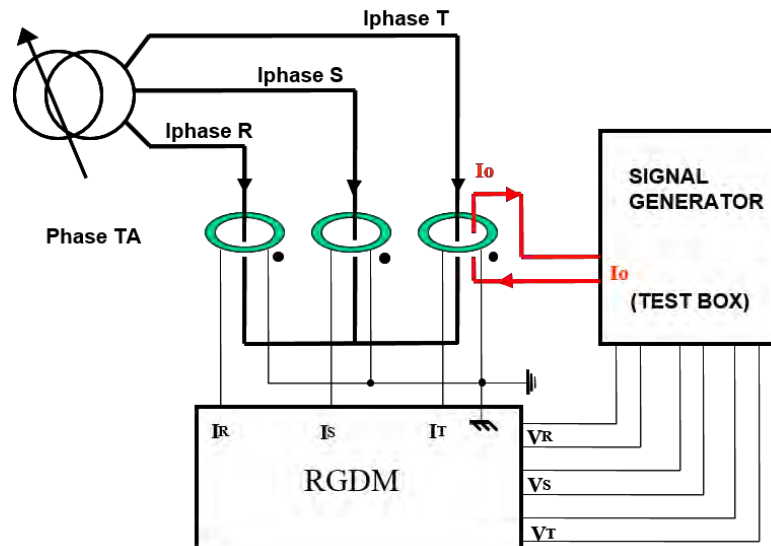

Figure 63 – Example of test circuit for current channels (power transformer method)

Observe that the transformer secondary has a star circuit with neutral isolated from the ground.

The test box to be used must have the following minimum characteristics:

Table 77 – Box test characteristics			
Voltage channels [n] (minimum number and minim voltage)	Single channel power [VA (Ω)] (minimum power)	Module error [%] (maximum error)	Angle error [°] (maximum error)
4 × 125 V	75 VA (210 Ω)	0,05	0,02

Table 78 – Box test characteristics			
Current channels [n] (minimum number and minim voltage)	Single channel power [VA (Ω)] (minimum power)	Module error [%] (maximum error)	Angle error [°] (maximum error)
6 × 12,5 A	80 VA (1,1 Ω a 8,5A)	0,05	0,02

11.1.9 Visual inspection

It is mandatory to verify the absence of visible manufacturing defects, the highest build-quality and precision of manufacture, the compliance of the enclosure dimensions with those indicated in the present specification, as well as the required degree of IP protection.

With the exception of the point at which the field cables are inserted, the entire metal container must have a protection level of IP30, and must prevent the penetration of water dripping from above.

The presence of documentation enclosed with the device and the absence of visible defects must be checked during acceptance testing.

	GLOBAL STANDARD	Page 114 of 134
	Protection and control device for MV substation – RGDM control unit	GSTP011 Rev. 01 26/07/2019

11.1.10 Isolation and dielectric strength tests

The purpose of the tests is to verify the dielectric strength of the RGDM ST.

In addition, the dielectric strength of the electronic card must be verified according to what is prescribed below.

Each test must be performed by applying the voltage (of a value corresponding to the level specified for each circuit) between each of the following three circuits and the other two connected to ground:

- a. voltage inputs (level 3)
- b. current inputs (level 3 applied to the primary current transducers)
- c. remote signal outputs and 24 Vdc power supply (level 3).

The tests prescribed are all those cited below.

- impulse seal test;
- dielectric strength test;
- measurement of the insulation resistance value;

Table 79 – Isolation and dielectric strength tests				
N°	Description	Standard	Class	Level
1	Dielectric strength (50Hz)	IEC 60255-27	4(*)	2kV CM
2	Isolation resistance (500V)	IEC 60255-27	3	> 100 Mohm

(*): The isolation class for open relay contacts is level 3, and for remote measurement (Icc) is level 2.

The presence of filter capacitors to earth results in the application of strength tests at a direct voltage of an equivalent value. In particular, the amplitude and duration will be:

- a. Class 4 = $\sqrt{2} \times 2\text{kV AC} = 2.8\text{kV DC}$ for 60s
- b. Class 3 = $\sqrt{2} \times 1\text{kV AC} = 1.4\text{kV DC}$ for 60s
- c. Class 2 = $\sqrt{2} \times 0.5\text{kV AC} = 0.7\text{kV DC}$ for 60s

The circuit groupings for common isolation are as follows:

G.	TYPE	CIRCUIT TERMINALS FOR TESTS IN COMMON MODE
1	24 Vdc power supply Inputs from the field Relay outputs to the field	MU-1, MU-2, MU-3, MU-4, MU-5, MI-1, MI-2, MI-3, MI-4, MI-5, MI-6, MI-7, MI-8, MI-9, MI-10, MI-11, MI-12, MI-13, MB-1, MB-2, MB-3, MB-5, MB-8, MB-9, MB-10
2	Icc remote measurement	MB4, MB7 (along with auxiliary power supply for the CT-VT)
3	Measurement inputs with earth-related potential	LC-1, LC-2, PE (along with the RJ45 shield for measurements L1, L2, L3)

If referred to the respective groups, the auxiliary power supply for the CT-VTs and the RJ45 measurement screens, must not be connected to the test stimulator.

The circuit groupings for checking between open relay contacts, are as follows:

G.	TYPE	CIRCUIT TERMINALS
1a	Command relays:	MI-10, MI-11
1b	Signalling relays:	MB-2, MB-3, MB-5

	GLOBAL STANDARD	Page 115 of 134
	Protection and control device for MV substation – RGDM control unit	GSTP011 Rev. 01 26/07/2019

The impulse withstand test is not done, as it is replaced by the more demanding, SURGE test.

11.1.11 Out-of-limit Power Supply Tests

It must be verified that all the functions of the RGDM ST are inhibited by supplying the device with the values of the supply voltage that do not guarantee correct operation.

11.1.12 Electromagnetic Compatibility Tests

The purpose of the tests is to verify the correct operation of the RGDM ST subjected to the application of various electromagnetic phenomena.

The tests to be carried out as well as the methods of execution and evaluation of the results must be done, considering that:

- a. the function of the RGDM ST is intended as “protection”;
- b. the installation environment is intended as “MT station”;
- c. the signal port is intended for “local connections”.

The disturbances must be applied on the MA terminal board, with reference to the voltage inputs, and to the current transducers (primary signals) as regards the current inputs.

The procedure for verifying the correct operation of the RGDM during these tests must be agreed with Enel. Criterion for evaluating the individual immunity tests.

The EUT must be configured to detect variations in the 3Io (at effective value related to the basic) and indicate triggers at the maximum current threshold 51N. The trigger set for the 3Io must be 2A for a duration of 1 sec. This threshold corresponds to the minimum settable for the 3Io (1A) plus twice the resolution accepted (0.5A).

The duration time required is half the time that must be set for the RF immunity scans.

The sensitivity criterion provides for using the 3Io as the most critical quantity.

This set-up called for the use of three passive smart termination sensors, connected to the EUT.

The set-up for the current channels, called for Rogowsky sensors, with a ratio of 1000A : 100mV.

Any 51N trigger prejudices the successful completion of the test.

Since the tests would require the use of primary signals, application of the overlapping of effects principle was established, and checking, in the absence of a signal, of the maximum degree of variation in the critical reference measurement (3Io). The signal ports are taken to be “local connections”. The means for checking correct functioning of the RGDM during these tests must, in any case, be approved by ENEL.

11.1.13 Thermal behavior tests

The thermal map of the RGDM fed with the maximum values of the nominal range must be detected; the test must be carried out under the following normal climatic conditions:

- a. temperature: 15 ÷ 35 ° C
- b. atmospheric pressure: 86 ÷ 106 kPa
- c. relative humidity: 45 ÷ 75%

The over temperature values, measured near the individual components, must be used to verify that, at the highest operating temperature, the maximum permissible operating temperature for the components is not exceeded. The thermal map is also used for the definition of the thermal time constant for the temperature variation test.

With the EUTs powered for 1 hour, under reference ambient conditions (about 25°C and 50% RH), analyze the PCBs using a heat-sensitive camera, acquiring thermal images within the visible spectrum.

	GLOBAL STANDARD	Page 116 of 134
	Protection and control device for MV substation – RGDM control unit	GSTP011 Rev. 01 26/07/2019

The purpose of this test is to identify the most critical components for each board, and to record their operating temperatures. Should one or more of the boards be inaccessible, remove them from the EUT and power them separately, waiting 1 hour before taking the images. If a heat-sensitive camera is not available, use a suitable thermometer with a thermocouple, probing (according to a criterion established by the manufacturer and explained in the report) the EUT's most critical components.

At the maximum operating temperature, the hottest component must reach a temperature below or equal to 10°C with respect to its maximum permissible temperature. At the minimum operating temperature, the internal temperature of the device (air) must be higher or equal to 10°C than the test temperature.

11.1.14 Mechanical compatibility tests

The tests are divided into:

- a. sinusoidal vibration immunity tests (working equipment)
- b. resistance tests to transport and handling stresses (equipment not working)

The requirements to be applied are the following:

- c. sinusoidal vibration immunity V.H.3
- d. resistance to transport stresses and handling (test type, large-band random vibrations)

The procedure for verifying the correct operation of the RGDM ST during these tests must be agreed with ENEL.

MECHANICAL									
N°	Description	Standard	Class	Level	Ports being tested				
					Casing	Uaux	Local	Range	Earth
1	Response to vibrations and resistance to vibrations	IEC 60255-21-1 IEC 60068-2-6	1	10-150Hz, 0.5g 1cycle 10-150Hz, 1g 20 cycles	X ⁽¹⁾ X ⁽²⁾				
2	Broad band random vibrations [(m/s ²) ² /Hz]	IEC 60068-2-64	1	5-10Hz, [0.0013] 10-50Hz, [0.02] 50-100Hz, [0.0013]	X ⁽³⁾				

(1): The response test is done with the EUT powered, while the resistance test is done with no power to the EUT.

(2): The transportation test is done in the packaging chosen by the manufacturer for the supply, complete with the 9 m cable for the MB.

For the test with the EUT powered, the same assessment criteria are applied as those used for the immunity tests.

11.1.15 Climate compatibility tests

The reference levels of the individual test groups are as follows:

- a. Tests with powered equipment: level 4

The procedure for verifying the correct operation of the RGDM ST device during these tests must be agreed with ENEL.

	GLOBAL STANDARD	Page 117 of 134
	Protection and control device for MV substation – RGDM control unit	GSTP011 Rev. 01 26/07/2019

CLIMATIC							
N°	Description	Type	Standard	Class	Temperatures	Humidity	Duration
1	Operational EUT	Initial ref. (1)			+25°C	50% R.H.	1 hour
2	Operational EUT	Hot humid (2)	IEC 60068-2-78		+40°C	93% R.H.	96 hours
3	Operational EUT	Hot dry (3)	IEC 60068-2-2		+85°C	20% R.H.	16 hours
4	Operational EUT	Cold (4)	IEC 60068-2-1		-25°C	10% R.H. at temp. > +10°C	16 hours
5	Operational EUT	Variations (5)	IEC 60068-2-14		From -25°C to +70°C	10% R.H. at temp. > +10°C	3 hours
6	Operational EUT	Final ref. (6)			+25°C	50% R.H.	1 hour

(1): When thermal equilibrium is achieved, after about 1 hour, record the EUT's reference measurements, stimulated using a test box at the nominal voltage, current, and phase shift angle values. These will be used to evaluate variations at extreme temperatures.

(2)- (3): The change in temperature must not exceed 0.3°C/minute, whereas the humidity gradient can be set at 1.5%RH/minute. When thermal equilibrium is achieved, after about 1 hour, record the EUT measurements, checking that the quantities have not exceeded the measurement range errors under influential ambient conditions.

(4): The change in temperature must be set at 0.5°C/minute, resulting in a rise of about 3 hours. During the cooling phase, the humidity check may exceed 2.5%RH/minute, up to a limit of +10°C. Below this temperature, the humidity is not checked anymore. When thermal equilibrium is achieved, after about 1 hour, record the EUT measurements, checking that the quantities have not exceeded the measurement range errors under influential ambient conditions.

(5): The change in temperature must be set at 0.5°C/minute. During the heating phase, recommence checking the humidity after +10°C, with a gradient of 2.5%RH/minute. When the upper extreme is achieved, after about 1 hour, record the EUT measurements, checking that the quantities have not exceeded the measurement range errors under influential ambient conditions.

(6): When thermal equilibrium is achieved, after about 1 hour, record the EUT measurements and compare them with the initial reference values, as well as with the relevant errors under nominal conditions. Check correct reinstatement of performance.

Any performance losses in the display at the extreme temperatures are taken to be within the norm, but only if reinstatement of its functions is complete once back within the nominal temperatures (15-35°C).

11.2 Compatibility tests with CT-VT approved sensors

Tests to verify compatibility with CT-VT will be carried out by ENEL laboratories by supplying a suitable number of triples (depends on the sensor technology) of CT-VT with voltages and with primary currents. The frequencies of the applied voltages are indicated below:

- a. 0 Hz,
- b. 50 Hz,
- c. 100 Hz,
- d. 150 Hz,
- e. 250 Hz,
- f. 550 Hz

	GLOBAL STANDARD	Page 118 of 134
	Protection and control device for MV substation – RGDM control unit	GSTP011 Rev. 01 26/07/2019

g. 1000 Hz.

The secondary of the CT-VT must be connected to the electronic board of the RGDM ST during the aforementioned tests. The accuracy will be verified:

- h. On the secondary voltage signal, or
- i. On the secondary current signal proportional to the primary voltage.

11.2.1 CT-VT Voltage sensor

The tests for the verification of the functions (referred to par. 9.3) will be carried out by supplying the RGDM ST electronic card with secondary voltage values made available by the CT-VT sensor, naturally taking

Figure 64 shows the principle diagram to be used for checking the characteristic of the RGDM ST voltage transducer at the various frequencies (for example up to 500-1000 Hz).

The components to be used are:

- a. a relay test box,
- b. 3 MT VTs with ratio to be used as voltage boosters,
- c. a measurement VT
- d. an RGDM ST with which it is possible to visualize the module of the 3 voltages V1, V2, V3 and the relative phase shift

The test consists in expressing a sinusoidal voltage at different frequencies, V1', V2', V3' at the secondary of the VT in order to obtain the rated primary phase voltage.

11.2.2 Verification of the constancy of the module and of the phase as the frequency changes

By varying the voltage V1', V2', V3' in the module (for example with a variation of $\pm 20\%$) the corresponding variation occurs on V1, V2, V3 and on what read by RGDM ST up to 1000 Hz (for example).

By varying the voltage V1', V2', V3' in phase (for example with a variation of $\pm 10^\circ$) the corresponding variation occurs on V1, V2, V3 and on what read by RGDM ST up to 1000 Hz (for example).

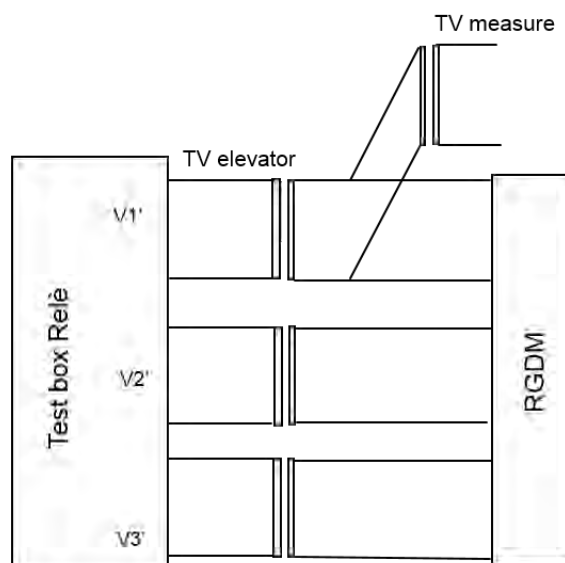



Figure 64 – Test circuit to verify angle error voltmetric transducer

	GLOBAL STANDARD	Page 119 of 134
	Protection and control device for MV substation – RGDM control unit	GSTP011 Rev. 01 26/07/2019

11.3 Checking Of All the Functions

The functional test plan must be drawn up by the supplier and approved by Enel.

Enel reserves the right to carry out all or some of the functional tests.

Regular carrying out of all the functions indicated in these specifications must be carried out by powering the RGDM, complete with all parts, with the electricity supply at its nominal values. A request is made for some tests to be repeated at the extreme values for the electricity supply.

In the case of type tests, the tests must be repeated five times.

11.3.1 Testing detection of the presence / absence of voltage

The threshold check described in par. 9.3.9 must be done on the electronic board only, with a precision of 1% of the thresholds. The tests are only done in the board because the CT-VT sensors are characterized separately.

Behavior in all possible cases must be tested, as the voltage varies on all three phases.

The tests must be repeated at the extreme values for the electricity supply.

11.3.2 Checking the function for detecting a single-phase fault to earth

The threshold check described in par. 9.3.5 must be carried out on the electronic board powered at suitable secondary voltages and in the laying condition described in par. 11.1.8. The tests are done using secondary voltages, because the CT-VT sensors are characterized separately.

The following tests must be done under static conditions (that is, in a sinusoidal regime), for both the 67N.S1 and 67N.S2 regime, in order to determine the activation thresholds and times.

- a. Checking of the residual voltage threshold, with a precision of 1% (implementing a safe activation condition for residual current and offset angle values), equal to twice the current calibration value and the bisector of the activation sector respectively.
- b. Checking of the residual current threshold, with a precision of 1% (implementing a safe activation condition for residual voltage and offset angle values), equal to twice the voltage calibration value and the bisector of the activation sector respectively.
- c. Checking of the angular sector, with and without the inversion signal activated (implementing a safe activation condition for the residual current and residual voltage values, equal to twice the activation calibration value), in order to guarantee an overall error of $\pm 2^\circ$.

In particular:

- d. The checks on the current thresholds must be done:
 - With a symmetrical, balanced triad of currents, with an effective value of 10 - 100 - 360 A, and
 - Creating the value for the residual components required by the individual check on each of the three phase CTs.
- e. The checks on the voltage thresholds must be done:
 - On the secondary, with a symmetrical voltage triad, with a value equivalent to the nominal primary voltage, and
 - Creating the residual voltage component required by the individual check on each of the three voltage input channels.

When checking the 67N.S2 threshold, the safe activation value for the residual voltage must not be higher than 4% in order to avoid superimposition with the 67N.S1 threshold.

	GLOBAL STANDARD	Page 120 of 134
	Protection and control device for MV substation – RGDM control unit	GSTP011 Rev. 01 26/07/2019

Under static conditions (that is, in a sinusoidal regime) the tests must also be carried out that are indicated in Table 80, Table 81 and Table 82 to check the 67N.S1 threshold, and those indicated in Table 83, Table 84 and Table 85 for checking the 67N.S2 threshold.

The tests indicated in Table 80 must be repeated at the extreme values for the electricity supply. The tests described in Table 80, Table 81 and Table 82:

- f. Must be repeated, applying the residual current to all three phases.
- g. Must be repeated, applying the phase currents with a triad of symmetrical but not balanced currents (on only one phase chosen), in order to create a current imbalance of 2 A with a 0° and 180° phase compared to the residual voltage.

The phase current indicated in the following tables must circulate in the three phases by means of a symmetrical, balanced triad.

Table 80 – List of tests to check the 67N.S1 directional earth function					
Calibration for threshold 67N.S1: $60^\circ \leq \alpha \leq 250^\circ$ - $V_0 = 6\%$ - I residual = 1.5 A					
Phase current (A)	Residual voltage		Residual current in the phase (A)		Expected behavior
	Modulus	Phase	Modulus	Phase	
360	6.15%	0	1.55	57°	No trigger
360	6.15%	0	1.55	63°	TS 67 AV
360	6.15%	0	1.55	180°	TS 67 AV
360	6.15%	0	1.55	247°	TS 67 AV
360	6.15%	0	1.55	253°	No trigger
100	6.15%	0	1.55	57°	No trigger
100	6.15%	0	1.55	63°	TS 67 AV
100	6.15%	0	1.55	180°	TS 67 AV
100	6.15%	0	1.55	247°	TS 67 AV
100	6.15%	0	1.55	253°	No trigger
10	6.15%	0	1.55	57°	No trigger
10	6.15%	0	1.55	63°	TS 67 AV
10	6.15%	0	1.55	180°	TS 67 AV
10	6.15%	0	1.55	247°	TS 67 AV
10	6.15%	0	1.55	253°	No trigger

Table 81 – List of tests to check the 67N.S1 directional earth function					
Calibration for threshold 67N.S1: $60^\circ \leq \alpha \leq 250^\circ$ - $V_0 = 6\%$ - I residual = 1.5 A					
Phase current (A)	Residual voltage		Residual current in the phase (A)		Expected behavior
	Modulus	Phase	Modulus	Phase	
360	5.85%	0	1.55	63°	No trigger
360	5.85%	0	1.55	180°	No trigger
360	5.85%	0	1.55	247°	No trigger
100	5.85%	0	1.55	63°	No trigger
100	5.85%	0	1.55	180°	No trigger
100	5.85%	0	1.55	247°	No trigger
10	5.85%	0	1.55	63°	No trigger
10	5.85%	0	1.55	180°	No trigger
10	5.85%	0	1.55	247°	No trigger

Table 82 – List of tests to check the 67N.S1 directional earth function					
Calibration for threshold 67N.S1: $60^\circ \leq \alpha \leq 250^\circ$ - $V_0 = 6\%$ - I residual = 1.5 A					
Phase current (A)	Residual voltage		Residual current in the phase (A)		Expected behavior
	Modulus	Phase	Modulus	Phase	
360	6.15%	0	1.48	63°	No trigger



360	6.15%	0	1.48	180°	No trigger
360	6.15%	0	1.48	247°	No trigger
100	6.15%	0	1.48	63°	No trigger
100	6.15%	0	1.48	180°	No trigger
100	6.15%	0	1.48	247°	No trigger
10	6.15%	0	1.48	63°	No trigger
10	6.15%	0	1.48	180°	No trigger
10	6.15%	0	1.48	247°	No trigger

Table 83 – List of tests to check the 67N.S2 directional earth function

Calibration for threshold 67N.S2: $60^\circ \leq \alpha \leq 120^\circ$ - $V_0 = 2\%$ - I residual = 1.5 A					
Phase current (A)	Residual voltage		Residual current in the phase (A)		Expected behavior
Modulus (*)	Modulus	Phase	Modulus	Phase	
360	2.1%	0	1.55	57°	No trigger
360	2.1%	0	1.55	63°	TS 67 AV
360	2.1%	0	1.55	180°	TS 67 AV
360	2.1%	0	1.55	247°	TS 67 AV
360	2.1%	0	1.55	253°	No trigger
100	2.1%	0	1.55	57°	No trigger
100	2.1%	0	1.55	63°	TS 67 AV
100	2.1%	0	1.55	180°	TS 67 AV
100	2.1%	0	1.55	247°	TS 67 AV
100	2.1%	0	1.55	253°	No trigger
10	2.1%	0	1.55	57°	No trigger
10	2.1%	0	1.55	63°	TS 67 AV
10	2.1%	0	1.55	180°	TS 67 AV
10	2.1%	0	1.55	247°	TS 67 AV
10	2.1%	0	1.55	253°	No trigger

Table 84 – List of tests to check the 67N.S2 directional earth function

Calibration for threshold 67N.S2: $60^\circ \leq \alpha \leq 120^\circ$ - $V_0 = 2\%$ - I residual = 1.5 A					
Phase current (A)	Residual voltage		Residual current in the phase (A)		Expected behavior
Modulus (*)	Modulus	Phase	Modulus	Phase	
360	1.9%	0	1.55	63°	No trigger
360	1.9%	0	1.55	180°	No trigger
360	1.9%	0	1.55	247°	No trigger
100	1.9%	0	1.55	63°	No trigger
100	1.9%	0	1.55	180°	No trigger
100	1.9%	0	1.55	247°	No trigger
10	1.9%	0	1.55	63°	No trigger
10	1.9%	0	1.55	180°	No trigger
10	1.9%	0	1.55	247°	No trigger

Table 85 – List of tests to check the 67N.S2 directional earth function

Calibration for threshold 67N.S2: $60^\circ \leq \alpha \leq 120^\circ$ - $V_0 = 2\%$ - I residual = 1.5 A					
Phase current (A)	Residual voltage		Residual current in the phase (A)		Expected behavior
Modulus (*)	Modulus	Phase	Modulus	Phase	
360	2.1%	0	1.45	63°	No trigger
360	2.1%	0	1.45	180°	No trigger
360	2.1%	0	1.45	247°	No trigger
100	2.1%	0	1.45	63°	No trigger
100	2.1%	0	1.45	180°	No trigger
100	2.1%	0	1.45	247°	No trigger
10	2.1%	0	1.45	63°	No trigger

	GLOBAL STANDARD	Page 122 of 134
	Protection and control device for MV substation – RGDM control unit	GSTP011 Rev. 01 26/07/2019

10	2.1%	0	1.45	180°	No trigger
10	2.1%	0	1.45	247°	No trigger

Finally, an activation test must be done powering the RGDM with:

- h. A sinusoidal residual voltage with an amplitude 10% of the nominal voltage.
- i. A residual current with a component at 50 Hz with a 50 A modulus and 247° phase, in relation to a residual current, with a one way component, with an amplitude of $\sqrt{2} \times 500$ A and time constant of 150 ms.

Under these conditions, check that the RGDM reacts within less than 500ms.

The following tests are aimed at determining the ratios and return times.

11.3.2.1 Return ratio

- a. Residual voltage threshold: from the safe activation conditions (120% of the setting with residual current and staggering angle values equal to twice the current calibration value and the bisector of the activation sector respectively), gradually reduce the residual voltage, until the triggering relay is deactivated.
- b. Residual current threshold: from the safe activation conditions (120% of the setting with residual voltage and staggering angle values equal to twice the voltage calibration value and the bisector of the activation sector respectively), gradually reduce the residual current, until the triggering relay is deactivated.
- c. Angular sector, with and without the inversion signal activated (implementing a safe activation condition for the residual current and residual voltage values, equal to twice the activation calibration value), gradually leave the activation sector, until the trigger relay is deactivated.

11.3.2.2 Return time

- a. Residual voltage threshold: from the safe activation conditions (120% of the setting with residual current and staggering angle values equal to twice the current calibration value and the bisector of the activation sector respectively), reduce the residual voltage in steps, down to 80% of the calibration value.
- b. Residual current threshold: from the safe activation conditions (120% of the setting with residual voltage and staggering angle values equal to twice the voltage calibration value and the bisector of the activation sector respectively), reduce the residual current in steps, down to 80% of the calibration value.
- c. Angular sector: with and without the inversion signal activated (implementing a safe activation condition for the residual current and residual voltage values, equal to twice the activation calibration value), leave the activation sector in steps, with a margin of 5°.

11.3.3 Checking the maximum residual current function

The verification of the thresholds and precisions described in par. 9.3 must be carried out in the laying condition described in par. 11.1.8 and supplying the primary side CT-VT current sensors.

Under static conditions (that is, in a sinusoidal regime) the residual current threshold and activation times must be checked, under the following conditions:

- a. With a symmetrical, balanced triad of currents, with an effective value of 10 - 100 - 360 A.
- b. Creating the residual component required by the individual check on each of the three phase CTs.

In addition, a safe activation test must be carried out with a residual component of 1000 A. This test must be done with a symmetrical, balanced, 10 A triad, and repeated creating the residual component for each of the three phase CTs. The subject of this test is only correct activation of the RGDM.

	GLOBAL STANDARD	Page 123 of 134
	Protection and control device for MV substation – RGDM control unit	GSTP011 Rev. 01 26/07/2019

The tests indicated must be repeated at the extreme values for the electricity supply.

The following tests are aimed at determining the ratios and return times.

11.3.3.1 Return ratio

Residual current threshold: from the safe activation conditions (120% of the calibration), reduce the residual current gradually, until the trigger relay is deactivated.

11.3.3.2 Return time

Residual current threshold: from the safe activation conditions (120% of the calibration), reduce the residual current in steps until 80% of the calibration value.

11.3.4 Checking the maximum phase current function

The check of the thresholds and the intervention times specified in par. 9.3.2 must be carried out in the laying condition described in par.11.1.8.

The tests to check the thresholds must be repeated at the extreme values for the electricity supply. Under static conditions (that is, in a sinusoidal regime) the phase current threshold must be checked, for each of the three CTs.

In addition, the following checks must be done of certain activation at current values:

- a. 1000 A
- b. 2000 A
- c. 9000 A

The subject of this test is only correct activation of the RGDM.

The following tests are aimed at determining the ratios and return times.

11.3.4.1 Return ratio

Maximum current threshold: from the safe activation conditions (120% of the calibration), reduce the current gradually, until the trigger relay is deactivated.

11.3.4.2 Return time

Maximum current threshold: from the safe activation conditions (120% of the calibration), reduce the residual current in steps until 80% of the calibration value.

11.3.5 Transient tests

For the check under transient fault conditions, the RGDM must be powered with voltage and current wave forms obtained from fault simulations. In particular, the transient events related to the following conditions:

- a. Double single-phase fault to earth tests
- b. Closure due to fault tests
- c. Evolutionary fault tests
- d. Intermittent arcs
- e. Impulse test

The tests must be carried out powering the RGDM with voltage signals proportional to the primary fault voltages (assessed on the basis of the level of the analogue signal leaving the CT-VT voltage sensor), and with the primary fault currents, in the laying condition described in par.11.1.8.

The voltage and current signals are provided in COMTRADE format.

A detailed description of the test cases and expected results is provided below.

	GLOBAL STANDARD	Page 124 of 134
	Protection and control device for MV substation – RGDM control unit	GSTP011 Rev. 01 26/07/2019

The purpose of the functional tests is to check that the RGDM being tested conforms to the functional specifications in relation to its capacity to detect transient faults, and the presence/absence of the power supply.

The tests to be carried out relate to recognition of fault phenomena (single-phase to earth with intermittent arcs, double single-phase to earth, evolutionary) and re-closing when a fault occurs, as well as to detect that the power is on, especially when due to opening and closing of the line switch and/or OdM in the Secondary Sub-Station.

The network structure envisaged for the tests, obtained from simulations, is indicated in Figure 65 and constitutes a simplified network scheme that is sufficient for the purposes of the tests themselves.

The system comprises a 20 kV MV network, made of three equivalent lines. The extent of the network in terms of single-phase fault current varies from 100 A to 500A, as the case may be. Unless specified otherwise, the line indicated in Figure 65 as L1 is taken to have a length that makes up about 40% of the entire network (maximum value permitted), whereas the remaining two lines are taken to have a length that corresponds to 10% and 50% of the entire network respectively.

In cases with a compensated network, the scheme has been taken with a coil connected at the star centre of the transformer.

The three-phase short-circuit current at the MV bars is equal to about 10 kA.

The output quantities at the RGDM to be monitored to determine the outcome of the tests described, are the TS67AV, TS51A, and TSPRESV signals.

The tests must be carried out, with the following settings for the RGDM:

- f. For the S1 threshold:
 - A voltage setting of 6% and a residual current value of 2 A.
- g. For the S2 threshold:
 - A voltage setting of 2% and a residual current value of 2 A.

The tests must not be repeated when the inversion signal is active.

11.3.5.1 Double single-phase fault to earth tests

With reference to Figure 65 for the double single-phase fault transients, the following are provided:

- a. Phase voltages, phase currents for line 1.
- b. Phase voltages, phase currents for line 2.

For each transient, this functional test is made up of two parts, carried out with the device powered at the quantities for line 1 and line 2 respectively. The faults are taken as occurring on different phases:

Case	Name	Ires line 1	α 1	Ires line 2	α 2	Test
1	gdomo1	282 A	262.5°	313 A	83°	T
2	gdomo2	173 A	245.5°	200 A	69°	T
3	gdomo3	108 A	242°	134 A	68°	T
4	gdomo4	165 A	71°	138 A	246°	T

The results expected are indicated in the table below (in terms of output triggers and, between brackets, in terms of information that can be deduced from the events recording function).

Case	Name	Fault line 1	Fault line 2
1	gdomo1	trigger TS 51 A (51N)	trigger TS 51 A (51N)
2	gdomo2	trigger TS 51 A (51N)	trigger TS 51 A (51N)
3	gdomo3	trigger TS 67 AV (67S2)	trigger TS 67 AV (67N.S1 & 67N.S2)

	GLOBAL STANDARD	Page 125 of 134
	Protection and control device for MV substation – RGDM control unit	GSTP011 Rev. 01 26/07/2019

4	gdomo4	trigger TS 51 A (51N)	trigger TS 67 AV (67N.S2)
---	--------	-----------------------	---------------------------

11.3.5.2 Tests for closing (and rapid re-closing) for a permanent fault

For the fault-related closing and re-closing transients, the phase voltages and phase currents are provided for the RGDMs in the position indicated in Figure 66.

The simulations done are for the following sequence of fault events: opening of switch “INT_1”, opening of OdM “OdM_1”, re-closing of switch “INT_1”, re-closing (due to fault) of OdM “OdM_2”.

For each transient, the functional tests is made up of 3 parts, set up by powering the device with the currents and voltages related to positions 1, 2 and 3, which correspond to three possible positions of the RGDM in relation to the fault.

Case	Name	Ires pos1	α 1	Ires pos 2	α 2	Ires pos 3	α 3	Test
1	Closing1	50 A	90°	62.5 A	90°	15 A	270°	T
2	Closing2	2.8 A	90°	3.5 A	90°	0.85 A	270°	T
3	Closing3	48.5 A	232°	33 A	206°	26.5 A	270°	T
4	Closing4	4.2 A	232°	2.9 A	206°	2.3 A	270°	T

The results expected are indicated in the table below (in terms of output triggers and, between brackets, in terms of information that can be deduced from the events recording function). The triggers indicated for the RGDMs on the line affected by the fault, must only be activated if a fault occurs.

Case	Name	RGDM (1)	RGDM (2)	RGDM (3)	Test
1	Closing1	2 times TS 67 AV (67S1 & 67S2)	2 times TS 67 AV (67N.S1 & 67N.S2)	No trigger	T
2	Closing2	2 times TS 67 AV (67S1 & 67S2)	2 times TS 67 AV (67N.S1 & 67N.S2)	No trigger	T
3	Closing3	2 times TS 67 AV (67S1)	2 times TS 67 AV (67N.S1)	No trigger	T
4	Closing4	2 times TS 67 AV (67S1)	2 times TS 67 AV (67N.S1)	No trigger	T

11.3.5.3 Evolutionary fault tests

With reference to Figure 65, functioning of the RGDM must be checked in laying conditions (1), when a single-phase fault occurs, that evolves into various types of faults.

The simulations done represent a fault to earth event on the line, taking that, after a certain duration, this “evolves” into a different kind of fault.

Case	Name	Description	Ires line 1	α 1	Test
1	evolutionary1	67->51N (duration 67 : 125 ms)	23 A → 192 A	90°	T
2	evolutionary2	67->51N (duration 67 : 125 ms)	23 A → 521 A phase	90°	T
3	evolutionary3	51N → 67(duration 51N 75 ms)	195 A → 37 A	232°	T
4	evolutionary4	51-> 67 (duration 51 for 30 ms)	530 A phase→ 34 A	233°	T
5	evolutionary5	67-> 51N (duration 67 for 175 ms)	23 A → 192 A	90°	T
6	evolutionary6	67-> 51 (duration 67 for 175 ms)	23 A → 521 A phase	90°	T
7	evolutionary7	51N → 67(duration 51N for 125 ms)	195 A → 38 A	232°	T
8	evolutionary8	51-> 67 (duration 51 for 85 ms)	530 A phase→ 34 A	233°	T

The results expected are indicated in the table below (in terms of output triggers and, between brackets, in terms of information that can be deduced from the events recording function). The times indicated for the second activation (cases 5÷8) are taken from the instant the fault evolves.

Case	Name	Expected behaviour
1	evolutionary1	TS 51A (51N)
2	evolutionary2	TS 51A (51)
3	evolutionary3	TS 67AV (67N.S1)
4	evolutionary4	TS 67AV (67N.S1)
5	evolutionary5	TS 67AV (67N.S1 & 67N.S2) + TS51A (51N) after 80÷120 ms
6	evolutionary6	TS 67AV (67N.S1 & 67N.S2) + TS51A (51) after 40÷80 ms
7	evolutionary7	TS51A (51N) + TS 67AV (67N.S1) after 130÷170 ms
8	evolutionary8	TS51A (51) + TS 67AV (67N.S1) after 130÷170 ms

11.3.5.4 Tests related to intermittent arc simulations

With reference to Figure 65, functioning of the RGDM must be checked in laying conditions (1), when an intermittent single-phase fault to earth occurs.

For each transient, this functional test is made up of two parts, carried out with the device powered at the quantities for line 1 and line 2 respectively.

Case	Name	Type of network	Case description	Test
1	arcint1	NI	Arcs for 20 ms, at 80 ms intervals, for a duration of 1 sec.	T
2	arcint2	NI	Arcs for 20 ms, at 130 ms intervals, for a duration of 1 sec.	T
3	arcint3	NC	Arcs for 20 ms, at 80 ms intervals, for a duration of 1 sec.	T
4	arcint4	NC	Arcs for 20 ms, at 130 ms intervals, for a duration of 1 sec.	T
5	arcint5	NC	Arcs for 120 ms, at 80 ms intervals, for a duration of 1 sec.	T
6	arcint6	NC	Arcs for 120 ms, at 130 ms intervals, for a duration of 1 sec.	T

The results expected are indicated in the table below (in terms of output triggers and, between brackets, in terms of information that can be deduced from the events recording function).

Case	Name	Faulty line	Healthy line
1	arcint1	TS 67 AV (67N.S4)	No trigger
2	arcint2	No trigger	No trigger
3	arcint3	TS 67 AV (67N.S4)	No trigger
4	arcint4	No trigger	No trigger
5	arcint5	TS 67 AV (67N.S4)	No trigger
6	arcint6	No trigger	No trigger

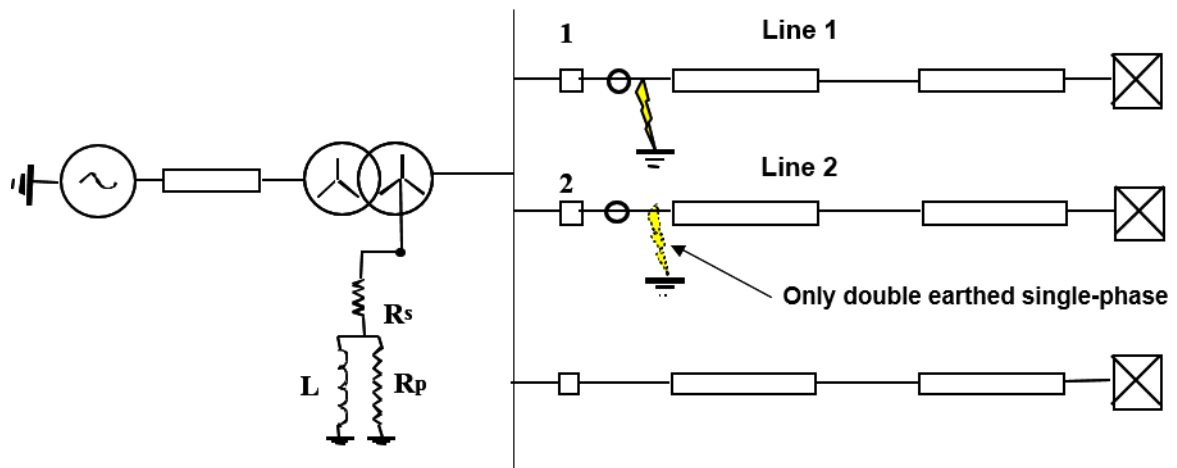

Figure 65 – Reference Network for TEST cases RGDM

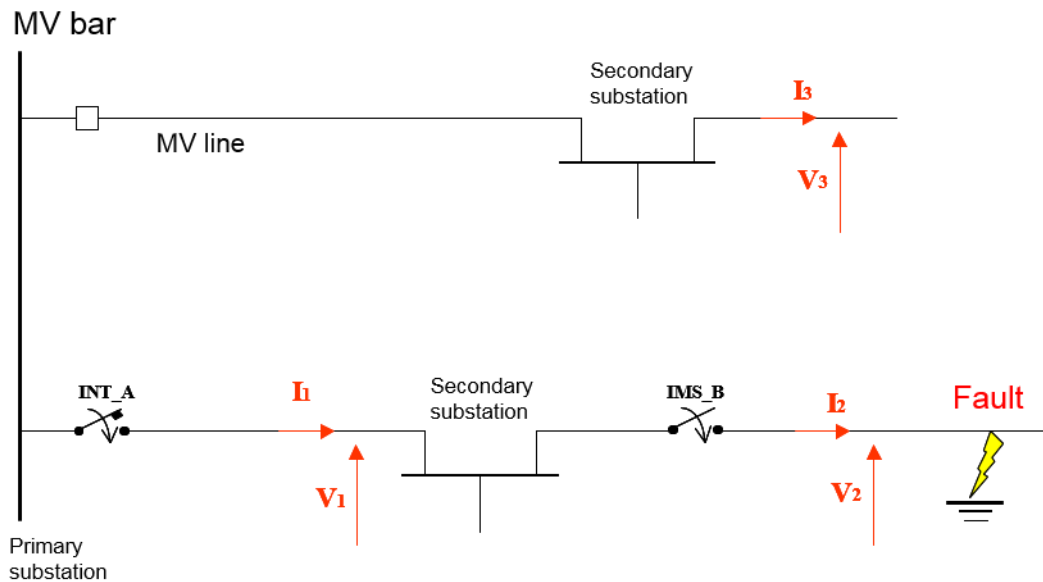

Figure 66 – Cases for closing due to fault

11.3.5.5 Impulse test

An impulse response test must be performed by the RGDM as described below. The impulse tests must have the following characteristics:

- Analogue current Input 20 A (secondary signal coming from the CT sensor Rogowsky)
- Duration of the impulse: 1ms, 2 ms, 4ms and 8 ms.

Examples of the test are shown in the following figures.

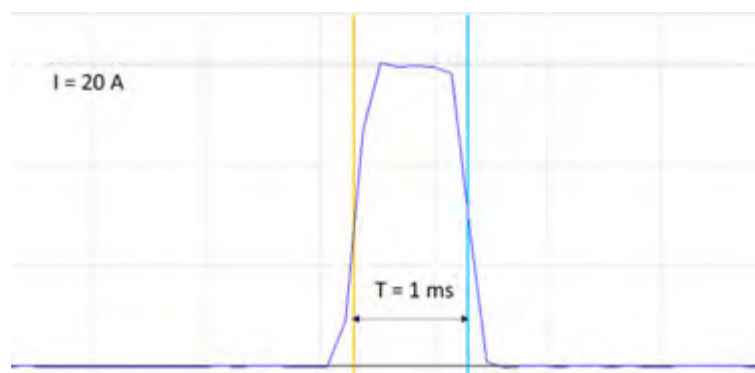

Figure 67 – Impulse test, $T = 1 \text{ ms}$

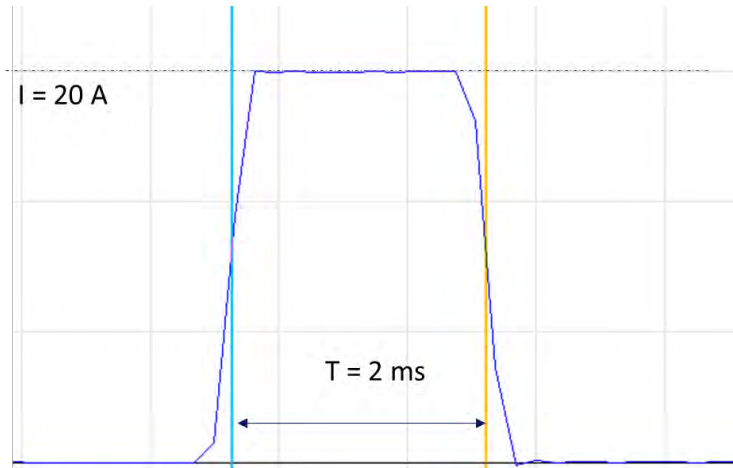

Figure 68 – Impulse test, T = 2 ms

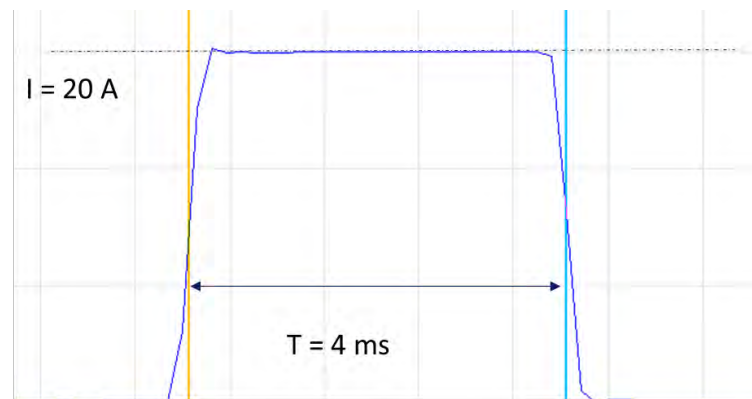

Figure 69 – Impulse test, T = 4 ms

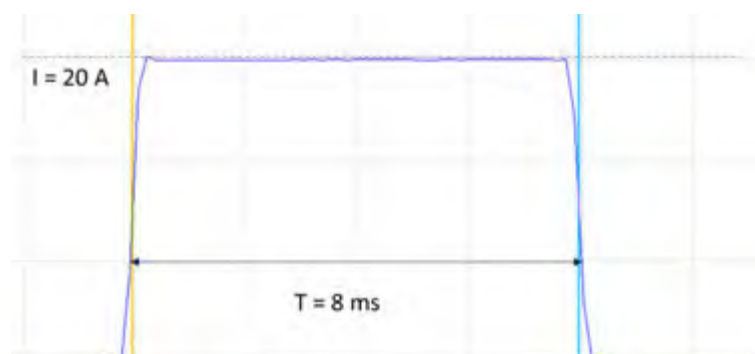



Figure 70 – Impulse test, T = 8 ms

11.3.6 Checking the measurement function

For checking the active and reactive power and phase voltage measurement function, the RGDM must be subjected to the tests listed in Table 86, with the RGDM powered at the secondary and primary voltages. The secondary power supply voltages must be such that a reference is obtained for calculating the active and reactive power at the primary voltage of 20 kV.

	GLOBAL STANDARD	Page 129 of 134
	Protection and control device for MV substation – RGDM control unit	GSTP011 Rev. 01 26/07/2019

Test n°	I		P (kW)	Q (kVAR)
	modulus (A)	phase (°)		
1	50	0.0	1732.051	0
2	50	36.9	1385.094	1039.958
3	50	-25.8	1559.398	-753.842
4	200	0.0	6928.203	0
5	200	36.9	5540.378	4159.833
6	200	-25.8	6237.591	-3015.37
4	360	0.0	12470.77	0
5	360	36.9	9972.68	7487.7
6	360	-25.8	11227.66	-5427.67

The error allowed when calculating the active and reactive power under the test conditions described above, must be less than 1%.

11.3.7 Checking continuous voltage compensation

To check the continuous voltage compensation, the RGDM must be subjected to the tests listed in Table 87:

- c. setting the 67N.S1 threshold with:
 - V_0 secondary 6 V
 - I_0 primary 5 A
 - Activation sector $60^\circ \leq \alpha \leq 250^\circ$
- d. Providing for 5 sec the value of V_{0pre} and a residual current of 1 A primary and phase of 0° ;
- e. Providing the value of V_{0pre} in steps for 5 sec and a residual current of 10 A primary and phase of 0° ;
- f. Checking the 67N.S1 trigger, with the activation time provided for, or the absence of said trigger.

Test n°	V_{0pre}		V_{0post}		Trigger 67.S1
	Modulus (V)	Phase (°)	Modulus (V)	Phase (°)	
1	3.6	90	7.5	-28.6	YES
2	3.6	0	3.0	0.0	YES
3	3.6	45	4.8	-32.1	YES
4	3.6	90	6.5	-33.6	NO
5	3.6	0	1.8	0.0	NO
6	3.6	45	3.9	-41.7	NO

11.3.8 Checking continuous current compensation

To check the continuous current compensation, the RGDM must be subjected to the tests listed in Table 88:

- g. setting the 67.S1 threshold with:
 - V_0 secondary 6 V
 - I_0 primary 5 A
 - Activation sector $60^\circ \leq \alpha \leq 250^\circ$
- h. Providing the value of I_{0pre} for 5 sec and a residual voltage of 3.6 V and phase of 0° .

	GLOBAL STANDARD	Page 130 of 134
	Protection and control device for MV substation – RGDM control unit	GSTP011 Rev. 01 26/07/2019

- i. Providing the value of I_{0pre} in steps for 5 sec and a residual voltage of 30 V and phase of 0°.
- j. Checking the 67.S1 trigger, with the activation time provided for, or the absence of said trigger.

Test n°	I_{0pre}		I_{0post}		Trigger 67.S1
	Modulus (A)	Phase (°)	Modulus (A)	Phase (°)	
1	1	90	5.6	10.3	YES
2	1	0	6.5	0.0	YES
3	1	45	6.3	6.5	YES
4	1	90	4.6	12.5	NO
5	1	0	5.5	0.0	NO
6	1	45	5.2	7.8	NO

11.3.9 Checking the performance of the 61850 protocol

The device must also be equipped with propriety Sw for both configuring all the protection and control parameters, and for configuring and managing the 61850 protocol part (creation of CID files).

The tests required are indicated below:

- a. Sending of the CID file from the SW to the device.
- b. Receiving of the CID file by the device.
- c. Sending of the CID file from the TMF 2020 to the device.
- d. Loading of the CID file generated by the TMF 2020 in the SW.
- e. Measuring the reception time for the GOOSE messages related to the generating cause, for example, for 67N protection activation, the times must be measured between the start of a fault event and sending the opening command to the switch, and the related GOOSE that switches the status to protection activated. Once these times have been measured, the difference between them is determined. The maximum admissible difference must not exceed 30 msec.
- f. The test described above is done for a series of 10 protection activations, broken up by 1 second pauses, measuring the times are described above. The time differences must stay below 30 msec.

Enel reserves the right to add further tests to those indicated above, based on its incontestable judgement.

11.4 Pilot installation tests

In a substation chosen by ENEL will be installed one RGDM granted by the manufacturer in order to evaluate its behavior and stability in a real environment.

The manufacturer will configure the device and will collaborate in the commissioning with all the necessary modifications to enable all the required functionalities and completely integrate the RGDM in the substation.

11.5 Individual tests

These tests will consist of the visual checking of:

- a. Terminal blocks for the power supply, Digital Inputs and Outputs, Current and Voltage Inputs, communication ports/channels, etc.. For these tests it will be necessary to provide:
 - a) Photo(s) of the front panel of the device,
 - b) Photo(s) of the rear of the device.

	GLOBAL STANDARD	Page 131 of 134
	Protection and control device for MV substation – RGDM control unit	GSTP011 Rev. 01 26/07/2019

- b. Identification label with the characteristics of the device (including complete model and firmware version).

The device will also be powered on to verify (via its keyboard/display) that the information about its identifying characteristics match those registered in the homologation process.

11.6 Certifications and self-certifications

About the compliance of all the requirements/standards recalled in this GS, a certificate or selfcertificate must be provided.

Regional laws or standards may requires additional certifications or self-certifications.

Certifications and self-certifications must be made according to the relevant standards or laws (including the template format).

	GLOBAL STANDARD	Page 132 of 134
	Protection and control device for MV substation – RGDM control unit	GSTP011 Rev. 01 26/07/2019

12 MISCELLANEOUS

This chapter include further requirements, recommendations and additional information.

12.1 Required documentation

The following documents (in pdf format) must be provided:

- a. RGDM data sheet with snapshots;
- b. installation, operation and maintenance manuals, with instructions on the installation and interfacing procedures;
- c. administrator's manual, for proper integration of RGDM into communication and IT networks (this document should describe any network service the RGDM is supplying);
- d. list of pre-installation checks to ensure that the components have been delivered correctly;
- e. quick installation and set-up guide;
- f. installation and one-wire diagrams (also in DWG/DXF formats);
- g. all software need to RGDM operation;
- h. parts list;
- i. required but not included parts list;
- j. recommended Tool List;
- k. electrical schematics;
- l. mechanical drawings;
- m. spare parts list;
- n. maintenance procedures;
- o. troubleshooting guide;
- p. component specification literature.

This documents must be made according to IEC 61010-1 and they must be approved by ENEL.

A copy of these documentation must be accessible by the RGDM HMI.

12.2 Clarification during procurement process

By summarizing, during the procurement process the following clarification will be provided to the supplier:

- a. Clarification about the type of terminals board (par.6.2.6).
- b. Clarification about device tracking (par.11.1.4).
- d. Clarification for the color codes to be used:
 - Color codes according to the IEC standard (ref. par. 6.1.1)
 - Color codes according to the ANSI standard (green for open button and red for close button).

12.3 Procurement management

The information of this paragraph are only indicative and may change by according with ENEL procurement management; final procurement approach will be issued by entrusted ENEL units.

Within 30 days of receiving the present specification, the manufacturer must send the following documentation, in English, along with the technical proposal:

	GLOBAL STANDARD	Page 133 of 134
	Protection and control device for MV substation – RGDM control unit	GSTP011 Rev. 01 26/07/2019

- a. Dimensions and weight of the RGDM,
- b. General description of functions, functional schema, wiring diagrams, power consumption requirements, errors limit, etc. The description must also include the algorithms used for the treating and filtering signals and the number of samples per cycle,
- c. Photos or detailed drawings of the RGDM,
- d. Lists of references,
- e. Exceptions to this specification,
- f. Instructions for the installation, adjustment and commissioning of the RGDM,
- g. Examples of adjustment and configuration,
- h. Instructions for checking and maintenance.

If the manufacturer fails to provide any or all of the above information within 30 days of receipt of this specification, he will be disqualified as supplier, for ENEL, of the product standardized in this Technical Specification.

12.4 Receipt of material

The information of this paragraph are only indicative and may change by according with ENEL product management; final procurement approach will be issued by entrusted ENEL units.

12.4.1 Reception tests

Part of the process of accepting delivery of a manufacturer's devices will include the proof of having successfully passed previously performed acceptance tests (Par.11.1.7).

Then, the reception tests will be carried out in Official Laboratories or Laboratories accredited by ENEL, or in the workshops of the manufacturer. ENEL reserves the right to attend any or all of these tests and must be kept informed of the manufacturer's testing programs, schedules and results. If the assistance of an ENEL representative is not available, the provisional reception procedure will be conducted when tests protocols are received.

The reception will be deemed as completed once the reception tests have been carried out and the material has been delivered with the associated tests protocols. The tests are the ones mentioned in Par.11.5 and will be performed before any order is delivered; the associated testing protocols will be presented to ENEL for approval. The results obtained in these individual tests must be indicated in a report; every device must be accompanied by this report.

In the event the documentation has undergone modifications with reference to the actual devices delivered, the manufacturer must provide the updated documentation before the reception procedure will be deemed to have been completed.

12.4.2 Warranty

The manufacturer will commit to providing a guarantee of the IEDs for a minimum period of 24 months, which will commence immediately following a successful reception.

The guarantee will be legally binding for any device/component faults and/or defects that occur within the guarantee period: accordingly, the devices and/or components will be replaced. Further, the manufacturer will undertake to continue, free of charge, the software and firmware development and provide the updates to ENEL for the lifetime of the devices.

If during the contract term the manufacturer fails to address in a prompt and timely manner any functional anomalies or defects in the device behavior or manufacture (hardware or firmware), ENEL reserves the

	GLOBAL STANDARD	Page 134 of 134
	Protection and control device for MV substation – RGDM control unit	GSTP011 Rev. 01 26/07/2019

right to block the necessary positions on the contract, staged payments and/or alter the payment schedules as necessary until the anomalies have been resolved to the complete satisfaction of ENEL.