

MARCH 2018

RUSSIA'S MILITARY POSTURE: GROUND FORCES ORDER OF BATTLE



Catherine Harris and Frederick W. Kagan

ISW
INSTITUTE FOR THE
STUDY OF WAR



The background of the entire page is a detailed topographic map, showing contour lines and geographical features in a light tan color. The map is oriented vertically, with the top of the page showing higher elevations and the bottom showing lower elevations. The contour lines are closely spaced in some areas, indicating steeper slopes, and more widely spaced in others, indicating flatter terrain. The map covers the entire page, providing a textured and thematic backdrop for the text.

Catherine Harris and Frederick W. Kagan

RUSSIA'S MILITARY POSTURE:

GROUND FORCES ORDER OF BATTLE

Cover: A soldier in one of the Russian tanks approaching the Russian border holds their national flag as they drive through the northern part of breakaway South Ossetia August 24, 2008. REUTERS/Denis Sinyakov (GEORGIA)

All rights reserved. Printed in the United States of America. No part of this publication may be reproduced or transmitted in any form or by any means, electronic or mechanical, including photocopy, recording, or any information storage or retrieval system, without permission in writing or from the publisher.

©2018 by the Institute for the Study of War.

©2018 by the Critical Threats Project.

Published in 2018 in the United States of America by the Institute for the Study of War and the Critical Threats Project at the American Enterprise Institute.

1400 16th Street NW, Suite 515 | Washington, DC 20036

1789 Massachusetts Avenue, NW | Washington, DC 20036

understandingwar.org

criticalthreats.org

ABOUT THE AUTHORS

CATHERINE HARRIS

Catherine Harris is a Research Analyst on the Russia and Ukraine portfolio at the Institute for the Study of War (ISW). Her work focuses on the Kremlin's global objectives, military capabilities, and ongoing campaigns. She is a graduate of the Hertog War Studies Program. Catherine holds a B.A. in International Relations and Global Studies from the University of Texas at Austin where she also studied the Russian language.

FREDERICK W. KAGAN

Frederick W. Kagan is the Robert H. Malott Chair and director of the Critical Threats Project at the American Enterprise Institute. In 2009, he served in Kabul, Afghanistan on General Stanley McChrystal's strategic assessment team. He returned to Afghanistan in 2010, 2011, and 2012 to conduct research for Generals David Petraeus and John Allen. In July 2011, Chairman of the Joint Chiefs of Staff Admiral Mike Mullen awarded him the Distinguished Public Service Award. Previously an associate professor of military history at West Point, Dr. Kagan has a Ph.D. in Russian and Soviet military history.

ACKNOWLEDGMENTS

The authors would like to thank the incredible combined ISW-CTP teams without whom this report would not have been possible. We would like to extend our sincere appreciation to ISW President Dr. Kimberly Kagan for her endless support. We are especially grateful to current and former ISW interns Sean Jones, Jack Ulses, Brad Hanlon, Oliver Lopez-Gomez, Kirill Abramov, Will Chim and Charles Frattini III for their dedicated research and contribution to this project. We would also like to thank ISW Development Director Nataliya Bugayova, the ISW Russia-Ukraine Team, and former ISW analyst Kathleen Weinberger for their guidance, mentorship, and support. Finally, we would like to thank the operations teams at ISW-CTP particularly Maseh Zarif, Lisa Suchy, Caitlin Forrest, Katie Donnelly, and Caroline Goodson for helping us bring this report to light.

ABOUT THE INSTITUTE

ISW is a non-partisan, non-profit, public policy research organization. ISW advances an informed understanding of military affairs through reliable research, trusted analysis, and innovative education. ISW is committed to improving the nation's ability to execute military operations and respond to emerging threats in order to achieve U.S. strategic objectives.

The Critical Threats Project at the American Enterprise Institute equips policymakers, opinion leaders, and the military and intelligence communities with detailed and objective open-source analysis of America's current and emerging national security challenges. Through daily monitoring, in-depth studies, graphic presentations, private briefings, and public events, the project is a unique resource for those who need to fully understand the nuance and scale of threats to America's security to effectively develop and execute policy.

METHODOLOGY

This order of battle reflects the intended structure and disposition of the Russian ground forces discernible from the open source at the time of publication. The Kremlin is in the midst of restructuring some of its forces. Some of these units are likely in an ongoing transition phase from a former unit name and echelon to the unit name and echelon depicted in this order of battle. The authors developed this order of battle by using open source intelligence to confirm the existence and locations of the Russian conventional ground force units. The authors focused research and analysis on all combat units at the regiment-level echelon and larger, with the exception of a few significant battalion-level units. The authors conducted extensive research to confirm the existence of all maneuver units using Russian and Ukrainian media, individual social media accounts, and crowdsourcing platforms. All maneuver units are multi-sourced from open source data. This order of battle does not include all combat support and combat service units in the Russian ground forces. Some of the combat support and combat service support units in this order of battle do not have multiple sources. These units are single-sourced from *Milkavkaz.com*. This order of battle does not include complete data on the Russian Aerospace Forces, elite Airborne Troops, Special Forces (SPETSNAZ), Russian Navy, Strategic Rocket Forces, or the National Guard of the Russian Federation.

ABOUT OUR TECHNOLOGY PARTNERS

RUSSIA'S MILITARY POSTURE: GROUND FORCES ORDER OF BATTLE

ISW-CTP believes superior strategic insight derives from a fusion of traditional social science research and innovative technological methods. ISW and CTP recognizes that the analyst of the future must be able to process a wide variety of information, ranging from personal interviews and historical artifacts to high volume structured data. ISW and CTP thank its technology partner, Praescient Analytics, for their support in this innovative endeavor. In particular, their technology and implementation assistance has supported creating many maps and graphics.



Praescient Analytics is a Veteran Owned Small Business based in Alexandria, Virginia. Its aim is to revolutionize how the world understands information by empowering its customers with the latest analytic tools and methodologies. Currently, Praescient provides several critical services to our government and commercial clients: training, embedded analysis, platform integration, and product customization.



Neo4j is a highly scalable native graph database that helps organizations build intelligent applications that meet today's evolving connected data challenges including fraud detection, tax evasion, situational awareness, real-time recommendations, master data management, network security, and IT operations. Global organizations like MITRE, Walmart, the World Economic Forum, UBS, Cisco, HP, Adidas, and Lufthansa rely on Neo4j to harness the connections in their data.



Ntrepid enables organizations to safely conduct their online activities. Ntrepid's Passages technology leverages the company's platform and 15-year history protecting the national security community from the world's most sophisticated opponents. From corporate identity management to secure browsing, Ntrepid products facilitate online research and data collection and eliminate the threats that come with having a workforce connected to the Internet.



Linkurious' graph visualization software helps organizations detect and investigate insights hidden in graph data. It is used by government agencies and global companies in anti-money laundering, cyber-security or medical research. Linkurious makes today's complex connected data easy to understand for analysts.

TABLE OF CONTENTS

EXECUTIVE SUMMARY 8

INTRODUCTION 9

FORCE POSTURE12

RECOMMENDATIONS17

APPENDIX A18

APPENDIX B 24

ENDNOTES41

RUSSIA'S MILITARY POSTURE: GROUND FORCES ORDER OF BATTLE

Catherine Harris and Frederick W. Kagan

EXECUTIVE SUMMARY

U.S. leaders and their European allies are unprepared for the ways in which Putin is poised to wage war in Ukraine and the Baltic. The Russian military is well-positioned to launch a conventional war in Ukraine and a hybrid war in the Baltic States, the opposite of what Western leaders seem to be expecting in each theater.

Western leaders are right to be concerned with the threat of a Russian conventional invasion in the Baltic region. Yet the Russian Armed Forces are much better postured for rapid mechanized intervention in Ukraine. Putin has positioned Russia's ground forces around Ukraine in ways which would enable him to accelerate a conventional maneuver war from the north and east with speed, if he desired. Their presence and capability also support Putin's efforts to coerce and cajole Kyiv.

Western leaders are also right to focus on the hybrid warfare tactics the Kremlin has used in Ukraine in the past, including the use of soldiers out of uniform, disinformation campaigns, and the infiltration and commandeering of vigilante groups. The Baltic States, however, are vulnerable to these same tactics. Their vulnerabilities include a disaffected Russian minority, Russia's ever-present cyber and information operations, and domestic law enforcement and intelligence apparatuses unprepared for large-scale destabilization.

U.S. leaders and American partners in Europe should re-evaluate Putin's current military positioning and the weaknesses in Ukraine and the Baltic region that leave these states vulnerable to various forms of attack. They must reconsider what military and non-military tools are required to defend NATO allies and Ukraine against potential Russian aggression in the likeliest forms it could take. Western leaders must then compose an approach to confront the multifarious threats Russia poses in Europe.

KEY FACTS:

- The Kremlin has re-established multiple division headquarters along the Russia-Ukraine border but has not restored any near the Baltics
- There are three mechanized divisions near the Ukrainian border compared to just one airborne division near the Baltic, which would not be optimal for large-scale mechanized offensives
- The Kremlin has deployed ground forces in pairs of regiments co-located under division headquarters along separate-but-converging lines of advance with well-secured rear areas, all within 50 miles of the Ukrainian border
- Soviet and Russian maneuver warfare doctrine supports the pattern of deployments along the Ukrainian border, but not along the Baltic States' borders, for the conduct of rapid, large-scale mechanized operations
- Russian military leadership, practice, and ad hoc deployment along the Baltic borders all suggest Putin is much more likely to pursue a hybrid approach in the Baltic over a conventional mechanized invasion, but is readier to conduct a conventional invasion of Ukraine

INTRODUCTION

U.S. leaders and their European allies are unprepared for the ways in which Putin is poised to wage war in Ukraine and the Baltic. The Russian military is well-positioned to launch a short-notice conventional war in Ukraine and a hybrid war in the Baltic States, the opposite of what Western leaders seem to expect in each theater. NATO leaders increasingly warn of the threat of a conventional invasion of the Baltic States (or even Western Europe).¹ But Russian ground forces are not deployed or organized to initiate a short-notice conventional war in that region. They have, however, redeployed and reorganized since 2014 in a way that would support a rapid mechanized invasion of Ukraine from both north and east, while remaining well-prepared to conduct a hybrid warfare intervention in the Baltics similar to what they did in Ukraine after the Maidan Revolution. The United States and its partners should re-evaluate the most likely Russian courses of action and reconsider the mix of military and non-military tools required to defend NATO allies and Ukraine from potential Russian aggression.

The current Western discourse about Russia's conventional threat to NATO fails to consider the perspective of Russian military planners and the broader Russian context. Several factors shape current Russian military thought. Both President Vladimir Putin and Chief of the Russian General Staff Valeriy Gerasimov prefer to use hybrid warfare rather than conventional invasion to accomplish their aims because of the lower cost and lower risk of escalation hybrid warfare offers. Gerasimov published a well-known article in 2013 laying out this preference and approach, which the Russian military has practiced repeatedly since 2008.² The ostensible justification for Russian intervention, moreover, is the mistreatment of Russian co-nationals in former Soviet states—a justification that lends itself much more naturally to pseudo-insurgency and hybrid intervention than to direct invasion. Russia remains at war with Ukraine, finally, and its military posture shows how central that fact is to its leadership. Approaching the examination of Russian intentions from this framework casts doubt on the likelihood of a short-notice conventional invasion of the Baltics in the short term, but instead highlights a number of worrisome threats and trends for which NATO is not adequately preparing.

Russia remains at war with Ukraine since it illegally annexed Crimea and launched a hybrid-war campaign to gain control of Eastern Ukraine in 2014. Russia conducted an unconventional operation to seize and secure the strategic peninsula of Crimea. This operation was a reaction to the unexpected collapse of the government of Russian puppet Viktor Yanukovich and the sudden exposure of the Russian naval base at Sevastopol to a pro-Western Ukrainian government.³ Putin then deployed a combination of conventional forces and special operators to Eastern Ukraine, having secured Crimea, to undo the results of the Maidan Revolution by means short of full-scale conventional war. This effort proved only partially successful. Russian proxies control a portion of eastern Ukraine. The Ukrainian government in Kyiv remains weak and vulnerable, but is still in the hands of Ukrainians fighting to preserve their independence from Moscow. This ongoing war looms large in the eyes of the senior Russian military leadership. Russia's interests in Ukraine cannot be excluded from consideration in discussions about possible Russian threats to the Baltic States or the rest of NATO.

The deployment and organization of the Russian ground forces presented in this order of battle offers insight into how the General Staff is actually thinking about and preparing for future war.

The Soviet and Russian militaries have historically placed great theoretical emphasis on the problems of properly deploying and organizing forces before a conflict. Soviet military literature on the “initial period of war” is extensive, as is the Soviet corpus of writing about correct organization of forces.⁴ Gerasimov was a tank officer by background and a graduate of the Armed Forces General Staff Military Academy (formerly the Frunze General Staff Academy).⁵ It is inconceivable that he did not have these theories and concerns drilled into him at an early age and throughout his career. He has been Chief of the General Staff since 2012, and has thus overseen all the reorganization and redeployment that has occurred since that time. Those changes, therefore, offer meaningful indications of Gerasimov’s views of the nature of the current and future wars Russia might have to fight.

The Russian Armed Forces is attempting to transform itself into a capable military force optimized for large-scale combat as well as hybrid warfare. Russian officers are learning from experiences in Ukraine. They are cultivating the ability to subsume irregular proxy forces into Russian command-and-control structures in order

to augment the strength and impact of the Russian Armed Forces.⁶ Russia is testing new asymmetric capabilities on the Ukrainian battlefield and in Syria and subsequently incorporating them into conventional force structures.⁷ The Kremlin is simultaneously undertaking a significant effort to reconfigure the Russian Armed Forces to improve management and coordination of forces during wartime. Russia recently resurrected division and corps echelons in the ground forces organizational structure in an effort to relieve Russian commanders of overwhelming responsibilities on a large-scale and fast-paced battlefield. This change likely

Russia is testing new asymmetric capabilities on the Ukrainian battlefield and in Syria and subsequently incorporating them into conventional force structures.

indicates that Russia identified problems with the previous structure while commanding-and-controlling forces in Ukraine and is implementing improvements accordingly.⁸

Gerasimov and Defense Minister Sergei Shoigu are reversing a series of reforms that had reduced Russia’s ability to conduct large scale warfare (either hybrid or conventional) in order to save money. Russia inherited an unsustainable Soviet military structure that manifested in the Russian Armed Forces poor performance in the 2008 invasion of Georgia. The Kremlin deployed a combination of elite airborne troops and conventional ground, air, and naval forces across the Russo-Georgian border to prevent Georgian integration with the West.⁹ Russia subsequently occupied South Ossetia and Abkhazia.¹⁰ These operations demonstrated significant failures that included command-and-control mistakes and logistical catastrophes that served as the basis for a large-scale reform initiative.¹¹

The 2008 global economic downturn also began to pressure the Russian economy, fueling a desire for cost-savings through reform of the bloated and inefficient Soviet-era military structure.

Russian Defense Minister Anatoly Serdyukov introduced comprehensive military reforms during his 2008-2012 tenure to address both the weaknesses evident in the Georgian war and the financial challenges. The Serdyukov reforms sought to transform the massive Soviet-legacy military organization into an agile, combat-ready force able to mobilize quickly and deploy expeditionary forces.¹² Serdyukov set out to decrease the size of the Russian Armed Forces from 1.3 million to 1 million by 2016 and reduce the officer cadre in order to decrease personnel expenses.¹³ He centralized the six preexisting strategic commands into four joint strategic commands: the Western, Southern, Central, and Eastern Military Districts.¹⁴ He flattened the military hierarchy by

eliminating almost all division echelons in the command structure.¹ He then rearranged Russian combat forces into brigade-level units reporting directly to an Army commander for the most part.¹⁵ The Serdyukov Defense Ministry prioritized the increase in the number of separate brigades to function as the primary tactical units.¹⁶ These units were organically equipped with sufficient combat support and combat service support elements to operate in combat without a higher echelon coordinating support.

Headquarters play a vital and under-appreciated role in the conduct of military operations. Often portrayed as useless “tail” taking money away from valuable “tooth” in Western militaries, headquarters can actually be the difference between effective military operations and ugly defeats. A given military commander can only effectively control between three and five direct subordinates as a general rule.¹⁷ Outstanding commanders in history (like Napoleon Bonaparte) have controlled more, but not always successfully (as his failed invasion of Russia demonstrated). The Serdyukov reforms placed many more brigades directly under the control of army and military district commanders than they could have hoped to handle in combat. The elimination of intervening division and corps headquarters saved money, but at the cost of depriving the Russian ground forces of the ability to command and control large-scale operations.

The Russian military establishment resisted and criticized the Serdyukov reforms, providing support for the efforts by Shoigu and Gerasimov to undo them^{II}.¹⁸ The Shoigu-Gerasimov

reforms have restored the division headquarters in many areas, re-establishing in principle the

ability to conduct major military operations.¹⁹ The specific locations at which these headquarters were re-established provide insight into the nature of the war the Russian military thought it would most likely have to conduct. Unsurprisingly, divisions re-emerged on the Russia-Ukraine border as the war with Ukraine has continued.²⁰ It is noteworthy, on the other hand, that no ground forces division headquarters was established in the near vicinity of the Baltics. It is very easy to over-read this fact, of course, since the 76th Airborne Division headquarters remains at Pskov. The posture of the mechanized forces on the Baltic periphery, nevertheless, contrasts sharply with that of those deployed along the Ukrainian border and deserves serious consideration.

An order of battle can only provide by itself insight into the general concepts and intentions of a military. The information and analysis presented below make no effort to determine the actual size of any of the units in the Russian military, either in personnel or equipment. Even knowing those sizes, moreover, would provide limited insight into the actual combat power of the forces, since combat power depends on many factors not discernible

from such data. This report, therefore, makes no effort to evaluate the actual scale of the conventional or hybrid threat the Russian Armed Forces pose to their neighbors. It highlights only the fact that decisions about the disposition and organization of combat forces, especially ground forces, are taken consciously and carefully in all militaries, but especially in the Russian military, and should inform our assessments of the likely intentions of the

Russian high command more than they appear thus far to have done.

The Shoigu-Gerasimov reforms have restored the division headquarters in many areas, re-establishing in principle the ability to conduct major military operations.

I Serdyukov preserved the 18th Machine Gun Artillery Division in the Eastern Military District.

II Commander of the elite Russian Airborne Troops (VDV) Lieutenant-General Vladimir Shamanov refused to implement the Serdyukov reforms and preserved the division-regiment structure in the VDV.

[“VDV: not to reduce but to strengthen”] Interfax. May 27, 2009. <http://www.interfax.ru/russia/81948>; McDermott, Roger. “Russia’s Airborne Forces Await Fresh Reform.” Jamestown Foundation. May 8, 2012. <https://jamestown.org/program/russias-airborne-forces-await-fresh-reform/>

FORCE POSTURE

Russia's Western Military District (WMD) is responsible for confronting NATO and maintaining Russian influence in former Soviet space, with a particular focus on Ukraine and protecting the Russian exclave of Kaliningrad between Poland and Lithuania. The WMD has the most combat units of any military district. It includes the 1st Guards Tank Army and the 20th and 6th Combined-Arms Armies concentrated near Moscow, Saint Petersburg, and the Ukrainian and Belarusian borders respectively. The WMD also commands the Russian ground forces in Transnistria, Moldova ostensibly performing a peace-keeping mission.²¹ The Kremlin leverages this small force to sustain Russian influence in Moldova and threaten the southwestern border of Ukraine. The Kremlin also maintains significant military power in Kaliningrad. Russia recently deployed strategic air and sea weapons platforms to the exclave.²² It aims to maintain sufficient ground forces to defend Kaliningrad in the event of a large-scale war in the European theater and to pose a threat to Lithuania or Poland.

The 20th Combined-Arms Army and its subordinate divisions are likely responsible for supporting Russia's efforts in Ukraine and Belarus. The headquarters of this army moved in 2015 from Nizhny Novgorod (over 480 miles from the nearest border) to Voronezh, roughly 120 miles from Ukraine.²³ This move was likely intended to facilitate logistical and combat support for Russia's ongoing invasion of Eastern Ukraine. The army controls two divisions. The 3rd Motorized Rifle Division is headquartered with one regiment at Boguchar, about 45 miles from the eastern Ukrainian border, and commands two other regiments at Valuiki, fewer than 20 miles from Ukraine. The 144th Motorized Rifle Division generally faces Belarus, with its headquarters and one regiment at Yelnya, about 60 miles from the Belarusian border, and two regiments at Klinty, less than 30

miles from Ukraine. The 20th Combined-Arms Army thus controls six combat regiments within a short drive of Ukraine on axes that could lead rapidly toward Kyiv, Kharkiv, and into Luhansk. The Kremlin could also deploy two mechanized infantry battalions located in Transnistria, Moldova to attack Odessa, Ukraine from the northwest. The four regiments of the 150th Motorized Rifle Division of the 8th Combined-Arms Army at Rostov in the Southern Military District are also 20-30 miles from the Ukrainian border and could readily support still another axis of advance along the northern coast of the Sea of Azov. The separate reconnaissance brigade under the 22nd Corps in Crimea could also push north into central Ukraine to support. These forces together pose a significant conventional threat to Ukraine, disposed under multiple operational-level headquarters that could plan and conduct simultaneous mechanized thrusts along several axes. Such an attack would accord well with Soviet operational art, which emphasizes the imperative of presenting the enemy with multiple dilemmas simultaneously and in sequence.²⁴

The Russian ground forces disposition near the Baltics suggests no such intent to conduct large-scale conventional mechanized operations. The General Staff did not resurrect any division formations in the 6th Combined-Arms Army during the counter-reform effort, although one division headquarters—the 76th Guards Air Assault Division—was never dissolved and remains in Pskov (about 20 miles from Estonia) with its three airborne regiments. The 6th Army includes two separate motorized rifle brigades, one at Luga (about 70 miles from Estonia) and the other at Kamenka (north of St. Petersburg and around 140 miles from Estonia). The Kaliningrad exclave has one motorized rifle regiment, one motorized rifle brigade, and a naval infantry brigade with a corps headquarters about 50 miles from the Lithuanian border.

Russian Armed Forces Deployed Around Ukraine



Key

- Russian Western Military District
- Russian Southern Military District
- ★ Russian-PRO-Russian Separatist
- BSF=Black Sea Fleet

The Russian Armed Forces clearly could concentrate significant combat power against the Baltic States if they chose to, but their forces are not currently well-arrayed for a major short-notice conventional attack. Current dispositions put three motorized rifle brigades, one motorized regiment, and three airborne regiments within close proximity to the Baltic States. These forces could attack along three axes (via northern Estonia, from Pskov toward Latvia or to the north, and from Kaliningrad into Lithuania) if the objective were the reconquest of all three Baltic states at once. Such an attack would leave the Kaliningrad exclave defended only by a naval infantry brigade and expose the two units attacking Lithuania to counter-attacks from their flanks and rear or isolation from their base. The large amount of strategically-important equipment in Kaliningrad makes it very unlikely that the General Staff would risk losing the exclave in this fashion. The command arrangements would leave the maneuver of two separate motorized rifle brigades under the direct control of the 6th Army, the maneuver of one motorized regiment and one motor rifle brigade under the control of the 11th Corps in Kaliningrad—while the 76th Air Assault Division falls under the separate command of the Air Assault Forces—a service distinct from the ground forces.²⁵ The 1st Tank Army near Moscow and elements of the 144th Motorized Rifle Division from the 20th Combined-Arms Army could certainly reinforce, but the command arrangements would be quite muddled—combat elements from as many as three armies and one separate corps could be operating in the area of responsibility of the 6th Combined-Arms Army. The movement of reinforcements from elsewhere in the Western Military District, moreover, would take time, giving NATO advanced warning of what might be coming^{III}.

The Russian Armed Forces could, therefore, conduct a conventional attack on the Baltics, but their posture suggests they are pursuing a hybrid approach. The ground forces deployments around the periphery of Ukraine give an indication of what preparations for a short-notice mechanized invasion might look like—pairs of regiments co-located under distinct headquarters along separate but converging lines of advance with well-secured rear-areas, all within 50 miles of the border. This disposition looks nothing like the ad hocery that would be required for a mechanized invasion of the Baltic States. The air assault division, separate motorized rifle brigades, and heavy SPETSNAZ presence near the Baltics, however, offers a much more suitable platform for hybrid warfare.²⁶ The initial operations in Ukraine were undertaken by SPETSNAZ and air assault forces, supplemented only later by regular motorized rifle units and tank units, and those sparingly.²⁷ The separate brigade near the Estonian border has a robust combat service support structure that would allow it to parcel out its troops and support them individually much better than a regiment functioning as part of a division would be able to do.²⁸ The absence of mechanized division headquarters, moreover, suggests that the General Staff is not contemplating a complex multi-axis conventional advance, which the 76th Air Assault Division headquarters would likely be unsuited to command-and-control.^{IV} That division would be well-suited to oversee a hybrid campaign, however, coordinated with the 6th Combined-Arms Army headquarters just outside of St. Petersburg. For all these reasons, the disposition and organization of Russian ground forces in the Western Military District strongly suggest that the General Staff is thinking about possible conventional warfare in Ukraine, presumably if its hybrid warfare approach

III A major study produced by the RAND Corporation in 2016 played out a variation of this scenario, positing an agglomeration of individual battalions from many brigades across the Western Military District in a few weeks to stage a conventional mechanized attack on the Baltics. The command arrangements involved in any such undertaking would be breathtakingly contorted and in violation of all kinds of basic maneuver warfare principles of Russian and Soviet operational art. The General Staff may think of undertaking this approach, but it is very unlikely.

Shlapak, David A. and Johnson, Michael. "Reinforcing Deterrence on NATO's Eastern Flank." RAND Corporation. 2016. https://www.rand.org/pubs/research_reports/RR1253.html

IV A light infantry division generally prepares and trains for a different kind of operation from that on which a mechanized force focuses. Mechanized units generally think in terms of faster movement over greater distances than do light infantry, and also consider the problems of coordinating all arms (armor, infantry, and artillery) more comprehensively than forces (like airborne troops) that have limited amounts of armor. The 76th could be an exceptional formation with a staff committed to thinking through and preparing for the task of commanding-and-controlling large-scale mechanized warfare, but there is no evidence to suggest that it is—whereas it and its subordinate units have performed well in the traditional tasks and kind of combat for which an airborne unit is well-suited.

fails or it becomes necessary to accelerate Ukraine's defeat, and hybrid war in the Baltics.

Russia's Southern Military District (SMD) is likely responsible for supporting the ongoing war in Ukraine, intimidating Georgia and possibly Turkey, and containing instability in the Caucasus.

The Southern Military District plays an important role in Russia's operations in Ukraine. It would likely share with the Western Military District responsibility for defeating Ukrainian forces in the event of significant escalation, as we have seen. The Russian Defense Ministry announced the creation of the 8th Combined-Arms Army in spring 2017 and established its headquarters in Rostov Oblast less than 70 miles from the Ukraine border.²⁹ The new army is configured to engage in conventional combat operations. It controls one separate motorized rifle brigade and the 150th Motorized Rifle Division with four combat-experienced regiments beneath it (two motorized rifle and two tank). The separate motorized rifle brigade is deployed well to the rear in Volgograd. The SMD commander is also responsible for integrating Russian forces with military proxies in South Ossetia and Abkhazia to expand the reach of the Russian military and sustain sufficient influence over Georgia. The SMD retains a significant presence in the historically unstable North Caucasus region, with two combined-arms armies (the 49th near Stavropol and the 58th in Vladikavkaz). The 49th Combined-Arms Army consists of two motorized rifle brigades and a separate SPETSNAZ regiment in the North Caucasus, which could swing west toward Crimea, northwest toward Rostov and eastern Ukraine, or south into the Caucasus as required. The 58th Combined-Arms Army controls the 42nd Motorized Rifle Division whose three regiments are deployed in ever-problematic Chechnya, as well as separate

The initial operations in Ukraine were undertaken by SPETSNAZ and air assault forces, supplemented only later by regular motorized rifle units and tank units, and those sparingly.

motorized rifle brigades in Vladikavkaz and Dagestan. The Kremlin announced in February 2018

plans to reform these separate motorized brigades into divisions throughout the year.³⁰ The 58th Army also oversees Russia's military base in the disputed territory of South Ossetia whose leadership commands a separate reconnaissance brigade in Russia's North Ossetia. The 58th Army's mission is most likely to threaten Georgia, support operations against Islamist insurgents throughout the region, and provide a rapid and crushing response to any new outbreak of rebellion. These

two armies together, however, currently put nine regiments/brigades in or near the Caucasus—a force strong enough to daunt and possibly attack Georgia or Azerbaijan, or even Turkey if they were concentrated. They could be used in particular to deter hostile action against Russia's ally, Armenia, where a Russian airbase operates with little ground forces cover^V.

The Central Military District (CMD) projects power into Central Asia and protects vital military industrial facilities. It is comprised of two Combined-Arms Armies, the 2nd and the 41st, positioned along the Kazakh border and near the tri-border area of Kazakhstan, China, and Mongolia, respectively. The 41st Combined-Arms Army controls the recently-resurrected 90th Guards Tank Division in Chebarkul, Chelyabinsk Oblast. This division likely serves to protect critical military infrastructure including underground nuclear facilities reported to exist in the Ural Mountains.³¹ The 41st Army also commands maneuver regiments stationed in Tajikistan. The Kremlin disposed one of these regiments near the Afghanistan-Tajikistan border likely in response to increasing concerns of Central Asian militants crossing the border and threatening Russian domestic security. The Central

V Russia's 102nd base in Armenia contains three motor rifle battalions and a tank battalion.

["Southern Military District."]. Milkavkaz. June 6, 2017. <http://milkavkaz.com/index.php/voorujonnie-cili-racii/vo-cv/u-vo>

Military District can also supply reinforcements to the Eastern or the Western Military Districts in the event of a major war in either of these theaters, although the distances are daunting (a thousand miles to the eastern border of Ukraine and 1,200 miles to China). The Kremlin is engaged in an ongoing effort to build out infrastructure and transportation networks within the CMD to fulfill this requirement.³²

The Eastern Military District (EMD) is responsible for protecting Russian security interests along its Chinese and Korean borders in addition to supporting Russian claims to disputed islands in the Pacific Ocean. The Eastern Military District commander oversees four combined-arms armies. Their deployment suggests that the Kremlin identifies the area near the Korean peninsula and Vladivostok as the Asian theater in which it must be prepared to fight a significant conventional war in the near term. The 5th Combined-Arms Army in Ussuriysk, Primorsky Krai, approximately 155 miles away from the Russia-North Korea 10 mile land border, commands four separate motor rifle brigades out of the nine total mechanized brigades in the military district. This army surely also has the responsibility of defending Vladivostok, by far the most important city in Russia's far east, against any possible Chinese attack (although its four brigades stand little chance on their own of stopping the People's Liberation Army). The other combined-arms armies in this district command at most two separate motor rifle brigades each. None is strong

enough to withstand a Chinese attack in force or, in all likelihood, even to mount a meaningful counter-offensive to disrupt a Chinese attack on any of the others. The concentration of forces near Vladivostok places them in a salient exposed to isolation by a Chinese thrust toward the Pacific. It does not appear that the General Staff is seriously considering or preparing for a land war with China (with good reason). The Kremlin is instead managing the Chinese threat by equipping all the missile brigades in the Eastern Military District with nuclear-capable Iskander medium range ballistic missiles.³³ The Kremlin also placed the 68th Corps on the Sakhalin Islands to reinforce its claim to the territory amid ongoing territorial disputes with Japan.³⁴

The Northern Fleet/Arctic District reflects Russia's ambitions to build out and militarize the Arctic region in the long-term. The Russian MoD created this joint strategic command in 2014 and tasked it with protecting Russian interests in the Arctic region.³⁵ The two separate motor rifle brigades under the 14th Corps constitute the primary striking force. The Kremlin retains few conventional ground forces in the Arctic. The Kremlin will likely position these forces to protect key infrastructure such as the joint Chinese-Russian Ice Silk Road project aimed at developing the Northern Sea Route as a shipping route.³⁶ Russia will likely continue to increase the number of ground forces in the Arctic region as such projects progress in the future.

RECOMMENDATIONS

U.S. policymakers must recognize that the Kremlin will not likely deploy conventional forces as its initial form of aggression in the Baltics.

It will rather employ a combination of subversive tactics before it accepts the full costs associated with conventional combat. Russia demonstrated this timing and phasing during the initial irregular invasion of Eastern Ukraine and subsequent deployment of ground units to combat. The flurry of concern over the possibility of a Russian invasion of the Baltics launched by the 2016 RAND study generated a positive initial response—the stationing of mechanized battalions in the Baltic States. But the flurry is reaching a crescendo that threatens to drown out consideration of more likely and more dangerous Russian courses of action that additional conventional deployments in the Baltics would not adequately address.

Gerasimov's writings, Russian practice, and the deployment of Russian forces along the Baltic borders all suggest that Moscow is much more likely to pursue a hybrid-war approach than to launch a conventional mechanized invasion. The Ukraine playbook is available for all to see—Russian propaganda and agents play on disaffected Russian minorities sufficiently to cause unrest; “little green men” out of uniform but drawn from the SPETSNAZ and airborne forces show up in small numbers but with high-end equipment and skills; “volunteers” who are actually drawn from combat units blend into local “insurgent” and vigilante groups, turning them into militias more or less under Moscow’s control; and only at the end, if needed, small numbers of mechanized troops enter to “defend” the “oppressed” Russian minority.

Putin and the General Staff are working hard to create options in all forms of warfare, while continuing to demonstrate a preference for low-cost approaches.

U.S. and NATO mechanized battalions will be insufficient to defend the Baltics against the hybrid threat.

The Baltic States must focus, rather, on addressing the disaffection among their Russian minority, observing and countering Russian cyber and information operations, strengthening their domestic intelligence and law enforcement apparatus, preparing crowd-control and gendarme capabilities, and various other things needed to recognize the earliest signs of an escalation in Russia’s hybrid war and divert or defuse it before it can destabilize the state. The increasing fixation on defending against a conventional invasion is more likely to obstruct than to assist with this effort because it reinforces a natural tendency in any state to want to see the threat as external rather than internal. The measures that would be required to defuse tensions within ethnic Russian minorities would also be politically unpopular in the Baltic States, so displacing the threat to Russian mechanized forces strengthens the arguments for refusing to undertake them.

The focus on a possible conventional invasion of the Baltics, moreover, may blind us to the risks of a conventional invasion of Ukraine and a hybrid invasion of the Baltics. Whereas all the talk about the threat to the Baltics has come to turn on

conventional threats, discussions of Ukraine focus on the hybrid threat. Yet the Russian ground forces are well-positioned to conduct a very short-notice mechanized assault on Ukraine against which Kyiv’s military likely stands little chance—particularly if the conventional invasion were accompanied by an escalation in the hybrid war in Ukraine’s east, a distraction from the direction of Moldova, and Russian-fueled political unrest in Kyiv

itself. The U.S., NATO, and Kyiv must take this conventional threat seriously, yet none of the public discussions about the assistance Ukraine might need have addressed it.

Russian offensive conventional military operations remain unlikely in the near- to mid-term, nevertheless. Russia is a poor country—its economy is roughly the size of Italy's on a bigger population and a vast territory—and conventional warfare is exceedingly expensive. That is why Putin has opted for hybrid warfare whenever possible—it is the manner of fighting best suited to the brilliant poor.

The West would be foolish to over-focus on any one form of possible future war with Russia. Putin and the General Staff are working hard to create options in all forms of warfare, while continuing to demonstrate a preference for low-cost approaches.

Over-investing in conventional deterrence and defense can lead to ignoring hybrid threats that could achieve equally devastating effects. Ignoring the conventional threat, on the other hand, could leave U.S. allies and partners open to rapid decisive thrusts. The U.S. and NATO must compose themselves to a balanced approach to dealing with the multifarious threats posed by Moscow and avoid the oscillations between confidence and fear that have hitherto characterized the discussion of Russian military power.

APPENDIX A

Western Military District

General-Colonel Andrei Valerievich Kartapolov – Saint Petersburg, Leningrad Oblast³⁷

6th Combined Arms Army – General-Major Andrei Vladimirovich Kuzmenko – Agalatovo, Leningrad Oblast³⁸

- 138th Separate Motor Rifle Brigade – Kamenka, Leningrad Oblast³⁹
- 25th Separate Motor Rifle Brigade – Luga, Leningrad Oblast⁴⁰
- 9th Separate Guards Artillery Brigade – Luga, Leningrad Oblast⁴¹
- 5th Anti-aircraft Missile Brigade – Lomonsov, Leningrad Oblast⁴²
- 26th Missile Brigade – Luga, Leningrad Oblast⁴³
- 95th Command Brigade – Gorelovo, Leningrad Oblast
- 132nd Signals Brigade – Agalatovo, Leningrad Oblast

- 51st Logistics Brigade – Saint Petersburg, Leningrad Oblast
- 30th Engineering Regiment – Kerro Village, Leningrad Oblast
- 6th Separate CBRN Regiment – Sapernoje, Leningrad Oblast

20th Guards Combined Arms Army – General-Major Alexander Peryazev – Voronezh, Voronezh Oblast⁴⁴

- 3rd Motor Rifle Division – Boguchar, Voronezh Oblast⁴⁵
 - 752nd Motor Rifle Regiment – Valuiki, Belgorod Oblast⁴⁶
 - 252nd Motor Rifle Regiment – Boguchar, Voronezh Oblast⁴⁷
 - 237th Guards Tank Regiment – Valuiki, Belgorod Oblast⁴⁸
 - 99th Self-propelled Artillery Regiment – Boguchar, Voronezh Oblast⁴⁹
 - 1143rd Anti-aircraft Missile Regiment – Belgorod Oblast⁵⁰
 - 84th Separate Reconnaissance Battalion – Valuiki, Belgorod Oblast⁵¹

- 337th Separate Engineer Battalion – Boguchar, Voronezh Oblast⁵²
 - 692nd Separate Communications Battalion – Valuiki, Belgorod Oblast⁵³
 - 911th Separate Logistics Battalion – Boguchar, Voronezh Oblast⁵⁴
 - 144th Motor Rifle Division – Yelnya, Smolensk Oblast⁵⁵
 - 488th Motor Rifle Regiment – Klinty, Bryansk Oblast⁵⁶
 - 182nd Motor Rifle Regiment – Klinty, Bryansk Oblast⁵⁷
 - 228th Tank Regiment – Yelnya, Smolensk Oblast⁵⁸
 - 856th Self-propelled Artillery Regiment – Pochep, Bryansk Oblast⁵⁹
 - 1259th Anti-aircraft Missile Regiment
 - 1281st Separate Anti-Tank Battalion – Yelnya, Smolensk Oblast⁶⁰
 - 148th Separate Reconnaissance Battalion – Smolensk, Smolensk Oblast
 - 686th Separate Communications Battalion – Smolensk, Smolensk Oblast
 - 295th Separate Logistics Battalion – Yelnya, Smolensk Oblast
 - 448th Missile Brigade – Kursk, Kursk Oblast⁶¹
 - 9th Command Brigade – Voronezh, Voronezh Oblast
- 1st Guards Tank Army – Lieutenant-General Alexei Avdeev – Bakovka and Odintsovo, Moscow Oblast⁶²
- 2nd Guards Motor Rifle Division – Kalininets, Moscow Oblast⁶³
 - 1st Guards Motor Rifle Regiment – Kalininets, Moscow Oblast⁶⁴
 - 15th Guards Motor Rifle Regiment – Kalininets, Moscow Oblast⁶⁵
 - 1st Tank Regiment – Kalininets, Moscow Oblast⁶⁶
 - 147th Guards Self-propelled Artillery Regiment – Kalininets, Moscow Oblast⁶⁷
 - 1117th Anti-aircraft Missile Regiment – Golitsyno, Moscow Oblast⁶⁸
 - 1174th Separate Antitank Battalion – Kalininets, Moscow Oblast⁶⁹
 - 136th Separate Reconnaissance Battalion – Kalininets, Moscow Oblast⁷⁰
 - 211th Separate Engineering Battalion – Kalininets, Moscow Oblast
 - 47th Separate Communications Battalion – Kalininets, Moscow Oblast
 - 1063rd Separate Logistics Battalion – Kalininets, Moscow Oblast
 - 4th Guards Tank Division – Colonel Oleg Tulinov – Naro-Fominsk, Moscow Oblast⁷¹
 - 12th Guards Tank Regiment – Naro-Fominsk, Moscow Oblast⁷²
 - 13th Guards Tank Regiment – Naro-Fominsk, Moscow Oblast⁷³
 - 423rd Motor Rifle Regiment – Naro-Fominsk, Moscow Oblast⁷⁴
 - 275th Self-propelled Artillery Regiment – Naro-Fominsk, Moscow Oblast⁷⁵
 - 49th Anti-aircraft Missile Brigade – Smolensk, Smolensk Oblast⁷⁶
 - 538th Guards Anti-aircraft Missile Regiment – Naro-Fominsk, Moscow Oblast
 - 137th Separate Reconnaissance Battalion – Naro-Fominsk, Moscow Oblast
 - 413th Separate Communications Battalion – Naro-Fominsk, Moscow Oblast
 - 330th Separate Engineering Battalion – Naro-Fominsk, Moscow Oblast
 - 1088th Separate Logistics Battalion – Naro-Fominsk, Moscow Oblast
 - 165th Separate Medical Battalion – Naro-Fominsk, Moscow Oblast
 - 27th Separate Motor Rifle Brigade – Mosrentgen, Moscow Oblast⁷⁷
 - 6th Separate Tank Brigade – Dzerzhinsk, Nizhny Novgorod Oblast⁷⁸
 - 112th Missile Brigade – Shuya, Ivanovo Oblast⁷⁹
 - 288th Artillery Brigade – Mulino, Nizhny Novgorod Oblast⁸⁰
 - 53rd Anti-aircraft Missile Brigade – Marshala Zhukova, Kursk Oblast
 - 96th Separate Reconnaissance Brigade – Sormovo, Nizhny Novgorod Oblast⁸¹
 - 60th Command Intelligence Brigade – Naro-Fominsk, Moscow Oblast
 - 69th Separate Logistics Brigade – Dzerzhinsk, Nizhny Novgorod Oblast

Baltic Sea Fleet – Vice-Admiral Aleksander Mikhailovich Nosatov – Kaliningrad Oblast⁸²

- 11th Army Corps – General Major Yuri Yarovitsky – Kaliningrad, Kaliningrad Oblast⁸³
 - 7th Guards Separate Motor Rifle Regiment – Kaliningrad, Kaliningrad Oblast⁸⁴
 - 79th Guards Separate Motor Rifle Brigade – Gusev, Kaliningrad Oblast⁸⁵
 - 244th Guards Artillery Brigade – Kaliningrad, Kaliningrad Oblast⁸⁶
 - 152nd Guards Missile Brigade – Chernyakhovsk, Kaliningrad Oblast⁸⁷
 - 22nd Anti-Aircraft Missile Regiment – Kaliningrad, Kaliningrad Oblast⁸⁸
- 336th Naval Infantry Brigade – Baltiysk, Kaliningrad Oblast⁸⁹
- 202nd Separate Anti-aircraft Missile Brigade – Naro-Fominsk, Moscow Oblast⁹⁰
- 79th Guards Reactive Artillery Brigade – Tver, Tver Oblast⁹¹
- 45th Artillery Brigade – Tambov, Tambov Oblast⁹²
- Operative Group of the Russian Armed Forces in Transnistria, Moldova – Tiraspol, Transnistria, Moldova⁹³
 - 82nd Motor Rifle Battalion⁹⁴
 - 113th Motor Rifle Battalion⁹⁵
 - 540th Command Battalion

Southern Military District

Colonel-General Aleksandr Dvornikov – Rostov-on-Don, Rostov Oblast⁹⁶

58th Combined Arms Army – General-Major Evgeny Nikiforov – Vladikavkaz, North Ossetia⁹⁷

- 42nd Motor Rifle Division – Major General Sergei Minenkov – Chechnya⁹⁸
 - 70th Guards Motor Rifle Regiment – Shali, Chechnya⁹⁹
 - 71st Guards Motor Rifle Regiment – Kalinovskaya, Chechnya¹⁰⁰

- 291st Guards Motor Rifle Regiment – Borzoi, Chechnya¹⁰¹
- 50th Guards Self-propelled Artillery Regiment – Shali, Chechnya¹⁰²
- 1203rd Anti-aircraft Missile Regiment – Chechnya
- 19th Separate Motor Rifle Brigade – Vladikavkaz, North Ossetia*¹⁰³
- 136th Guards Motor Rifle Brigade – Buynaksk, Dagestan*¹⁰⁴
- 4th Guards Base – Tskhinvali, South Ossetia, Georgia¹⁰⁵
 - 100th Separate Reconnaissance Brigade – Mozdok, North Ossetia¹⁰⁶
 - 12th Missile Brigade – Mozdok, North Ossetia¹⁰⁷
 - 291st Artillery Brigade – Troistkaya, Ingushetia¹⁰⁸
 - 67th Anti-aircraft Missile Brigade – Vladikavkaz, North Ossetia¹⁰⁹

49th Combined Arms Army – General-Major Sergei Mikhailovich Sevrakov – Stavropol, Stavropol Krai¹¹⁰

- 205th Motor Rifle Brigade – Budennovsk, Stavropol Krai¹¹¹
- 34th Separate Motor Rifle Brigade (Mountain) – Storozhevaya, Karachaevo – Cherkess Republic¹¹²
- 25th Separate Spetsnaz Regiment – Stavropol, Stavropol Krai¹¹³
- 227th Artillery Brigade – Maikop, Republic of Adygea¹¹⁴
- 1st Guards Missile Brigade – Molkino, Krasnodar Krai
- 90th Anti-aircraft Missile Brigade – Afipsky, Krasnodar Krai
- 66th Command Brigade – Stavropol, Stavropol Krai¹¹⁵
- 7th Military Base – Gudauta, Abkhazia, Georgia¹¹⁶

8th Combined Arms Army – Major-General Sergei Kuzovlev – Novochechensk, Rostov Oblast¹¹⁷

- 150th Motor Rifle Division – Novochechensk, Rostov Oblast¹¹⁸

* The 19th and 136th Separate Motor Rifle Brigades will be reformed into divisions throughout 2018, according to a Russian MoD source.

- 102nd Motor Rifle Regiment – Persianovka, Rostov Oblast¹¹⁹
- 103rd Motor Rifle Regiment – Kadamovskiy, Rostov Oblast¹²⁰
- 68th Tank Regiment – Persianovka, Rostov Oblast¹²¹
- 163rd Tank Regiment – Kuzminsky, Rostov Oblast¹²²
- 933rd Anti-aircraft Missile Regiment – Millerovo, Rostov Oblast¹²³
- 381st Self-propelled Artillery Regiment – Rostov on Don, Rostov Oblast¹²⁴
- 20th Separate Guards Motor Rifle Brigade – Volgograd, Volgograd Oblast¹²⁵
- 102nd Military Base – Yerevan and Gyumri, Armenia¹²⁶
 - 988th Anti-aircraft Missile Regiment – Gyumri, Armenia¹²⁷
- 439th Guards Reactive Artillery Brigade – Znamensk, Astrakhan Oblast¹²⁸
- 77th Anti-aircraft Missile Brigade – Korenovsk, Kransodar Krai
- 28th Separate RBCN Brigade – Kamyshin, Volgograd Oblast
- 11th Separate Guards Engineering Brigade – Kamensk-Shakhtinsky, Rostov Oblast

Black Sea Fleet – Admiral Aleksandr Viktorovich Vitko – Sevastopol, Crimea, Ukraine¹²⁹

- 22nd Army Corps – Simferopol, Crimea, Ukraine¹³⁰
 - 127th Separate Reconnaissance Brigade – Sevastopol, Crimea, Ukraine¹³¹
 - 15th Separate Coastal Rocket Artillery Brigade – Sevastopol, Crimea, Ukraine¹³²
 - 126th Separate Coastal Defense Brigade – Perevalne, Crimea, Ukraine¹³³
 - 8th Artillery Regiment – Simferopol and Perevalne, Crimea, Ukraine¹³⁴
- 810th Naval Infantry Brigade – Sevastopol, Crimea, Ukraine¹³⁵

Caspian Flotilla – Rear-Admiral Sergei Mihailovich Pinchuk – Astrakhan, Astrakhan Oblast¹³⁶

- 414th Naval Infantry Battalion – Kaspiysk, Republic of Dagestan¹³⁷
- 727th Naval Infantry Battalion – Astrakhan, Astrakhan Oblast¹³⁸

Central Military District

Lieutenant General Alexander Lapin – Yekaterinburg, Sverdlovsk Oblast¹³⁹

2nd Guards Combined Arms Army – Major-General Gennady Zhidko – Samara, Samara Oblast¹⁴⁰

- 30th Separate Motor Rifle Brigade – Roshchinsky, Samara Oblast¹⁴¹
- 15th Separate Motor Rifle Brigade – Roshchinsky, Samara Oblast¹⁴²
- 21st Separate Guards Motor Rifle Brigade – Totskoye, Orenburg Oblast¹⁴³
- 92nd Missile Brigade – Totskoye, Orenburg Oblast¹⁴⁴
- 385th Guards Artillery Brigade – Totskoye, Orenburg Oblast¹⁴⁵
- 950th Reactive Artillery Regiment – Totskoye-2, Orenburg Oblast¹⁴⁶
- 297th Anti-aircraft Missile Brigade – Leonidovka, Penza Oblast¹⁴⁷
- 2nd CBRN Brigade – Samara, Samara Oblast
- 91st Command Brigade – Samara, Samara Oblast
- 71st Communications Brigade – Kalinovka, Samara Oblast
- 105th Separate Logistics Brigade – Samara, Samara Oblast

41st Combined Arms Army – Major-General Aleksei Vladimirovich Zavizon – Novosibirsk, Novosibirsk Oblast¹⁴⁸

- 90th Guards Tank Division – Chebarkul, Chelyabinsk Oblast¹⁴⁹
 - 239th Tank Regiment – Cherbakul, Chelyabinsk Oblast¹⁵⁰
 - 6th Tank Regiment – Cherbakul, Chelyabinsk Oblast¹⁵¹
 - 80th Tank Regiment – Cherbakul, Chelyabinsk Oblast¹⁵²
- 228th Motor Rifle Regiment – Yekaterinburg, Sverdlovsk Oblast¹⁵³
- 400th Self-propelled Artillery Regiment – Cherbakul, Chelyabinsk Oblast
- 33rd Communications Brigade –

Cherbakul, Chelyabinsk Oblast

- 35th Separate Guards Motor Rifle Brigade – Aleisk, Alta Krai¹⁵⁴
- 55th Separate Motor (Mountain) Rifle Brigade– Kyzyl, Tuva Republic¹⁵⁵
- 74th Separate Guards Motor Rifle Brigade – Yurga, Kemerovo Oblast¹⁵⁶
- 201st Military Base – Dushanbe, Tajikistan¹⁵⁷
 - 149th Guards Motor Rifle Regiment – Dushanbe, Tajikistan¹⁵⁸
 - 92nd Motor Rifle Regiment – Dushanbe, Tajikistan¹⁵⁹
 - 191st Separate Motor Rifle Regiment – Qurghonteppa, Tajikistan¹⁶⁰
- 119th Missile Brigade – Elanskiy, Sverdlovsk Oblast¹⁶¹
- 120th Guards Artillery Brigade – Yurga, Kemerovo Oblast¹⁶²
- 61st Anti-aircraft Missile Brigade – Biysk, Altai Krai¹⁶³
- 10th CBRN Regiment – Topchikha, Alta Krai¹⁶⁴
- 35th Command Brigade – Kochenevo, Novosibirsk Oblast¹⁶⁵
- 106th Separate Logistics Brigade – Yurga, Kemerovo Oblast¹⁶⁶
- 28th Anti-aircraft Missile Brigade – Mirny, Kirovsk Oblast¹⁶⁷
- 29th Separate CBRN Brigade – Yekaterinburg, Sverdlovsk Oblast
- 232nd Reactive Artillery Brigade – Shelekhov, Kurgansk Oblast
- 179th Command Brigade – Yekaterinburg, Sverdlovsk Oblast

Eastern Military District

Colonel-General Alexander Zhuravlev – Khabarovsk, Khabarovsk Krai¹⁶⁸

5th Combined Arms Army – Ussuriysk, Primorsky Krai – Lieutenant General Aleksei Nikolaevich Salmin¹⁶⁹

- 70th Separate Guards Motor Rifle Brigade – Barabash, Primorsky Krai¹⁷⁰

- 59th Separate Motor Rifle Brigade – Sergeevka, Primorsky Krai¹⁷¹
- 57th Separate Guards Motor Rifle Brigade – Bikin, Khabarovsk Krai¹⁷²
- 60th Separate Motor Rifle Brigade – Kamen-Rivolov, Primorsky Krai¹⁷³
- 20th Guards Missile Brigade – Spassk-Dalny, Primorsky Krai¹⁷⁴
- 305th Artillery Brigade – Ussuriysk, Primorsky Krai¹⁷⁵
- 8th Anti-aircraft Missile Bridge – Ussuriysk, Primorsky Krai¹⁷⁶
- 25th CBRN Regiment – Sergeevka, Primorsky Krai¹⁷⁷
- 80th Command Brigade – Ussuriysk, Primorsky Krai
- 101st Separate Logistics Brigade – Ussuriysk, Primorsky Krai

35th Combined Arms Army – Major-General Sergei Cherbotaev – Belogorsk, Amur Oblast¹⁷⁸

- 64th Separate Motor Rifle Brigade – Knyaze-Volonskoe, Khabarovsk Krai¹⁷⁹
- 38th Separate Guards Motor Rifle Brigade – Belogorsk, Amur Oblast¹⁸⁰
- 69th Separate Covering Brigade – Babstovo Village, Jewish Autonomous Oblast¹⁸¹
- 71st Anti-aircraft Missile Brigade – Srednebeloye, Amur Oblast¹⁸²
- 107th Missile Brigade – Birobidzhan, Jewish Autonomous Oblast¹⁸³
- 165th Artillery Brigade – Nikosolskoe Village, Amur Oblast¹⁸⁴
- 35th CBRN Regiment – Belogorsk, Amur Oblast¹⁸⁵
- 54th Command Brigade – Belogorsk, Amur Oblast¹⁸⁶
- 103rd Separate Logistics Brigade – Belogorsk, Amur Oblast¹⁸⁷

36th Combined Arms Army – Major-General Mikhail Nosulev – Ulan-Ude, Buryatia Republic¹⁸⁸

- 5th Separate Guards Tank Brigade – Ulan-Ude, Buriyatia¹⁸⁹
- 37th Separate Guards Motor Rifle Brigade – Kyakhta, Buriyatia¹⁹⁰
- 30th Artillery Brigade – Ulan-Ude, Buriyatia¹⁹¹

- 35th Anti-aircraft Missile Brigade – Ulan-Ude, Buriyatia¹⁹²
- 103rd Missile Brigade – Ulan-Ude, Buriyatia¹⁹³
- 26th CRBN Regiment – Onokhoye Village, Buriyatia
- 75th Command Brigade – Sosnovii Bor, Ulan-Ude, Buriyatia¹⁹⁴
- 102nd Separate Logistics Brigade – Sosnovy Bor, Buriyatia¹⁹⁵

29th Combined Arms Army – Major-General Yevgeny Poplavsky – Chita, Zabaykalsky Krai¹⁹⁶

- 36th Separate Guards Motor Rifle Brigade – Borzya, Zabaykalsky Krai¹⁹⁷
- 200th Artillery Brigade – Gorny, Zabaykalsky Krai¹⁹⁸
- 3rd Missile Brigade – Chita, Zabaykalsky Krai¹⁹⁹
- 140th Anti-aircraft Missile Brigade – Domna Village, Zabaykalsky Krai²⁰⁰
- 19th CRBN Regiment – Gorny Village, Zabaykalsky Krai
- 104th Separate Logistics Brigade – Chita, Zabaykalsky Krai²⁰¹

68th Army Corps – Major General Dmitry Glushenkov – Yuzhno-Sakhalinsk, Sakhalin Oblast²⁰²

- 18th Machine Gun Artillery Division – Iturup, Kuril Islands²⁰³
 - 46th Machine Gun Artillery Regiment – Kunashir, Kuril Islands²⁰⁴
 - 49th Machine Gun Artillery Regiment – Iturup, Kuril Islands²⁰⁵
- 39th Separate Motor Rifle Brigade – South Sakhalinsk, Sakhalin Oblast²⁰⁶

Pacific Fleet – Admiral Vladimir Ivanovich Korolev – Vladivostok, Primorsky Krai²⁰⁷

- 155th Separate Naval Infantry Brigade – Vladivostok, Primorsky Krai²⁰⁸
- 40th Separate Naval Infantry Brigade – Petropavlosk-Kamchatskiy, Kamchatka Krai²⁰⁹
- 520th Separate Coastal Missile Artillery Brigade – Petropavlosk-Kamchatskiy, Kamchatka Krai²¹⁰
- 72nd Separate Coastal Missile Regiment – Petropavlosk-Kamchatskiy, Kamchatka Krai

Northern Fleet and Arctic Joint Strategic Command

Vice-Admiral Nikolay Yevmenov – Severomorsk, Murmansk Oblast²¹¹

Northern Fleet – Vice Admiral Nikolay Yevmenov – Severomorsk, Murmansk Oblast²¹²

- 61st Separate Naval Infantry Brigade – Sputnik, Murmansk Oblast²¹³
- 536th Separate Coastal Missile Brigade – Guba Olenya, Murmansk Oblast²¹⁴
- 14th Army Corps – Murmansk, Murmansk Oblast²¹⁵
 - 200th Separate Motor Rifle Brigade – Luostari, Murmansk Oblast²¹⁶
 - 80th Separate Arctic Motor Rifle Brigade – Alakurtti, Murmansk Oblast²¹⁷

APPENDIX B

Russian Military Districts

Northern Fleet and Arctic Joint Strategic Command

Western Military District

Southern Military District

Central Military District



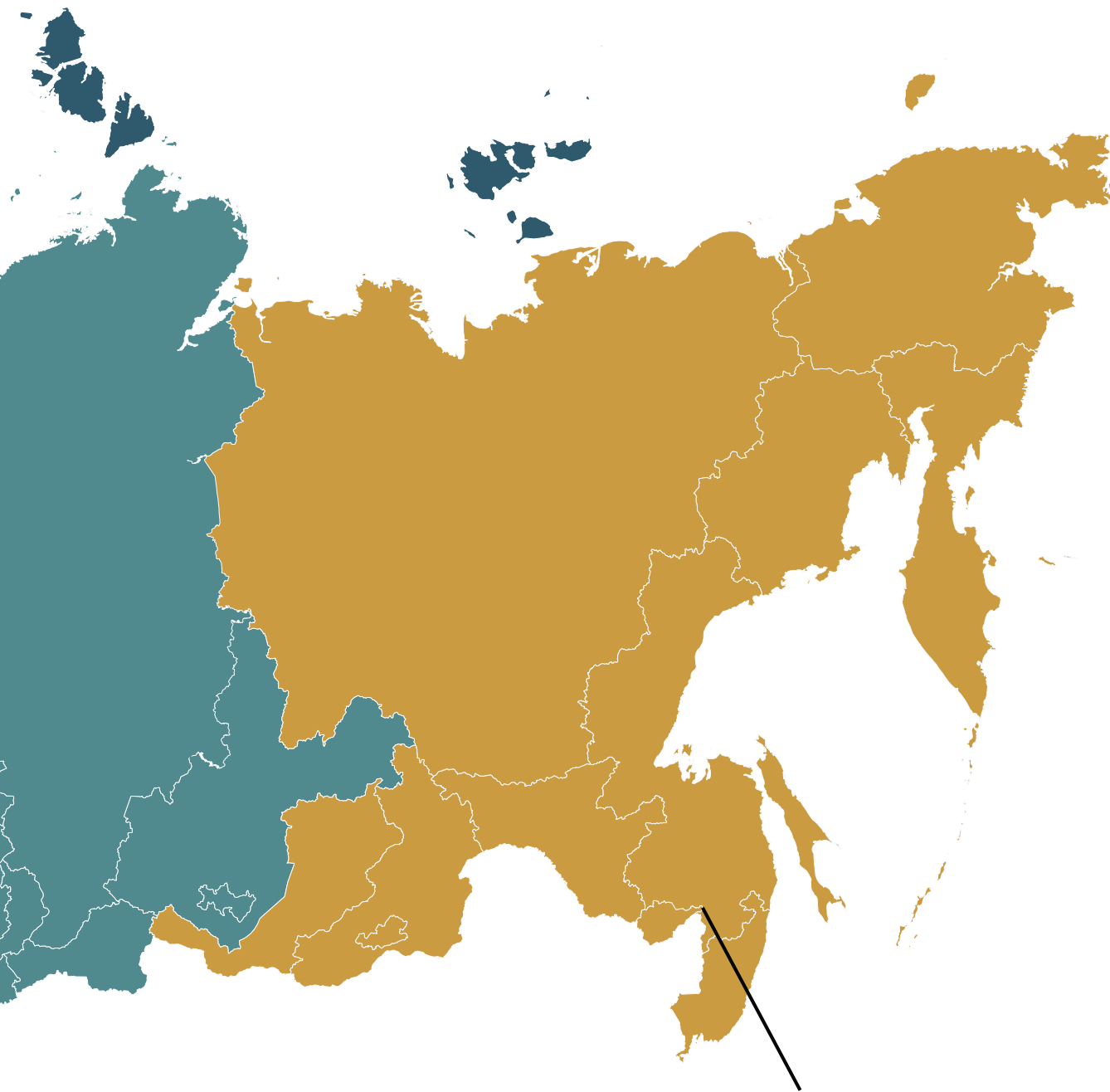

Eastern Military District

Russian Army Headquarters

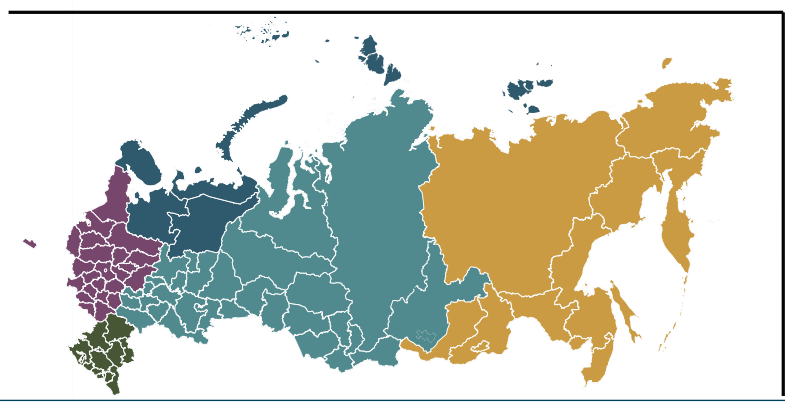
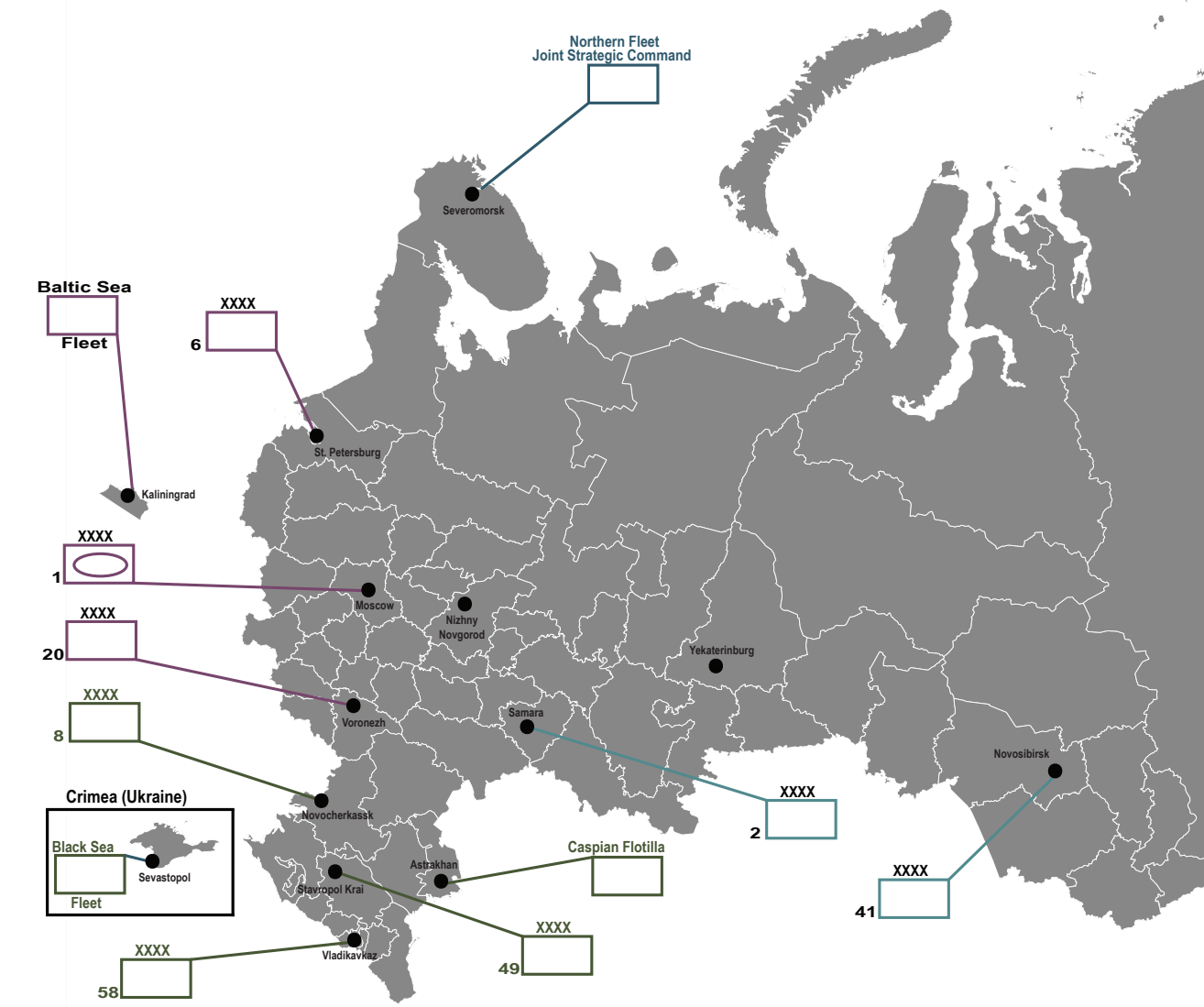



Map © Free Vector Maps.com, with ISW Modifications

Russian Order of Battle

Full Key on Page 40

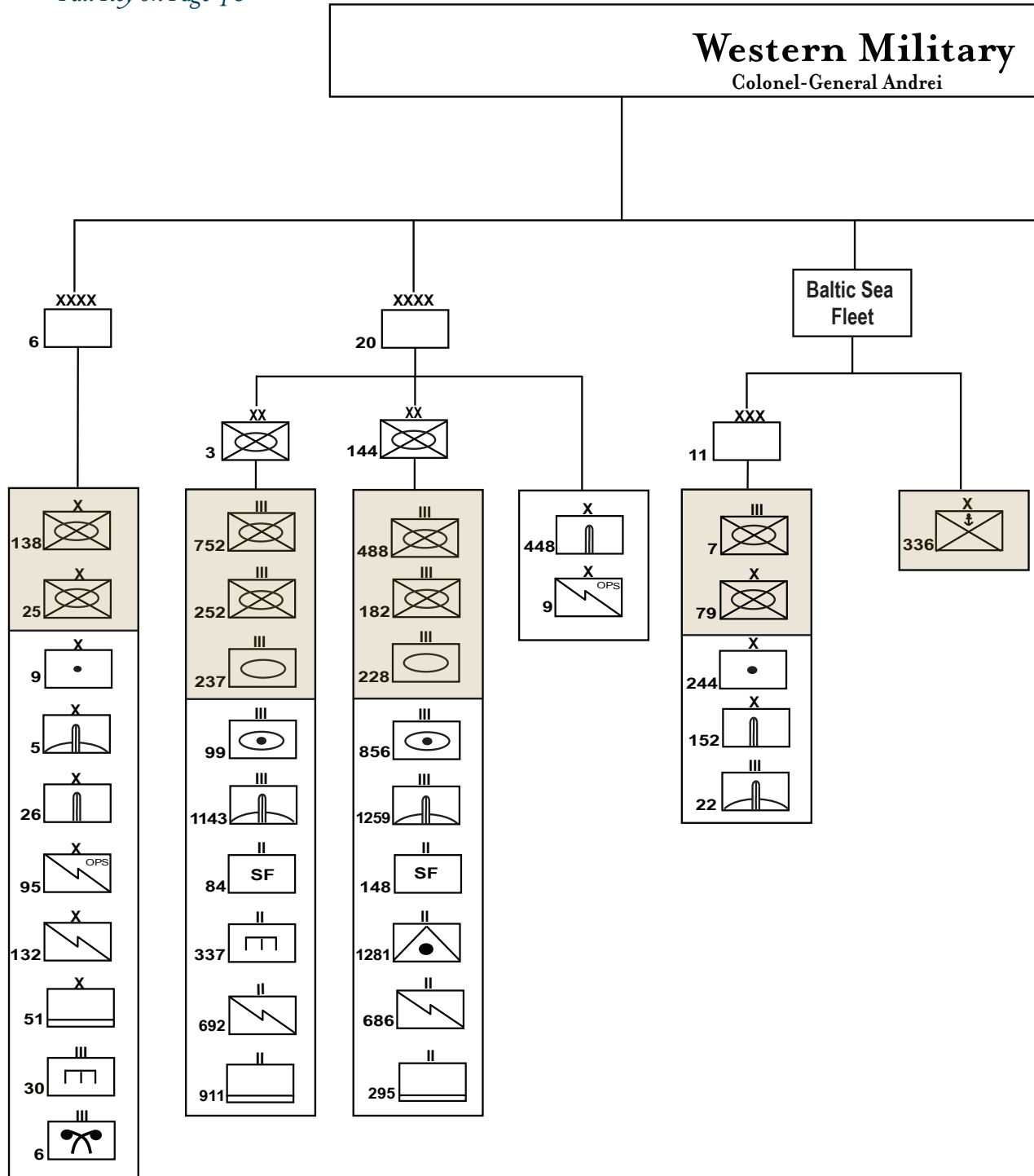

District

Valerievich Kartapolov

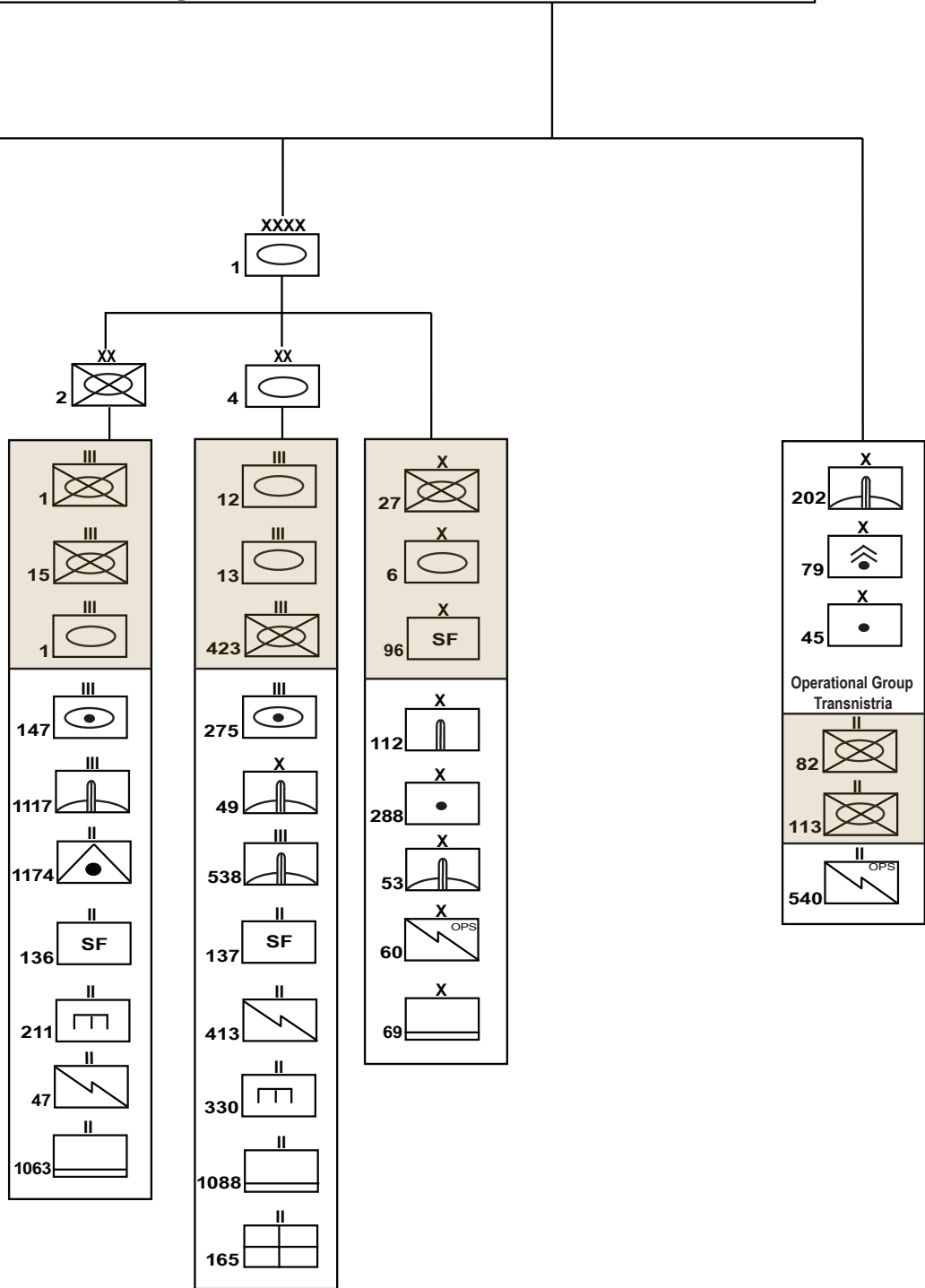

Western Military District

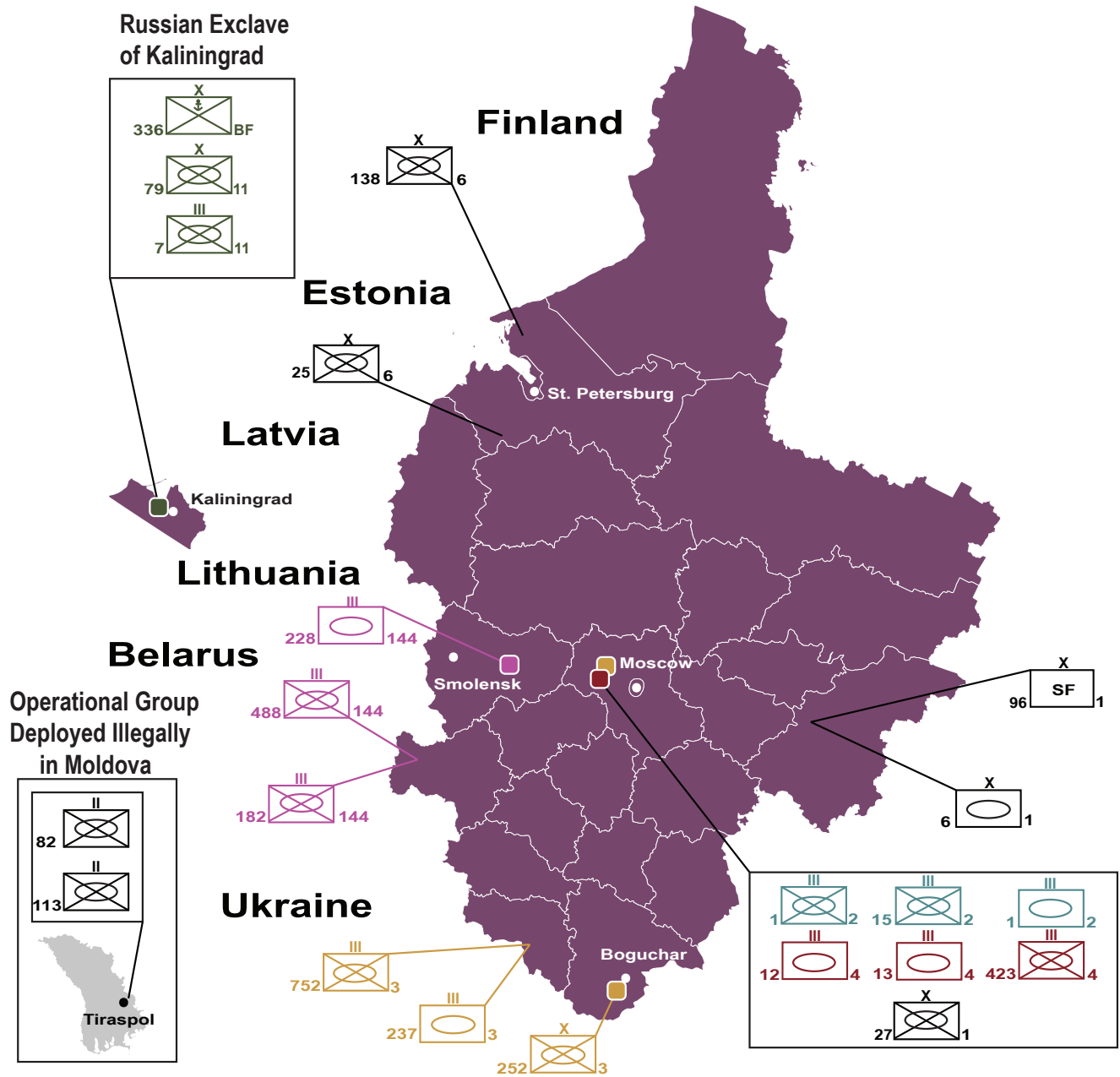

Division and Corps Commands

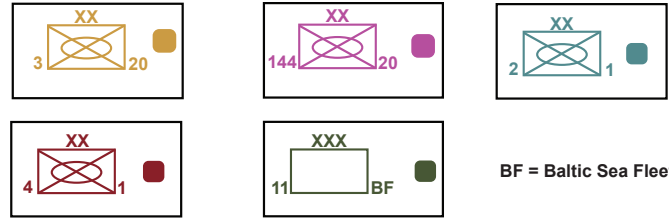

Map © Free Vector Maps.com, with ISW Modifications

Southern Military District

Crimea, Ukraine

127 SF 22
810 BSF

102 III SF 150
103 III SF 150
68 III SF 150
163 III SF 150

Ukraine
Rostov-on-Don
Volgograd

Georgia
Krasnodar

Azerbaijan

20 X 8
25 SF 49
34 X 49
100 X SF 58
727 CF
414 CF
136 X 58
71 X 42
291 III 42
70 III 42
205 X 49
19 X 58
7

Russian Forces Deployed in Armenia

102 Base

Russian Forces Illegally Deployed in Georgia

4 Base 58
7 Base 49

Division and Corps Commands

42 XX 58
150 XX 8
22 XXX BSF

CF = Caspian Flotilla BSF = Black Sea Fleet

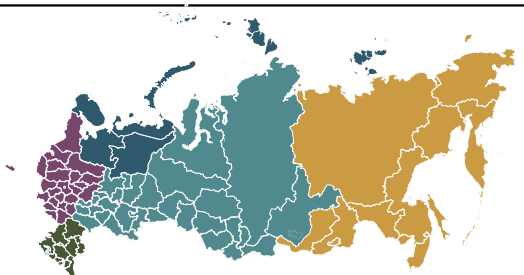

Map © Free Vector Maps.com, with ISW Modifications

Russian Order of Battle

Full Key on Page 40

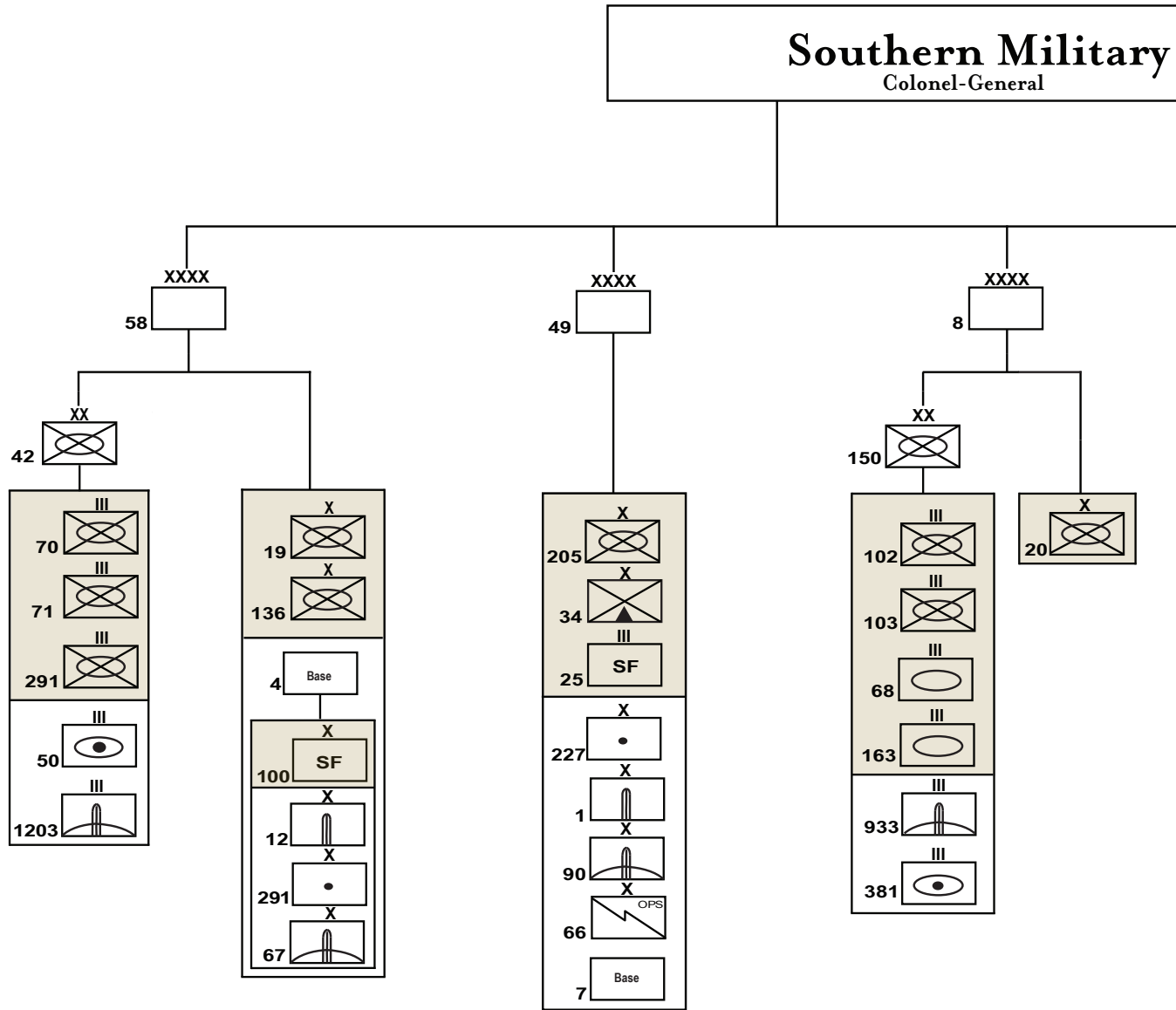

District

Aleksandr Dvornikov

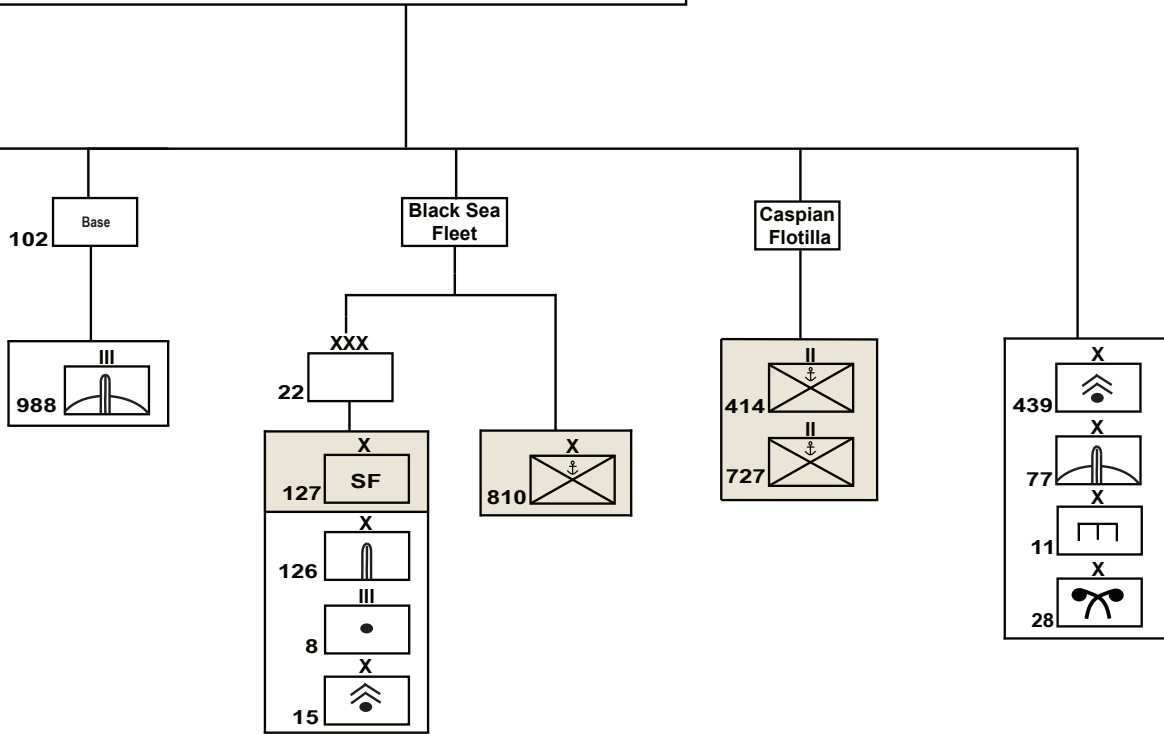

Russian Order of Battle

Full Key on Page 40

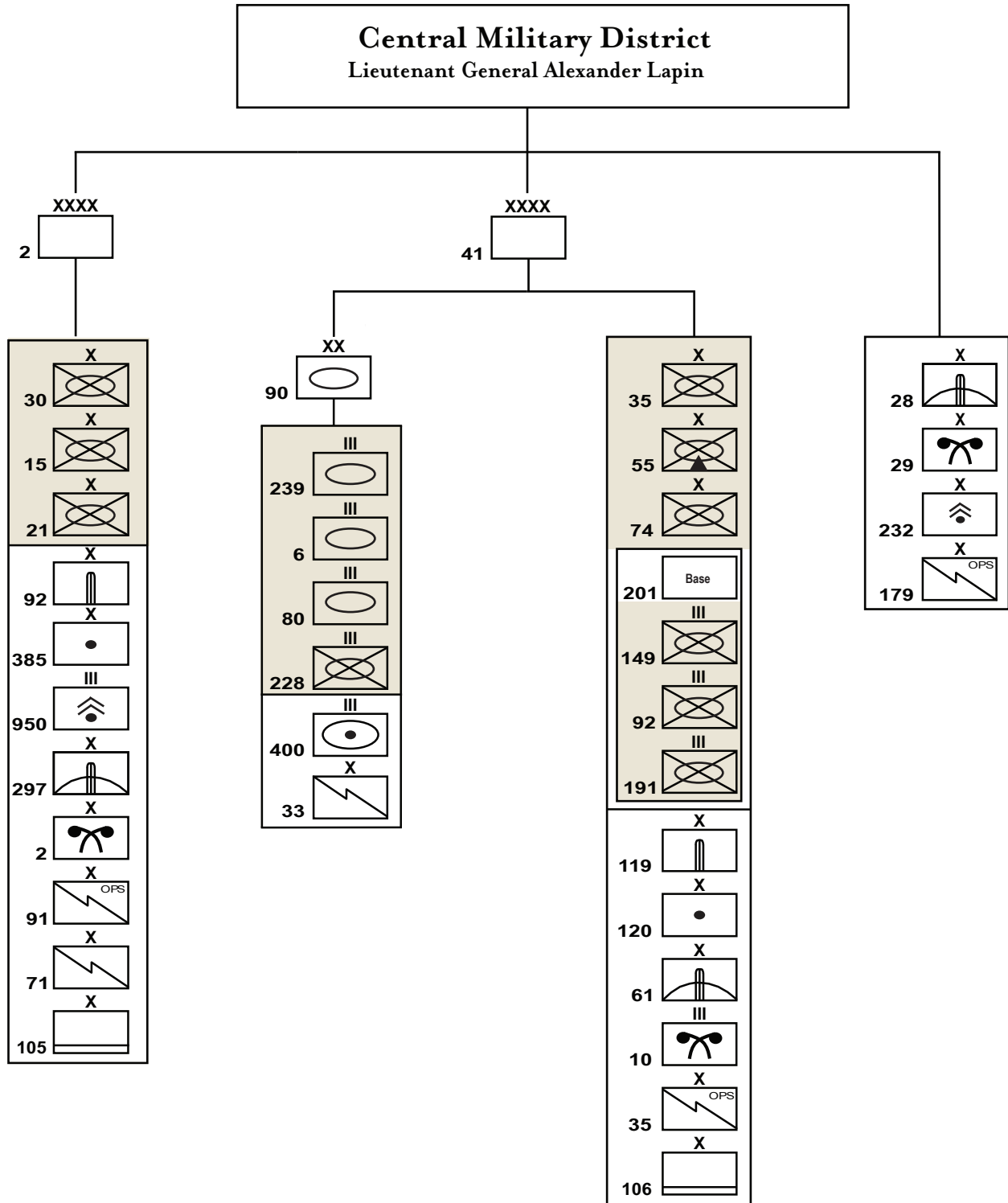

Central Military District

201 Base
Dushanbe
Tajikistan

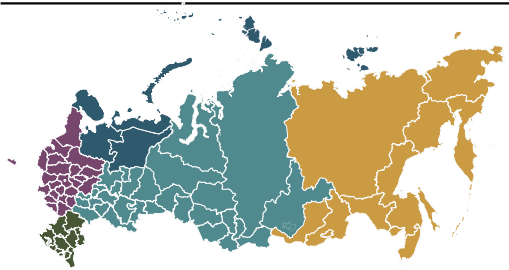
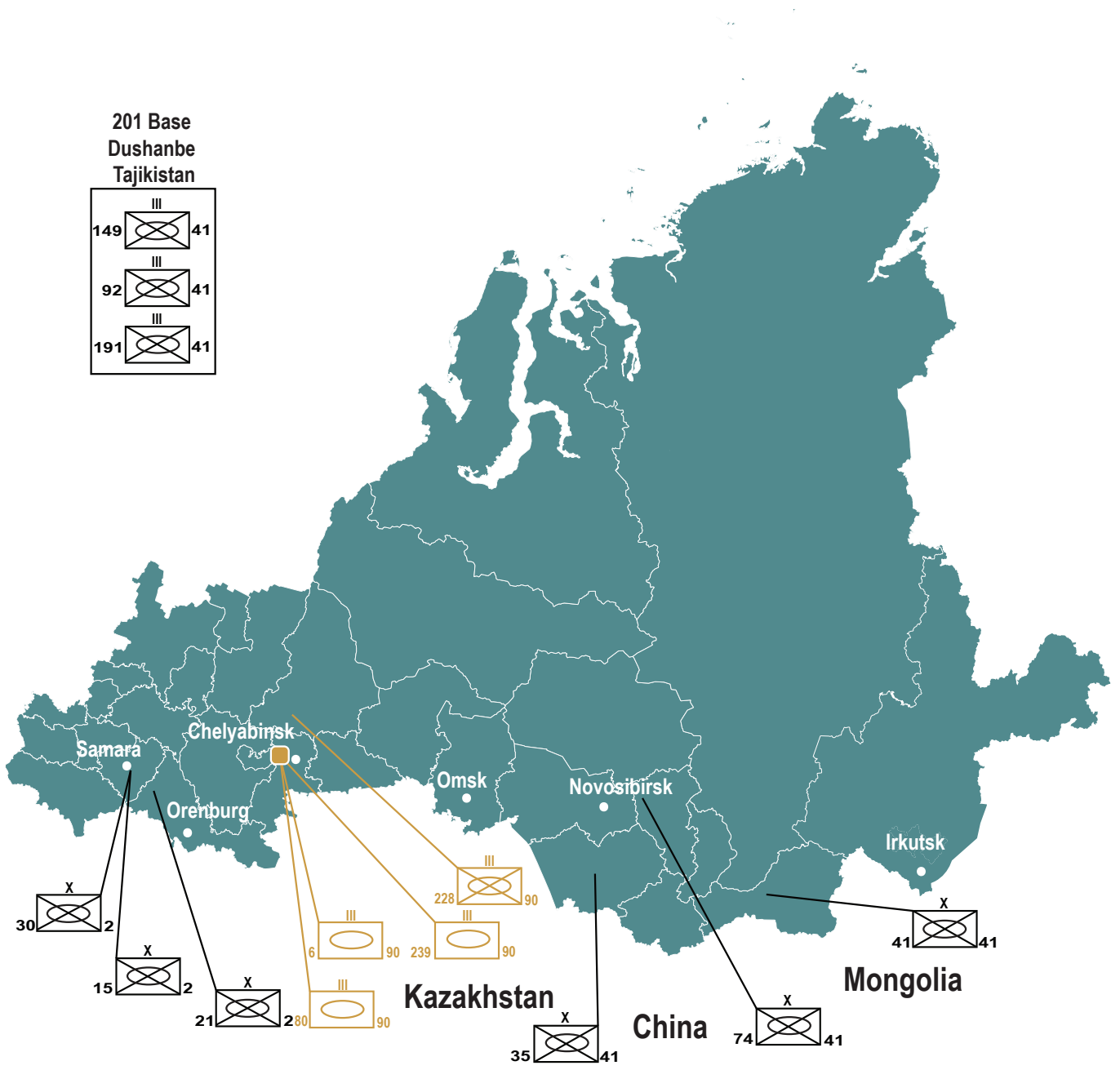
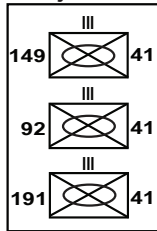

Division and Corps Commands

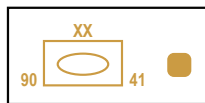

Map © Free Vector Maps.com, with ISW Modifications

Russian Order of Battle

Full Key on Page 40

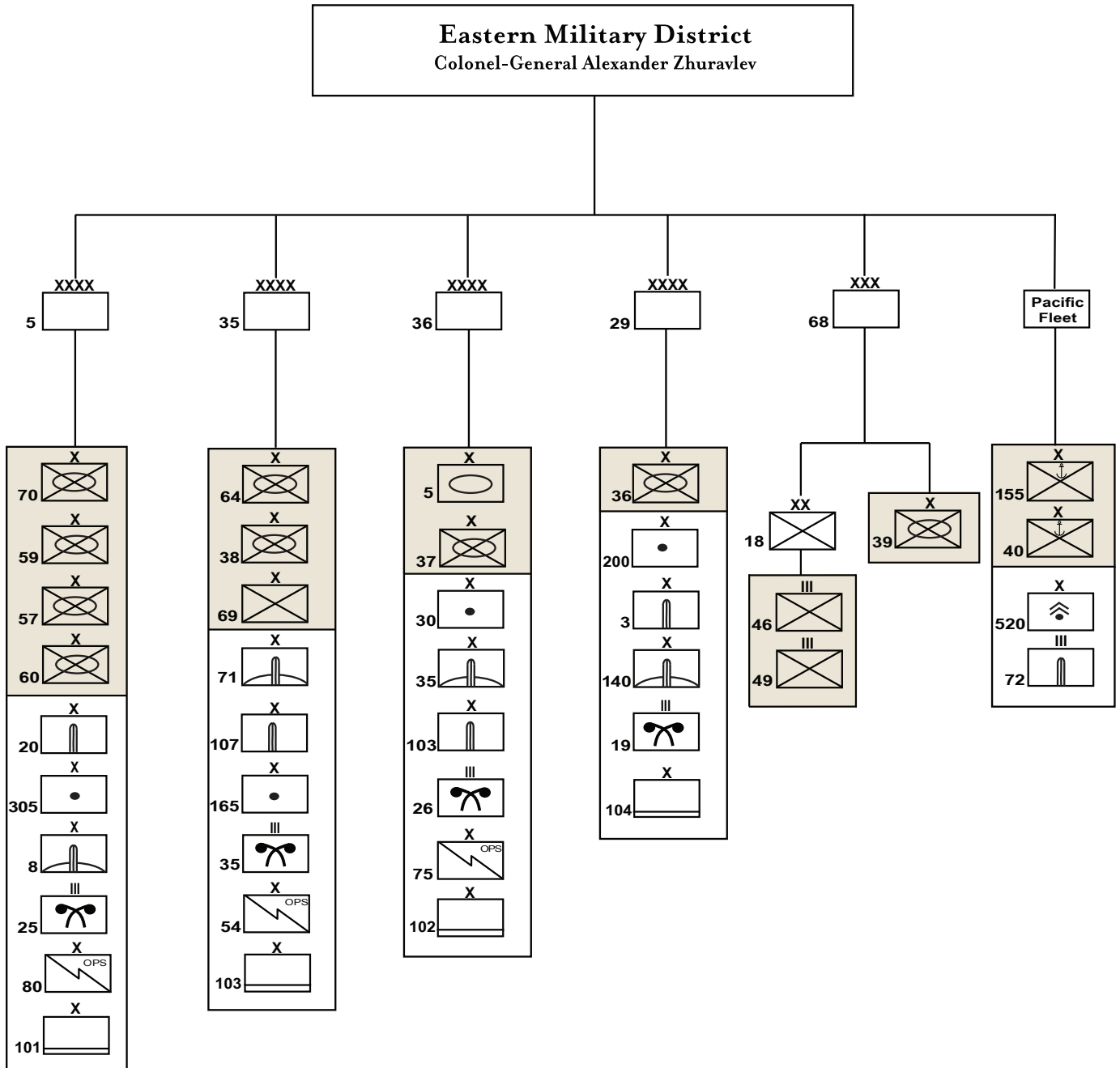

Eastern Military District



Division and Corps Commands:

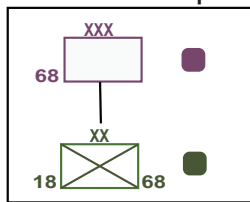

PF = Pacific Fleet

Map © Free Vector Maps.com, with ISW Modifications

Russian Order of Battle

Full Key on Page 40

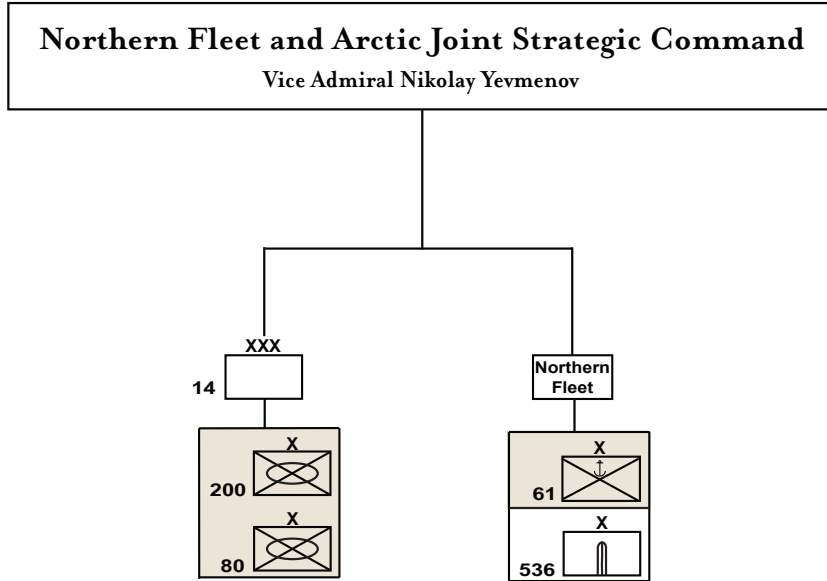

Northern Fleet and Arctic Joint Strategic Command

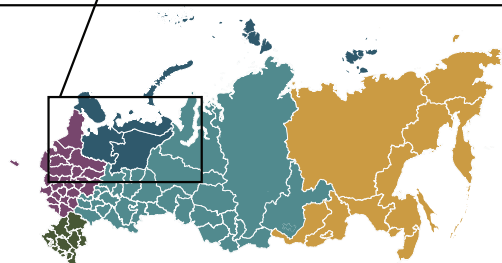
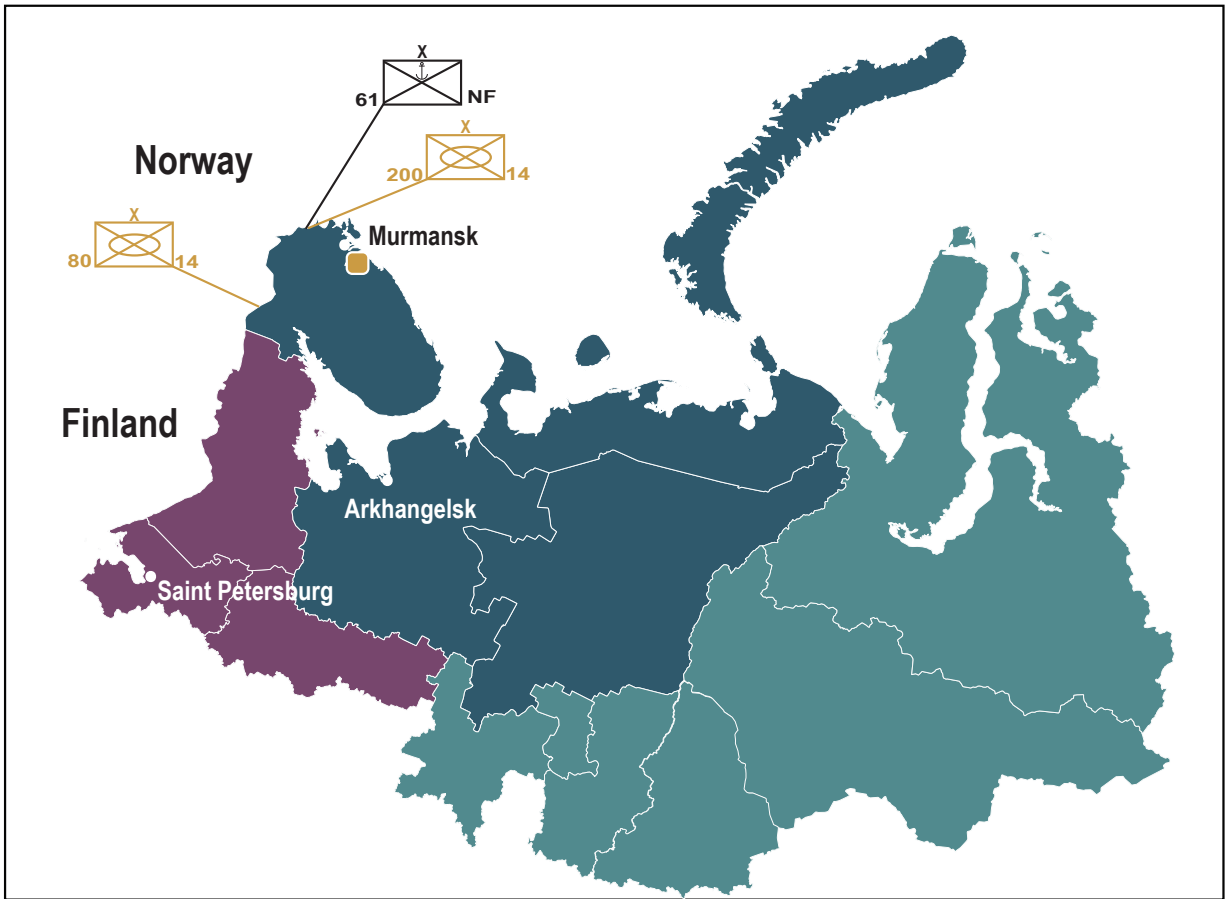





















Division and Corps Commands:



NF-Northern Fleet

Russian Order of Battle

Key

	Indicates Combat Unit		
	Infantry		Missile
	Motor Rifle		Antiaircraft-air Missile
	Mountain Infantry		CBRN
	Mountain Motor Rifle		Military Base
	Naval Infantry		Communications
	Tank		Command and Control
	Special Forces (SPETSNAZ)		Engineer
	Artillery		Logistics
	Reactive Artillery		Medical
	Self-Propelled Artillery		Anti-Tank Artillery

ENDNOTES

- 1 “Estonian Defense Chief: Zapad simulated large-scale military attack against NATO,” *The Baltic Times*. January 1, 2018. https://www.baltictimes.com/estonian_defense_chief_zapad_simulated_largescale_military_attack_against_nato/
- 2 Valeriy Gerasimov. [“The Value of Science is in Foresight”]. *Voenno-Promishlennii Kurier*. February 7, 2013. https://vpk-news.ru/sites/default/files/pdf/VPK_08_476.pdf; Gerasimov, Valeriy. “The Value of Science is in the Foresight.” *Military Review*. January 2016. http://usacac.army.mil/CAC2/MilitaryReview/Archives/English/MilitaryReview_20160228_art008.pdf
- 3 “Evidence of Russian Support for Destabilization of Ukraine.” *Mission of the United States Geneva Switzerland*. April 13, 2014. <https://geneva.usmission.gov/2014/04/14/evidence-of-russian-support-for-destabilization-of-ukraine/>
- 4 S.M. Shtemenko. [“General Staff in the years of war.”] *Militaria*. 1981. <http://militaria.lib.ru/memo/russian/shtemenko/index.html>; Glantz, Colonel David M. “Operational Art and Tactics.” *Defense Technical Information Center*. December 1988. <http://www.dtic.mil/dtic/tr/fulltext/u2/a216492.pdf>
- 5 “Valeriy Vasilyevich Gerasimov.” *Ministry of Defense of the Russian Federation*. https://structure.mil.ru/management/deputy/more.htm?id=11113936@SD_Employee
- 6 Franklin Holcomb. “The Kremlin’s Irregular Army: Ukrainian Separatist Order of Battle.” *The Institute for the Study of War*. September 2017. http://www.understandingwar.org/sites/default/files/ISW%20Separatist%20ORBAT%20Holcomb%202017_Final.pdf
- 7 Sergey Sukhankin. “Russia Electronic Warfare in Ukraine: Between Real and Imaginable.” *Jamestown Foundation*. May 24, 2017. <https://jamestown.org/program/russian-electronic-warfare-ukraine-real-imaginable/>
- 8 Nicolas J. Fiore. “Defeating the Russian Battalion Tactical Group.” *U.S. Army Fort Benning*.
- 9 Frederick W. Kagan. “Situation Report: The Russian Crisis Update.” *The Institute for the Study of War*. September 13, 2008. <http://www.understandingwar.org/sites/default/files/reports/Russian%20Crisis.pdf>; Anne Barnard, Andrew E. Kramer and C. J. Chivers. “Russian Push Past Separatist Area to Assault Central Georgia.” *The New York Times*. August 10, 2008. <http://www.nytimes.com/2008/08/11/world/europe/11georgia.html>
- 10 [“D. Medvedev recognized the Independence of South Ossetia and Abkhazia.”] *RBC*. August 26, 2008. <https://www.rbc.ru/politics/26/08/2008/5703ce849a79473dc81487d9>; “Abkhazia, S. Ossetia Formally Declared Occupied Territory.” *Civil Georgia*. August 8, 2008. <http://www.civil.ge/eng/article.php?id=19330>
- 11 Ariel Cohen and Robert. E Hamilton. “The Russian Military and the Georgia War: Lessons and Implications.” *Strategic Studies Institute*. June 2011. <http://ssi.armywarcollege.edu/pdffiles/pub1069.pdf>; Nichol, Jim. “Russian Military Reform and Defense Policy.” *Congressional Research Service: Report for Congress*, 24 August 2011. <https://fas.org/sgp/crs/row/R42006.pdf>
- 12 Martin Russell. “Russia’s Armed Forces: Reforms and Challenges.” *European Parliamentary Research Service*. April 2015. http://www.europarl.europa.eu/RegData/etudes/IDAN/2015/554213/EPRS_IDA%282015%29554213_EN.pdf
- 13 Rod Thornton. “Military Modernization and the Russian Ground Forces” *Strategic Studies Institute*. June 30, 2011. <https://ssi.armywarcollege.edu/pdffiles/PUB1071.pdf>
- 14 [“The President changed the military-administrative division of the country.”] *Rossiyskaya Gazeeta*. September 22, 2010. <https://rg.ru/2010/09/22/delenie.html>
- 15 Rod Thornton. “Military Modernization and the Russian Ground Forces” *Strategic Studies Institute*. June 30, 2011. <https://ssi.armywarcollege.edu/pdffiles/PUB1071.pdf>
- 16 Jim Nichol. “Russian Military Reform and Defense Policy.” *Congressional Research Service: Report for Congress*, August 24, 2011. <https://fas.org/sgp/crs/row/R42006.pdf>
- 17 Major William G. Pierce. “Span of Control and The Operational Commander: Is It More Than Just a Number?” *School of Advanced Military Studies*. January 5, 1991. <http://www.dtic.mil/dtic/tr/fulltext/u2/a240178.pdf>
- 18 Chloe Arnold. “Russia: Resignation Signals Trouble within Defense Ministry.” *Radio Free Europe Radio Liberty*. March 27, 2008. <https://www.rferl.org/a/1079697.html>
- 19 [“The new division will be the Russian Armed Forces in Yelnya, Voronezh and Rostov-on-Don.”] *Interfax*. May 4, 2016. <http://www.interfax.ru/russia/506841>; [“The Guards Tamanskaya Order of the October Revolution the Red Banner Order of Suvorov Motorized Rifle Division and the Kantemirovskaya Order of Lenin Red Banner Red Banner Tank Division were re-created.”] *Ministry of Defense of the Russian Federation*. May 4, 2013. https://function.mil.ru/news_page/country/more.htm?id=11735703@egNews
- 20 “Three divisions of the Armed Forces deployed on the borders of Ukraine, prepared for offensive action, - General Staff.” *112.ua*. July 7, 2017. <https://112.ua/politika/tri-divizii-vs-rf-ravzernutyena-granicach-ukrainy-podgotovleny-dlya-nastupatelnyh-deystviy-genshtab-400044.html>
- 21 Cristi Vlas. “The peace-keeping mission from Transnistria turns 24 years old.” *Moldova.org*. July 29, 2016. <http://www.moldova.org/en/peace-keeping-mission-transnistria-turns-24-years/>
- 22 “Russia moves nuclear-capable missiles to Kaliningrad,” *Reuters*. October 8, 2016. <https://www.reuters.com/article/us-russia-usa-missiles-confirm/russia-moves-nuclear-capable-missiles-into-kaliningrad-idUSKCN1280IV> Dave Majumdar. “U.S. Air Force Fears Russia’s Lethal S-400 in Europe.” *The National Interest*. January 12, 2016. <http://nationalinterest.org/blog/the-buzz/us-air-force-fears-russias-s-400-europe-14883>
- 23 Sergey Kalashnikov. [“20th Army takes Boguchar.”] *Kommersant*. August 8, 2015. <https://www.kommersant.ru/doc/2796382>
- 24 Frederick W. Kagan. “The Rise and Fall of Soviet Operational Art, 1917–1941.” *The Military History of the Soviet Union*. Palgrave Macmillan, New York.
- 25 [“Vladimir Shamanov: The Airborne Troops of the Russian Federation today are fully self-sufficient troops,”] *Center for Analysis of Global Arms Trade*. July 29, 2015. <http://www.armstrade.org/includes/periodics/news/2015/0729/125530364/detail.shtml>
- 26 “WMD’s SPETSNAZ eliminated imaginary armed group in Pskov region.” *Ministry of Defense of the Russian Federation*. June 21, 2017. http://eng.mil.ru/en/news_page/country/more.htm?id=12129739@egNews; “Russia Airborne Throws its Weight Around.” *Warsaw Institute*. November 7, 2017. <https://warsawinstitute.org/russian-airborne-throws-weight-around/>
- 27 Franklin Holcomb. “The Kremlin’s Irregular Army: Ukrainian Separatist Order of Battle.” *The Institute for the Study of War*. September 2017. http://www.understandingwar.org/sites/default/files/ISW%20Separatist%20ORBAT%20Holcomb%202017_Final.pdf; Magnitsky. “Revealed: Around 40 Russian Troops from Pskov Died in Ukraine, Reinforcements Sent in.” August 27, 2014. <https://www.bellingcat.com/news/mena/2014/08/27/revealed-around-40-russian-troops-from-pskov-died-in-the-ukraine-reinforcement-sent-in/>
- 28 [“Western Military District.”] *MilkaKaz*. June 6, 2017. <http://milkaKaz.com/index.php/voorujonnie-cili-racii/vo-cv/z-vo>
- 29 Yuri Butusov. [“The new army on the border with Ukraine.”] *Facenews*. March 21, 2017. <https://www.facenews.ua/columns/2017/312940>
- 30 [“Izvestia: Two motor rifle divisions will be created in the 58th army of the Southern Military District.”] *TASS*. February 16, 2018. <http://tass.ru/armiya-i-opk/4964277>
- 31 Michael R. Gordon. “Despite Cold War’s End, Russia Keeps Building a Secret Complex.” *New York Times*. April 16, 1996. <http://www.nytimes.com/1996/04/16/world/despite-cold-war-s-end-russia-keeps-building-a-secret-complex.html>
- 32 Yury Petrov. [“Military railroad built access roads to the arsenal of integrated storage in the Urals.”] *TV Zvezda*. February 1, 2018. <https://tvzvezda.ru/news/forces/content/201801021150-8r6n.htm>
- 33 Guy Plopsky. “Why Is Russia Aiming Missiles at China?” *The Diplomat*. July 12, 2017. <https://thediplomat.com/2017/07/why-is-russia-aiming-missiles-at-china/>
- 34 “Kuril islands dispute between Russia and Japan.” *BBC*. April 29, 2013. <http://www.bbc.com/news/world-asia-pacific-11664434>
- 35 “Russia’s Defense Ministry establishes Arctic Strategic Command.” *TASS*. December 1, 2014. <http://tass.com/russia/764428>
- 36 “China, Russia Team Up on Ice Silk Road.” *World Maritime News*. July 10, 2017. <https://worldmaritimeneews.com/archives/224690/china-russia-team-up-on-ice-silk-road/>

- 37 ["Structure of the Western Military District,"] *Russian Federation Ministry of Defense*, <http://structure.mil.ru/structure/okruga/west/structure.htm> ["Andrei Valerievich Kartapolov – Biography,"] *Russian Federation Ministry of Defense*, <http://structure.mil.ru/structure/okruga/west/head.htm>; ["Commanders of the Western Military District,"] *Russian Defense Ministry*, https://structure.mil.ru/structure/ministry_of_defence/details.htm?id=9793@egOrganization; ["Western Military District,"] *Milkavkaz.com*, June 6, 2017, <http://milkavkaz.com/index.php/voorujonnie-cil-racii/vo-cv/z-vo>
- 38 ["6th Red Banner Combined Arms Army,"] *Russian Federation Ministry of Defense*, <http://structure.mil.ru/structure/okruga/details.htm?id=11250@egOrganization>; Alexander Pinchuk, ["A Symbol of Personal Responsibility,"] *Red Star*, January 17, 2017, <http://redstar.ru/index.php/syria/item/31921-simvol-lichnoj-otvetstvennostika> ["6th Red Banner Combined Arms Army,"] *Russian Federation Ministry of Defense*, <http://structure.mil.ru/structure/okruga/details.htm?id=11250@egOrganization>
- 39 ["138th Separate Motor Rifle Brigade Kamenka, Leningrad Oblast,"] *Vkontakte*, <https://vk.com/club5573570>; ["Tanksmen Day observed on a training ground in Kamenka,"] *Saint Petersburg Government Official Site*, September 10, 2016, <https://gov.spb.ru/press/governor/95876/>
- 40 ["Pskov men from 18 to 40 years are invited to do contract service,"] *Without Format*, May 2, 2017, <http://pskov.bezformata.ru/listnews/pskovskih-muzhchin-ot-18-do-40-let-priglasayut/57015930/>; ["The Brave Taxi Driver,"] *Everyday Life*, October 11, 2017, <http://фатежские-будни.рф/архив-vsekh-nomerov-gazety/460-fatezhskie-budni-41-ot-11-10-2017-g/4521-sluzhba-po-kontraktu.html>; ["Military Unit 29760 in Luga,"] *Write a Letter to Putin*, <http://napisat-pismo-putinu.ru/armiya/voinskaya-chast-29760-g-luga>; ["Military Unit 29760,"] *Ok Group*, <https://ok.ru/komitetso/loca/66407957957377>; ["Western Military District,"] *Russian Military Units*, <http://vojskovayachast.ru/zapadnyj-voennyj-okrug/>
- 41 ["Military Unit 02561,"] *Vkontakte*, <https://vk.com/club10178011>; ["9th Artillery Guard Brigade - Luga"] *Wikimapia*, <http://wikimapia.org/19633622/ru/9-%D1%8F-%D0%B3%D0%B2%D0%B0%D1%80-%D0%B4%D0%B5%D0%B9%D1%81%D0%BA%D0%B0%D1%8F-%D0%B0%D1%80%D1%82%D0%B8%D0%BB%D0%BB%D0%B5%D1%80%D0%B8%D0%B9%D1%81%D0%BA%D0%B0%D1%8F-%D0%B1%D1%80%D0%B8%D0%B3%D0%B0%D0%B4%D0%B0-%D0%B2-%D1%87-02561>; ["Rehearsal and training of the parade in honor of the 71st anniversary of the Victory in the Great Patriotic War in St. Petersburg,"] *000100.ru*, <http://000100.ru/index.php?showtopic=96272>; Sergei Flev, ["Military Units of the Aggressor Country, Participating in War Crimes Against Ukraine and Its Citizens,"] *Begemot*, April 27, 2017, <http://begemot.media/news/voinskie-chasti-strany-agressora-uchastvuyushhie-v-sovshenii-voennyh-prestuplenij-protiv-ukrainy-i-ee-grazhdan/>
- 42 *Informost.ru*, 2015, Unavailable: <http://www.vpovsv.informost.ru/2015/pdf/2-02.pdf>; ["5th Air Defense Brigade Saint Petersburg,"] *Vkontakte*, <https://vk.com/club33079448>; ["5th Air Defense Brigade History,"] *Ok Group*, January 18, 2013, <https://ok.ru/tsgv.5zrb/topic/200487407450>; "5th Air Defense Brigade armed with 'Iskander-M' Missiles in Primorye," *PrimeMedia.ru*, July 24, 2016, <https://news.mail.ru/politics/26543263/>
- 43 "Pavel Kovalev, ['Iskander-M' Missile Brigade Might Be Posted in the Western Oblast of Belarus,"] *War and Politics Review*, June 17, 2015, <http://www.belypo.com/ru/53643.html>; ["Military Unit 54006,"] *Vkontakte*, <https://vk.com/club2577807>; ["Embroidered sleeve sign, 26th Missile Nemanskaya Red Banner, the Order of Suvorov, Kutuzov and Alexander Nevsky Brigade, Luga,"] *Custom Made Stripes*, <https://vishivkaspb.com/nashivki-mo-rossii/nashivka-army-150-detail.html>
- 44 Ilya Ershov, ["Commanding 20th Army in Voronezh begun operating in the Eastern Military District,"] *Bloknat*, February 3, 2017, <http://bloknat-voronezh.ru/news/komandyuyushchim-20-y-armiey-v-voronezhe-stal-preds-813743>; ["20th Red Banner Guards Combined Arms Army,"] *Russian Federation Ministry of Defense*, <http://structure.mil.ru/structure/okruga/details.htm?id=11251@egOrganization>; A.V. Karpenko, ["20th Red Banner Guards Combined Arms Army,"] *Weapons of the Homeland*, December 2, 2016, <http://bastion-opk.ru/20-arms-army/>; ["Title Unavailable,"]
- 45 ["Military Unit 54046, 3rd Motorized Rifle Division,"] *Vkontakte*, <https://vk.com/army54046>; ["Military Unit 54046, 9th Separate Motorized Military Brigade,"] *Military Units of Russia*, February 1, 2017, <http://vojskovayachast.ru/vch54046/>; ["3rd Motorized Divisions Receives Self-Propelled Howitzers,"] *Live Journal*, March 31st, 2017, <http://altyn73.livejournal.com/1127341.html>; ["Military Installations Voronezh,"] *Wikimapia*, <http://wikimapia.org/#lang=en&lat=49.943819&lon=40.499682&z=15&m=b&tag=516&search=boguchar>; Vidal Sorokin and Necro Mancer, ["Valuiki and Boguchar: The Re-Opening and Labeling of Technology of the 3rd Division of the Russian Federation,"] *Inform Napalm*, June 3, 2017, <https://informnapalm.org/37271-valujki-i-boguchar-markirovka-tehniki/>; ["Military Unit 54046, 3rd Motorized Rifle Division,"] *Vkontakte*, <https://vk.com/army54046>; "More on the 'New' Divisions," *Russian Defense Policy*, November 14, 2016, <https://russiandefpolicy.blog/2016/11/14/more-on-the-new-divisions/>
- 46 Igor Vetrov, ["Why Russia builds Military Bases at its Border with Ukraine: Opinions,"] *Segodnya*, June 18, 2016, <http://www.segodnya.ua/ukraine/zachem-rossiya-stroit-voennye-bazy-u-granic-s-ukrainoy-mneniya-ekspertov-724304.html>; Michael Kofman, "New Russian Divisions and other units shifting to Ukraine's border," *Russian Military Analysis – Blog*, August 22, 2016, <https://russianmilitaryanalysis.wordpress.com/2016/08/22/russian-units-on-ukraines-borders-second-look-with-updates/comment-page-1/>; ["Military Unit 34670 – 752nd Motorized Rifle Regiment,"] *Vkontakte*, https://vk.com/vch_34670; ["Military Unit 34670 - Valuiki & Solotii,"] *Mama Soldata*, November 5, 2017, <http://mamasoldata.mybb.ru/viewtopic.php?id=5734>
- 47 Tatyana Iorina, ["Military experts from Germany will train the motorized rifle unit arriving in Voronezh,"] *360n.ru*, January 15, 2017, <http://360n.ru/news/people/66097-voennye-spetsialisty-iz-germanii-proveryat-motostrelkovuyu-chast-pod-voronezhem>; ["Elninskaya motorized rifle brigade will be reorganized into a division,"] *BPK*, January 14, 2016, <http://vpk-news.ru/news/28807>; ["Military Unit 54046, 3rd Motorized Infantry Division, Boguchar,"] *Vkontakte*, <https://vk.com/army54046>; ["The Russian Federation doubled the number of weapons on the border with Ukraine at the Valuiki and Boguchar bases for the year,"] *Censor.net*, June 5, 2017, <https://censor.net.ua/photo-news/442815/rf-za-god-udvoila-kolichestvo-voorujeniya-na-granitse-s-ukrainoyi-na-bazah-v-valuyikah-i-boguchare-tehniki>; ["3rd Motorized Rifle Division,"] *Mama Soldata*, February 6, 2017, <http://mamasoldata.mybb.ru/viewtopic.php?id=5359>; ["Military Unit 62892 – 245th Motorized Rifle Guards,"] *Vkontakte*, <https://vk.com/club1233922>; ["Boguchar - Military Unit 54046,"] *Ok Group*, <https://ok.ru/group/54857369518097/topic/67033945036049>; Sergei Mamontov, ["German Advisors will meet the motorized rifle regiment near Voronezh,"] *RIA News Russia Today*, January 15, 2017, <https://ria.ru/defense-safety/20170115/1485719416.html>
- 48 ["Western Military District,"] *Military Units of Russia*, June 6, 2017, <http://vojskovayachast.ru/zapadnyj-voennyj-okrug/>; ["237th Tank Regiment,"] *Vkontakte*, <https://vk.com/vh91726>; ["Military Unit 91726 - Valuiki,"] *Vkontakte*, <https://vk.com/club134894032>; ["Information on Military Unit 91726 - Valuiki,"] *Ok Group*, <https://ok.ru/group/54857369518097/topic/67341624562961>; ["Enemy Divisions at the Ukrainian Border,"] *Inform Napalm*, June 4, 2017, <https://petrimazepa.com/enemysarmyatthegate.html>; ["Information on Military Unit 91726 - Valuiki,"] *Ok Group*, <https://ok.ru/group/54857369518097/topic/67341624562961>
- 49 ["99th Self-Propelled Artillery Regiment,"] *Vkontakte*, https://vk.com/artpolk_99; ["The Russian Federation doubled the number of weapons on the border with Ukraine at the Valuiki and Boguchar bases for the year,"] *Censor.net*, June 5, 2017, <https://censor.net.ua/photo-news/442815/rf-za-god-udvoila-kolichestvo-voorujeniya-na-granitse-s-ukrainoyi-na-bazah-v-valuyikah-i-boguchare-tehniki>
- 50 Vidal Sorokin and Necro Mancer, ["Valuiki and Boguchar: common markings on military equipment operated by Russian Army and LPR,"] *Inform Napalm*, August 16, 2017, <https://informnapalm.org/en/valuyki-boguchar-common-markings-military-equipment-operated-russian-army-lpr/>; ["1143rd Air Defense Regiment,"] *Ok Group*, <https://ok.ru/vojskovoep/album/56878469873715>; ["1143rd Air Defense Regiment – Military Unit 48422,"] *Vkontakte*, <https://vkfaces.com/vk/group/m48422>; ["Western Military District,"] *Military Units of Russia*, June 6, 2017, <http://vojskovayachast.ru/zapadnyj-voennyj-okrug/>

- 51 ["Valuiki and Boguchar: common markings on military equipment operated by Russian Army and LPR."] *Inform Napalm*, August 16, 2017, <https://informnapalm.org/en/valuiki-boguchar-common-markings-military-equipment-operated-russian-army-lpr/>; ["The Russian Federation doubled the number of weapons on the border with Ukraine at the Valuiki and Boguchar bases for the year."] *Censor.net*, June 5, 2017, https://censor.net.ua/photo_news/442815/uf_za_god_udvoila_kolichestvo_voorujeniji_na_granitse_s_ukrainoyi_na_bazah_v_valuyikah_i_boguchare_tehniku.
- 52 ["Valuiki and Boguchar: common markings on military equipment operated by Russian Army and LNR."] *Inform Napalm*, August 16, 2017, <https://informnapalm.org/en/valuiki-boguchar-common-markings-military-equipment-operated-russian-army-lpr/>; ["The Russian Federation doubled the number of weapons on the border with Ukraine at the Valuiki and Boguchar bases for the year."] *Censor.net*, June 5, 2017, https://censor.net.ua/photo_news/442815/uf_za_god_udvoila_kolichestvo_voorujeniji_na_granitse_s_ukrainoyi_na_bazah_v_valuyikah_i_boguchare_tehniku.
- 53 ["Valuiki and Boguchar: common markings on military equipment operated by Russian Army and LPR."] *Inform Napalm*, August 16, 2017, <https://informnapalm.org/en/valuiki-boguchar-common-markings-military-equipment-operated-russian-army-lpr/>; ["The Russian Federation doubled the number of weapons on the border with Ukraine at the Valuiki and Boguchar bases for the year."] *Censor.net*, June 5, 2017, https://censor.net.ua/photo_news/442815/uf_za_god_udvoila_kolichestvo_voorujeniji_na_granitse_s_ukrainoyi_na_bazah_v_valuyikah_i_boguchare_tehniku.
- 54 "Military Unit 54046." *Vkontakte*, https://vk.com/topic-26250088_31597597; ["Valuiki and Boguchar: common markings on military equipment operated by Russian Army and LPR."] *Inform Napalm*, August 16, 2017, <https://informnapalm.org/en/valuiki-boguchar-common-markings-military-equipment-operated-russian-army-lpr/>; ["The Russian Federation doubled the number of weapons on the border with Ukraine at the Valuiki and Boguchar bases for the year."] *Censor.net*, June 5, 2017, https://censor.net.ua/photo_news/442815/uf_za_god_udvoila_kolichestvo_voorujeniji_na_granitse_s_ukrainoyi_na_bazah_v_valuyikah_i_boguchare_tehniku.
- 55 ["Source reports that deployed Yelninsky Division is part of the 1st Tank Army."] *Lenta.ru*, June 5, 2016, <https://lenta.ru/news/2016/07/05/elninskaya/>; Aleksei Nikolski, ["New Divisions are Deploying to the Border with Ukraine."] *Vedomosti*, November 30, 2016, <http://www.vedomosti.ru/politics/articles/2016/11/30/667490-ukrainoi-novih-divizii>; Michael Kofman, "New Russian Divisions and other units shifting to Ukraine's border," *Russian Military Analysis – Blog*, August 22, 2016, <https://russianmilitaryanalysis.wordpress.com/2016/08/22/russian-units-on-ukraines-borders-second-look-with-updates/comment-page-1/>; Victory Krm, ["Klintsy – a military foothold for the advance of Russia to the West."] *Inform Napalm*, May 19, 2017, <https://informnapalm.org/36671-klintsy-voennyi-platsdarm-na-zapad/>; "More on the 'New' Divisions," *Russian Defense Policy*, November 14, 2016, <https://russiandefpolicy.blog/2016/11/14/more-on-the-new-divisions/>.
- 56 Aleksei Nikolski, ["Pentagon suspected Russia prepared an invasion of Ukraine."] *Vedomosti*, August 18, 2016, <http://www.vedomosti.ru/newspaper/articles/2016/08/18/653689-vtorzhenie-ne-pervoiv-svezhesti>; ["488th Motorized Rifle Regiment in Klintsy."] *Livejournal*, August 18, 2016, <http://bmdp.livejournal.com/2074442.html>; ["The 28th Separate Motorized Rifle Brigade Celebrated its 96th Anniversary."] *Klitsy News*, November 11, 2016, <http://klitsy.info/news/block-252/>; The 488th regiment was created from parts of the 28th brigade and will be complete by June 2017: ["New Facilities Built for 488th Motorized Rifle Brigade in Klintsy."] <http://gorodbyrjansk.info/>, August 18, 2016, <http://gorodbyrjansk.info/2016/08/klintsy-warfare/>; ["On November 1st, the city held a gala dedicated to the 96th anniversary of the 28th separate motorized rifle brigade."] *Klinci*, November 1, 2016, <http://www.klinci.ru/news/632/3816/page19/>.
- 57 ["Military Unit 61423."] *Vkontakte*, <https://vk.com/club13674799>; ["Military Unit 61423."] *Prizyvnik*, November 9, 2016, https://www.prizyvnik.info/threads/158750-v-ch_61423/; ["28th Separate Motorized rifle Brigade."] *Russian Military Units*, <https://voinskayachast.net/suhoputnie-voyska/motostrelkovie/vch61423>; ["Is Belarus ready to meet an uninvited neighbor?": Russia is forming a new division in Klintsy, aimed at the West."] *Censor.net*, May 22, 2017, https://censor.net.ua/photo_news/440897/gotova_li_bielarus_k_vstreche_s_neproshenym_sosedom_rf_formiruet_na_baze_v_klintsah_novuyu_diviziyu_natselennuyu; Ekaterina Egirovskaya, ["Shoigu strengthens the Bryansk border."] *Gazeta*, June 1, 2016, <https://www.gazeta.ru/army/2016/06/01/8276903.shtml#>.
- 58 ["Western Military District."] *Military Units of Russia*, June, 6, 2017, <http://vojskovayachast.ru/zapadnyj-voennyj-okrug/>; ["Military Unit 54046 Composition,"] *m2ch.hk*, <https://m2ch.hk/po/res/23759627.html#23759990>.
- 59 ["Cases and concerns of the military unit,"] Without Format, February 7, 2017, <http://pochep.bezformata.ru/listnews/dela-i-zaboti-vojskovoj-chasti/54685458v>; ["The 856th self-propelled artillery regiment based in Pochep arranged an unusual day for conscripts,"] *Radio 32*, November 3, 2017, <http://radio32reklama.ru/news/v-pochepe-voinskaya-chast-gde-baziruetsya-856-y-samokhodno-artilleryjskiy-polk-ustroila-neobychnyy-d/>; ["Title Unavailable,"] *Pochep Gazeta*, <http://pochepgazeta.ru/?p=21549>.
- 60 ["144th Motorized Rifle Division,"] *Turkish Search Engine*, <https://www.turkaramamotoru.com/ru/144-%D1%8F%D0%BC%D0%BE%D1%82%D0%BE%D1%81%D1%82%D1%80%D0%B5%D0%BB%D0%BA%D0%BE%D0%B2%D0%B0%D1%8F-%D0%B4%D0%B8%D0%B2%D0%B8%D0%B7%D0%B8%D1%8F-g86r78.html>; ["Western Military District,"] *Military Units of Russia*, June, 6, 2017, <http://vojskovayachast.ru/zapadnyj-voennyj-okrug/>.
- 61 ["9th Brigade gets Complete 'Iskander-M' Missile Set,"] *Army News*, November 30, 2016, <http://army-news.ru/2016/11/devyatyj-brigadnyj-komplekt-raketnyx-kompleksov-iskander-m/>; Marina Riznik, ["In Russia, the tank army that participated in the Battle of Kursk reintroduced,"] <http://kursk-izvestia.ru/>, February 11, 2016, <http://kursk-izvestia.ru/news/17070/>.
- 62 Alexander Khrolenko, ["Why Russia Needs a New Tank Army,"] *Russia Today*, February 3, 2016, <https://ria.ru/analitics/20160203/1369103343.html>; ["The Legendary 1st Tank Guards Army Revived in the Western Military District,"] *Russian Federation Ministry of Defense*, February 1, 2016, <http://structure.mil.ru/structure/okruga/west/news/more.htm?id=12076048@egNews>; ["Lieutenant-General Avdeev received the status of the commander of the First Tank Army,"] *TASS*, May 12, 2016, <http://tass.ru/armiya-i-opk/4247536>; ["Media learns of the revival of the first Tank Guards Army in the Russian Military,"] *RBC*, July 23, 2015, <http://www.rbc.ru/rbcfreenews/55b0c3969a79475146bac8e5>; ["Ministry of Defense of the Russian Federation: the first Tank Guards Army re-established in the Western Military District,"] *TASS*, February 1, 2016, <http://tass.ru/armiya-i-opk/2629907>; Victor Litovkin, ["The First Tank Brigade: Why does the Russian Army have a mechanized fist?"] *TASS*, February 2, 2016, <http://tass.ru/armiya-i-opk/2632366>; Marina Riznik, ["In Russia, the tank army that participated in the Battle of Kursk reintroduced,"] <http://kursk-izvestia.ru/>, February 11, 2016, <http://kursk-izvestia.ru/news/17070/>.
- 63 ["New Russian Military Divisions will appear in Yelnya, Voronezh and Rostov-on-Don,"] *Interfax*, May 4, 2016, <http://www.interfax.ru/russia/506841>; ["Elninskaya motorized rifle brigade will be reorganized into a division,"] *VPK*, January 14, 2016, <http://vpk-news.ru/news/28807>; ["2nd Guards Taman Division,"] *Vkontakte*, <https://vk.com/2gvmsd>; ["2nd Guards Taman Motorized Rifle Division, Military Unit 23626,"] *Russian Military Units*, <https://voinskayachast.net/suhoputnie-voyska/motostrelkovie/vch23626>; ["Volunteers declassified Putin's new military in Syria,"] *Apostrophe*, May 4, 2017, <https://apostrophe.ua/news/world/2017-05-04/volonteryi-rassekretili-novyih-voennyih-putina-v-sirii-opublikovanyi-foto/95114>.
- 64 ["1st Motorized Rifle Regiment,"] *Vkontakte*, <https://vk.com/club3618540>; ["The 1st Motorized Rifle Regiment of the Taman Division, Military Unit 31135,"] *Russian Military Units*, <https://voinskayachast.net/suhoputnie-voyska/motostrelkovie/vch31135>; ["Information about the Taman Division,"] *Prizyvnik*, January 14, 2014, <https://www.prizyvnik.info/entries/42399-informatsiya-po-tamanskoy-divizii>.
- 65 ["The 15th Motorized Rifle Regiment of the Taman Division, Military Unit 31134,"] *Russian Military Units*, <https://voinskayachast.net/suhoputnie-voyska/motostrelkovie/vch31134>; ["The 15th Motorized Rifle Regiment of the Taman Division, Military Unit 31134,"] *Bizbi*, <https://bizbi.ru/handbook/vooruzhennyye-sily/voennyye-chastinarofominska/77357/>.
- 66 ["A New Tank Regiment was Formed in the Moscow Suburbs,"] *RIA News*, December 21, 2016, <https://ria.ru/defense-safety/20161221/1484264029.html>; ["Western Military District,"] *Military Units of Russia*, June 6, 2017, <http://vojskovayachast.ru/zapadnyj-voennyj-okrug/>; ["What will we fight if there are almost no tanks in Russia?"] *Popular News*, March 13, 2017, <https://narod-novosti.com/armiya-i-oruzhie/?p=chem-myi-budem-voevat-esli-v-rf-pochti-net-tankov>.

- 67 ["Military Unit 73966."], *For President*, <http://forpresident.ru/vch-73966.html>; ["Military Unit 23626, Kalininets, Naro-Fominsk."], *Mama Soldata*, November 10, 2012, <http://mamasoldata.mybb.ru/viewtopic.php?id=416&p=44>
- 68 ["1117th Antiaircraft Missile Regiment with Military Unit 71847 and Military Unit 23626."], *Ok Group*, <https://ok.ru/group/50383921938577/video/all>; ["The Tor-M2 surface-to-air missile systems of the 538th anti-aircraft missile regiment in the 726th training center in Yeisk."], *Live Journal*, March 27, 2017, <https://bmpd.livejournal.com/2513904.html>; ["The 15th Motorized Rifle Regiment of the Taman Division, Military Unit 31134."], *Ok Group video*, <https://ok.ru/video/242137107122>
- 69 ["The 1st Tank Army - The Main Strike Force. Yesterday and today."], *Shaked-il*, July 7, 2017, <http://shaked-il.blogspot.com/2017/07/1.html>; ["Military Unit 48487."], *Live Journal*, February 23, 2011, <http://yazvecovavv.livejournal.com/2208.html>; ["Western Military District."], *Military Units of Russia*, June 6, 2017, <http://vojskovayachast.ru/zapadnyj-voennyj-okrug/>; <http://vojskovayachast.ru/zapadnyj-voennyj-okrug/>
- 70 ["Information on Military Unit 23626."], *Mama Soldata*, June 21, 2013, <http://mamasoldata.mybb.ru/viewtopic.php?id=863>
- 71 ["New Russian Military Divisions will appear in Yelnya, Voronezh and Rostov-on-Don."], *Interfax*, May 4, 2016, <http://www.interfax.ru/russia/506841>; ["Elninskaya motorized rifle brigade will be reorganized into a division."], *VPK*, January 14, 2016, <http://vpk-news.ru/news/28807>; ["Birthday of the regiment."], *Live Journal*, March 1, 2017, <http://kosdor.livejournal.com/31962.html>
- 72 ["12th Tank Regiment of the Kantemirovskaya Tank Division."], *Bizbi*, <https://bizbi.ru/handbook/vooruzhennyye-sily/voennyye-chastinarofominska/77350/>; ["4th Tank Kantemirovskaya Division Military Unit 19612."], *Vkontakte*, <https://vk.com/club44760332>
- 73 ["Kantemirovskaya Division, 13th Tank Regiment."], *Military Unit*, June 21, 2015, <http://voinskaya-chast.ru/vooruzhennyye-cily/tankovyye-vojska/kantemirovskaya-diviziya-13-tankovyj-polk.html>; Tatar National Center of the Moscow Region, ["Speech by the deputy commander of the Kantemirovskaya division, Oleg Chivilieva."], *Tatar National Center of the Moscow Region*, <https://www.youtube.com/watch?v=g5mltntbEUG>; ["4th Guards Tank Division."], *Wikiwand*, <http://www.wikiwand.com/ru/4-%D1%8F-%D0%B3%D0%B2%D0%B0%D1%80%D0%B4%D0%B5%D0%B9%D1%81%D0%BA%D0%B0%D1%8F-%D1%82%D0%B0%D0%BD%D0%BA%D0%BE%D0%B2%D0%B0%D1%8F-%D0%B4%D0%B8%D0%B2%D0%B8%D0%B7%D0%B8%D1%8F>; ["Naro-Fominsk (Kantemirovka) - distribution from Mulino."], *Vkontakte*, https://vk.com/topic-108377947_36424148
- 74 ["Kantemirovskaya Division - Yampolsky Regiment."], *Vkontakte*, <https://vk.com/kantimyrj>; ["Naro-Fominsk (Kantemirovka) - distribution from Mulino."], *Vkontakte*, https://vk.com/topic-108377947_36424148
- 75 ["4th Tank Division Comment."], *Ok Group*, <https://ok.ru/group13ygvardey/topic/63596214569834>; ["Military Unit 19612, Kantemirovskaya Tank Division."], *Mama Soldata*, April 28, 2017, <http://mamasoldata.mybb.ru/viewtopic.php?id=5462&p=42>; ["275th self-propelled artillery regiment, military unit 48763, Naro-Fominsk/Moscow region."], *Russian-army-in-ukraine.silk.co*, date unknown, <http://russian-army-in-ukraine.silk.co/page/275-%D0%B9-%D1%81%D0%B0%D0%BC%D0%BE%D1%85%D0%BE%D0%B4%D0%BD%D1%8B%D0%B9-%D0%B0%D1%80%D1%82%D0%B8%D0%BB%D0%BB%D0%B5%D1%80%D0%B8%D0%B9%D1%81%D0%BA%D0%B8%D0%B9-%D0%BF%D0%BE%D0%BB%D0%BA-48763-%D0%9D%D0%B0%D1%80%D0%BE-%D0%A4%D0%BE%D0%BC%D0%B8%D0%BD%D1%81%D0%BA-%D0%9C%D0%BE%D1%81%D0%BA%D0%BE%D0%B2%D1%81%D0%BA%D0%B0%D1%8F-%D0%BE%D0%B1%D0%B%D0%B0%D1%81%D1%82%D1%8C>
- 76 ["Holiday for the 49th Anti-Aircraft Missile Brigade."], *District of Smolensk Government*, November 22, 2016, <http://smolpatriot.ru/news/prazdnik-49-zenitnoj-raketnoj-brigady/>; ["49th Anti-Aircraft Missile Air Defense Unit 21555."], *Vkontakte*, <https://vk.com/club34595092>
- 77 ["New Russian Military Divisions will appear in Yelnya, Voronezh and Rostov-on-Don."], *Interfax*, May 4, 2016, <http://www.interfax.ru/russia/506841>; ["Elninskaya motorized rifle brigade will be reorganized into a division."], *VPK*, January 14, 2016, <http://vpk-news.ru/news/28807>
- 78 ["New Russian Military Divisions will appear in Yelnya, Voronezh and Rostov-on-Don."], *Interfax*, May 4, 2016, <http://www.interfax.ru/russia/506841>; ["Elninskaya motorized rifle brigade will be reorganized into a division."], *VPK*, January 14, 2016, <http://vpk-news.ru/news/28807>; ["6th Tank Brigade of Russia."], *Live Journal*, September 17, 2015, <http://sled-vzayt.livejournal.com/3827.html>
- 79 ["5th Air Defense Brigade armed with 'Iskander-M' Missiles in Primorye."], *PrimeMedia.ru*, July 24, 2016, <https://news.mail.ru/politics/26543263/>; ["Iskander-M Missile Brigade Might Be Posted in the Western Oblast of Belarus."], *War and Politics Review*, June 17, 2015, <http://www.belupo.com/ru/53643.html>; ["Viktor Smirnov visited the 112th Novorossiysk Guards Missile Brigade."], *Ivanovo Regional Duma*, February 21, 2017, <http://ivoblduma.ru/press-tsentr/vse-novosti/20234/>
- 80 ["288th Artillery Brigade - Military Unit 30683."], *Military Units of Russia*, <https://voinskayachast.net/suhoputnie-voyska/raketnie-i-artilleriya/vch30683>; ["Military Unit 30683 (288th Artillery Brigade) in Mulino."], *Wikimapia*, <http://wikimapia.org/17802113/ru/%D0%B2-%D1%87-%D0%B3-%D0%B8-%D0%90%D1%80%D1%82%D0%B8%D0%BB%D0%BB%D0%B5%D1%80%D0%B8%D0%B9%D1%81%D0%BA%D0%B0%D1%8F-%D0%91%D1%80%D0%B8%D0%B3%D0%B0%D0%B4%D0%B0>; ["288th Artillery Brigade."], *Vkontakte*, https://vk.com/artbrigada_288
- 81 ["Separate intelligence brigades."], *Paratrooper*, January 18, 2016, <http://desantura.ru/forum/forum15/topic22217/>; ["Military Unit 52634, Nizhny Novgorod, 96th Separate Intelligence Brigade."], *Military Units of Russia*, <http://voinskajachast.ru/suhoputnye-voyska/specialnye-voyska/vch-52634-nizhnyj-novgorod-96-aya-obrr/>
- 82 ["Nosatov Alexander Mikhailovich - Biography."], *Russian Federation Ministry of Defense*, <http://structure.mil.ru/structure/forces/type/navy/baltic/leader.htm>; ["Department of Information Kaliningrad Region Contacts."], *Russian Federation Ministry of Defense*, <http://structure.mil.ru/structure/forces/type/navy/baltic/contacts.htm>; ["Russian Baltic Fleet."], *MilKavkaz.com*, June 6, 2017, <http://milkavkaz.com/index.php/voorujonnie-cili-racii/vmf/bf>
- 83 Aleksei Nikolski, ["Moscow Nominated Officers for Front Line Duty."], *Vedomosti*, May 12, 2016, <http://www.vedomosti.ru/politics/articles/2016/05/12/640715-shtabistov-peredovuyu>; Yuri Yarovitsky, ["New Army Corps Deployed in the Kaliningrad District."], *lenta.ru*, May 12, 2016, <https://lenta.ru/news/2016/05/12/corps/>; ["11th Army Corps Forms as part of the Baltic Fleet."], *Sight*, June 29, 2016, <http://vz.ru/news/2016/6/29/818741.html>; Yuri Yarovitsky, ["New Army Corps Deployed in the Kaliningrad District."], *lenta.ru*, May 12, 2016, <https://lenta.ru/news/2016/05/12/corps/>
- 84 ["The creation of the 11th Army Corps will, if necessary, quickly build up troop presence in the Kaliningrad region - a source."], *Military News*, July 6, 2016, <http://www.militarynews.ru/story.asp?rid=&nid=418358>; ["The Baltic Fleet will celebrate the 90th anniversary of the formation of its famous motorized rifle formation."], *Russian Defense Ministry*, December 16, 2016, https://function.mil.ru/news_page/country/more.htm?id=12106366&egNews; Aleksei Nikolski, ["Moscow Nominated Officers for Front Line Duty."], *Vedomosti*, May 12, 2016, <http://www.vedomosti.ru/politics/articles/2016/05/12/640715-shtabistov-peredovuyu>
- 85 ["The creation of the 11th Army Corps will, if necessary, quickly build up troop presence in the Kaliningrad region - a source."], *Military News*, July 6, 2016, <http://www.militarynews.ru/story.asp?rid=&nid=418358>; Aleksei Nikolski, ["Moscow Nominated Officers for Front Line Duty."], *Vedomosti*, May 12, 2016, <http://www.vedomosti.ru/politics/articles/2016/05/12/640715-shtabistov-peredovuyu>
- 86 Katerina Mihalididi, ["Shoigu Strengthens The Kaliningrad Region 11th Army Corps."], *riafan.ru*, July 6, 2016, <https://riafan.ru/534912-shoigu-usilil-kaliningradskuyu-oblast-11-m-armskim-korpusom>; Andrei Vypolov, ["NATO's eastern headquarters will settle in 50 kilometers from the Kaliningrad region."], *Top Secret*, July 8, 2016, <http://www.sovsekretno.ru/news/id/9383/>; ["244th Artillery Brigade."], *Vkontakte*, <https://vk.com/club13161213>; "Order of Battle Report Updates," *Russian Defense Policy*, October 11, 2017, <https://russiandefpolicy.blog/category/order-of-battle/>
- 87 ["5th Air Defense Brigade armed with 'Iskander-M' Missiles in Primorye."], *PrimeMedia.ru*, July 24, 2016, <https://news.mail.ru/politics/26543263/>; ["9th Brigade gets Complete 'Iskander-M' Missile Set."], *Army News*, November 30, 2016, <http://army-news.ru/2016/11/devyatyj-brigadnyj-komplekt-raketnyx-kompleksov-iskander-m/>
- 88 ["22nd Separate Guards Anti-Aircraft Missile Regiment."], *Vkontakte*, <https://vk.com/22ozgrp>; ["Composition of the fleets' Army Corps."], *Top War*, May 25, 2017, <https://topwar.ru/116427-sostav-sozdannyh-na-flotah-armeyskih-korpuso.html>; ["22nd Separate Anti-Aircraft Guards - Military Unit 54129."], *Vkontakte*, <https://vk.com/club16722060>

- 89 ["336th Marine Brigade,"] *Vkontakte*, <https://vk.com/brigada336>; ["Under Kaliningrad, a stone was planted on the temple to commemorate the Marines who died in Chechnya,"] *regnum.ru*, January 18, 2017, <https://regnum.ru/news/politi/2228404.html>.
- 90 ["202nd Air Defense Military Unit 43034,"] *Vkontakte*, <https://vk.com/club21035032>; ["Western Military District,"] *milkavkaz.net*, December 2015, <http://www.milkavkaz.net/2015/12/zapadnyj-voennyj-okrug.html>
- 91 ["79th Red Banner Rocketry and Artillery Brigade Military Unit 53956,"] *Vkontakte*, <https://vk.com/club6465759>; ["79th Red Banner Rocketry and Artillery Brigade Military Unit 53956 Photos,"] *Vkontakte*, <https://vk.com/albums-6465759>
- 92 ["What is the Address of Military Unit 31969 in Tambov?"] *Our Reference*, August 21, 2016, <http://tambov.nashaspravka.ru/kakoj-adres-u-vojskoj-chasti-31969-v-tambove-2714651>; ["Military Unit 31969 of Tambov,"] *Ok Group*, <https://ok.ru/materisold/topic/66304291659863>;
- 93 Cristi Vlas, ["New monument of the "Russian warrior-peacekeeper" installed in Tiraspol,"] *Moldova.org*, December 3, 2017, <http://www.moldova.org/en/new-monument-russian-warrior-peacekeeper-installed-tiraspol/>; Igor Sutyagin and Michael Clarke, ["Ukraine Military Dispositions,"] *Royal United Services Institute*, April 2014, https://rusi.org/system/files/UKRANIANMILITARYDISPOSITIONS_RUSIBRIEFING.pdf
- 94 ["Replenishment of the Russian group in Transnistria,"] *weaponews.com*, June 1, 2017, <http://weaponews.com/news/8330-replenishment-of-the-russian-group-in-transnistria.html>; Sergey Ilchenko ["Ukraine and Moldova will act together against Russia in the United Nations,"] *AVA Media*, September 1, 2017, <https://ava.md/2017/08/31/ukraina-i-moldova-vystupyat-vmeste-protiv/>
- 95 ["Replenishment of the Russian group in Transnistria,"] *weaponews.com*, June 1, 2017, <http://weaponews.com/news/8330-replenishment-of-the-russian-group-in-transnistria.html>; Sergey Ilchenko ["Ukraine and Moldova will act together against Russia in the United Nations,"] *AVA Media*, September 1, 2017, <https://ava.md/2017/08/31/ukraina-i-moldova-vystupyat-vmeste-protiv/>
- 96 ["The commander of the South-Eastern Military District examined the combat readiness of the Russian military base in South Ossetia,"] *Russian Federation Ministry of Defense*, February 2, 2017, http://function.mil.ru/news_page/country/more.htm?id=12110585@egNews; ["The Commander of the troops of the Southern Military District arrived to inspect the Maikop garrison,"] *rambler.ru*, December 8, 2017, <https://news.rambler.ru/roops/38627515-komanduyuschiy-voyskami-yuzhnogo-voennogo-okruga-pribyl-s-rabochey-poezdkov-v-maykopskiy-garnizon/>; ["Southern Military District,"] *Milkavkaz.com*, June 6, 2017, <http://milkavkaz.com/index.php/voorujonnie-cili-racii/vo-cv/u-vo>
- 97 Oleg Mukhin, ["The 20th Army found a new commander on Sakhalin,"] *kommersant.ru*, February 3, 2017, <http://www.kommersant.ru/doc/3207955> also in <http://osetia.info/news/main/2017/01/14/01-23/>; Roman Biryulin, ["The symbol of valor and honor,"] *Red Star*, December 5, 2017, <http://redstar.ru/index.php/component/k2/item/35305-simvol-doblesti-i-chesti>; ["58th Combined-Arms Army,"] *Russian Federation Ministry of Defense*, <http://structure.mil.ru/structure/okruga/details.htm?id=11257@egOrganization>
- 98 Alexey Ramm, ["The Ministry of Defense revives the legendary 'Chechen division',"] *News*, September 27, 2016, <http://izvestia.ru/news/634572>; ["Federal Danger Service 58th Combined-Arms Army,"] *Live Journal*, September 12, 2008, <http://malaya-zemlya.livejournal.com/448774.html>; Dmitry Buyanin, ["Two Divisions have Formed in the South Military District Army Corps and have already started combat training,"] *TASS*, February 10, 2017, <http://tass.ru/armiya-i-opk/4014014>
- 99 ["Federal Danger Service 58th Combined-Arms Army,"] *Live Journal*, September 12, 2008, <http://malaya-zemlya.livejournal.com/448774.html>; ["70th Guards Motorized Rifle Regiment,"] *Vkontakte*, <https://vk.com/club16169736>; ["The 70th Guards Motorized Rifle Regiment in Chechnya received a new BMP-3,"] *Live Journal*, February 7, 2018, <https://bmpd.livejournal.com/3082755.html>
- 100 ["Federal Danger Service 58th Combined-Arms Army,"] *Live Journal*, September 12, 2008, <http://malaya-zemlya.livejournal.com/448774.html>; ["71st regiment of Military Unit 16544,"] *Vkontakte*, <https://vk.com/club141828892>
- 101 Irakly Komakhidze, ["Anniversary of the 291st Artillery Brigade of the Russian Federation Armed Forces in Donbass,"] *Inform Napalm*, June 9, 2016, <https://informnapalm.org/23556-yubilejnyj-zasvet-291-j/>
- 102 ["Chechnya, Shaws, 50th Self-propelled Artillery Regiment,"] *Ok Group*, <https://ok.ru/video/3143632258>; ["Military Unit 64684,"] *Esosedi*, http://ru.esosedi.org/RU/CE/1000011056/v_ch_64684/; ["Military Unit 64684,"] *RusProfile*, February 21, 2018, <http://www.rusprofile.ru/id/10002440>
- 103 Dmitry Petrov, ["The situation is close to the battle: the Russian military raised on alert,"] *Vesti*, February 8, 2016, <http://www.vesti.ru/doc.html?id=2718004>; Irina Gugkayeva, ["For the 19th Specialized Motorcycle Brigade of the 58th Army, A Day of the Open Doors,"] *alania.tv*, February 15, 2016, <http://alania.tv/vesti/?id=17737>; ["Izvestia: two motorized rifle divisions will be created in the 58th Army of the Southern Military District,"] *TASS*, February 16, 2018, <http://tass.ru/armiya-i-opk/4964277>
- 104 ["A mercenary soldier from Dagestan in the Donbas was identified,"] *Charter 97*, August 18, 2016, <https://charter97.org/ru/news/2016/8/16/218748/>; ["Alley of Heroes opened by the 136th separate motorized rifle brigade,"] *Republican Information Agency*, May 9, 2015, http://www.riadagestan.ru/news/society/alleyu_geroev_otkryli_v-voinskoy_chasti_136_oy_otdelnoy_motostrelkovoy_brigady/; ["Izvestia: two motorized rifle divisions will be created in the 58th Army of the Southern Military District,"] *TASS*, February 16, 2018, <http://tass.ru/armiya-i-opk/4964277>
- 105 ["4th Guards Military Unit 66431 of Tskhinvali,"] *Vkontakte*, https://vk.com/military_base_4 Irakly Komakhidze, ["The Russian Shengen: The 4th Military Base is on Alert,"] *Inform Napalm*, February 6, 2017, <https://informnapalm.org/32860-shengen-po-russkij-4-baza-podnyata-po-trevoge/>
- 106 Irakli Komakhidze, ["100th Separate Brigade on the border with Ukraine,"] *Inform Napalm*, September 26, 2014, <https://informnapalm.org/1677-100-ya-otdelnaya-razvedyvatelnaya-brygada-na-granytse-s-ukraynoj/>; ["100th Separate Reconnaissance Brigade - Military Unit 23511,"] *Russian Military Units*, <https://voinskayachast.net/suhoputnie-voyska/specialnie/vch23511> ["Mozdok, Military Unit 23511, 100th Brigade,"] *Vkontakte*, <https://vk.com/club15934236>
- 107 ["Military Unit 25788 Wall,"] *Vkontakte*, https://vk.com/wall-10504037_50762; ["The 152nd Guards missile brigade in Kaliningrad received Iskander-M missile systems,"] *Live Journal*, November 25, 2017, <https://bmpd.livejournal.com/2970466.html>
- 108 ["The 291st Artillery Brigade, Military Unit 64670,"] *Russian Military Units*, <http://voinskayachast.ru/suhoputnie-voyska/raketnie-i-artilleriya/vch64670/>; Irakli Komakhidze, ["291st Artillery Brigade of the Russian Armed Forces is Back on the Donbas Radar for a Record 12th Time,"] *Inform Napalm*, June 9, 2016, <https://informnapalm.org/en/jun09-291-brigade-donbas/>; ["ISIS declares that three Russian servicemen were killed in Syria,"] *Milkavkaz*, June 2016, <http://www.milkavkaz.net/2016/06/daesh-zavaylyaet-cto-v-sirii-ubity-troe-voennosluzhashih-rf.html>
- 109 ["The 67th Anti-Aircraft Missile Brigade,"] *Vkontakte*, <https://vk.com/club39031289>; Presence in Ukraine: Irakly Komakhidze, ["67th Air-Defense Missile Brigade from Russia Has Been in Ukraine,"] *Inform Napalm*, November 2, 2014, <https://informnapalm.org/en/67th-air-defense-missile-brigade-russia-ukraine/>
- 110 ["49th Combined Arms Army,"] *Russian Federation Ministry of Defense*, <http://structure.mil.ru/structure/okruga/details.htm?id=11254@egOrganization>
- 111 ["The Russian army began active mobilization of reservists in the Stavropol Territory,"] *joinfo.ua*, August 26, 2016, http://joinfo.ua/inworld/1178069_Na-Stavropole-nachalas-aktivnaya-mobilizatsiya.html; ["Governor of Stavropol has checked the readiness of the regiment of territorial defense,"] *pobeda.ru*, August 29, 2016, <http://pobeda26.ru/novosti/gubernator-stavropolya-proveril-boegotovnost-polka-territorialnoj-oborony>; ["Russian contractors have been transferred to the border of Ukraine,"] *uinp.info*, date unavailable, http://uinp.info/political_Groups/rossijskih_kontraktnikov_perebrosili_k_granice_ukrainy_foto; Oleg Bozhov, ["The Army leaves the mountains,"] *MK RU*, September 4, 2016, <http://www.mk.ru/politics/2016/09/04/armiya-ukhodit-v-gory.html>
- 112 ["34th Separate Motorized Rifle Brigade, Military Unit 01485,"] *Russian Military Units*, <https://voinskayachast.net/suhoputnie-voyska/motostrelkovie/vch01485> ["34th Separate Motorized Rifle Brigade (Mountainous),"] *Ok Group*, <https://ok.ru/group34otdelnay>; Mikhail Kuznetsov, ["Identification of the Russian Ground Forces in Salma, Syria,"] *Inform Napalm*, January 27, 2016, <https://informnapalm.org/en/jan27-ground-syria/> -- Deployment to Syria

- 113 ["Special Purpose Units of the Russian Federation,"] *zem-advokat.ru*, <https://zem-advokat.ru/practice/item/podrazdeleniya-spetsialnogo-naznacheniya-rossiyskoy-federatsii/>; ["Special Forces of the GRU: history, structure, main tasks,."] *militaryarms.ru*, July 5, 2017, <https://militaryarms.ru/armii-mira/specnaz-gru/>
- 114 ["Russia is deploying a new artillery brigade in the Ukrainian direction - volunteers,"] *UNIAN*, February 3, 2017, <https://www.unian.net/world/1759402-rossiya-razvorachivaet-novuyu-artilleriyskiy-brigadu-kotoraya-neset-ugrozu-ukraine-i-gruzii-volonteryi.html> Irakli Komakhidze, "Journey of Russian Occupation: Gudauta - Rostov - Donbas - Khmeimim," *Inform Napalm*, April 3, 2016, <https://informnapalm.org/en/journey-russian-occupant-gudauta-rostov-donbas-khmeimim/> -- Deployment to Donbas 2015, Syria in November 2015 Fire Dragon. ["7th Military Base: infoleak countermeasures,"] *Inform Napalm*, February 4, 2017, <https://informnapalm.org/bg/komandvaneto-na-yuvo-predprie-merki-za-predotvratyavane-na-iztichane-na-informatsiya-za-t-n-rostovsko-ukrainski-komandirovki/>; ["Abkhazia-Gudauta Military Unit 09332,"] *Ok Group*, <https://ok.ru/group/53712944168960>
- 115 Nikolay Makhno, ["Tracking Down the 66th Signal Brigade: from Donbas to Syria,"] *Inform Napalm*, December 24, 2015, <https://informnapalm.org/en/dec23-syria-track/>
- 116 ["7th Military Base, Gudauta,"] *Vkontakte*, <https://vk.com/club8045872>; Vladimir Anosov, ["The Russian military base in Abkhazia created a company of unmanned aircraft,."] *rg.ru*, July 26, 2017, <https://rg.ru/2017/07/26/reg-ufo/na-voennoj-baze-v-abhazii-sozdali-rotu-bespiilotnikov.html>
- 117 Alexey Ramm and Evgeny Andreev, ["The Southern Military District will receive a new army,."] *News*, March 17, 2017, <https://iz.ru/news/670561>; Ivan Safronov, ["South-West district fortified with military generals,."] *kommersant.ru*, July 10, 2017, <https://www.kommersant.ru/doc/3350770>
- 118 ["The 150th Motor-rifle Division starts to protect the southern frontier,."] *dontr.ru*, date unavailable, <http://dontr.ru/vesti/obshchestvo/150-ya-motostrelkovaya-diviziya-pristupila-k-zashhite-rubezhej-na-yuge-rossii/>; Alexey Gromov, ["The new motorized rifle division in South-East Asia will begin combat training on December 1st,."] *riafan.ru*, October 18, 2016, <https://riafan.ru/565575-novaya-motostrelkovaya-diviziya-v-yuvo-nachnet-boevuyu-uchebu-1-dekabrya>; Michael Kofman, "New Russian Divisions and other units shifting to Ukraine's border," *Russian Military Analysis - Blog*, August 22, 2016, <https://russianmilitaryanalysis.wordpress.com/2016/08/22/russian-units-on-ukraines-borders-second-look-with-updates/comment-page-1/>; ["Two divisions in the South Military District Army Corps have formed and are already started combat training,."] *TASS*, February 10, 2017, <http://tass.ru/armiya-i-opk/4014014> Aleksei Nikolski, ["New Divisions are Deploying to the Border with Ukraine,."] *Vedomosti*, November 30, 2016, <https://www.vedomosti.ru/politics/articles/2016/11/30/667490-ukrainoi-novih-divizii>; "More on the 'New' Divisions," *Russian Defense Policy*, November 14, 2016, <https://russiandefpolicy.blog/2016/11/14/more-on-the-new-divisions/>
- 119 ["102nd Motorized Rifle Regiment,."] *Vkontakte*, <https://vk.com/33brigada> ["The 102nd military base for the Russian Forces in Transcaucasia,."] *Caucasian Knot*, April 3, 2015, <http://www.kavkaz-uzel.eu/articles/152315/>; ["Southern Military District,."] *milkavkaz.net*, December 2015, <http://www.milkavkaz.net/2015/12/yuzhnyj-voennyj-okrug.html>; Irakli Komaxidze, ["Myths and reality behind the 150th Division, Russian state-of-art 21st century Armed Forces,."] *Inform Napalm*, October 13, 2017, <https://informnapalm.org/39397-150-ya-diviziya-xxi-veka-vs-rf-mify-i-realnost/>; Irakli Komaxidze, "Myths and reality behind the 150th Division, Russian state-of-art 21st century Armed Forces,."] *Inform Napalm*, October 13, 2017, <https://informnapalm.org/en/myths-and-reality-behind-the-150th-division-russian-state-of-art-21st-century-armed-forces/>
- 120 Irakli Komaxidze, "Myths and reality behind the 150th Division, Russian state-of-art 21st century Armed Forces,."] *Inform Napalm*, October 13, 2017, <https://informnapalm.org/en/myths-and-reality-behind-the-150th-division-russian-state-of-art-21st-century-armed-forces/>
- 121 Alexey Ramm and Evgeny Andreev, ["Russia's southern border strengthened by special tanks,."] *News*, July 24, 2017, <https://iz.ru/618033/aleksei-ramm-evgenii-andreev-iug-rossii-usilili-sverkhzashchishchennymi-tankami/>; ["Russia transferred a 'contract soldier' tank regiment to its border with Ukraine,."] *glavred.info*, June 14, 2017, <http://glavred.info/politika/rossiya-perebrosila-na-granicu-s-ukrainoy-tankovyy-polk-divizii-kontraktnikov-441230.html>
- 122 Irakli Komaxidze, "Myths and reality behind the 150th Division, Russian state-of-art 21st century Armed Forces,."] *Inform Napalm*, October 13, 2017, <https://informnapalm.org/en/myths-and-reality-behind-the-150th-division-russian-state-of-art-21st-century-armed-forces/>; ["Military Unit 84839 Wall,."] *Vkontakte*, https://vk.com/wall-125684771_6159; ["Military Unit 84839 Info,."] *Ok Group*, <https://ok.ru/komitsetso/topic/66778693864193>
- 123 ["The anti-aircraft missile regiment of the 150th motorized rifle division is armed with the Tor-M2 surface-to-air missile systems,."] *Live Journal*, November 13, 2017, <https://bmpd.livejournal.com/2946915.html>; Alexei Ramm, Dmitry Litovkin, and Evgeny Dmitriev ["The south of Russia was strengthened with the latest 'Tor' air defense systems,."] *News*, June 21, 2017, <https://iz.ru/608604/aleksei-ramm-dmitrii-litovkin-evgenii-dmitriev-iug-rossii-usilili-zenitnyimi-bublikami-avtomatami/>; ["The regiment with 'Tor-M2U' air defense systems will cover the south of Russia,."] *tvzvezda.ru*, June 21, 2017, <https://tvzvezda.ru/news/opk/content/20170621022-uad5.htm>
- 124 ["381st Artillery Regiment, 150th Motorized Rifle Division,."] *Vkontakte*, <https://vk.com/club150186828>
- 125 ["Military Unit 22220 Volgograd - the 20th separate guards motorized rifle brigade,."] *Military Units of Russia*, <http://voinskajachast.ru/sukhoputnye-voyska/motostrelkovye-voyska/voyskovaya-chast-22220/>; ["The 20th Guards separate motorized rifle brigade,."] *Military Units of Russia*, <https://voinskayachast.net/suhoputnie-voyska/motostrelkovie/vch22220/>; ["The 20th motorized rifle brigade celebrated its 75th anniversary,."] *Volgograd 24*, <https://www.youtube.com/watch?v=TWsmWyPu0TU>; ["The 20th Motorized Rifle Brigade hosted an open day,."] *Volgograd 24*, <https://www.youtube.com/watch?v=f4FYWEZAdCQ>
- 126 ["Defense Ministers of Russia and Armenia signed an agreement on the Combined Group of Forces of the two countries,."] *Russian Federation Ministry of Defense*, November 30, 2016, http://function.mil.ru/news_page/country/more.htm?id=12105072@egNews#txt; MrBurjuin, ["102nd Russian military base In Gyumri, Armenia,."] <https://www.youtube.com/watch?v=SY-60AV8fgQ>; ["102nd Military Base,."] *Vkontakte*, https://vk.com/voennaya_baza
- 127 ["Military base in Armenia is topic of Russian-Armenian relations,."] *Regnum*, March 15, 2017, <https://regnum.ru/news/2249794.html>; ["Western Military District,."] *Military Units of Russia*, June 6, 2017, <http://vojskovayachast.ru/yuzhnyj-voennyj-okrug/>; ["Southern Military District,."] *milkavkaz.com*, June 6, 2017, <http://milkavkaz.com/index.php/voorujonnie-cili-racii/vo-cv-u-vo> ["Anti-aircraft gunners of the Russian military base in Armenia began preparations for training with combat launches from the S-300V SAM on the Kapustin Yar test range,."] *Russian Federation Ministry of Defense*, October 17, 2017, https://www.google.com/url?q=http://function.mil.ru/news_page/country/more.htm?id%3D12147147@egNews&sa=D&ust=15091127027000&usq=AFQjCNFZKuq9BFD1QaKziY_PGpsC7Hl7WQ
- 128 ["Western Military District,."] *Military Units of Russia*, June 6, 2017, <http://vojskovayachast.ru/yuzhnyj-voennyj-okrug/>; Irakli Komaxidze, ["Confirmation of the 439th Guards Rocket Artillery Brigade deployed as part of the Russian invasion forces,."] *Inform Napalm*, November 5, 2014, <https://informnapalm.org/en/confirmation-439th-guards-rocket-artillery-brigade-deployed-part-russian-invasion-forces/>; ["Military Unit 69673, Znamensk, Astrakhan region,."] *Mama Soldata*, January 10, 2016, <http://mamasoldata.mybb.ru/viewtopic.php?id=3755>; ["Military Units in Astrakhan and the Astrakhan region,."] *Military Units*, <https://voinskayachast.net/goroda/astaxan-i-astaxanskaya-oblast>
- 129 ["Vitko Alexander Viktorovich - Biography,."] *Russian Federation Ministry of Defense*, http://structure.mil.ru/structure/forces/type/navy/black_sea/leader.htm ["Black Sea Fleet,."] *Russian Federation Ministry of Defense*, http://structure.mil.ru/structure/forces/type/navy/black_sea.htm; ["Russian Black Sea Fleet,."] *Milkavkaz.com*, June 6, 2017, <http://milkavkaz.com/index.php/voorujonnie-cili-racii/vmf/chf>

- 130 ["The composition of the army corps created from the fleets,"] *Top War*, May 25, 2017, <https://topwar.ru/116427-sostav-sozdannyh-na-flotah-armeyskih-korpusov.html>; ["The 32nd Army Corps are in Crimea,"] *Interfax*, December 12, 2016, <http://www.interfax.ru/russia/540985>; ["Two divisions in the South Military District Army Corps have formed and are already started combat training,"] TASS, February 10, 2017, <http://tass.ru/armiya-i-opk/4014014>; ["Were the 22nd or 32nd Army Corps in Crimea?"] *Live Journal*, February 11, 2017, <https://altyn73.livejournal.com/1095716.html>; Ivan Kapustin, ["The 22nd Army Corps of the Black Sea Fleet are in Crimea,"] *RIA*, February 10, 2017, https://ria.ru/defense_safety/20170210/1487713296.html; Ivan Kapustin, ["The 22nd Army Corps of the Black Sea Fleet are in Crimea,"] *rambler.ru*, February 10, 2017, <https://news.rambler.ru/politics/36066460-v-krymu-sformirovan-22-y-armeyskiy-korpus-chernomorskogo-flota/>
- 131 ["In Crimea, a reconnaissance brigade was formed,"] *Live Journal*, March 7, 2015, <https://bmpd.livejournal.com/1209860.html>; ["Militarization of Crimea: the results of four years of occupation,"] *Information Resistance*, February 20, 2018, <http://sprotvy.info/ru/news/kyev/militarizaciya-kryma-itogi-chetyreh-let-okkupacii>
- 132 Konstantin Bogdanov, ["Vespiary,"] *lenta.ru*, March 16, 2016, <https://lenta.ru/articles/2016/03/16/crimea/>
- 133 ["Tankmen hit moving targets on exercises in Crimea,"] *TV Zvezda*, September 10, 2017, <https://tvzvezda.ru/news/forces/content/201709101149-31p2.htm>; ["12676th Coastal Defense Brigade,"] *Vkontakte*, <https://vk.com/club70915841>
- 134 ["Black Sea Fleet - Russia,"] *ru.wikipedia*, https://ru.wikipedia.org/wiki/%D0%A7%D0%B5%D1%80%D0%BD%D0%BE%D0%BC%D0%BE%D1%80%D1%81%D0%BA%D0%B8%D0%B9_%D1%84%D0%BB%D0%BE%D1%82_%D0%92%D0%9C%D0%A4_%D0%A0%D0%BE%D1%81%D1%81%D0%B8%D0%B8; ["Military service on the Black Sea Fleet,"] *Military Units of Russia*, November 14, 2016, <http://prizyvnik-soldat.ru/sluzhba-po-kontraktu-na-chernomorskom-flote/>
- 135 ["Marines from the 810th separate brigade of the Black Sea Fleet were identified in Donbass 12 km from Mariupol,"] *Petrimazepa*, October 25, 2016, <https://petrimazepa.com/russianmarinenearmariupol.html>; ["Marine Corps of the Black Sea Fleet of Russia arrived in the occupied Donbass,"] *New Time*, March 24, 2016, <http://ny.ua/ukraine/events/v-okkupirovannyj-donbass-pribyla-brigada-morskoj-pehoty-chernomorskogo-flota-razvedka-105450.html>
- 136 ["Caspian Flotilla,"] *Russian Federation Ministry of Defense*, <http://structure.mil.ru/structure/forces/type/navy/kasp.htm>; ["Pinchuk Sergey Mikhailovich - Biography,"] *Russian Federation Ministry of Defense*, <http://structure.mil.ru/structure/forces/type/navy/kasp/leader.htm>; ["Caspian Flotilla,"] *MilkaKaz.com*, June 6, 2017, <http://milkaKaz.com/index.php/voorujonnie-cili-racii/vmf/kacpiiskaia-flotilia>
- 137 ["414th Separate Marine Battalion, Military Unit 95152, Kaspiisk,"] *Mr Typhoon*, August 13, 2015, http://mptaifun.ru/blog/414_j_otdelnyj_batalon_morskoj_pehoty_kaspijskoj_flotilii_v_ch_95152/2015-08-13-240; Dmitry Boltentkov, "The Russian Marine Corps,," *Base History*, <http://bazaistoria.ru/blog/43341649641/The-Russian-Marine-Corps.-Morskaya-pehota-Rossii>
- 138 ["727th Separate Battalion, Military Unit 20264,"] *Vkontakte*, <https://vk.com/marines727>; ["727th Separate Guards Marine Battalion,"] *eurasian-defense.ru*, <http://eurasian-defence.ru/?q=node/28195>
- 139 ["Central Military District. Dossier,"] TASS, November 27, 2017, <http://tass.ru/info/4763078>; ["Lapin Alexander Pavlovich - Biography,"] *Russian Federation Ministry of Defense*, https://structure.mil.ru/management/info.htm?id=11559589@SD_Employee; ["Central Military District,"] *MilkaKaz.com*, June 6, 2017, <http://milkaKaz.com/index.php/voorujonnie-cili-racii/vo-cv/te-vo>
- 140 ["2nd Guards Red Banner Combined Arms Army,"] *Russian Federation Ministry of Defense*, <http://structure.mil.ru/structure/okruga/details.htm?id=11252@egOrganization>; ["2nd Guards Combined-Arms Red Banner Army,"] *Mama Soldata*, October 18, 2016, <http://mamasoldata.mybb.ru/viewtopic.php?id=5078>; ["Anti-aircraft missile brigade - on duty in the Penza region,"] *Penza News*, December 5, 2017, <http://npnz.ru/politics/zenitnaya-raketnaya-brigada-na-boevom-dezhurstve-v-penzenskoy-oblasti/>; Anton Vernitsky, ["At a meeting with officers and prosecutors, the Russian president spoke about the tasks of ensuring the security of the citizens of the country,"] *News 1*, October 26, 2017, <https://www.itv.ru/news/2017-10-26/335152-na-vstreche-s-ofitserami-i-prokurorami-prezident-rf-govoril-o-zadachah-po-obespecheniyu-bezopasnosti-grazhdan-strany>; Alexander Balitsky, ["The President thanked the officers and set new tasks for them,"] *Vesti*, October 26, 2017, <https://www.vesti.ru/doc.html?id=2947776>
- 141 ["Military Unit 45863 in the Samara region,"] *Conscript Soldier*, January 11, 2017, <http://prizyvnik-soldat.ru/vch-45863-roshchinski/>; ["Military Unit 45863 - 30th motorized rifle brigade,"] *Vkontakte*, https://vk.com/vch_45863; ["In Ufe, Men join the military by contract,"] *Fn24*, March 29, 2017, <http://fn24.ru/region/9/society/14558>
- 142 ["Military Unit 90600 - 15th Independent Guards Motorized Rifle Brigade,"] *Military Units of Russia*, February 3, 2017, <http://vojskovayachast.ru/vch90600/>; ["Peacekeeping brigade from the Samara region will be transferred to exercise in Tajikistan,"] *Lenta*, March 27, 2017, <https://lenta.ru/news/2017/03/27/brigade/>; https://www.samara.kp.ru/daily/26597_4/3612752/; ["15th Separate Guards Motorized Rifle Brigade (Roshchinsky,") *Wikimapia*, <https://www.google.com/url?q=http://wikimapia.org/%23lang%3Den%26lat%3D53.050733%26lon%3D50.489291%26z%3D17%26m%3Db%26show%3D/15245403/ru/15-%25D0%259E%25D1%2582%25D0%25B4%25D0%25B5%25D0%25BB%25D1%258C%25D0%25BD%25D0%25B0%25D1%258F-%25D0%25B3%25D0%25B2%25D0%25B0%25D1%2580%25D0%25B4%25D0%25B5%25D0%25B9%25D1%2581%25D0%25BA%25D0%25B0%25D1%258F-%25D0%259C%25D0%25BE%25D1%2582%25D0%25BE%25D1%2581%25D1%2582%25D1%2580%25D0%25B5%25D0%25BB%25D0%25BA%25D0%25BE%25D0%25B2%25D0%25B0%25D1%258F-%25D0%2591%25D1%2580%25D0%25B8%25D0%25B3%25D0%25B0%25D0%25B4%25D0%25B0%26search%3Dsamara&sa=D&ust=1150590079-878000&usq=AFQjCNGCphGPRGtSxcdPOwVdThX2o2Yuw>; ["15th brigade of the Russian Federation sent to Donbass,"] *Stop Terror*, July 12, 2017, <https://stopterror.in.ua/info/2017/07/15-brigada-rt-otpravlena-na-donbass/>; ["Military Unit 12128 - 21st Independent Guards Motorized Rifle Brigade,"] *Russian Military Units*, <http://vojskovayachast.ru/vch12128/>; ["21st separate motorized rifle brigade of 75 years,"] *Totskoe News*, December 19, 2016, <http://totskoe.ru/21-%D0%BE%D1%82%D0%B4%D0%B5%D0%BB%D1%8C%D0%B%D0%BE%D0%B9-%D0%BC%D0%BE%D1%82%D0%BE%D1%81%D1%82%D1%80%D0%B5%D0%BB%D0%BA%D0%BE%D0%B2%D0%BE%D0%B9-%D0%B1%D1%80%D0%B8%D0%B3%D0%B0%D0%B4%D0%B5-75-%D0%BB>; ["In the Samara region, a new motorized rifle brigade was formed,"] *Lenta*, November 30, 2016, <https://lenta.ru/news/2016/11/30/brigade/>; ["Project "Cargo-200 from Ukraine to Russia,"] *Peacekeeping-centre*, <http://peacekeeping-centre.in.ua/Museum/East/Ubit/Gruz-200.htm>; ["Officers of the Totsky garrison congratulated on the Day of the Defender of the Fatherland,"] *Totskoe News*, February 27, 2017, http://www.totskoe.org/news/index.php?ELEMENT_ID=43140
- 143 ["Military Unit 12128 - 21st Independent Guards Motorized Rifle Brigade,"] *Russian Military Units*, <http://vojskovayachast.ru/vch12128/>; ["21st separate motorized rifle brigade of 75 years,"] *Totskoe News*, December 19, 2016, <http://totskoe.ru/21-%D0%BE%D1%82%D0%B4%D0%B5%D0%BB%D1%8C%D0%BD%D0%BE%D0%B9-%D0%BC%D0%BE%D1%82%D0%BE%D1%81%D1%82%D1%80%D0%B5%D0%BB%D0%BA%D0%BE%D0%B2%D0%BE%D0%B9-%D0%B1%D1%80%D0%B8%D0%B3%D0%B0%D0%B4%D0%B5-75-%D0%BB>; ["In the Samara region, a new motorized rifle brigade was formed,"] *Lenta.ru*, November 30, 2016, <https://lenta.ru/news/2016/11/30/brigade/>; ["Project "Cargo-200 from Ukraine to Russia,"] *Peacekeeping-centre*, <http://peacekeeping-centre.in.ua/Museum/East/Ubit/Gruz-200.htm>; ["Officers of the Totsky garrison congratulated on the Day of the Defender of the Fatherland,"] *Totskoe news*, February 27, 2017, http://www.totskoe.org/news/index.php?ELEMENT_ID=43140
- 144 ["Fourth Iskander-M system set to be delivered to Russian army in November,"] *Interfax*, November 12, 2014, <https://www.rbth.com/news/2014/11/10/fourth-iskander-m-brigade-set-to-be-delivered-to-russian-army-in-novembe-41267.html>; Jeffrey Lewis, "Russia Deploys the Iskander to Kaliningrad,," *Arms Control Wonk*, December 11, 2016, <http://www.armscontrolwonk.com/archive/1202268/iskanders-in-kaliningrad/>; ["Officers of the Totsky garrison congratulated on the Day of the Defender of the Fatherland,"] *Totskoe News*, February 27, 2017, http://www.totskoe.org/news/index.php?ELEMENT_ID=43140; ["The 5th Army Missile Brigade in Primorye reequipped with Iskander-M missile systems,"] *News.mail.ru*, July 24, 2016, <https://news.mail.ru/politics/26543263/>; ["Military Unit 30785 (92nd Order of Kutuzov III class rocket brigade,") *Vkontakte*, <https://vk.com/club17754765>

- 145 Sergei Flev, ["Military Units of the Aggressor Country, Participating in War Crimes Against Ukraine and Its Citizens."] *Begemot*, April 27, 2017, <http://begemot.media/news/voinskije-chasti-strany-agrescora-uchastvuyushhie-v-sovershenii-voennyh-prestuplenij-protiv-ukrainy-i-ee-grazhdan/>; ["November 19th – Artillery and Missile Day."] *Voepro*, <https://voepro.ru/celebrar/19-noyabrya-den-raketnyh-vojsk-i-artillerii/>; ["Military Unit 32755."] *Vkontakte*, <https://vk.com/club23168784/>; ["The 385th Guards Artillery Brigade - Military Unit 32755."] *Russian Military Units*, <https://voinskayachast.net/suhoputnie-voyska/raketnie-i-artilleriya/vch32755>
- 146 ["950th Reactive - artillery regiment."] *Vkontakte*, <https://vk.com/artillerists/>; ["Central Military District."] *bastion-opk.ru*, January 6, 2017, <http://bastion-opk.ru/central-military-district/>
- 147 ["Central Military District."] *Bastion-opk*, January 6, 2017, <http://bastion-opk.ru/central-military-district/>; ["297th Anti-Aircraft Missile Brigade - Military Unit 02030."] *Russian Military Units*, <https://voinskayachast.net/vozdušno-kosmicheskie-sily/voenno-vozdušnie-sily/zrv/vcho2030/>; ["Military Unit 02030."] *Vkontakte*, <https://vk.com/club9391556/>; ["In Leonidovka the anti-aircraft gunners were awarded after exercises in Kapustin Yar."] *Penzainform*, October 24, 2017, <http://www.penzainform.ru/news/social/2017/10/24/v-leonidovke-zenitchikov-nagrادili-posle-uchenij-v-kapustinom-yare.html>
- 148 ["41st Combined-Arms Army."] Russian Federation Ministry of Defense, <http://structure.mil.ru/structure/okruga/details.htm?id=11253@egOrganization>
- 149 ["Denis Igorevich Lyamin – Biography."] *chutku.ru*, <http://www.chutku.ru/?pid=2289/>; ["90th Guards Tank Division."] *Revolyt*, <https://www.revolvy.com/main/index.php?s=90th%20Guards%20Tank%20Division&uid=15751/>; ["Tankmen from Chebarkul celebrated the birthday of their division."] *znak*, August 21, 2017, <https://www.znak.com/2017-08-21/tankisty-gvardeyev-iz-chebarkulya-otmetili-den-rozhdeniya-divizii/>; ["The tank division in the Urals will be formed before December 1st."] *TASS*, September 11, 2016, <http://tass.ru/armiya-i-opk/3612149>
- 150 ["In Chebarkul, a judo tournament was held for the newspaper "Yuzhnourals", dedicated to servicemen who are on special tasks."] *Gazeta-ch*, November 27, 2017, <http://gazeta-ch.ru/lentanovosti/6-novosti/7373-v-chebarkule-sostoyalsya-turnir-po-dzyudo-nash-prizy-gazety-yuzhnourals-posvyashchennyy-voennosluzhashchim-nakhodyashchimsya-na-vypolnenii-spetsialnykh-zadach.html>; Mikhail Trokhinin, ["Milovice, 239th Tank Regiment."] <https://www.youtube.com/watch?v=6AE5aNXQj2g>; Roman Skomorokhov, ["90th Guards Tank Division: the third attempt."] *Top War*, December 2, 2016, <https://topwar.ru/104799-90-ya-gvardeyskaya-tankovaya-diviziya-tretya-popytka.html>
- 151 Elena Nazarova, ["At the South Urals railway station the soldier got under the train."] *Chelyabinsk 74*, February 5, 2018, <https://chelyabinsk.74.ru/text/incident/395422403757568.html>; ["Who do the soldiers serve at Military Unit 93992, Chebarkul?."] *Ok Group*, <https://ok.ru/komitsetso/topic/656393959744769>
- 152 ["The legendary Vitebsk-Novgorod tank division was reconstructed in the Central Military District."] *RIA*, December 1, 2016, https://ria.ru/defense_safety/20161201/1482567340.html; ["90th Guards Tank Division: the third attempt."] *Top War*, December 2, 2016, <https://topwar.ru/104799-90-ya-gvardeyskaya-tankovaya-diviziya-tretya-popytka.html>; Irina Wolik, ["In the Chebarkul military unit, the ice hockey championship was held in honor of Valery Kharlamov."] *gazeta-ch.ru*, January 29, 2018, <http://gazeta-ch.ru/lentanovosti/6-novosti/7678-v-chebarkulskoj-voinskoj-chasti-sostoyalsya-chempionat-po-khokkeyu-s-shajboj-v-chest-valeriyi-kharlamova.html>
- 153 ["Military Unit 22316 Yekaterinburg address."] *Our Reference*, July 4, 2017, https://ekaterinburg.nashaspravka.ru/zdravstvujte-podskazhite-adres-g-ekaterinburg-v-ch-22316-228-motostrelkovyj-polk-3393745-https://vk.com/club30021404?w=wall-30021404_63
- 154 ["35th separate Guards Motor-rifle Volgograd-Kiev, Order of Lenin, the Red-Banner Order of Suvorov and Kutuzov brigade."] *Soldiers Mothers Forum*, May 22, 2013, <http://prizyvnikmoy.ru/forum/67-763-1;https://voinskayachast.net/suhoputnie-voyska/motostrelkovie/vch41659/>; ["Military Unit 41659 Aleysk."] *Vkontakte*, <https://vk.com/club19868307/>; ["The 35th Independent Guards Motorized Rifle Brigade (Military Unit 41659)."] *Nomad*, <https://www.youtube.com/watch?v=g85jYUoFUA>; ["Field of Fools' (Aleysk)."] *Wikimapia*, <http://wikimapia.org/#lang=en&lat=52.486883&lon=82.737565&z=15&m=b&show=26856669/ru>
- 155 ["Tuva celebrated the Defender of the Fatherland Day."] *Republic of Tuva*, February 26, 2018, http://www.rtyva.ru/press_center/news/society/35318/; ["The 55th Motorized Rifle Brigade in Tuva has a new commander."] *Tuvaonline.ru*, January 16, 2018, <https://www.tuvaonline.ru/2018/01/16/u-55-y-motostrelkovoy-brigady-v-tuve-novyy-komandir.html>; ["55th Separate Motorized Rifle Brigade (Mountain)."] *bastion-karpenko.ru*, January 5, 2018, http://bastion-karpenko.ru/55-obr_gorn/
- 156 ["Military Unit 21005 – 74th separate Guards Motorized Rifle Brigade."] *Military Units of Russia*, <http://voinskajachast.ru/suhoputnye-voyska/motostrelkovye-voyska/voyskovaya-chast-21005-74-ya-otdelnaya-gvard/>; ["Military Unit 21005 Yurga Kemerovo Region."] *Vkontakte*, <https://vk.com/club24246017/>; Irakli Komakhidze and Oleksandr Klymenko, ["The Russian 74th Brigade's Contract Servicemen Fight in Donbas As Hooligans."] *Inform Napalm*, October 12, 2015, <https://informnapalm.org/13538-74-omsbr-hooligans/>; ["Military Unit 21005."] *Ministry of Natural Resources and Environment of the Russian Federation*, [http://www.mnr.gov.ru/ecocontrol/detail.php?ID=48771/](http://www.mnr.gov.ru/ecocontrol/detail.php?ID=48771;); ["Military Unit 21005."] *Ok Group*, <https://ok.ru/group/51945980297452/>; ["The 74th Independent Guards Motorized Rifle Brigade, 106th Division, Logistics Support Team (Yurga)."] *Wikimapia*, [http://wikimapia.org/31966337/ru/74-%D1%8F-%D0%BE%D1%82%D0%B4%D0%B5%D0%BB%D1%8C%D0%BD%D0%B0%D1%8F-%D0%B3%D0%B2%D0%B0%D1%80%D0%B4%D0%B5%D0%B9%D1%81%D0%BA%D0%B0%D1%8F-%D0%BC%D0%BE%D1%82%D0%BE%D1%81%D1%82%D1%80%D0%B5%D0%BB%D0%BA%D0%BE%D0%B2%D0%B0%D1%8F-%D0%B1%D1%80%D0%B8%D0%B3%D0%B0%D0%B4%D0%B0-106-%D1%8F-%D0%BE%D1%82%D0%B4-%D0%91%D1%80%D0%B8%D0%B3%D0%B0%D0%B4%D0%B0-%D0%9C%D0%B0%D1%82%D0%B5%D1%80%D0%B8%D0%B0%D0%BB%D1%8C%D0%BD%D0%BE-%D0%A2%D0%B5%D1%85%D0%BD%D0%B8%D1%87%D0%B5%D1%81%D0%BA%D0%BE%D0%B3%D0%BE-%D0%9E%D0%B1%D0%B5%D1%81%D0%BF%D0%B5%D1%87%D0%B5%D0%BD%D0%B8%D1%8F](http://wikimapia.org/31966337/ru/74-%D1%8F-%D0%BE%D1%82%D0%B4%D0%B5%D0%BB%D1%8C%D0%BD%D0%B0%D1%8F-%D0%B3%D0%B2%D0%B0%D1%80%D0%B4%D0%B5%D0%B9%D1%81%D0%BA%D0%B0%D1%8F-%D0%BC%D0%BE%D1%82%D0%BE%D1%81%D1%82%D1%80%D0%B5%D0%BB%D0%BA%D0%BE%D0%B2%D0%B0%D1%8F-%D0%B1%D1%80%D0%B8%D0%B3%D0%B0%D0%B4%D0%B0-106-%D1%8F-%D0%BE%D1%82%D0%B4-%D0%91%D1%80%D0%B8%D0%B3%D0%B0%D0%B4%D0%B0-%D0%9C%D0%B0%D1%82%D0%B5%D1%80%D0%B8%D0%B0%D0%BB%D1%8C%D0%BD%D0%BE-%D0%A2%D0%B5%D1%85%D0%BD%D0%B8%D1%87%D0%B5%D1%81%D0%BA%D0%BE%D0%B3%D0%BE-%D0%9E%D0%B1%D0%B5%D1%81%D0%BF%D0%B5%D1%87%D0%B5%D0%BD%D0%B8%D1%8F;); ["Famous Wrestler Alexander Karelin paid a visit to the servicemen of the 74th separate guards motorized rifle brigade, stationed in the city of Yurga."] *Russian Federation Ministry of Defense*, https://function.mil.ru/function/public_board/activities/events/more.htm?id=11969516@cmsArticle; ["A group of tank men of the 74th Brigade of the Russian Armed Forces who fought in the Donbas, are identified."] *petrimazepa.com*, October 14, 2016, <https://petrimazepa.com/groupofankmen.html>
- 157 ["201st military base Tajikistan."] *Vkontakte*, <https://vk.com/club55193083/>; Alexander Khrolenko, ["Why does Russia strengthen its military bases in Tajikistan and Kyrgyzstan?."] *RIA*, June 7, 2017, https://ria.ru/defense_safety/20170607/1496044411.html
- 158 Lyudmila Garkavaya, ["Service in the 201st military base."] *fb.ru*, September 10, 2017, [http://fb.ru/article/340908/voennaya-baza-sljuba-v-y-voennoy-baze/](http://fb.ru/article/340908/voennaya-baza-sljuba-v-y-voennoy-baze;); ["President Vladimir Putin presented state awards to servicemen who distinguished themselves during the operation in Syria."] *Vladimir-pelevin.blogspot.com*, December 29, 2017, http://vladimir-pelevin.blogspot.com/2017/12/blog-post_30.html
- 159 ["Russian motorized rifle regiment in Tajikistan transferred to Dushanbe."] *lenta.ru*, November 19, 2015, <https://lenta.ru/news/2015/11/19/mosp/>; ["The mutiny in Dushanbe will be suppressed by the Russian infantry."] *svpressa.ru*, December 17, 2015, <http://svpressa.ru/war21/article/138432/>
- 160 ["Russian military bases and facilities abroad: Kazakhstan, Tajikistan, Kyrgyzstan."] *Eurasia Expert*, <http://eurasia.expert/rossiyskie-voennye-bazy-i-obekty-za-rubezhom-asia/>; ["201st MSD Tajikistan (Kurgan-Tube)."] *Ok Group*, <https://ok.ru/group/51595230511258>

- 161 ["Central Military District,"] *bastion-opk.ru*, January 6, 2017, <http://bastion-opk.ru/central-military-district/>; ["119th Rocket Brigade,"] *Military units of the Sverdlovsk Region and Yekaterinburg*, <http://voenskie-chasti-ekb.ru/item/119-ya-rocketnaya-brigada/>; ["The missile brigade will receive new infrastructure,"] *pravdaurfo.ru*, September 8, 2016, <http://pravdaurfo.ru/category/tegi/119-rocketnaya-brigada/>; ["119th Rocket Brigade,"] *Vkontakte*, <https://vk.com/club38349052>; Mikhail Voskresensky, ["The Ministry of Defense will receive two more 'Iskander-M' missile systems,"] *Top War*, August 24, 2017, <https://topwar.ru/123371-minoborony-poluchit-esche-dve-brigady-iskander-m.html>; ["119th Rocket Brigade,"] *Vkontakte*, <https://vk.com/club38349052>; ["The 120th Artillery Brigade,"] *Zarplata*, September 4, 2015, <https://www.zarplata.ru/companies/12750343/>; ["Division of the 120th artillery brigade from Yurga to Millerovo,"] *Live Journal*, May 6, 2015, <https://volnodum.livejournal.com/1290778.html>; ["Yurga: Military Unit 59361, Military Unit 21005, Military Unit 72154,"] *Vkontakte*, <https://vk.com/club44345421>; Victor Alksnis, ["5th howitzer battery of the 120th Artillery Brigade of the Russian Armed Forces fights in Syria,"] *APN*, November 19, 2015, <http://www.apn-spb.ru/opinions/article22711.htm>; ["Private Ponyaev (Rep. of Tajikistan, 201 military base,") *Ok Group*, <https://ok.ru/video/11364402451>; Irakly Komakhidze, ["Division of the 120th artillery brigade from Yurga to Millerovo,"] *InformNapalm*, May 6, 2015, <https://informnapalm.org/8771-podrazdelenye-120-j-artilleryjskoj-brygady-yz-yurgy-v-myllerovo/>; Irakli Komakhidze, ["Ukrainian mission" of the 120th Artillery Brigade of the Russian Army,"] *InformNapalm*, March 3, 2017, <https://informnapalm.org/31188-svidetelstva-komandirovki-120-j-artilleryjskoj-brigady/>
- 162 ["120th Artillery Brigade - Military Unit 59361,"] *Russian Military Units*, <https://voinskayachast.net/suboputnie-voyska/rocketnie-i-artilleriya/vch59361/>; <http://svpressa.ru/war21/article/136301/>
- 163 ["61st Anti-aircraft missile brigade Central Military District,"] *Military Air Defense*, <http://vpvovsvo.infomost.ru/2015/pdf/2-11.pdf>; ["61st Anti-aircraft Missile Brigade,"] *Ok Group*, <https://ok.ru/voyskovoep/album/57746877186099>
- 164 Pozdin Sergey Vitalevich, ["History of the military garrison 'Topchikha I,'] *Top-Culture*, February 2, 2017, <http://museum.top-culture.ru/istoriya-voennogo-garnizona-topchikha-i/>; Pozdin Sergey Vitalevich, ["History of the military garrison 'Topchikha I,'] *Top-Culture*, February 2, 2017, <http://museum.top-culture.ru/istoriya-voennogo-garnizona-topchikha-i/>; ["Military Unit 55121,"] *Vkontakte*, <https://vk.com/club84122316>
- 165 ["35th Management Brigade - Military Unit 57849,"] *Russian Military Units*, <https://voinskayachast.net/suboputnie-voyska/specialnie/vch57849/>; ["Military 57849,"] *Mama Soldata*, October 31, 2015, <http://mamasoldata.mybb.ru/viewtopic.php?id=3324&p=6>; ["Military Unit 57849,"] *Vkontakte*, <https://vk.com/club12447687>; ["35th Management Brigade, Tallinn Order of the Red Star,"] *Zarplata*, October 29, 2012, <https://nsk.zarplata.ru/companies/2821237/>; ["In Novosibirsk the Major, who killed his wife on Victory Day, received 10 years of strict security,"] *news-ru.com*, January 22, 2016, <https://m.newsru.com/crime/22jan2016/majormwife9maysnt.html>; ["35th Tallinn Order of the Red Star Communication Brigade,"] *Wikimapia*, <http://wikimapia.org/11150572/ru/35-%D1%8F-%D0%A2%D0%B0%D0%BB%D0%BB%D0%B8%D0%BD%D1%81%D0%BA%D0%B0%D1%8F-%D0%BE%D1%80%D0%B4%D0%B5%D0%BD%D0%B0-%D0%9A%D1%80%D0%B0%D1%81%D0%BD%D0%BE%D0%B9-%D0%97%D0%B2%D0%B5%D0%B7%D0%B4%D1%8B-%D0%91%D1%80%D0%B8%D0%B3%D0%B0%D0%B4%D0%B0-%D1%81%D0%B2%D1%8F%D0%B7%D0%B8>
- 166 ["New academic year for the Jurgen military began with an excellence in service award,"] *Yurga*, December 1, 2016, <http://www.yurga.org/news.html?nwid=4396>; ["Military Unit 72154,"] *Vkontakte*, <https://vk.com/club56156815>; ["Car Troops Military Unit 72154,"] *Ok Group*, <https://ok.ru/group/51891688964349>; ["Military Unit 72154 Information,"] *Mama Soldata*, <http://mamasoldata.mybb.ru/viewforum.php?id=461>
- 167 A.V.Karpenko, ["28th Anti-Aircraft Missile Brigade of the Central Military District,"] *Bastion-opk*, <http://bastion-opk.ru/28zrb/>; ["28th Air Defense Missile Brigade,"] *Chelyabinsk Region*, October 27, 2014, <http://chelindustry.ru/view2.php?idd=1601&rr=10>; ["The anti-aircraft missile regiment with S-400 began combat duty outside of Moscow,"] *VPK*, January 11, 2017, https://vpk.name/news/172398-zenitnyj-raketnyj-polk_s_400_zastupil_na_boevoe_dezhurstvo_v_podmoskove.html
- 168 ["Structure of the Eastern Military District,"] *Russian Federation Ministry of Defense*, <https://structure.mil.ru/structure/okruga/east/structure.htm>; Inna Sidorkova, ["Russian group in Syria found a new commander,"] *RBC*, November 2, 2017, <https://www.rbc.ru/politics/02/11/2017/59faf43e9a7947fe3ef01c99>; Ivan Safronov, Alexandra Djordjevic, and Musa Muradov, ["General with a Syrian look at the VCS,"] *kommersant.ru*, September 22, 2017, <https://www.kommersant.ru/doc/3417067>; ["Eastern Military District,"] *MilkaKaz.com*, June 6, 2017, <http://milkavkaz.com/index.php/voorujonnie-cilj-racii/vo-cv/vvo>
- 169 ["5th Krasnoznamennaya Combined Arms Army,"] *Russian Federation Ministry of Defense*, <http://structure.mil.ru/structure/okruga/details.htm?id=11244@egOrganization>; ["Ukrainian intelligence: Russian air defense brigade in Donbas harbinger of offensive campaign,"] *euromaidan press*, August 20, 2016, <http://euromaidanpress.com/2016/08/20/ukrainian-intelligence-spots/#arvlbdata>
- 170 ["70th Selected Motor-Square Brigade Military Unit 24776,"] *Ok Group*, <https://ok.ru/group70tdelnyaj>; ["Service on contract in Ussuriysk,"] *farpost.ru*, <http://www.farpost.ru/ussurijsk/job/vacancy/sluzhba-po-kontraktu-v-g-ussurijske-45507373.html>; ["Military Unit 24776,"] *Vkontakte*, <https://vk.com/uss24776>
- 171 ["Military Unit 44980,"] *Vkontakte*, https://vk.com/vch_44980; ["Servicemen of Military Unit 44980,"] *Vkontakte*, <https://vk.com/club21270023>; Alena Telegina, ["Oath of the military unit 44980 in Sergeevka July 24, 2016,"] <https://www.youtube.com/watch?v=r0EZ36GvxX8>; ["Soldier died while working in Sergeevka,"] *vl.ru*, December 15, 2016, <http://www.news1.ru/accidents/2016/12/15/154566/>
- 172 ["Separate motorized rifle brigade of military unit 46102,"] *Ok Group*, <https://ok.ru/group/52255412519152>; ["Military Unit 46102 Khabarovsk region Bikin,"] *Vkontakte*, <https://vk.com/club16121248>; ["Military Unit 46102,"] *Vkontakte*, <https://vk.com/club28422871>; ["Military Unit 46102,"] *Rusprofile*, <http://www.rusprofile.ru/id/7020281>; ["Combat route 57 of the separate guards Krasnogorsky Red Banner Order of Suvorov,"] *Ministry of Social Protection of Population of Khabarovsk Krai*, <https://mszn27.ru/node/25253>
- 173 ["Oath of Military Unit 16871,"] *Conscript Soldier*, <https://www.youtube.com/watch?v=husvDmTSMhs>; ["Demobilization of Military Unit 16871,"] *Ok Group*, <https://ok.ru/group/50830221836501>; ["Military Unit 16871,"] *Vkontakte*, <https://vk.com/club18998669>
- 174 ["The 20th Guards missile brigade received a set of 'Iskander-M' missiles,"] *Live Journal*, June 29, 2016, <http://bmpd.livejournal.com/1988614.html>; ["A new set of Iskander-M missiles received by the Guard of the Motherland,"] *Kbm*, <http://www.kbm.ru/ru/press-centre/791.html>
- 175 ["In two cities in Primorye, a set of fireworks,"] *East Media*, February 21, 2017, <http://www.vostokmedia.com/r2/21-02-2017/n317250.html>; ["Military service under contract in Ussuriysk,"] *Farpost*, <http://www.farpost.ru/ussurijsk/job/vacancy/voennaja-sluzhba-po-kontraktu-v-305-abr-45977944.html>; ["Seaside servicemen won awards of the Eastern Military District Championship in the ARB in Chita,"] *News1*, March 8, 2017, <http://www.news1.ru/sport/2017/03/08/157183/>; ["Exercises in Ussuriysk: the military destroyed 50 'terrorists,'] *Vesti*, October 29, 2016, <http://www.vesti.ru/videos/show/vid/696308/cid/1/>; Maxim Tikhonov, ["Gunners in Ussuriysk trained in striking the conventional enemy,"] *News1*, November 18, 2016, <http://www.news1.ru/photos/2016/11/18/153638/>
- 176 ["Military Unit 36411,"] *Vkontakte*, <https://vk.com/clubpv036411>; ["Military Unit 36411,"] *Ok Group*, <https://ok.ru/group/50775721967774>; ["Gunners in Ussuriysk trained in striking the conventional enemy,"] *News1*, November 18, 2016, <http://www.news1.ru/photos/2016/11/18/153638/>
- 177 ["Military Unit 58079,"] *Vkontakte*, <https://vk.com/rhbz58079>; ["Chemical Corps of the Eastern Military District passed final examinations in practice,"] *RIA Novosti*, October 21, 2016, https://ria.ru/defense_safety/20161021/1479690644.html; ["Military units of Blagoveshchensk and the Amur Region,"] *Russian Military Units*, <https://voinskayachast.net/goroda/blagoveshchensk-i-amurskaya-oblast>
- 178 ["35th Army Congratulated on the 72th Anniversary of the Victory in Belogorsk,"] *amur.info*, May 6, 2017, <http://www.amur.info/news/2017/05/06/124235/>; ["The 35th Krasnoznamennaya Combined Arms Army,"] *Russian Federation Ministry of Defense*, <http://structure.mil.ru/structure/okruga/details.htm?id=11248@egOrganization>; ["Military Unit 21720 in Belogorsk,"] *Wikimapia*, <http://wikimapia.org/#lang=en&lat=50.905252&lon=128.480043&z=15&m=b&tag=516&show=19515723/ru/%D0%B2-%D1%87-21720&search=belogorsk>

- 179 ["Military Unit 51460 – 64th separate motorized rifle brigade of Khabarovsk, Mlechnik."] *Russian Military Units*, January 5, 2017, <http://prizyvnik-soldat.ru/vch-51460-habarovsk-mlechnik/>; ["Military Unit 51460 Khabarovsk."] *Vkontakte*, https://vk.com/vch_51460; ["Military Unit 51460."] *Vkontakte*, <https://vk.com/64omsbr>; ["64th separate motorized rifle brigade - Military Unit 51460."] *Russian Military Units*, <https://voinskayachast.net/suhoputnie-voyska/motostrelkovie/vch51460>
- 180 ["Military Unit 21720 in Yekaterinoslavka."] *Ok Group*, <https://ok.ru/video/48607660641>; ["Military Unit 21720 in Yekaterinoslavka."] *Ok Group*, <https://ok.ru/group/50534372475023>; ["Military Unit 21720."] *Vkontakte*, https://vk.com/vch_21720; One ["The 38th Independent Guards Motorized Rifle Brigade - Military Unit 21720."] *Russian Military Units*, <https://voinskayachast.net/suhoputnie-voyska/motostrelkovie/vch21720>; ["Military Unit 21720."] *Vkontakte*, <https://vk.com/club21452858>; Vladislav Romanov, ["Military Unit 21720."] <https://www.youtube.com/watch?v=wnsC1DHRh9o>
- 181 ["The commander of the Cossack brigade in the Jewish Autonomous Region was burned on firewood."] *deita.ru*, January 17, 2017, <http://deita.ru/news/incidents/17.01.2017/5180636-komandir-kazachey-brigady-v-evreyskoy-ao-pogorel-na-drovakh/>; ["The 69th separate Cossack cover-up brigade - Military Unit 61424."] *Russian Military Units*, <https://voinskayachast.net/suhoputnie-voyska/motostrelkovie/vch61424>; ["Separate 69th cover brigade."] *Vkontakte*, <https://vk.com/club39381127>; Irakly Komakhidze, ["Division of the 69th Covering Brigade from Birobidzhan in Millerovo."] *Inform Napalm*, April 24, 2015, <https://informnapalm.org/8240-podrazdelenye-69-j-brigady-prikrityya-yz-byrobydzhan-v-mylerovo/>
- 182 ["71st anti-aircraft missile brigade."] *Wikimapia*, <http://wikimapia.org/#lang=en&lat=50.690042&lon=128.024712&z=14&m=b&show=20487143/ru/71-зенитная-ракетная-бригада&search=Srednebeloe-2>; ["Military units of Blagoveshchensk and the Amur Region."] *Russian Military Units*, <https://voinskayachast.net/goroda/blagoveshchensk-i-amurskaya-oblast>; ["71st Anti-aircraft missile brigade."] *Vkontakte*, <https://vk.com/club46512322>
- 183 Guy Plopsky, "Why Is Russia Aiming Missiles at China?," *The Diplomat*, July 12, 2017, <https://thediplomat.com/2017/07/why-is-russia-aiming-missiles-at-china/>; ["The 20th Guards missile brigade received a set of "Iskander-M" missiles."] *Live Journal*, June 29, 2016, <http://bmpd.livejournal.com/1988614.html>; ["Why Is Russia Aiming Missiles at China?"] *Cyan Factory*, <https://www.youtube.com/watch?v=dKWt1IDcuHo>
- 184 ["Military units of Blagoveshchensk and the Amur Region."] *Russian Military Units*, <https://voinskayachast.net/goroda/blagoveshchensk-i-amurskaya-oblast>; ["Military Unit 02901 Belogorsk Amur Region."] *Mama Soldata*, January 22, 2016, <http://mamasoldata.mybb.ru/viewtopic.php?id=3860>
- 185 ["Amur Region, Belogorsk, 35th Regiment."] *Ok Group*, <https://ok.ru/komitetsa/topic/65544657472257>; ["Amur Region, Belogorsk, 35th Regiment."] *Vkontakte*, https://vk.com/wall-1053960_3885?reply=4047; ["Military Unit 72157 - Belogorsk, the Amur Region."] *Prizyvnik*, August 31, 2016, <https://www.prizyvnik.info/threads/136447-v-ch-72157-avtobat-belogorsk-amurskaya-oblast/page4>
- 186 ["The 54th management brigade - Military Unit 53790."] *Russian Military Units*, <https://voinskayachast.net/suhoputnie-voyska/specialnie/vch53790>; ["Amurskaya Oblast, Belogorsk, 54th Separate Brigade of Communication, Military Unit 53790."] *Vkontakte*, <https://vk.com/club24654698>; ["70th anniversary of the brigade of communication in Belogorsk."] *GTRKamur*, <https://www.youtube.com/watch?v=k1p1I07cCDM>
- 187 ["103rd OWMS."] *Vkontakte*, <https://vk.com/public68097629>; ["Military Unit 72157 - Belogorsk, the Amur Region."] *Prizyvnik*, November 21, 2011, <https://www.prizyvnik.info/threads/136447-v-ch-72157-avtobat-belogorsk-amurskaya-oblast/page2>
- 188 ["36th Combined-Arms Army."] *Russian Federation Ministry of Defense*, <http://structure.mil.ru/structure/okruga/details.htm?id=11249@egOrganization>; ["In Buryatia, a new anti-aircraft missile brigade of the Russian Ground Forces was given a Buk-M2 missile defense system."] *Arms-expo*, December 4, 2016, <http://www.arms-expo.ru/news/vooruzhenie-i-voennaya-tehnika/v-buryatii-sformirovana-novaya-zenitnaya-raketnaya-brigada-suhoputnykh-voysk-na-zrs-buk-m2/>; ["Major-General Mikhail Nosulev was appointed commander of the combined-arms army of the Eastern Military District."] *Russian Federation Ministry of Defense*, October 14, 2017, http://function.mil.ru/news_page/country/more.htm?id=12146115@egNews&print=true
- 189 ["The 5th Independent Guards Tank Brigade - Military Unit 46108."] *Russian Military Units*, <https://voinskayachast.net/suhoputnie-voyska/tankovie/vch46108>; ["5th Tank Brigade Military Unit 46108."] *Vkontakte*, <https://vk.com/club25820264>; Dima Leonov, ["Field concert of the 5th tank brigade."] <https://www.youtube.com/watch?v=APCnmP2zgao>; ["The 5th Tank brigade of the Russian Armed Forces in the battles for Debal'tsevo."] *Live Journal*, April 1, 2015, <https://sled-vzayt.livejournal.com/2099.html>; ["The 5th Armored Brigade in Ukraine. Investigation."] *Om TV*, <https://www.youtube.com/watch?v=ZS2FsE9oAxo>; ["The 36th Army from Ulan-Ude won the Army Spartakiad."] *Today*, March 18, 2017, <http://today.ru/news/society/10140009/>
- 190 ["Military Unit 69647 Kyakhta - 37th OMSB."] *Russian Military Units*, <http://voinskajachast.ru/suhoputnie-voyska/motostrelkovye-voyska/vch-69647-kyakhta-37-aya-omsbr/>; ["The 37th Independent Guards Motorized Rifle Brigade Military Unit 69647."] *Russian Military Units*, <https://voinskayachast.net/suhoputnie-voyska/motostrelkovie/vch69647>; ["Military Unit 69647, Kayhta."] *Vkontakte*, <https://vk.com/club69658298>; ["The 36th Army from Ulan-Ude won the Army Spartakiad."] *Today*, March 18, 2017, <http://today.ru/news/society/10140009/>
- 191 ["30th Artillery Brigade."] *Russian Imperial Army*, <http://regiment.ru/reg/IV/B/30/1.htm>; ["Military Unit 62048 Ulan Ude."] *Prizyvnik*, November 17, 2016, <https://www.prizyvnik.info/threads/155207-vch-62048-ulan-ude/page33>; ["The 36th Army from Ulan-Ude won the Army Spartakiad."] *Today*, March 18, 2017, <http://today.ru/news/society/10140009/>
- 192 ["In the Eastern Military District, a new missile brigade was formed and equipped with Iskander-M missiles."] *Live Journal*, June 10, 2017, <https://bmpd.livejournal.com/2661082.html>; ["Air Defense Brigade in Buryatia Re-equips Buk-M3 missiles."] *Top War*, June 13, 2017, <https://topwar.ru/117870-brigada-pvo-v-buryatii-perevooruzhaetsya-na-kompleksy-buk-m3.html>
- 193 Guy Plopsky, "Why Is Russia Aiming Missiles at China?," *The Diplomat*, July 12, 2017, <https://thediplomat.com/2017/07/why-is-russia-aiming-missiles-at-china/>; ["The 36th Army from Ulan-Ude won the Army Spartakiad."] *Today*, March 18, 2017, <http://today.ru/news/society/10140009/>
- 194 ["The 36th Army from Ulan-Ude won the Army Spartakiad."] *Today*, March 18, 2017, <http://today.ru/news/society/10140009/>; <https://vk.com/club21934422>; ["75th Management Brigade - Military Unit 01229."] *Russian Military Units*, <https://voinskayachast.net/suhoputnie-voyska/specialnie/vch01229>
- 195 ["102nd separate logistics support brigade - Military Unit 72155."] *Russian Military Units*, <https://voinskayachast.net/suhoputnie-voyska/specialnie/vch72155>; ["102nd separate logistic support brigade - Military Unit 72155 (Pine Forest)."] *Wikimapia*, <http://wikimapia.org/#lang=en&lat=51.849247&lon=107.887545&z=14&m=b&show=21168462/ru/102-%D1%8F-%D0%BE%D1%82%D0%B4%D0%B5%D0%BB%D1%8C%D0%BD%D0%B0%D1%8F-%D0%B1%D1%80%D0%B8%D0%B2%D0%B0%D0%B4-%D0%B0-%D0%BC%D0%B0%D1%82%D0%B5%D1%80%D0%B8%D0%B0%D0%BB%D1%8C%D0%BD%D0%BE-%D1%82%D0%B5%D1%85%D0%BD%D0%B8%D1%87%D0%B5%D1%81%D0%BA%D0%BE%D0%B2%D0%BE-%D0%B1%D0%B5%D1%81%D0%BF%D0%B5%D1%87-%D0%B5%D0%BD%D0%B8%D1%8F-%E2%80%94%D0%B2%D0%BE%D0%B9%D1%81%D0%BA%D0%BE%D0%B2%D0%B0%D1%8F-%D1%87%D0%B0%D1%81%D1%82%D1%8C-72155&search=ulan-ude>
- 196 ["29th Combined Arms Army."] *Russian Federation Ministry of Defense*, <http://structure.mil.ru/structure/okruga/details.htm?id=11245@egOrganization>; ["Commander of the 29th Army from Chita Avdeev became commander of the tank army in the suburbs."] *The Transbaikalian worker*, May 6, 2017, <http://забрабо.чй.рф/News/157923/>
- 197 ["36th Motorized Rifle Brigade."] *arms-expo.ru*, June 30, 2017, <http://www.arms-expo.ru/articles/124/87068/>; ["36th separate motorized rifle brigade - Military Unit 06705."] *Russian Military Units*, <https://voinskayachast.net/suhoputnie-voyska/motostrelkovie/vch06705>; ["36th Motorized Rifle Brigade."] *Vkontakte*, <https://vk.com/club20675936>; Irakly Komakhidze, ["A subdivision of the 36th Brigade from Transbaikalia was transferred to the Rostov Region."] *Inform Napalm*, April 21, 2015, <https://informnapalm.org/8175-v-rostovskuyu-oblast-perebrosheno-podrazdelenye-36-j-brigady-yz-zabajkalya/>; ["Borzya-3 Military Unit 06705."] *Vkontakte*, <https://vk.com/club12922909>; Alisher Makhmudov, ["Drive to Tsugol. Borzya-3, Military Unit 06705."] <https://www.youtube.com/watch?v=YrKW8tPNjX4>

- 198 Denis Mokrushin, ["200th Artillery Brigade,"] *arms-expo.ru*, February 22, 2017, <http://www.arms-expo.ru/articles/124/83266/>; ["Military Unit 48271 in Gornyy, Trans-Baikal Territory (200th Artillery Brigade),"] *prizyunik.info*, November 19, 2014, <https://www.prizyunik.info/threads/147447-v-ch-48271-p-gornyy-zabaykalskiy-kray-200-ya-artillerijskaya-brigada>; ["200th Artillery Brigade,"] *Vkontakte*, <https://vk.com/club90728017>
- 199 Guy Plopsky, "Why Is Russia Aiming Missiles at China?," *The Diplomat*, July 12, 2017, <https://thediplomat.com/2017/07/why-is-russia-aiming-missiles-at-china/>; "Iskander-M in Kaliningrad," *Russian Defense Policy*, November 27, 2017, <https://russiandefpolicy.blog/tag/iskander-m/>
- 200 ["Military Unit 32390,"] *Vkontakte*, <https://vk.com/club26408907>
- 201 ["List of military units in Chita and the Trans-Baikal Territory,"] *Russian Military Units*, <https://voinskayachast.net/goroda/chita-i-zabaykalskiy-kray>; ["Military Unit 11387 or 98605,"] *Our Reference*, <https://chita.nashspravka.ru/voennaya-chasti-11387-ili-zhe-98605-chita-poselok-kashtak-telefon-dezhurnogo-po-chasti-3042834>; ["The 104th separate logistics support brigade - Military Unit 11387,"] *Russian Military Units*, <https://voinskayachast.net/suhoputnie-voyska/specialnie/vch11387>; ["Military Unit 11387, Chita,"] *Vkontakte*, <https://vk.com/brigada104>
- 202 Cyril Yasko, ["Paratrooper Dmitry Glushenkov will lead the Sakhalin 68th Army Corps,"] *Sakhalin.info*, February 3, 2017, <https://sakhalin.info/news/127495>; Vadim Gorbunov, ["68th Army Corps will transfer to contract manning system,"] *skr.su*, August 30, 2016, <https://skr.su/news/262685>; Kirill Ivanov, ["The Commander-in-Chief of the Land Forces of Russia inspects the 68th Army Corps on Sakhalin,"] *Riafan*, October 19, 2016, <https://riafan.ru/565890-glavkom-suhoputnyh-voisk-rossii-inspektiruet-68-i-armeiskii-korpus-na-sahaline>; ["On Sakhalin, the memory of the deceased in Syria, and General Valery Asapov,"] *TASS*, September 25, 2017, <http://tass.ru/obschestvo/4589520>
- 203 Irakly Komakhidze, ["Guests from Sakhalin: 18th Pulad as part of the invasion force,"] *Inform Napalm*, January 23, 2015, <https://informnapalm.org/4981-gosty-s-sahalyna-18-ya-pulad/>; ["Shoigu spoke about the deployment of the division in the Kuriles,"] *lenta.ru*, February 22, 2017, <https://lenta.ru/news/2017/02/22/kurily/>
- 204 ["The 46th Machine-Gun Artillery Regiment - Military Unit 71435,"] *Russian Military Units*, <https://voinskayachast.net/suhoputnie-voyska/raketnie-i-artilleriya/vch71435>; ["The 46th Machine-Gun Artillery Regiment - Military Unit 71435,"] *Wikimapia*, [http://wikimapia.org/#lang=en&lat=44.055780&lon=145.780978&z=17&m=b&show=31179038/ru/46-пулемётно-артиллерийский-полк-\(в-ч-71435\)&search=lagunnoye](http://wikimapia.org/#lang=en&lat=44.055780&lon=145.780978&z=17&m=b&show=31179038/ru/46-пулемётно-артиллерийский-полк-(в-ч-71435)&search=lagunnoye); ["Military Unit 71435 Kunashir,"] *Vkontakte*, https://vk.com/vc_71435_public
- 205 ["Military Unit 71436 (49th Machine-gun and Artillery Regiment),"] *Ok Group*, <https://ok.ru/video/2680555604>; ["Military Unit 71436 and 05812 in Iturup,"] *Vkontakte*, https://vk.com/iturup_71436_05812; ["Catalog of military units,"] *forum of servicemen parents*, <https://forum-army.org/gruppy/>; Vidal Sorokin, ["A serviceman of the 49th Machine-Gun Artillery Regiment of the Russian Armed Forces is seen in Donbass,"] *Inform Napalm*, December 30, 2017, <https://informnapalm.org/18041-49-pulemyotno-artillerijskogo-polka-vs-rf-na-donbasse/>
- 206 ["The winners of tank biathlon in Sakhalin given rental house keys,"] *Sakhalin.info*, August 21, 2017, <https://sakhalin.info/news/137455>; ["39th motorized rifle brigade conducted large-scale military exercises in Sakhalin,"] *ACTB*, <https://www.youtube.com/watch?v=yhfk2n2zG10>; ["2017 Day of the Motor Troops,"] *Ok Group*, <https://ok.ru/video/39848380978>; ["39th separate motorized rifle brigade - Military Unit 35390,"] *Russian Military Units*, <https://voinskayachast.net/suhoputnie-voyska/motostrelkovie/vch35390>; ["39th separate motorized rifle brigade - Military Unit 35390,"] *Russian Military Units*, <https://voinskayachast.net/suhoputnie-voyska/motostrelkovie/vch35390>; ["39th Independent Motorized Rifle Red Banner Brigade (Yuzhno-Sakhalinsk),"] *Wikimapia*, <http://wikimapia.org/#lang=en&lat=46.888662&lon=142.757592&z=16&m=b&show=20843951/ru/39-я-отдельная-мотострелковая-Краснознаменная-бригада&search=sakhalin>
- 207 ["Korolev Vladimir Ivanovich – Biography,"] *Russian Federation Ministry of Defense*, <http://structure.mil.ru/structure/forces/navy/management.htm>; Pacific Fleet ["Russian Pacific Fleet,"] *Milkavkaz.com*, June 6, 2017, <http://milkavkaz.com/index.php/voorujonnie-cili-racii/vmf/tf>
- 208 ["155th Separate Marine Infantry Brigade,"] *Vkontakte*, <https://vk.com/club21123261>; ["155th Marine Corps brigade, Vladivostok,"] *Ok Group*, <https://ok.ru/g.vladivo/topic/63054157966249>
- 209 ["40th Separate Marine Corps Brigade, Military Unit 10103,"] *Vkontakte*, <https://vk.com/4obrmkamchatka>; ["40th Separate Marine Brigade, Military Unit 10103,"] *Russian Military Units*, <https://voinskayachast.net/voenno-morskoj-flot/beregovie-voyska/vch10103>
- 210 ["Shooting of the 520th Coastal Missile Artillery Brigade,"] *Live Journal*, December 15, 2011, <https://twower.livejournal.com/682248.html>; ["Anti-aircraft gunners of the Western Military District received a brigade kit 'Buk-M3',"] *Made By Us*, December 16, 2017, <https://sdelanounas.ru/blogs/101782/>
- 211 ["United Strategic Command Structure of the Northern Fleet,"] *Russian Federation Ministry of Defense*, http://structure.mil.ru/structure/okruga_north/structure.htm; ["Commander of the Northern Military Fleet,"] *RU Military Wikipedia*, <https://ru.wikipedia.org/wiki/%D0%A1%D0%B5%D0%B2%D0%B5%D1%80%D0%BD%D1%8B%D0%B9%D1%84%D0%BB%D0%BE%D1%82%D0%92%D0%9C%D0%A4%D0%AC%D0%BE%D1%81%D1%80%D0%B8%D0%B8%D0%9A%D0%BE%D0%BC%D0%B0%D0%BD%D0%B4%D1%83%D1%8E%D1%89%D0%B8%D0%B5>; Arctic ["OSK North,"] *Milkavkaz.com*, June 6, 2017, <http://milkavkaz.com/index.php/voorujonnie-cili-racii/vo-cv/ock-cever>; Northern Fleet ["Northern Fleet,"] *Milkavkaz.com*, July 7, 2017, <http://milkavkaz.com/index.php/voorujonnie-cili-racii/vmf/cf>
- 212 "Nikolay Yevmenov – Biography,"] *Russian Defense Ministry*, <http://eng.mil.ru/en/structure/forces/navy/associations/structure/forces/type/navy/north/leader.htm>; "Promotion List – December 2017,"] *Russian Defense Policy*, December 2017, <https://russiandefpolicy.blog/2017/12/>
- 213 ["United Strategic Command Structure of the Northern Fleet,"] *Russian Federation Ministry of Defense*, http://structure.mil.ru/structure/okruga_north/structure.htm; ["Military Unit 38643 Companion Marine Corps Brigade,"] *Vkontakte*, <https://vk.com/club2119182>
- 214 ["536th separate coastal rocket and artillery brigade, Military Unit 10544, Snezhnogorsk, Olenya Bay,"] *Mptaifun*, September 12, 2015, <http://mptaifun.ru/blog/536-ja-otdelnaja-beregovaja-raketno-artillerijskaja-brigada-v-ch-10544-snezhnogorsk-guba-olenja/2015-09-12-338>; ["The 536th separate coastal rocket and artillery brigade, Military Unit 10544,"] *Wikimapia*, <http://wikimapia.org/23204821/ru/536-%D1%8F-%D0%BE%D1%82%D0%B4%D0%B5%D0%BB%D1%8C%D0%BD%D0%B0%D1%8F-%D0%B1%D0%B5%D1%80%D0%B5%D0%B3%D0%BE%D0%B2%D0%B0%D1%8F-%D1%80%D0%B0%D0%BA%D0%B5%D1%82%D0%BD%D0%BE-%D0%B0%D1%80%D1%82%D0%B8%D0%BB%D0%BB%D0%B5%D1%80%D0%B8%D0%B9%D1%81%D0%BA%D0%B0%D1%8F-%D0%B1%D1%80%D0%B8%D0%B3%D0%B0%D0%B4%D0%B0-%D0%B2-%D1%87-10544>
- 215 ["As part of the joint strategic "North" command the 14th Army Corps formed,"] *Live Journal*, April 22, 2017, <https://bmpd.livejournal.com/2562849.html>; ["Defense Minister Shoigu announces the creation of the 14th Army Corps in the Arctic,"] *RNS*, April 21, 2017, <https://rns.online/military/Shoigu-obyavil-o-sozdanii-14-armeiskogo-korpusa-v-arktike-2017-04-21/>; ["The composition of the army corps created from the fleets,"] *Top War*, April 25, 2017, <https://topwar.ru/116427-sostav-sozdannyh-na-flotah-armeyskih-korpusov.html>
- 216 ["United Strategic Command Structure of the Northern Fleet,"] *Russian Federation Ministry of Defense*, http://structure.mil.ru/structure/okruga_north/structure.htm; ["The composition of the army corps created from the fleets,"] *Top War*, April 25, 2017, <https://topwar.ru/116427-sostav-sozdannyh-na-flotah-armeyskih-korpusov.html>; "OSK North,"] *milkavkaz.com*, June 6, 2017, <http://milkavkaz.com/index.php/voorujonnie-cili-racii/vo-cv/ock-cever>

- 217 ["80th Arctic Motor Rifle Brigade,"] *Top War*, May 12, 2017, <https://topwar.ru/115438-arkticheskaya-motostrelkovaya-brigada-80-omsbr.html>; ["United Strategic Command Structure of the Northern Fleet,"] *Russian Federation Ministry of Defense*, <http://structure.mil.ru/structure/okruga/north/structure.htm>; Alexander Mayorov, ["Arctic Brigade Video Highlights,"] <https://www.youtube.com/watch?v=8GDx81CeHzM>

