

VICTORY™

Operation and
Service Manual 1ST Edition

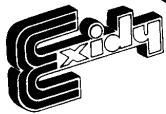
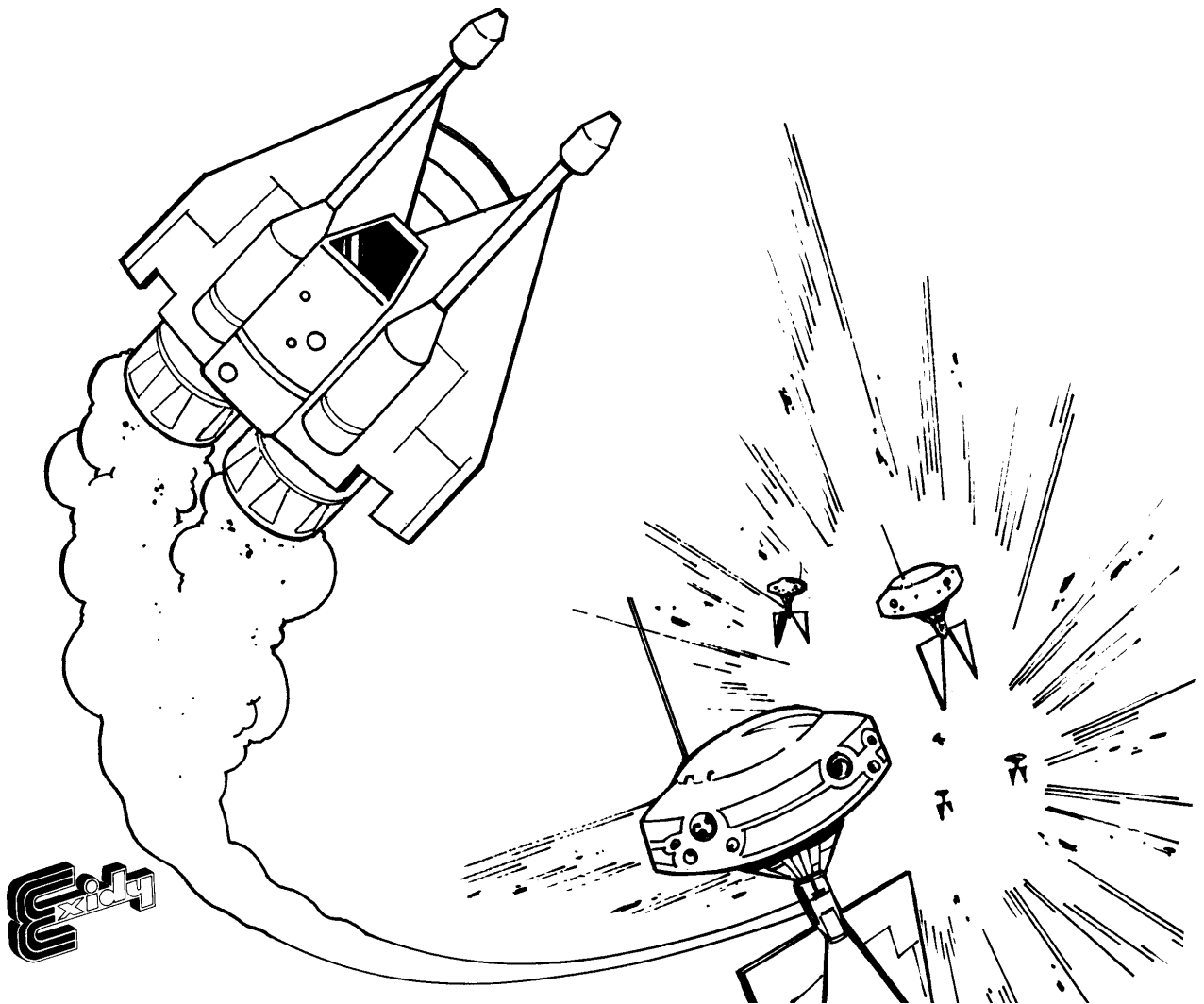

VICTORY™

Operation and Service Manual
1st Edition

© 1982 Exidy, Inc.
390 Java Drive, Sunnyvale,
California 94086-1271
Telephone: (408) 734-9410
Toll-free: (800) 538-8402
Telex: 357-499 (EXIDY MNTV)

Exidy Ireland
Gortlandroe Industrial Estate
Nenagh, County Tipperary
Ireland
Telephone: (067) 32555
Telex: 70009 (EXDY EI)

T A B L E O F C O N T E N T S

SPECIAL FEATURES ON VICTORY™	1
PRELIMINARY PROCEDURES	
A. GAME INSPECTION	2
1. Filing a Claim	2
2. Visual Check	2
B. GAME INSTALLATION	3
C. CHECKOUT PROCEDURE	3
D. ADJUSTMENTS	4
1. Power Supply	4
2. Audio Adjustments	4
3. Battery Replacement	5
VICTORY MODES OF OPERATION	
A. NEW! OPERATOR INTERFACE MODE	5
1. MASTER MENU	5
Resetting Statistics and Operator Options	7
Resetting High Score Tables	7
2. SYSTEM DIAGNOSTICS MENU	9
3. OPERATOR OPTIONS MENU	9
Coinage Options	10
Coin Mechanism Option	10
Player Turns or BATTLESTARS	10
Doomsday Device Settings	12
Shield Settings	12
Fuel Setting	12
Bonus Settings	12
Promotion Points	12
Free Play Mode Setting	12
High Score Tables Preset/Preclear	13
4. ACCOUNTING STATISTICS MENU	13
Total Coins	14
Player 1/ Player 2 Games	14
Total Games	14
Doomsdays, Shields	15
Bonuses, Promotions	15
Highest Squadron	15
Total Minutes on and Total Minutes Played	15
Seconds per Credit	16
B. ATTRACT MODE	15

C. GAME PLAY MODE	16
The Controls	16
D. NEW! DEMONSTRATION MODE	17

ILLUSTRATED PARTS LIST

ELECTRICAL SCHEMATICS

COPYRIGHT

Copyright © 1982 by Exidy Inc. All rights reserved. No part of this publication may be reproduced, transmitted, transcribed, stored in a retrieval system, or translated into any language, in any form, or by any means without the prior written permission of Exidy, Inc., 390 Java Drive, Sunnyvale, California 94086.

DISCLAIMER

Exidy Inc. makes no representations or warranties with respect the contents hereof and specifically disclaims any implied warranties of merchantability or fitness for any particular purpose. Further, Exidy Inc. reserves the right to revise this publication and to make changes from time to time in the content hereof without obligation of Exidy Inc. to notify any person of such revision or changes.

TRADEMARKS

VICTORY™ is a registered trademark of Exidy Inc.

WARNING

This equipment generates, uses and can radiate radio frequency energy and if not installed and used in accordance with the instruction manuals, may cause interference to radio communications. As temporarily permitted by regulation, it has not been tested for compliance with the limits for Class A computing devices pursuant to Subpart J of Part 15 of FCC Rules, which are designed to provide reasonable protection against such interference. Operation of this equipment in a residential area is likely to cause interference in which case the user at his own expense will be required to take whatever measures may be required to correct the interference.

EXIDY INTRODUCES SPECIAL FEATURES ON VICTORY™

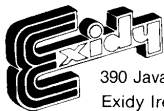
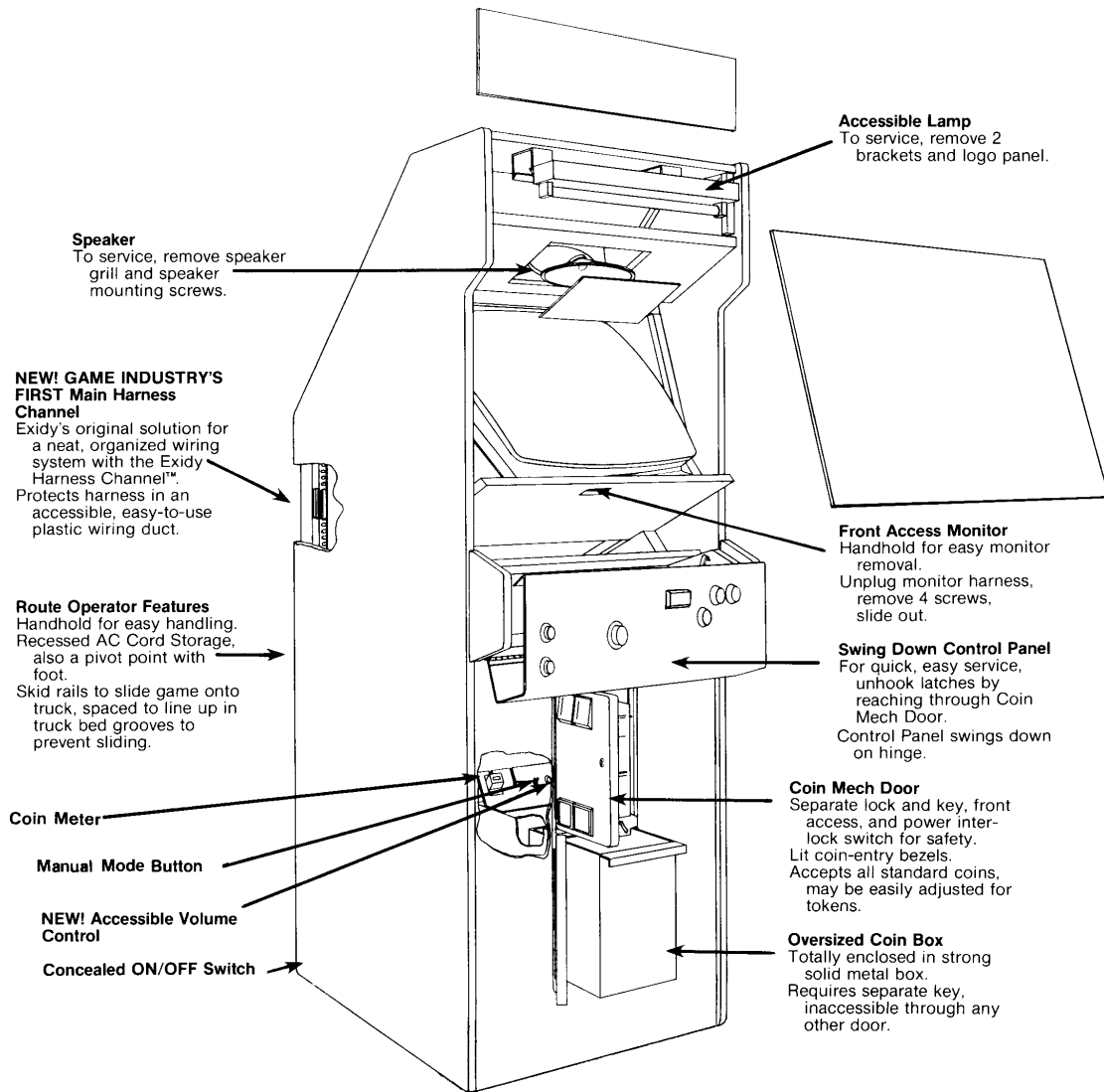

390 Java Drive, Sunnyvale, CA 94086 (408) 734-9410 Service Toll-Free Hotline (800) 538-8402. Telex 357-499.
Exidy Ireland, Gortlandroe Industrial Estate Unit No. 8 Nenaugh, County Tipperary, Ireland Phone 32555, Telex 70009.

PRELIMINARY PROCEDURES

The following sections describe the proper procedure for game inspection, installation, component locations, and checkout. Adjustment procedures for power supply, audio, and battery replacement follows.

A. GAME INSPECTION

All Exidy equipment is carefully packaged in well-padded cardboard containers to prevent damage during shipment. **Before** signing the delivery receipt, you should follow this procedure:

1. Check for obvious damage and make certain that the physical piece count of the shipment matches the piece count on the bill of lading. These two procedures should always be done **before** signing the delivery receipt.
2. Shortages and/or obvious damage to the packaging on any given shipment should be noted **in writing** on the delivery receipt **before** signing for the delivery.
3. If concealed damage is suspected on any shipment, those packages believed to contain the damaged goods **should be opened in the presence of the delivery driver**. If the goods have sustained concealed damage, a description of said damage should be noted **in writing** on the delivery receipt **before** signing for the delivery.
4. **Never** apply power to any game with noticeable damage.

1. Filing a Claim

To file a claim, follow this procedure:

1. Any and all damaged freight, including packaging, **should be retained by the consignee** until a physical inspection of said freight can be made by a representative of the carrier involved.
2. The Claims Manager for the carrier involved should be notified as soon as possible, after the damaged goods are received. Preferably, the carrier's Claims Manager should be notified within forty-eight (48) hours of receipt of the goods by the consignee.
3. If warranted, a written claim should be filed with the carrier involved. A detailed description of the damage(s) should be provided and copies of all supporting documents, **including bill of lading and/or delivery receipt, inspection report, and invoice**, should be attached.
4. The sooner a claim is filed, the better for all parties concerned. The carrier against which a claim is filed is required, by law, to respond to (acknowledge) that claim within thirty (30) days of receiving same and must make a final determination of the matter within one hundred twenty (120) days.

2. Visual Check

If no immediate cabinet damage is evident, perform the following visual inspection:

1. Open each door with appropriate key.

2. Examine each major and electrical component thoroughly for scrapes, dents, broken or missing parts and loose or missing screws.
3. Check for loose cable connectors.
4. Visually verify that all the integrated circuit devices (IC's) plugged into sockets are properly seated and that no IC pins are bent or misaligned.

If you find any damage during this inspection, file a claim with the carrier. Send a complete report of the damage to Exidy.

B. GAME INSTALLATION

Planning the location of the game should involve both physical and electrical considerations. Such physical considerations concern the placement of the equipment with respect to these clearances:

	inches	cm.
Height	70.00	177,80
Width	25.25	64,14
Depth	30.00	76,20
Weight	260 lbs.	117 kg.

An indoor, relatively dust-free environment is necessary, with proper conditions required of any electrical device. Electrical considerations include availability of an AC outlet with the correct voltage and frequency. You should also consider that access to circuit boards and monitor is through the back of VICTORY™.

NOTE:

The cabinet must be within five feet of an AC outlet. Be certain that a ground jack or terminal is available at the outlet.

CAUTION:

DO NOT remove the AC ground prong from the plug. Doing so **voids your warranty!**

C. CHECKOUT PROCEDURE

After properly inspecting and installing VICTORY™, follow this procedure to check its operation:

1. Plug the AC jack into the AC outlet.
2. A message appears on the screen indicating the game is going through an automatic Self-Diagnostic Test, with a software version number and date. This lasts about a minute, while it checks the program ROM CRC (Cyclic Redundancy Check), program volatile RAM, program non-volatile RAM, Video Foreground Background RAM, and Audio Subsystem. If other images appear on your screen during this test, this is **not** an indication of a malfunction. For detailed information on Automatic Self-Diagnostic Tests, see the Addendum.
3. If the game passes all tests, the phrase, "Unit Test Passed" is announced by the voice computer and then the normal Attract Mode begins. In the event a game did not pass the diagnostic test, the voice computer announces "Unit Test Failed" and the screen freezes with an indication of where the failure occurred, if possible. To resume operation, press any button on the control panel.

4. Observe the TV monitor display to assure the correct Attract Mode is present on the screen, described in Section F "Attract Mode". If the VICTORY™ display is incorrect, contact the Exidy Customer Service Department.
5. Insert the appropriate coin or token into either of the coin slots. The following line will flash throughout the Attract Mode:

PLAYS 1 PRESS PLAYER ONE START or PLAYS 2 PRESS ONE OR TWO PLAYER START

depending on the number of coins dropped into the slot.

6. Press one or two player start and play the game to verify that all screen images are displayed.
7. Press Manual Mode button, the red button on the metal panel inside the coin mech door. This takes you into the Operator Interface Mode, where you may run individual manual diagnostics, set operator options, and see accounting statistics. To verify that this is working correctly, read Section A, Operator Interface.
8. For a complete Manual Diagnostic Test, enter the Manual Mode for the Operator Interface at anytime and specify PERFORM DIAGNOSTICS, as explained in Section A2, of the Operator Interface Mode.

If assistance or repairs are necessary, contact the Exidy Customer Service Department, (800) 538-8402.

D. ADJUSTMENTS

1. Power Supply Information

All DC Power required to operate VICTORY™ is supplied by the Exidy Power Supply Module.

CAUTION: Only certified technicians should make adjustments on any components of VICTORY™. Only the +5v DC is adjustable. This must be adjusted to:

+5.00v DC +/- .25v

as measured on the Logic PCB near the microprocessor.

Should it become necessary to change the voltage of your game, contact Exidy Customer Service for the appropriate procedure.

2. Audio Adjustments

To adjust the master audio for VICTORY™, open the top front Coin Mech door. The volume control is to the left of the red button on a metal panel. Turn it to adjust the volume.

3. Battery Replacement

VICTORY™ features battery backup RAM, which retains information for the Operator Options, the Statistics Table in the Operator Interface Mode, All Time High Scores, and so on. In the event you need to replace the batteries, use **two AA Cell Alkaline (Z) batteries**. When pulling out the old batteries on the CPU board, note the placement of their polarity and place the new batteries in the same position.

WARNING

In the event of battery failure, all options, statistics, and high scores tables are reset automatically to factory values.

VICTORY MODES OF OPERATION

VICTORY™ has four modes of operation: the Operator Interface Mode, Attract Mode, Game Play Mode, and Demonstration Mode. The first mode, the **Operator Interface Mode**, contains screen display menus for manual diagnostic tests, operator options, and accounting statistics. The second mode, the **Attract Mode**, is seen between games giving instructions and brief game play clips to intrigue players. The third mode is **Game Play**, which is the usual game play after a coin has been inserted and the Player Start button has been pressed. Finally, the **Demonstration Mode**, accessible only when the game is in Freeplay, allows the user to freeze game action and then advance his level and/or defenses for demonstration. Each of these modes will now be described in detail.

A. NEW! OPERATOR INTERFACE MODE

VICTORY™ introduces Exidy's first software-driven Operator Interface. This feature replaces **all** operator-controlled hardware "dip" switches with friendly and easy-to-use screen "menus". These menus provide extensive selections for self-contained Diagnostic Testing, Operator Options, and for the first time, Game Accounting Statistics. Your options and the accounting statistics are retained in a battery-powered backup RAM, which remains in memory when the game is turned off.

1. MASTER MENU

To enter this Operator Interface mode, open the Coin Mech door. The red button on the metal coin counter bracket is the Manual Mode Button. To enter the Operator Interface Mode, press it when the game is in the Attract Mode, not being played.

When this button is pressed, a Master Menu, or list, is shown on the screen. From the Master Menu, the operator may choose to see one of three other menus: Manual Diagnostic Tests, Operator Options, or Accounting Statistics.

A diagram of the Operator Interface is as follows:

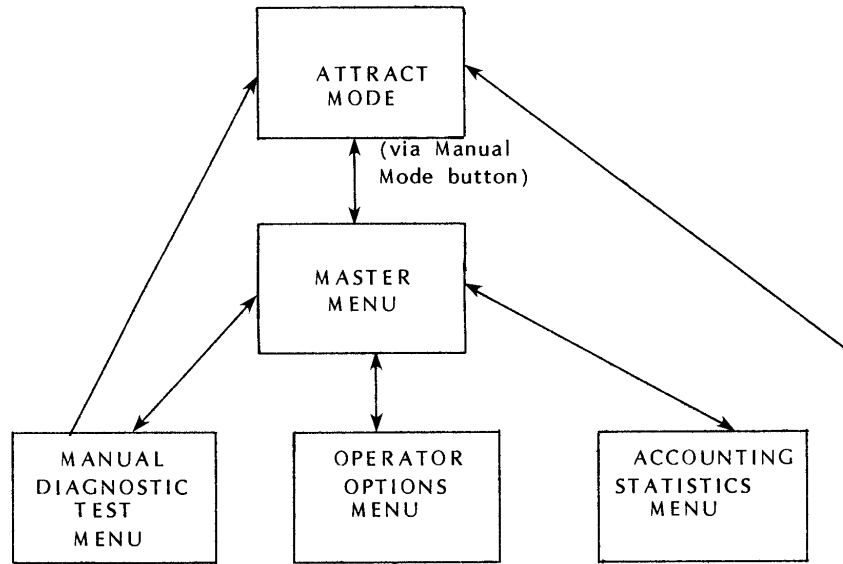

The only way to leave the Operator Interface Mode and return to the Attract Mode is to select "Exit Operator Interface, Resume Play", a selection on any menu. Also, the Manual Diagnostic Menu, Operator Options Menu, and Accounting Statistics Menu have a selection allowing you to return to the Master Menu.

When the red Manual Mode button is first pushed, the operator is presented with the following Master Menu:

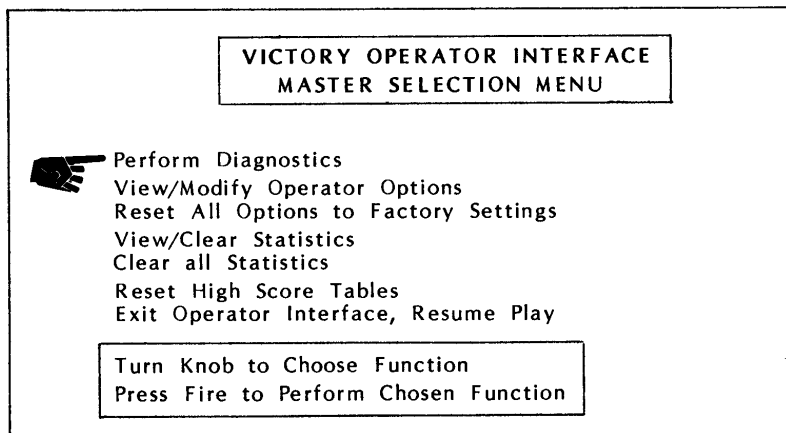

In the left margin, a hand pointer is left of the first function, "Perform Diagnostics". The operator uses the Control Panel Knob to move the hand pointer to the appropriate menu selection, and presses the Fire button to have the function carried out.

- Perform Diagnostics places System Diagnostics Menu on screen.
- View/Modify Operator Options places Operator Options on the screen.
- Reset all Options to Factory Settings resets all operator options to original factory settings.
- View/Clear Statistics places Statistic Menu on screen.
- Clear All Statistics sets all statistics to 0 to begin new count.

- Reset High Score Tables sets both High Scores of the Day and All Time High Scores Table to either zeros or factory scores (depending on selection in Options table, as explained later in High Score table information).
- Exit Operator Interface, Resume Play puts VICTORY™ back in the normal Attract Mode.

Resetting Statistics and Operator Options

The **Master Menu** gives you the option to reset operator options and statistics.

The **Operator Options** include such selections as number of turns, coinage, bonus level, etc. (For a complete list, see Operator Options Menu). Options are set at the factory for optimum earning capability. However, each location has its own needs and you may wish to experiment with other settings. If you do so and later wish to reset all options back to the original factory settings, select "Reset all Options to Factory Settings".

The **Accounting Statistics** contain all the information you need to evaluate the play of VICTORY™, its difficulty, earning capability, minutes played, number of bonuses awarded, etc. (For a complete list, see Accounting Statistics Menu). At times you may wish to reset all these factors to 0, to begin a new analysis. To do so, select "Clear All Statistics" on the Master Menu. (You may reset individual statistics to 0 by going into the Accounting Statistics Menu, explained later).

When either "Clear all Statistics" or "Reset all Options to Factory Settings" has been chosen, the following message appears on the screen to prevent any mistaken selections:

<p>ARE YOU SURE! PRESS FIRE TO EXECUTE PRESS ANY OTHER BUTTON TO ABORT</p>

At this point you press FIRE if you wish to have the function reset, and your selection is performed without any visible change on the screen. Push any other button if you change your mind. To return to the Attract Mode, select "Exit Operator Interface, Resume Play"

Resetting High Score Tables

There are two High Score Tables: High Scores of the Day and All Time Highest Scores.

The High Scores of the Day Table is used to retain the initials and scores of the ten top players for that day. It is reset each time the game powers up or the "Reset High Score Tables" selection is made in the Master Menu. If the Operator Options "High Score Table Setup" is set for PRESET, factory preset scores and initials appear on the screen when the High Score Tables are reset. If the "High Score Table Setup" is set for PRECLEAR, scores are reset to zeros with factory preset initials.

The All Time High Score Table records initials and scores of the ten highest scoring players, since the game left the factory. The only way to reset them is to select RESET HIGH SCORE TABLES on the Master Menu or after a battery failure. If the "High Score Table Setup" option in the Operator Options Menu is PRESET, the All Time High Scores return to factory high scores and initials on a reset. If it is PRECLEAR, the All Time High Scores are set to zeros with factory initials.

2. SYSTEM DIAGNOSTICS MENU

The game automatically performs Diagnostics Self Test on power up, performing the following tests: Program ROM CRC, Program Volatile RAM, Program Non-Volatile RAM, Video Background RAM, and Audio Subsystem.

To perform manual Diagnostics, you must enter the Operator Interface Mode. To do so, open coin mech door. When the game is in the Attract Mode, press the red button on the metal panel. When the Master Menu appears on the screen, select "Perform Diagnostics". The System Diagnostics Menu will then be displayed.

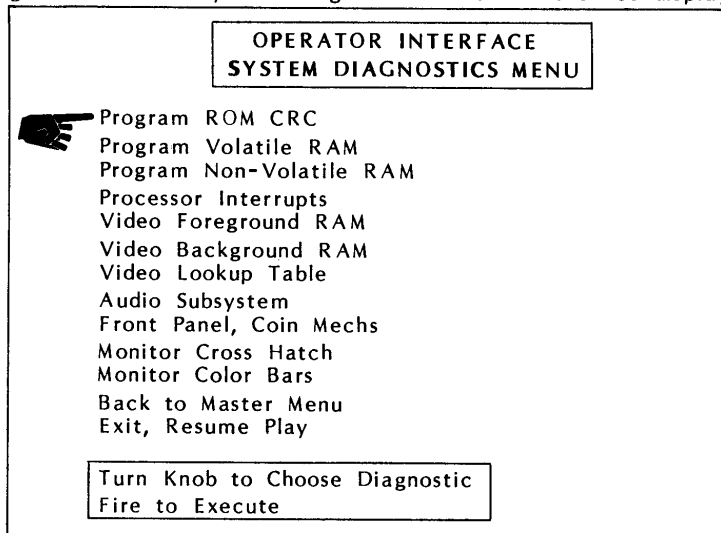

The operator chooses which test to execute by moving the pointer with the knob, and pressing fire to execute a test.

Some of the tests show a screen for monitor adjustments, etc. Others perform the chosen test, and when through, a message will tell whether the test passed or failed, and if possible, where the failure lies. When the test is complete, you are returned to the System Diagnostic Menu. If the event a test fails, the screen displays a message and freezes. To return to the Sytem Diagnostic Menu, press any button. To return to the Master Menu, select "Back to Master Menu". To return to the Attract mode, select "Exit, Resume Play".

Program ROM CRC: Cyclic Redundancy Check, checks to make sure every binary bit in EPROM program is correct.

Program Volatile RAM: Checks all program RAM for correct functioning. Volatile RAM is that RAM whose data is destroyed by a power up.

Program Non-Volatile RAM: Checks RAM contained in battery back- up for correct functioning. Non-volatile RAM contains data which is always retained, unless the battery fails.

Processor Interrupts: Checks interrupts coming from graphic system, going to processor.

Audio Subsystem: Checks audio components.

Video Foreground RAM, Video Background RAM, Video Lookup Table all check video graphic system.

Front Panel, Coin Mechs gives screen messages to test various controls.

Monitor Cross Hatch gives cross hatched lines to test for monitor distortion.

Monitor Color Bars shows eight color bars on the screen. From left to right, these colors appear: black, green, blue, red, cyan, yellow, magenta, white.

3. OPERATOR OPTIONS MENU

Victory™ is the first Exidy game with total software- controlled options, eliminating all hardware dip switches. To use the Operator Options Menu you must enter the Operator Interface Mode. To do so, press the red Manual Mode button inside the Coin Mech Door. Select VIEW/MODIFY OPERATOR OPTIONS on the Master Menu, and the following screen appears (the current settings appear in the right hand column, listed here as the factory settings):

OPERATOR INTERFACE OPERATOR OPTIONS MENU	
 Coin Option	0
Mech 2: Mech 1 Ratio	1
Battlestar to Start	4
Awarded at Bonus	1
Maximum Accumulated	10
Doomsday Devices to Start	3
Awarded at Bonus	1
Maximum Accumulated	10
Shields to Start	4
Awarded at Bonus	1
Units Starting Fuel	48
First Bonus Score Threshold	35000
Subsequent Bonus Deltas	65000
Points Given at Bonus	1600
Promotion Points/Quark/Level	1000
Freeplay/Demo Mode	NO
High Score Table Setup	PRESET
Return to Master Menu	
Exit, Resume Play	
Turn Knob to Choose options	
1 Player Start to Increase Value	
2 Player Start to Decrease Value	

To change values, turn knob to choose the option you wish to change. Pressing Player 1 Start button increases values, Player 2 Start decreases values. Hold the buttons down to continuously change. Tap it to change once. The values will be selected so that you cannot make a mistake (for example, there is no "0" value for BATTLESTARS: Number to Start).

Each option is explained below, with the factory settings in parentheses.

Coinage Settings

There are two independent coinage settings: "Coin Option" and "Mech 2 : Mech 1 Ratio".

The Coin Option determines the number of credits given for coins. Many options are available, including "special bonus credits", such as 1 coin 1 credit, 4 coins 5 credits. This encourages players to put more coins in for extra credits.

The Mech 2 : Mech 1 Ratio setting makes it possible to have two coin mechanisms accepting different denominations. This is especially common in European countries. For example, a 5 Deutsche mark could be accepted in the right Mech (#2), with a 1 Deutsche mark accepted in the left (#1). You must set the ratio of Coin Mech 2 to Coin Mech 1 if two different coin acceptors are required, as described following Coin Option below.

Coin Option

COIN OPTION Setting (0)

The following is the code for the COIN OPTION setting:

Code on Menu	Option	Note
0	1 coin 1 credit	Normal option
1	1 coin 2 credits	Two for One Special
2	1 coin 3 credits	Special Credit
3	1 coin 4 credits	Special Credit
4	2 coins 1 credit	\$.50 game
5	3 coins 1 credit	\$.75 game
6	4 coins 1 credit	\$1.00 game
7	5 coins 1 credit	\$1.25 game
8	1 coin 1 credit	Special Bonus Credit
	2 coins 3 credits	
9	1 coin 1 credit	
	2 coins 4 credits	
10	1 coin 1 credit	
	2 coins 5 credits	
11	1 coin 1 credit	
	3 coins 4 credits	
12	1 coin 1 credit	
	3 coins 5 credits	
13	1 coin 1 credit	
	4 coins 5 credits	
14	1 coin 1 credit	Setting for Germany
	5 coins 6 credits	
15	2 coins 1 credit	
	3 coins 2 credits	
16	2 coins 1 credit	
	3 coins 3 credits	
17	2 coins 1 credit	
	3 coins 4 credits	
18	2 coins 1 credit	
	4 coins 3 credits	

19	2 coins 1 credit 4 coins 4 credits	
20	2 coins 1 credit 4 coins 5 credits	
21	2 coins 1 credit 5 coins 3 credits	Setting for England
22	3 coins 1 credit 4 coins 3 credits	
23	3 coins 1 credit 5 coins 3 credits	

Selections: 0-23.

Coin Mechanism Option

Mech 2: Mech 1 Ratio Setting (1)

In some countries, games have two different coin acceptors. If this is true in your case, you must adjust this setting to have both acceptors offer the same credits per coin(s). Coin Mech 2 is the right mech. Coin Mech 1 is left mech.

To set: Mech 2: Mech 1 = x : 1. "x" is number of coins it takes in Coin Mech 1 (the left mech) to be equivalent to a single coin accepted in Coin Mech 2 (the right mech).

Example: For Germany, the ratio of Coin Mech 2 (5 Deutch Mark) : Coin Mech 1 (1 Deutsche mark) is 5 to 1. Give this setting a 5. To offer a special "1 coin/1 credit, 5 coins/6 credit" option, set Coin Option for 14, and both coin acceptors will offer 5 coins/6 credits. So a coin in the left mech gives 1 credit. A coin in the right mech gives six credits as does five straight coins in the left mech.

Example: For England, Coin Mech 2 (50 Pence):Coin Mech 1 (10 Pence) is 5:1. Again, give this setting a 5. For a special Two 10 Pence/ One credit, One 50 Pence/ 3 Credits, adjust the Coin Options to 21 and both coin acceptors will offer the bonus credit.

Selections: 1-10.

Player Turns or BATTLESTARS

Battlestars to Start: (4) The number of BATTLESTARS (player ships, or turns) given at the beginning of a game for each player. The factory setting is 4 and may be set at any number, from 1 to 25.

Awarded At Bonus: (1) The number of BATTLESTARS or turns awarded for bonus score (35,000, 100,000 etc.). Zero (0) gives no extra turn for achieving bonus level. Selections: 0-10.

Maximum Accumulated: (10) This sets a limit for the maximum number of BATTLESTARS accumulated at any one time. If the player has 10 BATTLESTARS and gets a bonus, another one will not be awarded. Selections: 1-25.

DOOMSDAY DEVICE Settings

Doomsday Devices to Start: (3) Doomsday Devices are the player's defense for destroying all enemies on the Cockpit Window screen at one time. Because of their power, they are limited in number. You select the number the player starts with: 1-25.

Awarded at Bonus: (1) The number of Doomsday Devices awarded when the player makes a bonus score. Selections: 0-10.

Maximum Accumulated: (10) Maximum amount of Doomsday Devices permitted at one time. Selections: 1-25

SHIELD Settings

Shields to Start: (4) You select the amount of shields each player starts with. Shields protect the player's ship from all external dangers for 3 seconds. Selections: 1-4

Awarded at Bonus: (1) You select the number of shields awarded when a bonus amount of points are made. Selections: 0-4.

Fuel Setting

Units Starting Fuel: (48) This is the amount of fuel at game start. A Full tank is 64 units, three quarters a tank is 48 units. Selections: 16 to 64.

Bonus Settings

First Bonus Score Threshold: (35,000) The score a player must attain to achieve his first bonus. The factory preset bonuses are 1 Battlestar (turn), 1 doomsday, 1 shield, and 1600 points, which may be altered to fit your needs. The threshold can be changed to any number, from 100 - 999,900, in increments of 100.

Subsequent Bonus Deltas: (65,000) The point span between the first bonus score threshold and the second and subsequent bonus score thresholds. The factory settings give bonuses for scores of 35,000, 100,000 and 165,000, continuing at increments of 65,000. Selection: 100 - 999,900, in increments of 100.

Points Given at Bonus: (1600) Number of points awarded when player reaches bonus level. Selection: 0 - 999,900, in increments of 100.

Promotion Points

Promotion points/Quark/Level: (1000) When a player destroys an entire enemy squadron, and he is promoted to a new rank and level, points are awarded for each QUARK not released from its land bunker. The number selected (1000 in this case) is multiplied times the level number the player achieved. This answer is then multiplied times the number of QUARKS not released.

Example: If 8 QUARKS remain at the end of level 2, and the setting is 1000 points, then $1000 \times 8 \times 2 = 16,000$ promotion points total are awarded. Selection: 0 - 10,000, in increments of 100.

Freeplay/Demonstration Mode Setting

Freeplay/Demo Mode: (NO) When this is set for YES, free one and two player games are given at all times, until this setting is reset to NO. During Freeplay, the Demonstration Mode may be used, explained in Section D, Demonstration Mode. Selections: YES (by pressing Player 1) and NO (by pressing Player 2).

High Score Tables Preset/Preclear

High Score Table Setup: (PRESET) There are two High Score tables, Highest Scores of the Day and All Time High Scores. Highest Scores of the Day Table powers up with factory preset scores and initials, if PRESET is selected. Zeros and initials appear if PRECLEAR is selected. Should the table ever be RESET by the Master menu selection, it will reset in the same manner it powers on.

The All Time High Scores are retained in the battery back up memory. When the game powers up, the All Time High Scores remain. The only way to reset this table is to select Reset High Score Tables from the Master Menu, or to have a failure in the batteries. Should either of these occur, the All Time High Score Table is set at factory high scores and initials if the Operator Option High Score Table is set for PRESET. If it is set for PRECLEAR, all scores turn to zero, with factory initials.

Selection: PRESET (by pressing Player 2) and PRECLEAR (by pressing Player 1).

TO RETURN TO THE MASTER MENU, select "Back to Master Menu". To return to the Attract Mode, select "Exit, Resume Play".

4. ACCOUNTING STATISTICS MENU

For the first time, Exidy offers a complete Accounting Statistic package, in the form of a screen menu. This menu lists all the information you need to evaluate the difficulty and earnability of VICTORY.

To see the Accounting Statistics, you must enter the Operator Interface. To do so, open the coin mech door and press red manual mode button on metal panel. Select "View/Clear Statistics" from the Master Menu, and the following screen appears, where x is a number corresponding to each statistic.

**OPERATOR INTERFACE
ACCOUNTING STATISTICS**

	Total Coins Mech 1	x
	Total Coins Mech 2	x
	Total 1 Player Games	x
	Total 2 Player Games	x
	Total Games	x
	Total Doomsdays Awarded	x
	Total Doomsdays Used	x
	Total Shields Awarded	x
	Total Shields Used	x
	Total Bonuses Awarded	x
	Total Promotions Awarded	x
	Highest Squadron	x
	Average Squadron	x
	Total Minutes On	x
	Total Minutes Played	x
	Seconds Per Credit, Maximum	x
	Average	x
	Minimum	x

Return to Master Menu
Exit Interface, Resume Play

Turn Knob to Choose Statistic
 Press Fire to Clear that Statistic

To reset a particular statistic to 0, turn the knob to choose the statistic, and press the fire button to clear it to 0. To reset entire statistic menu to 0, you may select "Clear all Statistics" in the Master Menu.

Total Coins

Total Coins Mech 1, Total Coins Mech 2 gives a count of the number of coins entered in each coin mech. This may serve as a double check with the hardware coin counter behind the coin mech door. Reset it to zero when beginning a new count.

Player 1/Player 2 Games and Total Games

Total 1 Player Games and Total 2 Player Games give a count of the number of one and two player games played. Total Games gives the **total** players who have played. That is, it multiplies number of Player 2 games times two and adds this to number of Player 1 games.

Doomsdays, Shields

Total Doomsdays Awarded and Total Shields Awarded is the total number of each awarded so far. This includes number to start and bonus awards. Total Doomsdays and shields the players have used in games tells you the total amount they actually used and may help you determine the difficulty level of the game.

Bonuses, Promotions

Total bonuses awarded is the number of times a player has exceeded the bonus score levels. The total promotions awarded is the number of times a player has eliminated an entire enemy squadron and succeeded to a higher level. Both can be used as an indication of whether to adjust the game difficulty.

Highest Squadron

Highest Squadron is the highest level any player has achieved. Average Squadron Number is the average level achieved by players at your location.

Total Minutes On and Total Minutes Played

Gives both the total amount of time your game has been powered on since it left the factory and the total minutes it has been played for comparison.

Seconds Per Credit

A record of the longest (maximum) and shortest (minimum) games played (in seconds) and the average game length. All of these statistics can help you determine the level of difficulty to challenge players and increase profits.

To return to the Master Menu, select "Back to Master Menu". To return to the Attract Mode, select "Exit, Resume Play".

B. ATTRACT MODE

After the VICTORY™ is powered up and the automatic self- diagnostic test is performed and passes the unit, the Attract Mode starts up, displaying the following screen images:

The Attract Mode goes into a brief game play demonstration, with the BATTLESTAR traveling and shooting at enemies.

Then, the word "Exidy" rises on the screen in red, and then the word VICTORY is spelled out in white outline by "enemy lasers" stationed at the bottom of the screen. Next, all VICTORY characters are identified. The player's BATTLESTAR is in the center of the screen, and all enemies surround it.

The following game instructions appear:

<p>VICTORY™</p> <ul style="list-style-type: none">• Stop PARATROOPERS from releasing deadly QUARKS.• "Yellow Alert" = QUARK loose• REFUEL at depot as needed• Use SHIELD and DOOMSDAY carefully <p>Copyright (c) (P) Exidy Inc., 1982</p>

Then the High Score Tables are displayed and the cycle then repeats.

When enough coins have been deposited to earn one credit, the message below flashes throughout the Attract Mode

Plays 1
Press 1 player start

When more than one credit is earned, the number of credits appears as x below:

Plays x
Press 1 or 2 player start

C. GAME PLAY MODE

After depositing coins, a player pushes the 1 or 2 player button to begin game play as a Cadet on the BATTLESTAR, the most maneuverable spaceship in the universe. His mission: to destroy all enemy ships. Some enemy ships add to the challenge by dropping PARATROOPERS to the ground where they release the lethal QUARKS, locked up in land bunkers. Once freed, the QUARKS head straight for the BATTLESTAR. At his defense are unlimited bullets, the DOOMSDAY device (which kills all enemies seen out Cockpit Window), and the SHIELD (which protects the BATTLESTAR from all threats for three seconds). Doomsday, shield, and fuel supply are limited.

Three Doomsday Devices and four Shields are given at the outset of the game (operator selectable). Then, when a bonus is obtained (35,000 or operator selectable), a doomsday, shield, turn, and 1600 points are awarded.

After all enemies in a squadron (level) have been destroyed, points are awarded for each QUARK not released, and the "Cadet" is promoted to a Flier with a new world to defend. As a Flier, two parallel bullets shoot each time the FIRE button is pressed—an advantage needed for the increased number of enemies the Flier faces. Further promotions (from Flier, to Squadron Leader to Wing Commander to Ace) provide better weapons and more enemies to conquer.

Detailed Game Play information is given in the small manual included in quantity with each game, **How to Master VICTORY, A Pilot's Guide to Game Strategy.**

The Controls

The BATTLESTAR travels 256 different directions, by turning the **steering knob** in the desired direction. This steering knob also controls the battlegun. A **thrust button** simulates true motion, with gradual thrust and then full speed. A **fire button** fires bullets at enemies.

Hitting the **Shield button** puts up a 3 second shield around the Battlestar, protecting it against all enemies, bombs, and land. When activated, the **Doomsday Device** button destroys every enemy on the screen. The player has only four shields and three Doomsday Devices (operator selectable)

D. NEW! DEMONSTRATION MODE

Exidy has added a demonstration technique to help distributors and operators demonstrate VICTORY. The Demonstration Feature enables the operator to freeze the game and then increase defenses, advance levels, or attain bonuses (actually to 'cheat').

You may set VICTORY for Freeplay mode by entering the Operator Options menu via the Master Menu and specifying YES for FREEPLAY/DEMONSTRATION mode.

To use the Demonstration Feature, follow these simple steps:

1. You must have the game set for Freeplay.
2. You must be playing a game.
2. Press FIRE and THRUST, and while holding them down, press Player 1 and Player 2 buttons simultaneously (a total of four buttons at once, two with the left hand and two with the right hand).

At this point, the game freezes. The game will remain frozen until the operator gives a 'command'. Commands are entered by pressing particular buttons, each one giving the operator different capabilities.

Only one command may be given when the game freezes. However, throughout a game, you may freeze it as often as you wish, and continue to gain more advantages. Game play immediately resumes once a command is given.

FIRE- instantly promotes the operator to the next rank and gives the corresponding new weapon. For example, if a Cadet, he is promoted to a Flier. Ranks, from lowest to highest, are: Cadet, Flier, Squadron Leader, Wing Commander, Ace.

SHIELD- Skips the player one level after he has destroyed all enemy. That is, if he is on the first level and gives this command, he must eliminate entire enemy squadron first, and then is promoted to the third level, skipping the normal second level.

THRUST- Instant bonus achieved, giving player 1 doomsday, 1 shield, 1600 points, and a turn, or BATTLESTAR.

DOOMSDAY- Unused.

1 PLAYER START- Instantly turns off all enemy aggression. Enemies won't fire bullets, shoot laser cannons, launch rockets, or release paratroopers or QUARKS. This lasts throughout a turn or until 2 Player Start is given as a command (see 2 Player Start). The next turn, enemies become aggressive again, as usual.

2 PLAYER START- 'Undoes' Player 1 Start. That is, it makes enemies aggressive again. Can only be entered after THRUST and FIRE is pressed with PLAYER 1 and PLAYER 2 start button.

The following is an illustrated parts list and electrical schematics for VICTORY™.

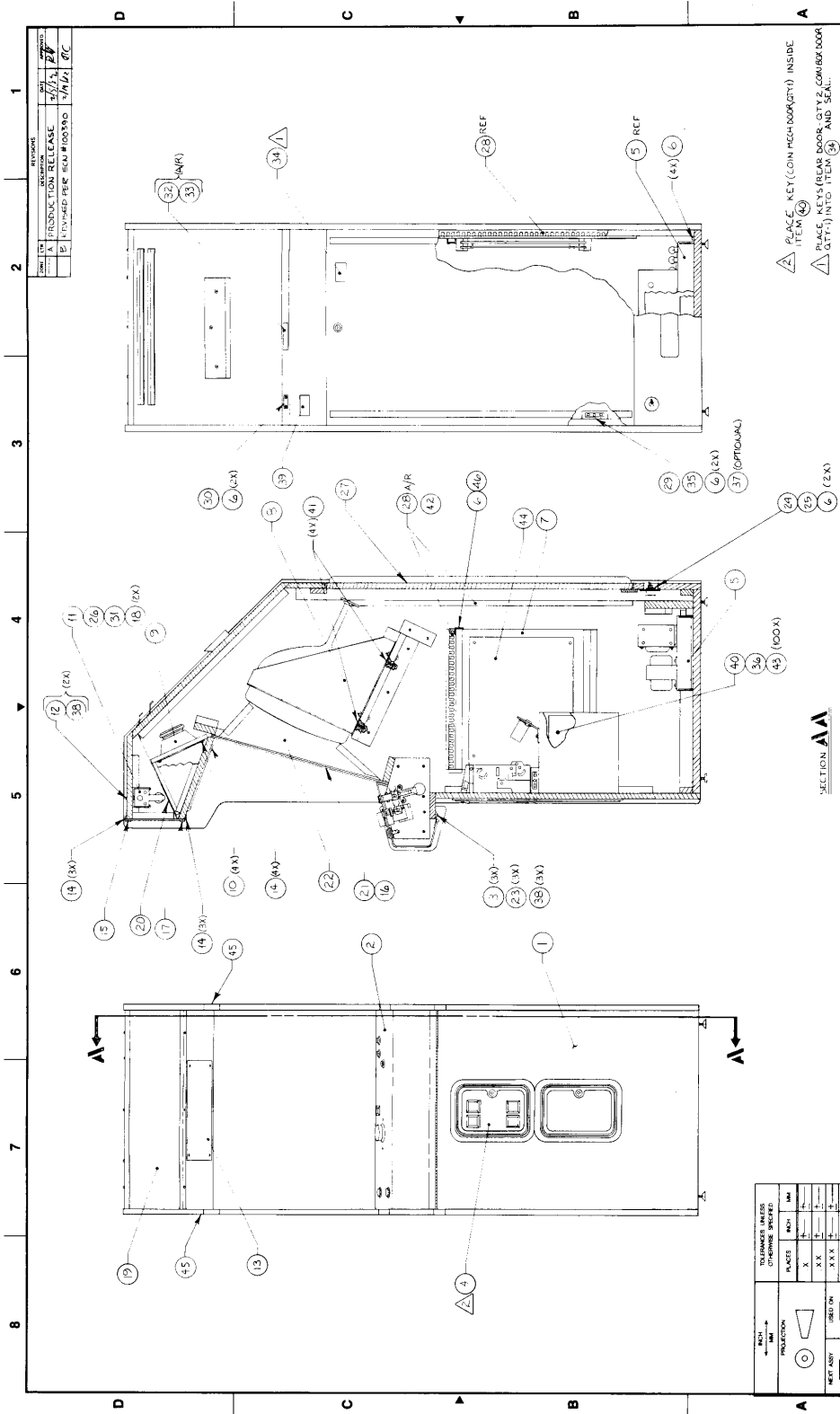

TITLE: ASSEMBLY, FINAL PART NO: 300-0002-00	
DRAWN BY: ST CHECKED BY: ST DATE: 1/25/82	PROJECT NUMBER: 117192
SCALE: NONE UNIT: INCHES DO NOT SCALE DRAWING	SHEET NO: 1 OF 2
SEE P/L FOR DIMENSIONS SEE P/L FOR TOLERANCES	MATERIAL SPECIFICATION: D
PART OF DRAWING: 300-0002-00	DRAWING NO: 300-0002-00
PROJECT: 300-0002-00	DRAWING NO: 300-0002-00

THE FOLLOWING TABLE INDICATES THE DIMENSIONS SHOWN	DIMENSIONS DIMENSIONS DIMENSIONS	DIMENSIONS DIMENSIONS DIMENSIONS	DIMENSIONS DIMENSIONS DIMENSIONS
DIMENSIONS DIMENSIONS DIMENSIONS	DIMENSIONS DIMENSIONS DIMENSIONS	DIMENSIONS DIMENSIONS DIMENSIONS	DIMENSIONS DIMENSIONS DIMENSIONS

ITEM	PART NUMBER	LIST DESCRIPTION	QTY
1	200-0013-00	ASSY. CABINET	1
2	200-0018-00	ASSY. CONTROL PANEL	1
3	50-0093-02	BRACKET, LOWER B/L	3
4	200-0015-00	ASSY. COIN DOOR	1
5	200-0017-00	ASSY. CHASSIS, HC	1
6	51-8007-01	SCREEN, VIDEO	1
7	177-0004-03	ASSY. P.C. BOARD, HVC	1
8	200-0014-00	ASSY. MONITOR	1
9	78-0001-00	SPEAKER	1
10	51-8002-05	SCREEN, VIDEO	4
11	200-0016-00	ASSY. FLOURESCENT LAMP	1
12	50-0083-02	BOLT, PAN HEAD, B/L	2
13	89-0003-00	GRILLE, SPEAKER	1
14	50-0065-02	SCREEN, VIDEO	10
15	80-0005-00	BRACKET, UPPER	1
16	94-0006-00	PANEL, DISPLAY	1
17	80-0004-00	BRACKET, LOWER LOGOS	1
18	83-0003-00	BRACKET, LAMP	2
19	94-0005-01	PANEL, LOGO	1
20	98-0003-00	SHIELD, LIGHT	1
21	94-0007-01	PANEL, AMBIENT	1
22	198-0004-00	ASSY. BEZEL	1
23	55-7000-01	WASHER, PENDER #10	3
24	48-2002-00	SWITCH, POWER	1
25	86-0004-00	PLATE, POWER SWITCH	1
26	91-0005-00	BRACKET, RETAINER	1
27	69-0023-00	ASSY. REAR DOOR	1
28	91-0078-00	DUCT, WIRING	4R
29	48-5012-00	SWITCH INTERLOCK	1
30	99-0002-00	LABEL, SERIAL NO	1
31	73-0002-00	LAMP, FLUORESCENT	1
32	99-0004-00	LABEL, VOLTAGE, 110	N/A
33	94-0005-00	LABEL, VOLTAGE, 220	N/A
34	870-0002-00	ENVELOPE, PACKING	1
35	83-0014-00	SWITCH, INTERLOCK	1
36	400-0004-01	OPTICAL MALLIBAL	1
37	91-0003-00	COVER INTERLOCK SWITCH OPT	1
38	53-0041-00	NUT, KEP - HEX # 10-24	5
39	99-0006-00	LABEL, FCC WARNING	1
40	84-0003-00	BOX, COIN	1
41	51-8032-00	SCREEN, VIDEO, FLT. HD	4
42	91-0079-00	SCREEN, VIDEO, ZING	4R
43	400-0005-01	FLYER, SERVICE MANUAL	100
44	177-0005-03	ASSY. AUDIO/CPU PC BOARD	1
45	93-0008-00	BEZEL, SIRE - COGO	2
46	84-0022-00	CABLE, P.C.B	1

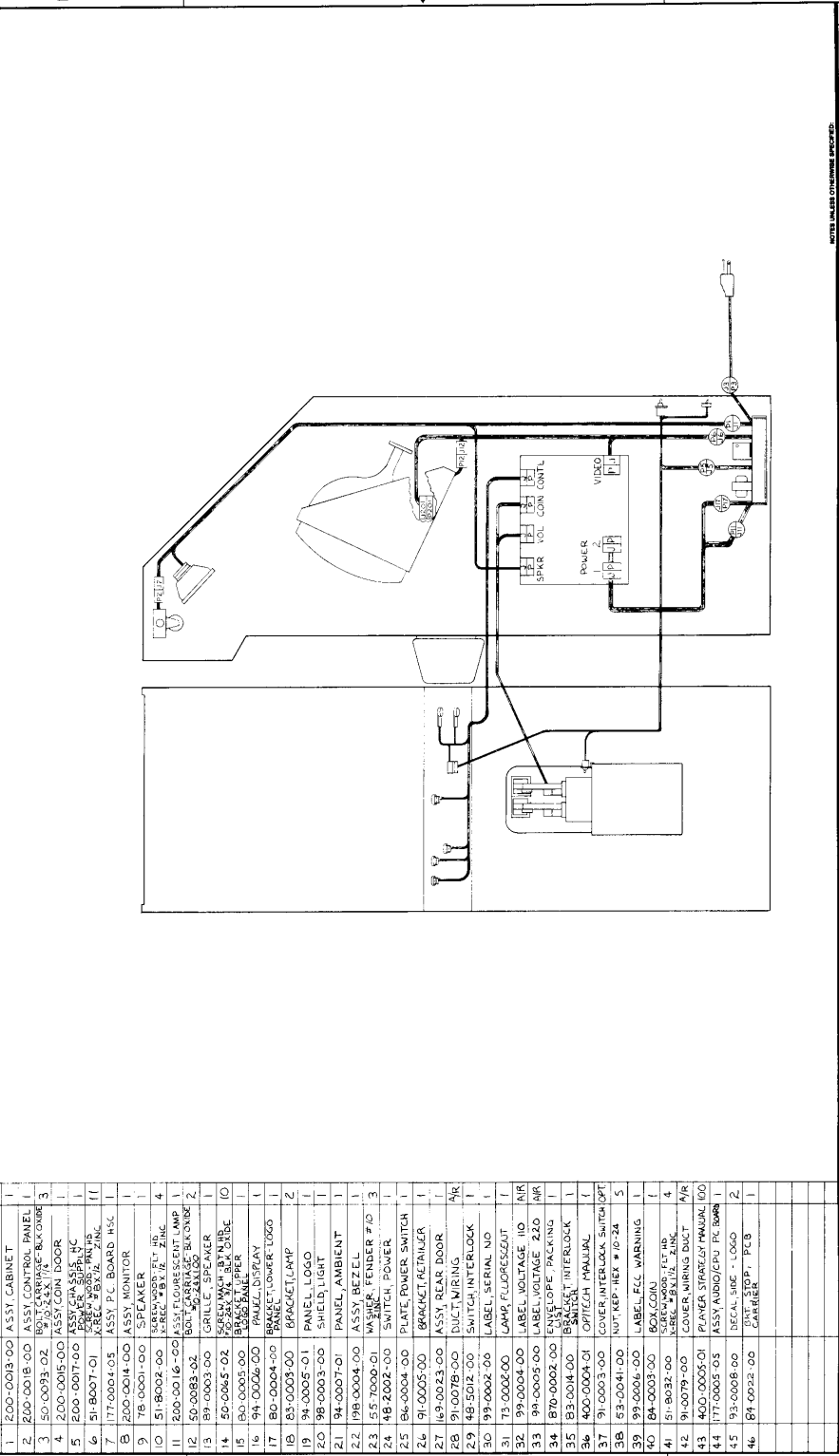

PROPERTY	DATE	BY	REVISION	DESCRIPTION	DATE	BY	REVISION	DESCRIPTION
1	1/2/82
2
3
4
5
6
7
8
9
10
11
12
13
14
15
16
17
18
19
20
21
22
23
24
25
26
27
28
29
30
31
32
33
34
35
36
37
38
39
40
41
42
43
44
45
46

TITLE: ASSY, FINAL
 DRAWING NO: 300-0002-00
 SHEET 2 OF 2
 DATE: 1/2/82
 BY: [Signature]
 CHECKED: [Signature]
 APPROVED: [Signature]
 DESIGNED: [Signature]
 DRAWN: [Signature]
 SCALE: DO NOT SCALE DRAWING
 NOTES: SEE SHEET 1
 NOTES: MAKE OTHERS SPECIFIC

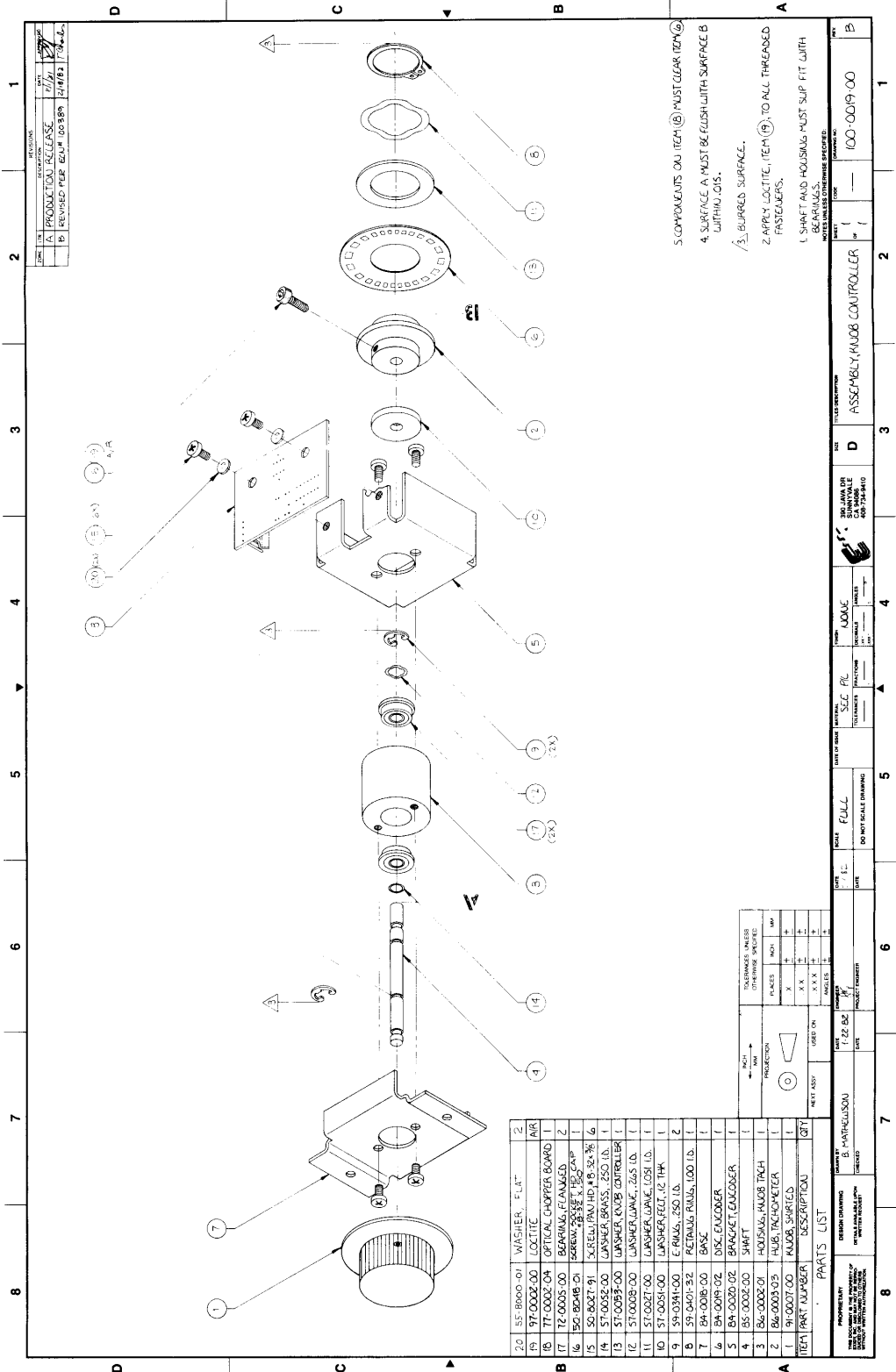

ITEM	PART NUMBER	DESCRIPTION	QTY
20	55-BROOD-07	WASHER, FLAT	2
19	97-0002-00	LOCTITE	1
18	77-0002-04	OPTICAL CHOPPER BOARD	1
17	72-0005-00	BEARINGS, FLANGED	2
16	50-BD4B-01	SCREW, 28 X 1/2	1
15	50-BD4B-01	SCREW, 28 X 1/2	1
14	57-0052-00	WASHER, BRASS, .250 ID.	1
13	57-0053-00	WASHER, BRASS, .250 ID.	1
12	57-0009-00	WASHER, WAVE, .265 ID.	1
11	57-0027-00	WASHER, WAVE, .108 ID.	1
10	57-0051-00	WASHER, FELT, .02 THK	1
9	59-0341-00	E-RINGS, .250 ID.	2
8	59-0401-32	PETALS, RINGS, 1.00 ID.	1
7	BA-0018-00	BASE	1
6	BA-0019-02	DISC, ENCODER	1
5	BA-0020-02	BRACKET, ENCODER	1
4	BS-0002-00	SHAFT	1
3	56-0002-01	HOUSING, NUB TACH	1
2	56-0003-03	HUB, TACHOMETER	1
1	91-0007-00	NUB, SHIELDS	1

UNIT	INCHES	MILLIMETERS
1	1/16	1.5875
2	1/8	3.1750
3	1/4	6.3500
4	3/8	9.5250
5	1/2	12.7000
6	5/8	15.8750
7	3/4	19.0500
8	7/8	21.6250
9	1	25.4000
10	1 1/8	29.5750
11	1 1/4	31.7500
12	1 3/8	34.9250
13	1 1/2	38.1000
14	1 5/8	41.2750
15	1 3/4	43.0000
16	1 7/8	46.1750
17	2	50.8000
18	2 1/8	54.0000
19	2 1/4	57.1500
20	2 3/8	60.3250

5. COMPONENTS ON ITEM 10 MUST CLEAR ITEM 6.
 4. SURFACE A MUST BE FLUSH WITH SURFACE B WITH HD OILS.
 3. BEARINGS SURFACE.
 2. APPLY LOCTITE, ITEM 19, TO ALL THREADED FASTENERS.
 1. SHAFT AND HOUSING MUST SLIP FIT WITH BEARINGS.

REV	DATE	BY	CHKD	DESCRIPTION
1	7.22.82	B. MATHELISSOU		DESIGN DRAWING
2				ISSUED FOR MANUFACTURE
3				ISSUED FOR MANUFACTURE
4				ISSUED FOR MANUFACTURE
5				ISSUED FOR MANUFACTURE
6				ISSUED FOR MANUFACTURE
7				ISSUED FOR MANUFACTURE
8				ISSUED FOR MANUFACTURE

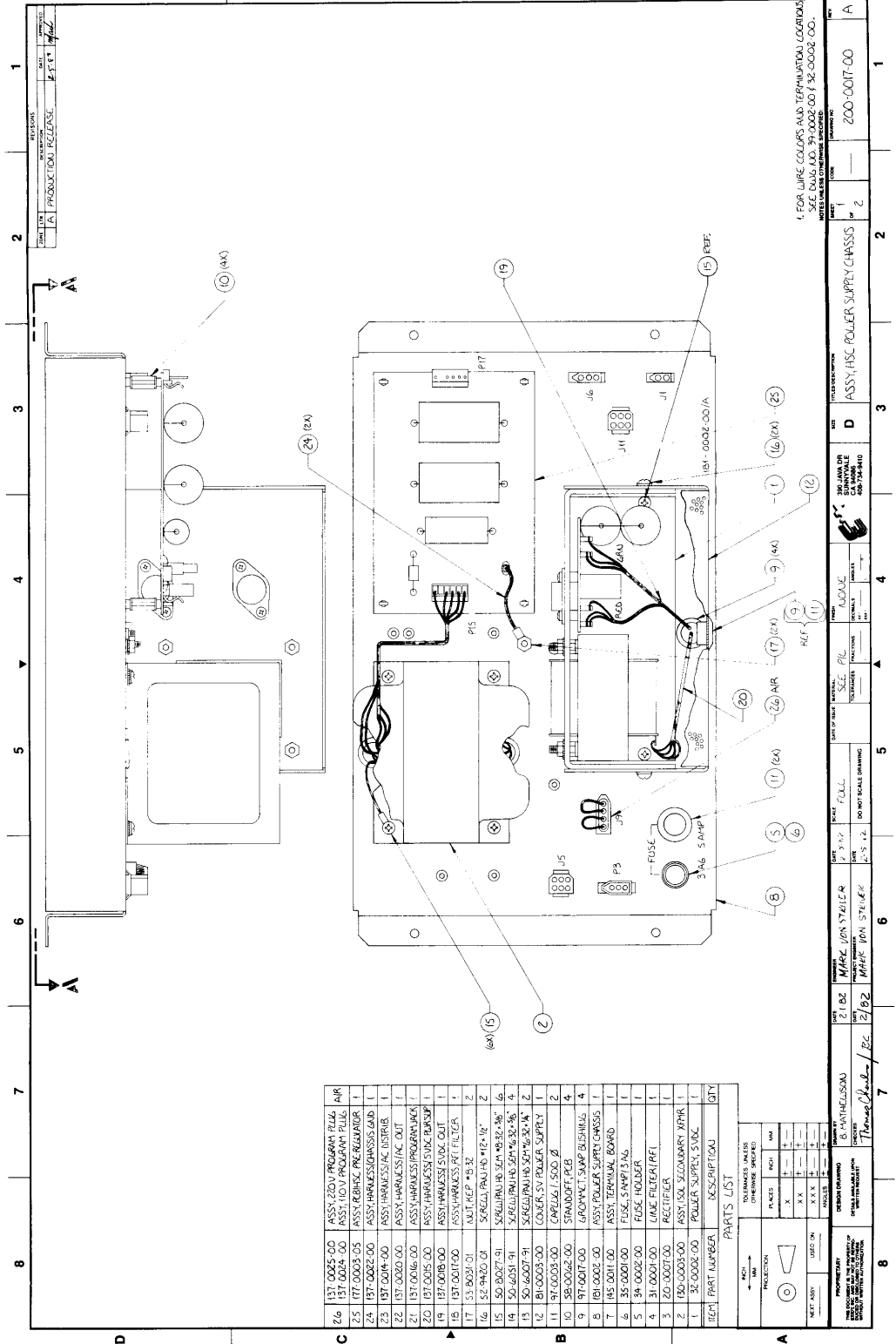

ITEM	PART NUMBER	DESCRIPTION	QUANTITY	UNIT	MATERIAL	MARK		DATE OF REVISION	REVISION	REVISED BY	REASON FOR REVISION
						1	2				
						2	2				
1	1	ASSEMBLY CHASSIS	1	CHASSIS		DATE OF REVISION		1	DATE	BY	REASON FOR REVISION
1	1	ASSEMBLY CHASSIS	1	CHASSIS		DATE OF REVISION		1	DATE	BY	REASON FOR REVISION
1	1	ASSEMBLY CHASSIS	1	CHASSIS		DATE OF REVISION		1	DATE	BY	REASON FOR REVISION

2	1	MARK ION STABILIZER	1	MARK ION STABILIZER		DATE OF REVISION		1	DATE	BY	REASON FOR REVISION
3	1	MARK ION STABILIZER	1	MARK ION STABILIZER		DATE OF REVISION		1	DATE	BY	REASON FOR REVISION

4	1	MARK ION STABILIZER	1	MARK ION STABILIZER		DATE OF REVISION		1	DATE	BY	REASON FOR REVISION
5	1	MARK ION STABILIZER	1	MARK ION STABILIZER		DATE OF REVISION		1	DATE	BY	REASON FOR REVISION
6	1	MARK ION STABILIZER	1	MARK ION STABILIZER		DATE OF REVISION		1	DATE	BY	REASON FOR REVISION

7	1	MARK ION STABILIZER	1	MARK ION STABILIZER		DATE OF REVISION		1	DATE	BY	REASON FOR REVISION
8	1	MARK ION STABILIZER	1	MARK ION STABILIZER		DATE OF REVISION		1	DATE	BY	REASON FOR REVISION

1. FOR WIRE COLORS AND TERMINATION LOCATIONS SEE WIRING DIAGRAM OF P-3000E CO.

2. FOR WIRE COLORS AND TERMINATION LOCATIONS SEE WIRING DIAGRAM OF P-3000E CO.

3. FOR WIRE COLORS AND TERMINATION LOCATIONS SEE WIRING DIAGRAM OF P-3000E CO.

4. FOR WIRE COLORS AND TERMINATION LOCATIONS SEE WIRING DIAGRAM OF P-3000E CO.

5. FOR WIRE COLORS AND TERMINATION LOCATIONS SEE WIRING DIAGRAM OF P-3000E CO.

6. FOR WIRE COLORS AND TERMINATION LOCATIONS SEE WIRING DIAGRAM OF P-3000E CO.

7. FOR WIRE COLORS AND TERMINATION LOCATIONS SEE WIRING DIAGRAM OF P-3000E CO.

8. FOR WIRE COLORS AND TERMINATION LOCATIONS SEE WIRING DIAGRAM OF P-3000E CO.

9. FOR WIRE COLORS AND TERMINATION LOCATIONS SEE WIRING DIAGRAM OF P-3000E CO.

10. FOR WIRE COLORS AND TERMINATION LOCATIONS SEE WIRING DIAGRAM OF P-3000E CO.

11. FOR WIRE COLORS AND TERMINATION LOCATIONS SEE WIRING DIAGRAM OF P-3000E CO.

12. FOR WIRE COLORS AND TERMINATION LOCATIONS SEE WIRING DIAGRAM OF P-3000E CO.

13. FOR WIRE COLORS AND TERMINATION LOCATIONS SEE WIRING DIAGRAM OF P-3000E CO.

14. FOR WIRE COLORS AND TERMINATION LOCATIONS SEE WIRING DIAGRAM OF P-3000E CO.

15. FOR WIRE COLORS AND TERMINATION LOCATIONS SEE WIRING DIAGRAM OF P-3000E CO.

16. FOR WIRE COLORS AND TERMINATION LOCATIONS SEE WIRING DIAGRAM OF P-3000E CO.

17. FOR WIRE COLORS AND TERMINATION LOCATIONS SEE WIRING DIAGRAM OF P-3000E CO.

18. FOR WIRE COLORS AND TERMINATION LOCATIONS SEE WIRING DIAGRAM OF P-3000E CO.

19. FOR WIRE COLORS AND TERMINATION LOCATIONS SEE WIRING DIAGRAM OF P-3000E CO.

20. FOR WIRE COLORS AND TERMINATION LOCATIONS SEE WIRING DIAGRAM OF P-3000E CO.

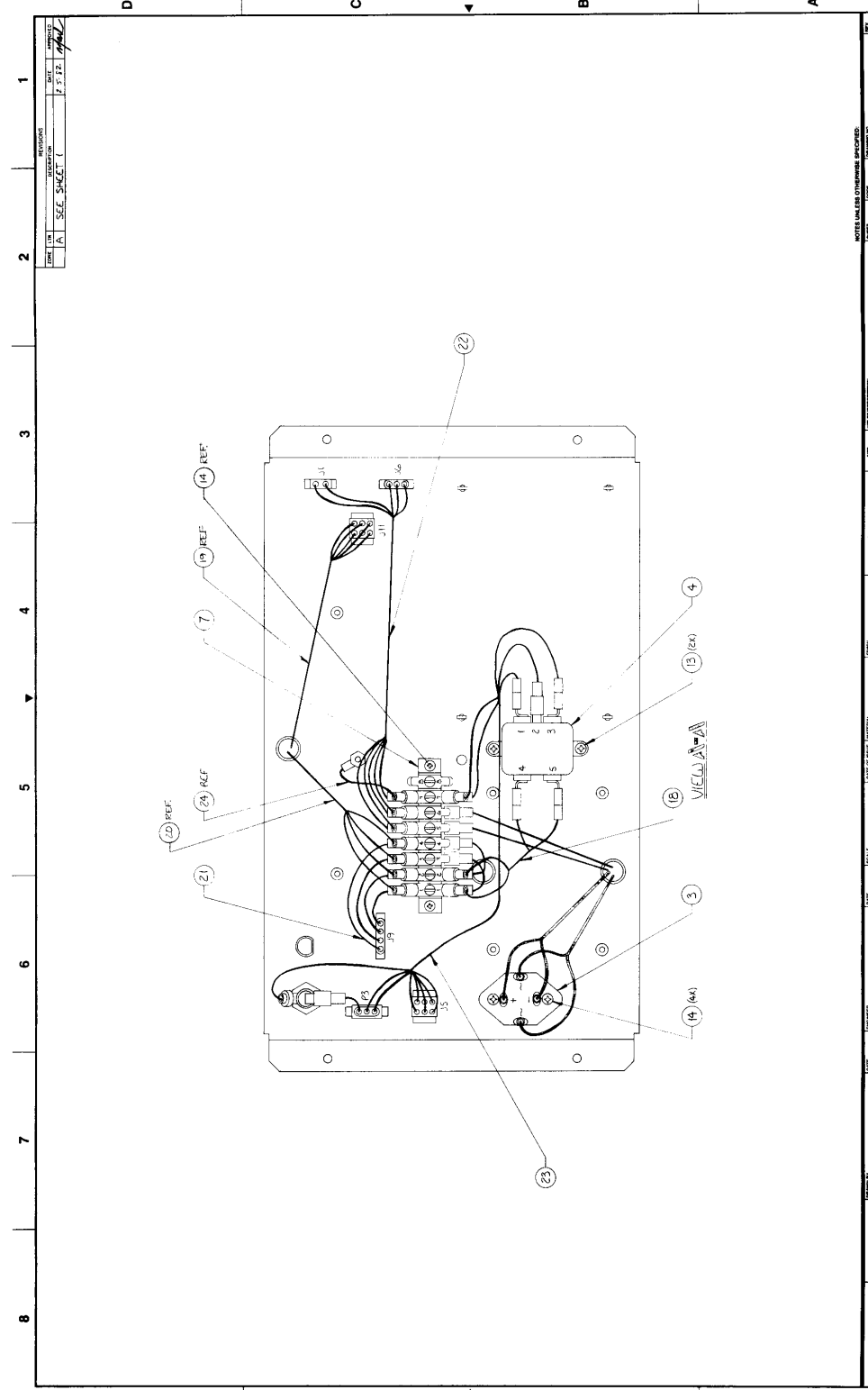

REV		DATE	BY	APPROVED
1		7.5.82	JMP	
DESCRIPTION		SEE SHEET 1		
2	A	SEE SHEET 1		

PROPRIETARY THIS DRAWING IS THE PROPERTY OF TRW ELECTRONIC CORPORATION AND IS NOT TO BE REPRODUCED OR TRANSMITTED IN ANY FORM OR BY ANY MEANS, ELECTRONIC OR MECHANICAL, INCLUDING PHOTOCOPYING, RECORDING, OR BY ANY INFORMATION RETRIEVAL SYSTEM.	DESIGN CHANGES BY: B. P. HILLIUSON DATE: 5-82 BY: TRW/RS DATE: 7-82		DATE OF DRAWING 7-82	TITLE ASY45C POWER SUPPLY CHASSIS	PART NUMBER 200-0017-00	NOTED: UNLESS OTHERWISE SPECIFIED: DIMENSIONS IN PARENTHESES ARE FOR FIELD MODIFICATION	
	CHECKED BY: TRW/RS DATE: 7-82		SCALE FULL DO NOT SCALE DRAWING	MATERIALS SEE PILE REQUIREMENTS LISTED THEREIN	PART DESCRIPTION ASSY45C POWER SUPPLY CHASSIS		SHEET NO. 2 OF 2
	DRAWN BY: TRW/RS DATE: 7-82		FILE NUMBER 200-0017-00	PART NAME ASY45C POWER SUPPLY CHASSIS	QUANTITY 2		DRAWN BY TRW/RS
	CHECKED BY: TRW/RS DATE: 7-82		DRAWING NUMBER 200-0017-00	PART NUMBER 200-0017-00	PART NAME ASY45C POWER SUPPLY CHASSIS		DRAWN BY TRW/RS

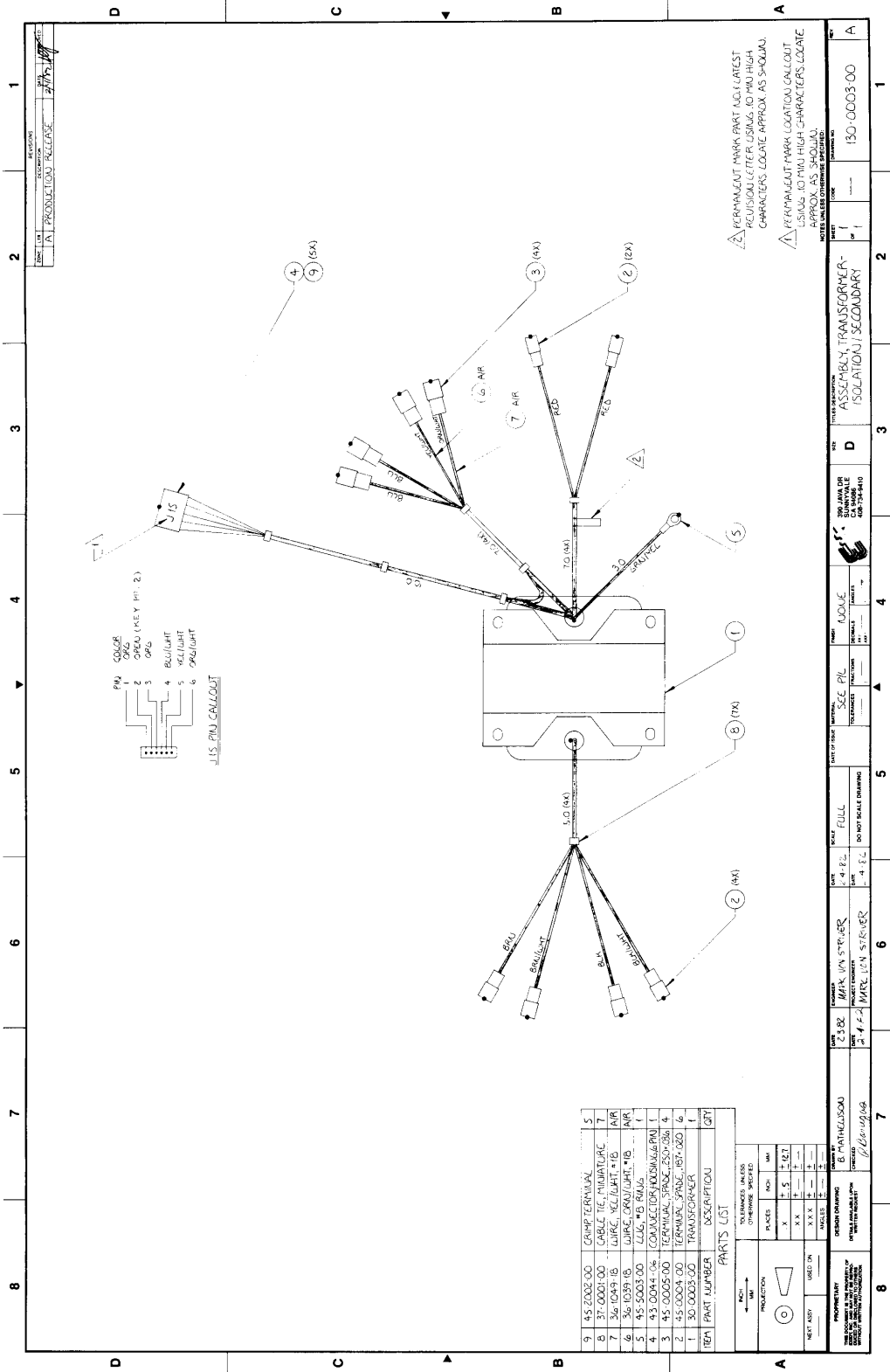

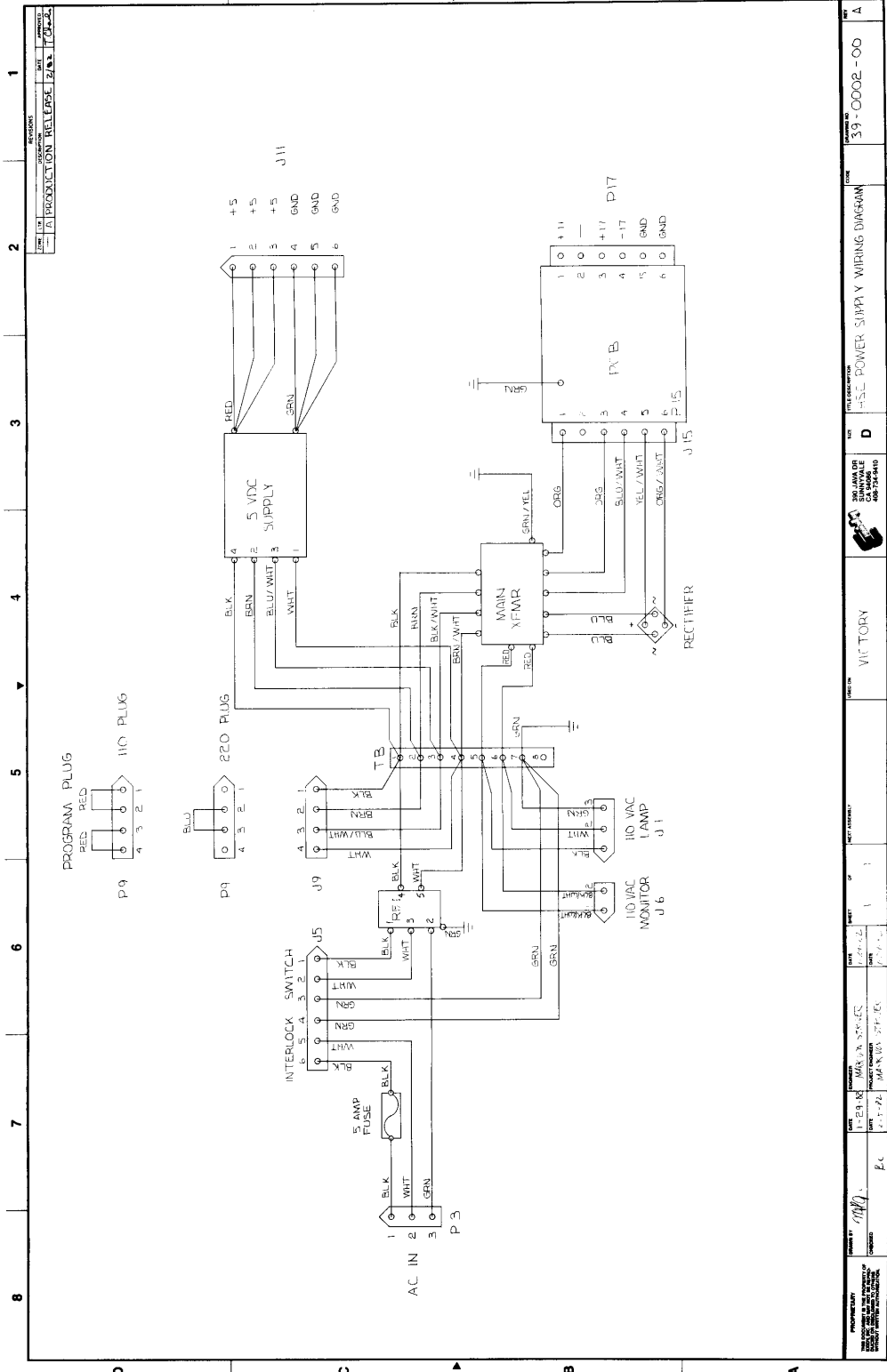

REV	DATE	DESCRIPTION	BY	CHKD
1	10/11/78	PRODUCTION RELEASE	JH	JH

PROPERTY	DATE	BY	CHKD
1-24-XE	10/11/78	JH	JH
1-1-78	10/11/78	JH	JH

PROJECT	DATE	BY	CHKD
1-24-XE	10/11/78	JH	JH
1-1-78	10/11/78	JH	JH

DESIGN	DATE	BY	CHKD
1-24-XE	10/11/78	JH	JH
1-1-78	10/11/78	JH	JH

DESIGN	DATE	BY	CHKD
1-24-XE	10/11/78	JH	JH
1-1-78	10/11/78	JH	JH

DESIGN	DATE	BY	CHKD
1-24-XE	10/11/78	JH	JH
1-1-78	10/11/78	JH	JH

DESIGN	DATE	BY	CHKD
1-24-XE	10/11/78	JH	JH
1-1-78	10/11/78	JH	JH

DESIGN	DATE	BY	CHKD
1-24-XE	10/11/78	JH	JH
1-1-78	10/11/78	JH	JH

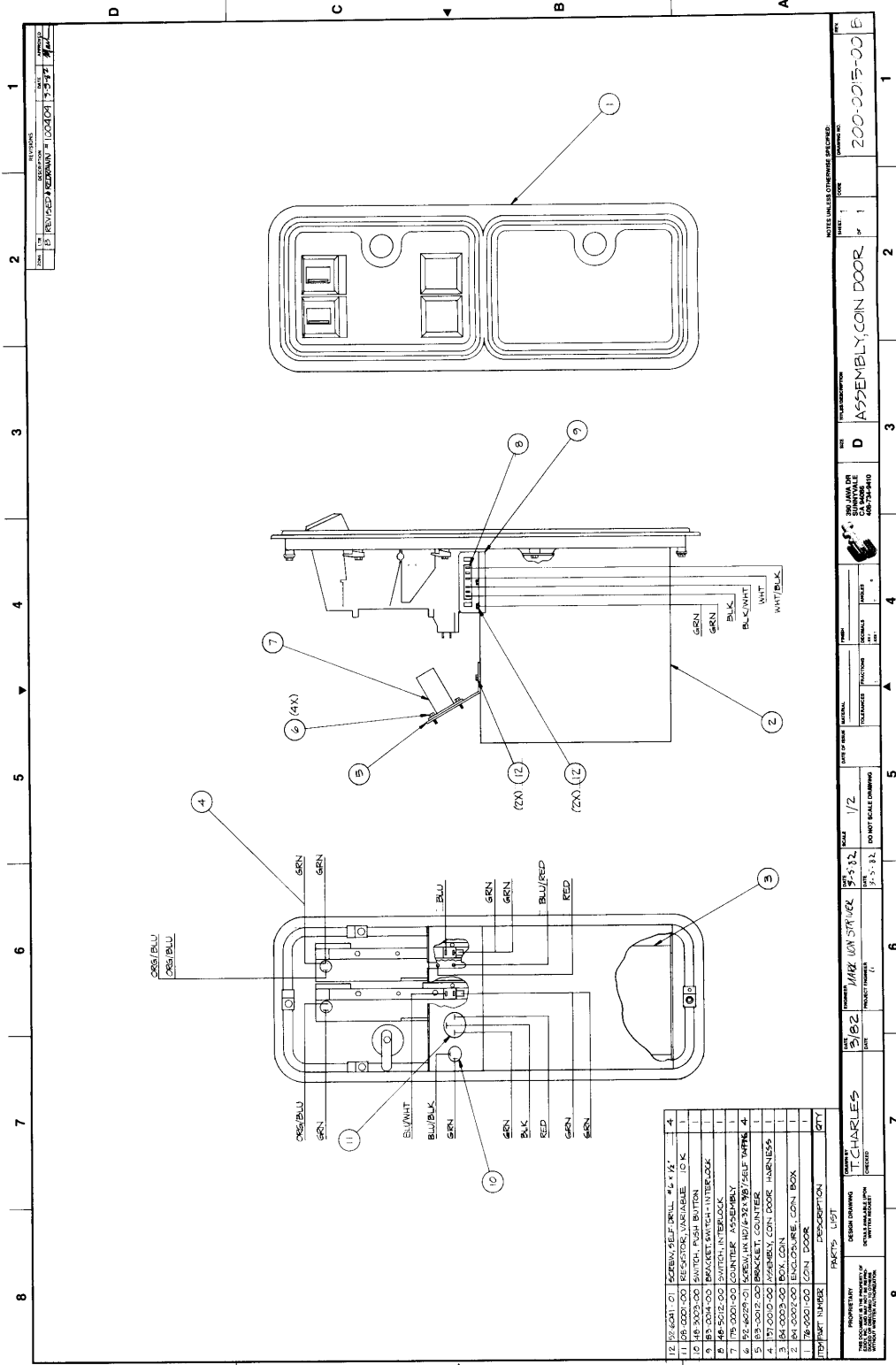

ITEM NUMBER	DESCRIPTION	QTY
12 12 001 01	SCREEN, SELF-BLOCK # 5 X 1/2	4
11 09 001 00	RESISTOR, VARIABLE 10 K	1
10 48 300 00	SWITCH, PUSH BUTTON	1
9 85 004 00	IMPACT SWITCH-INTERLOCK	1
8 48 502 00	SWITCH, INTERLOCK	1
7 15 300 00	COUNTER	1
6 15 300 00	W/1/2" X 1/2" X 1/2" SELF WINK	4
5 15 300 00	BRACKET, CENTER	1
4 17 000 00	ASSEMBLY, CON. DOOR HARNESSES	1
3 14 000 00	BOX, CON.	1
2 14 000 00	ENCLOSURE, CON. BOX	1
1 14 000 00	CON. DOOR	1

PROPERTY OF: **CHARLES**
 DRAWING NUMBER: **100-0015-00E**
 DATE: **12-5-52**
 SCALE: **1/2**
 DO NOT SCALE DRAWING

DESIGNER: **MARK W. STUBER**
 CHECKER: **T. CHARLES**
 DATE: **12-5-52**

ITEM NO. **1** OF **1** DOOR
 PART NO. **100-0015-00E**
 TITLE: **ASSEMBLY, CON. DOOR**

NOTE: VALUES OTHERWISE SPECIFIED

19" COLOR GAME MONITOR SCHEMATIC DIAGRAM

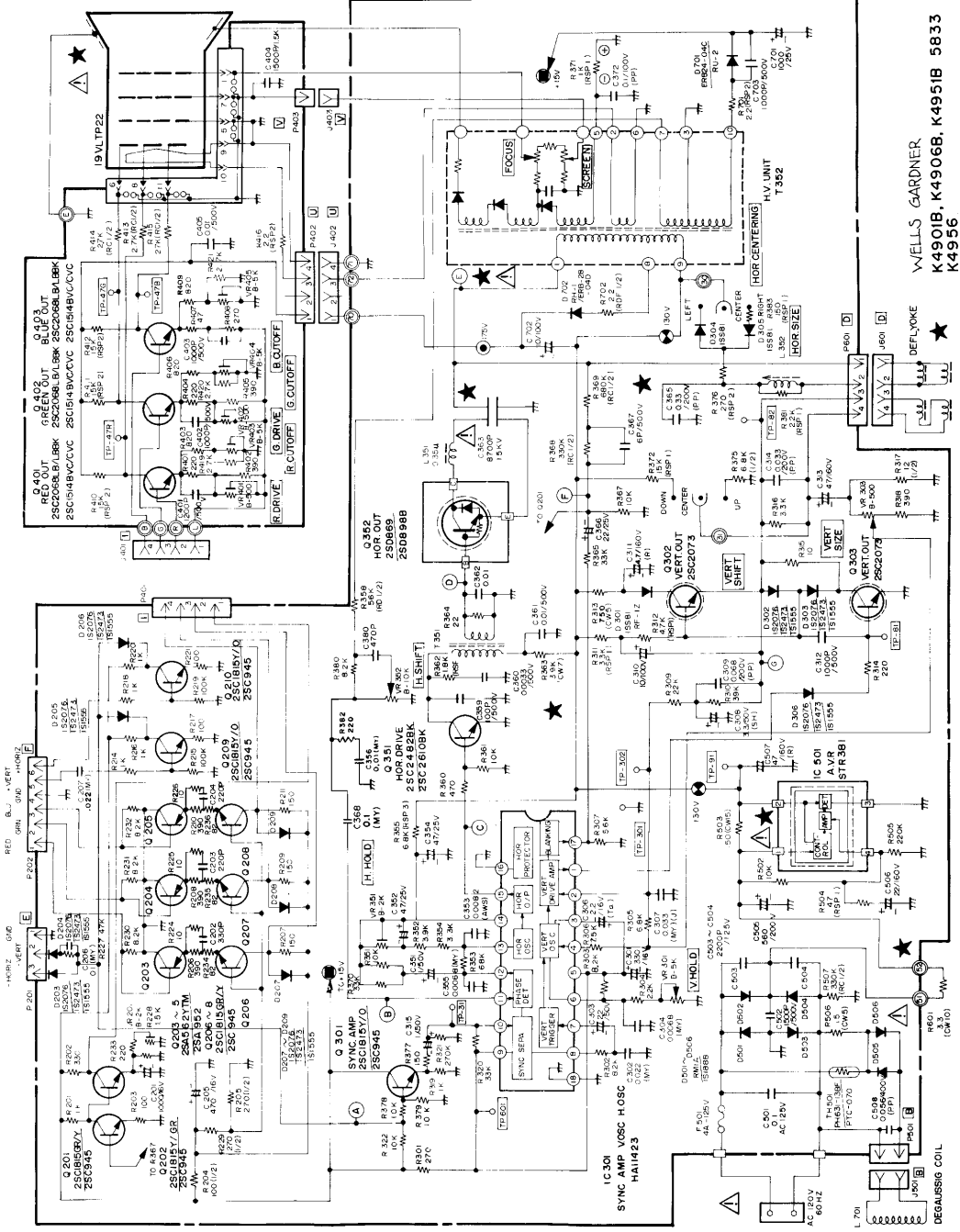

WELLS GARDNER
K4901B, K4906B, K4951B 5833
K4956

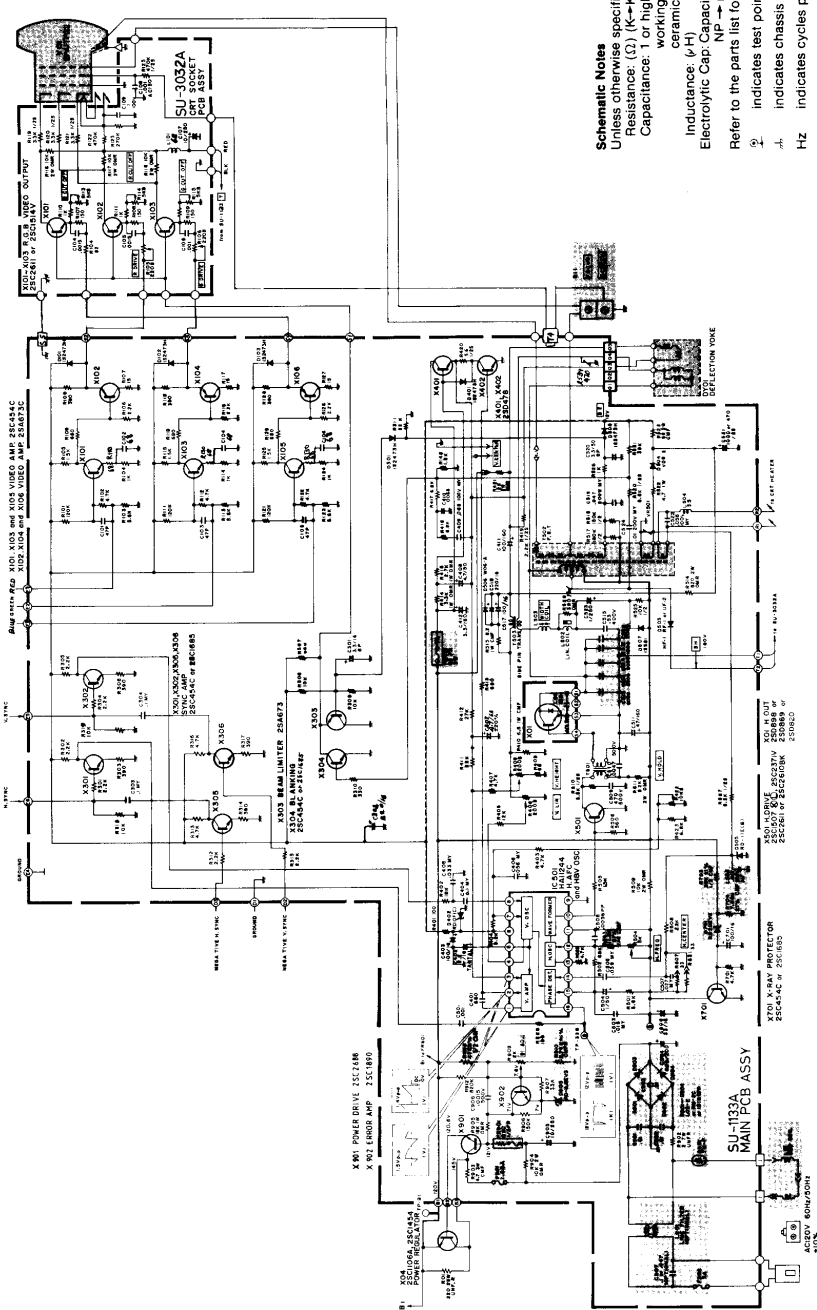

Schematic Notes
 Unless otherwise specified
 Resistance: (Ω) (K→KΩ, M→MΩ), 1/4 (W) carbon resistor
 Capacitance: (pF) or higher → (pF), less than 1 → (pF)
 working voltage → 50 (V)
 ceramic capacitor
 Inductance: (μH)
 Electrolytic Cap: Capacitance Value (μF)/working voltage (V),
 NP → non-polar (or bipolar) electrolytic cap.
 Refer to the parts list for additional component information.
 ② indicates test point connection
 ④ indicates chassis ground unless otherwise specified
 Hz indicates cycles per second
 For safety purposes (and continuing reliability)
 replace all components marked with safety symbol with
 identical type.
 NOTE: FR → fusible resistor —E52—

00-4147-04
 G07-CB0

Parts identification on circuit boards:
 e.g. SU1126A (R107 = R1107)
 SU3030A (R113 = R3113)
 ELECTROHOME

REV.	DESCRIPTION	DATE	APPROVAL
1	PRODUCTION RELEASE	3-1-74	[Signature]

REVISIONS

DESCRIPTION

DATE

APPROVAL

781/2

7405

P POWER

504

LS138

LS138

LS138

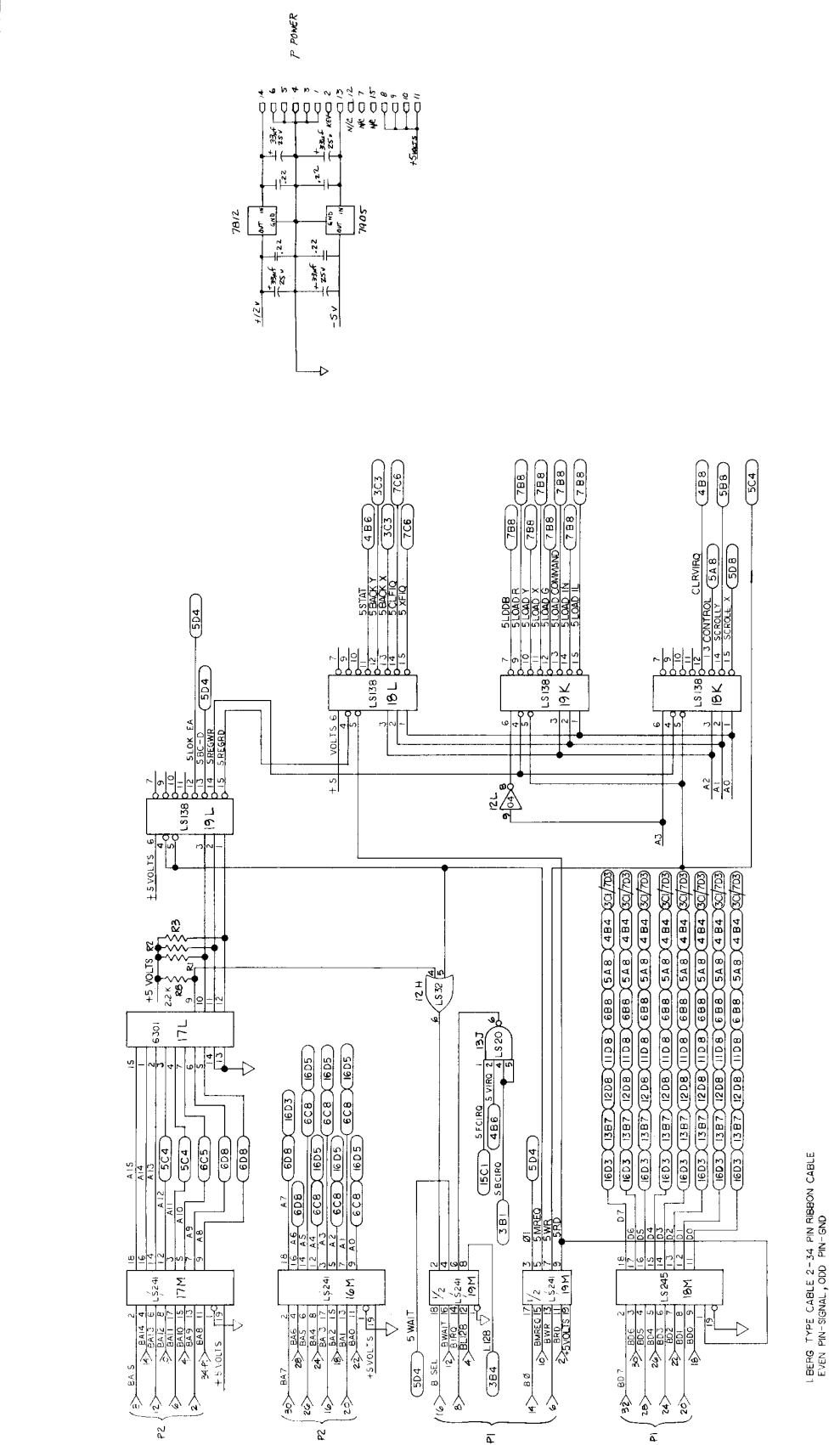

LEBERG TYPE CABLE 2- 34 PIN RIBBON CABLE
EVEN PIN-SIGNAL, ODD PIN-GND

PROPERTY OF	DESIGN OR DRAWING	CHECKED	DATE	DESIGNED BY	DATE	EXAMINED	DATE	SCALE	DATE	DO NOT SCALE DRAWING
THIS DOCUMENT IS THE PROPERTY OF										
IT IS NOT TO BE REPRODUCED OR										
DISSEMINATED WITHOUT AUTHORITY										
SIZE OF DRAWING	MATERIAL	OUTLINE	FUNCTION	TABLES	PART NUMBER		DATE	SCALE	DATE	DO NOT SCALE DRAWING
D	CPU INTERFACE				CPU INTERFACE					
77-0004-01					77-0004-01					

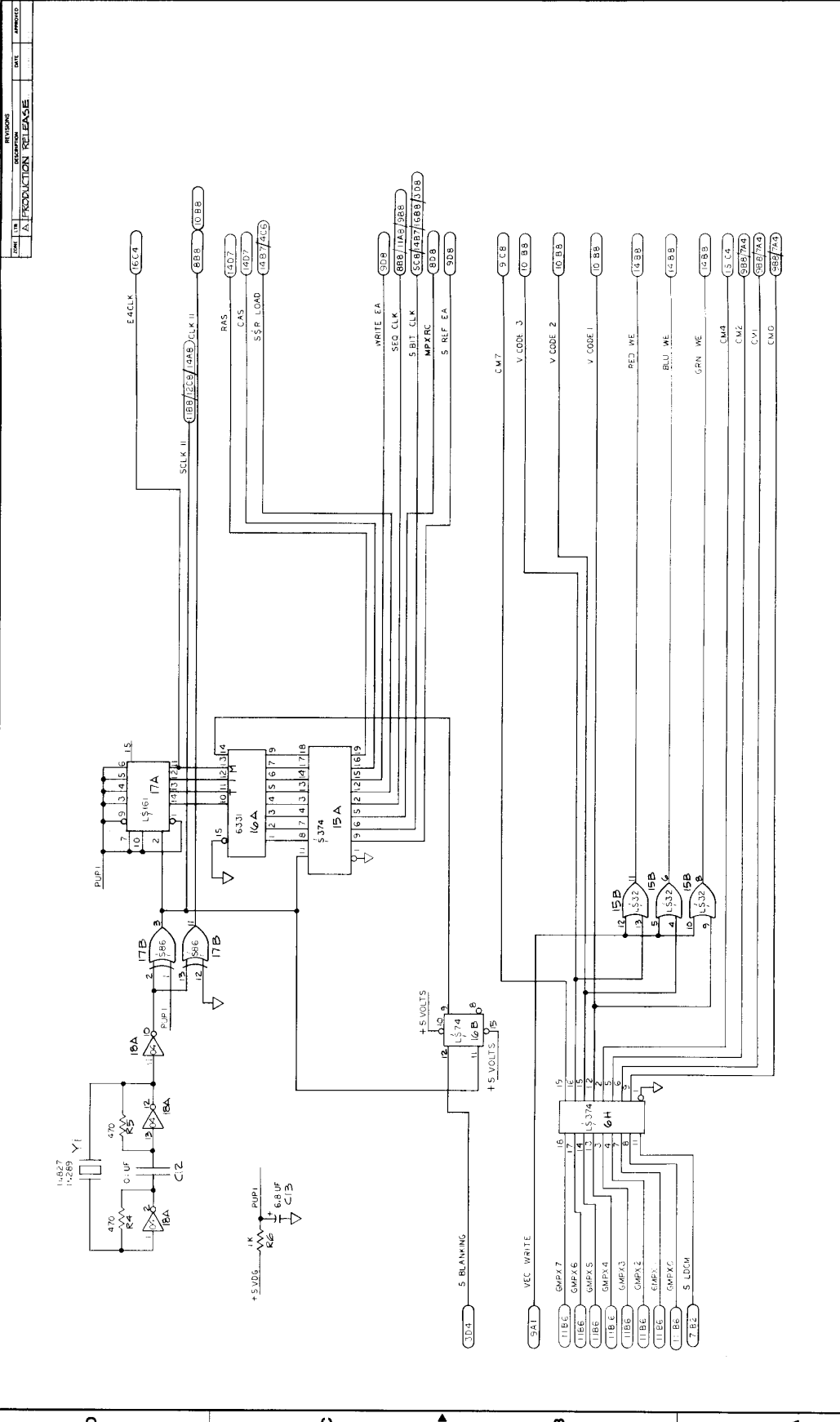

NOTES UNLESS OTHERWISE SPECIFIED:
 SHEET 2 OF 10
 DRAWING NO. 77-0004-01
 TITLE: MASTER CLK
 DESIGNED BY: 300 JAWA DR
 CA MARINA
 408-734-810
 CHECKED BY: [Signature]
 DATE: [Blank]
 PROJECT NUMBER: [Blank]
 SCALE: DO NOT SCALE DRAWING
 DATE OF ISSUE: [Blank]
 MATERIAL: [Blank]
 QUANTITY: [Blank]
 FUNCTION: [Blank]
 PART: [Blank]

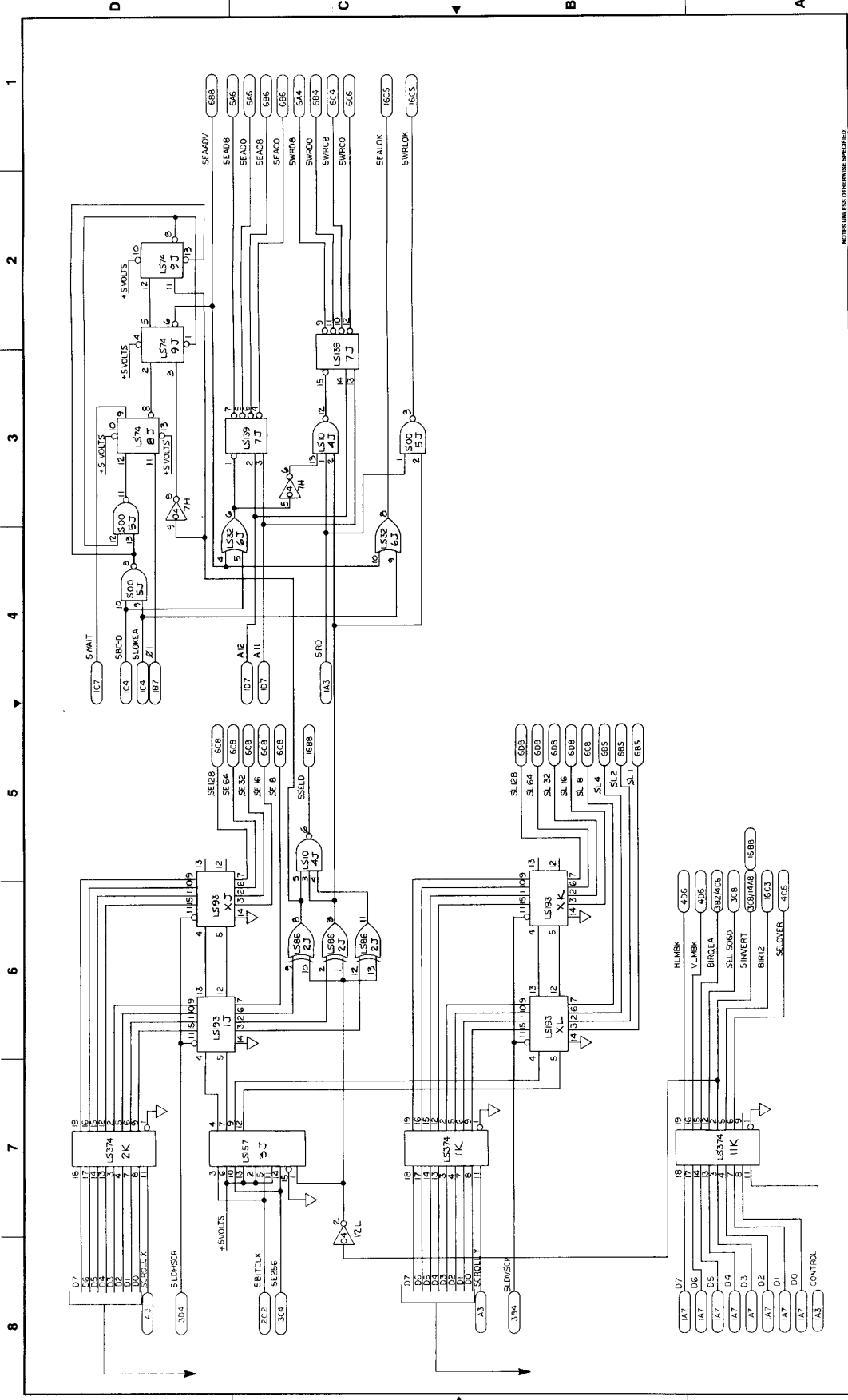

APPROVED BY THE DOCUMENT IS THE PROPERTY OF THE U.S. AIR FORCE AND IS LOANED TO YOU SUBJECT TO THE TERMS AND CONDITIONS OF THE LOAN AGREEMENT.	DRAWN BY DATE 8-29-81	NUMBER PROJECT NUMBER 100	DATE DATE 10/1/81	SCALE SCALE DO NOT SCALE DRAWING	TOLERANCES DIMENSIONS UNLESS OTHERWISE SPECIFIED	TITLE AND DESCRIPTION SCROLL REGISTER ADDRESS DECODING	SIZE SIZE D	SHEET SHEET 5	DRAWING NO. DRAWING NO. 77-0004-01
	NOTE: UNLESS OTHERWISE SPECIFIED,								

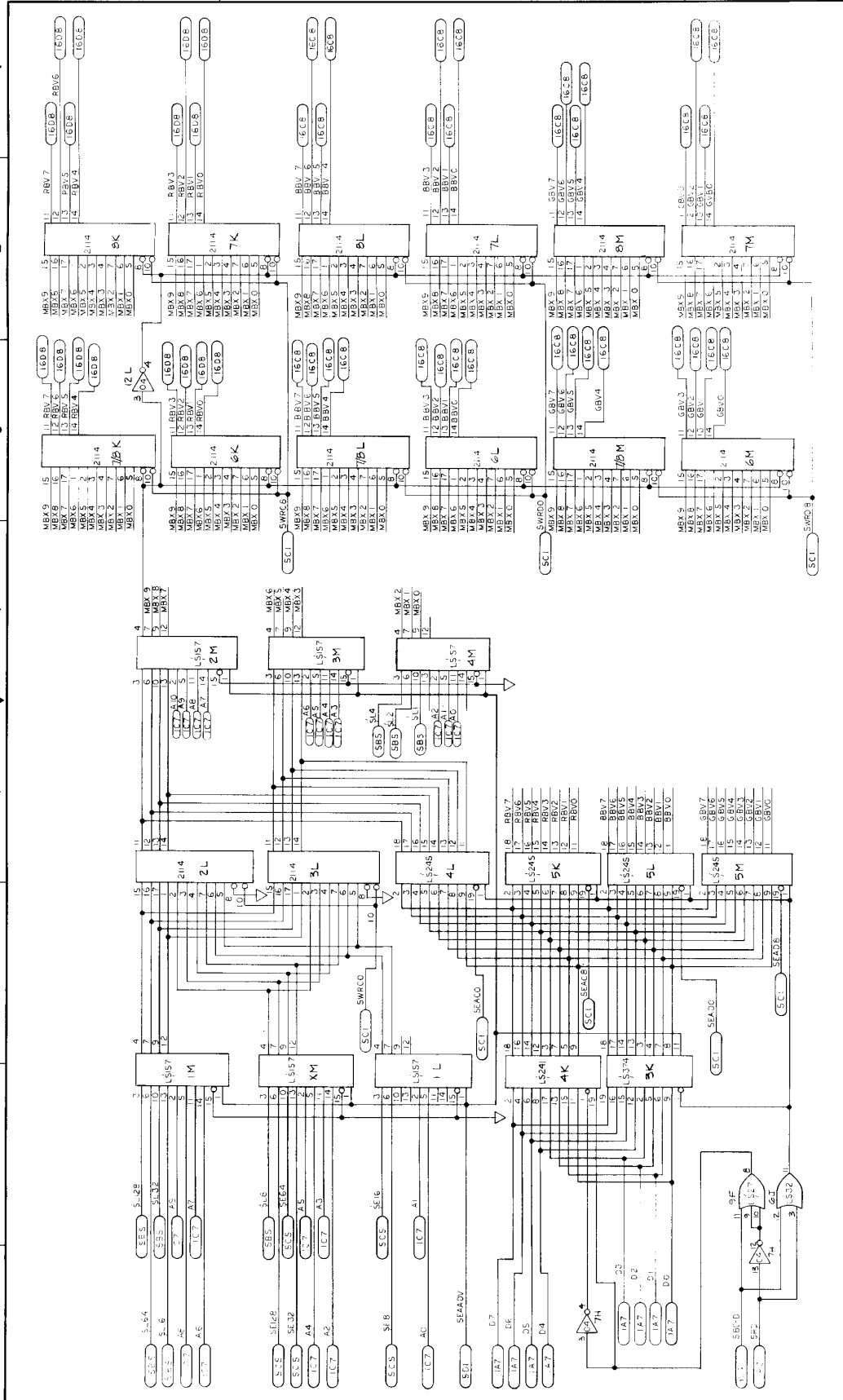

PROPRIETARY THIS DRAWING IS THE PROPERTY OF GENERAL MILITARY, INC. REPRODUCED BY ANY OTHER MEANS WITHOUT PERMISSION IS PROHIBITED.	CHECKED DATE: _____ DRAWN BY: <i>[Signature]</i>	PRODUCT NUMBER: <i>[Signature]</i>	DATE: _____ OWNER: _____	TITLE: _____	SHEET NO. _____ OF _____	DRAWING NO. <i>77-0004-01</i>
				PARTS LIST	QUANTITIES	MATERIAL

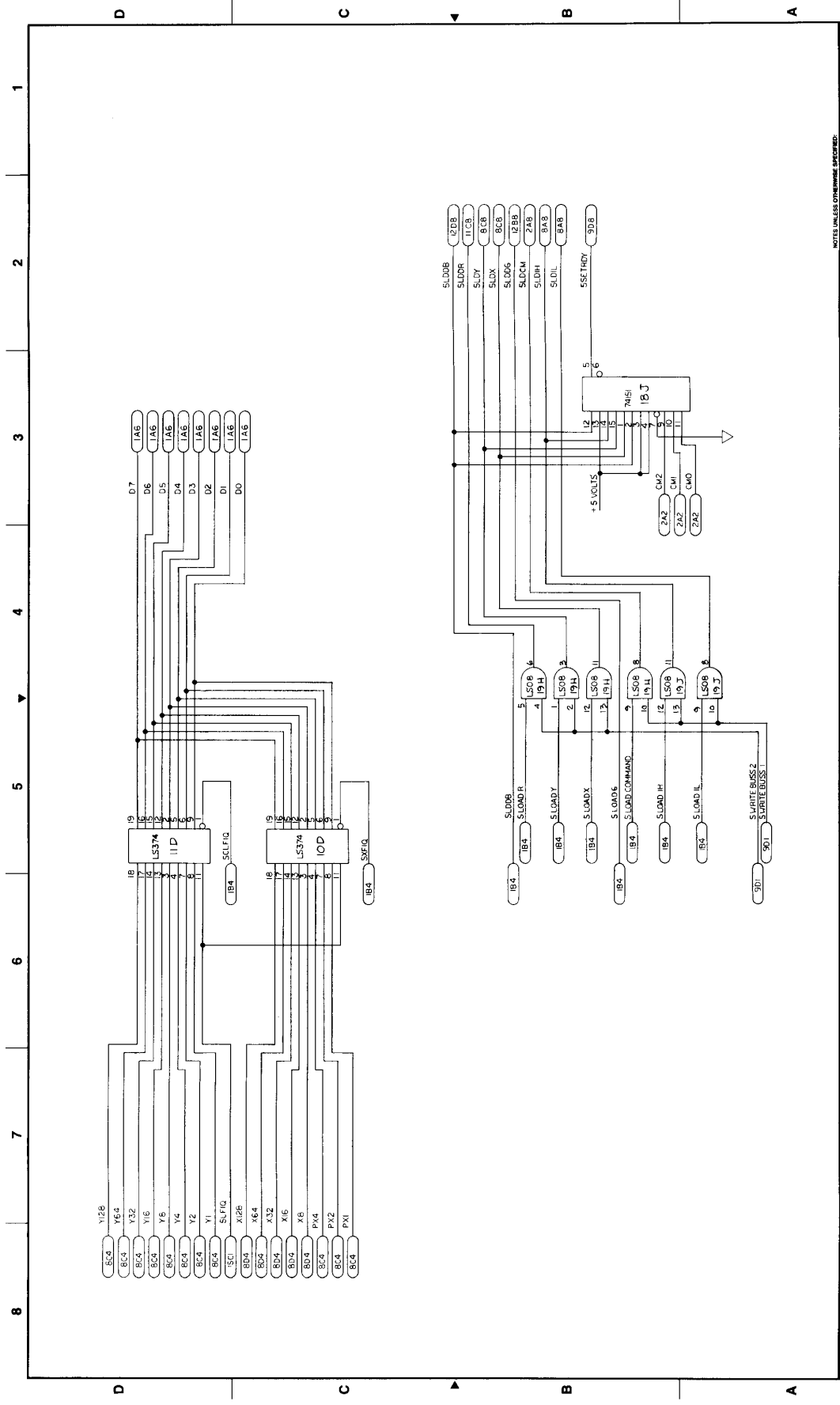

PROPRIETARY THE INFORMATION CONTAINED HEREIN IS UNCLASSIFIED EXCEPT WHERE SHOWN OTHERWISE.		DESIGN DRAWING DESIGNER'S NAME DATE		CHECKED DATE		DATE DATE		PROJECT NUMBER DATE		DO NOT SCALE DRAWING		DATE OF SHEET TOTAL SHEETS		NUMBER OF SHEETS TOTAL NUMBER OF SHEETS		DRAWING NUMBER 77-0004-01		SHEET NUMBER 7 OF 16		DRAWING TITLE REGISTER ADDRESS DECODING		DRAWING SCALE 1/16"	
-----------------------------------------------------------------------------------------------	--	-------------------------------------------	--	-----------------	--	--------------	--	------------------------	--	----------------------	--	-------------------------------	--	--------------------------------------------	--	------------------------------	--	-------------------------	--	--------------------------------------------	--	------------------------	--

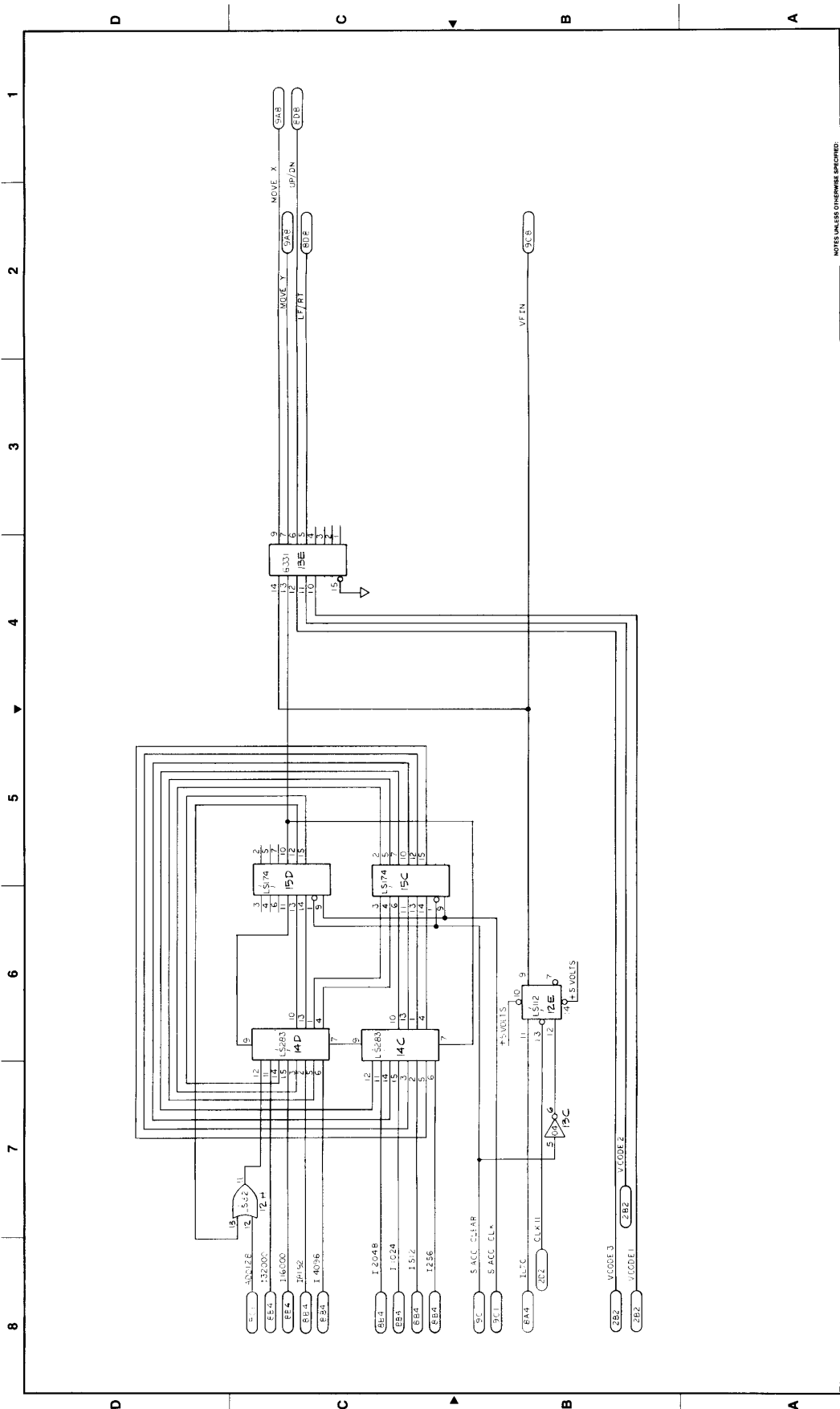

PROPERTY	DESIGN DRAWING	DESIGNED BY	DATE	SCALE	DATE OF REVISION	TOLERANCES	FUNCTIONS	REVISIONS	NO.	REV.	TITLE OR DESCRIPTION	NO.	REV.	DATE	NO.	REV.	NO.	REV.	NO.	REV.
77-0004-01	77-0004-01	77-0004-01	77-0004-01	77-0004-01	77-0004-01	77-0004-01	77-0004-01	77-0004-01	77-0004-01	77-0004-01	77-0004-01	77-0004-01	77-0004-01	77-0004-01	77-0004-01	77-0004-01	77-0004-01	77-0004-01	77-0004-01	77-0004-01

NOTES: UNLESS OTHERWISE SPECIFIED:
 300 JAVA DR
 408-724-810

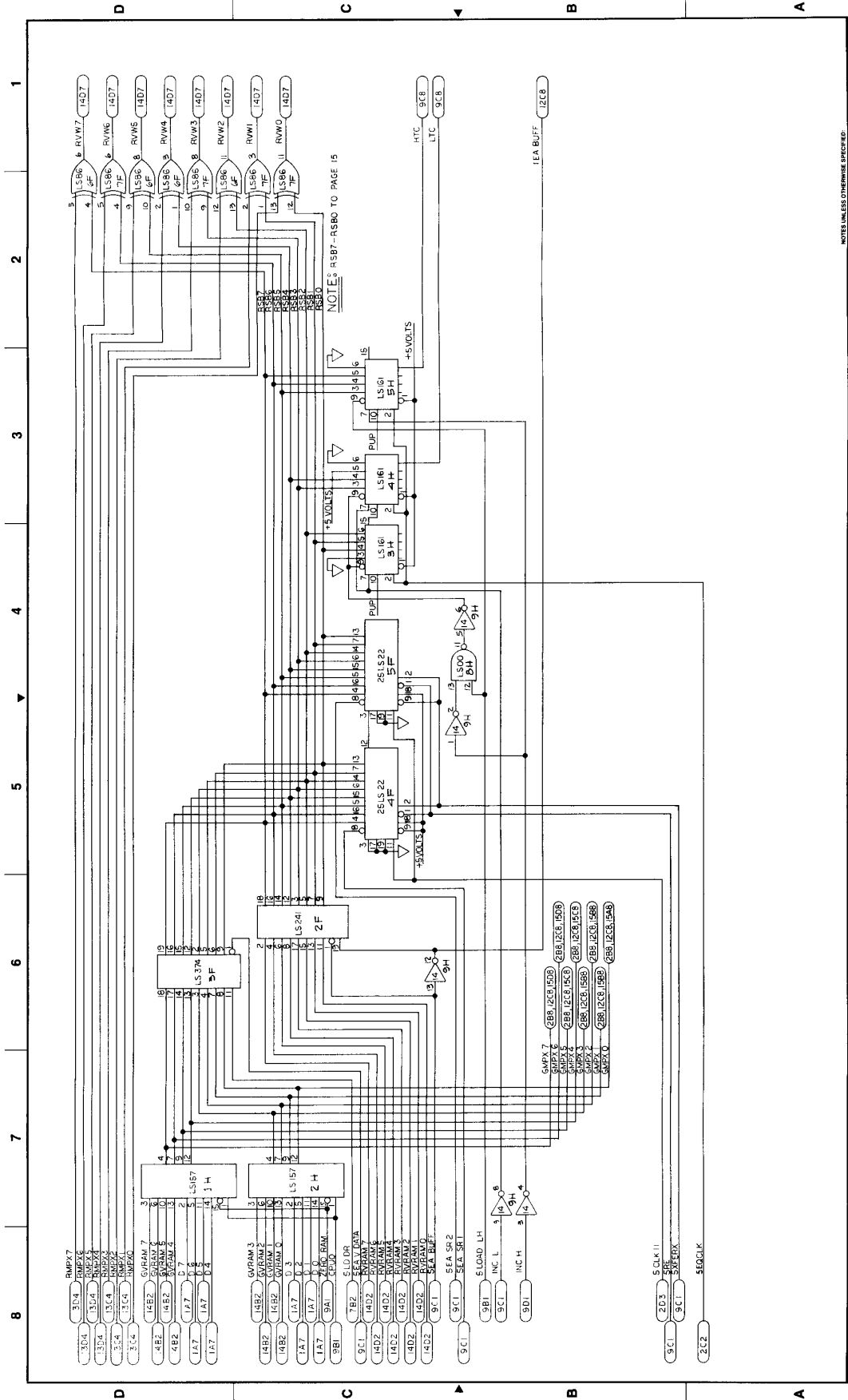

PROPERTY OF THE COMPANY OR INDIVIDUAL WHOSE PROPERTY THIS DRAWING IS. IT IS TO BE KEPT IN CONFIDENTIALITY AND NOT TO BE REPRODUCED OR COPIED WITHOUT THE WRITTEN PERMISSION OF THE COMPANY OR INDIVIDUAL.

DESIGNED BY: [Signature] CHECKED BY: [Signature]

DATE: [Blank] PROJECT NUMBER: [Blank]

SCALE: [Blank] DO NOT SCALE DRAWING

SHEET NUMBER: 11 OF 14

DATE: 77-0004-01

REV: [Blank]

77-0004-01

12CB

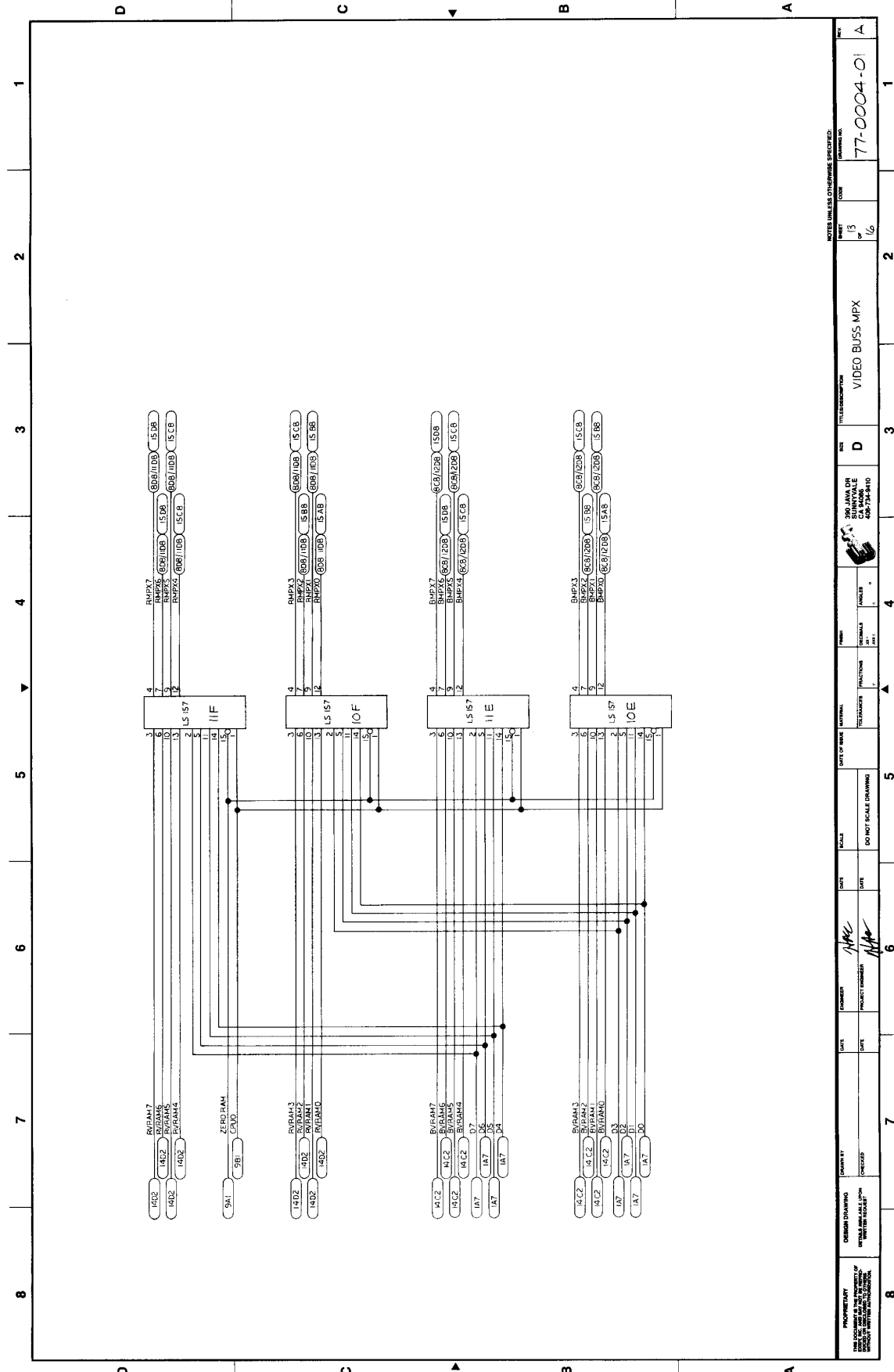

PROPRIETARY THIS DOCUMENT IS THE PROPERTY OF ORION & ASSOCIATES NO PART OF THIS DOCUMENT IS TO BE REPRODUCED OR TRANSMITTED IN ANY FORM OR BY ANY MEANS, ELECTRONIC OR MECHANICAL, INCLUDING PHOTOCOPYING, RECORDING, OR BY ANY INFORMATION STORAGE AND RETRIEVAL SYSTEM.		DRAWN BY CHECKED	DATE DATE	DESIGNER PROJECT NUMBER	SCALE DO NOT SCALE DRAWING	DATE OF WORK MATERIAL	TITLE/DESCRIPTION VIDEO BUSS MPX	SHEET 13 OF 16	DRAWING NO. 77-0004-01
---------------------------------------------------------------------------------------------------------------------------------------------------------------------------------------------------------------------------------------------------------------------------------------------------	--	---------------------	--------------	----------------------------	-------------------------------	--------------------------	-------------------------------------	-------------------------	---------------------------

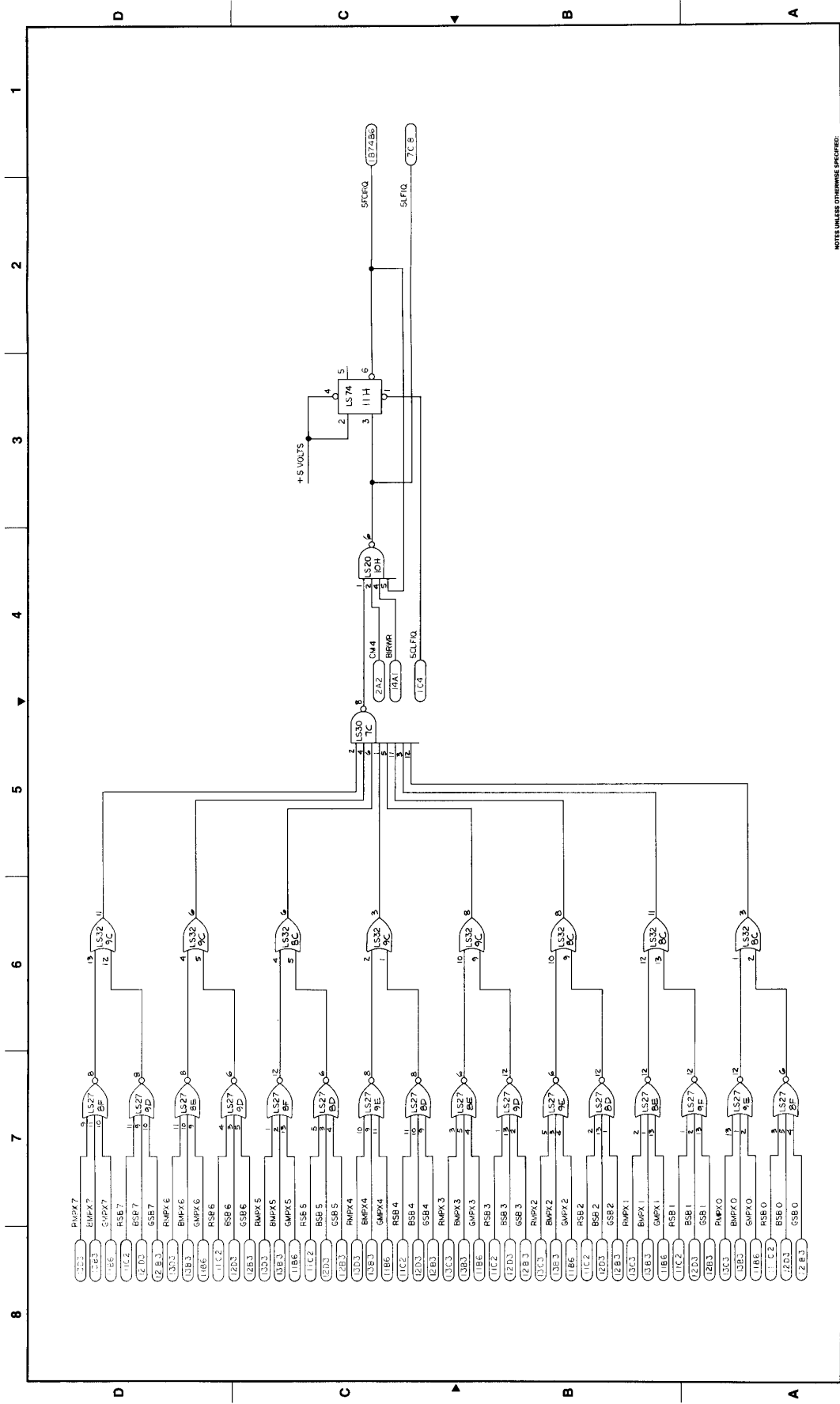

PROPERTY THIS DRAWING IS THE PROPERTY OF COLLISSIA DETECTION, INC. NO PARTS TO BE REPRODUCED OR COPIED WITHOUT WRITTEN PERMISSION	DESIGNED BY S. J. B.	CHECKED BY [Signature]	DATE [Date]	DRAWN BY [Signature]	DATE [Date]	TITLE COLLISION DETECTION, FOREGROUND	SIZE D	MATERIAL DESCRIPTION COLLISION DETECTION, FOREGROUND	SHEET NO. 15 OF 16	DRAWING NO. 77-0004-01
	DESIGN DRAWING CHECKED BY [Signature]	DATE [Date]	DRAWN BY [Signature]	DATE [Date]	TITLE COLLISION DETECTION, FOREGROUND	SIZE D	MATERIAL DESCRIPTION COLLISION DETECTION, FOREGROUND	SHEET NO. 15 OF 16	DRAWING NO. 77-0004-01	NOTES UNLESS OTHERWISE SPECIFIED: 1. UNLESS OTHERWISE SPECIFIED, ALL DIMENSIONS ARE IN INCHES. 2. DIMENSIONS ARE TO CENTER UNLESS OTHERWISE SPECIFIED. 3. DIMENSIONS ARE TO CENTER UNLESS OTHERWISE SPECIFIED. 4. DIMENSIONS ARE TO CENTER UNLESS OTHERWISE SPECIFIED.

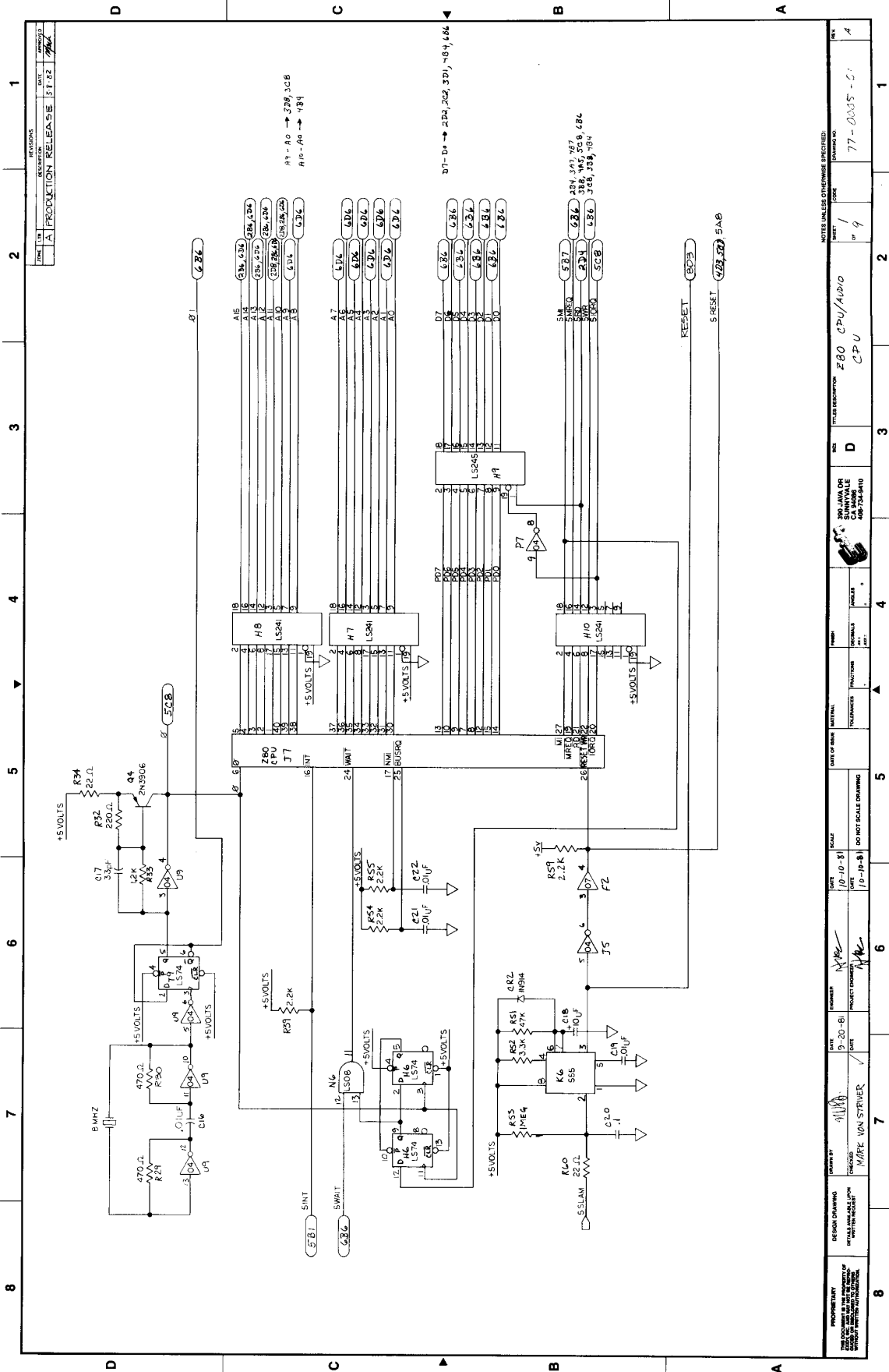

DATE	ISSUE	REVISION
17.12	1	1
A PRODUCTION RELEASE 17.12 1964		

NO.	DESCRIPTION	QTY	UNIT	REMARKS
1	580 CPU/AUDIO	1	PCB	
2	CPU	9		
TOTALS				
1		10		

NOTE: UNLESS OTHERWISE SPECIFIED:

- RESISTORS: 1% TOLERANCE
- CAPACITORS: 5% TOLERANCE
- WELDED CONTACTS: 100% TOLERANCE

PROJECT NAME	DATE	SCALE	DATE
580 CPU/AUDIO	10-10-64	1:1	10-10-64
DESIGNER	DATE	PROJECT ENGINEER	DATE
MARK VAN STEUER	9-20-64	MARK VAN STEUER	10-10-64
CHECKED	DATE	PROJECT ENGINEER	DATE

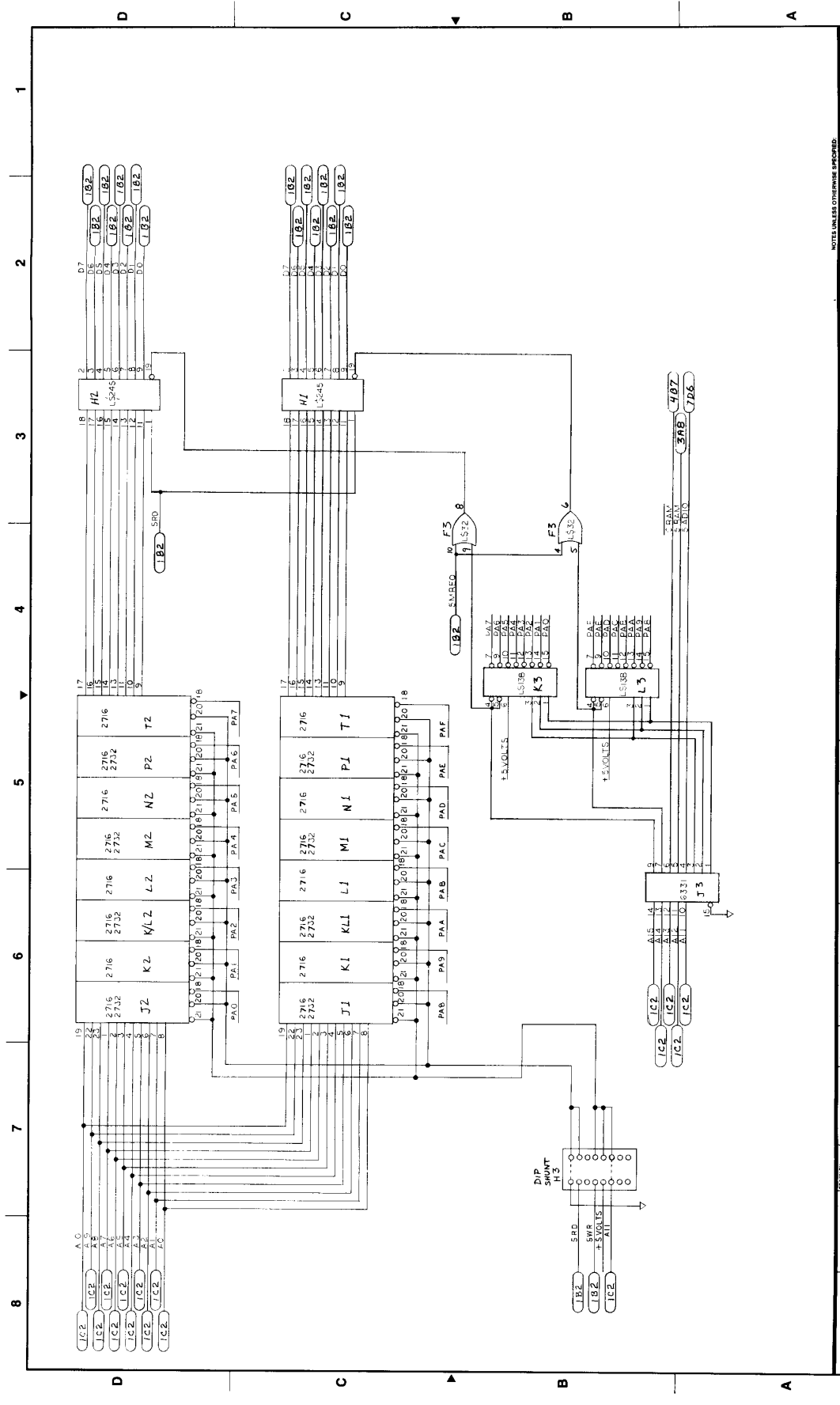

PROPRIETARY
THIS DOCUMENT IS THE PROPERTY OF
MILITARY AERONAUTICAL ESTABLISHMENT
REPRODUCTION IS PROHIBITED

DESIGN ORIGINATOR: MAFK VON STRIVER
CHECKED: MAFK VON STRIVER
DATE: 9-27-81

PROJECT NUMBER: AVE
PROJECT ENGINEER: MAFK VON STRIVER
DATE: 10-19-81

SCALE: DO NOT SCALE DRAWING

SHEET NUMBER: 2
TOTAL SHEETS: 9

DATE OF ISSUE: 10-19-81

REVISIONS:

NO.	DESCRIPTION	DATE	BY	CHKD.
1	INITIAL DESIGN	10-19-81	AVE	MAFK VON STRIVER
2	REVISION	10-19-81	M	MAFK VON STRIVER

APPROVED: MAFK VON STRIVER
DATE: 10-19-81

FUNCTION: PROGRAM MEMORY

ITEM NUMBER: 77-0005-C1

REV: A

NOTES UNLESS OTHERWISE SPECIFIED:

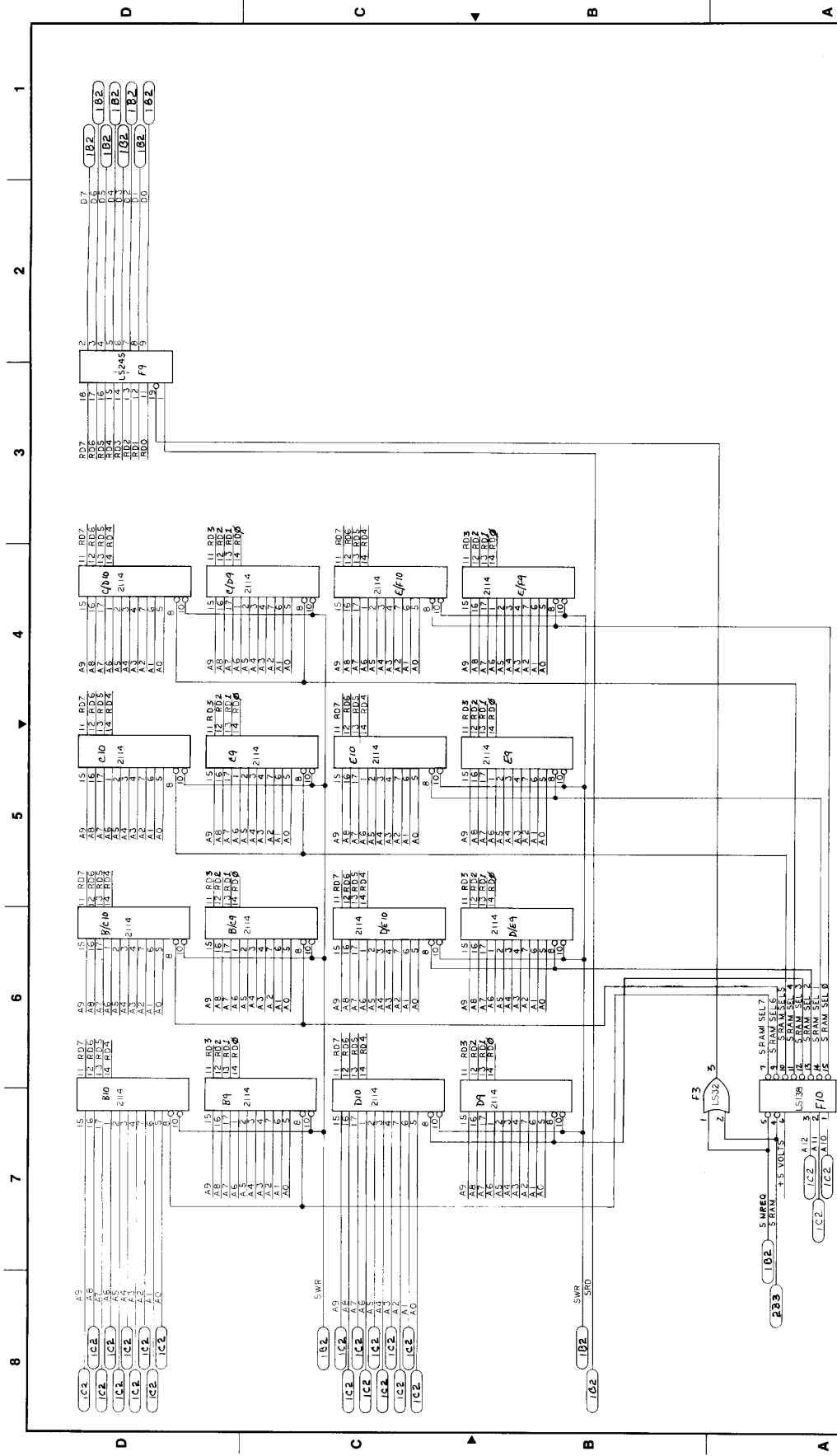

<p>PROPOSED BY: [Signature]</p> <p>DESIGN DRAWING: [Signature]</p> <p>DATE: 9-20-81</p> <p>PROJECT NUMBER: [Signature]</p> <p>DATE: 19-11-81</p> <p>DESIGNER: MARK VON STRIVER</p>	<p>DATE: 10-10-81</p> <p>DATE: 19-11-81</p> <p>DO NOT SCALE DRAWING</p>	<p>DATE OF ISSUE: [Blank]</p> <p>TITLE: [Blank]</p> <p>SCALE: [Blank]</p> <p>NO. OF SHEETS: [Blank]</p> <p>TOTAL SHEETS: [Blank]</p> <p>REVISIONS:</p> <p>NO. REV. DESCRIPTION</p>	<p>REV: D</p> <p>ISSUED: [Blank]</p> <p>DATE: [Blank]</p> <p>BY: [Blank]</p> <p>CHECKED: [Blank]</p> <p>DATE: [Blank]</p>	<p>FIGURE NO: 77-0005-01</p> <p>REV: A</p> <p>DATE: [Blank]</p> <p>BY: [Blank]</p> <p>CHECKED: [Blank]</p> <p>DATE: [Blank]</p>	<p>DESCRIPTION: E60 CPU/A630</p> <p>E60 RAM</p>	<p>PAGE: 3</p> <p>OF: 9</p>	<p>NOTES UNLESS OTHERWISE SPECIFIED:</p>
------------------------------------------------------------------------------------------------------------------------------------------------------------------------------------	-------------------------------------------------------------------------	------------------------------------------------------------------------------------------------------------------------------------------------------------------------------------	---------------------------------------------------------------------------------------------------------------------------	---------------------------------------------------------------------------------------------------------------------------------	-------------------------------------------------	-----------------------------	------------------------------------------

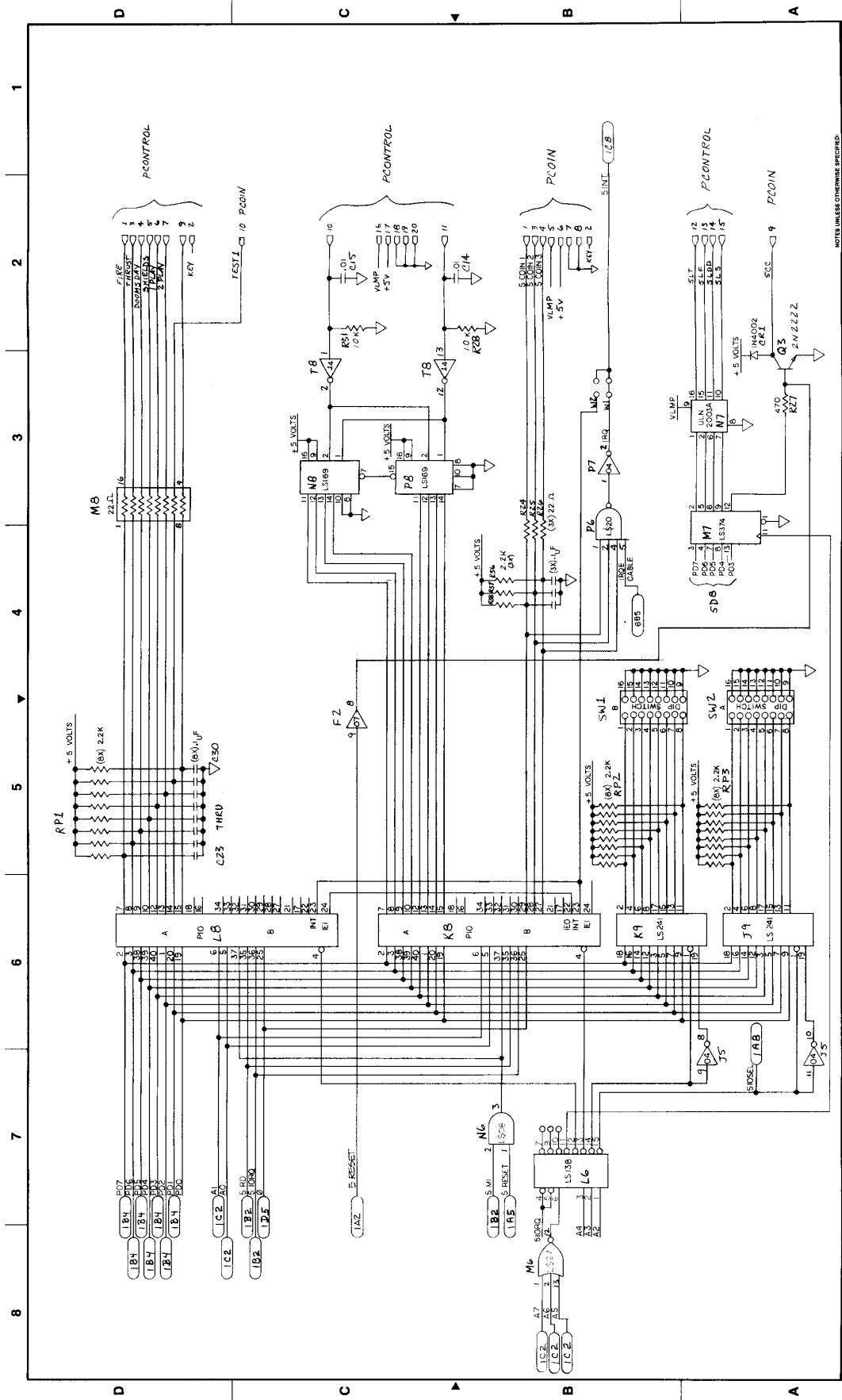

PROPERTY	DESIGN DRAWING	DATE	9-2-81	SCALE	DO NOT SCALE DRAWING	DATE OF ISSUE	NATURAL	FUNCTION	FORMER	REVISION	DATE	77-0005-01	REV	4	
THESE DRAWINGS ARE TO BE USED ONLY IN CONNECTION WITH THE PROJECT AND NOT TO BE REPRODUCED OR COPIED IN ANY MANNER WITHOUT THE WRITTEN PERMISSION OF THE PROJECT ENGINEER.	DATE	11-18-81	DATE	11-18-81	SCALE	DO NOT SCALE DRAWING	DATE OF ISSUE	NATURAL	FUNCTION	FORMER	REVISION	DATE	77-0005-01	REV	4
PROJECT: MARK VON STRIEMER PROJECT NUMBER: 9-2-81 DRAWN BY: M/V CHECKED BY: M/V TITLE: 386 JAVA DR SELECTION 280 CPU / 400 D 400-754-410 D 5 9 77-0005-01 4															

NOTE: UNLESS OTHERWISE SPECIFIED:

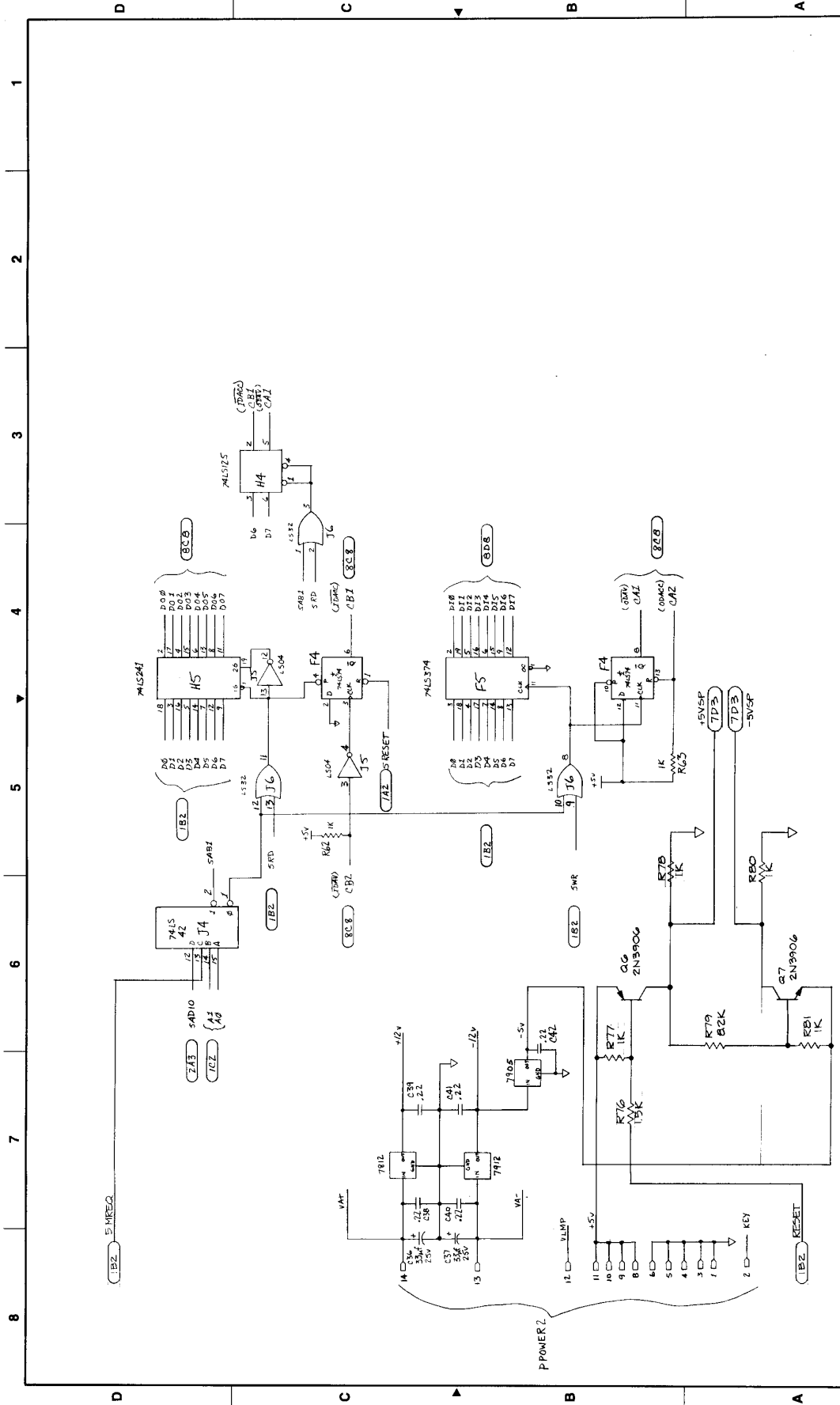

PROJECT NUMBER 77-0005-01	SHEET 7	OF 9	DRAWN BY [Signature]
TITLE AUDIO-CPU INTERFACE	PART NUMBER 77-0005-01	DATE 2-15-81	PROJECT NUMBER 77-0005-01
APPROVED BY [Signature]	CHECKED BY [Signature]	DATE 2-15-81	PROJECT NUMBER 77-0005-01
DRAWN BY [Signature]	CHECKED BY [Signature]	DATE 2-15-81	PROJECT NUMBER 77-0005-01

8 7 6 5 4 3 2 1

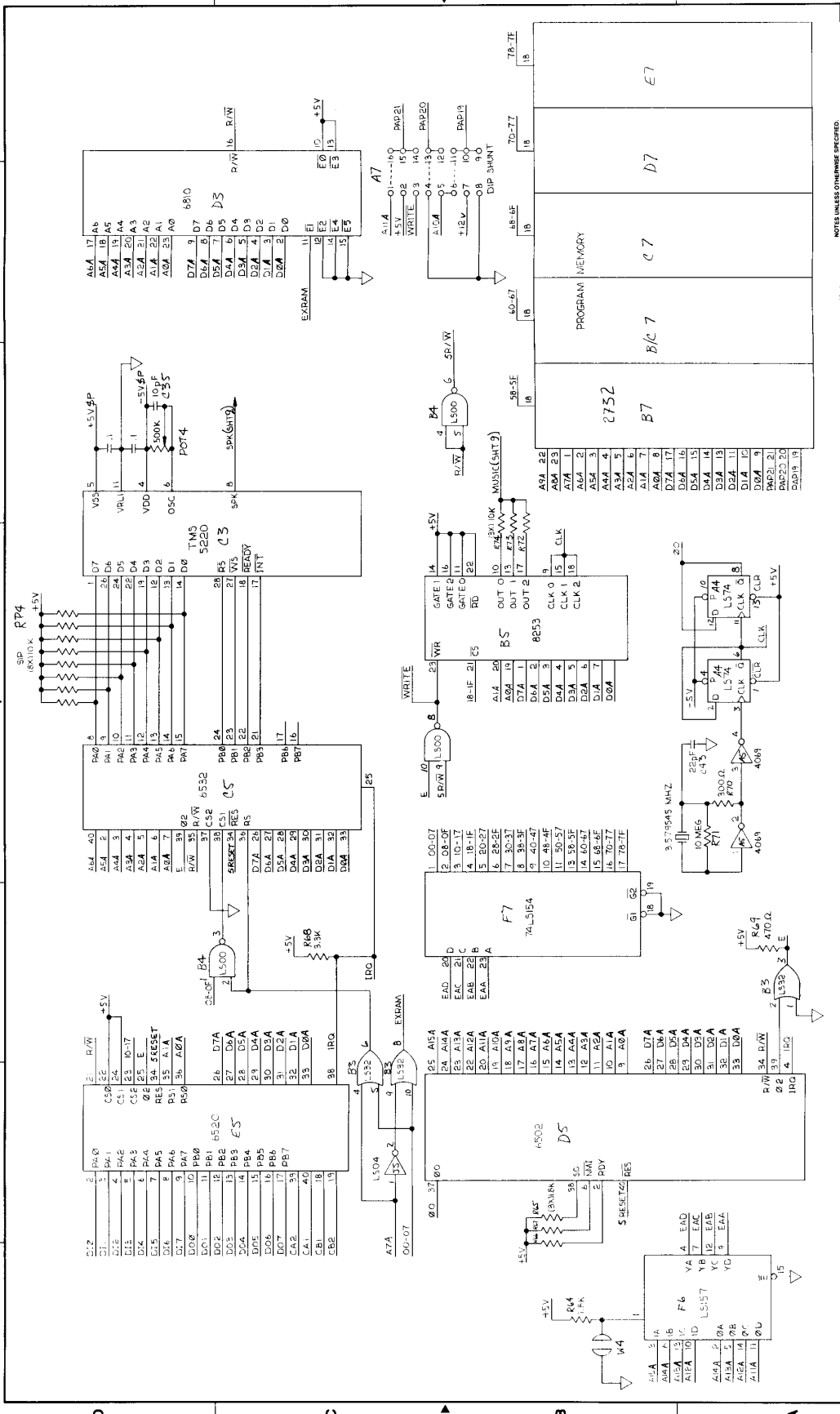

PROPRIETARY	DESIGN DRAWING	DATE	SCALE	DATE OF ISSUE	REVISION	PROJECT NUMBER	PROJECT NAME	DATE	BY	CHECKED	APPROVED
NOTED: THIS DRAWING IS THE PROPERTY OF OPTIMA ELECTRONICS AND IS NOT TO BE REPRODUCED OR TRANSMITTED IN ANY FORM OR BY ANY MEANS, ELECTRONIC OR MECHANICAL, INCLUDING PHOTOCOPYING, RECORDING, OR BY ANY INFORMATION STORAGE AND RETRIEVAL SYSTEM.	OPTIMA ELECTRONICS	12-13-81	DO NOT SCALE DRAWING				MARK VON STRUER				
TITLE: Z80 CPU/AUDIO SHEET: 8 OF 9 DRAWING NO: 77-0055-01 NOTES: UNLESS OTHERWISE SPECIFIED											

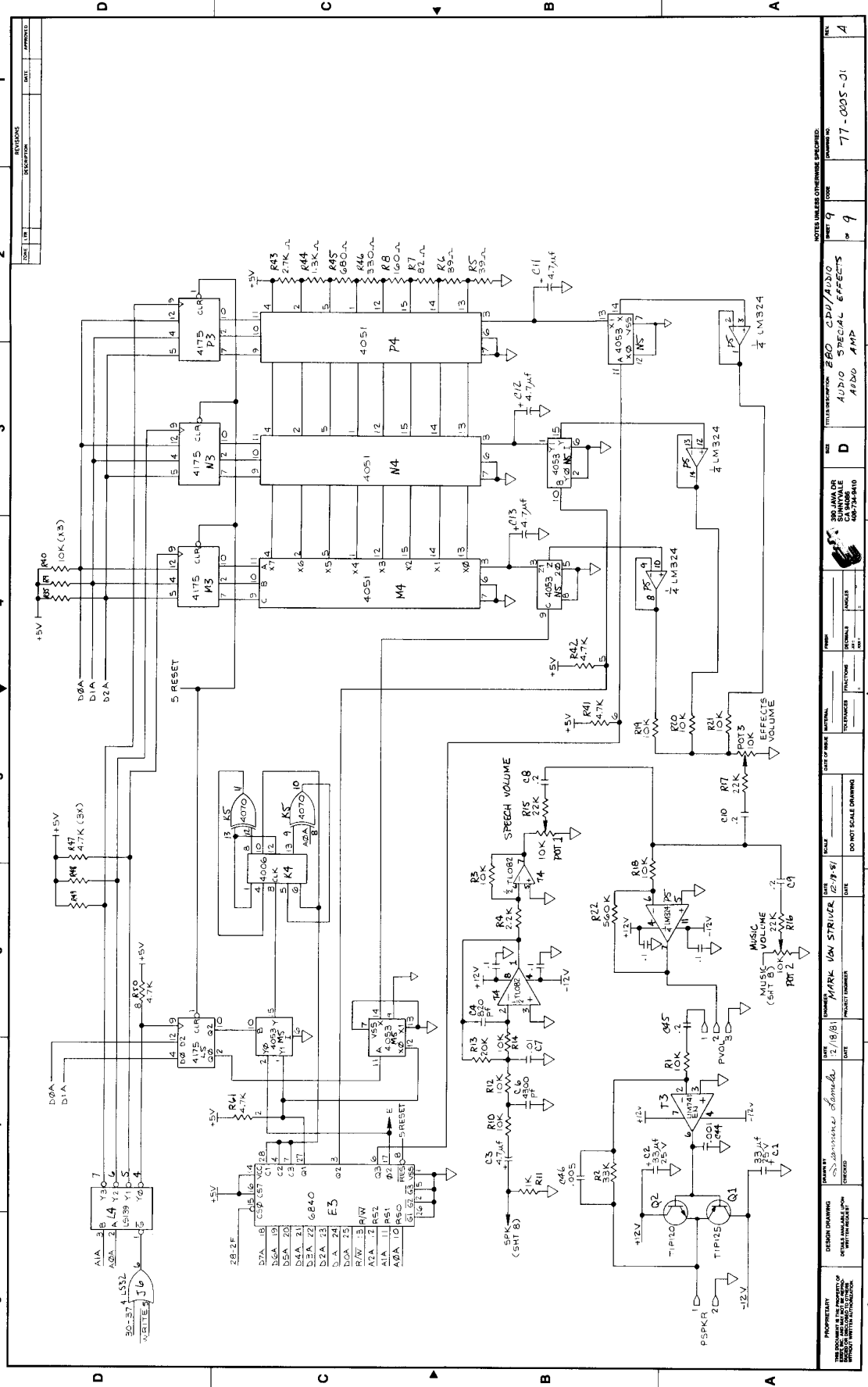

REV	DATE	DESCRIPTION	BY	APP'D
1				

REV	DATE	DESCRIPTION	BY	APP'D
1				

REV	DATE	DESCRIPTION	BY	APP'D
1				

REV	DATE	DESCRIPTION	BY	APP'D
1				

REV	DATE	DESCRIPTION	BY	APP'D
1				

REV	DATE	DESCRIPTION	BY	APP'D
1				

REV	DATE	DESCRIPTION	BY	APP'D
1				

REV	DATE	DESCRIPTION	BY	APP'D
1				

REV	DATE	DESCRIPTION	BY	APP'D
1				

REV	DATE	DESCRIPTION	BY	APP'D
1				

REV	DATE	DESCRIPTION	BY	APP'D
1				

REV	DATE	DESCRIPTION	BY	APP'D
1				

REV	DATE	DESCRIPTION	BY	APP'D
1				

REV	DATE	DESCRIPTION	BY	APP'D
1				

REV	DATE	DESCRIPTION	BY	APP'D
1				

REV	DATE	DESCRIPTION	BY	APP'D
1				

REV	DATE	DESCRIPTION	BY	APP'D
1				

REV	DATE	DESCRIPTION	BY	APP'D
1				

VICTORY™

Addendum 1.1 to
Operation and Service Manual
1st Edition

© 1982 Exidy, Inc.
390 Java Drive, Sunnyvale,
California 94086-1271
Telephone: (408) 734-9410
Toll-free: (800) 538-8402
Telex: 357-499 (EXIDY MNTV)

Exidy Ireland
Gortlandroe Industrial Estate
Nenagh, County Tipperary
Ireland
Telephone: (067) 32555
Telex: 70009 (EXDY EI)

TABLE OF CONTENTS

A. AUTOMATIC SELF-DIAGNOSTIC TESTS

1. Logic/Game System Diagnostic Tests.....	1
Program ROM CRC Test.....	2
Program Volatile RAM Test.....	2
Program Non-Volatile RAM Test.....	2
Processor Interrupts Test.....	2
Video Foreground RAM Test.....	2
Video Background RAM Test.....	2
CMOS RAM Reset	2
Audio Subsystem Test	3
2. Bypassing Automatic Diagnostic Tests	4
3. Audio System Diagnostic Tests	4
B. MANUAL DIAGNOSTIC TESTS	5
1. Video Lookup Table	5
2. Front Panel, Coin Mechs	5
3. Monitor Cross Hatch	6
4. Monitor Color Bars	6
C. COIN JAM ERROR	6
D. LIT CONTROL PANEL BUTTONS	6
APPENDIX A: ERROR CODES AND ERROR MESSAGES	7

COPYRIGHT

Copyright © 1982 by Exidy Inc. All rights reserved. No part of this publication may be reproduced, transmitted, transcribed, stored in a retrieval system, or translated into any language, in any form, or by any means without the prior written permission of Exidy, Inc., 390 Java Drive, Sunnyvale, California 94086.

DISCLAIMER

Exidy Inc. makes no representations or warranties with respect the contents hereof and specifically disclaims any implied warranties of merchantability or fitness for any particular purpose. Further, Exidy Inc. reserves the right to revise this publication and to make changes from time to time in the content hereof without obligation of Exidy Inc. to notify any person of such revision or changes.

TRADEMARKS

VICTORY™ is a registered trademark of Exidy Inc.

WARNING

This equipment generates, uses and can radiate radio frequency energy and if not installed and used in accordance with the instruction manuals, may cause interference to radio communications. As temporarily permitted by regulation, it has not been tested for compliance with the limits for Class A computing devices pursuant to Subpart J of Part 15 of FCC Rules, which are designed to provide reasonable protection against such interference. Operation of this equipment in a residential area is likely to cause interference in which case the user at his own expense will be required to take whatever measures may be required to correct the interference.

DIAGNOSTIC TESTS

VICTORY™ has both Automatic Self-Diagnostic Tests and Manual Diagnostic Tests. The Automatic Self-Diagnostic Tests are performed each time VICTORY™ is powered on. At that time, two processors are tested: the logic/game system, the audio system and the communications between the two. Manual Diagnostic Tests may be selected individually from a screen menu when in the Operator Interface Mode.

A. AUTOMATIC SELF-DIAGNOSTIC TESTS

On power-up, VICTORY™ automatically performs diagnostic tests on the logic/game system and the Audio system. Eight logic tests are run. Each is signified on the screen as a different color. The entire procedure takes approximately 45 seconds. The Audio CPU test is run simultaneously by the audio processor and its completion is signified by one high pitched and one low pitched beep. Hearing more or less than two beeps, indicates a failure as outlined in Audio Board Diagnostic Test Section.

If VICTORY™ passes all tests, the Attract Mode is displayed in the usual fashion.

1. Logic/Game System Diagnostic Tests

If VICTORY fails any one of the eight self-diagnostic tests, it freezes, verbally announces 'Unit Test Failed', and displays one of the following messages:

DIAGNOSTIC TEST FAILURE

Test: (name of test)

PC Board Location: xx

PUSH ANY BUTTON TO CONTINUE

or:

DIAGNOSTIC TEST FAILURE

Test: (name of test)

Error Code: xx

PUSH ANY BUTTON TO CONTINUE

The first screen appears when a test fails and a specific board location can be isolated as the cause of failure. Other tests are less specific, so the causes of failure will be identified by the second message. In that case, the Error Code given references one of several error conditions, listed in this section and again in Appendix A.

All board locations and codes displayed are only indications of where to first check the problem. Because this diagnostic test only evaluates certain components which depend on additional circuitry to run, test results may not point directly to failure. Please use the results of this test as an indication of where to begin troubleshooting.

If any one test should fail, its error message will be displayed and you may push any button to have the remaining diagnostics performed. If no tests fail, or if failed tests are continued by a button push, the game goes into the Attract Mode.

Now we will go through each of the eight tests, in the order they are performed during the Automatic Diagnostic Test Mode. Each screen is color coded in the event an extreme failure prevents an error message from displaying. In this case, the general nature and location of the failure can be estimated by the color on the screen.

1. PROGRAM ROM CRC TEST (Green Screen) 10 seconds
Cyclic Redundancy Check, to make sure every binary bit in EPROM program is correct. In the event of a failure, a message gives the board location of the 4K 2732 EPROM which failed.
2. PROGRAM VOLATILE RAM TEST (Blue Screen) 2 seconds
Checks all Z80 processor program RAM for correct functioning. Volatile RAM is that RAM whose data is destroyed by a power up. In the event of a failure, a message gives a board location of the 2114 chip most likely in error.
3. PROGRAM NON-VOLATILE RAM TEST (Cyan Screen- blueish green) 1 second
This checks the Battery Backup RAM **hardware**. Non-volatile RAM contains data which is always retained, unless the battery fails. (See BATTERY DATA VALIDITY CHECK, below.) In the event of a failure, a message gives the board location of the 2K CMOS RAM chip.
4. PROCESSOR INTERRUPTS TEST (Red Screen) instantaneous
Checks interrupts coming from graphic system, going to the Z80 processor. If there is a failure in the interrupts, an error code is given as opposed to a specific location. The error codes are as follows:
01: Frame interrupt expected but not received
02: Foreground collision interrupt received, not expected
03: Foreground collision interrupt expected, not received
04: Foreground collision interrupt bad (X,Y) collision coordinate
05: Background collision interrupt received, not expected
06: Background collision interrupt expected, not received
07: Background collision interrupt bad (X,Y) collision coordinate
08: Unknown interrupt
FD: Microcode failure
FE: Microcode failure
FF: HSC Stuck busy (not ready)
5. VIDEO FOREGROUND RAM TEST (Yellow Screen, then scrolling red, blue then green) 15 seconds
Checks video graphic system RAM. If possible, a board location is given of the 16Kx1 RAM chip most likely in error. If it can't localize the problem, it gives an error code, as follows:
FC: Red plane error, chip unknown
FD: Blue plane error, chip unknown
FE: Green plane error, chip unknown
FF: HSC Stuck busy
6. VIDEO BACKGROUND RAM TEST (Magenta Screen- reddish purple) 5 seconds
Checks video graphic system RAM. In the event of an error, a message gives the board location of the 2114 RAM chip to check.
7. CMOS RAM RESET (Battery Data Validity Check) (no color) instantaneous.
Checks the actual data in the battery backup RAM retained since the last power down. If the CMOS RAM has failed to retain data (the Highest Scores Tables,

Operator Options, Statistics, etc.) everything resets to factory settings. The game can still be played in this case, but this serves as a message to the operator that his settings may need to be redone if he has changed them from the factory settings.

Error Code: 01- Means all battery backup RAM has been reset to factory settings.

8. AUDIO SUBSYSTEM TEST (*Stand By* screen message) 10 seconds
The status of the Audio Board test is given to the logic processor, while the following message appears on the screen:

STAND BY

VERSION X.X DATE XX/XX/XX

The following sounds are heard: Computer Copilot saying "Bonus", a musical tune, and the sound effect of a klaxon (horn).

If there is a failure, it may be in either the Audio Board itself, or in the communications between the Audio and Logic Board. The following are error codes:

01: ZERO PAGE RAM FAILURE. Check 6532 location 6C or 6810 at 3D.

03: AUDIO EPROM FAILURE. Any error code ending with a 3

13: (03, 13, 23, 33) indicates a ROM failure. The first

23: digit (2 and 3, for example) indicates the appro-

33: priate chip that needs to be checked.

<u>Message</u>	<u>2K 2716</u>	<u>Chip to Check</u>
03		7BC
13		7C
23		7D
33		7E

04: INTERRUPT FAILURE, check 6532, location 6C.

05: SPEECH FAILURE. Check 5220 at 3C or 6532 at 6C.

FD: Audio command function won't terminate

FE: RECEIVE input link malfunction, check PIA 6520 at 6E

FF: SEND output link malfunction, check PIA 6520 at 6E

If this test passes, VICTORY enters the Attract Mode.

2. Bypassing Automatic Diagnostic Tests

Operators will want to make use of the Automatic Diagnostic Test feature to assure their game is working properly. However, technicians, powering the game on and off frequently, may wish to bypass this procedure. To do so, activate either coin mechanism while powering up VICTORY™ and then **immediately** let go once powered. That is, activate coin mech, power on game, deactivate immediately.

3. Audio System Diagnostic Tests

While the logic/game system tests are underway the Audio system is also performing self-tests. It indicates the results with audible beeps (and on the screen as well with Logic test #8.)

Ten seconds after power-on, one or more quick beeps, like an organ chord, are heard. This is part of the Exidy Audio Diagnostic Test. The number of beeps that sound indicate different conditions of the Audio board. Two types of beeps are heard: high pitched and low pitched. The high pitched beeps signify a speech chip condition. Low pitched beeps deal with conditions elsewhere in the audio system.

Note: This test does not check the communication between the audio and the logic processor. It is possible, then, to have the audio checkout okay, but for the communications between the audio and the logic to be faulty. This would result as an error in the Logic Diagnostic test #8, Audio Subsystem Test.

The following code is only an indication of where to first check the Audio Board. Because this diagnostic test only evaluates certain components, other circuitry is relied upon for the test. Should this other circuitry fail, the diagnostic test may not, then, point directly to the failure. Please use the results of this test as a guideline for further troubleshooting.

The code is as follows:

Number of beeps	Significance
0:	If no beeps are heard, along with a hum or random notes, this indicates a serious failure on the Audio Board. It could also mean the master volume or individual volumes are turned down.
1 HI only:	All audio hardware is OK, except the music section or its volume is malfunctioning.
1 LO only:	OK except something between the speech chip and the speaker is malfunctioning, or check speech volume.
1 LO & 1 HI:	All is OK. This is the normal sequence.
2 LO:	ZERO PAGE RAM FAILURE. Check 6532 location 6C or 6810 at 3D.
3 LO:	(will not occur)
4 LO:	ROM failure. Check location 7BC, 7C, 7D, 7E.
5 LO:	INTERRUPT failure. Check 6532 at location 6C.
6 LO:	SPEECH failure. Check 6520 at 3C or 6532 at 6C.

B. MANUAL DIAGNOSTIC TESTS

You may perform individual manual diagnostic tests in addition to the automatic ones occurring at power-up. To do so, open the coin mech door and press the red Manual Mode button on the metal panel, next to the coin counter and master volume knob, when VICTORY is in the Attract Mode. This takes you into the Operator Interface Mode. For more information, refer to Operator Interface Mode section, page 5, of the Victory Operation and Service Manual and Systems Diagnostics Menu, page 8.

Select "Perform Diagnostics" off the Master Menu and you are presented with a list of tests. The following menu selections are identical to the tests previously described in the Automatic Diagnostic Tests, Section A:

- Program ROM CRC Test
- Program Volatile RAM Test
- Program Non-Volatile RAM Test
- Processor Interrupts Test
- Video Foreground RAM Test
- Video Background RAM Test
- Audio Subsystem Test

Please see those tests in the Automatic Diagnostic Tests Section for appropriate explanation.

The following tests on the System Diagnostics Menu are not performed automatically on power up. They can only be done manually. We will now describe how each is used.

1. Video Lookup Table

When this test is selected, 64 bars of color appear on the screen, each one a different hue. Some of the colors are close in hue, and may be difficult to discern differences visually. However, if the screen appears all one color, or as shades of one color, there is a failure in the Video Lookup Table of the graphics system. The only error code possible is:

255 HSC Stuck busy (not ready)

The screen freezes until you press any button to return to the menu.

2. Front Panel, Coin Mechs

When selected, the screen looks like:

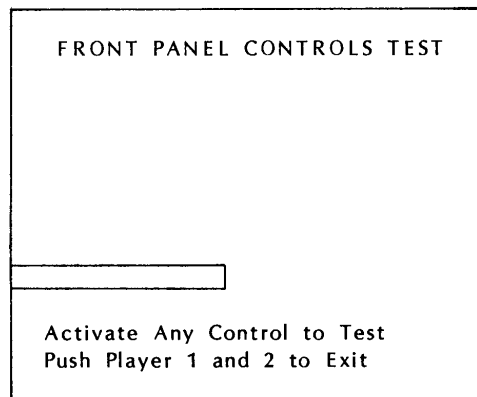

When any control panel button is pushed, it lights up on the panel its name appears in the blank area of the screen. To test coin mechs, insert a coin or token in each one, and Coin Mech 1 (left mech), Coin Mech 2 (right mech) message appears on the screen for each. The Manual Mode button may also be tested. The long green horizontal line at the bottom expands and shrinks lengthwise when the knob is turned. To return to the menu, press Player 1 and Player 2 **at the same time**.

3. Monitor Cross Hatch

This test shows a grid of evenly spaced vertical white lines intersecting evenly spaced white horizontal lines with white dots in each center, as follows:

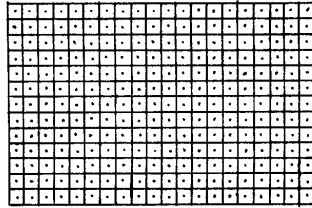

This shows any possible image distortion. To return to menu, press any button.

Only error code possible:

255: HSC Stuck busy (not ready)

4. Monitor Color Bars

This tests gives a screen display of eight color bars overlaying a grid. From left to right, these colors appear: black (blends with background), green, blue, cyan (blue-green), red, yellow, magenta (reddish purple), white. To return to menu, press any button.

Error Code:

255: HSC Stuck Busy (not ready)

COIN JAM ERROR

If any coin mech is activated for more than two seconds at any time, the game automatically freezes, and this message appears on the screen:

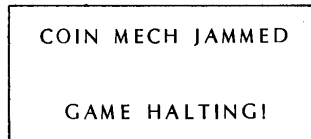

The only way to resume normal operation is to power up the game again. This is designed to help detect coin mech stringing, a jammed switch, or malfunctioning hardware. (Note: Special care should be taken by technicians, activating the coin mechanism to bypass Automatic Diagnostic Testing. Be sure to release immediately after power up).

LIT CONTROL PANEL BUTTONS

During the Attract Mode, the Shield, Doomsday, Fire and Thrust buttons turn on and off in a circular pattern. During game play, the buttons remain lit unless a particular supply runs out (for example, if the BATTLESTAR runs out of fuel, the thrust button light goes out). Shield, doomsday, and thrust are the only three buttons affected.

The control panel lights can be tested during the Operator Interface Mode, when "Front panel, Coin Mechs" is selected off the Systems diagnostics menu. In this test, panel buttons light up when pressed.

APPENDIX A: ERROR CODES AND ERROR MESSAGES

1. Logic System Diagnostic Tests

1. PROGRAM ROM CRC TEST gives board location of the 4K 2732 that failed.
2. PROGRAM VOLATILE RAM TEST gives board location of the 2114 chip most likely in error.
3. PROGRAM NON-VOLATILE RAM TEST gives the board location of the 2K CMOS RAM chip most likely in error.
4. PROCESSOR INTERRUPTS TEST (Red Screen) instantaneous
 - 01: Frame interrupt missing
 - 02: Foreground collision interrupt received unexpectedly
 - 03: ' ' ' expected, not received
 - 04: ' ' ' bad (X,Y) collision coordinate
 - 05: Background collision interrupt received unexpectedly
 - 06: ' ' ' expected, not received
 - 07: ' ' ' bad (X,Y) collision coordinate
 - 08: Unknown interrupt
 - FD: Microcode failure
 - FE: Microcode failure
 - FF: HSC Stuck busy (not ready)
5. VIDEO FOREGROUND RAM TEST board location of 16Kx1 RAM chip, if possible
 - or:
 - FC: Red plane error, chip unknown
 - FD: Blue plane error, chip unknown
 - FE: Green plane error, chip unknown
 - FF: HSC Stuck busy
6. VIDEO BACKGROUND RAM TEST gives board location of the 2114 RAM chip.
7. CMOS RAM RESET (Battery Data Validity Check) Error Code: 01- Battery backup RAM reset to factory settings.
8. AUDIO SUBSYSTEM TEST
 - 01: ZERO PAGE RAM FAILURE. 6532 at 6C or 6810 at 3D.
 - 03: EPROM failure, check 2K 2716 at 7BC
 - 13: EPROM failure, check 2K 2716 at 7C
 - 23: EPROM failure, check 2K 2716 at 7D
 - 33: EPROM failure, check 2K 2716 at 7E
 - 04: INTERRUPT FAILURE, check 6532 at 6C.
 - 05: SPEECH FAILURE, check 5220 3C or 6532 at 6C.
 - FD: Audio command function won't terminate
 - FE: RECEIVE input link error, check PIA 6520 at 6E
 - FF: SEND output link error, check PIA 6520 at 6E

2. Audio System Diagnostic Tests

The code is as follows:

Number of beeps	Significance
0:	Serious audio system failure, OR master or individual volumes are turned down.
1 HI	All audio hardware is OK, except the music section or its volume is malfunctioning.
1 LO	OK except something between the speech chip and the speaker is malfunctioning, or check speech volume.
1 LO & 1 HI:	All is OK. This is the normal sequence.
2:	ZERO PAGE RAM FAILURE. Check 6532 location 6C or 6810 at 3D.
3:	(will not occur)
4:	ROM failure. Check location 7BC, 7C, 7D, 7E.
5:	INTERRUPT failure. Check 6532 at location 6C.
6:	SPEECH failure. Check 6520 at 3C or 6532 at 6C.

VIDEO LOOKUP TABLE, MONITOR CROSS HATCH, MONITOR COLOR BARS TESTS:
255 HSC Stuck busy (not ready)

COIN JAM ERROR

Message: COIN MECH JAMMED GAME HALTING! on screen and game freezes.
Power game up again.