

PAC-MAN/MS. PAC-MAN TO PAC-MAN

PLUS CONVERSION

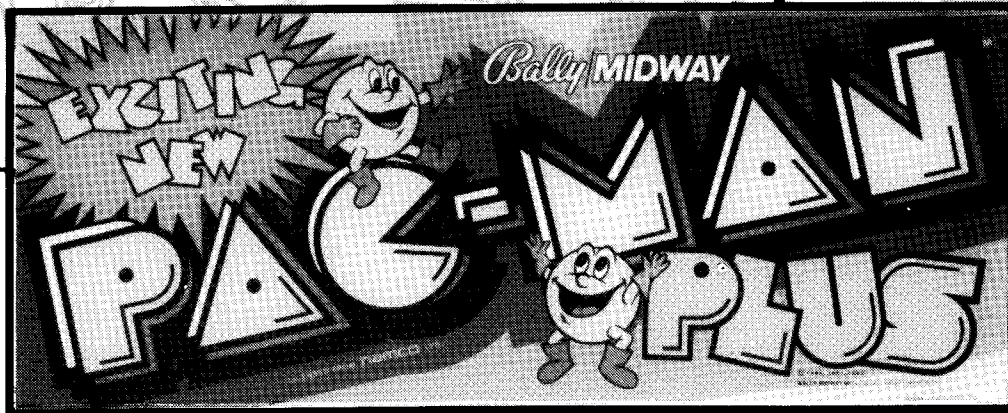

KIT

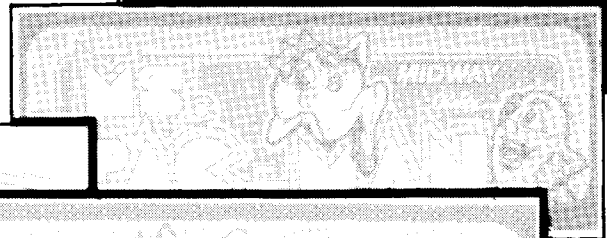

**FOR
UPRIGHT — COCKTAIL TABLE — MINI
MODELS**

PART NO. M051-00338-A004

Conversion Kit Components

Enclosed is a PAC-MAN PLUS Conversion Kit for your PAC-MAN/MS. PAC-MAN game. It includes the following items by model:

ALL MODELS:

- 1 AUXILIARY GAME LOGIC BOARD WITH RIBBON CABLE (POTTED)
- 1 AUXILIARY GAME LOGIC BOARD SUPPORT BRACKET (FOR PAC-MAN CONVERSIONS ONLY)
- 2 AUXILIARY GAME LOGIC BOARD SUPPORT BRACKET MOUNTING SCREWS (FOR PAC-MAN CONVERSIONS ONLY)
- 4 PLASTIC MOUNTING STAND-OFFS FOR THE AUXILIARY GAME LOGIC BOARD (FOR PAC-MAN CONVERSIONS ONLY)
- 1 INTEGRATED CIRCUIT FOR POSITION "5 E" ON MAIN GAME LOGIC BOARD
- 1 INTEGRATED CIRCUIT FOR POSITION "5 F" ON MAIN GAME LOGIC BOARD
- 1 INTEGRATED CIRCUIT FOR POSITION "4 A" ON MAIN GAME LOGIC BOARD
- 1 INTEGRATED CIRCUIT FOR POSITION "6 E" ON MAIN GAME LOGIC BOARD
- 1 INTEGRATED CIRCUIT FOR POSITION "6 F" ON MAIN GAME LOGIC BOARD
- 1 INTEGRATED CIRCUIT FOR POSITION "6 H" ON MAIN GAME LOGIC BOARD
- 1 INTEGRATED CIRCUIT FOR POSITION "6 J" ON MAIN GAME LOGIC BOARD
- 1 INTEGRATED CIRCUIT FOR POSITION "7 F" ON MAIN GAME LOGIC BOARD
- 1 MS. PAC-MAN PARTS AND OPERATING MANUAL

UPRIGHT MODEL:

- 1 ATTRACTION PANEL
- 1 SERIAL NUMBER TAG
- 1 MAIN-DISPLAY-GLASS LABEL

MINI MODEL:

- 1 ATTRACTION PANEL
- 1 SERIAL NUMBER TAG
- 1 MAIN-DISPLAY-GLASS LABEL

COCKTAIL TABLE MODEL:

- 1 TABLE TOP GLASS UNDERLAY
- 2 TABLE TOP GLASS LABELS (FOR PAC-MAN CONVERSIONS ONLY)
- 1 SERIAL NUMBER TAG

PAC-MAN to PAC-MAN PLUS Conversion Procedure

To convert your PAC-MAN game to a PAC-MAN PLUS game is a fairly simple operation. Just follow the Steps below and the illustrations given in each Figure.

- 1** Turn the power off to your game and disconnect it from its wall outlet.

CAUTION:
The right hand latch is very close to the HIGH VOLTAGE on the monitor.

- 2** Opening the Cabinet:

- UPRIGHT and MINI models:
Unlock and open the rear access door.
- COCKTAIL TABLE model:
Open the coin box door and release the two latches indicated in Figure 1.

- Once the latches are released, unhook them from their latch plates.
- Grasp the table top at "A" and open it as indicated in Figure 1.

CAUTION: Due to the weight of the monitor, EXTREME CARE MUST be taken when opening the cabinet.

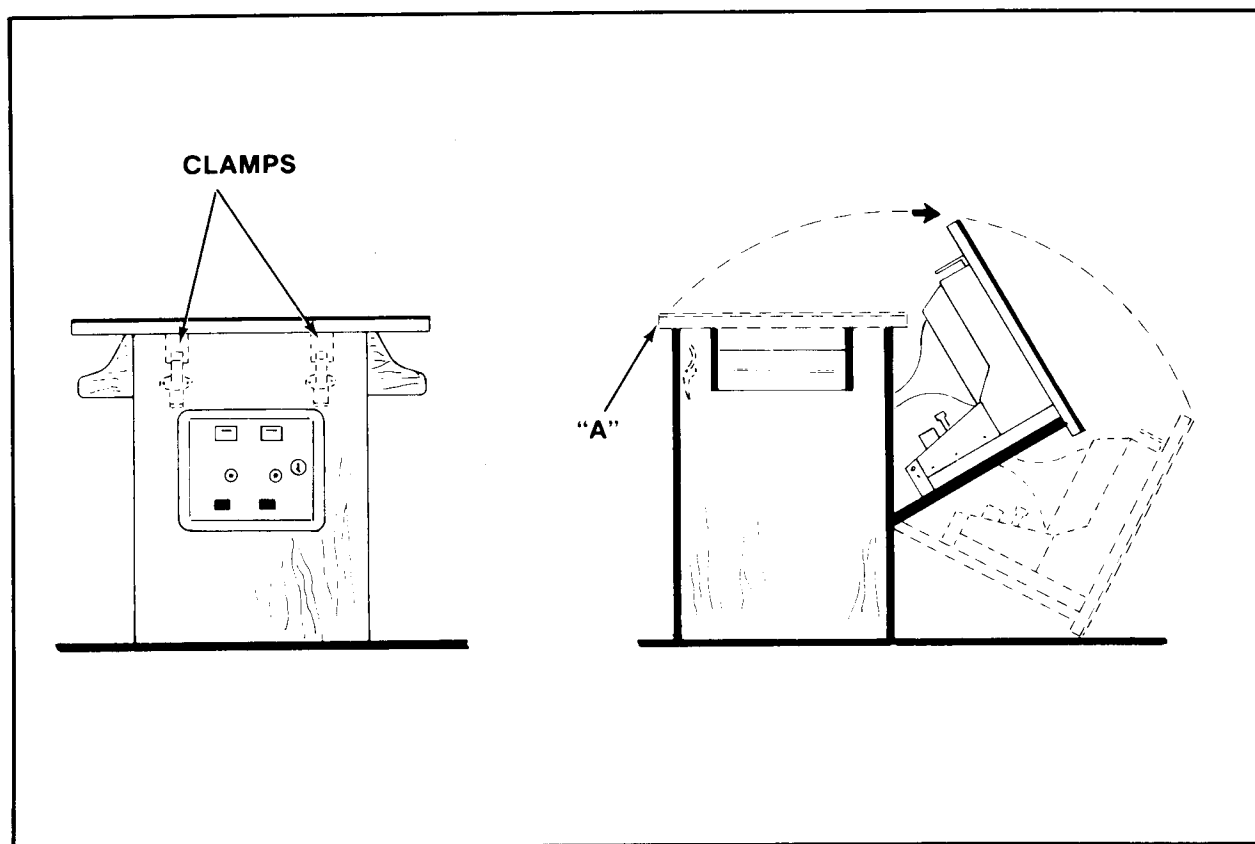

Figure 1

3

Main Game Logic Board removal:

□ Disconnect the Main Game Logic Board from all its cabling. See Figure 2.

□ Remove the P.C.B. clamps indicated in Figure 3 and slide the Main Game Logic Board out of the cabinet.

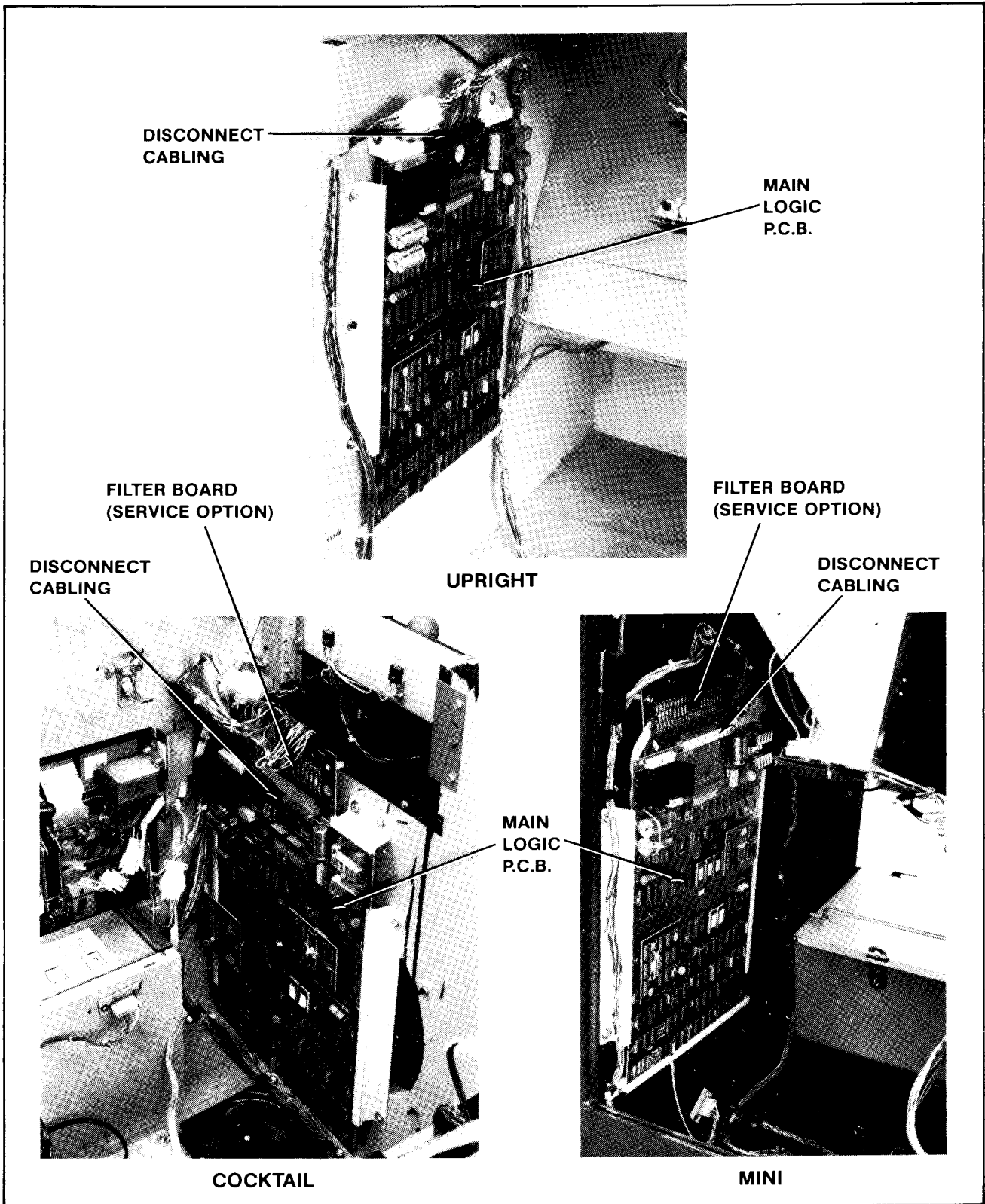

Figure 2

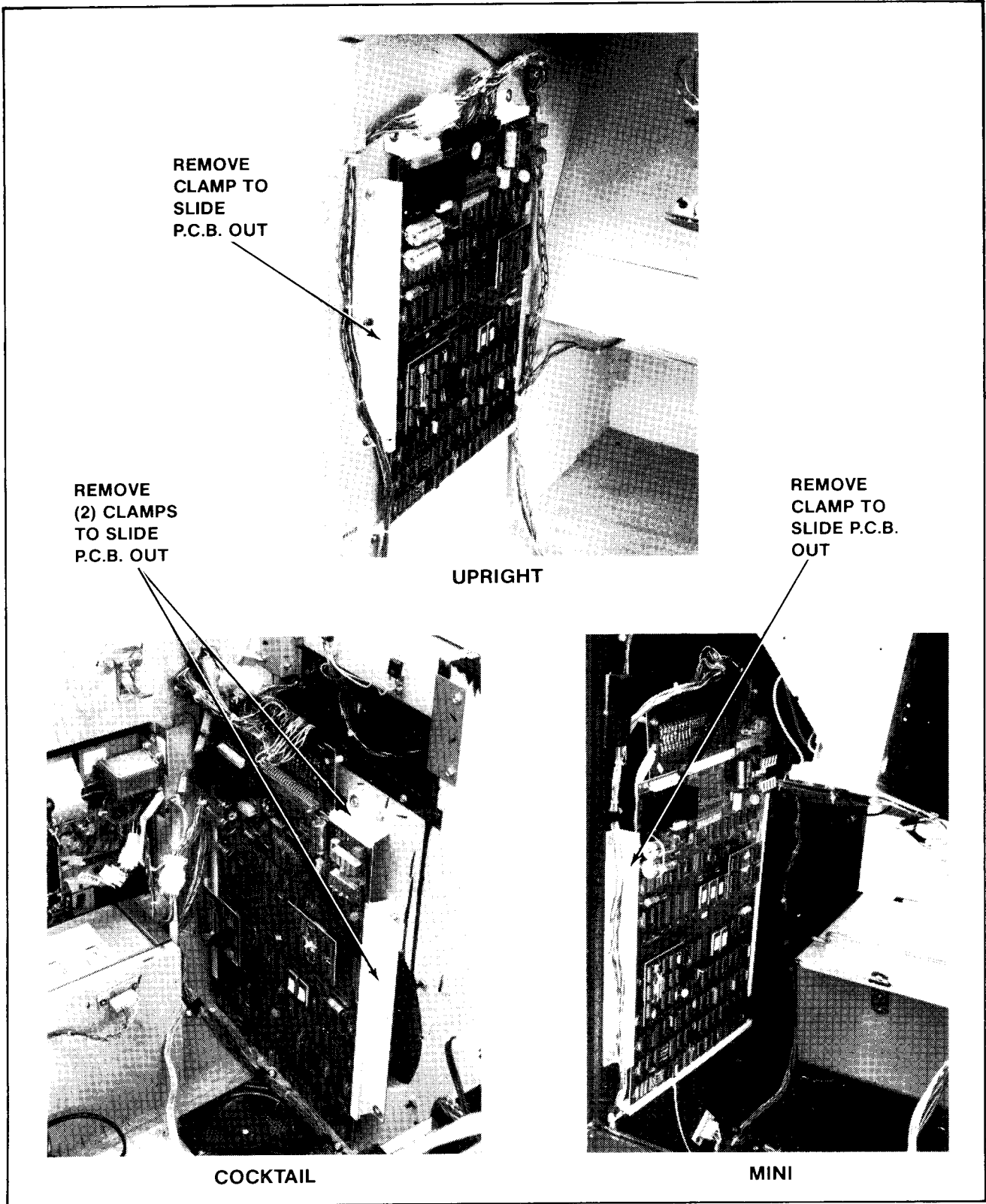

Figure 3

- 4** Install the Auxiliary Game Logic Board Support Bracket as indicated in Figure 4.
- Install the four plastic mounting stand-offs to the Auxiliary Game Logic Board Support Bracket.

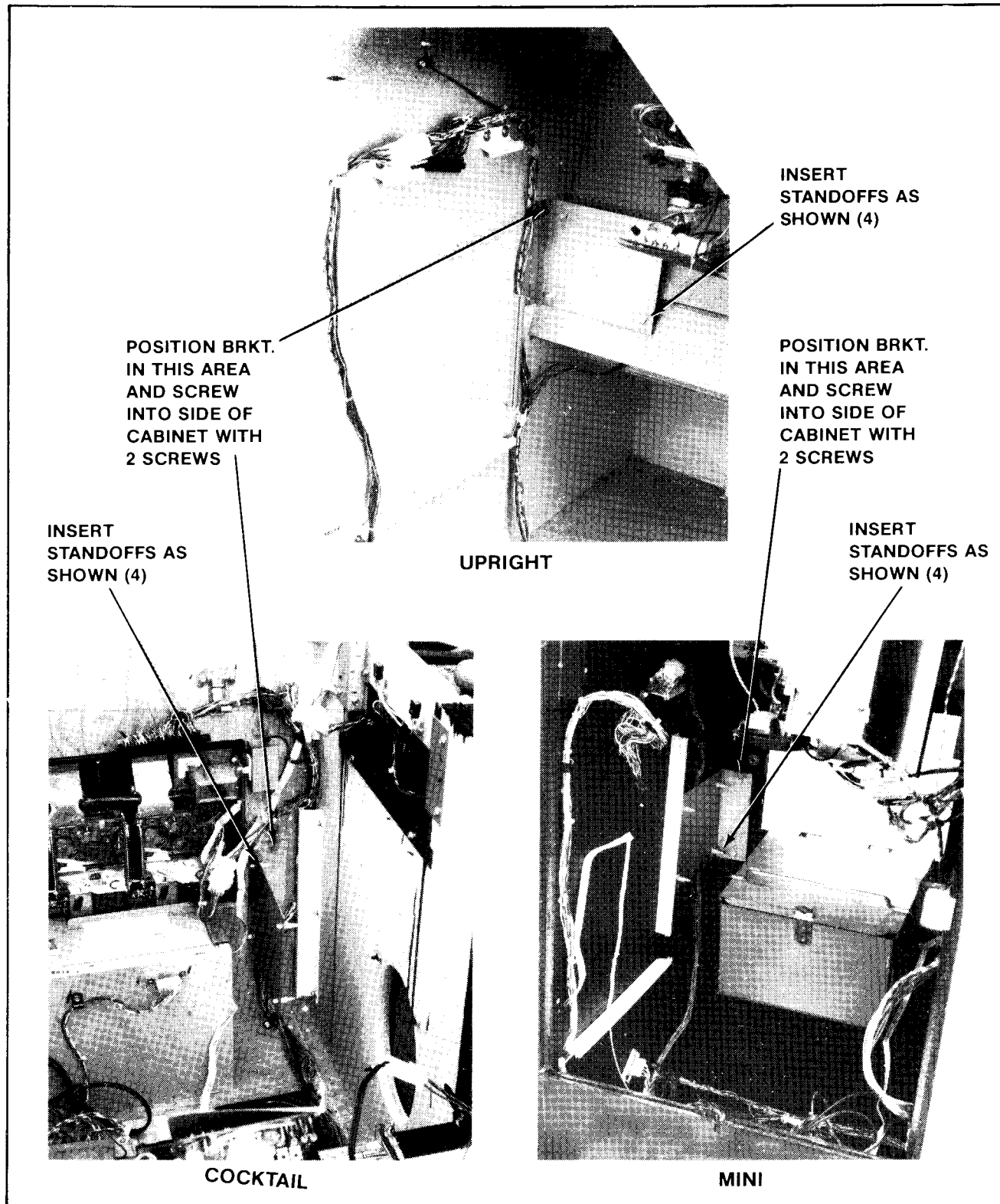

Figure 4

5 Cut the plastic securing strap and remove the "PIGGY-BACK" module indicated in Figure 5 **IF YOUR GAME IS EQUIPPED WITH ONE**. If it **IS NOT** equipped with one, simply proceed to Step 6 below.

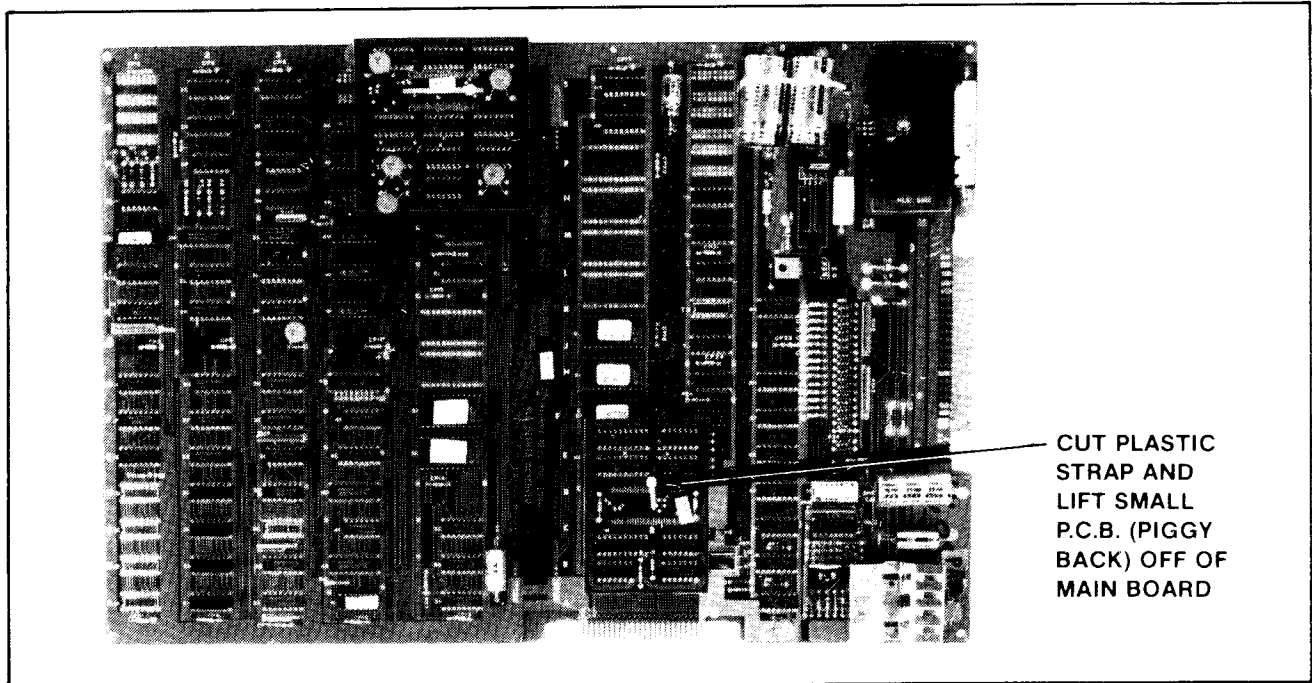

Figure 5

6 Remove the Z-80 CPU from the Main Game Logic Board as shown in Figure 6. **BE CAREFUL NOT TO BEND ITS PINS!!** Return this CPU to your stock. It may be used as a spare part.

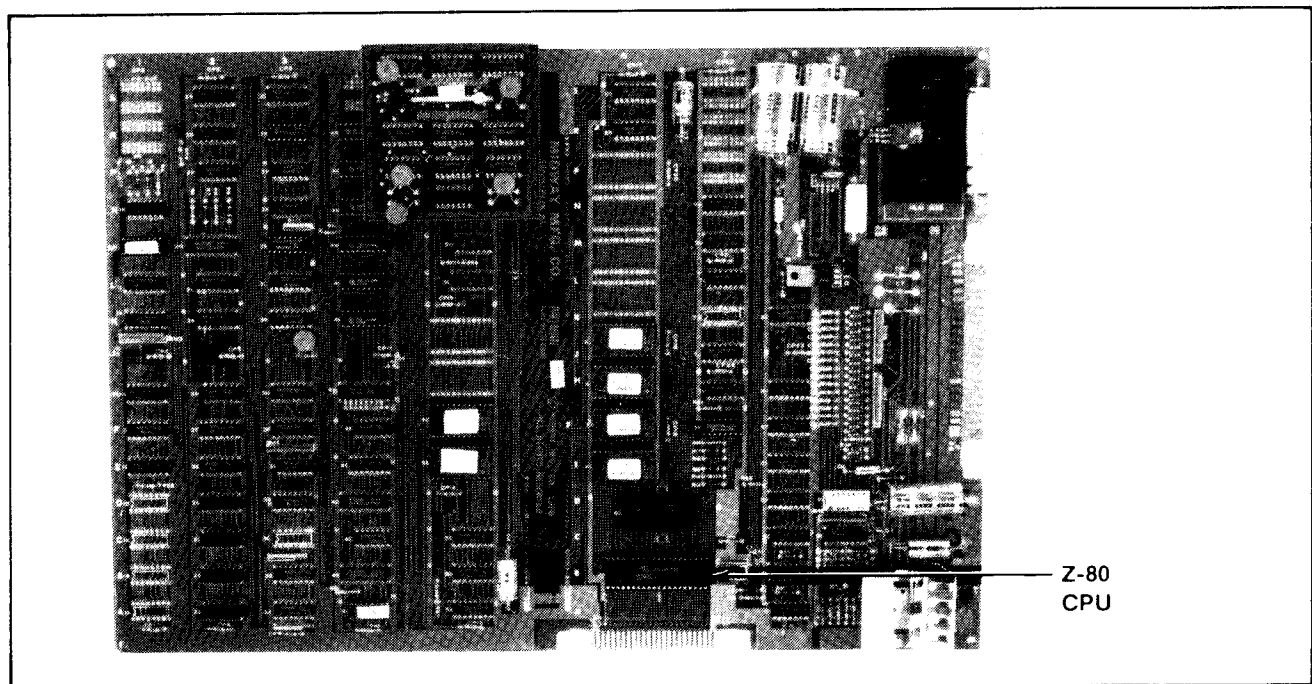

Figure 6

7 Remove the six EPROMS and 2 PROMS located as shown in Figure 8 and set them aside. **BE CAREFUL NOT TO BEND THEIR PINS!!** Replace the removed EPROMS and PROMS with the ones supplied in your conversion kit. They are installed as shown in the above Figure.

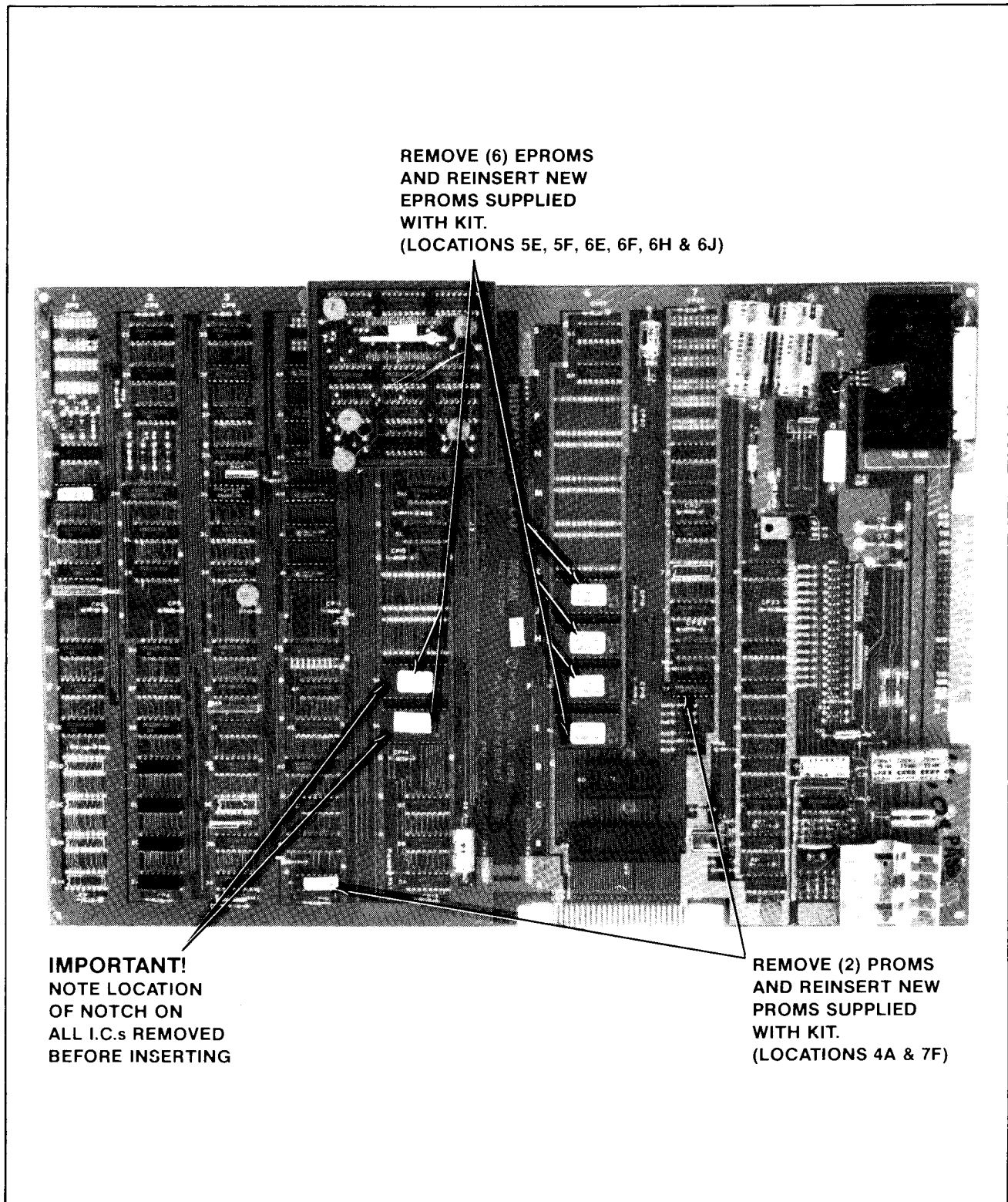

Figure 7

8 Plug the ribbon extension cable for the Auxiliary Game Logic Board into the empty socket on the Main Game Logic Board that was left when you removed the Z-80 CPU from it in Step 6. See Figure 8.

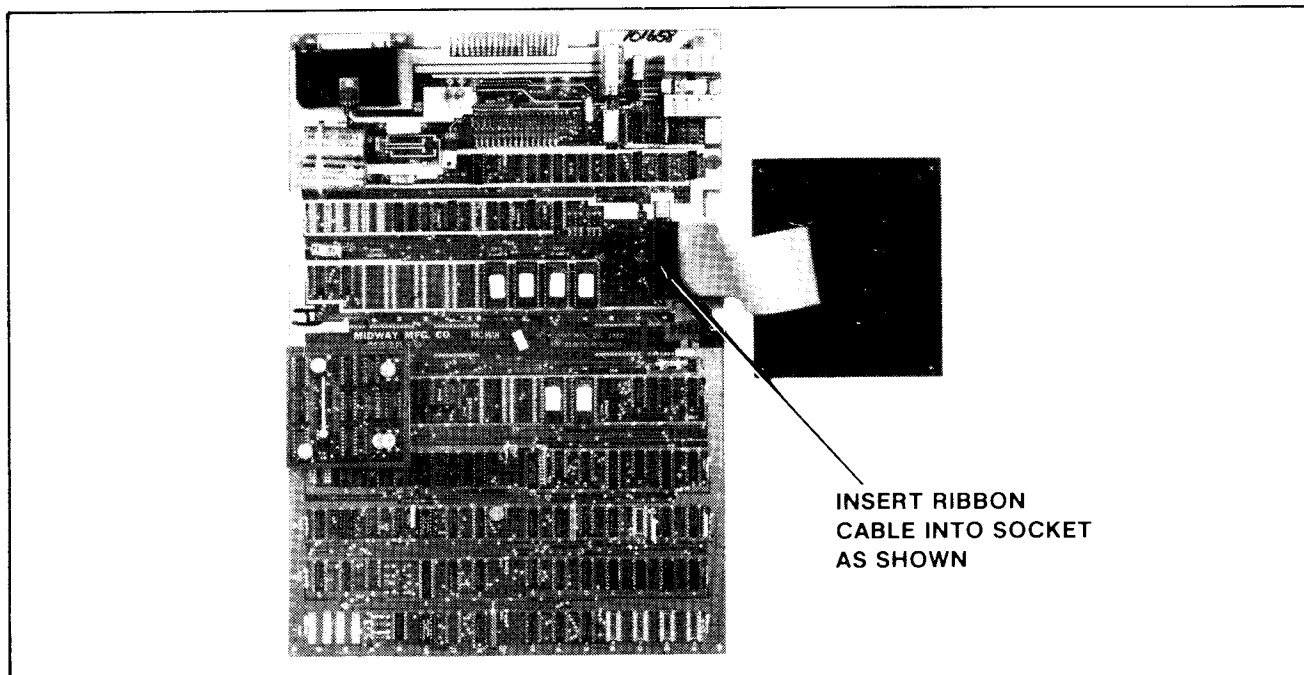

Figure 8

9 If your game was equipped with a "PIGGY-BACK" module that you removed in Step 5, reinstall it at this time. See Figure 9. If it was not equipped with one, simply proceed to Step 10.

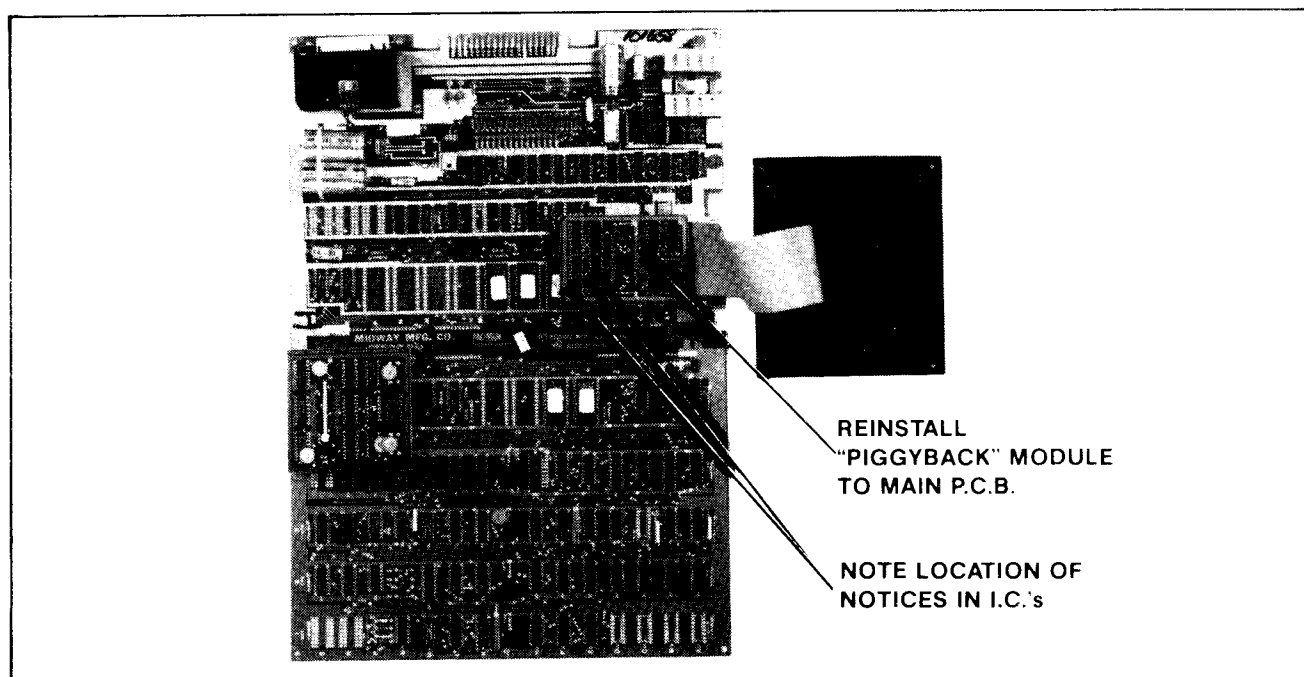

Figure 9

10 Reinstall the Main Game Logic Board and the Auxiliary Game Logic Board (now attached to it by the ribbon cable) back into the game cabinet.

11 Install the Auxiliary Game Logic Board to the four plastic snap-in mounting stand-offs of the Auxiliary Game Logic Board Support Bracket as shown in Figure 10.

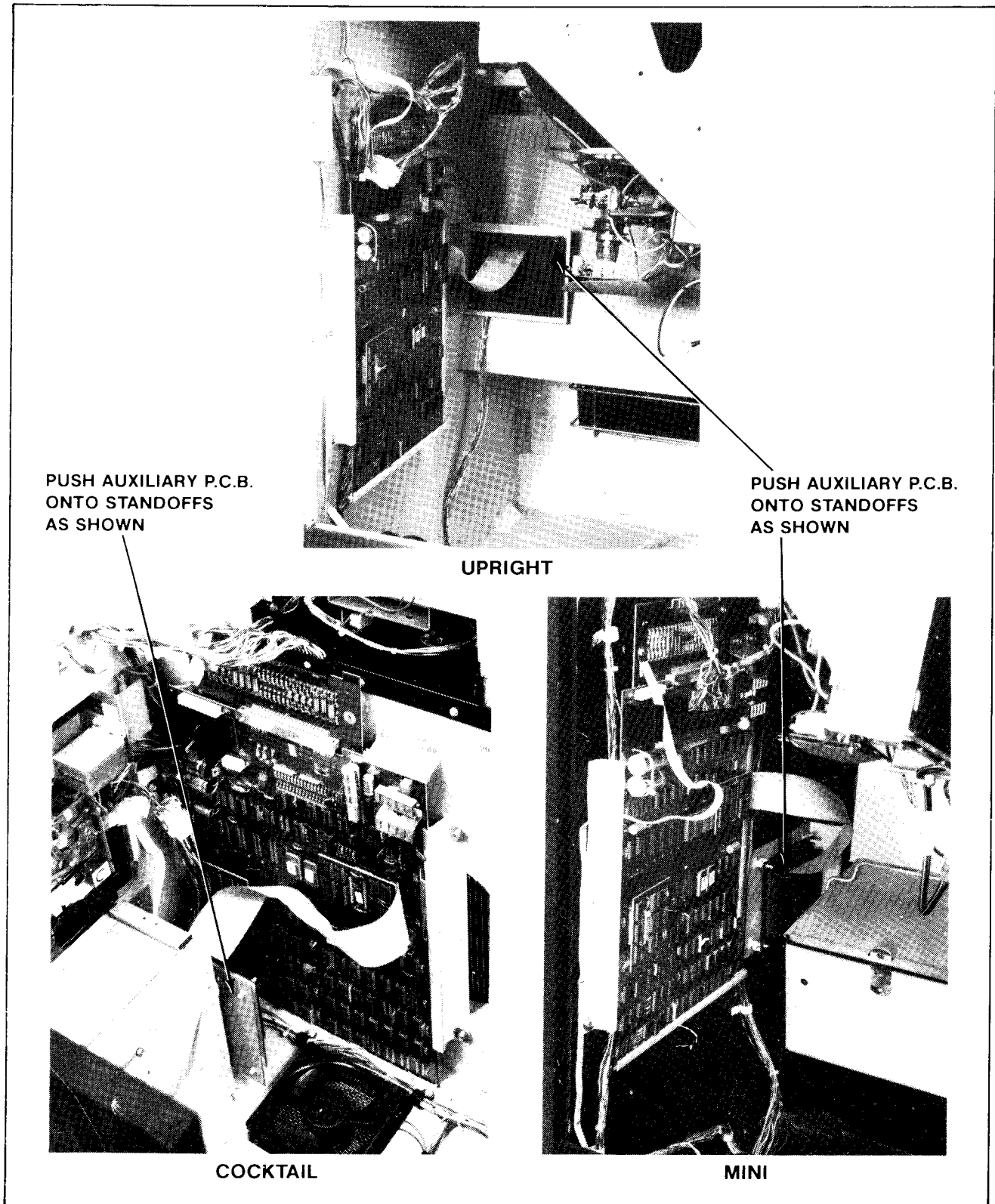

Figure 10

- 12** Reconnect all previously removed cabling to the Main Game Logic Board.
- 13** Close and lock the game cabinet and plug it back into its wall outlet.
- 14** Turn the game on and let it warm up for a few minutes, run a Self-Test on it, and play a couple of games to be sure everything is working properly.

NOTE: DO NOT FORGET to **SAVE** the six EPROMS and two PROMS you removed in Step 7 of this procedure. Put them in the packaging that the new EPROMS and PROMS came in and store them in a dark place at room temperature. They will not be harmed if stored this way. Thus, by reversing this procedure, you could convert your game back to a PAC-MAN model if you ever wanted to.

Installation of Remainder of Conversion Kit Parts

1. ATTRACTION PANELS

(UPRIGHT AND MINI MODELS):

- Turn the power off to the game.
- Remove the screws installed in the top attraction panel bracket.
- Lift off the bracket.
- Slide the attraction panel up and out.
- Install the new PAC-MAN PLUS attraction panel and secure it with the top attraction panel bracket.

2. TABLE TOP GLASS AND UNDERLAY (COCKTAIL TABLE MODEL):

- Turn the power off to the game.
- Remove the Screws securing the table top glass clamps in place.
- Remove the above clamps and the table top glass.
- Affix the new PAC-MAN PLUS Serial Number Tag to the **UNDERSIDE** of the table top glass as shown in Figure 11.

- Reinstall the table top glass.
- Secure the above with the table top glass clamps and screws you removed earlier.
- Affix **BOTH** Table Top Glass Labels to the **TOP SIDE** of the table top glass as shown in Figure 11.

3. MAIN-DISPLAY-GLASS (UPRIGHT AND MINI MODELS):

- Turn the power off to the game.
- Remove the main-display-glass as described in the appropriate sections of your OPERATOR'S MANUAL.
- Affix the new PAC-MAN PLUS Serial Number Tag to the **UNDERSIDE** of the main-display-glass as shown in Figure 12.
- Reinstall the main-display-glass.
- Affix the Main-Display-Glass Label to the **TOP SIDE** of the main-display-glass as shown in Figure 12.

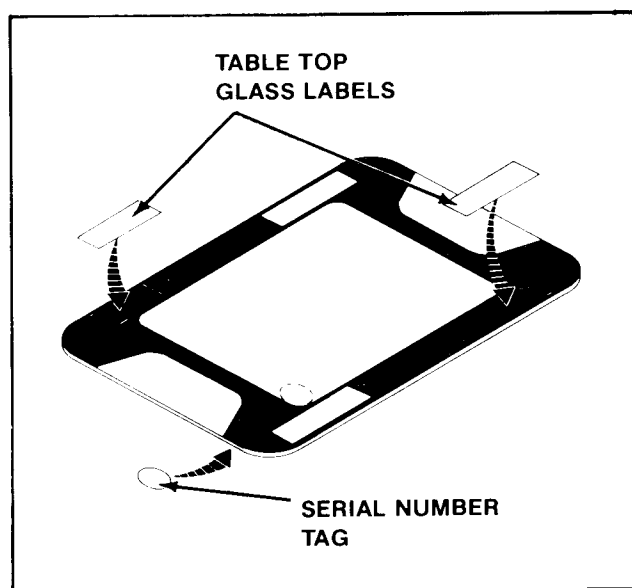

Figure 11

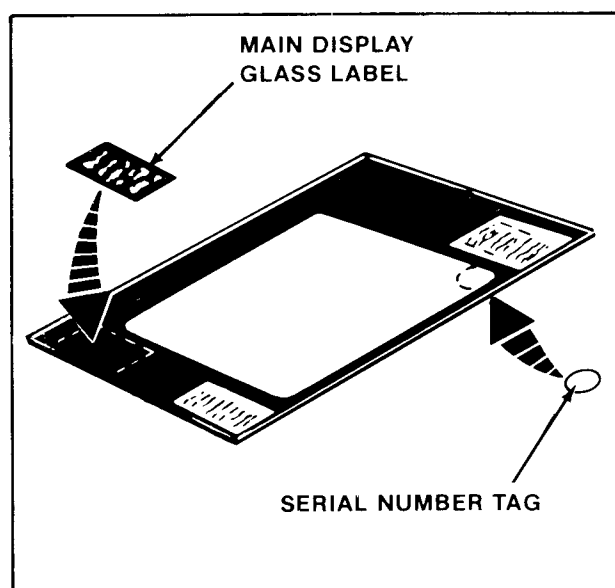

Figure 12

Notes:

MS. PAC-MAN to PAC-MAN PLUS Conversion Procedure

To convert your MS. PAC-MAN game to a PAC-MAN PLUS game is a fairly simple operation. Just follow the Steps below and the illustrations given in each Figure.

- 1** Turn the power off to your game and disconnect it from its wall outlet.

CAUTION:
The right hand latch is very close to the HIGH VOLTAGE on the monitor.

- 2** Opening the Cabinet:

- UPRIGHT and MINI models:
Unlock and open the rear access door.
- COCKTAIL TABLE model:
Open the coin box door and release the two latches indicated in Figure 1.

- Once the latches are released, unhook them from their latch plates.
- Grasp the table top at "A" and open it as indicated in Figure 1.

CAUTION: Due to the weight of the monitor, EXTREME CARE MUST be taken when opening the cabinet.

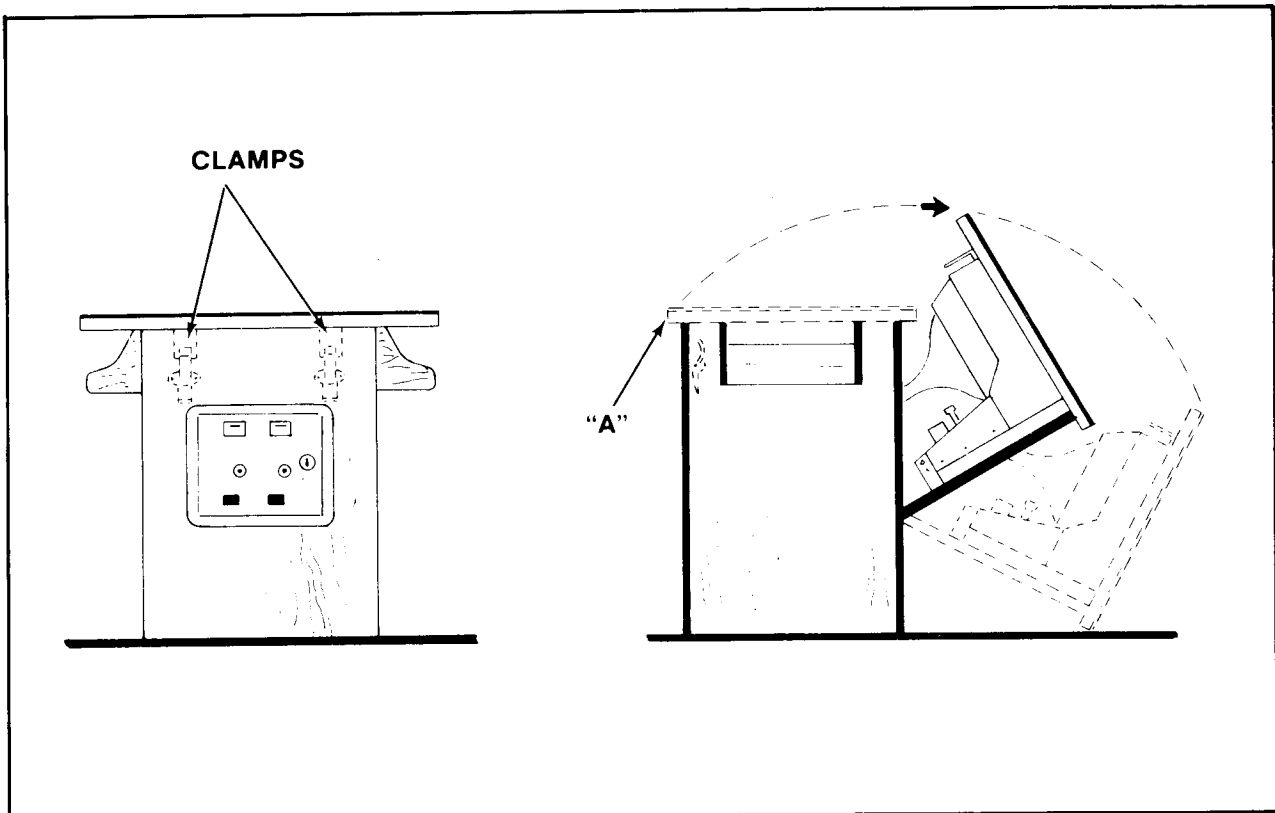

Figure 1

3 Main Game Logic Board removal:

- Disconnect the Main Game Logic Board from all its cabling. See Figure 2.
- Cut the plastic securing strap and remove the "PIGGY-BACK" module indicated in Figure 2 **IF YOUR GAME IS EQUIPPED WITH ONE** and set it aside.
- Remove the ribbon extension cable from the Main Game Logic Board.
- Remove the P.C.B. clamps indicated in Figure 3 and slide the Main Game Logic Board out of the cabinet.

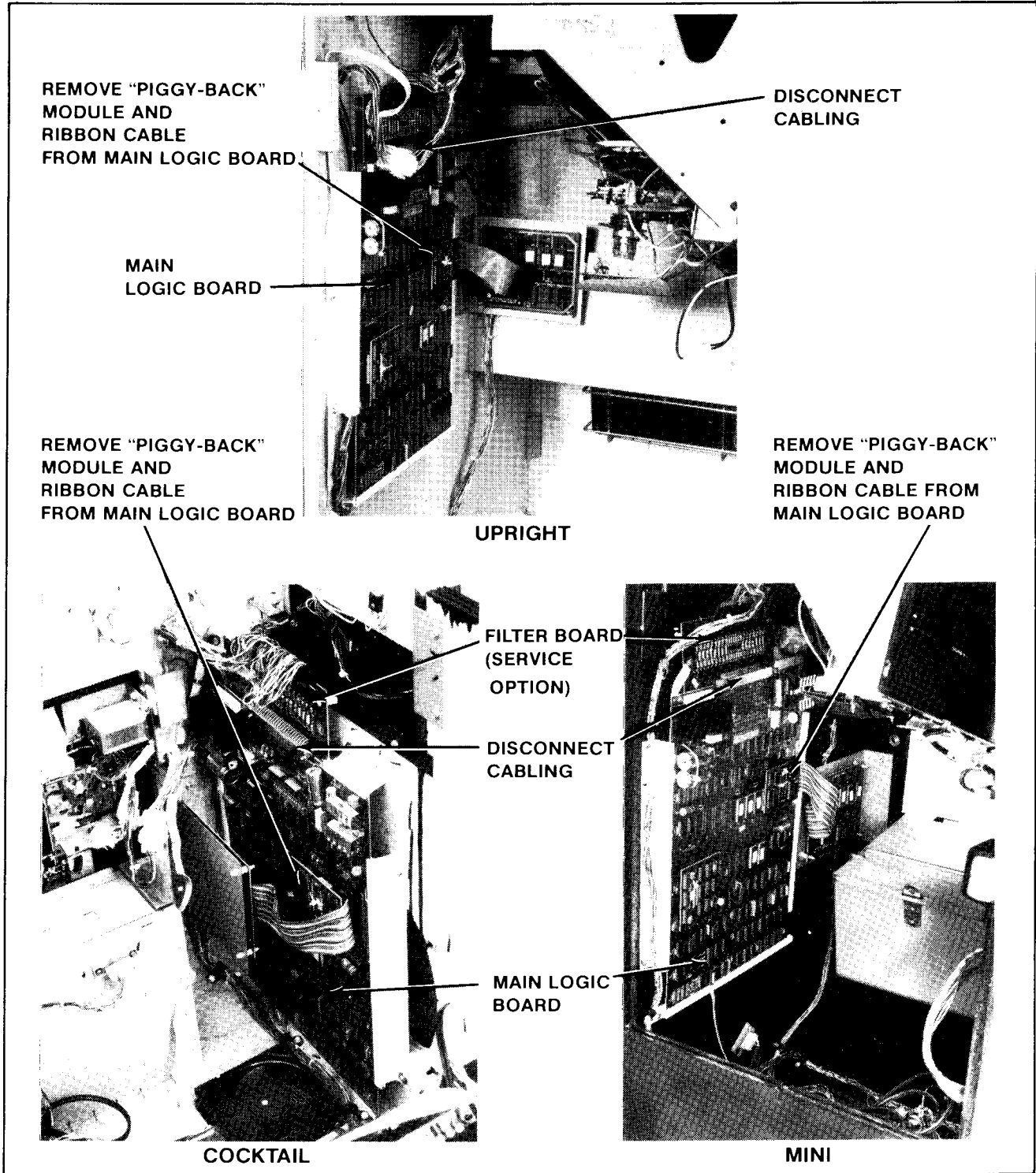

Figure 2

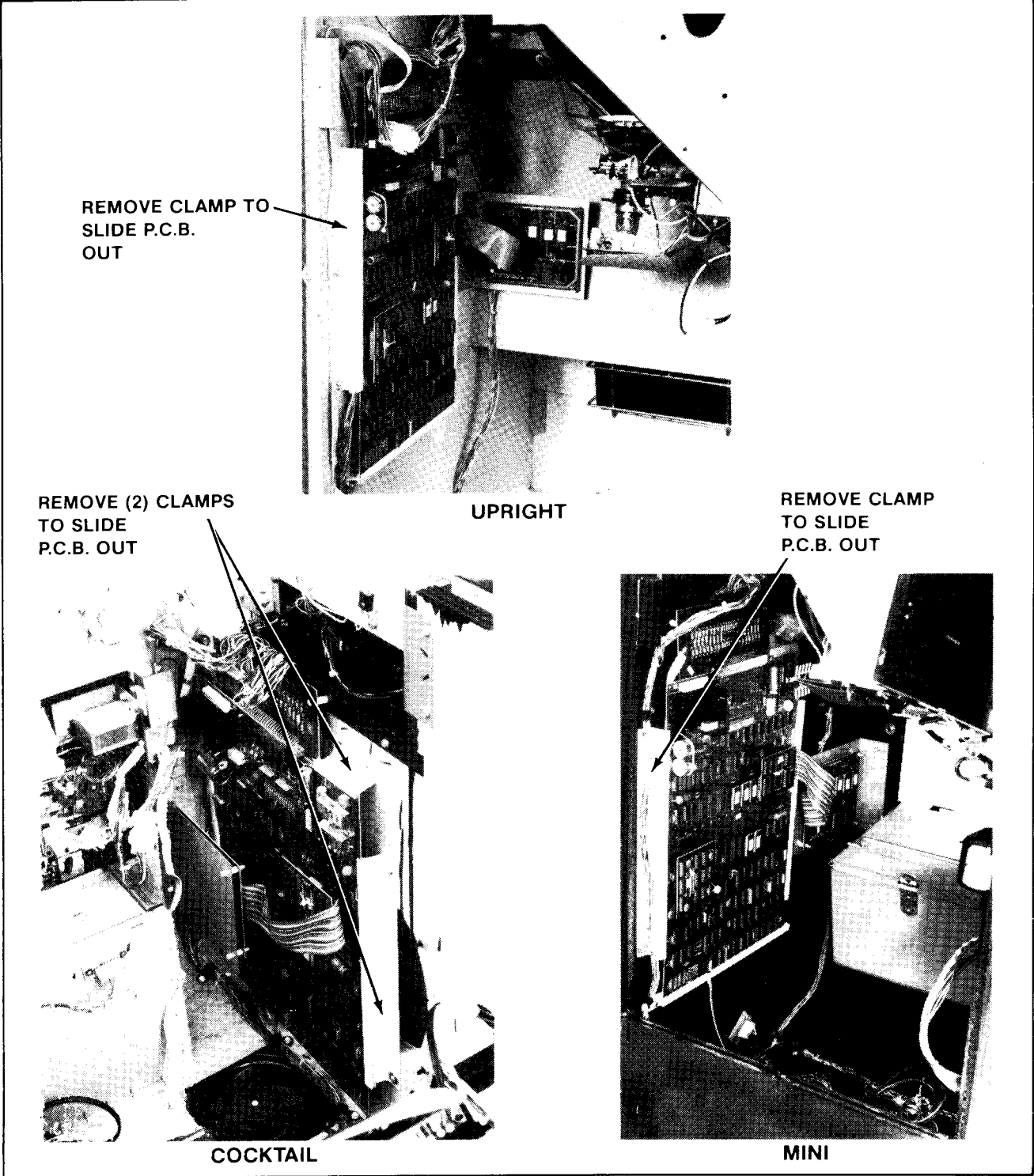

Figure 3

4 Remove the six EPROMS and 2 PROMS located as shown in Figure 4 and set them aside. **BE CAREFUL NOT TO BEND THEIR PINS!!** Replace the removed EPROMS and PROMS with the ones supplied in your conversion kit. They are installed as shown in the above Figure.

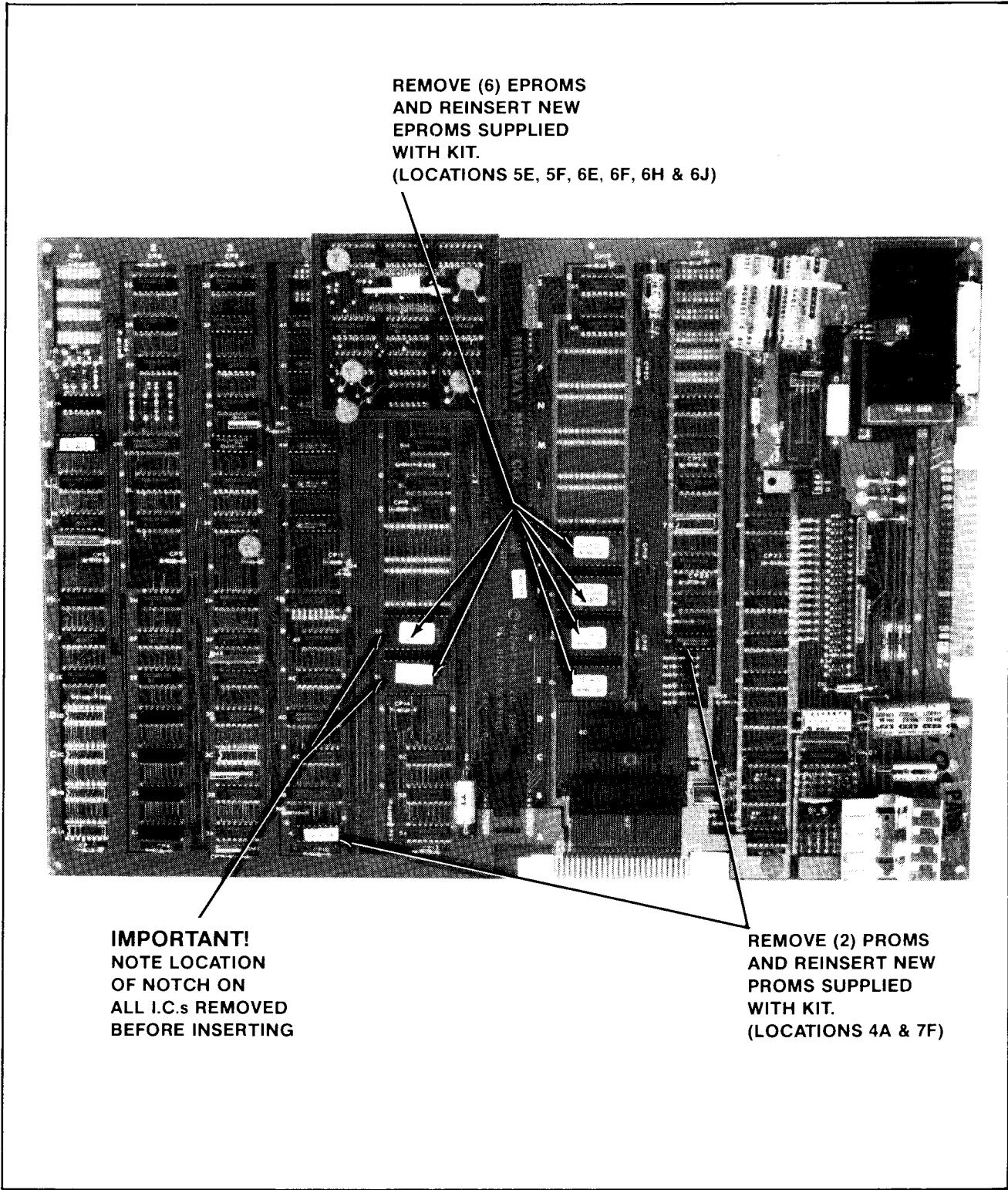

Figure 4

5 Plug the ribbon extension cable for the new Auxiliary Game Logic Board into the empty socket on the Main Game Logic Board that was left when you removed the original ribbon cable in Step 3. See Figure 5.

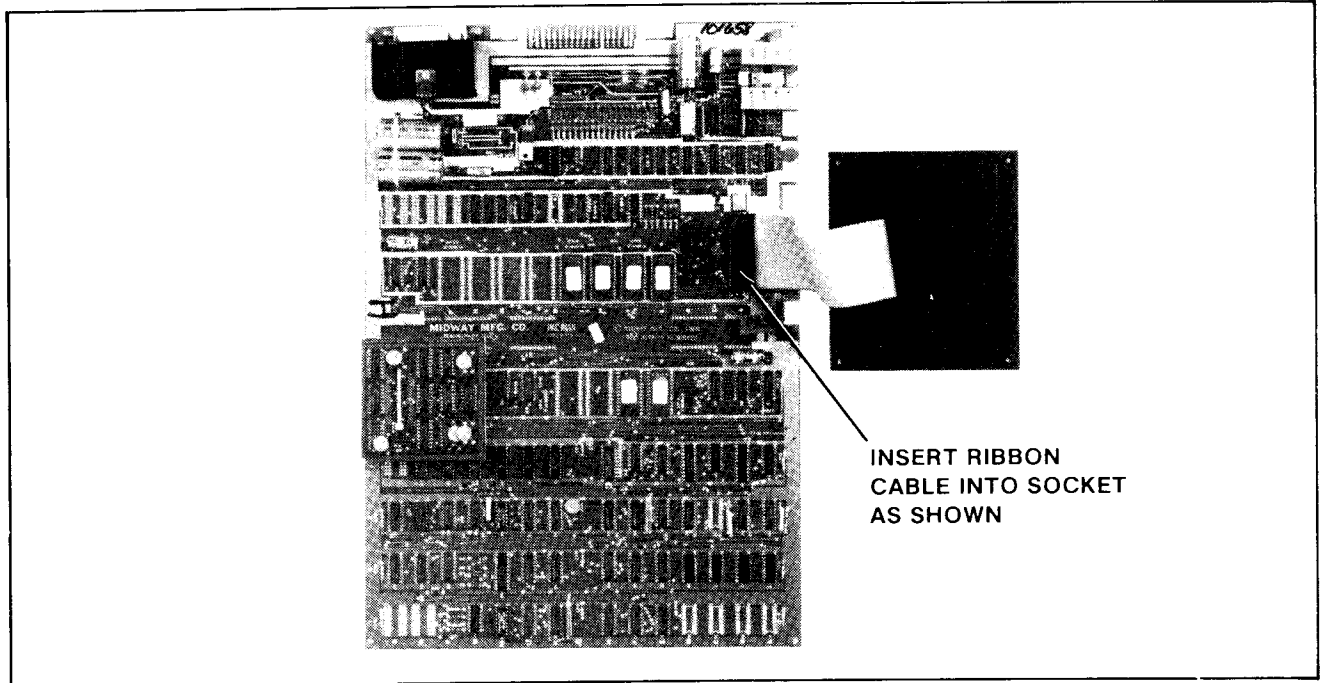

Figure 5

6 If your game was equipped with a "PIGGY-BACK" module that you removed in Step 3, reinstall it at this time. See Figure 6. If it was not equipped with one, simply proceed to Step 7.

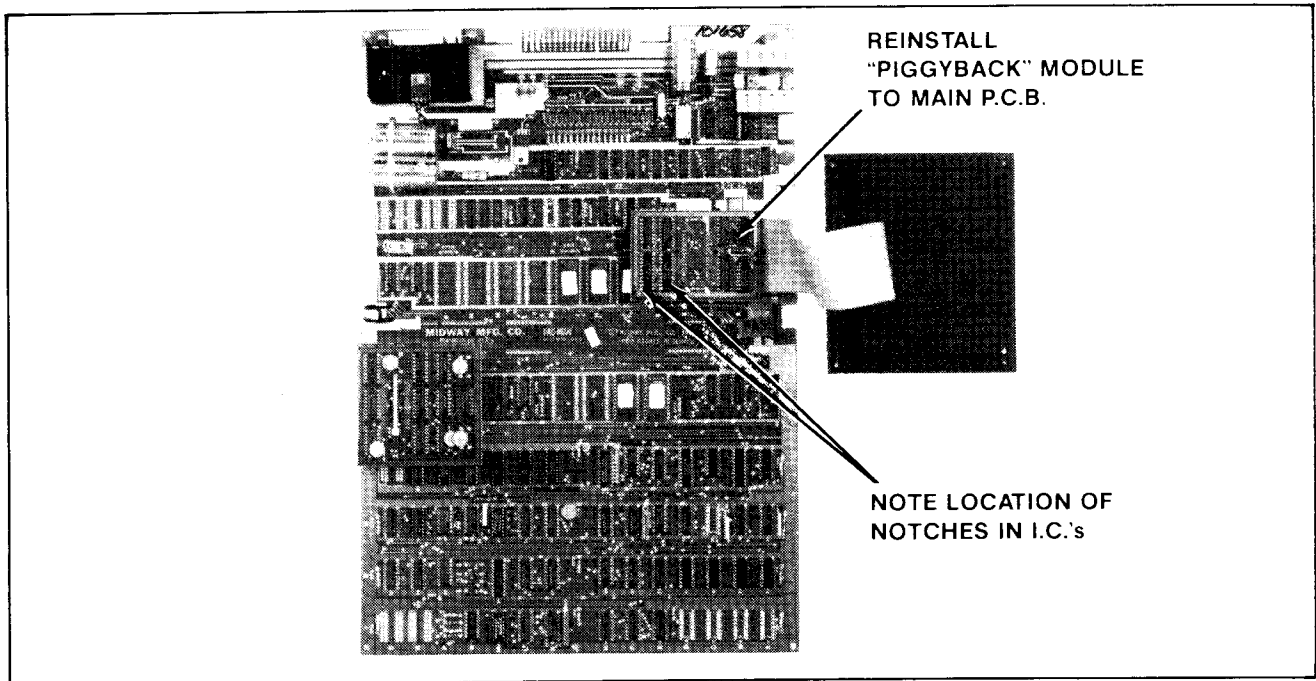

Figure 6

7 Remove the Auxiliary Game Logic Board from its support posts and return it to your stock for possible future use. See Figure 7.

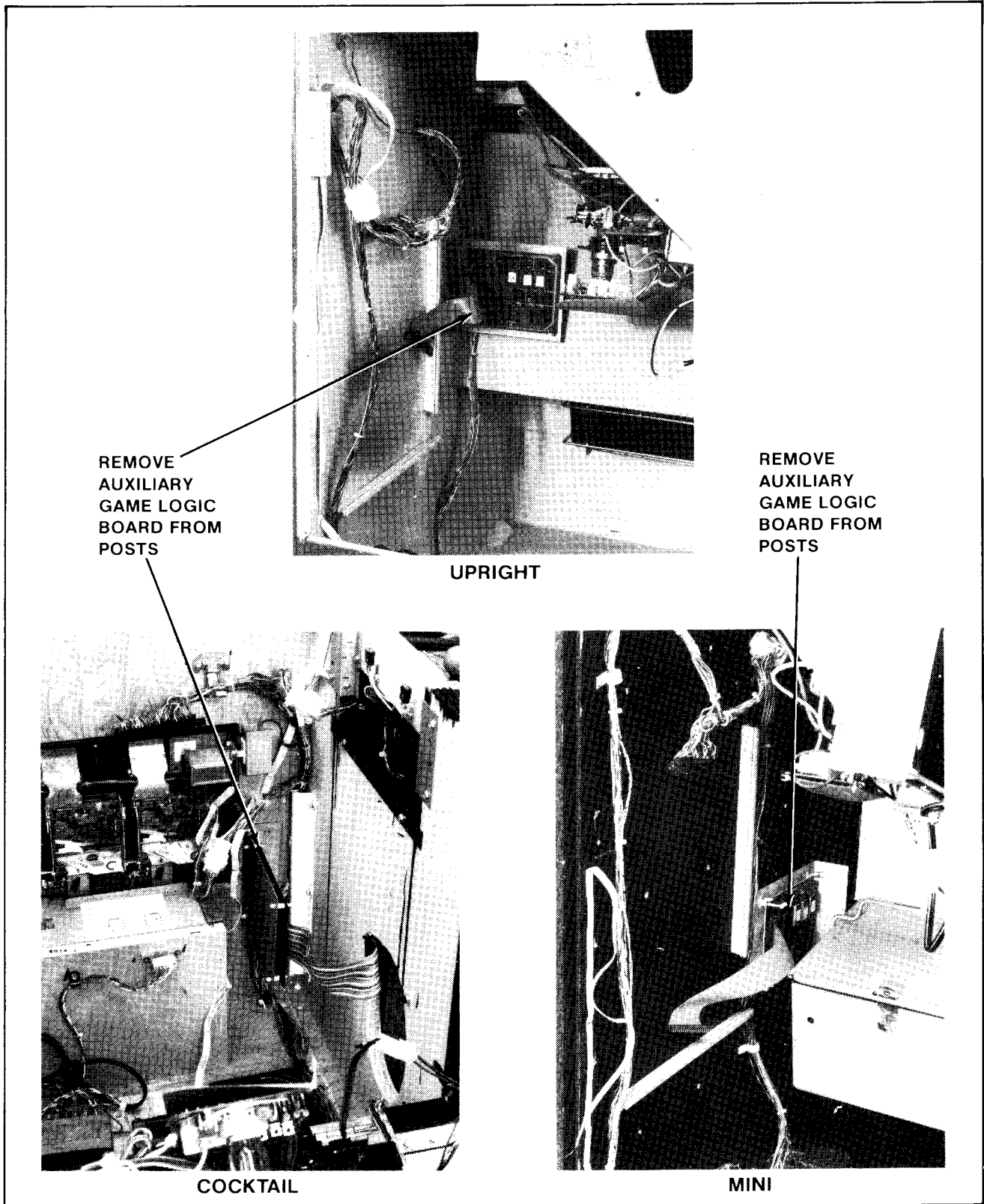

Figure 7

8 Reinstall the Main Game Logic Board and the new Auxiliary Game Logic Board (now attached to it by the ribbon cable) back into the game cabinet.

9 Install the new Auxiliary Game Logic Board to the four plastic snap-in mounting standoffs of the Auxiliary Game Logic Board Support Bracket as shown in Figure 8.

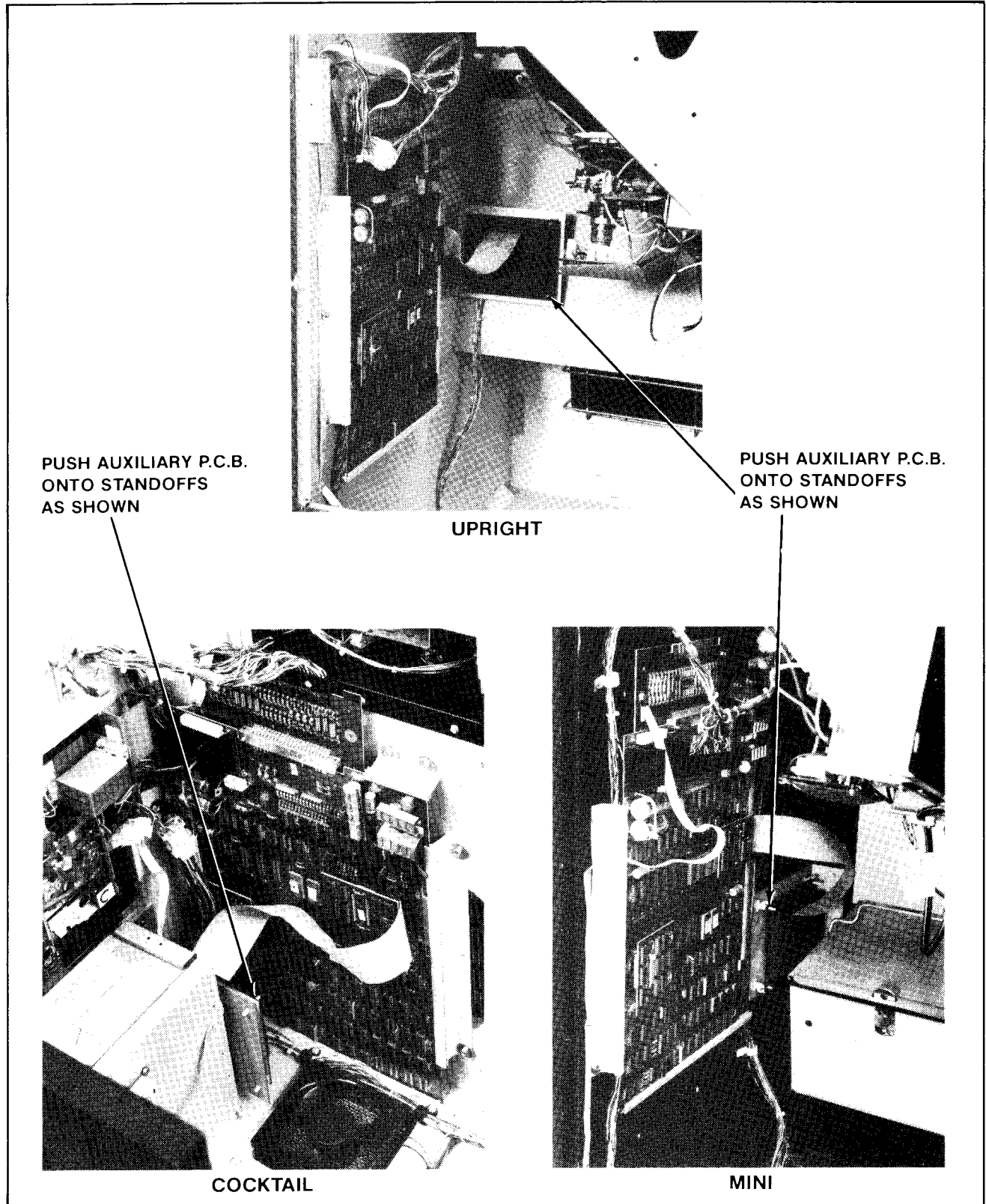

Figure 8

- 10** Reconnect all previously removed cabling to the Main Game Logic Board.
- 11** Close and lock the game cabinet and plug it back into its wall outlet.
- 12** Turn the game on and let it warm up for a few minutes, run a Self-Test on it, and play a couple of games to be sure everything is working properly.

NOTE: DO NOT FORGET to **SAVE** the Auxiliary Game Logic Board, six EPROMS, and two PROMS you removed in Steps 3 & 4 of this procedure. Put them in the packaging that the new EPROMS and PROMS came in and store them in a dark place at room temperature. They will not be harmed if stored this way. Thus, by reversing this procedure, you could convert your game back to a MS. PAC-MAN model if you ever wanted to.

Installation of Remainder of Conversion Kit Parts

1. ATTRACTION PANELS

(UPRIGHT AND MINI MODELS):

- Turn the power off to the game.
- Remove the screws installed in the top attraction panel bracket.
- Lift off the bracket.
- Slide the attraction panel up and out.
- Install the new PAC-MAN PLUS attraction panel and secure it with the top attraction panel bracket.

2. TABLE TOP GLASS AND UNDERLAY (COCKTAIL TABLE MODEL):

- Turn the power off to the game.
- Remove the Screws securing the table top glass clamps in place.
- Remove the above clamps and the table top glass.
- Affix the new PAC-MAN PLUS Serial Number Tag to the **UNDERSIDE** of the table top glass as shown in Figure 9.

- Reinstall the table top glass.
- Secure the above with the table top glass clamps and screws you removed earlier.
- Affix **BOTH** Table Top Glass Labels to the **TOP SIDE** of the table top glass as shown in Figure 9.

3. MAIN-DISPLAY-GLASS

(UPRIGHT AND MINI MODELS):

- Turn the power off to the game.
- Remove the main-display-glass as described in the appropriate sections of your OPERATOR'S MANUAL.
- Affix the new PAC-MAN PLUS Serial Number Tag to the **UNDERSIDE** of the main-display-glass as shown in Figure 10.
- Reinstall the main-display-glass.
- Affix the Main-Display-Glass Label to the **TOP SIDE** of the main-display-glass as shown in Figure 10.

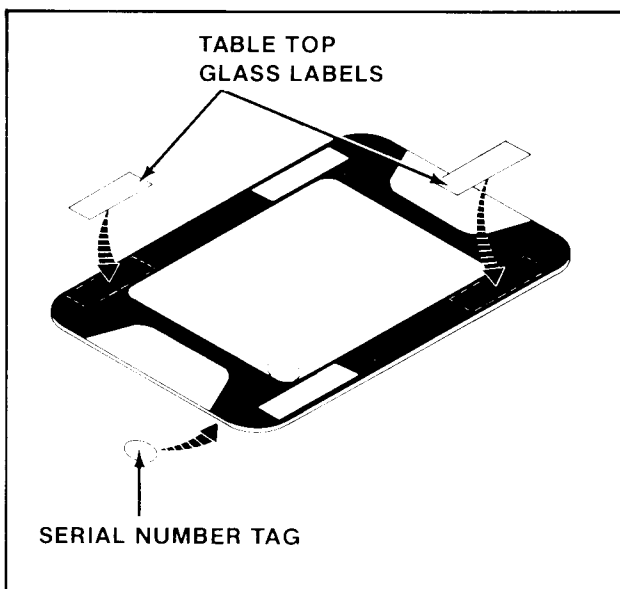

Figure 9

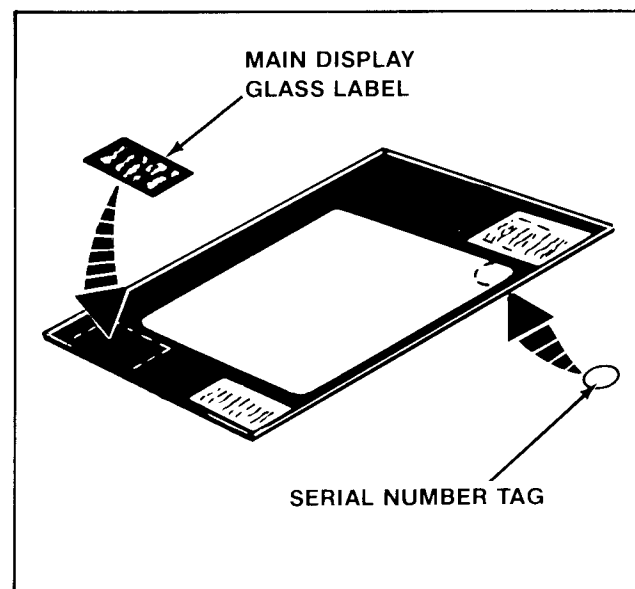

Figure 10