

CABARET™

Operation, Maintenance and Service Manual
Complete with Illustrated Parts Lists

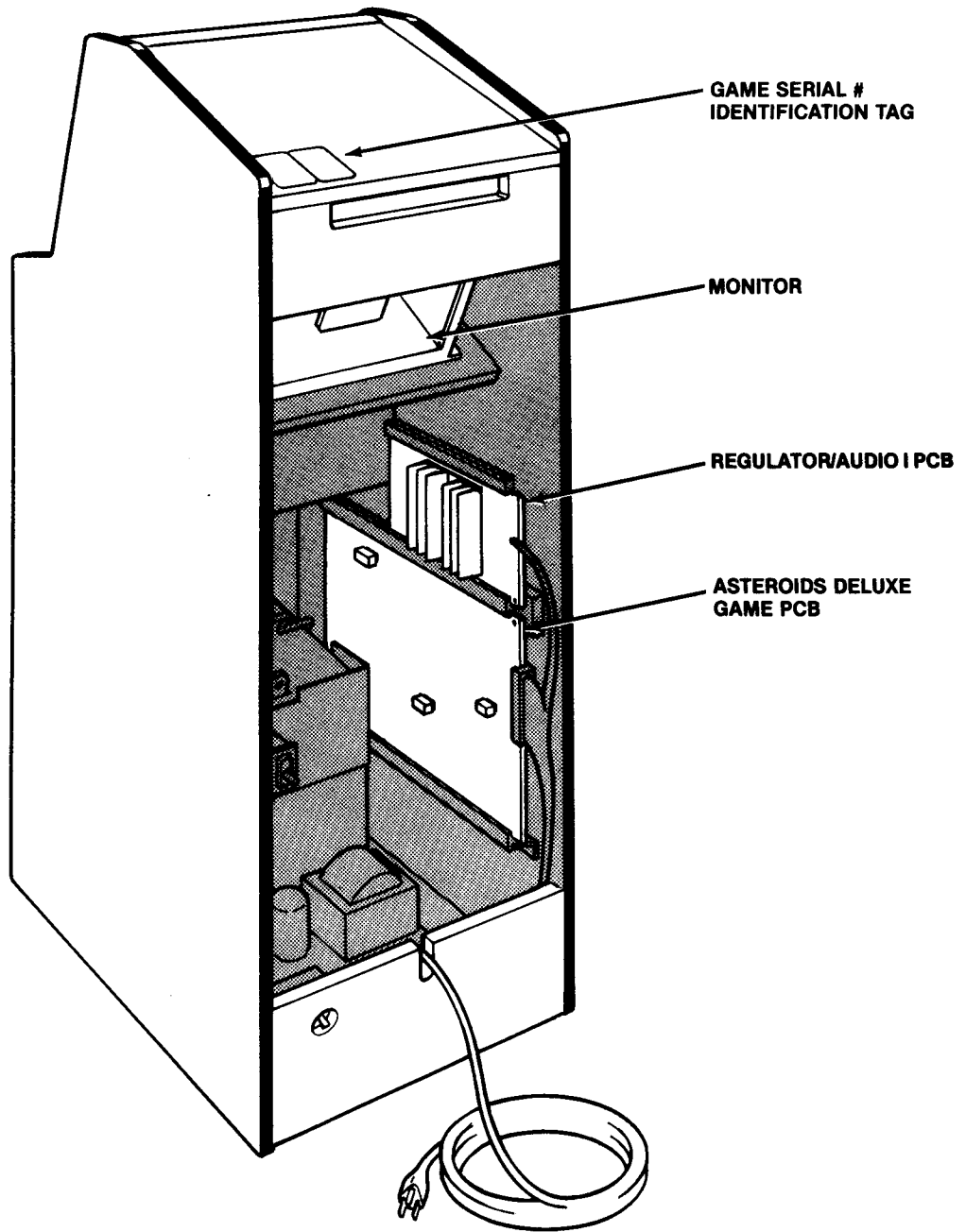



GAME SERIAL NUMBER LOCATION

Your game's serial number is stamped on a plate on the outside of the game. The same number is also stamped on the chassis of the monitor, Regulator/Audio I PCB, and the Asteroids Deluxe™ Game PCB. Please mention this number whenever calling your distributor for service.



Operation, Maintenance and Service Manual

Complete with Illustrated Parts Lists



 A Warner Communications Company

Copyright © 1981 by Atari, Inc.

All rights reserved.

No part of this publication may be reproduced by any mechanical, photographic, or electronic process, or in the form of a phonographic recording, nor may it be stored in a retrieval system, transmitted, or otherwise copied for public or private use, without permission from the publisher.

Published by:
ATARI, INC.
1265 Borregas Avenue
P. O. Box 427
Sunnyvale, California 94086

Lithographed in the U.S.A. **3K**

NOTE

If reading through this manual does not lead to solving a certain maintenance problem, call Tele-Help® at the Atari Customer Service office in your geographical area, as shown below.

WEST and CENTRAL U.S.A.

Parts for all Atari customers in the U.S.A. Game sales and service

Atari, Inc.
California Customer Service Office
1105 N. Fair Oaks Avenue
P. O. Box 427, Sunnyvale, CA 94086
Telex 17-1103
(Monday–Friday, 7:30–4:00 pm Pacific Time)

 From California, Alaska or Hawaii
(408) 745-2900

 From anywhere else in this area
toll-free (800) 538-1611

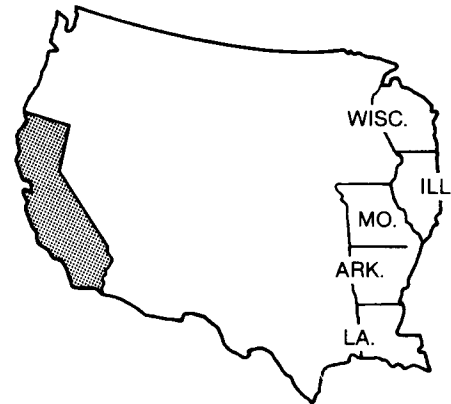
**EAST U.S.A.**

Game sales and service only

Atari, Inc.
New Jersey Customer Service Office
Cottontail Lane, Somerset, NJ 08873
Telex 37-9347
(Monday–Friday, 7:30–4:00 pm Eastern time)

 From New Jersey
(201) 469-5993

 From anywhere else in this area
toll-free (800) 526-3849

**EUROPE**

Parts for all Atari customers in Western Europe.

Game sales and service

Atari Ireland Limited
European Customer Service Office
Tipperary Town, Ireland
Telex 8165
(Monday–Friday, 9:00–6:00 pm GMT)

 062-52155

TIPPERARY TOWN,
IRELAND



Table of Contents

1	Location Setup	
A.	New Parts	1
B.	Game Inspection	3
C.	Game Installation	3
	1. Voltage Selection	3
	2. Interlock and Power On/Off Switches	4
D.	Self-Test Procedure	6
E.	Option Switch Settings	9
	1. Bonus Play Feature	9
	2. Coin Mechanism Multipliers	10
	3. Examples of Game Price Settings	10
F.	Game Play	13
	1. Attract Mode	13
	2. Ready-to-Play Mode	14
	3. Play Mode	14
	4. High Score Initial Mode	14
2	Maintenance and Repair	
A.	Cleaning	16
B.	Fuse Replacement	16
C.	Opening the Control Panel	16
	1. Leaf-Switch Replacement	16
	2. LED Start-Switch Replacement	16
D.	Monitor Removal	18
E.	Printed-Circuit Board Removal	19
F.	Fluorescent Tube Replacement	20
G.	Game Operation	21
3	Illustrated Parts Lists	
	Illustrations and parts lists begin on page	26

List of Illustrations

Figure 1	Overview of Game	2
Figure 2	Installation Requirements	3
Figure 3	International Line Voltage Selection	4
Figure 4	Interlock and Power On/Off Switches	5
Figure 5	Location of Self-Test Switch, Volume Control and Option Switches ...	6
Figure 6	Self-Test Procedure	7
Figure 7	Game Option Settings	9
Figure 8	Game Price Settings	11
Figure 9	Coin Counter Option Settings	13
Figure 10	Opening the Control Panel and Replacing Switches	17
Figure 11	Monitor Removal	18
Figure 12	Printed-Circuit Board Removal	19
Figure 13	Fluorescent Tube Replacement	20
Figure 14	Power Distribution	21
Figure 15	Signal Distribution	22
<i>Illustrated Parts Lists:</i>		
Figure 16	Cabinet-Mounted Assemblies	26
Figure 17	Control-Panel Assembly	28
Figure 18	Fluorescent Light Assembly	29
Figure 19	Asteroids Deluxe™ Game PCB Assembly	30
Figure 20	Regulator/Audio I PCB Assembly	34
Figure 21	Power Supply Assemblies for X-Y Games	36
Figure 22	American-Made Coin Door	38
Figure 23	British-Made Coin Door	42

Notice Regarding Non-Atari Parts

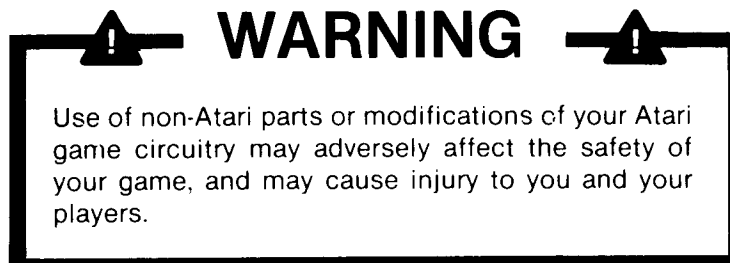

Atari, Inc.'s warranty (printed on the inside back cover of this manual) may be voided, if you do any of the following:

- 1.) you substitute non-Atari parts in your coin-operated game, or
- 2.) you modify or alter any circuits in your Atari game by using kits or parts **not** supplied by Atari.

Not only may the use of any non-Atari parts void your warranty, but any such alteration may also adversely affect the safety of your game, and may cause injury to you and your players.

Location Setup



A. New Parts

The Asteroids Deluxe™/Cabaret game has two new parts. Even if you are familiar with Atari games, you should note these important differences. The new parts are:

- **Deep-Well Coin Box.** This new coin box conservatively holds \$600 in U.S. quarters. Please note that \$500 in quarters weighs over 11 kg (25 lbs.), and \$600 in quarters weighs 12¾ to 13½ kg (28-30 lbs.).
- **Game PCB Circuitry.** Most video games to date have used the raster-scan method of display. This game uses vector-generation with X and Y axes which allows better contrast and a greater number of moving objects, and draws lines at any angle.

⚠ WARNING: ⚠ SHOCK HAZARD

Connect this game only to a grounded 3-wire outlet. If you have only a 2-wire outlet, we recommend you hire a licensed electrician to install a grounded outlet. **Players may receive an electric shock if this game is not properly grounded!**

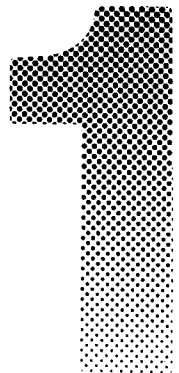
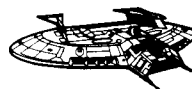
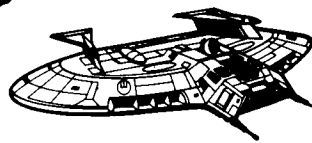

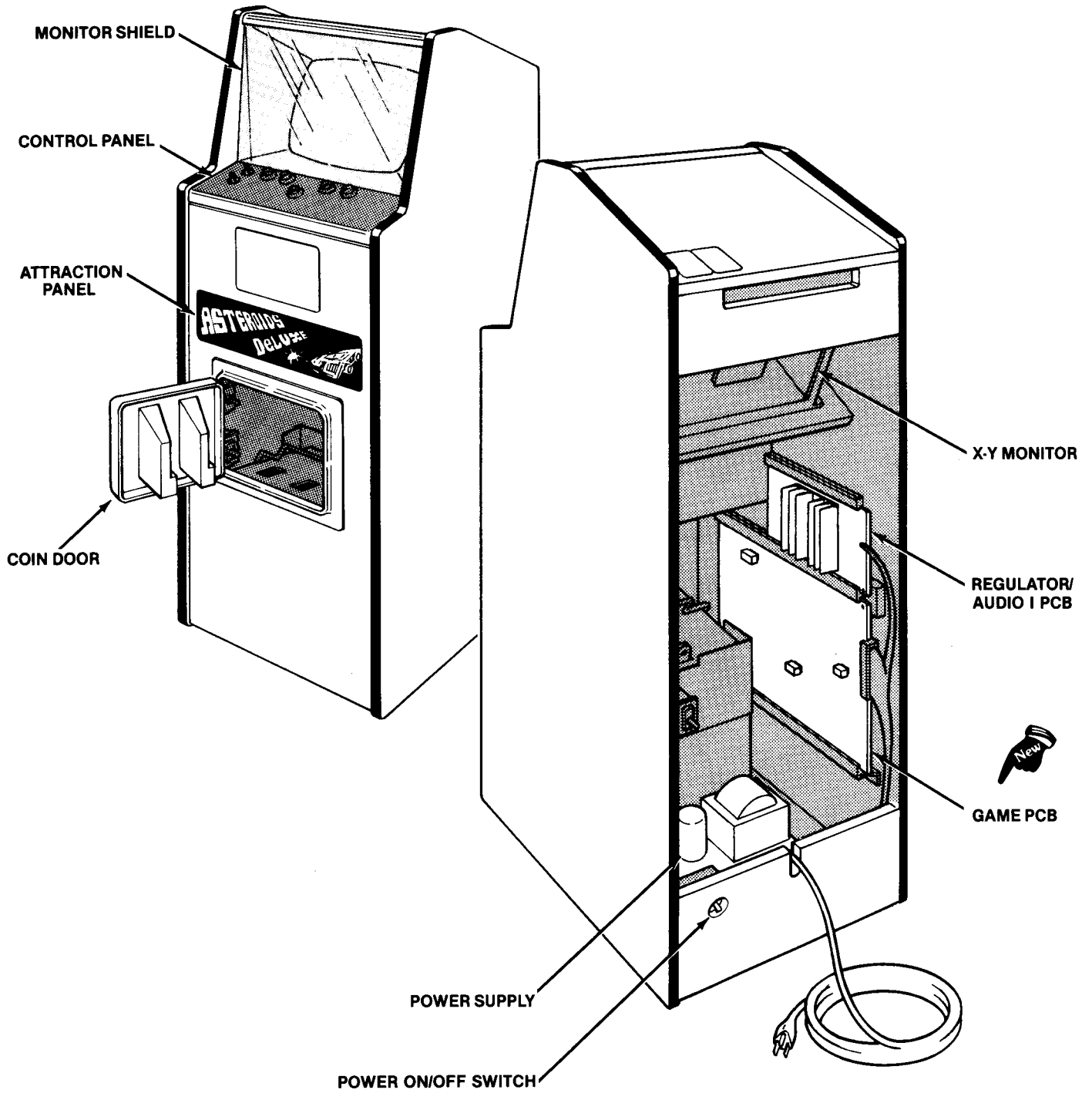

Figure 1 Overview of Game

In addition, Asteroids Deluxe™ is one of the first Atari games to have non-volatile memory for part of the high score table. This means that even if power is removed from the game, the three highest scores will permanently stay in memory. You may erase these scores by following the instructions in Figure 6, Self-Test Procedure.

These new parts, as well as all other major parts in the game, are illustrated in Figure 1. Throughout this manual, wherever one of these new parts is mentioned, you will see this symbol:



B. Game Inspection

This new game is ready to play upon removal from the shipping carton. However, your careful inspection is needed to supply the final touch of quality control. Please follow these steps to help us insure that your new game was delivered to you in good condition.

NOTE

Do not plug the game in yet!

1. Examine the exterior of the game cabinet for dents, chips, or broken parts.
2. Unlock and open the access panel of the cabinet and inspect the interior of the game as follows:
 - Check that all plug-in connectors (on the game harness) are firmly seated. Replug any connectors found unplugged. **Don't force connectors together.** The connectors are keyed so they only go on in the proper orientation. **A reversed edge connector will damage a PCB** and will void your warranty.
 - Check that all plug-in integrated circuits on the game PCB are firmly seated in their sockets.

WARNING

To avoid possible unpleasant electrical shock, do not touch internal parts of the monitor with your hands or metal objects held in your hands!

- Note the location of the game's serial number—it is printed on the special label on the outside of the game cabinet. Verify that the serial numbers also stamped on the Asteroids Deluxe™ Game PCB, Regulator/Audio I PCB and monitor are all identical. A drawing of the serial-numbered components is on the inside front cover of this manual. Please mention this number whenever you call your distributor for service.
- Check all major subassemblies such as the power supply, control panel and monitor for secure mounting.

C. Game Installation

Figure 2 Installation Requirements

Power	140 watts
Temperature	0 to 38° C (32 to 100° F)
Humidity	Not over 95% relative
Space Required	52 x 60 cm (20 3/8 x 23 3/4 in.)
Game Height	139 cm (54 3/4 in.)

1. Voltage Selection

This game has two possible power supplies: the U.S. or international power supply. The U.S. power supply operates on one line voltage range: 105 to 135 VAC. The international power supply has four colored voltage selection plugs and operates on the line voltage of almost any country in the world.

Before plugging in your game, check your power supply. If the supply *doesn't* have voltage selection plugs and a connector at J3 (see Figure 3), then the game operates on any voltage from 105 to 135 VAC. If the supply *has* the colored voltage selection plugs, make sure that the voltage selection plug is correct for your location's line voltage. Check the wire color on the plug and see if it is correct per Figure 3.

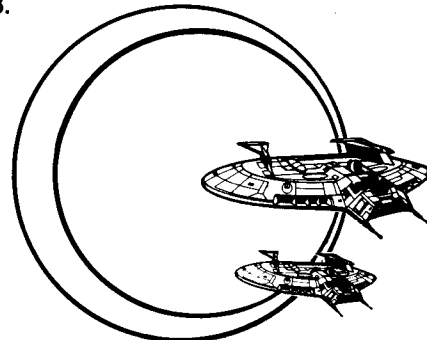

Line Voltage Range

90-110 VAC (100)
 105-135 VAC (120)
 200-240 VAC (225)
 220-260 VAC (240)

Plug Color

Violet
 Yellow
 Blue
 Brown

WARNING

Fuse cover must be in place during game operation.

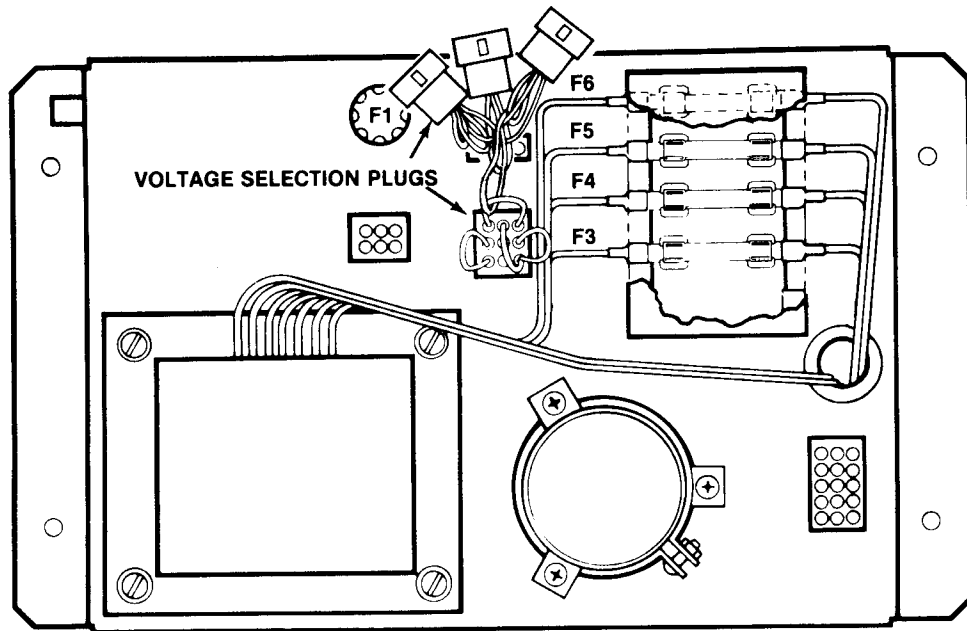

Figure 3 International Line Voltage Selection

2. Interlock and Power On/Off Switches

To minimize the hazard of electrical shock while working on the inside of the game cabinet, an interlock switch has been installed (see Figure 4). One is located behind the access panel and one is behind the coin door. These switches remove all AC line power from the game circuitry when a door is opened.

Check for proper operation of the interlock switches by performing the following steps:

- Plug the AC line power cord into an AC outlet.
- Be sure the access panel and the coin door are closed.

- Set the power on/off switch to the **on** position. Within approximately 30 seconds the monitor should display a picture.
- Slowly open the rear access panel. The monitor picture should disappear when the panel is opened approximately 2½ cm (1 inch). Close and lock the access panel and repeat this step with the coin door.
- If the results of the preceding step are satisfactory, the interlock switches are operating properly. If the monitor doesn't go off as described, check to see if the corresponding interlock switch is broken from its mounting or stuck in the **on** position.

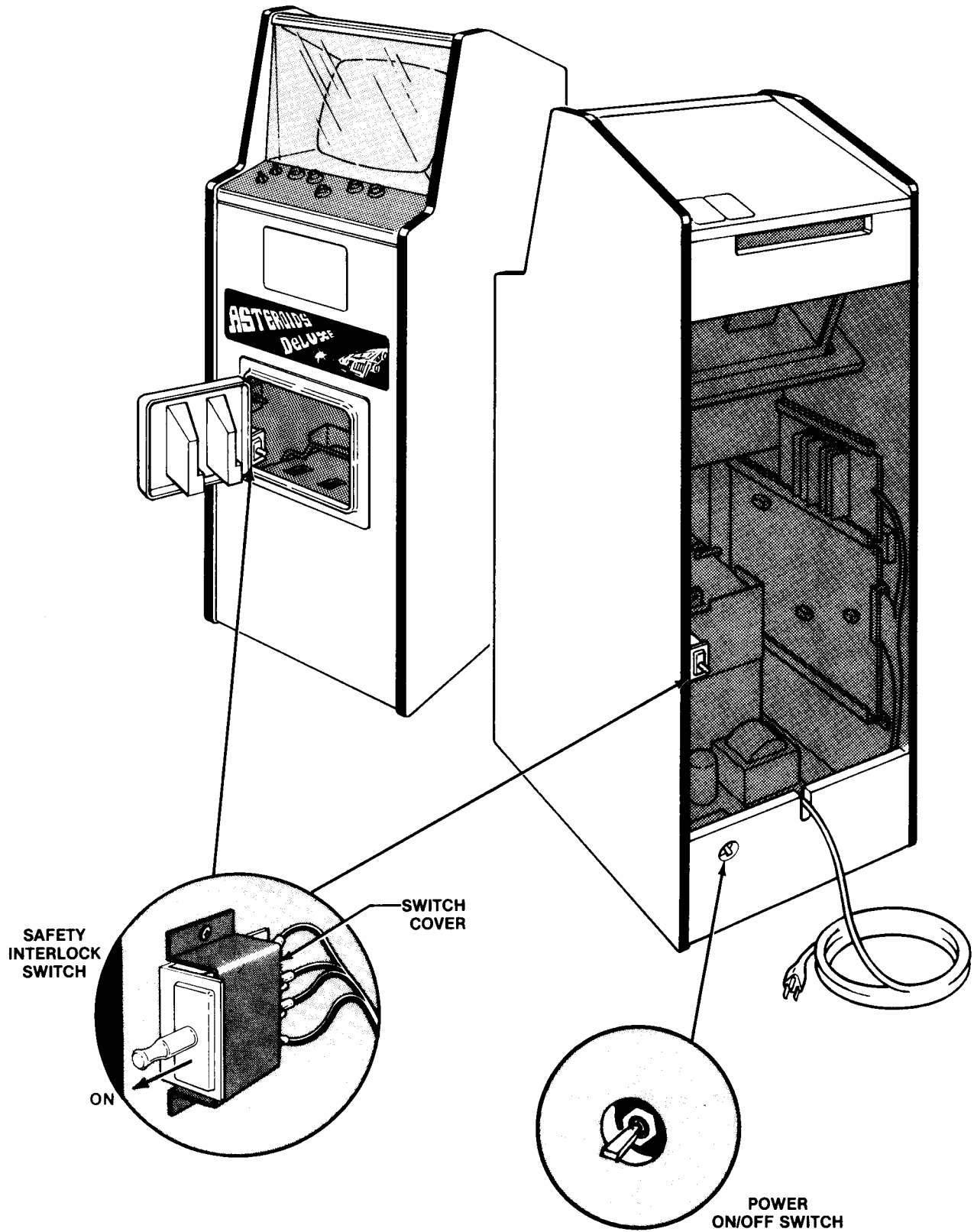

Figure 4 Interlock and Power On/Off Switches

D. Self-Test Procedure

This game will test itself and provide data to demonstrate that the game's circuitry and controls are operating properly. The data is provided on the monitor and the game speaker; no additional equipment is necessary.

Part of the self-test procedure includes a display of the operator-selectable game options. Therefore, we suggest you run the self-test procedure anytime you need to change the game's options.

To run the self-test, follow the instructions outlined in Figure 6.

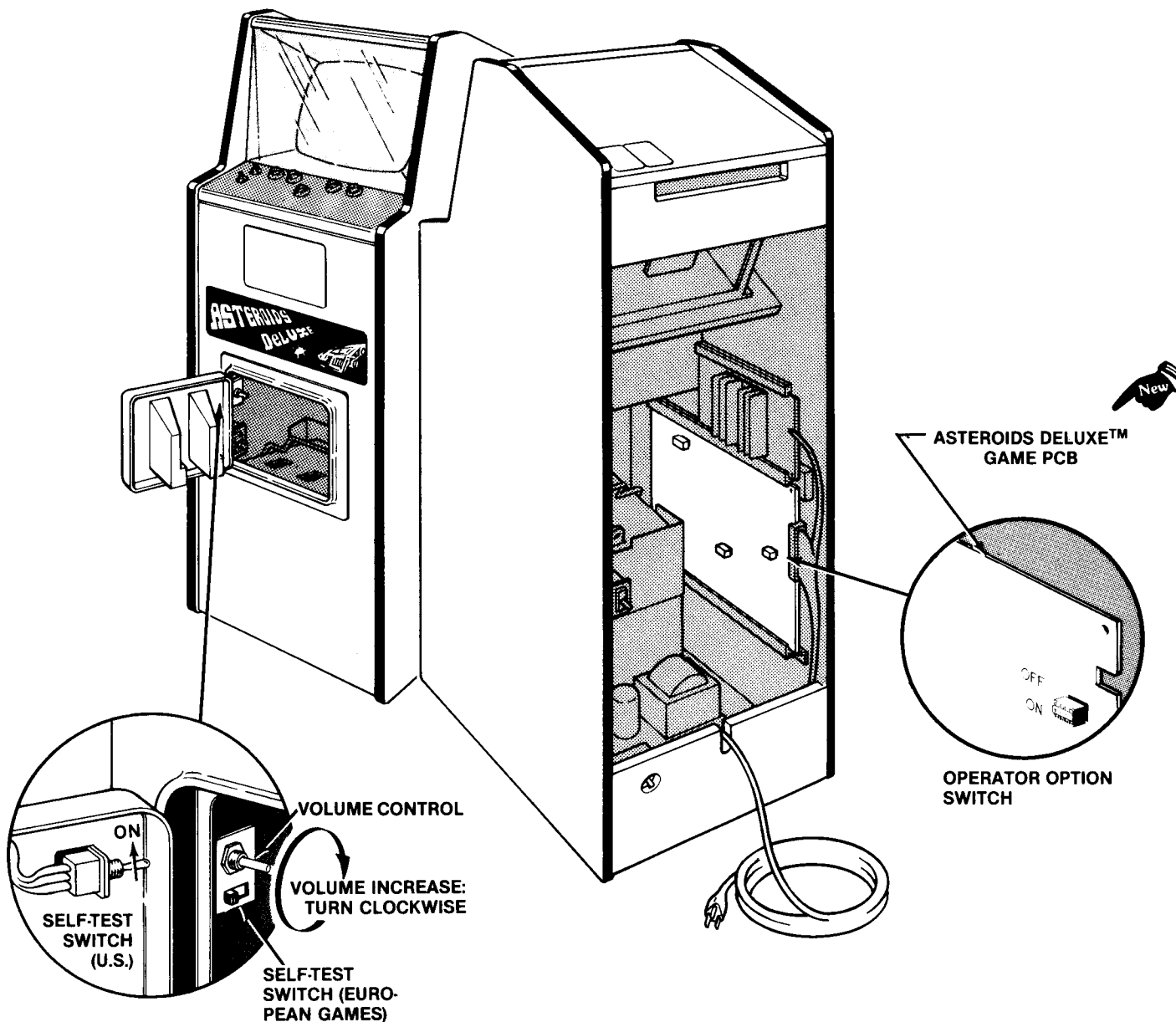
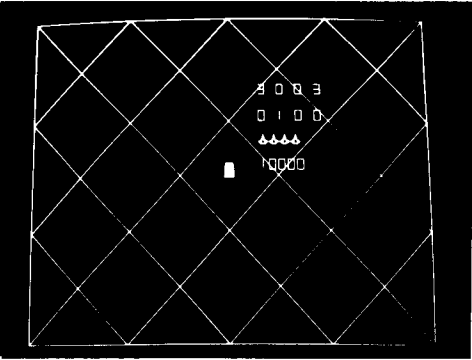



Figure 5 Location of Self-Test Switch, Volume Control and Option Switches

Figure 6 Self-Test Procedure

Instruction	Results if Test Passes	Results if Test Fails																				
1. Set self-test switch to on position (see Figure 5).	The monitor displays the picture below. The game produces only a very short beep sound.	RAM FAILURE is indicated by a sequence of low and high beeps. Note the sequence of beeps and determine which RAM(s) may be bad. To restart the sequence, press the reset pushbutton on the game PCB, or set the self-test switch to <i>off</i> , then again to the <i>on</i> position.																				
 <p data-bbox="261 1083 646 1129">Example only—detail on next page explains these four rows of symbols.</p>		<table border="0"> <thead> <tr> <th data-bbox="808 590 1003 611">Sequence of Beeps</th> <th data-bbox="1211 569 1430 615">Possible Bad RAM Chip Location(s)</th> </tr> </thead> <tbody> <tr> <td data-bbox="873 615 938 636">1 low</td> <td data-bbox="1304 615 1336 636">L1</td> </tr> <tr> <td data-bbox="873 636 938 657">2 lows</td> <td data-bbox="1284 636 1356 657">L1, M1</td> </tr> <tr> <td data-bbox="841 657 971 678">1 high, 1 low</td> <td data-bbox="1304 657 1336 678">M1</td> </tr> <tr> <td data-bbox="833 695 979 716">2 highs, 1 low</td> <td data-bbox="1304 695 1336 716">M3</td> </tr> <tr> <td data-bbox="833 716 979 737">2 highs, 2 lows</td> <td data-bbox="1284 716 1356 737">M3, R3</td> </tr> <tr> <td data-bbox="833 737 979 758">3 highs, 1 low</td> <td data-bbox="1304 737 1336 758">R3</td> </tr> <tr> <td data-bbox="833 774 979 795">4 highs, 1 low</td> <td data-bbox="1304 774 1336 795">N3</td> </tr> <tr> <td data-bbox="833 795 979 816">4 highs, 2 lows</td> <td data-bbox="1284 795 1356 816">N3, P3</td> </tr> <tr> <td data-bbox="833 816 979 837">5 highs, 1 low</td> <td data-bbox="1304 816 1336 837">P3</td> </tr> </tbody> </table> <p data-bbox="699 858 1356 879">Any bad RAMs must be replaced before the self-test can continue.</p> <p data-bbox="699 905 1528 995">ROM/PROM FAILURE is indicated by the display of the actual PROM or ROM chip location(s) on the center left side of the monitor screen. Both a PROM or its equivalent ROM are inserted into the same socket. Therefore, the displays are correct regardless of whether your game PCB has PROMs or ROMs or a combination of both.</p> <p data-bbox="699 995 1528 1043">If the screen is blank or displays "garbage," the chips at locations N2 and/or J1 are probably bad.</p> <p data-bbox="699 1073 1528 1163">INVERTING CIRCUITRY FAILURE is indicated by the <i>BANK ERROR</i> message in the lower center part of monitor screen. This circuitry is necessary for the cocktail-table version to function properly, that is, the picture turns 180° with every other ship in 2-player cocktail games.</p> <p data-bbox="699 1192 1528 1241">AUDIO CHIP FAILURE is indicated by the <i>ERROR</i> message at center bottom of the screen. The large audio chip is at location M7/8 on the game PCB.</p>	Sequence of Beeps	Possible Bad RAM Chip Location(s)	1 low	L1	2 lows	L1, M1	1 high, 1 low	M1	2 highs, 1 low	M3	2 highs, 2 lows	M3, R3	3 highs, 1 low	R3	4 highs, 1 low	N3	4 highs, 2 lows	N3, P3	5 highs, 1 low	P3
	Sequence of Beeps	Possible Bad RAM Chip Location(s)																				
1 low	L1																					
2 lows	L1, M1																					
1 high, 1 low	M1																					
2 highs, 1 low	M3																					
2 highs, 2 lows	M3, R3																					
3 highs, 1 low	R3																					
4 highs, 1 low	N3																					
4 highs, 2 lows	N3, P3																					
5 highs, 1 low	P3																					
2. Activate all 7 control-panel switches, the slam switch, and coin door switches.	As you activate and deactivate each switch, you'll hear a short low beep. Both start switch LEDs will be constantly lit.	You will not hear a short low beep for the defective switch, or dark LED.																				
 3. Erasing the High Score Table (optional)	The current three highest scores are held in permanent memory, even if the game is unplugged. These three are marked with spaceship symbols in the high score table. If you want to erase these scores, simultaneously press the rotate left, rotate right, thrust, and fire buttons. The <i>ERASING</i> message near the center of the screen will then be displayed for several seconds, until the entire table is erased.																					
4. When satisfied with test, set self-test switch to <i>off</i> position.																						

[Self-test continued on next page]

Figure 6 Self-Test Procedure, continued

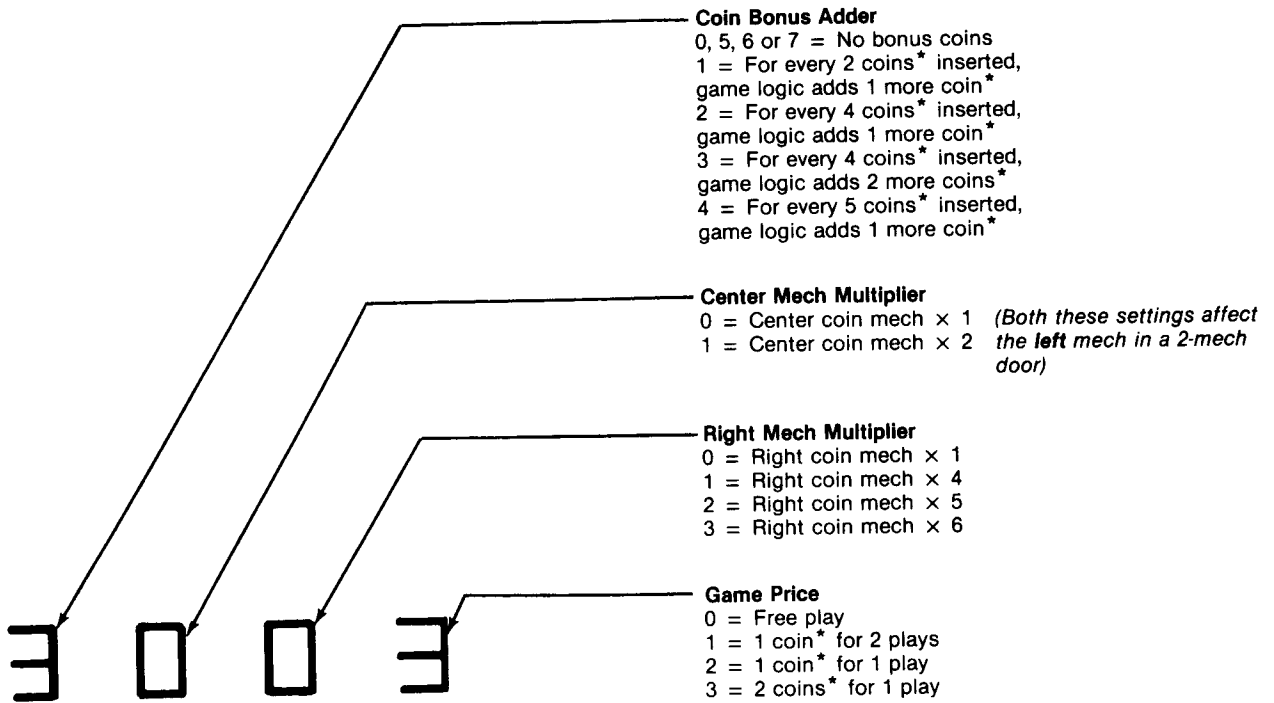

*In the U.S. a "coin" is defined as 25¢. In Germany a "coin" is 1 DM.

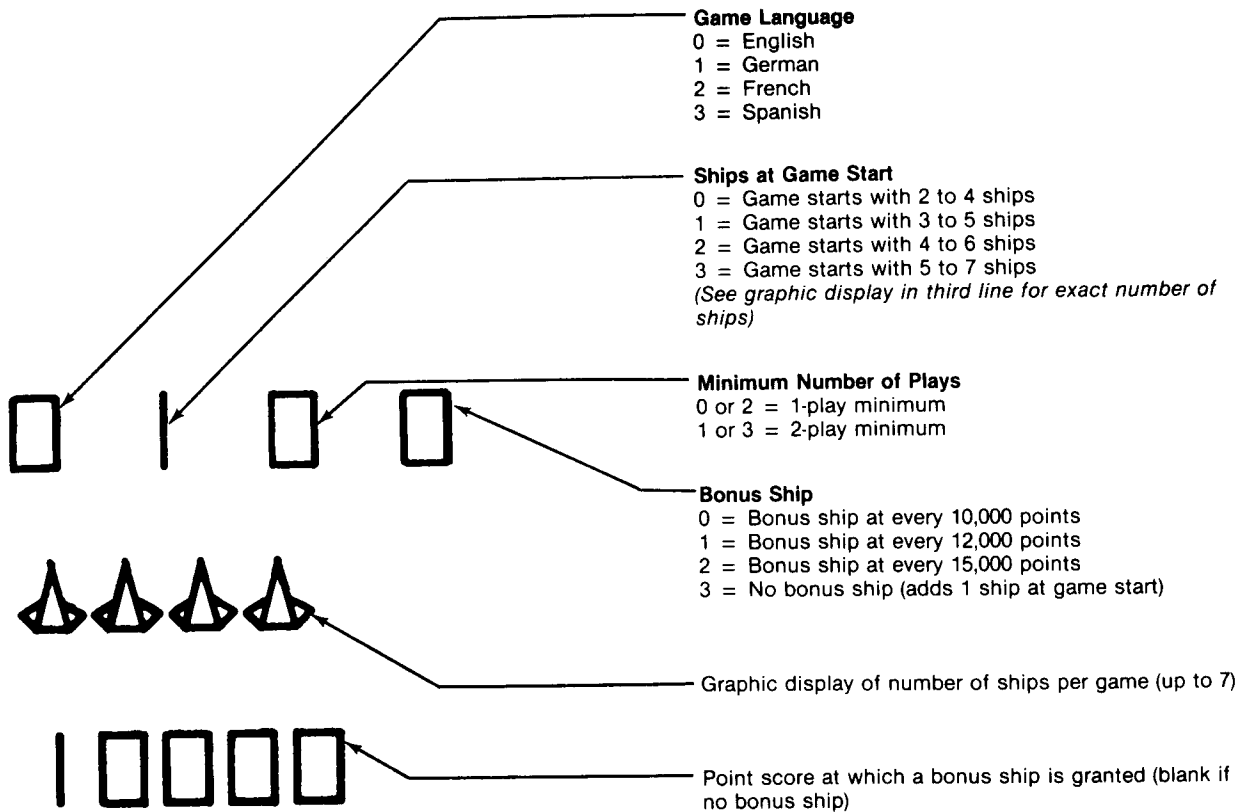

E. Option Switch Settings

1. Bonus Play Feature

Asteroids Deluxe™ offers a bonus play for certain combinations of coins inserted. This bonus feature is operator-selectable, meaning you may choose to offer it or not.

For example, with your game set at 50¢ per play, players who deposit four successive quarters or a \$1.00 coin, then press the start button, will receive a bonus play. Therefore, players receive 3 plays for \$1.00.

This bonus feature encourages players to insert more money than just the minimum 50¢ you could require for one game. Various other bonuses are available (see Figure 8).

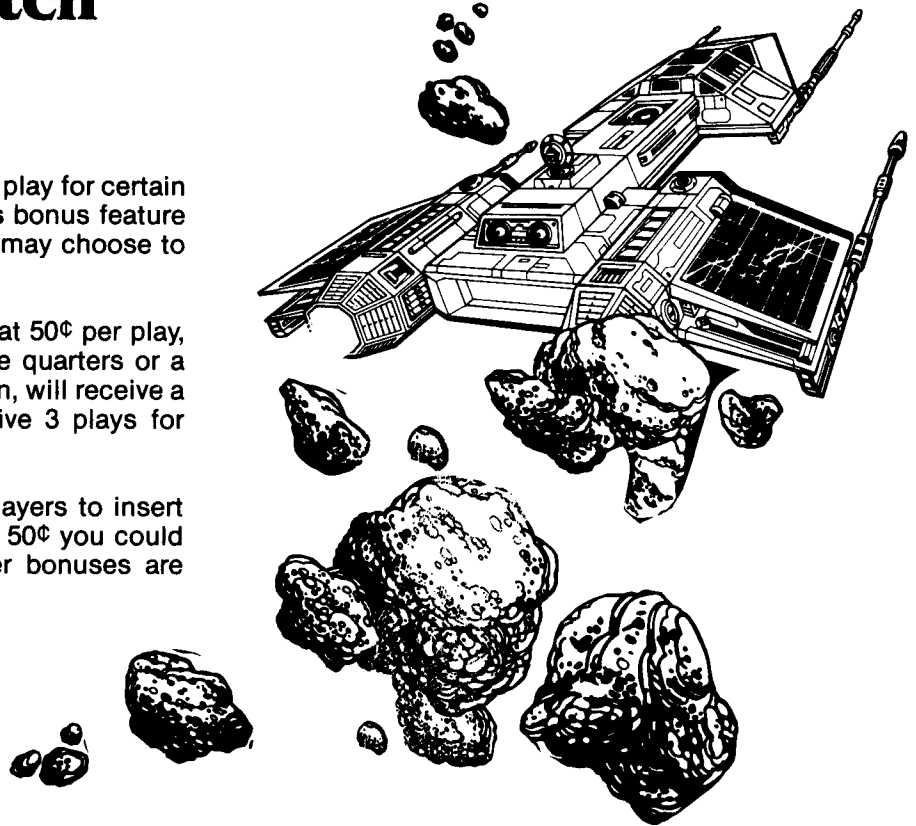

Figure 7 Game Option Settings

To change toggle positions on the switch assemblies, you need not remove the game PCB. The switches, usually colored blue, are easily accessible when the Asteroids Deluxe™ Game PCB is mounted in place.

When changing the options, verify proper results on the monitor display **by performing the self-test**. Note that changing an option on any of the following eight toggles will cause an immediate change on the monitor screen during the self-test.

Toggle Settings of 8-Toggle Switch on Asteroids Deluxe PCB
(at R5—LEFT switch when PCB is in game)

8	7	6	5	4	3	2	1	Option
						On	On	English language \$
						On	Off	German language
						Off	On	French language
						Off	Off	Spanish language
		Not Used		On	On			Game starts with 2 ships \$
				On	Off			Game starts with 3 ships
				Off	On			Game starts with 4 ships
				Off	Off			Game starts with 5 ships
			On					1-play minimum \$
			Off					2-play minimum
On	On							Bonus ship at every 10,000 points \$
On	Off							Bonus ship at every 12,000 points
Off	On							Bonus ship at every 15,000 points
Off	Off							No bonus ship

If set for no bonus ship or 50¢ play, add 1 ship per setting.

\$ Manufacturer's suggested settings

2. Coin Mechanism Multipliers

Available since early in 1980, Atari's new coin door has two or three mechanisms. All recent Atari game PCBs identify the different mechanisms in a certain pattern.

The right coin mechs are all the same to the game's logic, regardless of whether you have two or three mechs in your door. In addition, the logic sees the left mech in a 2-mech door and the center mech in a 3-mech door as the same. Refer to the diagram below.

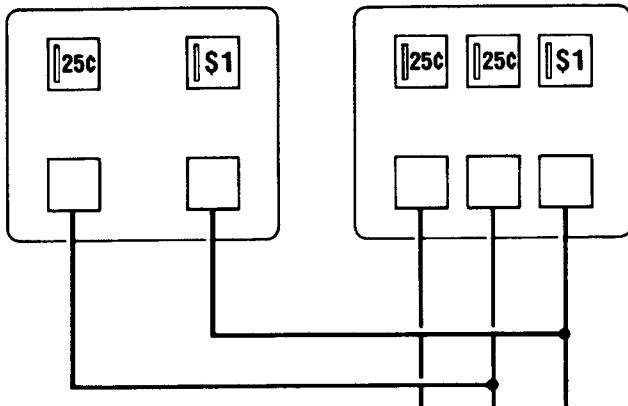

This pattern is important for you to know, so you can correctly set the "multipliers" for each mech. The multipliers determine how much each mechanism will be worth to the game's logic.

The basic unit of measurement is 25¢, which equals a multiplier of $\times 1$. Therefore, if you have a 25¢/25¢/\$1 coin door, you will probably want to set the center and right option-switch multipliers at $\times 1/\times 4$. (The left mech in a 3-mech door always has a value of $\times 1$ —you cannot change its value.)

You can set these multipliers with toggles 3 thru 5 on the Asteroids Deluxe PCB switch assembly at location L8. For exact settings of these toggles, refer to Figure 8.

3. Examples of Option Switch Settings

Figure 8 explains the options, giving twelve examples of the most common U.S. situations. The toggles mentioned are all in the switch at location L8; they **only** relate to game price, coin mechanism multipliers, and bonus play. You should set the toggles relating to other functions as you see fit, although Figure 7, 8, and 9 provide "\$" signs indicating Atari's recommendations.

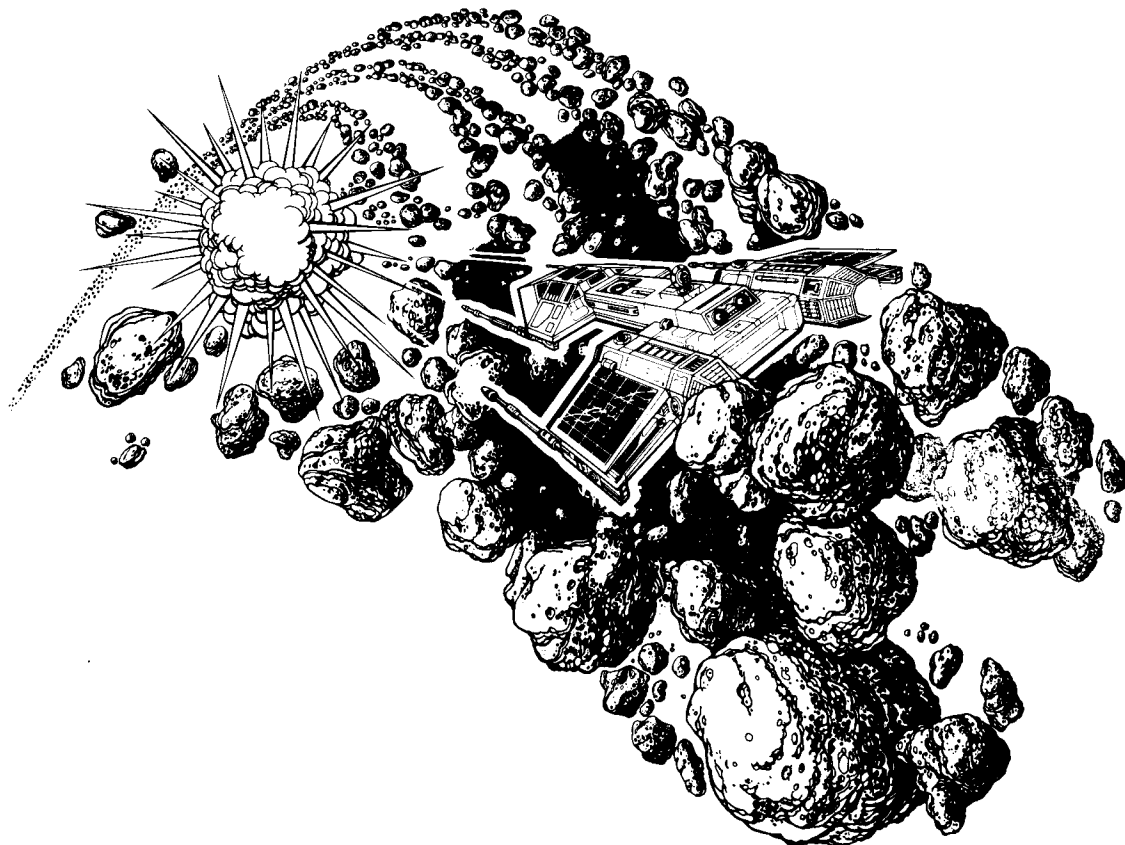

Figure 8 Game Price Settings

The white block below contains Atari's suggested settings. All numbers 1 thru 8 are toggle settings on the 8-toggle switch at location L8, on the Asteroids Deluxe™ game PCB (the CENTER switch assembly).

50¢ PER PLAY:

	No bonus	Bonus \$1.00 = 3 plays	Bonus \$.50 = 1 play \$.75 = 2 plays \$1.00 = 3 plays
Straight 25¢ Door	8 On 7 On 6 On 5 On 4 On 3 On 2 Off 1 Off ①	8 On 7 Off 6 Off 5 On 4 On 3 On 2 Off 1 Off ③	8 On 7 On 6 Off 5 On 4 On 3 On 2 Off 1 Off ④
25¢/\$1.00 Door or 25¢/25¢/\$1.00 Door	8 On 7 On 6 On 5 On 4 On 3 Off 2 Off 1 Off ①	8 On 7 Off 6 Off 5 On 4 On 3 Off 2 Off 1 Off ③ ⑤	8 On 7 On 6 Off 5 On 4 On 3 Off 2 Off 1 Off ④ ⑤

25¢ PER PLAY:

	No bonus	Bonus \$.50 = 3 plays	Bonus \$1.00 = 5 plays
Straight 25¢ Door	8 On 7 On 6 On 5 On 4 On 3 On 2 Off 1 On ② ⑥	8 On 7 On 6 Off 5 On 4 On 3 On 2 Off 1 On ⑥ ⑦	8 On 7 Off 6 On 5 On 4 On 3 On 2 Off 1 On ⑥ ⑦
25¢/\$1.00 Door or 25¢/25¢/\$1.00 Door	8 On 7 On 6 On 5 On 4 On 3 Off 2 Off 1 On ② ⑥	8 On 7 On 6 Off 5 On 4 On 3 Off 2 Off 1 On ⑥ ⑦	8 On 7 Off 6 On 5 On 4 On 3 Off 2 Off 1 On ⑥ ⑦

Circled numbers refer to coin-door labels you should use with each situation (labels are illustrated on the following page).

Use the label no. 6 (indicated above with ⑥) only if you set toggle 5 at PCB switch assembly R5 to off.

Figure 8 Game Price Settings, continued

For your information, we have defined below the switch settings for those options relating to game price, coin mechanism multipliers, and bonus play. This information is useful in case you need to temporarily set the Asteroids Deluxe™ game on free play, or if you have German coin mechanisms in your door.

The label no. 6 shown below should be used **only** if you set toggle 5 at PCB switch assembly R5 to **off**.

Toggle Settings of 8-Toggle Switch on Asteroids Deluxe PCB (at L8—CENTER switch when PCB is in game)								Option
8	7	6	5	4	3	2	1	
						On	On	Free play
						On	Off	1 coin* for 2 plays
						Off	On	1 coin* for 1 play \$
						Off	Off	2 coins* for 1 play
				On	On			Right coin mech × 1 \$
				On	Off			Right coin mech × 4
				Off	On			Right coin mech × 5
				Off	Off			Right coin mech × 6
			On					Center coin mech × 1 \$
			Off					Center coin mech × 2 \$ (Both these settings affect the left mech in a 2-mech door)
On	On	On						No bonus coins \$
On	On	Off						For every 2 coins* inserted, game logic adds 1 more coin*
On	Off	On						For every 4 coins* inserted, game logic adds 1 more coin*
On	Off	Off						For every 4 coins* inserted, game logic adds 2 more coins*
Off	On	On						For every 5 coins* inserted, game logic adds 1 more coin*

*In the U.S., a "coin" is defined as 25¢. In Germany a "coin" is 1 DM.

\$ Manufacturer's suggested settings

To achieve bonus plays, all coins must be inserted before pressing start button.

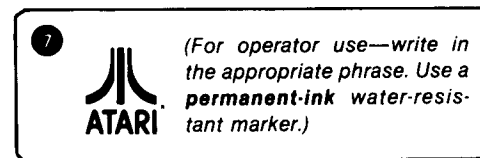
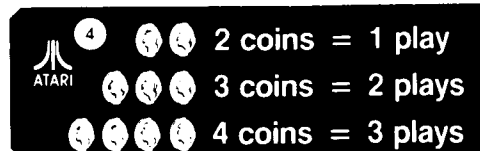
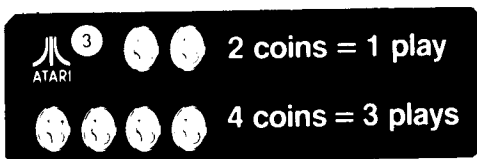

Figure 9 Coin Counter Option Settings

[These toggles determine which coin mechanisms activate which counters]

Toggle Settings of 4-Toggle Switch on Game PCB (M12)				Two coin acceptors in the coin door:	Two coin acceptors and a push-button utility coin switch in the game:	Three coin acceptors in the coin door:
4	3	2	1			
		On	On	Both acceptors activate all coin counters simultaneously.	<i>Do not use this setting.</i>	All 3 are same denomination and they activate all coin counters simultaneously.
Not Used	Not Used	Off	On	Both acceptors activate 2 counters separately.	<i>Do not use this setting.</i>	Left and center acceptor activate one coin counter; right acceptor activates another coin counter.
		On	Off	Both acceptors activate all coin counters simultaneously.	Utility coin switch will not activate a coin counter, if you do not hook up a separate counter. Both acceptors activate both coin counters simultaneously.	Left acceptor activates one coin counter; center and right acceptor activate another coin counter. <i>Not for any currently designed 3-mech coin door.</i>
		Off	Off	Both acceptors activate 2 counters separately. \$	Utility coin switch will not activate a coin counter, if you do not hook up a separate counter. Left and right acceptors activate 2 coin counters separately.	Left, center and right acceptors activate 3 coin counters separately. \$

\$ Manufacturer's suggested settings

F. Game Play

Atari's Asteroids Deluxe™ is a one- or two-player game with an X-Y or vector-generator monitor. The game depicts a third-person view of a player's spaceship battling to destroy asteroids, flying saucers and enemy ships or "death stars" (shaped like clusters of triangles). When hit, the asteroids and death stars will break into progressively smaller pieces.

Players can put up an octagon-shaped "shield" to temporarily protect their spaceship. However, this shield wears out with use.

The game has five possible modes of operation: Attract, Ready-to-Play, Play, High Score Initial, and Self-Test. Self-test is a special mode for checking the game switches and computer functions. You may enter this mode at any time. When entered, all game credits are cancelled.

1. Attract Mode

The attract mode begins when power is applied to the game, after a play or high score initial mode, or

after self-test. This mode is continuous and is only interrupted when a game is paid for and accepted or when you enter self-test.

In this mode, the monitor displays two possible pictures. One picture is of randomly tumbling asteroids, large and small saucers, and death stars—all in a simulated game. The other picture shows the ten currently highest scores.

If you erase the special "permanent" memory (see Figure 6, Self-Test Procedure), then the second picture with the high-score table will not appear on the screen. The table is redeveloped from scores of subsequent games.

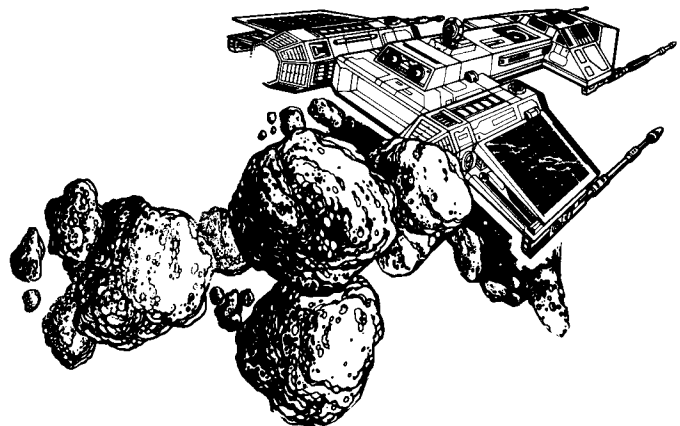

2. Ready-to-Play Mode

This mode begins when sufficient coins are accepted for a one- or two-player game. It ends when the 1 PLAYER START or 2 PLAYER START pushbutton is pressed.

Operators may choose one- or two-play minimums by selecting one of the option switch settings on the game PCB (see Figure 7, Game Option Settings). If you select the two-play minimum and a player inserts enough money for only one play, the message 2 GAME MINIMUM and CREDITS ½ stays on the screen until the required number of coins are inserted.

When this mode begins, the message *PRESS START* flashes immediately below the center score at the top of the screen. The displayed pictures are otherwise the same as those shown in the attract mode.

3. Play Mode

The play mode begins when either start pushbutton is pressed. The mode ends when the player's last ship of the game is lost.

Six large asteroids appear and drift in from the outer edges of the display. By pressing the ROTATE LEFT and ROTATE RIGHT pushbuttons on the control panel, the player may aim a spaceship toward any of the asteroids. The player uses the FIRE pushbutton to shoot at the asteroids and other objects.

When shot, each large asteroid divides into two medium-sized asteroids, and the game adds 20 points to the player's score. Medium-sized asteroids, when shot, divide into two small-sized asteroids, and the game awards 50 points to the player. When shot, the smallest asteroid disappears and the game adds 100 points to the player's score.

In addition to asteroids, the players can score points for shooting the various enemy ships. When hit, the large ships ("death stars" shaped like hexagons) score 50 points and break into three diamond shapes. The medium-sized enemy or diamond, when hit, grants the player 100 points and breaks into two small triangular pieces. These small pieces disappear when the player hits them, and the score increases by 200 points.

At any time during game play, a flying saucer may appear from either side of the display. The game awards players 200 points for shooting a large sau-

cer and 1000 points for a small saucer. (The latter is a smaller target for players, though not any faster moving than the large one. It also shoots more accurately.)

The player's objective in the game is to shoot and destroy as many asteroids, saucers, and enemy ships as possible before all his or her spaceships are destroyed. A ship is destroyed if an asteroid, saucer or enemy ship smashes into it, or if a flying saucer shoots it. To prevent losing a ship, the player may press the THRUST pushbutton to move out of the path of an oncoming object.

As an emergency maneuver, a player can press the SHIELDS pushbutton. An octagon will then appear around the player's ship as protection from all enemies. For challenge the shield power lasts only about 10 seconds, but the power is renewed with each ship. The amount of shielding power available is shown by the brightness of the octagon (dim means almost exhausted power).

An operator option allows you to award an extra ship each time a player's score reaches multiples of 10,000, 12,000 or 15,000 points. As an alternative, you may not offer any bonus ships at all to players. Refer to Figure 7, Game Option Settings, for how to set your game for this option.

When the last ship of the game is destroyed, the message *GAME OVER* appears below the high score. This message remains for three seconds before the high score initial mode begins.

4. High Score Initial Mode

At the beginning of the high score initial mode, the player instructions appear at the top of the screen, and A ___ appears at the lower center of the display. Players enter initials one character at a time.

By pressing the ROTATE LEFT pushbutton, the displayed character steps through the alphabet from A to Z. By pressing the ROTATE RIGHT pushbutton, the character shown will step backwards through the alphabet from A to a blank space, then from Z to A. Once the game displays the desired letter, players should press the SHIELDS pushbutton to record the letter; then an A appears in the next space.

If players need only two letters for their initials, they should use the blank between Z and A in one of the three locations. Pressing the SHIELDS pushbutton a third time will cause the initials and game score to be transferred to the high score table. This table contains a maximum of 10 scores and appears during the attract mode.

Maintenance and Repair

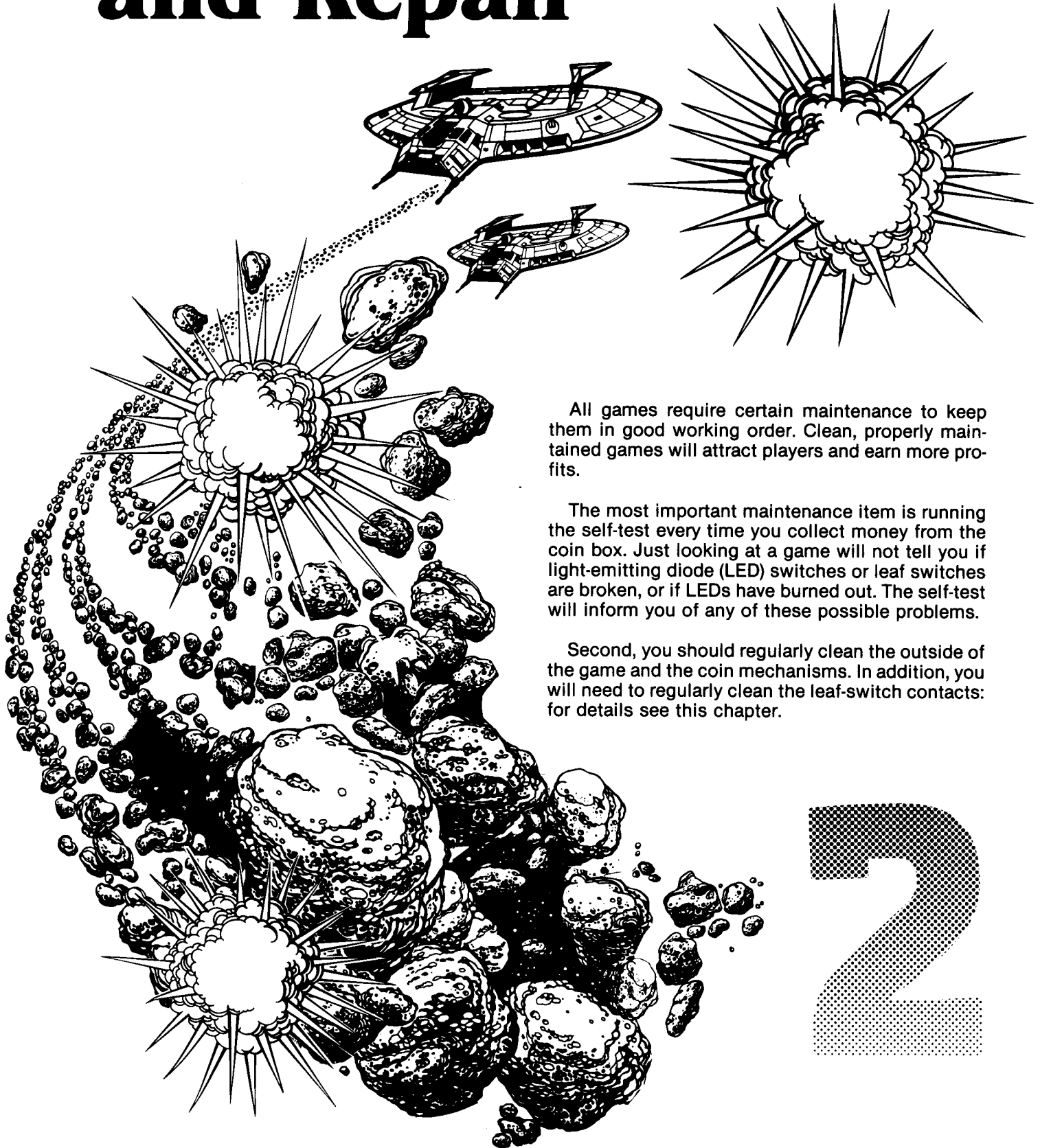

All games require certain maintenance to keep them in good working order. Clean, properly maintained games will attract players and earn more profits.

The most important maintenance item is running the self-test every time you collect money from the coin box. Just looking at a game will not tell you if light-emitting diode (LED) switches or leaf switches are broken, or if LEDs have burned out. The self-test will inform you of any of these possible problems.

Second, you should regularly clean the outside of the game and the coin mechanisms. In addition, you will need to regularly clean the leaf-switch contacts: for details see this chapter.

2

A. Cleaning

The exterior of the game cabinet and the metal and glass surfaces may be cleaned with any non-abrasive household cleaner. If desired, special coin machine cleaners that leave no residue can be obtained from your distributor.

Do not dry-wipe any of the acrylic panels, because dust can scratch the surface and result in fogging the plastic.

B. Fuse Replacement

This game contains five fuses—all on the power supply assembly (not including the monitor fuses). Replace fuses only with the same type as listed in Figure 21 of this manual. See the Quadrascan™ monitor manual for the monitor fuse data.

C. Opening the Control Panel

Prior to repairing or replacing any switch on the control panel or prior to removing the monitor, unplug the game. Then open the coin door.

Reach through the coin-door opening and open both luggage-style latches, located on the underside of the control panel (see Figure 10). Push up on the underside of the control panel with one hand. With the other hand lift the top edge of the panel towards you.

1. Leaf-Switch Replacement

NOTE

Adjust switches for a narrow gap. When a switch button is depressed, the resulting wiping action of the contacts provides a self-cleaning feature.

All five of these leaf switches operate on 5 volts at a very low current. Therefore, pitting of these switches would be extremely rare. Probably the only reason that pitting would occur is in very high-humidity locations.

Don't burnish the switch contacts. Burnishing them removes their plating, thus increasing the corrosion of the contacts. **The best method of cleaning the switch contacts is to wipe them with a non-abrasive surface.** A business card works very well.

To replace any switch, remove both of its screws with a Phillips-head screwdriver—see Figure 10.

If the white button itself needs to be replaced, turn the stamped nut with a wrench in a counter-clockwise direction, as seen from the inside of the control panel. The white ring on the outside of the control panel should not spin, due to its design.

2. LED Start-Switch Replacement

The light-emitting diode (LED) switches on the control panel have a very low failure rate. In case a switch should ever be suspect, first test it per the description that follows. To replace the switch, refer to Figure 10.

1. Remove the wires from the suspected switch.
2. Set multimeter to ohms scale. Set ohms scale to $R \times 1$, then zero the meter.
3. Connect multimeter leads to appropriate LED switch contacts (see Figure 10 for designation of switch contacts).
4. Check contacts (push and release the switch button) for closed and open continuity.
5. If the contacts do not operate sharply or always remain closed or open, then replace the LED switch as outlined in the figure.



To remove LED switch:

- Remove all wires from the faulty switch.
- Turn the switch counterclockwise while holding the black cone-shaped bushing on the outside of the control panel.
- Install a new switch using the reverse procedure.
- Reconnect the harness wires.

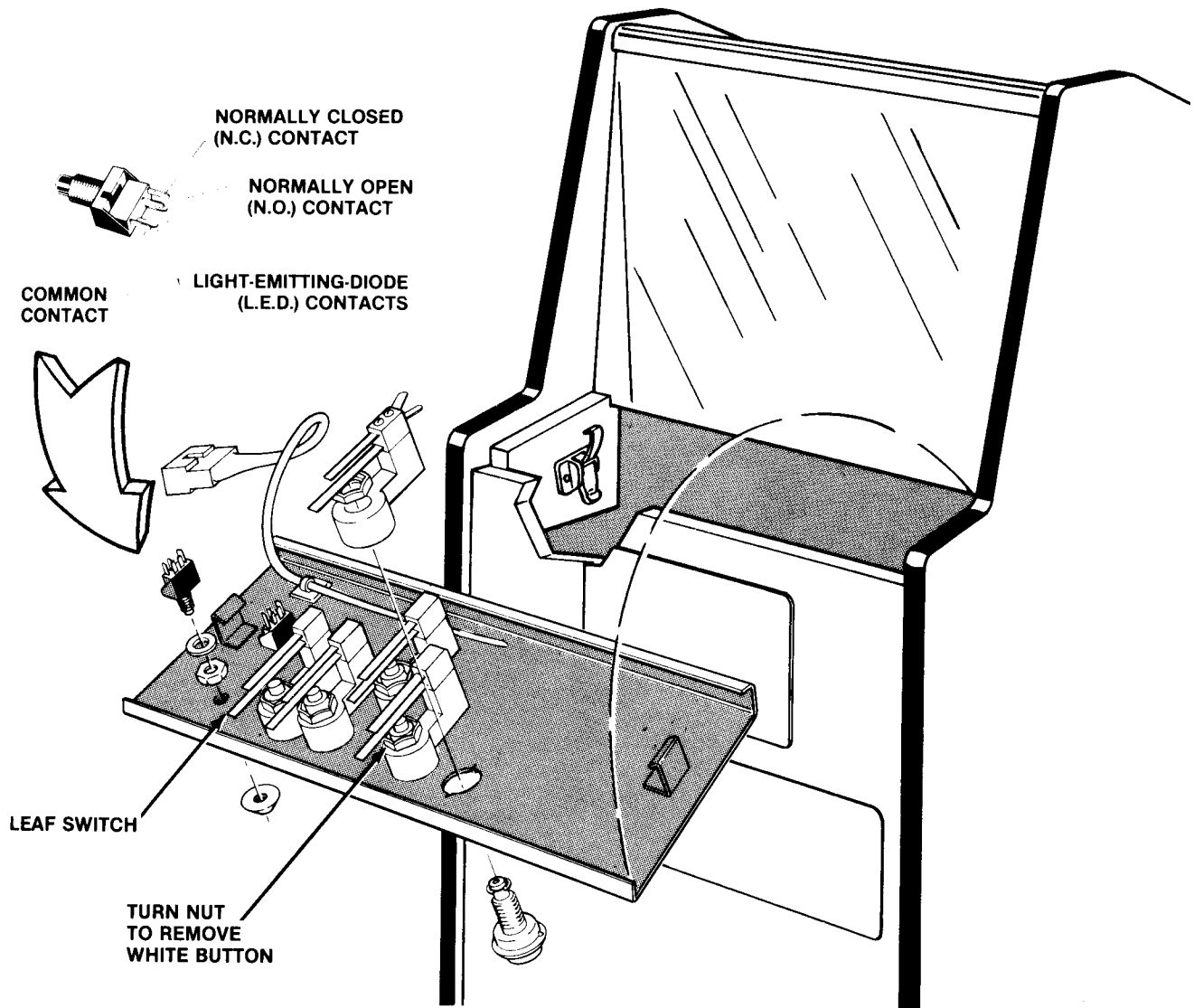

Figure 10 Opening the Control Panel and Replacing Switches

D. Monitor Removal

If you should need to remove the Quadrascan™ X-Y monitor, follow steps 1 thru 6 below. Refer to the accompanying Figure 11.

⚠ WARNING ⚠

Shock Hazard

High voltages may exist in any television or monitor, even with power disconnected. Use extreme caution and do not touch electrical parts of the yoke area with your hands or with metal objects in your hands!

Implosion Hazard

If you drop the monitor and the picture tube breaks, it will **implode!** Shattered glass and the yoke can fly 6 feet or more from the implosion. Use care when replacing any monitor.

1. Be sure the game is unplugged from its wall outlet! Then open the control panel as described in Section C. *Opening the Control Panel.*
2. Remove the acrylic monitor shield by loosening the retainer mounting hardware. Lift up the shield and slide out its lower edge.
3. Carefully remove the black cardboard bezel (it lies on top of the wood cleats and is attached with staples).
4. Open the rear access panel and unplug the 12-pin monitor harness connector.
5. Remove the four bolts, nuts, flat and lock washers that hold down the metal chassis.
6. Carefully lift the monitor chassis out of the front opening of the game cabinet (see **WARNING**).

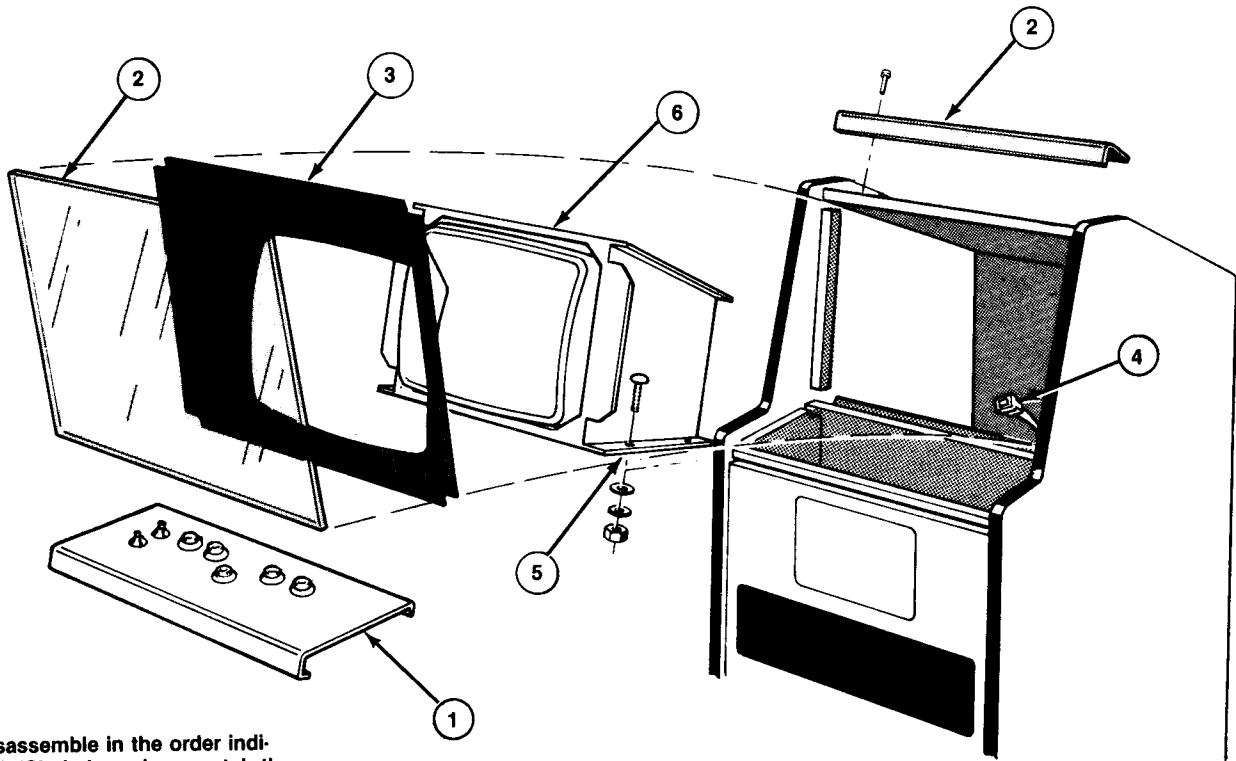

Disassemble in the order indicated. (Circled numbers match the steps above.)

Figure 11 Monitor Removal

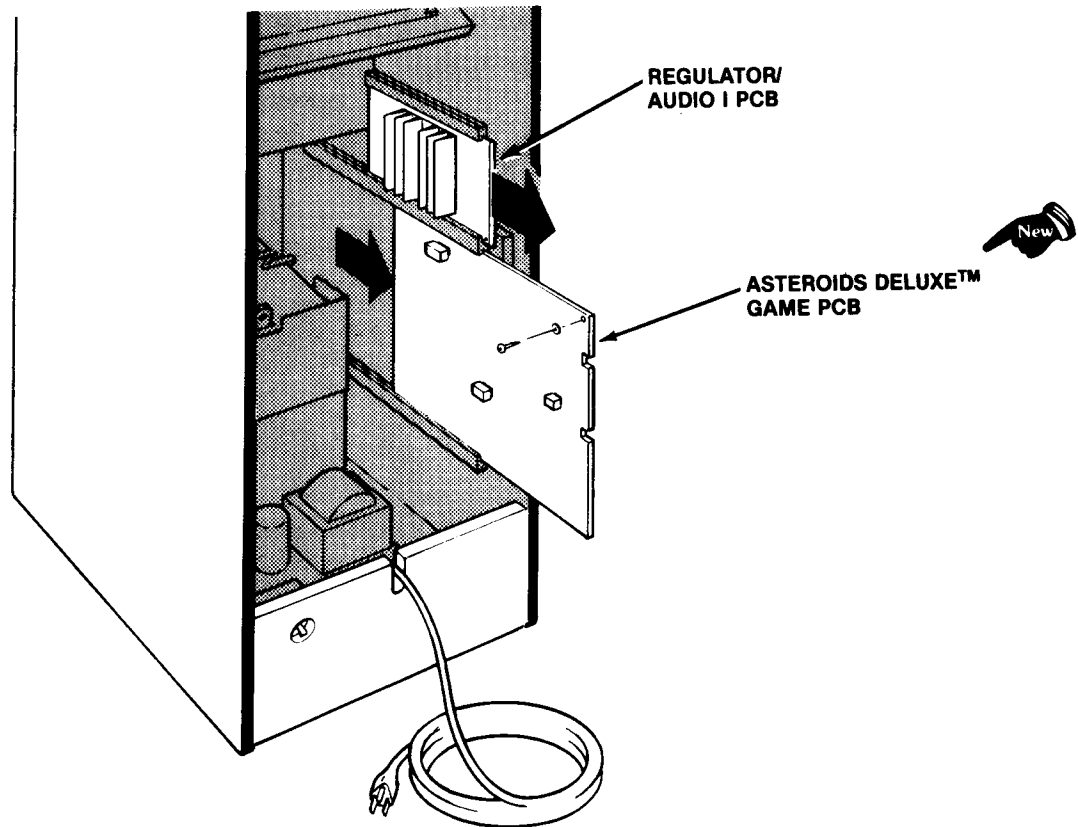

Figure 12 Printed-Circuit Board Removal

E. Printed-Circuit Board Removal

You may wish to remove the game printed-circuit board (PCB) or the Regulator/Audio I PCB for service or inspection. To do this, refer to Figure 12 and proceed as follows:

1. Unlock and open the rear access panel.
2. Remove the securing screw that holds down the PCB in its slots.
3. If you are removing the game PCB, first remove the two tie-wraps that fasten the edge connector to the game PCB. Then unplug the edge connector on the game PCB. If you are removing the Regulator/Audio I PCB, simply disconnect the three small harness connectors on this PCB.
4. Carefully slide either PCB straight out of its grey plastic slots. Be careful not to twist the PCB, as this may loosen connections or components. Replace or repair as required.
5. Reinstall the PCB, making sure that the connectors are properly plugged in. Note that all connectors are keyed to fit on only one way, so if they don't slip on easily, don't force them! **A reversed connector will probably damage your PCB and will void the warranty.**
6. Replace the securing screw in the PCB. Reinstall the tie-wraps used to secure the edge connector to the game PCB. Close and lock the rear access panel.
7. Check that the operation of the game is correct by **performing the self-test**. This is especially important with any game when you replace a PCB. Normally the **only** adjustments on this game are option switch changes (made on the 4- or 8-toggle switches). Unless you are a qualified technician, **do not turn any of the knobs near the game PCB's edge connector. Also do not turn the small knob on the Regulator/Audio I PCB.**

F. Fluorescent Tube Replacement

⚠ WARNING ⚠

If you drop a fluorescent tube and it breaks **it will implode!** Shattered glass can fly 6 feet or more from the implosion. Use care when replacing any fluorescent tube.

To replace the white fluorescent tube behind the front graphics attraction panel, follow this procedure (see Figure 13).

1. Be sure the game is unplugged from its wall outlet. Open the coin door. Remove the two Y-shaped connectors from the ends of the fluorescent tube. Now carefully remove the tube from its clamps by pulling it towards you.
2. Replace with a new tube. Do not snap the tube in vigorously—you may break it, causing an **implosion!**
3. Close the coin door and lock it.

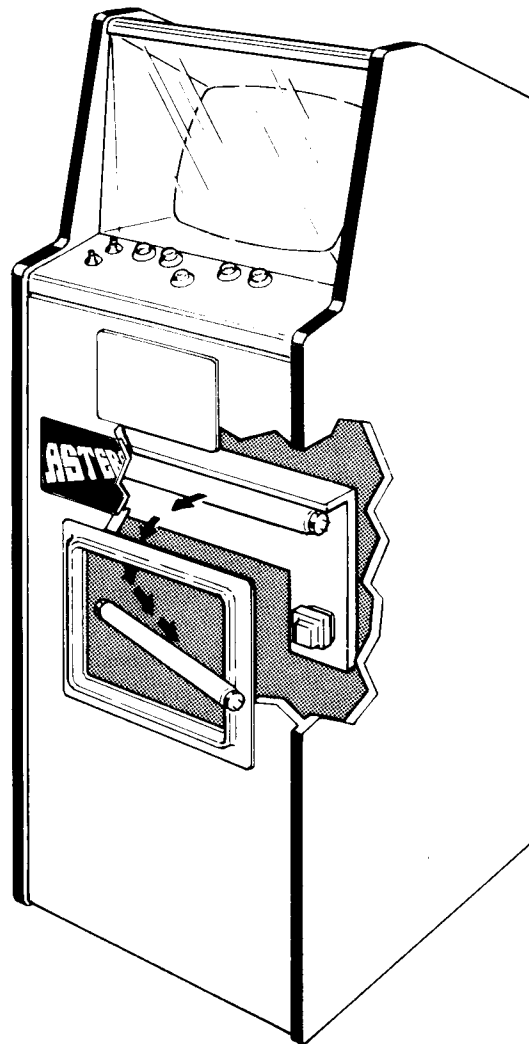

Figure 13 Fluorescent Tube Replacement

G. Game Operation

With this manual you received two large sheets that contain the wiring and schematic diagrams for the Asteroids Deluxe™/Cabaret game. Sheet 1, Side A, includes information that shows the arrangement of these diagrams. These diagrams include information that explains the functions of the circuits and defines inputs and outputs.

Atari's Asteroids Deluxe™ is a microprocessor-controlled game. The microprocessor is mounted on the game PCB. The game PCB receives switch inputs from the control panel and coin door. These inputs are processed by the game PCB and output to the monitor, Regulator/Audio I PCB, and control panel.

The monitor is an X-Y monitor. Therefore, the monitor receives signals for the X, Y and Z axes. Since the location of the beam in the monitor is totally controlled by the X- and Y-axis outputs of the game PCB, the game PCB does not contain a standard sync circuit. The X- and Y-axis inputs to the

monitor step in increments of 1024 steps for the X (horizontal) axis, and 768 steps for the Y (vertical) axis. The Z axis merely controls the intensity of the beam.

The Regulator/Audio I PCB performs two functions: 1) it regulates the + 10.3 VDC from the power supply to + 5 VDC, and 2) it amplifies the audio output from the game PCB. The + 5 VDC from the Regulator/Audio I PCB provides most logic power to the game PCB. The audio output from the Regulator/Audio I PCB directly drives the game speaker and is controlled by the volume control, mounted on the bracket inside the coin door.

The power supply is the source of all voltages in the game. These voltages are protected by four fuses (F3 thru F6) in the fuse block on the power supply chassis. The primary winding of the power supply transformer is protected by the cartridge-type fuse F1 in the power supply chassis.

Figure 14 illustrates the distribution of power in this game. Figure 15 illustrates the distribution of signals.

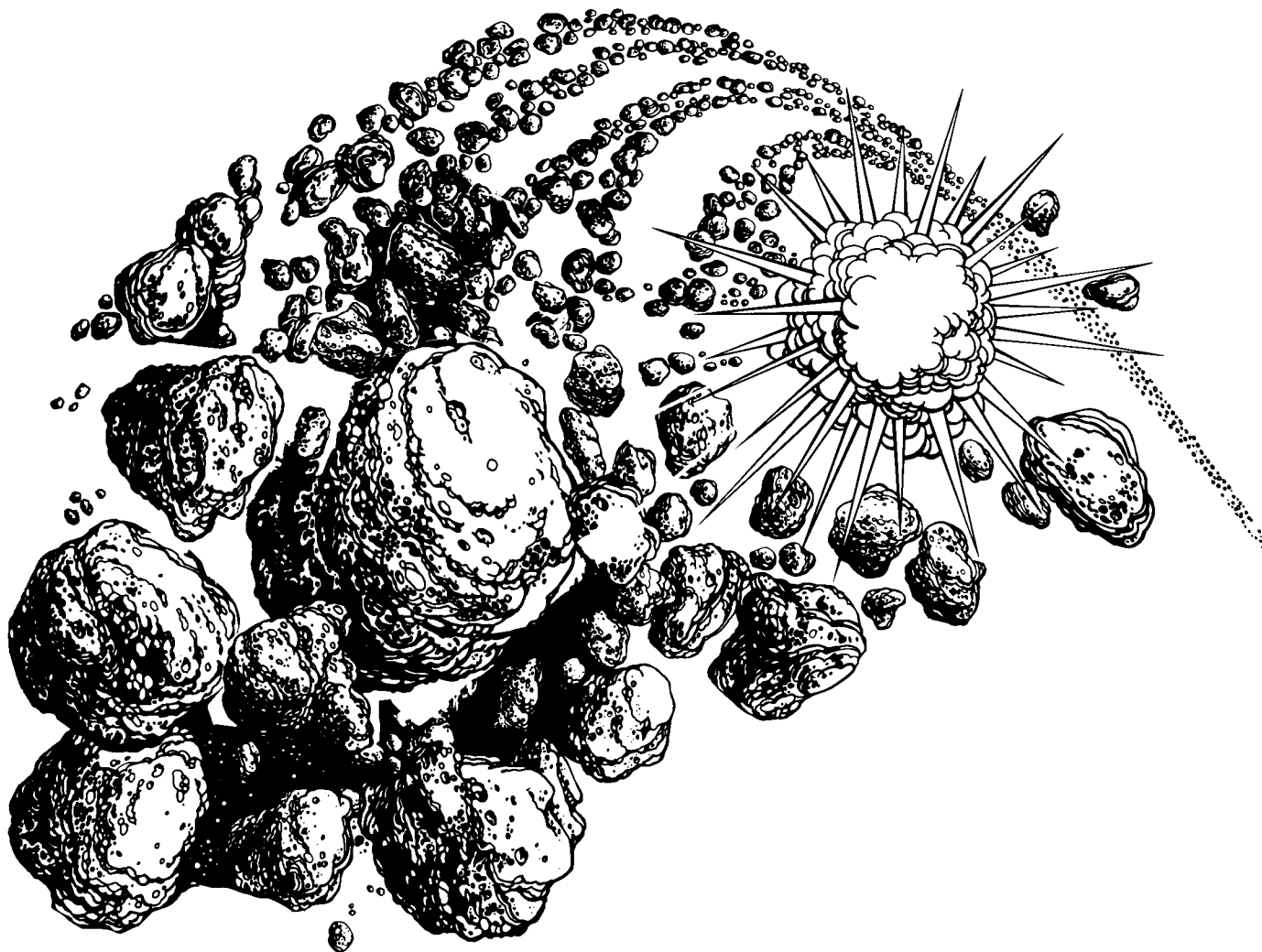

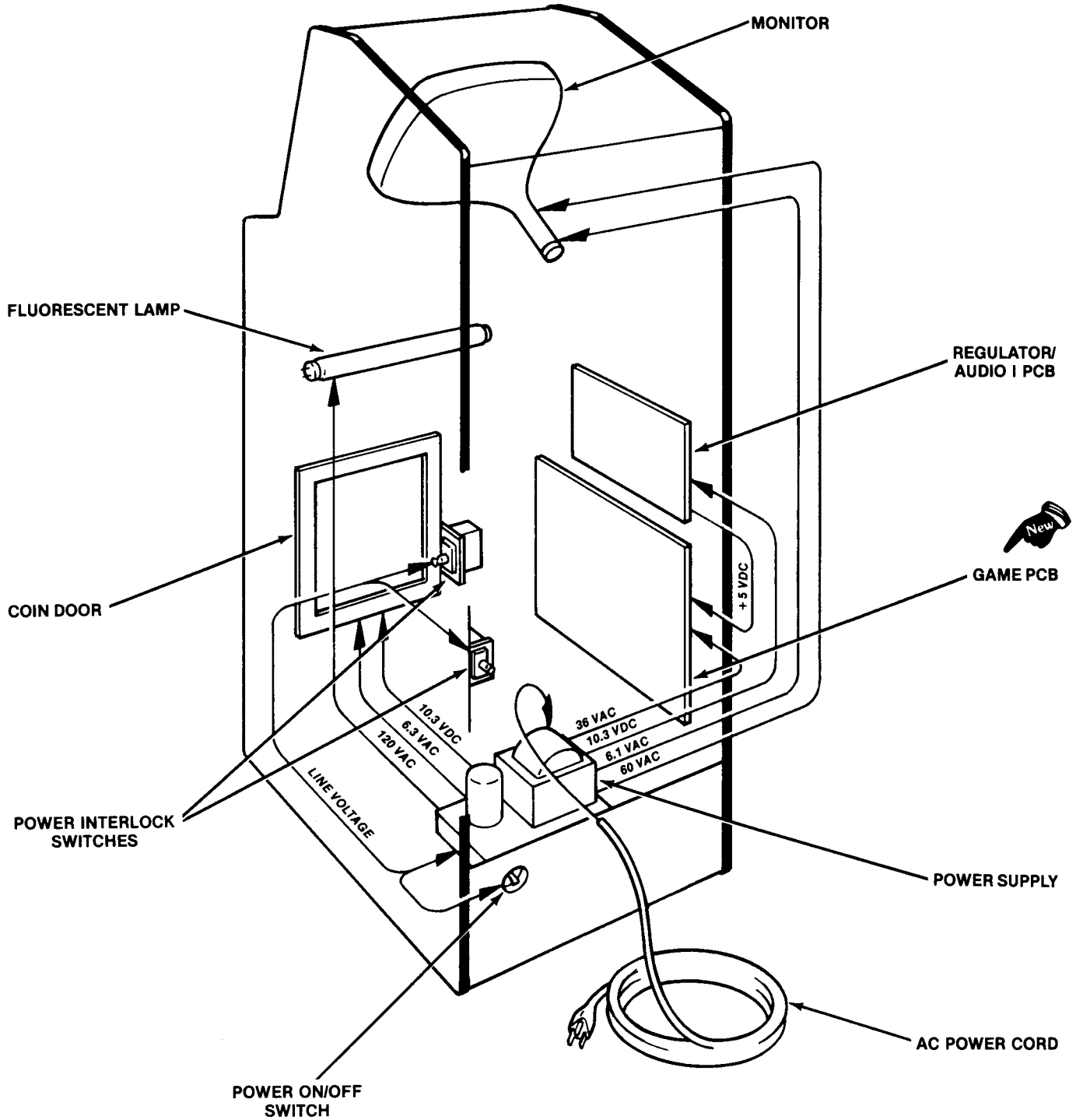

Figure 14 Power Distribution

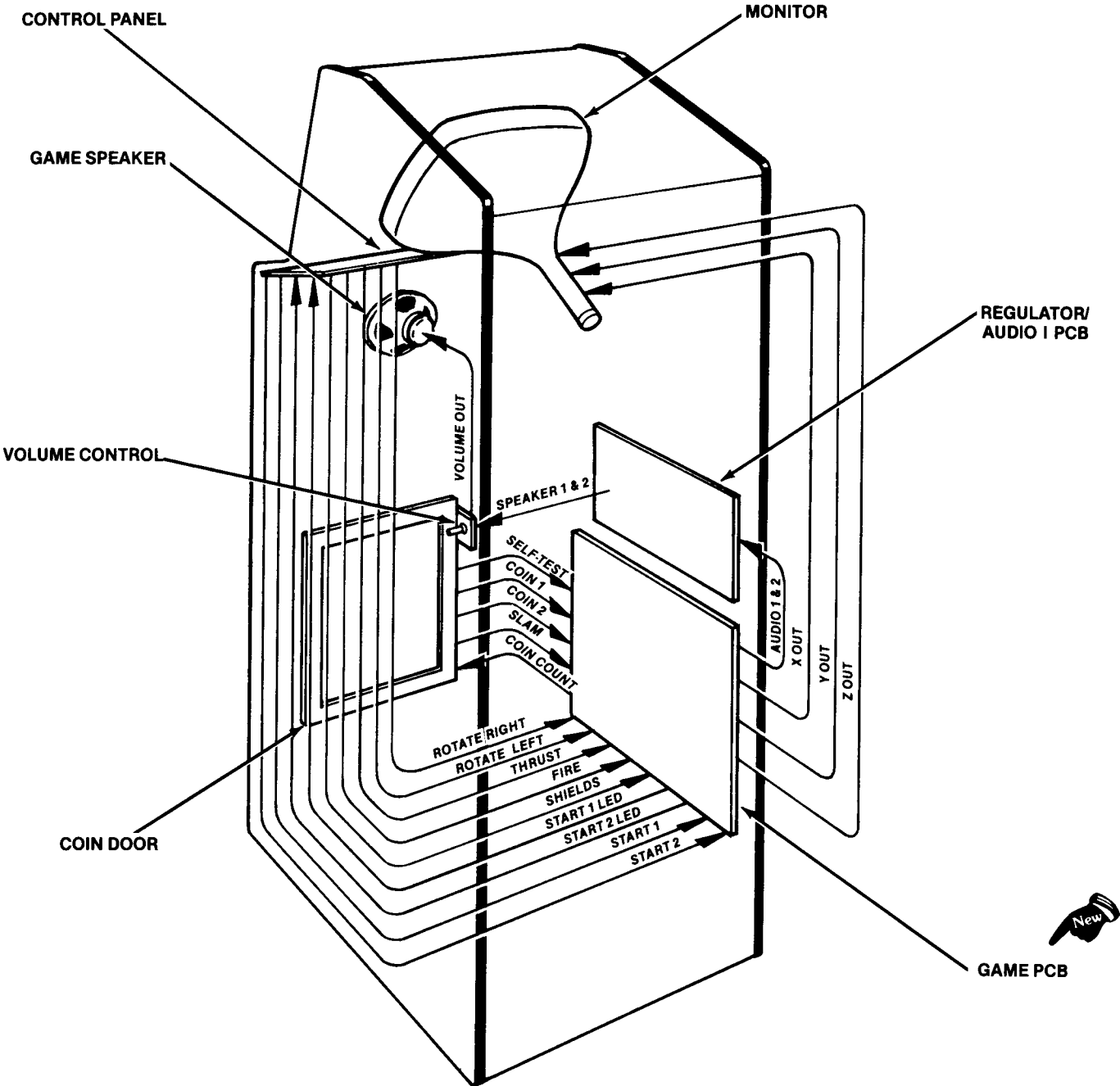

Figure 15 Signal Distribution



Illustrated Parts Lists

This chapter provides you with the necessary information for ordering replacement parts for your Asteroids Deluxe™/Cabaret game. Please note that, for simplicity, **common hardware has been deleted** from most of these parts lists. This includes screws, nuts, washers, bolts, etc.

The parts lists are arranged in alphanumeric order. For example, all "A-" prefix numbers come first. Following this are numbers in sequence evaluated up to the hyphen, namely 00- thru 99-, then 000598- thru approximately 190000-.

When ordering parts from your distributor, give the part number, part name, applicable figure number of this manual, and serial number of your game. This will help to avoid confusion and mistakes in your order. We hope the results will be less downtime and more profit from your game.

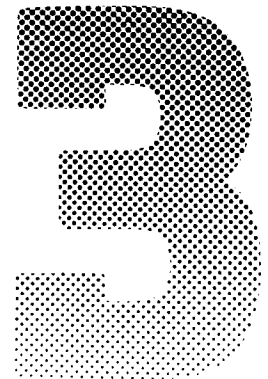

Schematics, Self-Test Label & Manuals—
see parts list on following page

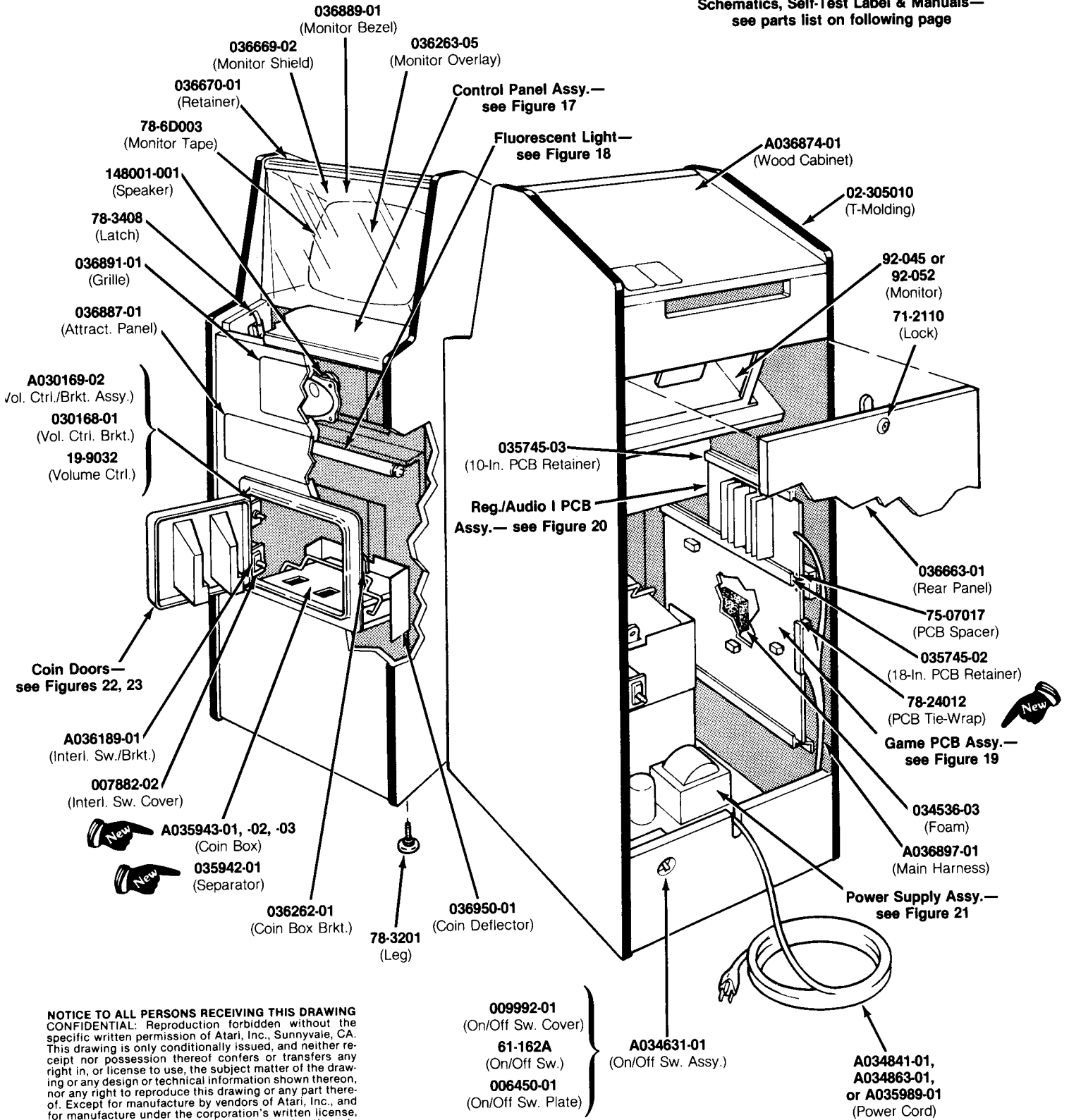

NOTICE TO ALL PERSONS RECEIVING THIS DRAWING
CONFIDENTIAL: Reproduction forbidden without the specific written permission of Atari, Inc., Sunnyvale, CA. This drawing is only conditionally issued, and neither receipt nor possession thereof confers or transfers any right in, or license to use, the subject matter of the drawing or any design or technical information shown thereon, nor any right to reproduce this drawing or any part thereof. Except for manufacture by vendors of Atari, Inc., and for manufacture under the corporation's written license, no right to reproduce this drawing is granted or the subject matter thereof unless by written agreement with or written permission from the corporation.

Figure 16 Cabinet-Mounted Assemblies
A036873-xx A

Figure 16 Cabinet-Mounted Assemblies, continued Parts List

Part No.	Description
A030169-02	Volume Control/Bracket Assembly
A034631-01	Power On/Off Switch Assembly
A034841-01	U.S. Strain-Relief Power Cord
A034863-01	German Strain-Relief Power Cord
A035943-01	Deep-Well Coin Box Assembly <i>(for all the same coins)</i>
A035943-02	Deep-Well Coin Box Assembly <i>(for two different coin denominations—has one separator)</i>
A035943-03	Deep-Well Coin Box Assembly <i>(for three different coin denominations—has two separators)</i>
A035989-01	Australian Strain-Relief Power Cord
A036189-01	Interlock Switch/Bracket Assembly <i>(modified for safety)</i>
A036897-01	Main Harness Assembly
A036874-01	Wood Cabinet Assembly <i>(includes legs and PCB retainers)</i>
<i>The following six items are the technical information supplements to this game:</i>	
DP-173-01	Asteroids Deluxe™/Cabaret Schematic Drawings <i>(Sheet 1)</i>
DP-173-02	Asteroids Deluxe/Cabaret Schematic Drawings <i>(Sheet 2)</i>
ST-173	Label with Self-Test Procedure and Option Switch Settings
TM-151	Instruction and Service Manual for Electrohome G05-802/805 Quadrascan™ X-Y Monitor
TM-164	Service Manual for Wells-Gardner 15- and 19-Inch Quadrascan™ X-Y Monitors
TM-173	Asteroids Deluxe/Cabaret Operation, Maintenance and Service Manual
02-305010	¾-Inch Black Plastic T-Molding
19-9032	50-Ohm, 12½-Watt, Wirewound Rheostat <i>(volume control)</i>
61-162A	DPST Power On/Off Toggle Switch
71-2110	Panel Cartridge Lock Mechanism <i>(for rear access panel)</i>
75-07017	Spacer for Mounting Printed-Circuit Boards
78-24012	5-Inch Beaded Nylon Tie-Wrap <i>(for Game PCB edge connector)</i>
78-3201	Cabinet-Leveling Leg
78-3408	Spring Draw Latch
78-6D003	½-Wide Adhesive Transfer Tape <i>(2 × 9 inches required for monitor)</i>
92-045 or	Electrohome 15-Inch Quadrascan™ X-Y Monitor, or
92-052	Wells-Gardner 15-Inch Quadrascan™ X-Y Monitor
006450-01	On/Off Switch Mounting Plate
007882-02	Interlock Switch Cover
009992-01	On/Off Switch Cover
030168-01	Volume Control Mounting Bracket
034536-03	Foam Vibration Damper <i>(for both PCBs)</i>
035745-02	18-Inch Plastic PCB Retainer
035745-03	10-Inch Plastic PCB Retainer
035942-01	Deep-Well Coin Box Separator
036262-01	Coin Box Bracket
036263-05	Blue Monitor Overlay
036663-01	Rear Access Panel <i>(does not include lock)</i>
036669-02	Smoke-Color Monitor Shield
036670-01	Metal Retainer for Monitor Shield
036686-01	Sheet of Game Pricing Labels
036887-01	Attraction Panel with Graphics
036889-01	Cardboard Monitor Bezel
036891-01	Speaker Grille
036950-01	Cardboard Coin Deflector
148001-001	6 × 9-Inch 4-Ohm 15-Watt Oval High-Fidelity Speaker

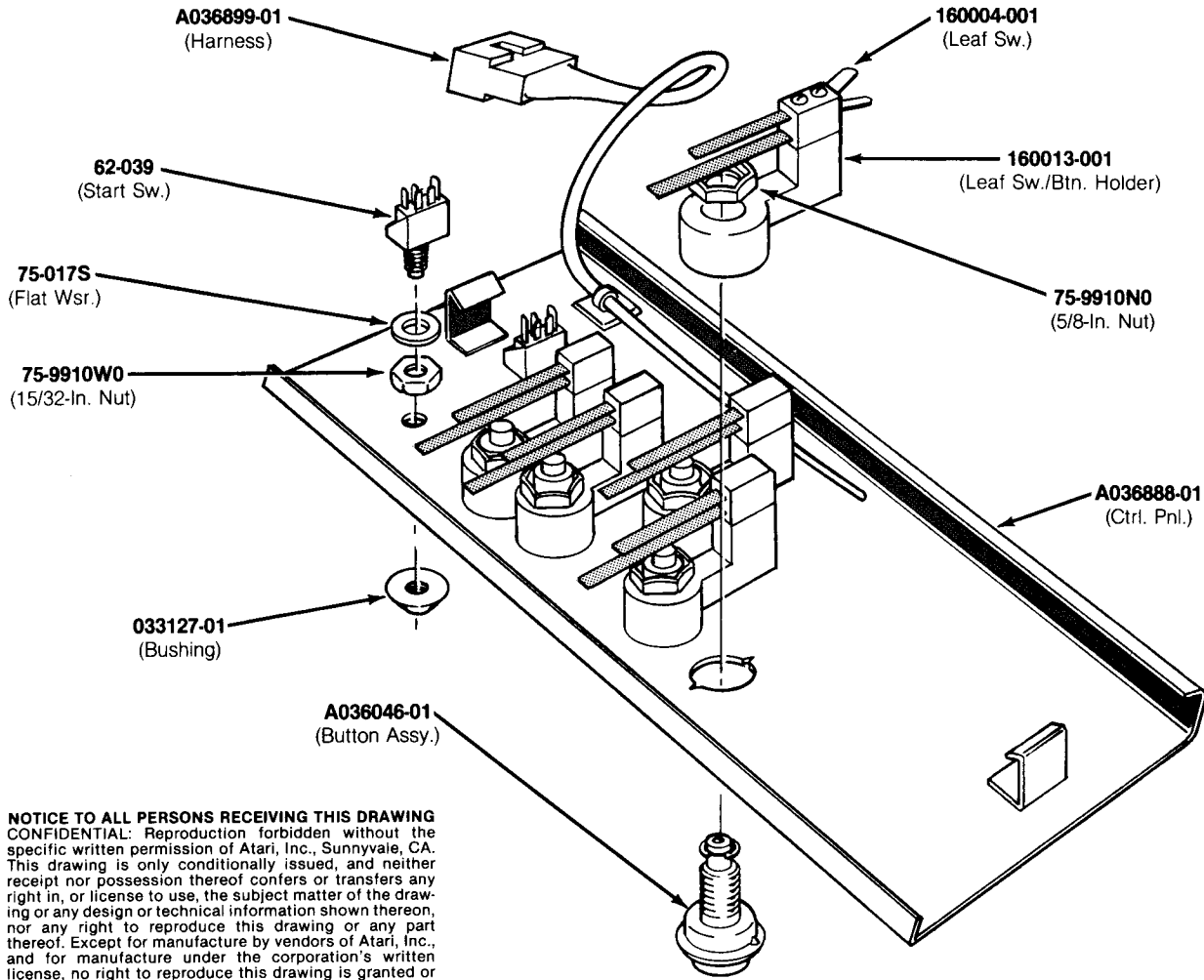

NOTICE TO ALL PERSONS RECEIVING THIS DRAWING
CONFIDENTIAL: Reproduction forbidden without the specific written permission of Atari, Inc., Sunnyvale, CA. This drawing is only conditionally issued, and neither receipt nor possession thereof confers or transfers any right in, or license to use, the subject matter of the drawing or any design or technical information shown thereon, nor any right to reproduce this drawing or any part thereof. Except for manufacture by vendors of Atari, Inc., and for manufacture under the corporation's written license, no right to reproduce this drawing is granted or the subject matter thereof unless by written agreement with or written permission from the corporation.

**Figure 17 Control Panel Assembly
A036878-01 C**

Parts List

<i>Part No.</i>	<i>Description</i>
A036046-01	Button Assembly
A036888-01	Control Panel with Graphics
A036899-01	Control Panel Harness Assembly
62-039	SPDT Momentary Pushbutton Switch, with Red Cap and Light-Emitting Diode
75-017S	7/16-Inch Flat Plain SAE-Standard Zinc-Plated Steel Washer
75-9910N0	5/8-11 Steel Stamped Nut
75-9910W0	15/32-32 Steel Stamped Nut
033127-01	Black Molded Switch Bushing
160013-001	Leaf Switch with Button Holder
160004-001	Leaf Switch Only

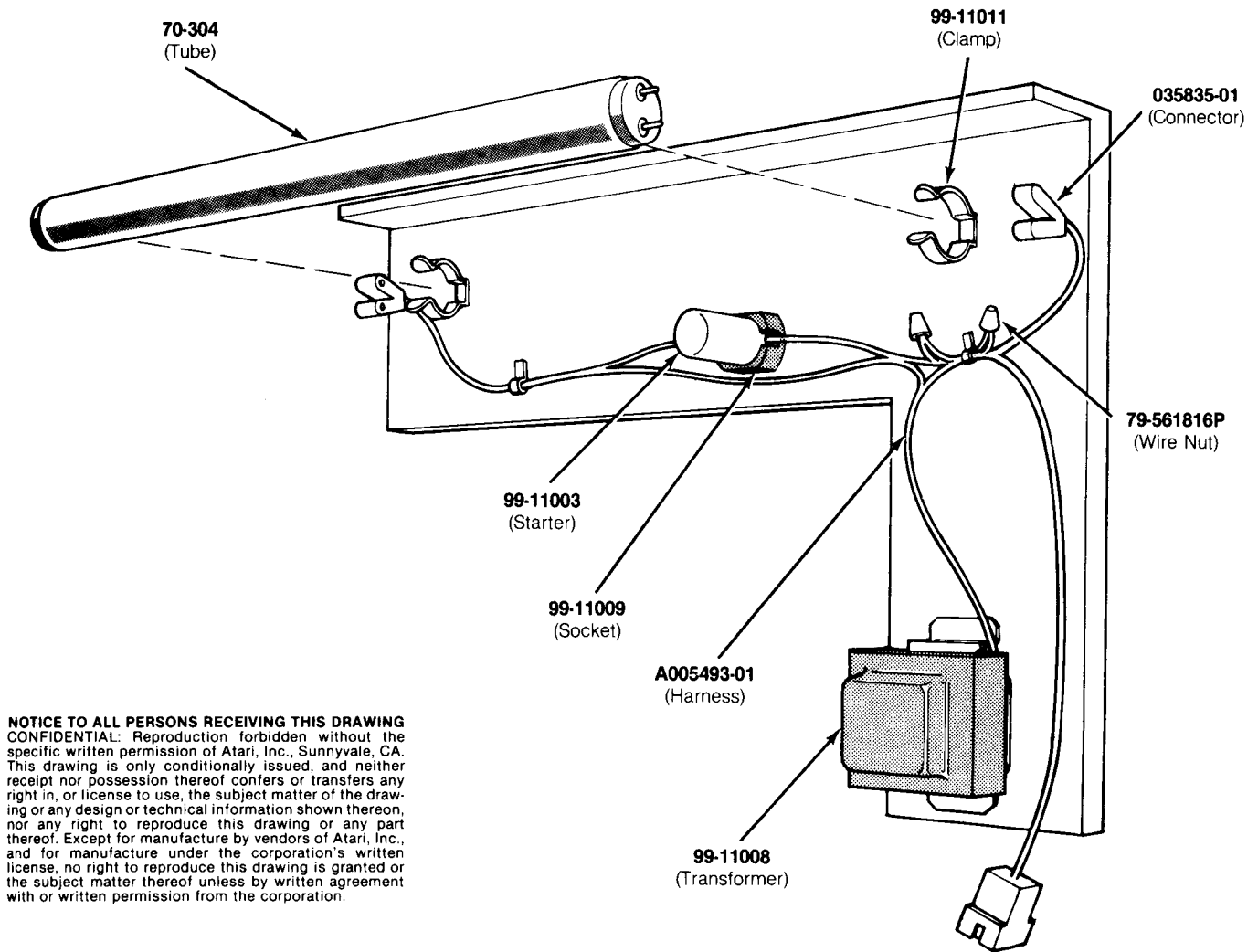
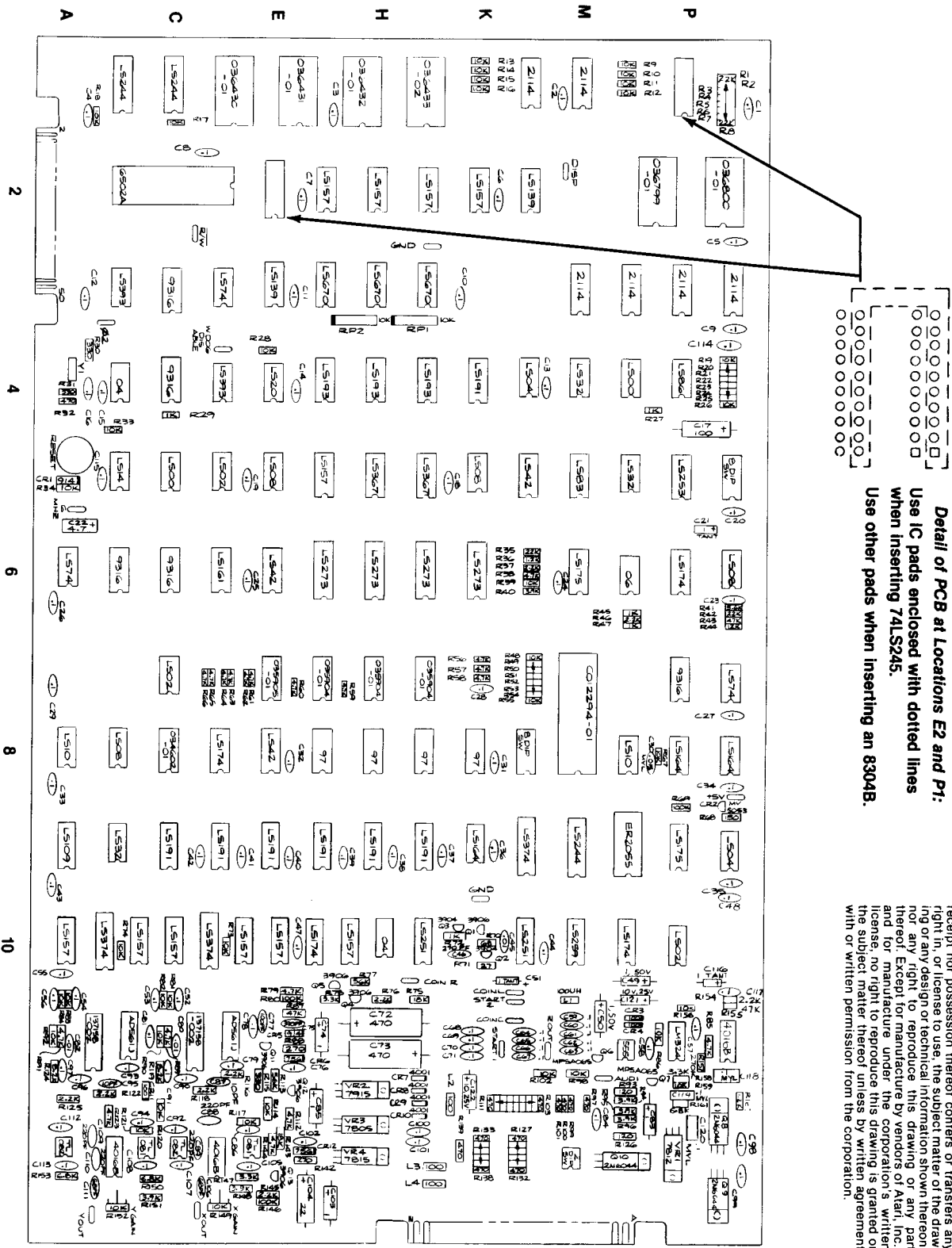

Figure 18 Fluorescent Light Assembly
A036205-01 C

Parts List

<i>Part No.</i>	<i>Description</i>
A005493-01	Fluorescent Light Harness Assembly
70-304	18-Inch 15-Watt Cool White Fluorescent Tube
79-561816P	Wire Nut for 16- to 18-Gauge Wires
99-11003	Fluorescent Lamp Starter
99-11008	Ballast Transformer
99-11009	Starter Socket
99-11011	1½-Inch Clamp
035835-01	Y-Lead Connector



NOTICE TO ALL PERSONS RECEIVING THIS DRAWING
 CONFIDENTIAL. Reproduction forbidden without the specific written permission of Atari, Inc., Sunnyvale, CA. This drawing is only conditionally issued, and neither receipt nor possession thereof confers or transfers any right in, or license to use, the subject matter of the drawing or any design or technical information shown thereon, nor any right to reproduce this drawing or any part thereof. Except for manufacture by vendors of Atari, Inc., and for manufacture under the corporation's written license, no right to reproduce this drawing is granted or the subject matter thereof unless by written agreement with or written permission from the corporation.

Figure 19 Asteroids Deluxe™ Game PCB Assembly A036471-01 and -02 C

Figure 19 Asteroids Deluxe™ Game PCB Assembly Parts List

Part No.	Description (Reference Designations and Locations in Bold)
C012294-01	Audio I/O N-Channel MOS/LSI Custom Chip (M7/8)
19-007	10K Ohm, ±20%, 1¼W 8-Pin Dual-Inline-Package Resistor Network (RP1, RP2—use only if board has 74LS170s or 74LS670s at locations F3, H3, J3)
19-315103	10K Ohm Vertical PCB-Mounting Cermet Trimpot (R149, 152)
21-101104	.1 uf, ±10%, Radial-Lead Epoxy-Dipped 100V Mylar Capacitor (C118-120)
21-101153	.015 uf, ±10%, Radial-Lead Epoxy-Dipped 100V Mylar Capacitor (C30)
24-250105	1 uf Aluminum Electrolytic Fixed Axial-Lead 50V Capacitor (C49, 50, 74, 83, 85, 103)
24-250106	10 uf Aluminum Electrolytic Fixed Axial-Lead 25V Capacitor (C121, 122)
24-250107	100 uf Aluminum Electrolytic Fixed Axial-Lead 25V Capacitor (C17)
24-250226	22 uf Aluminum Electrolytic Fixed Axial-Lead 25V Capacitor (C104)
24-250477	470 uf Aluminum Electrolytic Fixed Axial-Lead 25V Capacitor (C72, 73)
24-500475	4.7 uf Aluminum Electrolytic Fixed Axial-Lead 50V Capacitor (C22)
28-101100	10 pf Epoxy-Dipped 100V Radial-Lead Mica Capacitor (C87, 95)
28-101101	100 pf Epoxy-Dipped 100V Radial-Lead Mica Capacitor (C77)
28-101100	220 pf Epoxy-Dipped 100V Radial-Lead Mica Capacitor (C88, 89, 109, 110)
28-101271	270 pf Epoxy-Dipped 100V Radial-Lead Mica Capacitor (C46)
28-101391	390 pf Epoxy-Dipped 100V Radial-Lead Mica Capacitor (C75)
28-101680	68 pf Epoxy-Dipped 100V Radial-Lead Mica Capacitor (C106, 111)
29-006	1 uf, ±10%, 35V Tantalum Capacitor (C21, 51, 116)
29-088	.1 uf Ceramic-Disc 25V Radial-Lead Capacitor (C1-16, 18-20, 23-29, 31-44, 47, 48, 52-71, 76, 84, 86, 90-92, 94, 96-102, 105, 107, 108, 112-115, 117)
31-1N100	100V Type 1N100 Germanium Switching Diode (CR3, 4, 11)
31-1N914	75V Type 1N914 Silicon Switching Diode (CR1, 5)
31-1N4001	50V Type 1N4001 Silicon Rectifier Diode (CR7-10)
32-1N756A	8.2V, ±5%, Type 1N756A Zener Diode (CR6, 12)
33-2N3906	Type 2N3906 PNP Switching and Amplifying Transistor (Q1, 4, 5, 11-13)
34-2N3904	Type 2N3904 NPN 60V 1-Watt Transistor (Q2, 3)
34-2N6044	Type 2N6044 NPN Darlington Transistor (Q8-10)
34-MPSA06S	Type MPSA06S NPN 80V 500ma Transistor (Q6, 7)
37-LM324	Type LM324 Integrated Circuit (P11)
37-TL082CP	Type TL082CP Integrated Circuit (A12, C12)
37-4016B	Type 4016B Integrated Circuit (R11, B12, D12)
37-555	Type 555 Timer Integrated Circuit (N11)
37-74LS00	Type 74LS00 Integrated Circuit (C5, N4)
37-74LS02	Type 74LS02 Integrated Circuit (D5, P10. Also, for -02 PCB assy. only: C7)
37-74LS04	Type 74LS04 Integrated Circuit (L4, R9)
37-74LS08	Type 74LS08 Integrated Circuit (E5, K5, R6, B8)
37-74LS10	Type 74LS10 Integrated Circuit (A8, N8)
37-74LS14	Type 74LS14 Integrated Circuit (B5)
37-74LS20	Type 74LS20 Integrated Circuit (E4)
37-74LS32	Type 74LS32 Integrated Circuit (M4, N5, B9)
37-74LS42	Type 74LS42 Integrated Circuit (L5, E6, E8)
37-74LS74	Type 74LS74 Integrated Circuit (D3, A6, R7)
37-74LS83	Type 74LS83 Integrated Circuit (M5)
37-74LS86	Type 74LS86 Integrated Circuit (P4)
37-74LS109	Type 74LS109 Integrated Circuit (A9)
37-74LS139	Type 74LS139 Integrated Circuit (L2, E3)

[Continued on next page]

Figure 19 Asteroids Deluxe™ Game PCB Assembly, continued Parts List

Part No.	Description (Reference Designations and Locations in Bold)
37-74LS157	Type 74LS157 Integrated Circuit (F2, H2, J2, K2, F5, A10, B/C10, C10, D/E10, E10, F/H10)
37-74LS161	Type 74LS161 Integrated Circuit (D6)
37-74LS164	Type 74LS164 Integrated Circuit (P8, R8, K9)
37-74LS174	Type 74LS174 Integrated Circuit (P6, D8, F10, N10)
37-74LS175	Type 74LS175 Integrated Circuit (M6, P9)
37-74LS191	Type 74LS191 Integrated Circuit (K4, C9, D9, E9, F9, H9, J9)
37-74LS193	Type 74LS193 Integrated Circuit (F4, H4, J4)
37-74LS244	Type 74LS244 Integrated Circuit (B1, C1, M9)
37-74LS245	Type 74LS245 Integrated Circuit (P1, E2) <i>Acceptable substitute is part no. 37-8304B</i>
37-74LS251	Type 74LS251 Integrated Circuit (J10, L10)
37-74LS253	Type 74LS253 Integrated Circuit (P5)
37-74LS259	Type 74LS259 Integrated Circuit (M10)
37-74LS273	Type 74LS273 Integrated Circuit (F6, H6, J6, K6)
37-74LS367	Type 74LS367 Integrated Circuit (H5, J5)
37-74LS393	Type 74LS393 Integrated Circuit (B3, D4)
37-74LS374	Type 74LS374 Integrated Circuit (L9, B10, D10) <i>Acceptable substitute is part no. 37-74LS273</i>
37-74LS670	Type 74LS670 Integrated Circuit (F3, H3, J3) <i>Acceptable substitute is part no. 37-74LS170</i>
37-7404	Type 7404 Integrated Circuit (B4, H10)
37-7406	Type 7406 Integrated Circuit (N6)
37-7497	Type 7497 Integrated Circuit (<i>For -01 PCB assy. only:</i> F8, H8, J8, K8)
37-7805	+ 5V Voltage Regulator (VR3)
37-7812	+ 12V Voltage Regulator (VR1)
37-7815	+ 15V Voltage Regulator (VR4)
37-7915	- 15V Voltage Regulator (VR2)
37-9316	Type 9316 Integrated Circuit (C3, C4, B6, C6, P7)
38-MV5053	Type MV5053 Light-Emitting Diode (CR2)
41-3003	100 uH, ± 10%, Hot-Molded Plastic Fixed R.F. Choke (L1-4)
62-001	SPST Momentary Pushbutton Switch (A5)
66-114P1T	4-Station Single-Throw, Dual-Inline-Package Bit Switch (M12)
66-118P1T	8-Station Single-Throw, Dual-Inline-Package Bit Switch (R5, L8)
79-42C24	24-Contact Medium-Insertion-Force Integrated Circuit Socket (D1, E/F1, H1, J1, N/P2, R2)
79-42C40	40-Contact Medium-Insertion-Force Integrated Circuit Socket (C2, M7/8)
81-4302	Nylon Snap-In Fastener (VR1-4, Q8-10)
90-102	12.096 MHz, ± .005%, Crystal (Y1)
90-6013	Microprocessor (C2)
90-7033	Random-Access Memory (L1, M1, M3, N3, P3, R3)
020670-01	Test Point
034602-01	Programmable Read-Only Memory (C8)
035904-01	Type 82S131 Integrated Circuit (<i>For -02 PCB assy. only:</i> F7, H7, J7)
035905-01	Type 82S131 Integrated Circuit (<i>For -02 PCB assy. only:</i> E7)
036430-01	Read-Only Memory (D1)
036431-01	Read-Only Memory (E/F1)
036432-01	Read-Only Memory (H1)
036433-02	Read-Only Memory (J1)

Figure 19 Asteroids Deluxe™ Game PCB Assembly, continued Parts List

Part No.	Description (Reference Designations and Locations in Bold)
036799-01	Read-Only Memory (N/P2)
036800-01	Read-Only Memory (R2)
100015-103	.1 uf Ceramic-Disc 25V Radial-Lead Capacitor (C45, 80, 82)
110000-102	1K Ohm, $\pm 5\%$, 1/4W Resistor (R27, 29, 45, 47, 72)
110000-103	10K Ohm, $\pm 5\%$, 1/4W Resistor (R9-26, 28, 33, 34, 39, 48-55, 67, 73, 74, 81-84, 86, 90, 92, 98, 102, 114, 117, 120, 121, 156, 159)
110000-104	100K Ohm, $\pm 5\%$, 1/4W Resistor (R69, 80, 146)
110000-121	120 Ohm, $\pm 5\%$, 1/4W Resistor (R93, 126)
110000-122	1.2K Ohm, $\pm 5\%$, 1/4W Resistor (R36, 160)
110000-123	12K Ohm, $\pm 5\%$, 1/4W Resistor (R44)
110000-151	150 Ohm, $\pm 5\%$, 1/4W Resistor (R68)
110000-183	18K Ohm, $\pm 5\%$, 1/4W Resistor (R75, 143)
110000-222	2.2K Ohm, $\pm 5\%$, 1/4W Resistor (R37, 46, 76, 116, 125, 145, 154)
110000-223	22K Ohm, $\pm 5\%$, 1/4W Resistor (R1-8, 35, 42)
110000-270	27 Ohm, $\pm 5\%$, 1/4W Resistor (R71)
110000-271	270 Ohm, $\pm 5\%$, 1/4W Resistor (R88, 142)
110000-274	270K Ohm, $\pm 5\%$, 1/4W Resistor (R157)
110000-331	330 Ohm, $\pm 5\%$, 1/4W Resistor (R30, 31, 115)
110000-332	3.3K Ohm, $\pm 5\%$, 1/4W Resistor (R78, 147, 158)
110000-392	3.9K Ohm, $\pm 5\%$, 1/4W Resistor (R40, 94-96, 148, 151)
110000-471	470 Ohm, $\pm 5\%$, 1/4W Resistor (R32, 97, 99-101, 103-111, 127-139)
110000-472	4.7K Ohm, $\pm 5\%$, 1/4W Resistor (R38, 79, 85, 89, 91, 112, 123, 144. Also, for -02 PCB assy. only: R56-66)
110000-473	47K Ohm, $\pm 5\%$, 1/4W Resistor (R43, 87, 155)
110000-562	5.6K Ohm, $\pm 5\%$, 1/4W Resistor (R41)
110000-563	56K Ohm, $\pm 5\%$, 1/4W Resistor (R77, 113)
110000-680	68 Ohm, $\pm 5\%$, 1/4W Resistor (R70)
110000-682	6.8K Ohm, $\pm 5\%$, 1/4W Resistor (R150, 153, 161)
110000-822	8.2K Ohm, $\pm 5\%$, 1/4W Resistor (R119, 124)
137108-001	Operational Amplifier Integrated Circuit (B/C12, E12)
137158-002	Type AM6012ADC Digital-to-Analog Converter (A/B11, C/D11) <i>Acceptable substitute is part no. 37-AD561J</i> (B11, D11)
137161-001	Electrically Alterable Read-Only Memory (N9) 

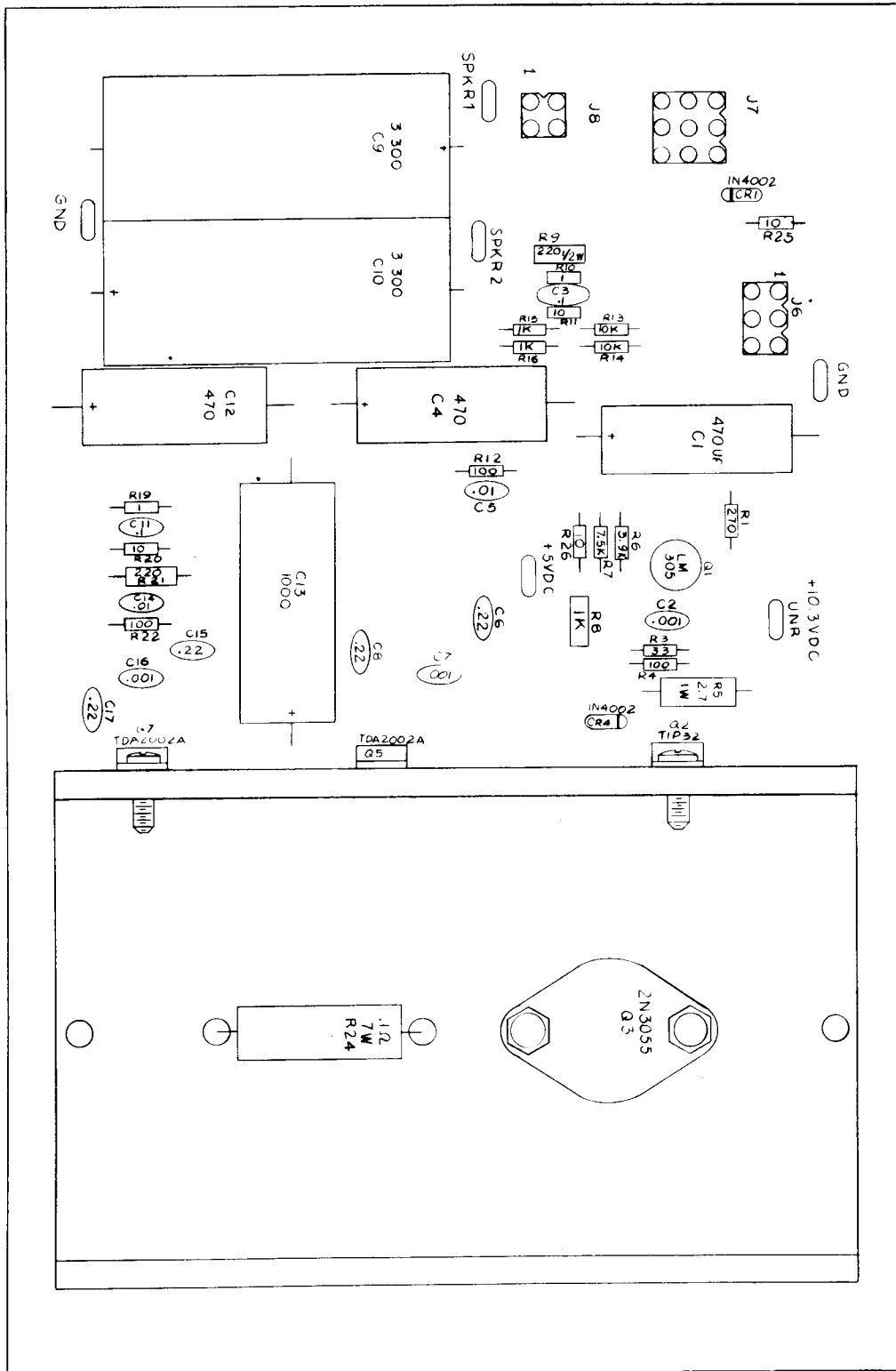

NOTICE TO ALL PERSONS RECEIVING THIS DRAWING
CONFIDENTIAL: Reproduction forbidden without the specific written permission of Atari, Inc., Sunnyvale, CA. This drawing is only conditionally issued, and neither receipt nor possession thereof confers or transfers any right in, or license to use, the subject matter of the drawing or any design or technical information shown thereon, nor any right to reproduce this drawing or any part thereof. Except for manufacture by vendors of Atari, Inc., and for manufacture under the corporation's written license, no right to reproduce this drawing is granted or the subject matter thereof unless by written agreement with or written permission from the corporation.

Figure 20 Regulator/Audio I PCB Assembly
A034485-03 A

Figure 20 Regulator/Audio I PCB Assembly Parts List

Part No.	Description (Reference Designations and Locations in Bold)
12-52P7	2.7 Ohm, \pm 5%, 1W Resistor (R5)
19-100P1015	.1 Ohm, \pm 3%, 7W Wirewound Resistor (R24)
19-315102	1K Ohm Vertical PCB-Mounting Cermet Trimpot (R8)
24-250108	1000 uf Aluminum Electrolytic Fixed Axial-Lead 25V Capacitor (C13)
24-250477	470 uf Aluminum Electrolytic Fixed Axial-Lead 25V Capacitor (C1, 4, 12)
24-350338	3300 uf Aluminum Electrolytic Fixed Axial-Lead 35V Capacitor (C9, 10)
29-088	.1 uf Ceramic-Disc 25V Radial-Lead Capacitor (C3, C11)
31-1N4002	100V 1-Amp. Silicon Rectifier 1N4002 Diode (CR1, 4)
33-TIP32	PNP Power Transistor, Type TIP32 (Q2)
34-2N3055	NPN Silicon Transistor, Type 2N3055 (Q3)
37-LM305	5V Linear Voltage Regulator (Q1)
75-F60405	#6-32 \times 1/4 Inch Binder-Head Nylon Screw
78-16008	Thermally Conductive Compound for the 2N3055
78-16014	Thermally Conductive Compound for the TIP32
79-58306	6-Position Connector Receptacle (J6)
79-58308	9-Position Connector Receptacle (J7)
79-58354	4-Position Square Connector Receptacle (J8)
020670-01	Test Point
034531-01	Heat Sink
100015-103	.01 uf Ceramic-Disc 25V Radial-Lead Capacitor (C5, 14)
110000-010	1 Ohm, \pm 5%, 1/4W Resistor (R10, 19)
110000-100	10 Ohm, \pm 5%, 1/4W Resistor (R11, 20, 25, 26)
110000-101	100 Ohm, \pm 5%, 1/4W Resistor (R4, 12, 22)
110000-102	1K Ohm, \pm 5%, 1/4W Resistor (R15, 16)
110000-103	10K Ohm, \pm 5%, 1/4W Resistor (R13, 14)
110000-271	270 Ohm, \pm 5%, 1/4W Resistor (R1)
110000-330	33 Ohm, \pm 5%, 1/4W Resistor (R3)
110000-392	3.9K Ohm, \pm 5%, 1/4W Resistor (R6)
110000-752	7.5K Ohm, \pm 5%, 1/4W Resistor (R7)
110001-221	220 Ohm, \pm 5%, 1/2W Resistor (R9, 21)
122002-102	.001 uf Ceramic-Disc 25V Radial-Lead Capacitor (C2, 7, 16)
122004-224	.22 uf Ceramic-Disc 25V Radial-Lead Capacitor (C6, 8, 15, 17)
137151-002	8W Linear Audio Amplifier Integrated Circuit (Q5, 7)

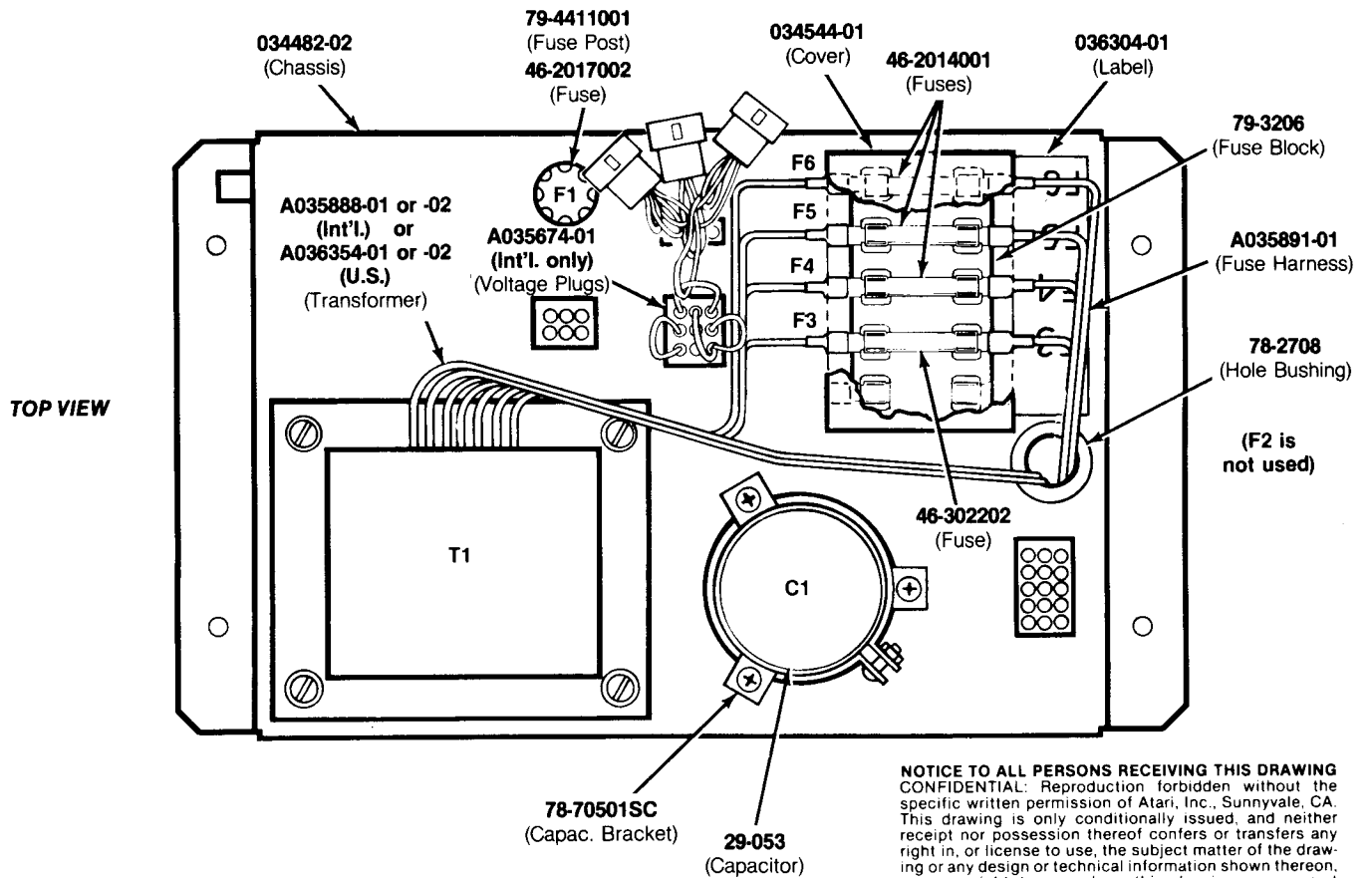

NOTICE TO ALL PERSONS RECEIVING THIS DRAWING CONFIDENTIAL: Reproduction forbidden without the specific written permission of Atari, Inc., Sunnyvale, CA. This drawing is only conditionally issued, and neither receipt nor possession thereof confers or transfers any right in, or license to use, the subject matter of the drawing or any design or technical information shown thereon, nor any right to reproduce this drawing or any part thereof. Except for manufacture by vendors of Atari, Inc., and for manufacture under the corporation's written license, no right to reproduce this drawing is granted or the subject matter thereof unless by written agreement with or written permission from the corporation.

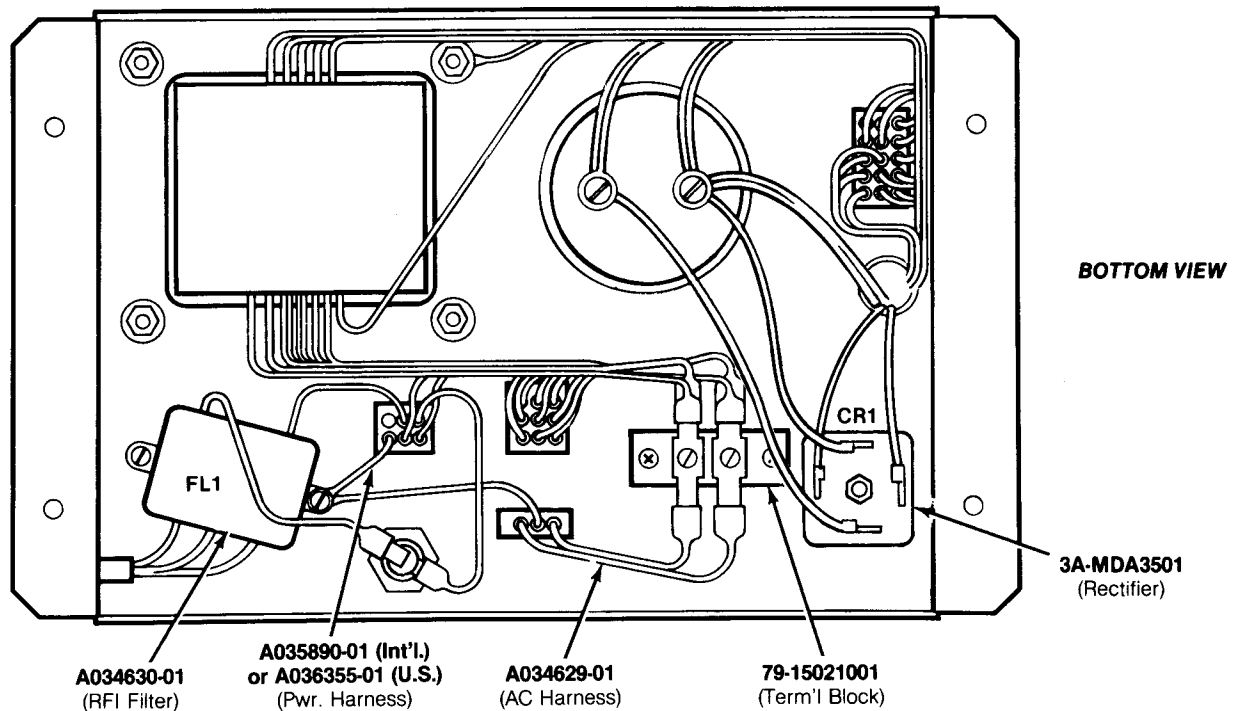
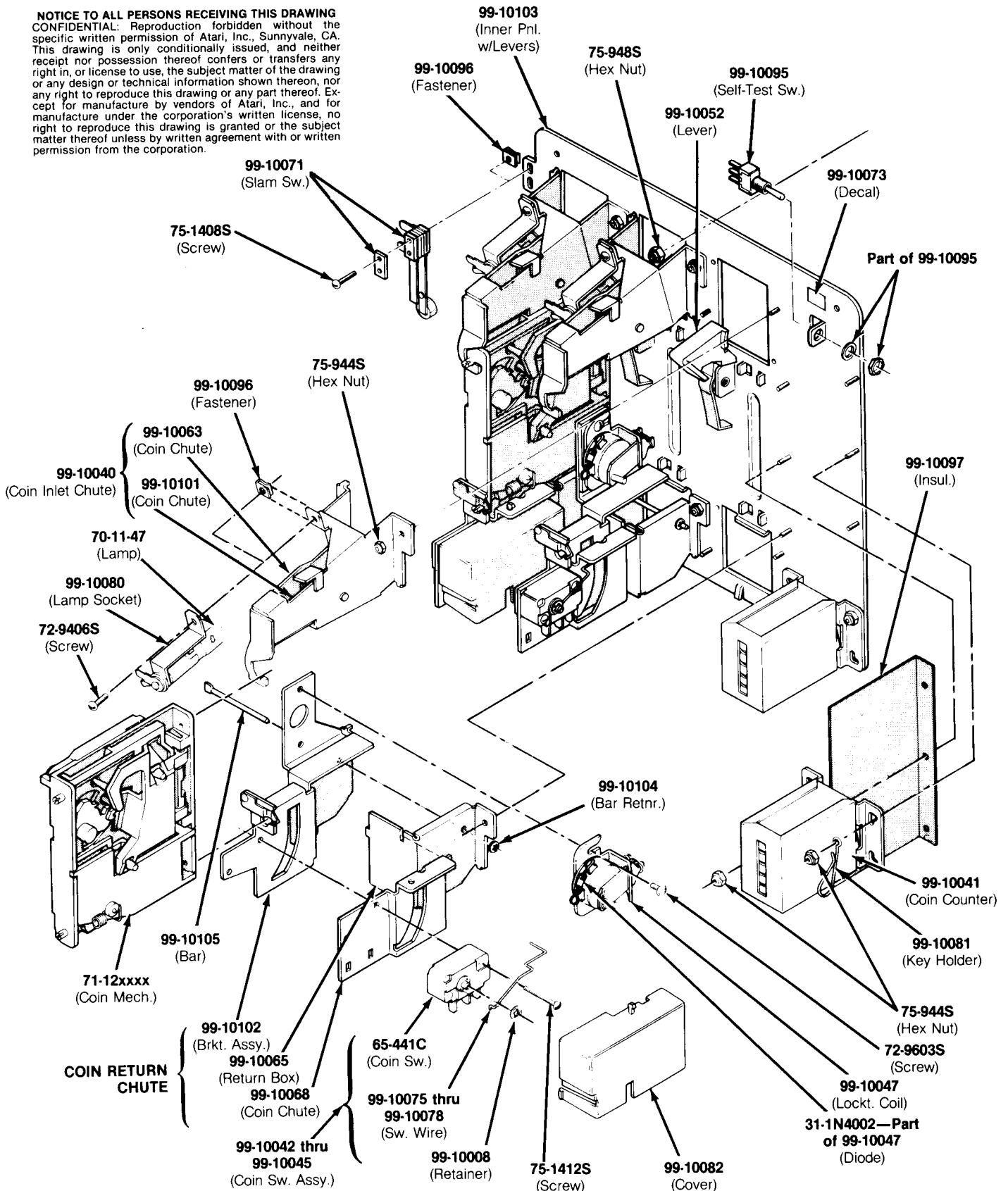

**Figure 21 Power Supply Assemblies for X-Y Games
A035892-01 (International) A / A036353-01 (U.S.) A**

Figure 21 Power Supply Assemblies for X-Y Games Parts List

<i>Part No.</i>	<i>Description (Reference Designations and Locations in Bold)</i>
A034629-01	A.C. Harness Assembly
A034630-01	RFI Filter Assembly (FL1)
A035674-01	Voltage Plug Assembly <i>(set of four plugs—for international power supply only)</i>
A035888-01 or -02	Transformer Assembly— <i>international only</i> (T1)
A035890-01	Power Harness Assembly <i>(international only)</i>
A035891-01	Fuse Harness Assembly
A036354-01 or -02	Transformer Assembly— <i>U.S. only</i> (T1)
A036355-01	Power Harness Assembly <i>(U.S. only)</i>
29-053	26,000 uf 15 VDC Electrolytic Capacitor (C1)
3A-MDA3501	Bridge Rectifier, Type MDA 3501 (CR1)
46-2014001	4-Amp. 125 V 3AG Slow-Blow Glass Cartridge-Type Fuse (F4, F5, F6)
46-2017002	7-Amp. 250 V 3AG Slow-Blow Glass Cartridge-Type Fuse (F1)
46-302202	20-Amp. 250 V 3AB Slow-Blow Ceramic Cartridge-Type Fuse (F3)
78-2708	Nylon Type 6/6 Hole Bushing with 5/8-Inch Inside Diameter × 55/64-Inch Outside Diameter × 1/4-Inch Thick
78-70501SC	2-Inch Diameter Capacitor Mounting Bracket
79-15021001	2-Circuit Single-Row Terminal Block
79-3206	5-Position 3AG Fuse Block with 1/4-Inch Quick-Disconnect Terminals
79-4411001	Panel-Mounting Non-Indicating 3AG Cartridge-Type Fuse Post
034482-02	Power Supply Chassis
034544-01	Fuse Block Cover
036304-01	Label for Fuse Values

NOTICE TO ALL PERSONS RECEIVING THIS DRAWING
CONFIDENTIAL: Reproduction forbidden without the specific written permission of Atari, Inc., Sunnyvale, CA. This drawing is only conditionally issued, and neither receipt nor possession thereof confers or transfers any right in, or license to use, the subject matter of the drawing or any design or technical information shown thereon, nor any right to reproduce this drawing or any part thereof. Except for manufacture by vendors of Atari, Inc., and for manufacture under the corporation's written license, no right to reproduce this drawing is granted or the subject matter thereof unless by written agreement with or written permission from the corporation.



**Figure 22 American-Made Coin Door
 71-10xxxx D**

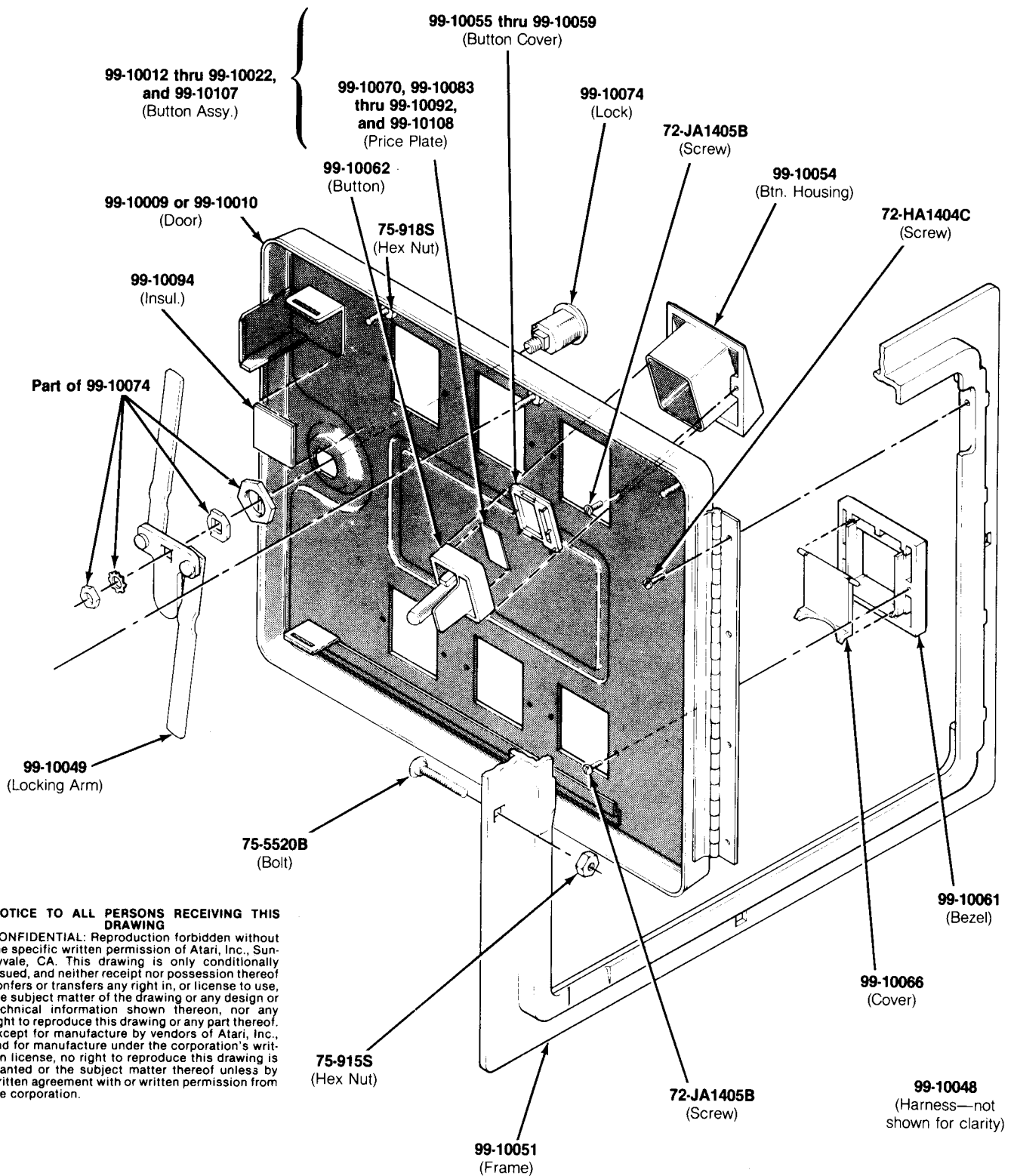

NOTICE TO ALL PERSONS RECEIVING THIS DRAWING
CONFIDENTIAL: Reproduction forbidden without the specific written permission of Atari, Inc., Sunnyvale, CA. This drawing is only conditionally issued, and neither receipt nor possession thereof confers or transfers any right in, or license to use, the subject matter of the drawing or any design or technical information shown thereon, nor any right to reproduce this drawing or any part thereof. Except for manufacture by vendors of Atari, Inc., and for manufacture under the corporation's written license, no right to reproduce this drawing is granted or the subject matter thereof unless by written agreement with or written permission from the corporation.

- 71-102201 — U.S. 25¢/25¢ Coin Door
- 71-103202 — U.S. 25¢/25¢/25¢ Coin Door
- 71-103203 — U.S. 25¢/25¢/\$1 Coin Door
- 71-102204 — German 2 DM/1 DM Coin Door
- 71-103205 — German 1/2/5 DM Coin Door

- 71-102206 — German 1 DM/5 DM Coin Door
- 71-102207 — Belgian 5 Fr/5 Fr Coin Door
- 71-102208 — Swiss 1 Fr/1 Fr Coin Door
- 71-102209 — Japanese 100Y/100Y Coin Door
- 71-102210 — British 10 P/10 P Coin Door

- 71-102211 — Australian 20¢/20¢ Coin Door
- 71-102212 — Italian 100 L/100 L Coin Door
- 71-102213 — U.S. 50¢/50¢ (2 x 25¢) Coin Door
- 71-103214 — U.S. 50¢/50¢/50¢ Coin Door
- 71-103215 — U.S. 50¢/50¢/\$1 Coin Door

**Figure 22 American-Made Coin Door
71-10xxxx D**

Figure 22 American-Made Coin Door, continued Parts List

Part No.	Description
31-1N4002	100V Silicon Rectifier 1N4002 Diode
65-441C	General-Usage Low-Force Miniature Switch
70-11-47	Miniature Bayonet-Base Incandescent Lamp, Type #47
71-1201ADU	U.S. \$1.00 Coin Mechanism
71-1201FCH	Swiss 1 Fr Coin Mechanism
71-1201MG	German 1 DM Coin Mechanism
71-1202MG	German 2 DM Coin Mechanism
71-1205FB	Belgian 5 Fr Coin Mechanism
71-1205MG	German 5 DM Coin Mechanism
71-1210PE	U.K. 10 P Coin Mechanism
71-1220CA	Australian 20¢ Coin Mechanism
71-1225CU	U.S. 25¢ Coin Mechanism
71-12100LI	Italian 100 Lire Coin Mechanism
71-12100YJ	Japanese Y100 Coin Mechanism
72-HA1404C	#4 × ¼-Inch Slotted Pan-Head Thread-Rolling Tri-Fluted "Taptite" Cadmium-Plated Screw
72-JA1405B	#4 × 5/16-Inch Slotted Pan-Head Thread-Rolling Tri-Fluted "Plastite" Black Screw
72-9406S	#4-40 × 3/8-Inch Slotted Truss-Head Steel Machine Screw
72-9603S	#6-32 × 3/16-Inch Slotted Truss-Head Steel Machine Screw
75-915S	#¼-20 Standard-Pattern Cadmium-Plated Steel Hex Nut
75-918S	#8-32 Standard-Pattern Cadmium-Plated Steel Hex Nut
75-944S	#4-40 Polymer Self-Locking Steel Hex Nut
75-948S	#8-32 Polymer Self-Locking Steel Hex Nut
75-1408S	#4-40 × ½-Inch Slotted Pan-Head Steel Machine Screw
75-1412S	#4-40 × ¾-Inch Slotted Pan-Head Steel Machine Screw
75-5520B	#¼-20 × 1¼-Inch Round-Head Square-Neck Steel Bolt with Black Finish
99-10008	Switch Wire Retainer
99-10009	2-Mech Coin Door Only
99-10010	3-Mech Coin Door Only
99-10012	U.S. 25¢ Coin Return Button Assembly
99-10013	U.S. \$1.00 Coin Return Button Assembly
99-10014	German 1 DM Coin Return Button Assembly
99-10015	German 2 DM Coin Return Button Assembly
99-10016	German 5 DM Coin Return Button Assembly
99-10017	Belgian 5 Fr Coin Return Button Assembly
99-10018	Swiss 1 Fr Coin Return Button Assembly
99-10019	Japanese Y100 Coin Return Button Assembly
99-10020	U.K. 10 P Coin Return Button Assembly
99-10021	Australian 20¢ Coin Return Button Assembly
99-10022	Italian 100 Lire Coin Return Button Assembly
99-10040	Coin Inlet Chute Assembly
99-10041	Coin Counter Assembly
99-10042	Coin Switch Assembly for U.S. 25¢ and Belgian 5 Fr Coins <i>(silver wire)</i>
99-10043	Coin Switch Assembly for German 1 DM, Swiss 1 Fr, and Japanese Y100 Coins <i>(black wire)</i>
99-10044	Coin Switch Assembly for U.S. \$1.00, German 2 DM, and Italian 100 Lire Coins <i>(gold wire)</i>
99-10045	Coin Switch Assembly for German 5 DM, U.K. 10 P, and Australian 20¢ Coins <i>(green wire)</i>

Figure 22 American-Made Coin Door, continued Parts List

<i>Part No.</i>	<i>Description</i>
99-10047	Lockout Coil Assembly
99-10048	Coin Door Harness Assembly
99-10049	Locking Arm Assembly
99-10051	Coin Door Frame
99-10052	Coin Return Lever
99-10054	Coin Button Housing
99-10055	Coin Return Button Cover for Japanese 100Y Coin
99-10056	Coin Return Button Cover for German 1 DM and Swiss 1 Fr Coins
99-10057	Coin Return Button Cover for U.S. 25¢ and Belgian 5 Fr Coins
99-10058	Coin Return Button Cover for U.S. \$1.00, German 2 DM, and Italian 100 Lire Coins
99-10059	Coin Return Button Cover for German 5 DM, U.K. 10 P, and Australian 20¢ Coins
99-10061	Coin Return Bezel
99-10062	Coin Return Button
99-10063	Right Half of Coin Inlet Chute
99-10065	Coin Return Box
99-10066	Coin Return Cover
99-10068	Coin Chute
99-10070	U.S. 25¢ Price Plate
99-10071	Slam Switch Assembly
99-10073	Test Switch Decal
99-10074	Lock Assembly
99-10075	Black Switch Wire for German 1 DM, Swiss 1 Fr and Japanese 100Y Coins
99-10076	Silver Switch Wire for U.S. 25¢ and Belgian 5 Fr Coins
99-10077	Gold Switch Wire for U.S. \$1.00, German 2 DM and Italian 100 Lire Coins
99-10078	Green Switch Wire for German 5 DM, U.K. 10 P and Australian 20¢ Coins
99-10080	Miniature Bayonet-Base Lamp Socket
99-10081	Wire Key Holder
99-10082	Switch Cover
99-10083	U.S. \$1.00 Price Plate
99-10084	German 1 DM Price Plate
99-10085	German 2 DM Price Plate
99-10086	German 5 DM Price Plate
99-10087	Belgian 5 Fr Price Plate
99-10088	Swiss 1 Fr Price Plate
99-10089	Japanese Y100 Price Plate
99-10090	U.K. 10 P Price Plate
99-10091	Australian 20¢ Price Plate
99-10092	Italian 100 Lire Price Plate
99-10094	Fish Paper Insulation
99-10095	Toggle Switch
99-10096	“U”-Type Fastener
99-10097	Fish Paper Insulation
99-10101	Left Half of Coin Inlet Chute
99-10102	Switch and Lockout Coil Bracket Sub-Assembly
99-10103	Inner Panel with Levers Sub-Assembly
99-10104	Anti-Penny-Flip Bar Retainer
99-10105	Anti-Penny-Flip Bar
99-10107	U.S. 50¢ Coin Return Button Assembly <i>(for two quarters)</i>
99-10108	U.S. 50¢ Price Plate <i>(for two quarters)</i>

NOTICE TO ALL PERSONS RECEIVING THIS DRAWING
CONFIDENTIAL: Reproduction forbidden without the specific written permission of Atari, Inc., Sunnyvale, CA. This drawing is only conditionally issued, and neither receipt nor possession thereof confers or transfers any right in, or license to use, the subject matter of the drawing or any design or technical information shown thereon, nor any right to reproduce this drawing or any part thereof. Except for manufacture by vendors of Atari, Inc., and for manufacture under the corporation's written license, no right to reproduce this drawing is granted or the subject matter thereof unless by written agreement with or written permission from the corporation.

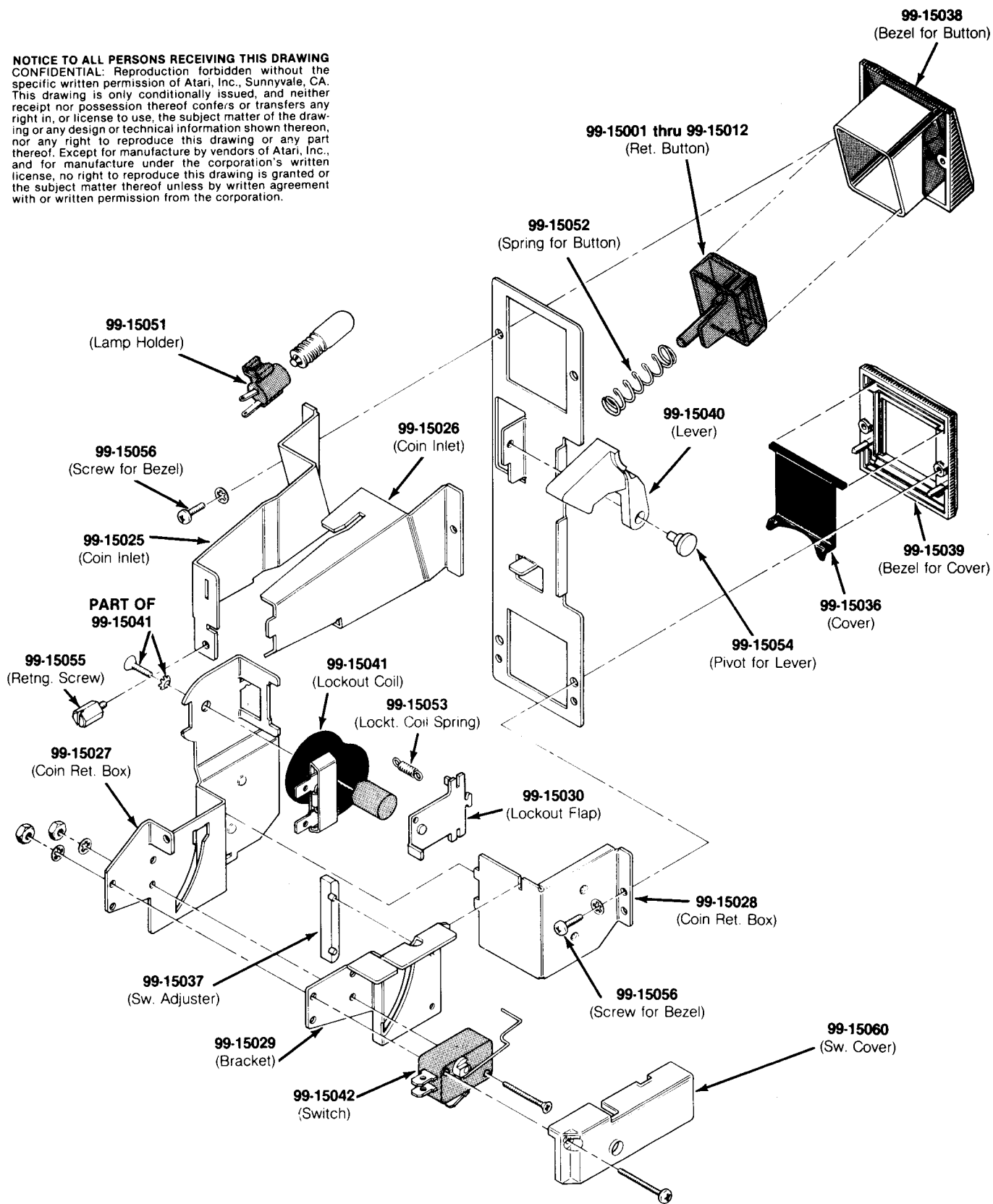
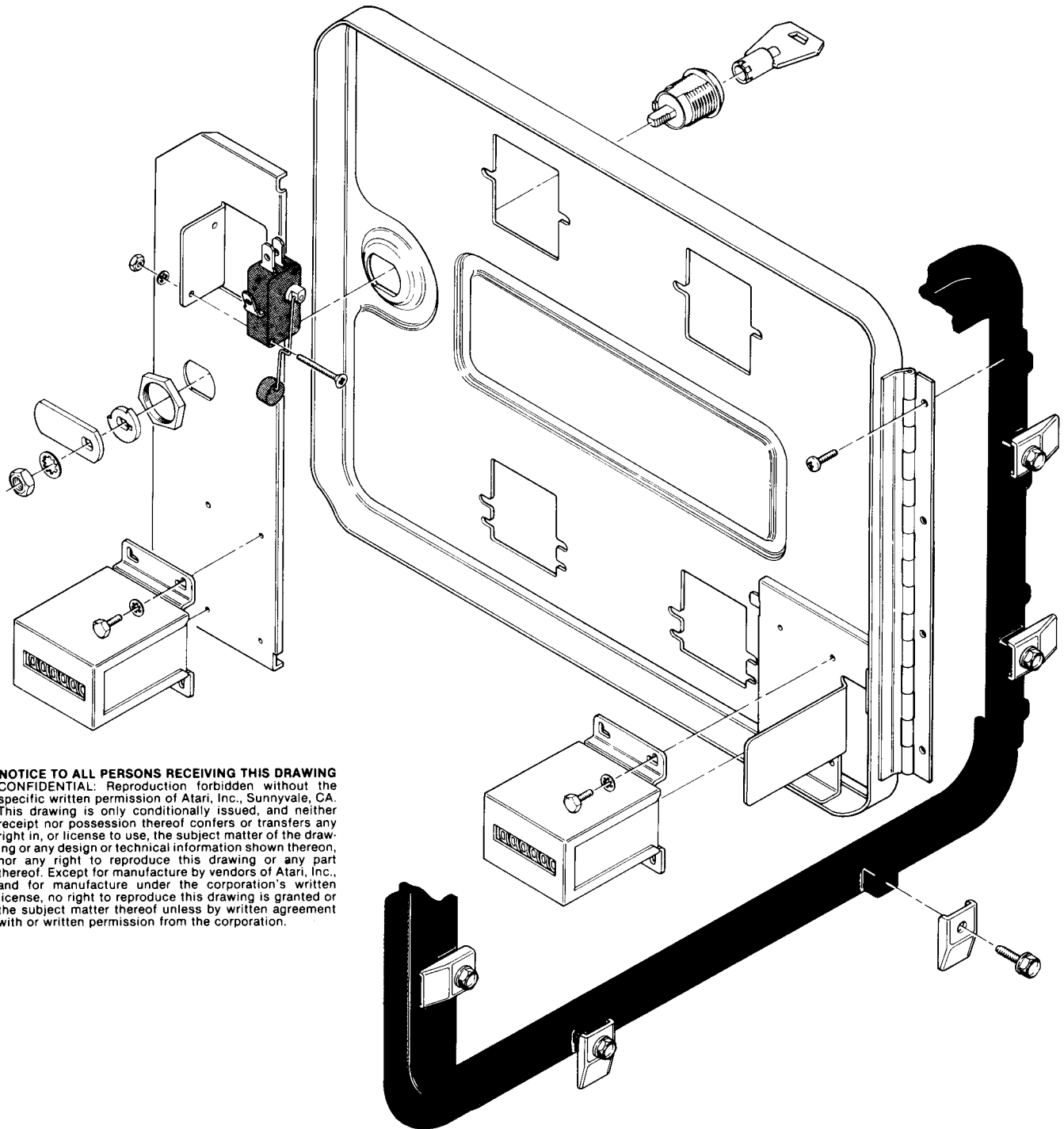

Figure 23 British-Made Coin Door
171000-xxx A



NOTICE TO ALL PERSONS RECEIVING THIS DRAWING
CONFIDENTIAL: Reproduction forbidden without the specific written permission of Atari, Inc., Sunnyvale, CA. This drawing is only conditionally issued, and neither receipt nor possession thereof confers or transfers any right in, or license to use, the subject matter of the drawing or any design or technical information shown thereon, nor any right to reproduce this drawing or any part thereof. Except for manufacture by vendors of Atari, Inc., and for manufacture under the corporation's written license, no right to reproduce this drawing is granted or the subject matter thereof unless by written agreement with or written permission from the corporation.

171001-001 — British 10 P/10 P Coin Door
 171000-002 — British 10 P/50 P Coin Door
 171000-003 — British 20 P/50 P Coin Door
 171000-004 — German 1 DM/1 DM Coin Door
 171000-005 — German 2 DM/1 DM Coin Door

171000-006 — German 2 DM/5 DM Coin Door
 171000-007 — Belgian 5 Fr/5 Fr Coin Door
 171000-008 — French 1 Fr/1 Fr Coin Door
 171000-009 — French 2 Fr/1 Fr Coin Door
 171000-010 — Swedish 1 Kr/1 Kr Coin Door

171000-011 — Hong Kong \$1/\$1 Coin Door
 171000-012 — Canadian 25¢/25¢ Coin Door
 171000-013 — U.S. 25¢/25¢ Coin Door
 171000-014 — Spanish 25 Pts/25 Pts Coin Door
 171000-015 — Swiss 1 Fr/1 Fr Coin Door

Figure 23 British-Made Coin Door
 171000-xxx A

Figure 23 British-Made Coin Door, continued Parts List

<i>Part No.</i>	<i>Description</i>
99-15001	Coin Return Button with U.S. 25¢ Price Plate
99-15002	Coin Return Button with U.S. \$1 Price Plate
99-15003	Coin Return Button with German 1 DM Price Plate
99-15004	Coin Return Button with German 2 DM Price Plate
99-15005	Coin Return Button with German 5 DM Price Plate
99-15006	Coin Return Button with Belgian 5 Fr Price Plate
99-15007	Coin Return Button with French 1 Fr Price Plate
99-15008	Coin Return Button with Japanese 100 Yen Price Plate
99-15009	Coin Return Button with British 10 Pence Price Plate
99-15010	Coin Return Button with Australian 20¢ Price Plate
99-15011	Coin Return Button with Italian 100 Lire Price Plate
99-15012	Coin Return Button with U.S. 50¢ (2 × 25¢) Price Plate
99-15025	Left Half of Coin Inlet
99-15026	Right Half of Coin Inlet
99-15027	Side Plate of Coin Return Box
99-15028	Base Plate of Coin Return Box
99-15029	Switch Bracket
99-15030	Flap for Lockout Coil (U.S. 25¢)
99-15036	Coin Return Cover
99-15037	Switch Adjuster
99-15038	Bezel for Coin Return Button
99-15039	Bezel for Coin Return Cover
99-15040	Coin Return Lever
99-15041	Lockout Coil
99-15042	Coin Switch for U.S. 25¢
99-15051	Lamp Holder
99-15052	Spring for Coin Return Button
99-15053	Spring for Lockout Coil
99-15054	Pivot for Coin Return Lever
99-15055	Retaining Screw
99-15056	Screw for Both Bezels
99-15060	Switch Cover

Warranty

Seller warrants that its printed circuit boards and parts thereon are free from defects in material and workmanship under normal use and service for a period of ninety (90) days from date of shipment. Seller warrants that its television monitors (in games supplied with monitors) are free from defects in material and workmanship under normal use and service for a period of thirty (30) days from date of shipment. None of the Seller's other products or parts thereof are warranted.

If the products described in this manual fail to conform to this warranty, Sellers' sole liability shall be, at its option, to repair, replace, or credit Buyer's account for such products which are returned to Seller during said warranty period, provided:

- (a) Seller is promptly notified in writing upon discovery by Buyer that said products are defective;
- (b) Such products are returned prepaid to Sellers' plant; and
- (c) Seller's examination of said products discloses to Seller's satisfaction that such alleged defects existed and were not caused by accident, misuse, neglect, alteration, improper repair, installation or improper testing.

In no event shall Seller be liable for loss of profits, loss of use, incidental or consequential damages.

Except for any express warranty set forth in a written contract between Seller and Buyer which contract supersedes the terms of this order, this warranty is expressed in lieu of all other warranties expressed or implied, including the implied warranties of merchantability and fitness for a particular purpose, and of all other obligations or liabilities on the Seller's part, and it neither assumes nor authorizes any other person to assume for the Seller any other liabilities in connection with the sale of products under this order.

The use of any non-Atari parts may void your warranty, according to the terms of the warranty. The use of any non-Atari parts may also adversely affect the safety of your game and cause injury to yourself and others. Be very cautious in using non-Atari-supplied components with our games, in order to insure your safety.

Atari distributors are independent, being privately owned and operated. In their judgment they may sell parts or accessories other than Atari parts or accessories. Atari cannot be responsible for the quality, suitability or safety of any non-Atari part or any modification including labor which is performed by such distributor.

This document is and contains confidential trade secret information of Atari, Inc.

This document is loaned under confidential custody for the sole purpose of operation, maintenance or repair of Atari equipment and may not be used by or disclosed to any person for any other purpose whatever, and remains the property of Atari, Inc.

Neither it nor the information it contains may be reproduced, used, or disclosed to persons not having a need to know consistent with the purpose of the loan, without written consent of Atari, Inc.

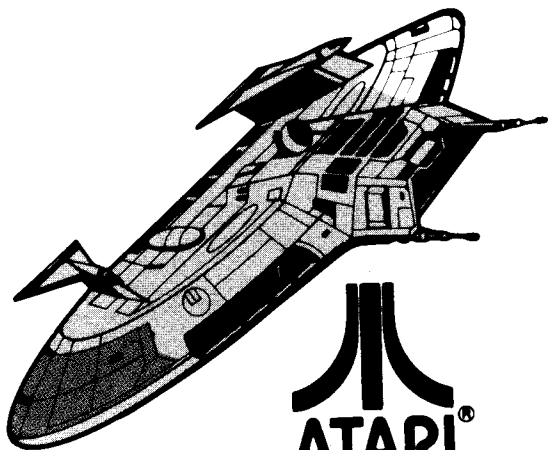
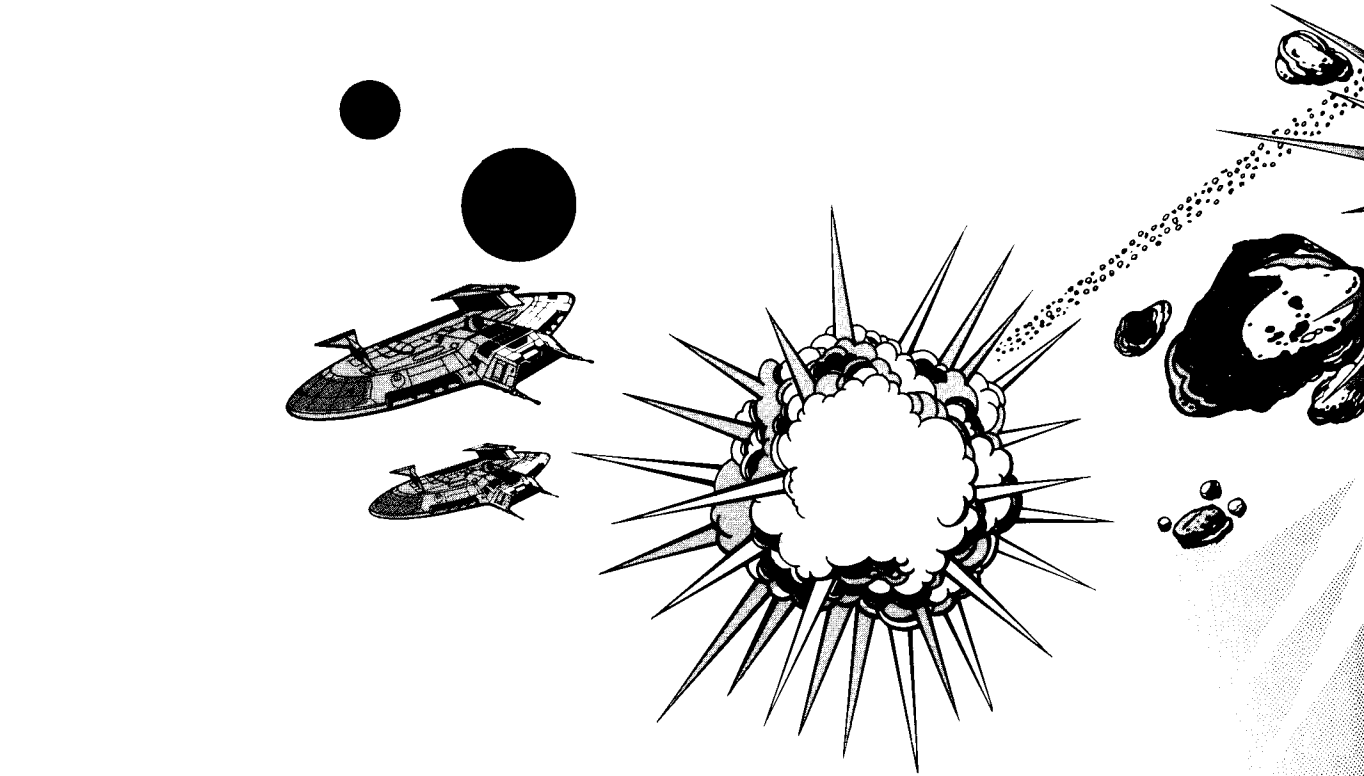

ATARI INC
1265 BORREGAS AVENUE
P.O. BOX 427
SUNNYVALE, CALIFORNIA 94086
408/745-2000 • TELEX 35-7488

 A Warner Communications Company