



SEGA[®]
AFTER
BURNER

OWNER'S MANUAL

SEGA ENTERPRISES, LTD.

TABLE OF CONTENTS

INTRODUCTION TO THE OWNER'S MANUAL	1
1. HANDLING PRECAUTIONS	2
2. PREVENTION OF COUNTERFEITING AND CONVERSION	2
3. PRECAUTIONS CONCERNING THE PLACE OF INSTALLATION	3
4. NAME OF PARTS 1	3
5. NAME OF PARTS 2	4
6. OPENING THE CONTROL UNIT	5
7. HANDLE UNIT ADJUSTMENT	6
8. REPLACING THE MOTOR BRUSHES	7
9. THROTTLE UNIT ADJUSTMENT	8
10. IC BOARD	9
11. SERVICE SWITCH FUNCTIONS	10
12. DIP SWITCH	11
13. EPROM/MASK ROM LOCATIONS	13
14. PARTS LIST	14
15. WIRING DIAGRAM	24

UPRIGHT TYPE

SPECIFICATIONS

INSTALLATION SPACE	: 630 mm (24.8 in.) W × 860 mm (33.9 in.) D
HEIGHT	: 1850 mm (72.8 in.)
POWER	: 240 W
C.R.T.	: 20" MONITOR
WEIGHT	: 124 kg (273 lbs.)

NOTE

- Descriptions herein contained may be subject to improvement changes without notice.

INTRODUCTION TO THE OWNER'S MANUAL

SEGA ENTERPRISES, LTD., supported by its high electronic technology of LSIs, microprocessors, etc. and a wealth of experience, has for more than 30 years been supplying various innovative and popular game machines to the world market. This OWNER'S manual is intended to provide detailed comments together with all the necessary information covering the operation in general of electronic assemblies, electromechanicals, servicing control, spare parts, etc. as regards the AFTER BURNER U/R, a new SEGA product. The manual is intended for those who have knowledge of electricity and technical expertise especially in ICs, CRTs, microprocessors, etc. Carefully read so as to acquire sufficient knowledge before working on the machine. Should there be a malfunction, non-technical personnel should under no circumstances touch the interior system.

1. HANDLING PRECAUTIONS

When installing or inspecting, be very careful of the following points and pay attention to ensure that the player can enjoy the game safely.

- Be sure to turn the power off before working on the machine.
- To insert or pull out the plug quickly is dangerous.
- It is necessary to make sure that the power cord or the grounding wire is not exposed on the road, etc. in a manner so as to be dangerous. Make sure that grounding connections are made safely at the position where so specified.
- Do not use any fuse that does not meet the specified rating.
- Make complete connections for the IC board and other connectors. Insufficient insertion is very dangerous.

Also, for the IC board circuit inspections, only the logic tone is allowed. The use of a tester is not permitted, so be careful in this regard. After confirming that there are no irregularities, turn the power ON.

2. PREVENTION OF COUNTERFEITING AND CONVERSION

LABELLING

To prevent counterfeits and conversions, the following labels are put on all the SEGA products. When handling such goods, be sure to confirm the labels. They are used to prevent illegal acts such as the unauthorized copying of the products and the printed circuit boards thereof or carrying on business by manufacturing similar merchandise or by converting, selling or using such products or printed circuit boards.

ORIGINAL SEAL

The following seal is put on the machines manufactured by SEGA.

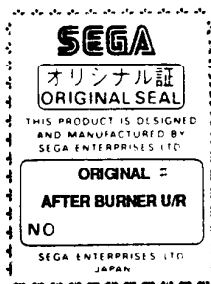

LICENSE SEAL

The following seal is put on the kits, such as the printed circuit boards, of SEGA products.

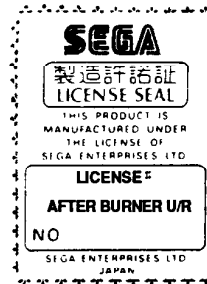

COPYRIGHT NOTICE

This SEGA product has the copyright notice as follows:

© SEGA 1987

This signifies that this work was disclosed in 1987 and is the property of SEGA ENTERPRISES, LTD.

3. PRECAUTIONS CONCERNING THE PLACE OF INSTALLATION

The SUPER AFTER BURNER U/R is an indoor game machine. Absolutely do not install it outside. Even indoors, avoid installing in places mentioned below so as to ensure proper usage:

- Places subject to rain or water leakage, or condensation due to humidity.
- In the proximity of an indoor swimming pool and/or shower.
- Places subject to direct sunlight.
- Places subject to heat sources from heating units, etc., or hot air.
- Vicinity of highly inflammable/volatile chemicals or hazardous matter.
- Sloped surfaces.
- Vicinity of anti-disaster facilities such as fire exits and fire extinguishers.
- Places subject to any type of violent impact.
- Dusty places.

4. NAME OF PARTS ①

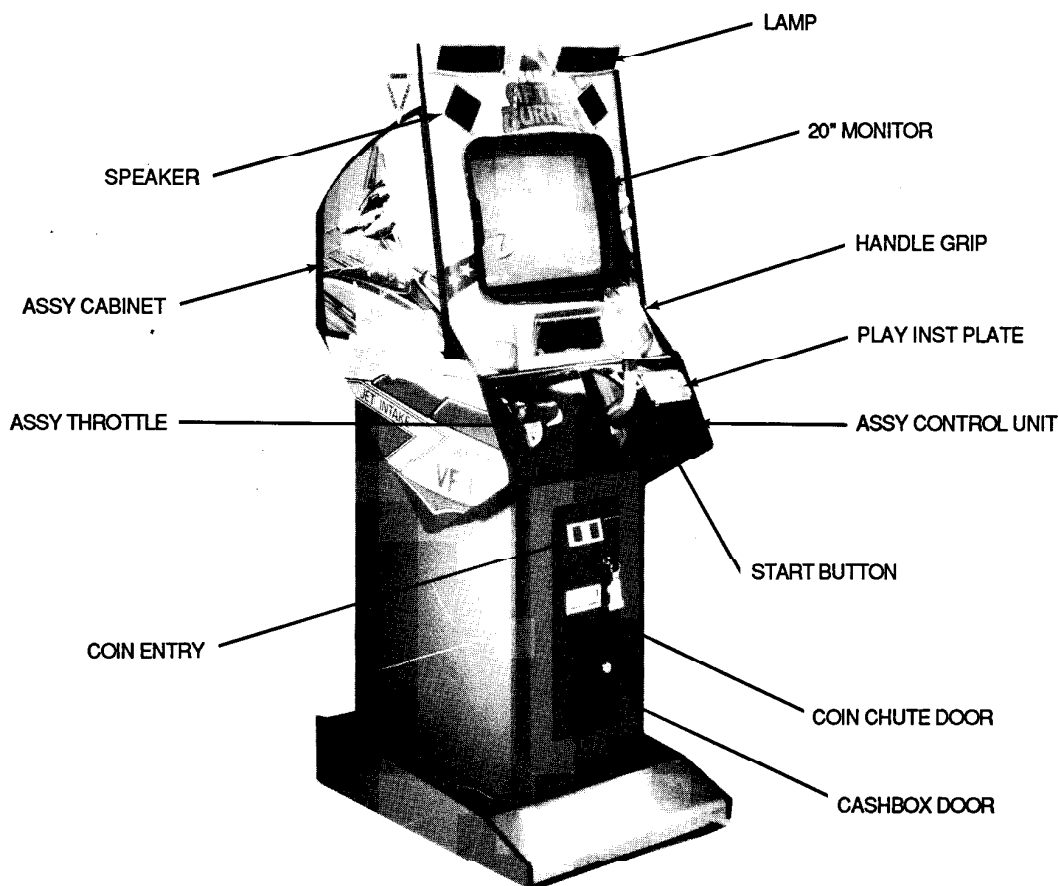

TOOLS

(TAMPERPROOF WRENCH)

- M 4 540-0006-01
- M 5 540-0007-01
- M 8 540-0009-01



(TAMPERPROOF DRIVER)

- M4 540-0018
- M5 540-0017
- M8 540-0011

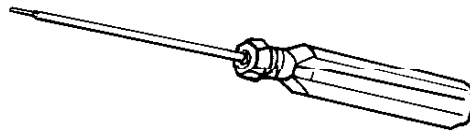

5. NAME OF PARTS ②

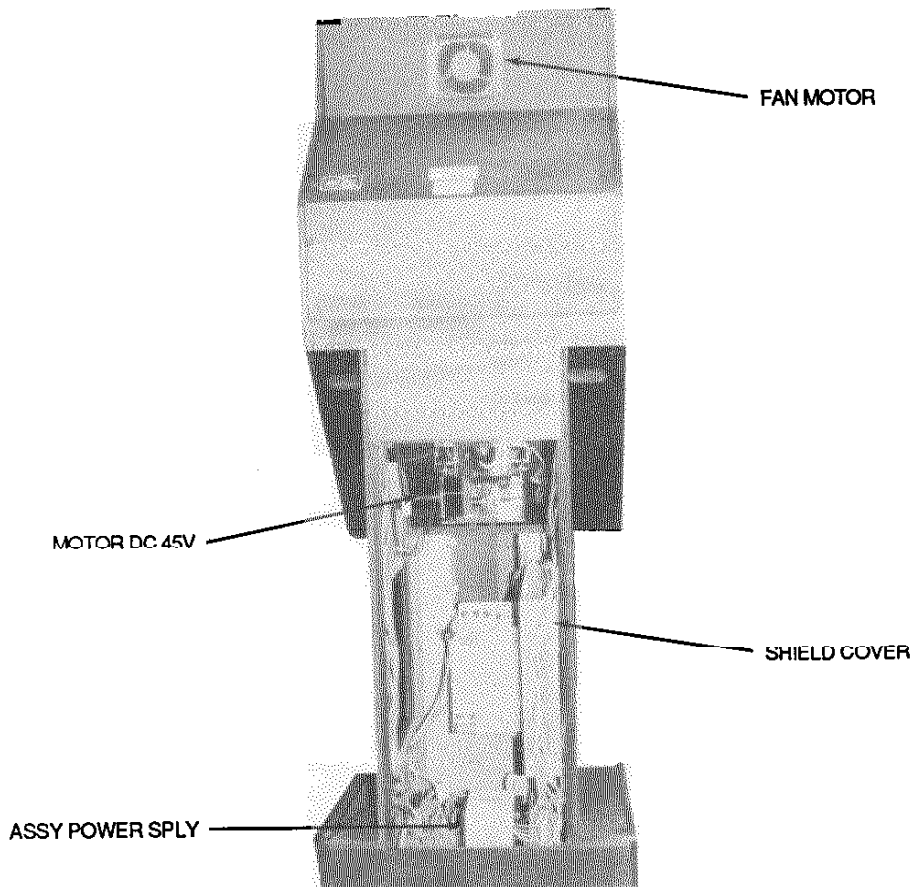

6. OPENING THE CONTROL UNIT

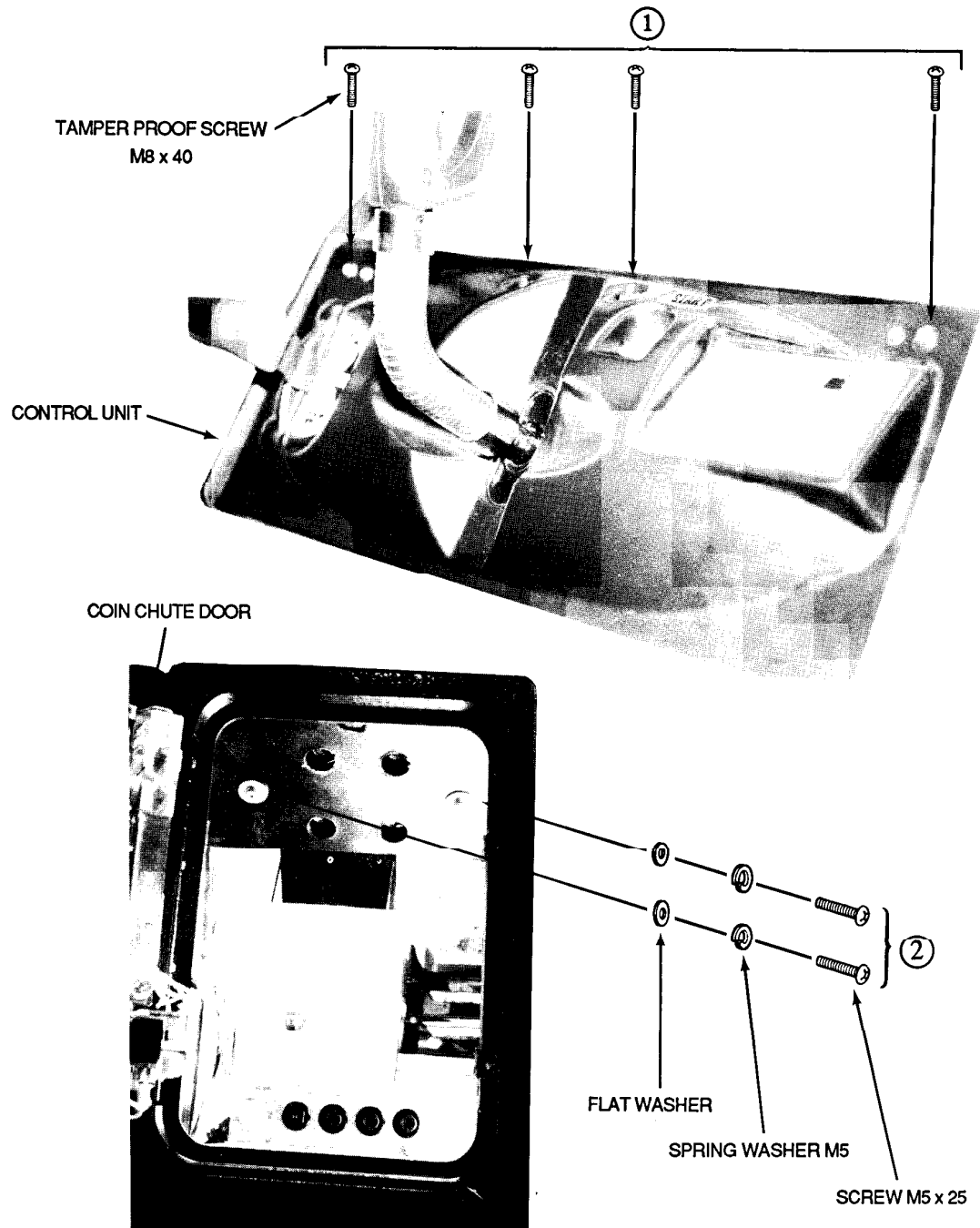

- To open the CONTROL UNIT, take off the 4 TAMPERPROOF SCREWS ①, open the COIN CHUTE DOOR, take off the 2 (M5 × 25) SCREWS ②, and the entire CONTROL UNIT will open towards you.
- Opening the CONTROL UNIT allows for spring replacements, handle centering V.R. adjustments, motor brush replacements and THROTTLE UNIT centering adjustments.

7. HANDLE UNIT ADJUSTMENT

In the test mode, cause the DIAGNOSTIC INPUT DISPLAY to appear on the screen (to select it, push the test switch and move the handle upward and downward).

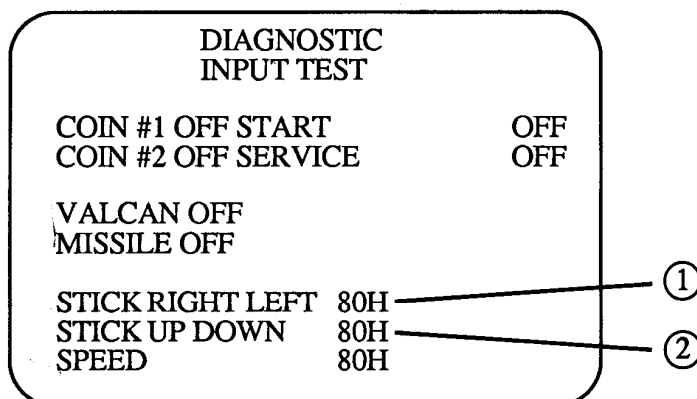

- ① To make VR adjustments in a horizontal direction (RIGHT/LEFT), release the VR "A" bracket's "A" screws and turn gear "A" in a manner so that when the handle grip is in an unoperated status, $80H \pm 2H$ is obtained. At this time, also make backlash adjustments.
- ② When making vertical (UP/DOWN) adjustments, while maintaining the present inclination of the handle unit, unfasten the gear "C" bracket's "B" screws and fasten the gear "C" bracket when the monitor display shows $80H \pm 2H$. For backlash adjustments, loosen the VR "B" bracket.

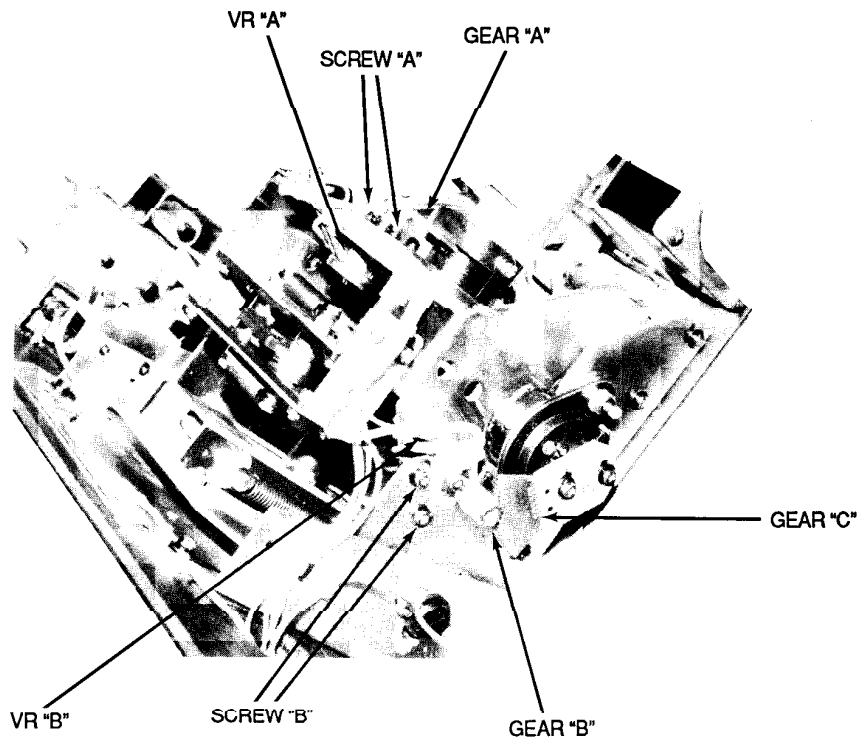

8. REPLACING THE MOTOR BRUSHES

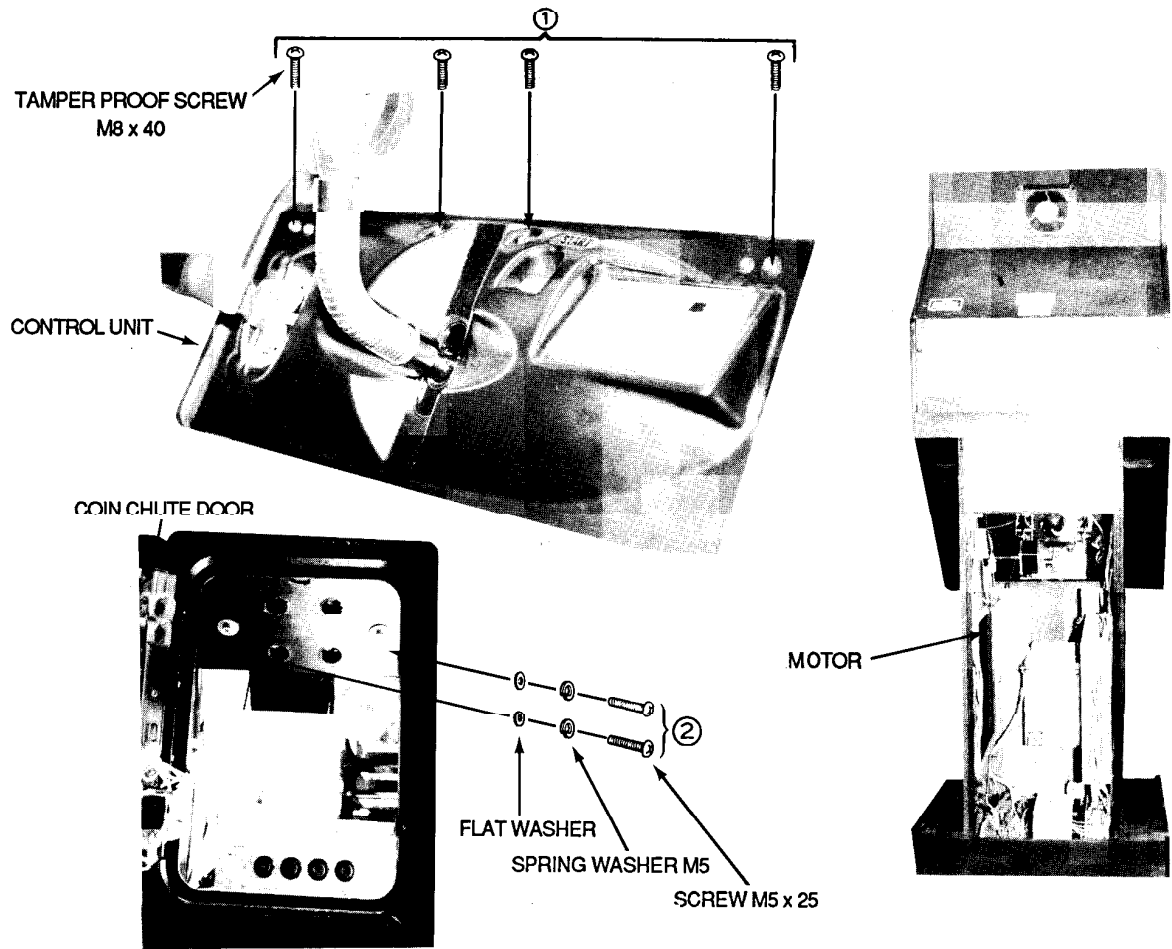

To replace the motor brushes, release the cap with a screwdriver, etc., and take out the brushes. Replacement once every 6 months is recommended. Make sure that both brushes are replaced at the same time.

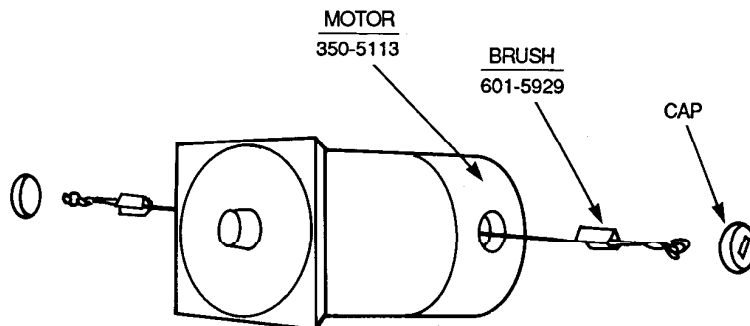

9. THROTTLE UNIT ADJUSTMENT

**DIAGNOSTIC
INPUT TEST**

COIN #1 OFF START	OFF
COIN #2 OFF SERVICE	OFF
VALCAN OFF	
MISSILE OFF	
STICK RIGHT LEFT 80H	①
STICK UP DOWN 80H	②
SPEED 80H	③

GEAR

ADJUSTMENT SCREW

- ③ Unfasten the 2 adjustable screws to loosen the volume bracket, making sure that in relation to the gear engagement, the variable value in the test mode is within the allowable adjustment range, and then refasten the adjustment screws.

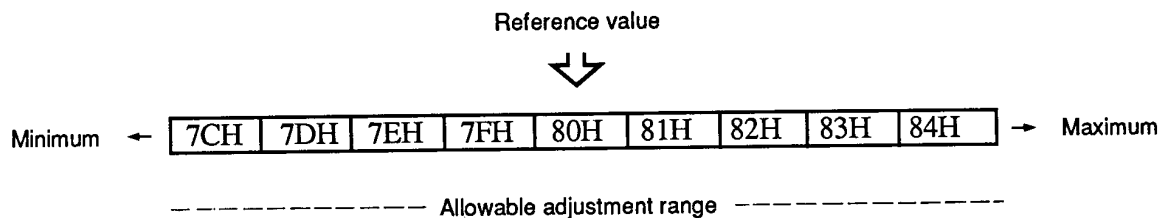

10. IC BOARD

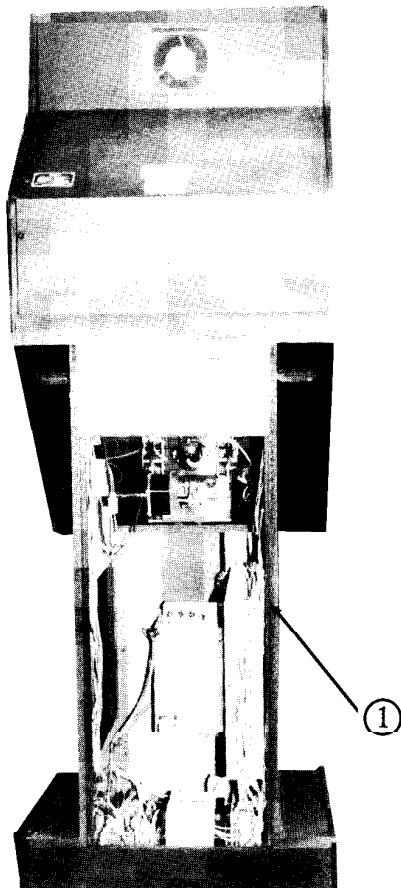
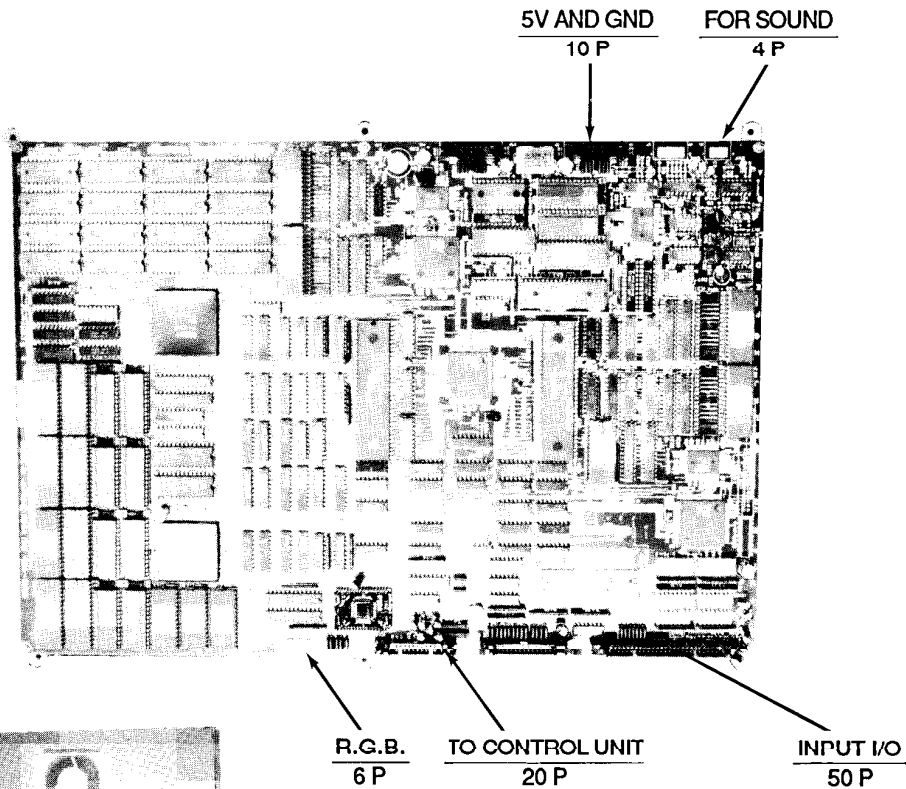

• HOW TO REMOVE THE IC BOARD

1. Disconnect all of the harness to the filter board (839-0108) CONNECTORS.
2. Take off the SCREW (M4 × 16 w/flat washer and spring washer) ① which secures the SHIELD BASE.
3. Completely pull out the SHIELD BOX, take off the 18 S TITE SCREWS (M4 × 6 w/flat washer) and remove the SHIELD COVER.
4. Take off the 6 S TITE SCREWS (M3 × 12 w/flat washer) which secure the IC BOARD.
5. The IC BOARD can be removed by taking off the inserted connectors.

11. SERVICE SWITCH FUNCTIONS

The layout as shown below can be viewed by opening the coin chute door.

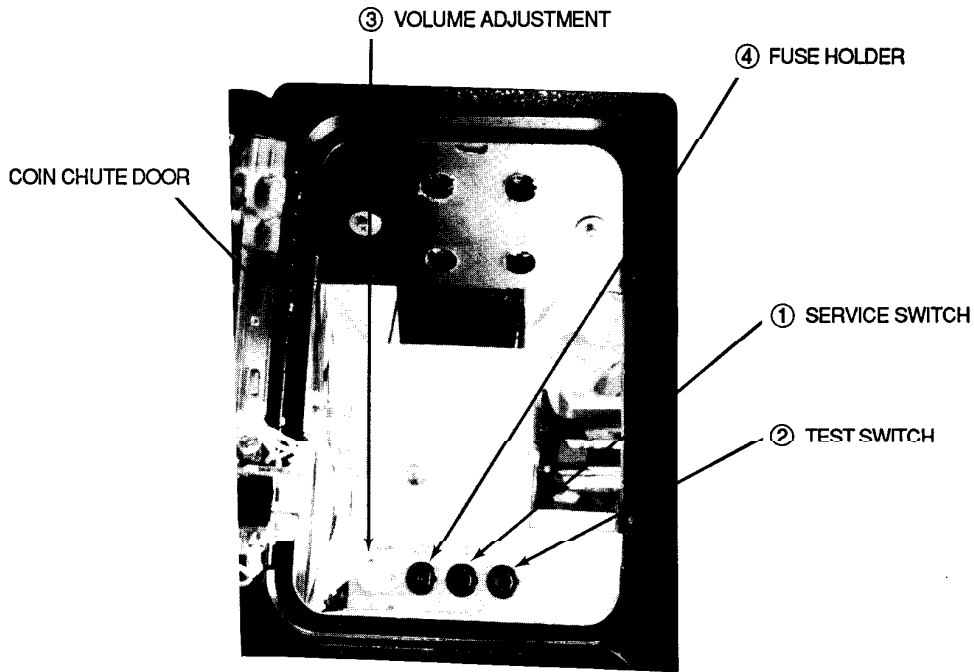

INSTRUCTIONS

- ① SERVICE SWITCH Used for the purpose of servicing and increasing the credits without registering on the meter (this allows you to check the game).
- ② TEST SWITCH For operating this switch, see SELF-TESTING.
- ③ VOLUME ADJUSTMENT The volume of the speaker inside the cowl can be adjusted.
- ④ FUSE HOLDER When the motor is overloaded, the fuse will be burned out, causing the motor which is connected with the handle, to stop. To restart it, replace the fuse with same current limit.

12. DIP SWITCH SETTING

COIN/CREDIT OPTION SWITCH SETTING

DIP SW A

OPTION		1	2	3	4	5	6	7	8
1 COIN	1 CREDIT	OFF	OFF	OFF	OFF	OFF	OFF	OFF	OFF
1 COIN	2 CREDITS	ON	OFF	OFF	OFF	ON	OFF	OFF	OFF
1 COIN	3 CREDITS	OFF	ON	OFF	OFF	OFF	ON	OFF	OFF
5 COINS	1 CREDIT	ON	ON	OFF	OFF	ON	ON	OFF	OFF
6 COINS	1 CREDIT	OFF	OFF	ON	OFF	OFF	OFF	ON	OFF
7 COINS	1 CREDIT	ON	OFF	ON	OFF	ON	OFF	ON	OFF
2 COINS	1 CREDIT	OFF	ON	ON	OFF	OFF	ON	ON	OFF
3 COINS	1 CREDIT	ON	ON	ON	OFF	ON	ON	ON	OFF
4 COINS	1 CREDIT	OFF	OFF	OFF	ON	OFF	OFF	OFF	ON
2 COINS	3 CREDITS	ON	OFF	OFF	ON	ON	OFF	OFF	ON
2 COINS	1 CREDIT	OFF	ON	OFF	ON	OFF	ON	OFF	ON
3 COINS	2 CREDITS	ON	ON	OFF	ON	ON	ON	OFF	ON
5 COINS	3 CREDITS	ON	ON	ON	ON	ON	ON	ON	ON
6 COINS	4 CREDITS	ON	ON	ON	ON	ON	ON	ON	ON
2 COINS	1 CREDIT	ON	ON	OFF	ON	ON	ON	OFF	ON
4 COINS	3 CREDITS	ON	ON	OFF	ON	ON	ON	OFF	ON
1 COIN	1 CREDIT	OFF	OFF	ON	ON	OFF	OFF	ON	ON
2 COINS	2 CREDITS	ON	OFF	ON	ON	ON	OFF	ON	ON
3 COINS	3 CREDITS	ON	OFF	ON	ON	ON	OFF	ON	ON
4 COINS	4 CREDITS	ON	OFF	ON	ON	ON	OFF	ON	ON
5 COINS	5 CREDITS	ON	OFF	ON	ON	ON	OFF	ON	ON
1 COIN	1 CREDIT	OFF	ON	ON	ON	OFF	ON	ON	ON
2 COINS	3 CREDITS	ON	ON	ON	ON	ON	ON	ON	ON
FREE PLAY		ON	ON	ON	ON	ON	ON	ON	ON
				COIN SW. #1			COIN SW. #2		

GAME OPTION SETTING

DIP SW B

OPTION		1	2	3	4	5	6	7	8
CABINET TYPE	MOVING DX	OFF	OFF						
	MOVING STD	ON	OFF						
	UP RIGHT	OFF	ON						
	NOT USED	ON	ON						
ADVERTISE SOUND	OFF		OFF						
	ON		ON						
SHIPS PER CREDIT	3 PLAYERS				OFF				
	4 PLAYERS				ON				
SHIP INCREASE	NO					OFF			
	YES					ON			
CONTINUE PLAY	NO						OFF		
	YES						ON		
GAME DIFFICULTY	NORMAL							OFF	OFF
	EASY							ON	OFF
	HARD							OFF	ON
	HARDEST							ON	ON

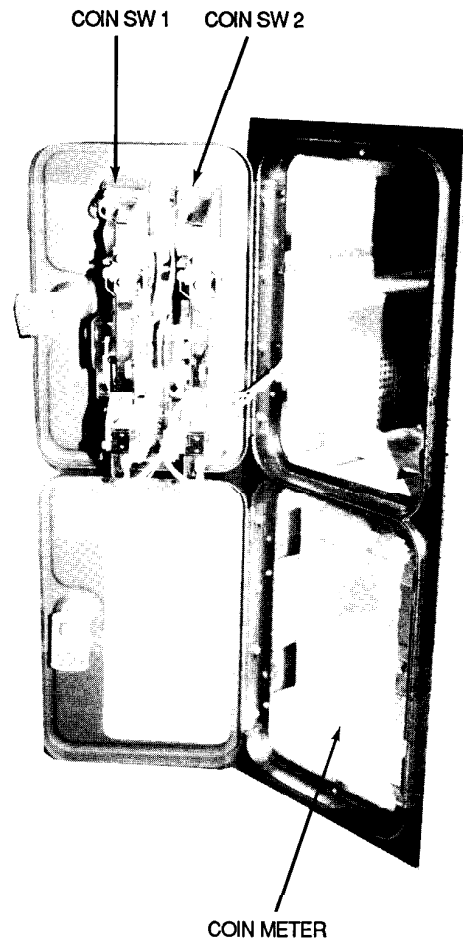

COIN METER

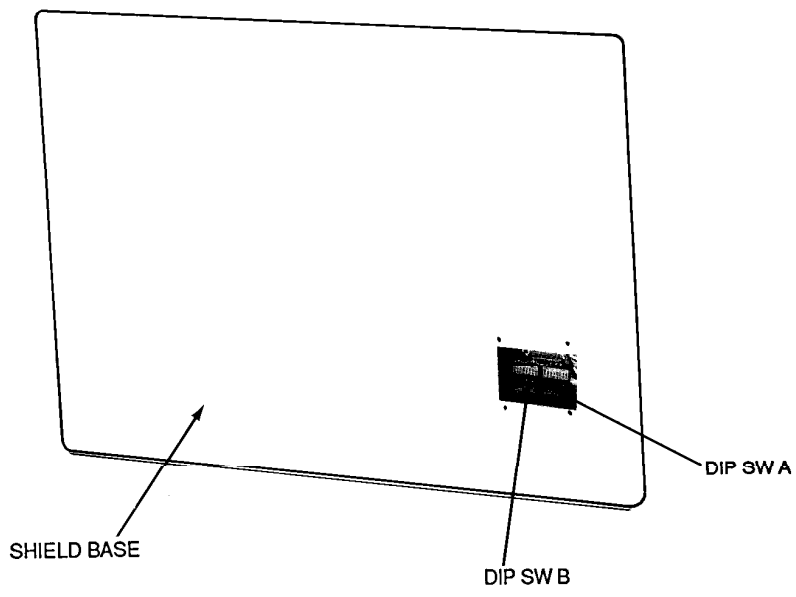
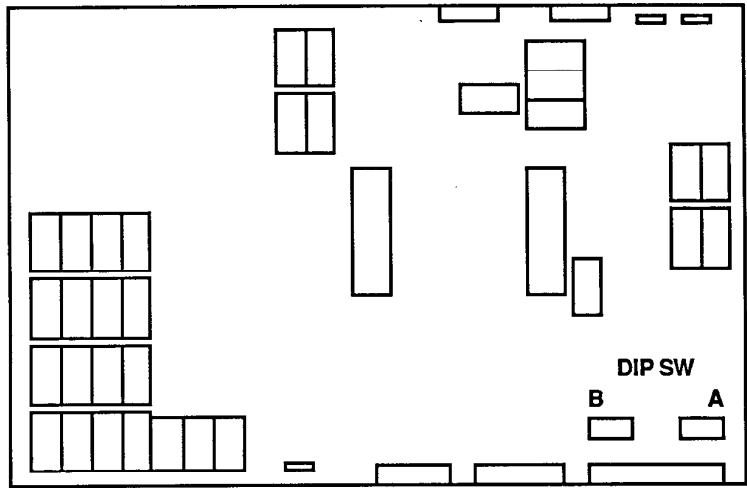

13. EPROM/MASK ROM LOCATIONS

GAME BD AFTER BURNER

834-6335-01

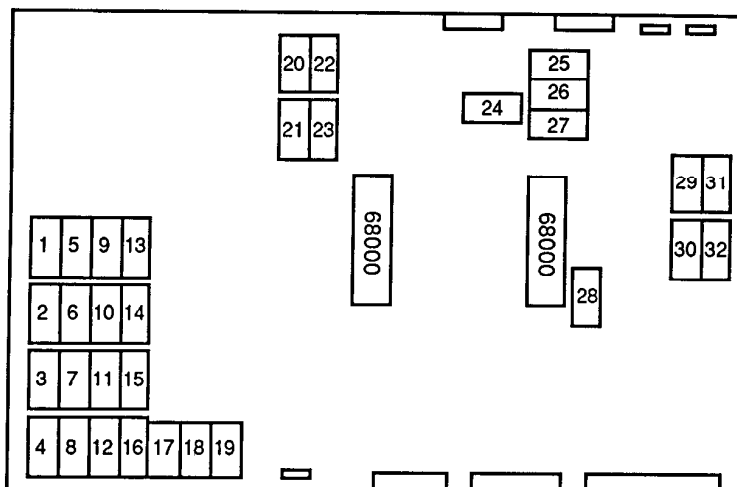

	IC LOCATION	MAIN WORK
1	IC 93	OBJECT (CHARACTER & SCENE SCENERY)
2	IC 97	
3	IC 101	
4	IC 105	
5	IC 92	
6	IC 96	
7	IC 100	
8	IC 104	
9	IC 91	
10	IC 95	
11	IC 99	
12	IC 103	
13	IC 90	
14	IC 94	
15	IC 98	
16	IC 102	
17	IC 154	FIX SCROLL CHARACTER
18	IC 153	
19	IC 152	
20	IC 58	MAIN PROGRAM
21	IC 63	
22	IC 57	
23	IC 62	
24	IC 17	SOUND PROGRAM
25	IC 11	SOUND DATER
26	IC 12	
27	IC 13	
28	IC 40	ROAD
29	IC 21	SUBPROGRAM
30	IC 30	
31	IC 20	
32	IC 29	

14. PARTS LIST

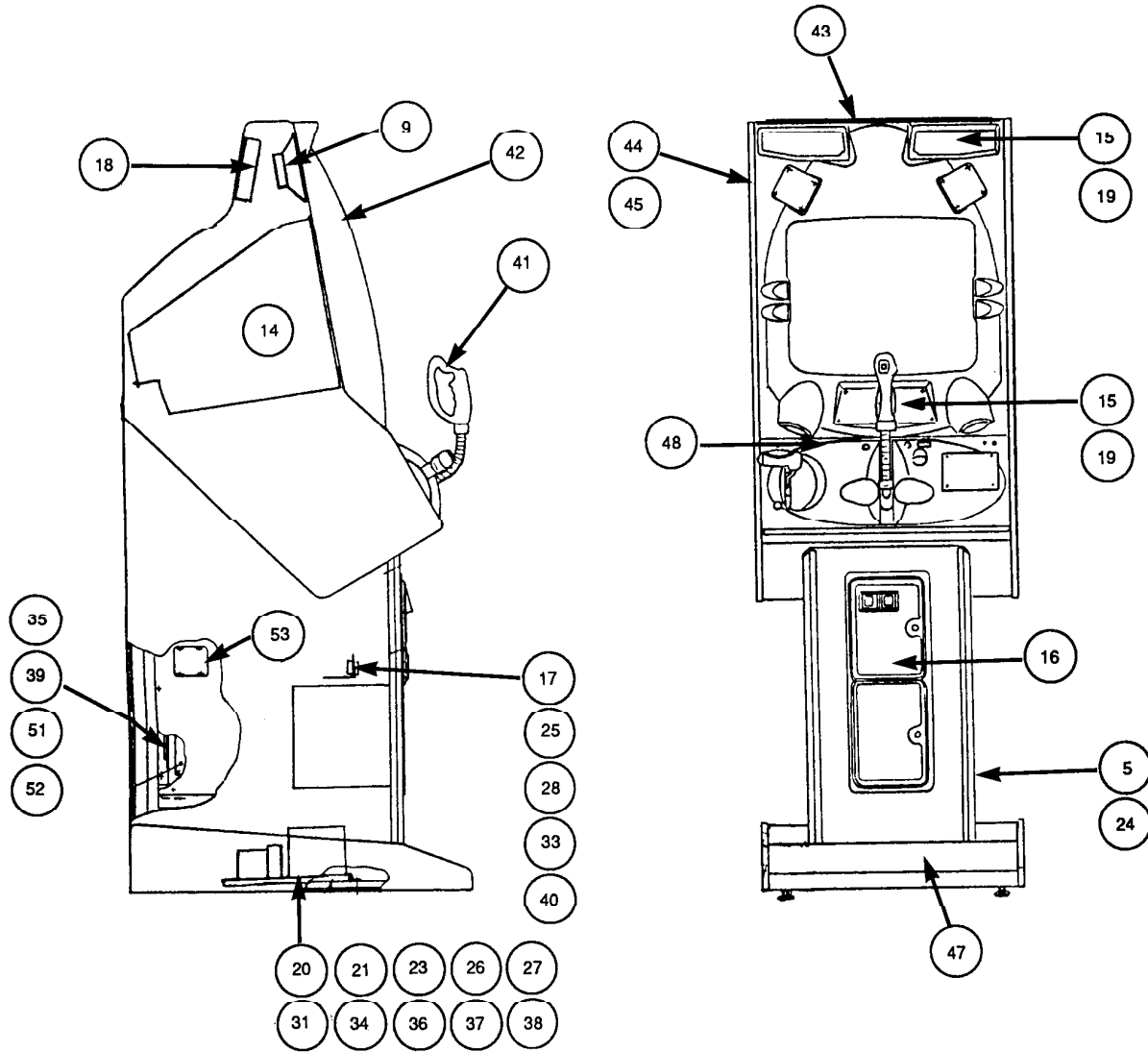

ASSEMBLY CABINET PARTS LIST

ITEM	PARTS NUMBER	DESCRIPTION
1	000-0525	M SCR PH M5X25 (PANEL)
2	008-0516	TMP SCR M5X16 (PANEL)
3	008-0535	TMP SCR M5X35 (TV DOOR)
4	029-0099	TMP SCR M8X40 (PANEL)
5	1050-0064	MAIN SW. BRACKET
6	1170-0184	TERMINAL BLOCK, 4P
7	1170-5131	TERMINAL BLOCK, 5P
8	1170-5131A	TERMINAL LUG
9	130-5018	SPFAKER 8-OHM 10W W/SHIELD
10	1500-0173	CAPACITOR, 4700 uF 50V
11	1500-0173A	CLAMP, CAP
12	1502-0000	POWER CORD RETAINER
13	1710-5151	FAN SCREEN COVER

14	2000-5090	TV MONITOR
15	2141-5064	LAMP SOCKET
16	2200-0000	COIN DOOR
17	2200-5179	VOL CONT B-5K
18	2600-0011-01	FAN 110V
19	3901-5167	LAMP 110V 30W
20	400-5070	DC/DC CONVERTER
21	400-5071	SW REGULATOR, 5V/7A
22	4211-6671	STICKER, DANGER
23	4810-0157	RECTIFIER, BRIDGE 2A
24	5090-0039	PUSH BUTTON POWER SW
25	5090-5028	PUSH BUTTON SW
26	5140-0031	FUSE 6A, FAST
27	5240-0034	FUSE 5A, FAST
28	5140-0036	FUSE 3A, FAST (MOTOR)
29	5140-0064	FUSE HOLDER 2P
30	5142-0000	FUSE HOLDER, PANEL
31	5600-5115	TRANSFORMER (160P6)
32	6010-0001	FUSE COVER
33	6010-0042	KNOB 22m
34	6010-0429	LINE FILTER
35	834-6335	GAME BOARD
36	839-0035-01	POWER AMP DC12V 10W
37	839-0048	SSR BOARD, MOTOR
38	839-0051	SSR BOARD, LAMP
39	839-0108	FILTER BOARD
40	KRO-1721	SW BRACKET
41	TX-13001	CONTROL PANEL ASSY
42	TX-1616	WINDOW MASK ASSY
43	TX0-1623	BRACKET, WINDOW MASK, TOP
44	TX1-1601-D	STICKER, SIDE R
45	TX1-1601-E	STICKER, SIDE L
46	TX1-1601-F	STICKER, SEGA
47	TX1-1605	ORNAMENT PLATE, TOE GUARD
48	TX1-1608	MAIN BRACKET, CONTROL ORNAMENT SASH L
49	TX1-1609	ORNAMENT SASH L
50	TX1-1610	ORNAMENT SASH R
51	TX1-1617	SHIELD COVER
52	TX1-1618	SHIELD BASE
53	TX1-1619	ACCESS PLATE
54	TX2-0000	CORNER PROTECTOR, LEFT
55	TX2-0001	CORNER PRTOECTOR, RIGHT
56	220-5130	VOL CONT B-5K (SPARE PARTS)
57	509-0058	PUSH SW VALCUN (SPARE PARTS)
58	510-5009	PUSH SW MISSILE (SPARE PARTS)
59	540-006-01	WRENCH, M4 (SPARE PARTS)
60	540-0007-01	WRENCH, M5 (SPARE PARTS)
61	540-0009-01	WRENCH, M8 (SPARE PARTS)
62	601-5929	MOTOR BRUSHES (SPARE PARTS)
63	TX-1317	EXT. SPRING (SPARE PARTS)
64	TX-1330	EXT. SPRING (SPARE PARTS)
65	TX-1423	EXT. SPRING (SPARE PARTS)

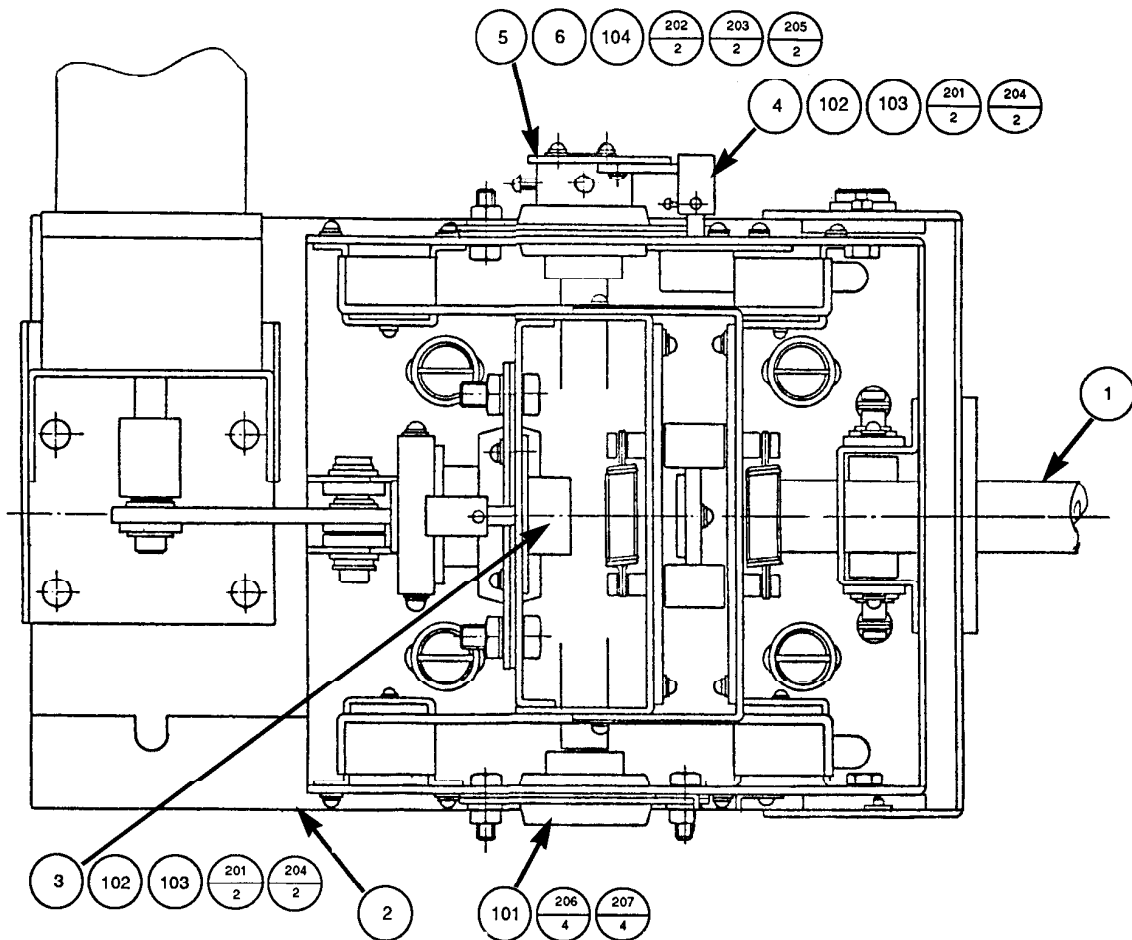

CONTROLLER UNIT ASSEMBLY PARTS LIST

ITEM	PARTS NUMBER	DESCRIPTION
1	TX-1351	SUB ASSEMBLY CONTROLLER
2	TX-1352	ASSEMBLY SHOCK MECHANISM
3	TX-1318	VR BRACKET A
4	TX-1334	VR BRACKET B
5	TX-1307	ADJUST PLATE
6	MX-2017	ADJUSTER
101	100-5042	BEARING D=12
102	220-5130	VOL CONT 5KOHM
103	601-5410	GEAR 15 D=16
104	601-5423	GEAR 1/6
201	000-0408-FS	M SCR W/FS M4 X 8
202	000-0408-S	M SCR W/FS M4 X 8
203	000-0412-FS	M SCR W/FS M4 X 12
204	028-0003	SET SCR PH SPECIAL M3 X 8
205	028-0021	SET SCR PH SPECIAL M4 X 16
206	061-0006	SPR WSHR M6
207	054-0006	U NUT M6

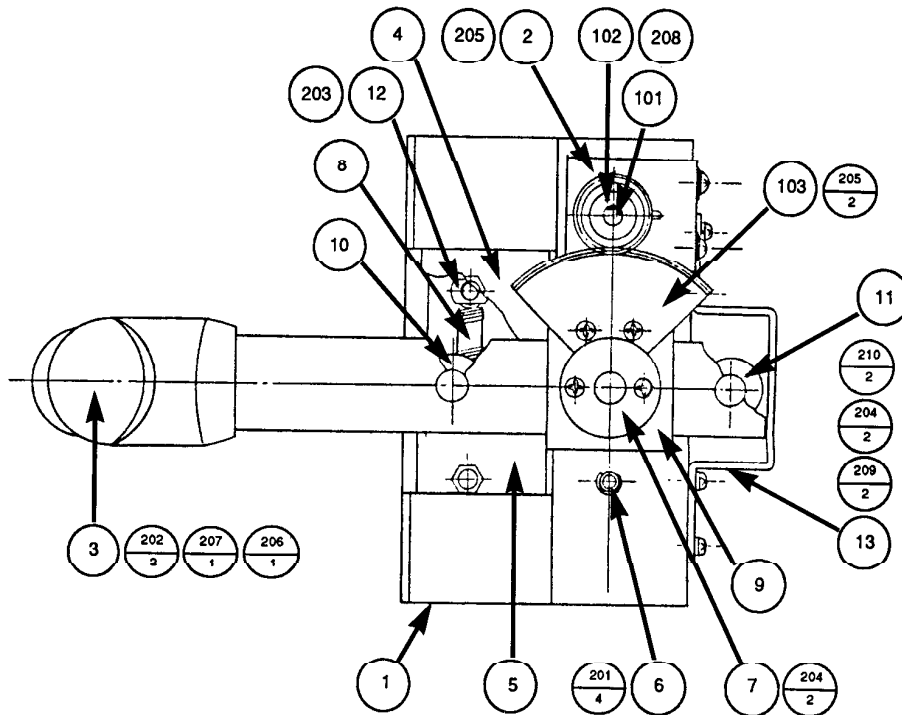

THROTTLE ASSEMBLY PARTS LIST

ITEM	PARTS NUMBER	DESCRIPTION
1	TX-1418	THROTTLE BASE
2	TX-1419	VR BRACKET
3	TX-1402	THROTTLE LEVER
4	TX-1403	SWING ARM A
5	TX-1404	SWING ARM B
6	TX-1405	SHAFT SWING ARM
7	TX-1406	GUIDE RING
8	TX-1423	EXT. SPRING
9	TX-1003	ADJUST PLATE
10	CY-2307	ROLLER
11	KR-1303	STOPPER PLATE
12	TX-1422	STUD
13	TX-1430	STOPPER BRACKET U/R
101	220-5130	VOL CONT B-5K OHM
102	601-5424	GEAR 30
103	601-5863	GEAR 1/4
201	065-0004	E RING 4mm
202	065-0008	E RING 8 mm
203	054-0006	U NUT M6
204	000-0414-S	M SCR PH W/S M4 X 14
205	000-0408-FS	M SCR PH W/FS M4 X 8
206	060-0010	FLT WSHR M 10
207	045-0022	COT PIN 2.5 X 20
208	028-0014	SET SCR HEX SKT CP M4 X 4
209	000-0406-S	M SCR PH W/S M4 X 6
210	054-0004-S	U NUT M4

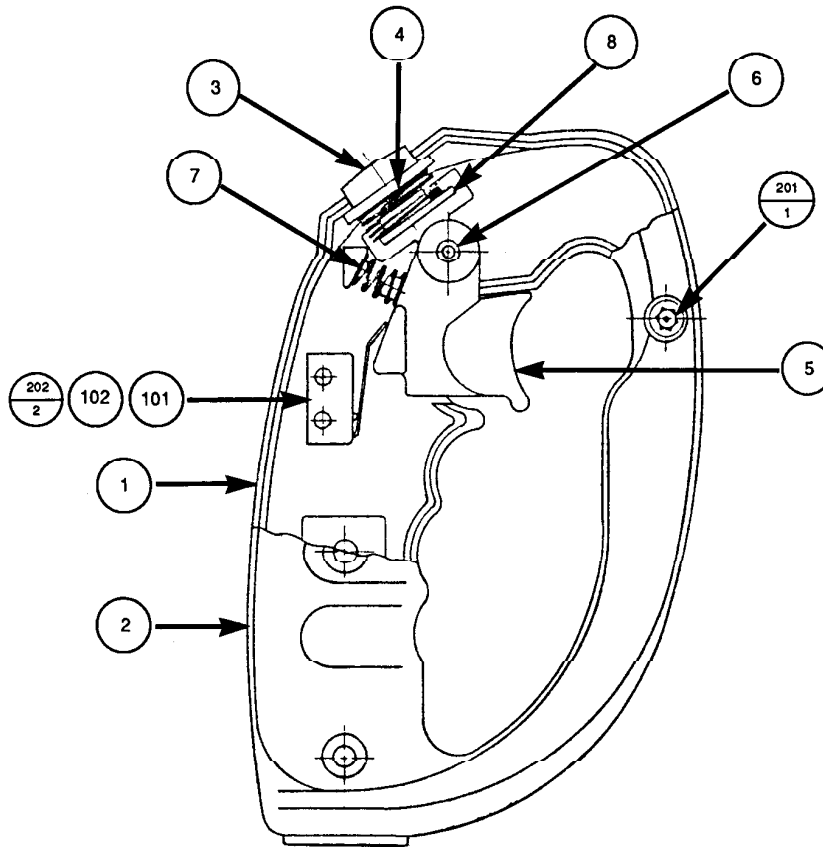

HANDLE GRIP ASSEMBLY PARTS LIST

ITEM	PARTS NUMBER	DESCRIPTION
1	TX-1336	HANDLE GRIP LEFT
2	TX-1337	HANDI F GRIP RIGHT
3	TX-1338	BUTTON
4	TX-1339	COMPRESSION SPRING
5	CD-2041	TRIGGER
6	CD-2042	SHAFT TRIGGER
7	125-0011	COMPRESSION SPRING
8	839-0087	SWITCH BOARD
9	600-5521	WIRE HARNESS, HANDLE GRIP
101	509-0058	MICRO SWITCH
201	029-0052	TMP PRF SCR PH M5 X 10
202	029-0134	M SCR PH M2 X 10

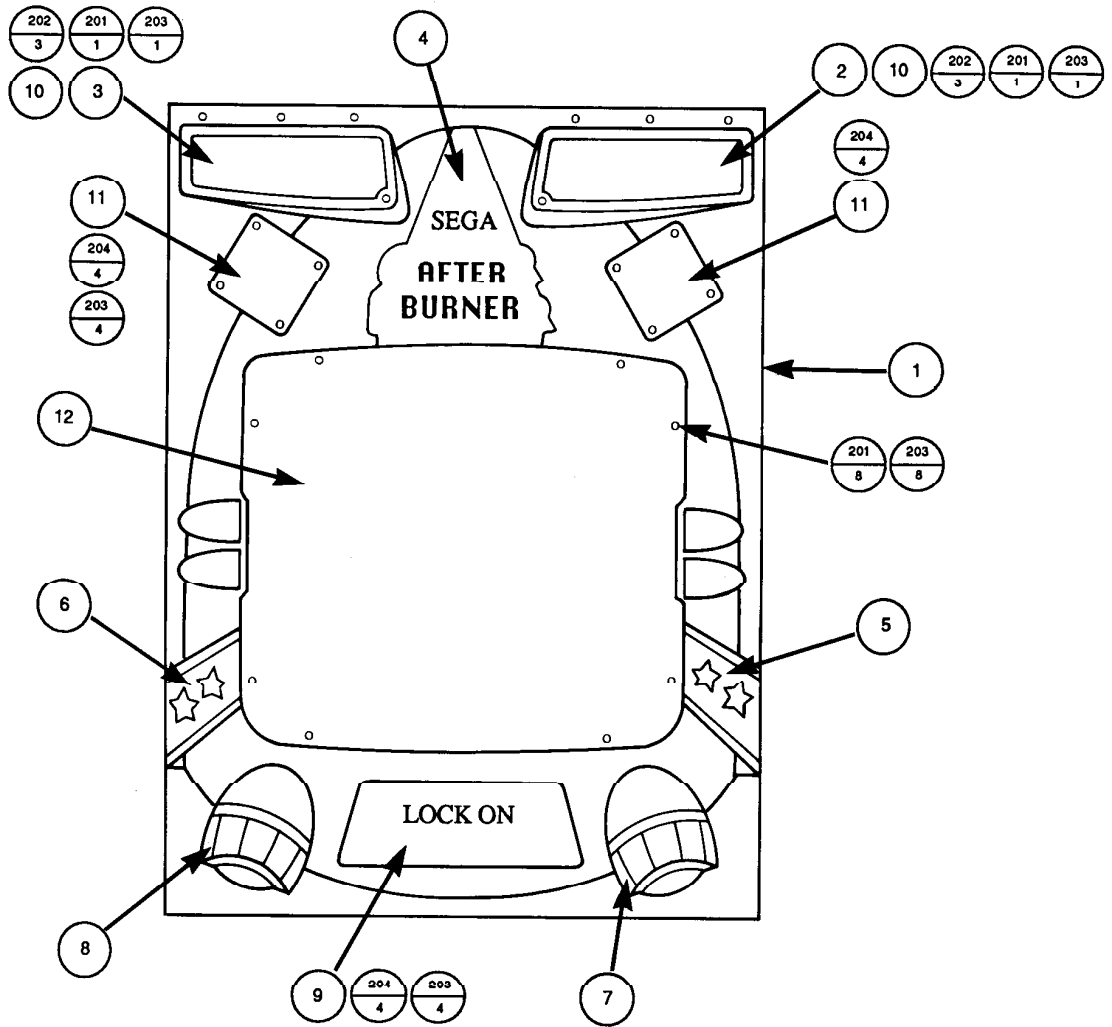

FRONT MASK ASSEMBLY PARTS LIST

ITEM	PARTS NUMBER	DESCRIPTION
1	TX1-1616-A	FRONT PANEL W/OUT MASK
2	TX1-1616-B	PLATE R
3	TX1-1616-C	PLATE L
4	TX1-1616-D	STICKER, AFTER BURNER
5	TX1-1616-E	STICKER, SIDE R
6	TX1-1616-F	STICKER, SIDE L
7	TX1-1616-G	STICKER, JET NOZZLE R
8	TX1-1616-H	STICKER, JET NOZZLE L
9	TX1-1616-J	PLATE, LOCK-ON
10	TX1-1616-K	BRACKET
11	TX1-1616-L	GUARD PLATE, SPEAKER
12	TX1-1616-AX	SCREEN, CLEAR SMOKE
201	008-0416	TMP SCR M4X16
202	031-0414-B	CARRIAGE BOLT BLACK M4X14
203	051-0004	FLANGE NUT M4

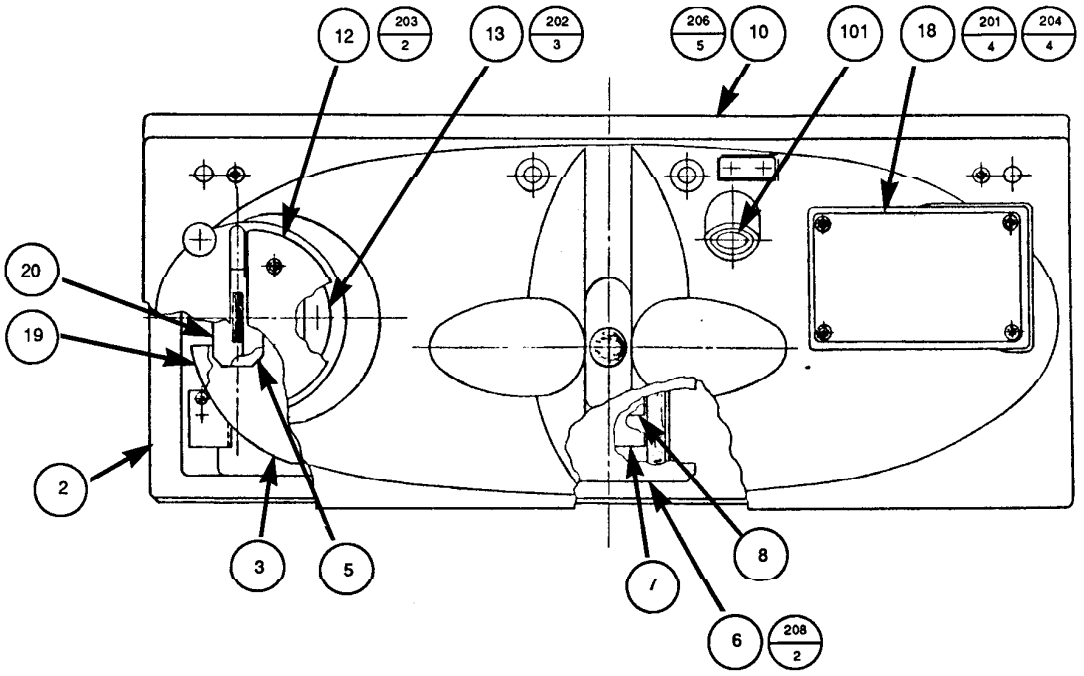
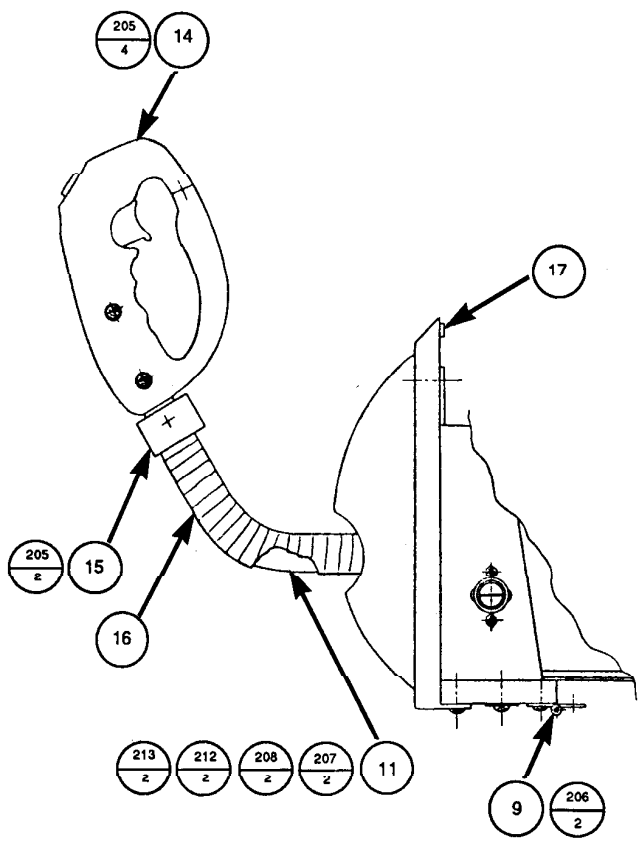

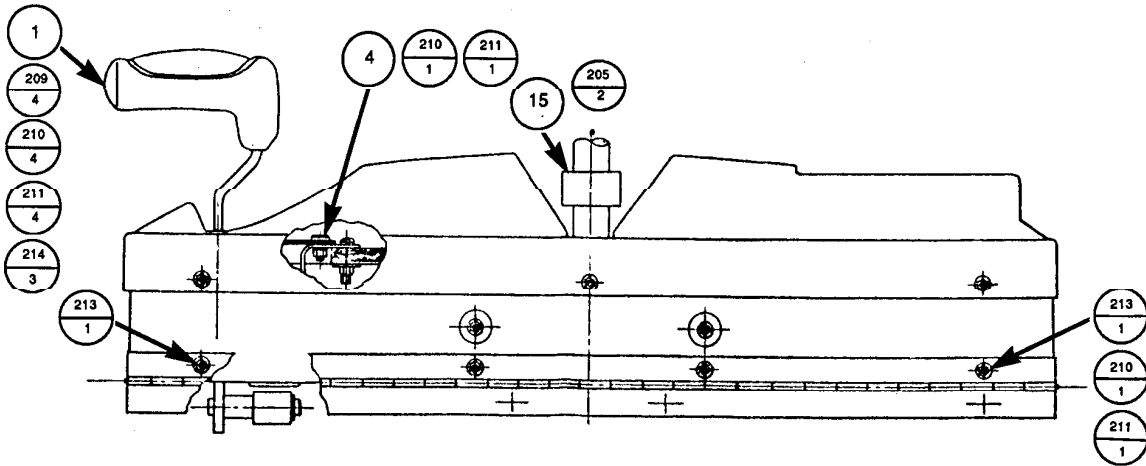

CONTROL PANEL ASSEMBLY PARTS LIST

ITEM	PARTS NUMBER	DESCRIPTION
1	TX-14001	ASSEMBLY THROTTLE
2	TX-1341	CON PANEL BASE
3	TX-1342	FLAG PLATE
4	TX-1343	SHLDER SCREW
5	TX-1344	COVER
6	TX-1345	GUIDE PLATE
7	TX-1346	SLIDE PLATE A
8	TX-1347	SLIDE PLATE B
9	TX-1366	HINGE 590
10	TX-1348	CONTROL PANEL COVER
11	TX-1350	ASSEMBLY CONTROLLER
12	TX-1349	THROTTLE COVER
13	TX-1367	COVER HOLDER
14	TX-1335	ASSEMBLY HANDLE GRIP
15	TX-1310	HOLDER A
16	TX-1356	PROTECT TUBE
17	HN-1069	RUBBER CUSHION
18	422-0209	PLAY INSTRUCTION PLATE
19	TX-1369	FLAG
20	TX-1370	COVER A
101	509-5050	START SWITCH W/LMAP
201	059-0014	WELL NUT M4
202	001-0406	M SCR FH M4 X 6
203	008-0408	TMP PRF SCR M4 X 8
204	008-0416	TMP PRF SCR M4 X 16
205	029-0052	TMP PRF SCR M5 X 10
206	08-0516	TMP PRF SCR M5 X 16
207	008-0520	TMP PRF SCR M5 X 20
208	000-0516-FS	M SCR PH W/FS M5 X 16
209	000-0525	M SCR PH M5 X 25
210	061-0005	SPR WSHR M5
211	054-0005	U NUT M5
212	069-0064	FLT WSHR BLK 5.5-20 X 6
213	008-0525	TMP PRF SCR TH M5 X 25
214	005-3113-F	W SCR PH W/F 3.1 X 13

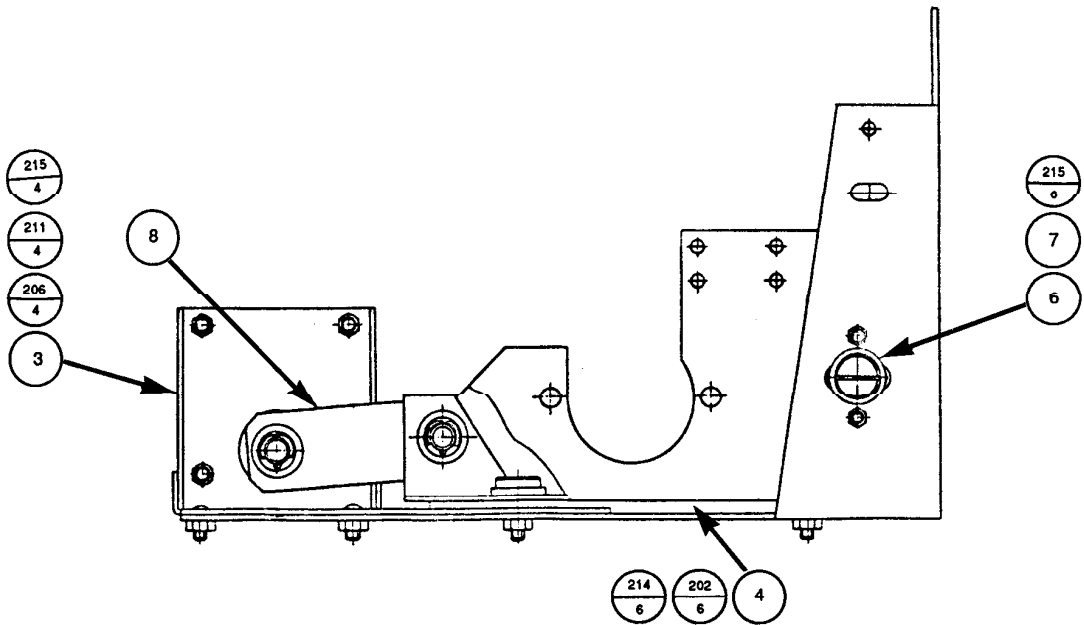
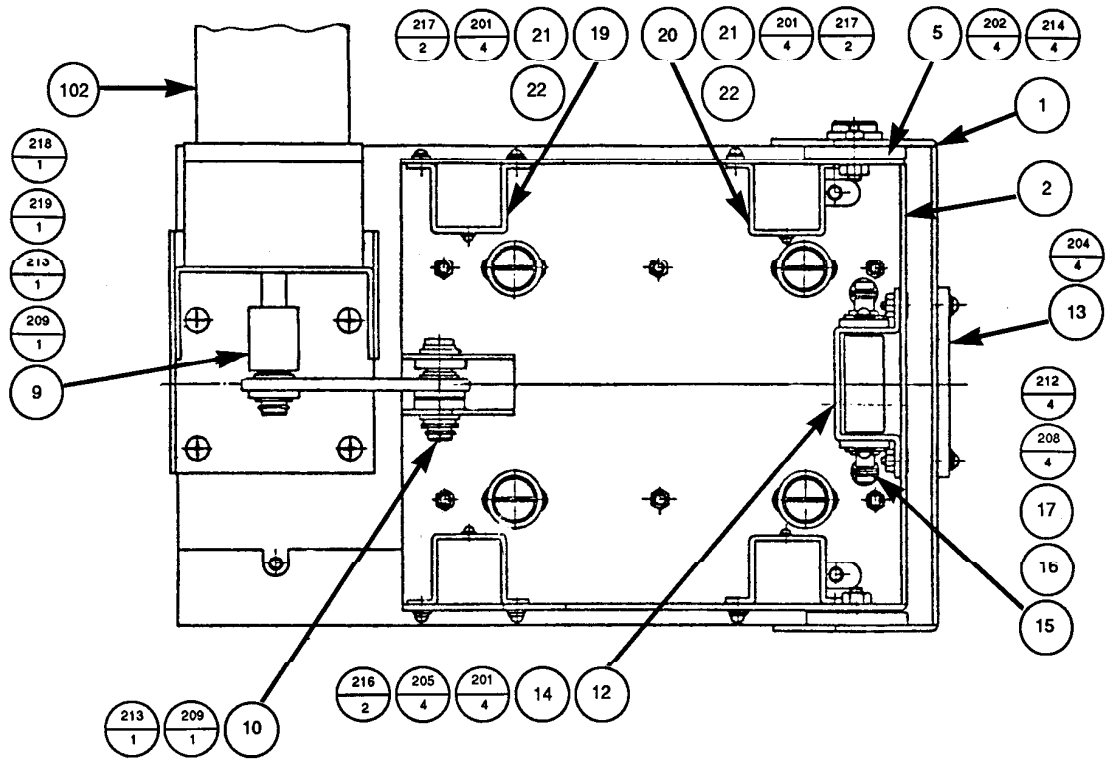

SHOCK MECHANICAL UNIT PARTS LIST

ITEM	PARTS NUMBER	DESCRIPTION
1	TX-1353	MAIN BASE
2	TX-1354	MOVING BASE
3	TX-1357	MOTOR BRACKET
4	TX-1358	SLIDE PLATE BOTTOM
5	TX-1359	SLIDE PLATE SIDE
6	TX-1360	GUIDE WASHER
7	TX-1361	SHOULDER SCREW
8	TX-1362	ROD
9	TX-1363	CAM
10	TX-1364	SHAFT
12	TX-1325	SPRING BRACKET
13	TX-1326	FRONT GUIDE
14	TX-1327	SIDE PLATE
15	TX-1328	SHAFT B
16	TX-1329	PIPE
17	TX-1330	EXT. SPRING
19	TX-1331	HOLDER L
20	TX-1332	HOLDER R
21	TX-1333	BUMPER B
102	350-5113	MOTOR DC45V
201	000-0412-FS	M SCR M4 X 12
202	001-0414	M SCR M4 X 14
204	000-0510-FS	M SCR M5 X 10
205	000-0512	M SCR M5 X 12
206	029-0035	M SCR M6 X 12
208	060-0008	FLT WSHR M8
209	060-0010	FLT WSHR M10
211	061-0006	SPR WSHR M6
212	065-0006	E RING 6mm
213	045-0022	COT PIN 2.5 X 20
214	054-0004	U NUT M4
215	054-0006	U NUT M6
216	054-0005	U NUT M5
217	000-0305-S	M SCR M3 X 5
218	028-0012	SET SCREW SPECIAL M5 X 12
219	045-0014	SPR PIN 3 X 26

WIRING DIAGRAM

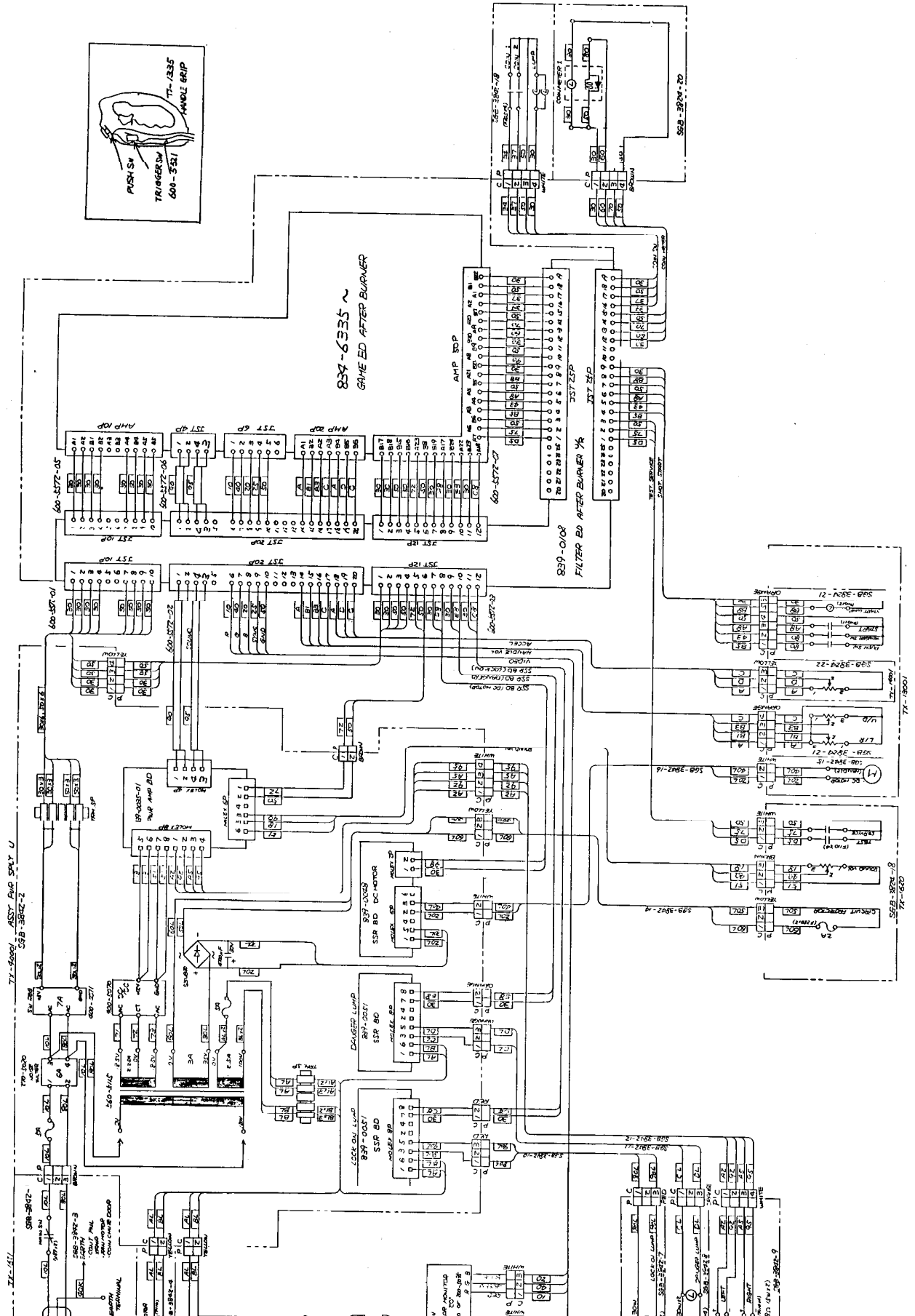

SEGA ENTERPRISES, INC. (USA)

2149 Paragon Drive
San Jose, CA 95131

Tel (408) 435-0201

©SEGA 1987

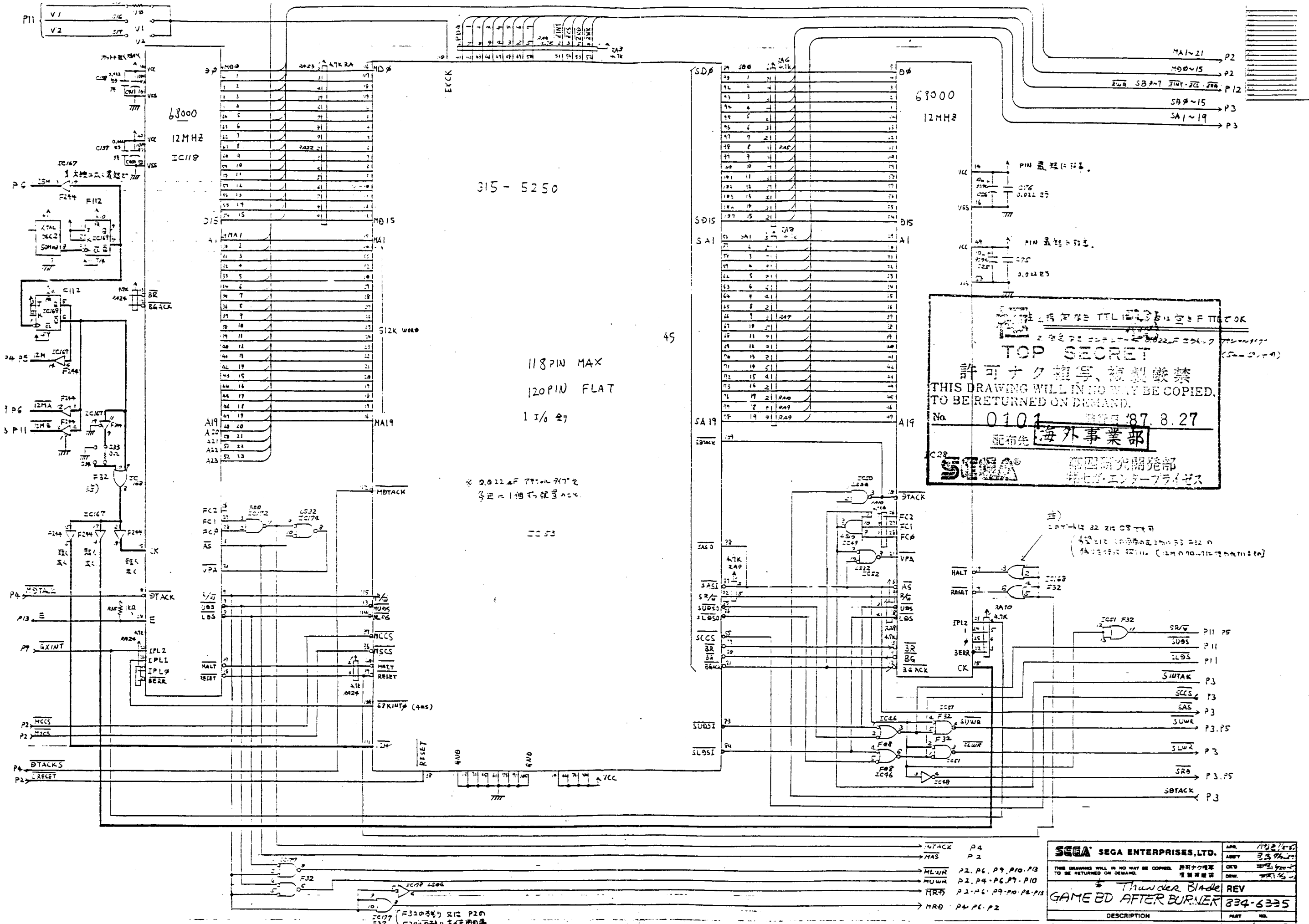

315-5250

118PIN MAX
120PIN FLAT
1 1/8"

TOP SECRET

許可なく複写、複製厳禁
THIS DRAWING WILL IN NO WAY BE COPIED,
TO BE RETURNED ON DEMAND.

No. 0101 87.8.27

配布先 海外事業部

SEGA 第四研究開発部
第七期エンタープライゼス

SEGA SEGA ENTERPRISES, LTD.		APR. 1987.11.15
THIS DRAWING WILL IN NO WAY BE COPIED, TO BE RETURNED ON DEMAND. 許可なく複写、複製厳禁		ABBY 3.3.87.11.15
* Thunder Blade		REV
GAME BD AFTER BURNER		834-6335
DESCRIPTION		PART NO.
Main PCB CPU		SHEET / OF 13

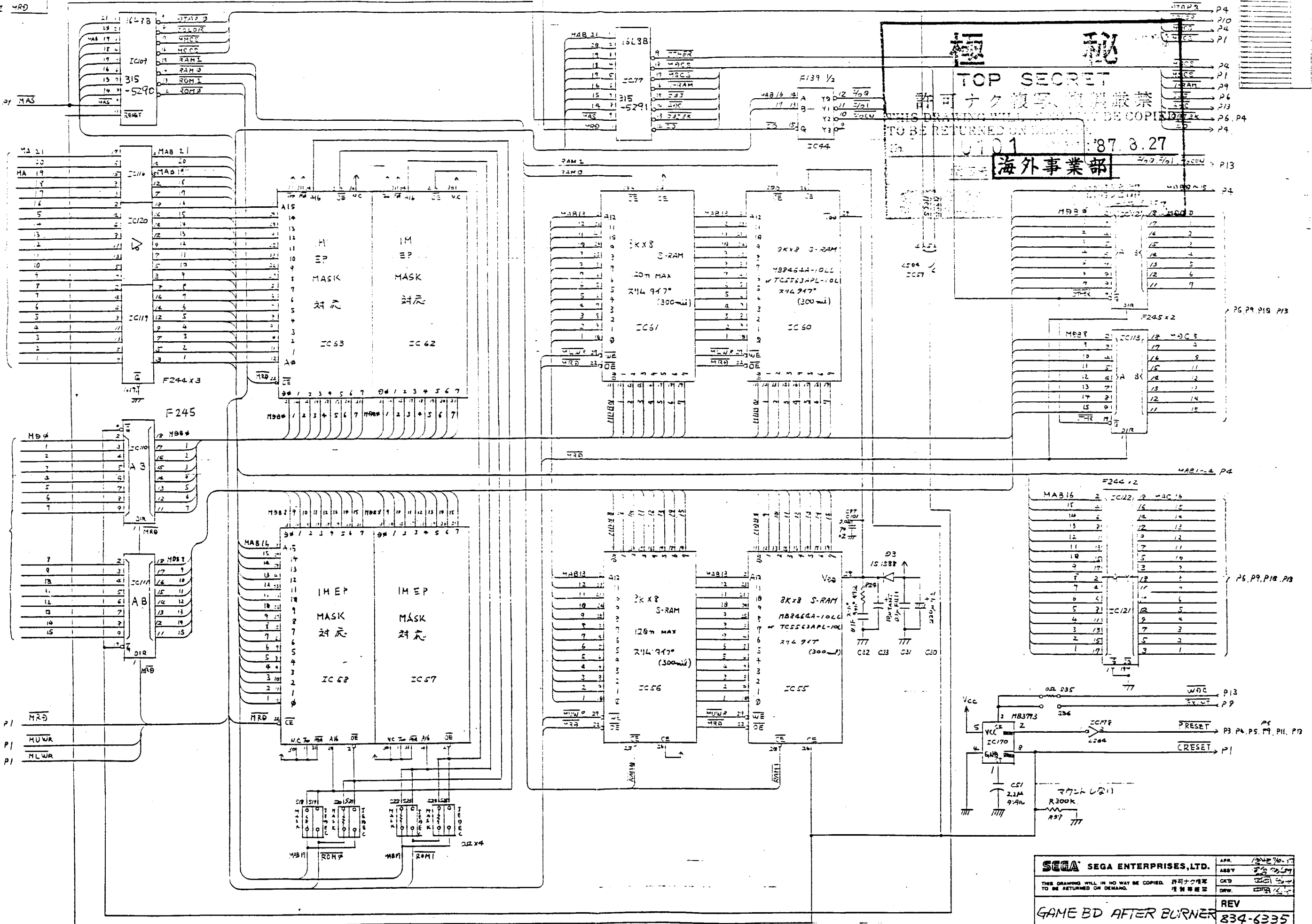

極 秘

TOP SECRET

許可なく複製、複製厳禁
THIS DRAWING WILL NOT BE COPIED
TO BE RETURNED ON DEMAND.

0101 87. 8. 27

海外事業部

SEGA SEGA ENTERPRISES, LTD.		APP. 1987. 8. 27
THIS DRAWING WILL IN NO WAY BE COPIED. 許可なく複製、複製厳禁 TO BE RETURNED ON DEMAND. 複製厳禁		ASBY 2/2/87
GAME BD AFTER BURNER		REV 834-6335
DESCRIPTION	PART NO.	SHEET 2 OF 13

P1 SIUTAK

P1 SAS

P1

P1

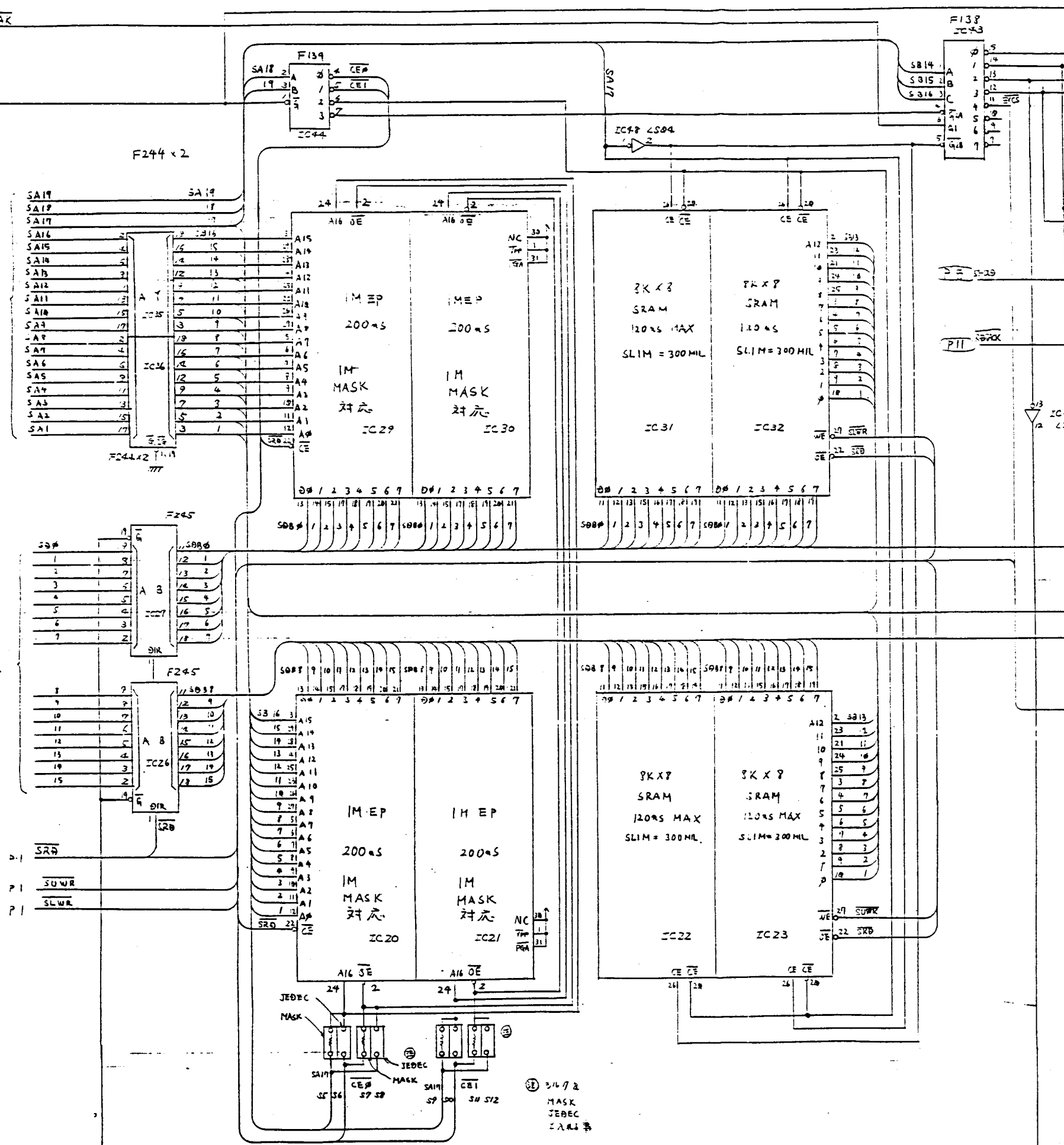

極秘
TOP SECRET
 許可なく複写、複製厳禁
 THIS DRAWING WILL IN NO WAY BE COPIED,
 TO BE RETURNED ON DEMAND.
 No. 0101 発行日 '87. 8. 27
 海外事業部
 海外事業部
 システム開発部
 システム開発部

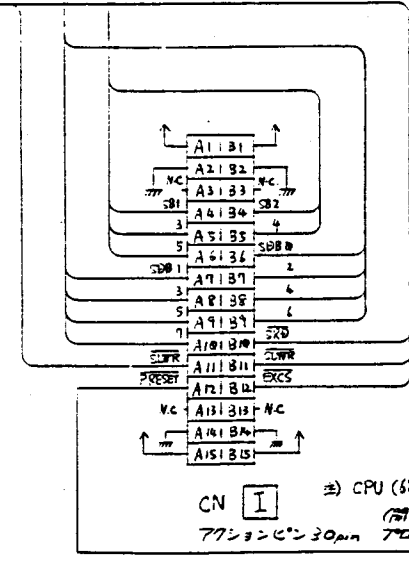

SEGA SEGA ENTERPRISES, LTD.	APR 1987
THIS DRAWING WILL IN NO WAY BE COPIED, 許可なく複写 TO BE RETURNED ON DEMAND. 複製厳禁	ASBY 2.2.76-4
DESCRIPTION	REV
GAME BD AFTER BURNER	834-6335
Sub CPU Rom & Ram	PART NO.
	SHEET 3 OF 13

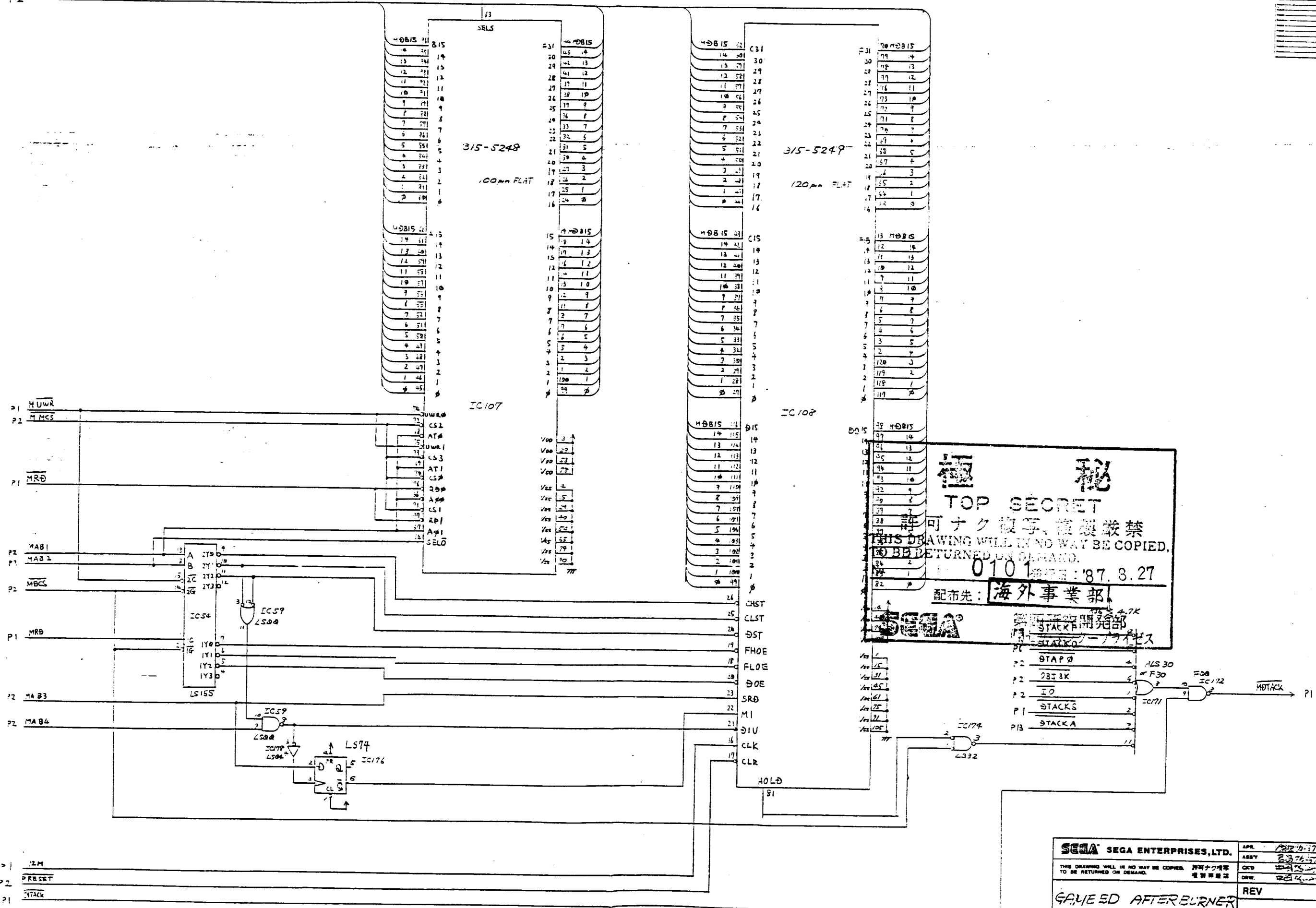
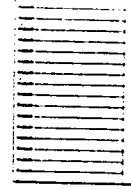

極 秘
TOP SECRET
 許可ナク複写、複製厳禁
 THIS DRAWING WILL IN NO WAY BE COPIED,
 NOR BE RETURNED ON DEMAND.
 0101
 1987. 8. 27
 配布先: 海外事業部

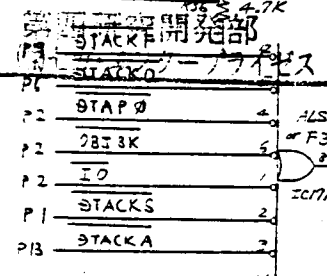

P1 12M
 P2 PRBSRT
 P1 YTACK

SEGA SEGA ENTERPRISES, LTD.		APR. 1987. 8. 27
THIS DRAWING WILL IN NO WAY BE COPIED, TO BE RETURNED ON DEMAND.		ASBY 870827
GAVE ED AFTER BURNER		CKD 870827
DESCRIPTION		DRW. 870827
PART NO.	REV	
SHEET 4 OF 12		

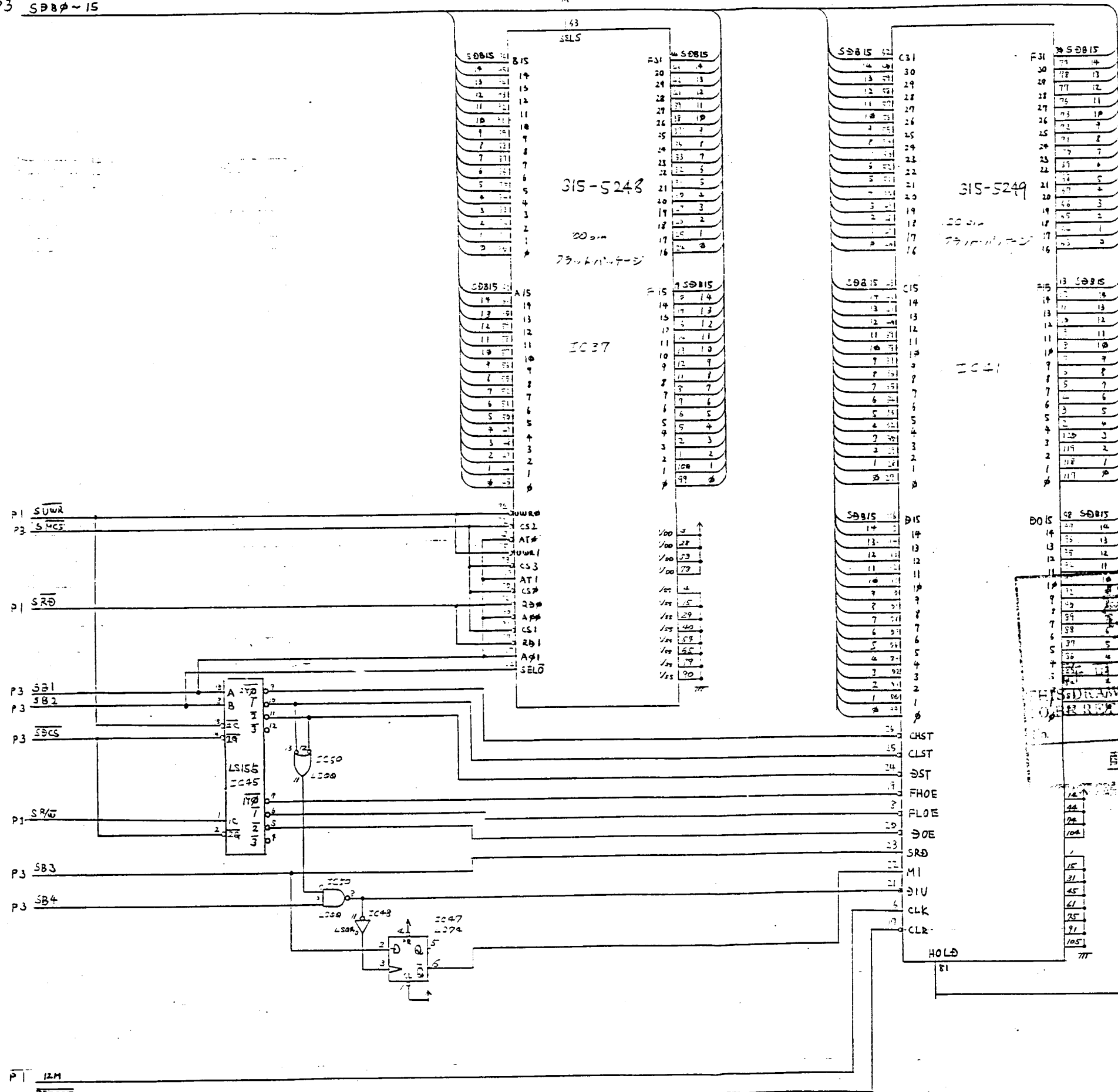
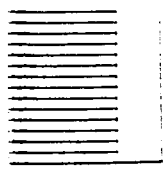

TOP SECRET
 コピー、複製厳禁
 THIS DRAWING WILL IN NO WAY BE COPIED,
 OR BE RETURNED ON DEMAND.
 0101 発行日 1978.8.27
 配前先: **海外事業部**
 第四研究開発部
 エンタープライゼス

HOLD → P3

P1 12M
 P2 PRESET

SEGA SEGA ENTERPRISES, LTD.		APP.	2001-17
THIS DRAWING WILL IN NO WAY BE COPIED, OR BE RETURNED ON DEMAND. 許可なく複製、複製厳禁		ASBY	2001-17
GAMEED AFTER BURNER		CKD	2001-17
		DRW.	2001-17
DESCRIPTION		REV	
		PART	NO.
		SHEET	20

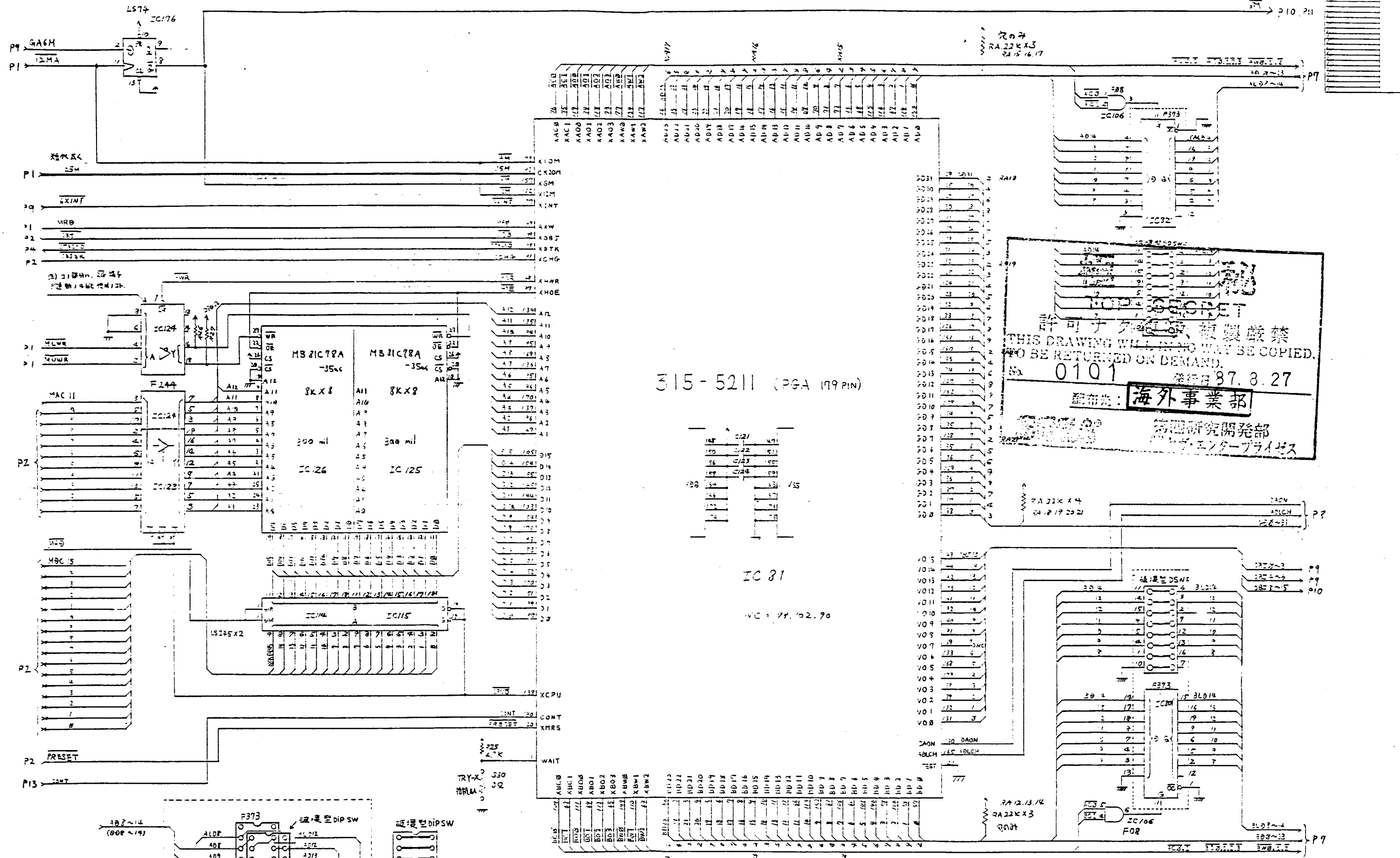

315-5211 (PGA 199 PIN)

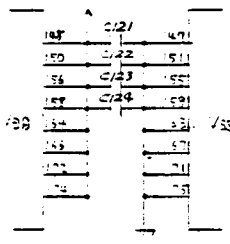

IC 81

VC = 74.02.90

許可なく複製厳禁
THIS DRAWING WILL IN NO WAY BE COPIED.
NO BE RETURNED ON DEMAND.
No. 0101 発行日 87. 8. 27
配布先: 海外事業部
第四研究開発部
エンタープライゼス

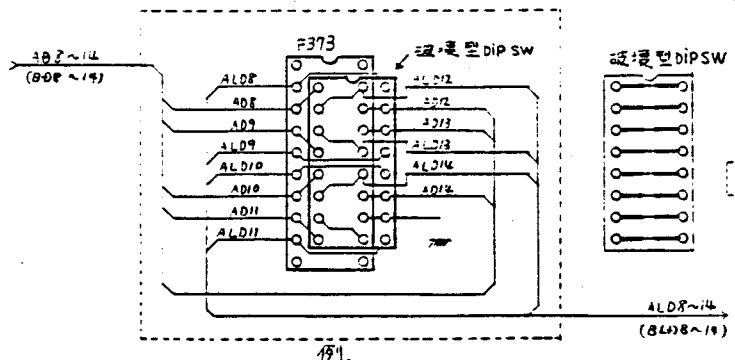

当該回路の回路は、F373、破損型DIP SWの利し替えにより、A108~114の出力は、A08~14のみが出力され、A08~14の出力として使用でき、換しアウトする。
②、破損型DIP SWは0.02x2で代用してもOK

SEGA SEGA ENTERPRISES, LTD.		APR. 1987
THIS DRAWING WILL IN NO WAY BE COPIED. 許可なく複製厳禁 NO BE RETURNED ON DEMAND. 複製厳禁		ASSY. 230527
GAME BD AFTER BURNER		REV
DESCRIPTION		PART NO.
Motion Window CKT		SHEET 6 OF 8

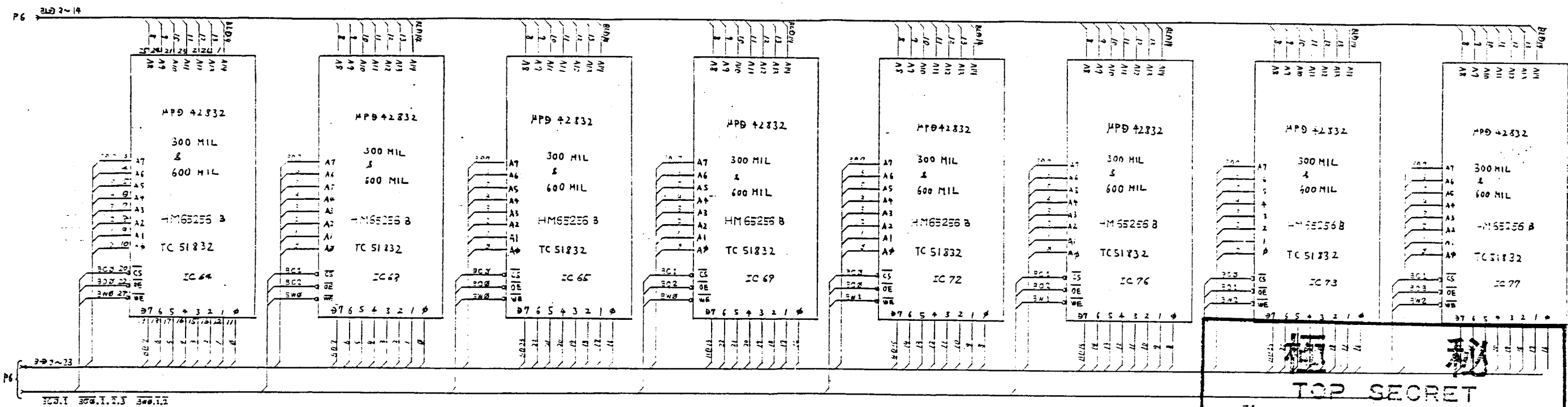
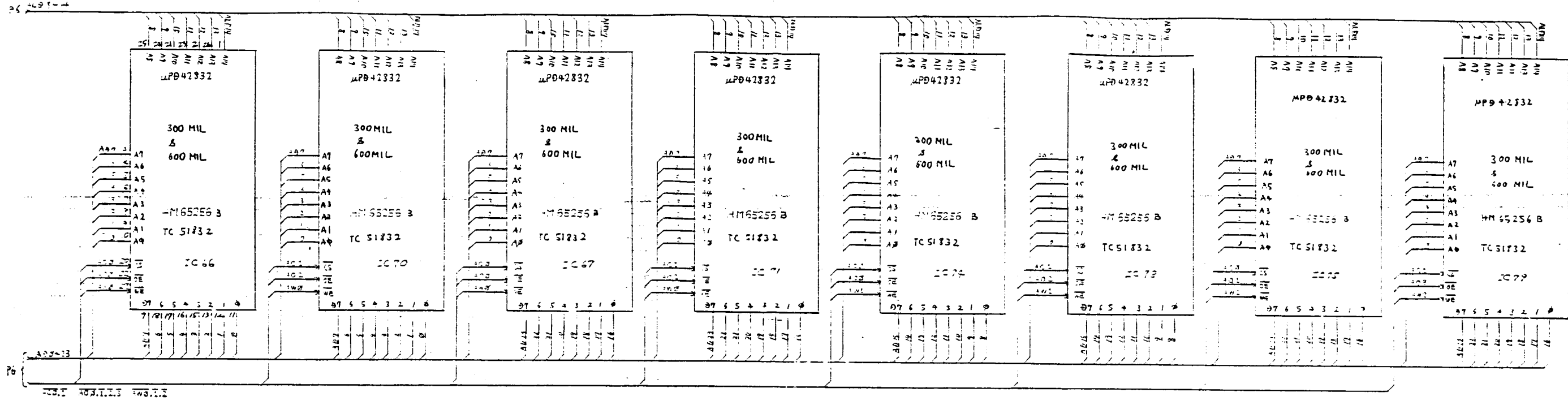

(19)

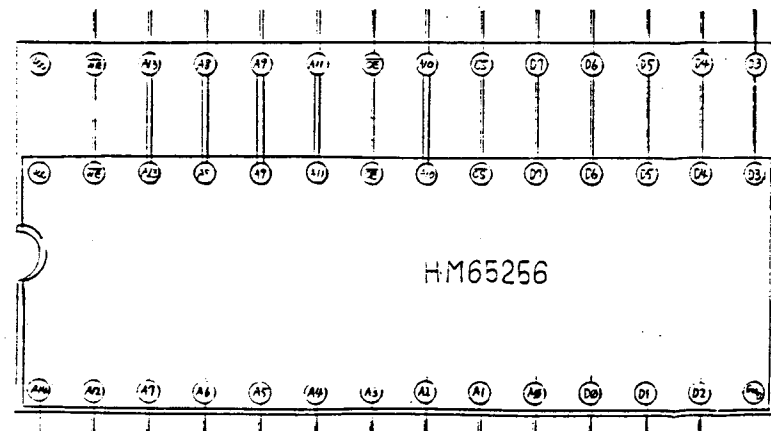

- HM65256 μ PD42832 . TC51832 について.
- HM65256を使用する場合は PSで DIP SW を使用す
 - μ PD42832 - TC51832 を使用する場合は DIP SW を使用す
 - 77C914 は Acc 6120a とす

秘 密

TOP SECRET

許可なく複製、複製厳禁
THIS DRAWING WILL IN NO WAY BE COPIED,
TO BE RETURNED ON DEMAND.

0101 0001 '87 8.27

配付先: **海外事業部**

研究開発部
システム部

SEGA SEGA ENTERPRISES, LTD.	APP. 1/22/87
THIS DRAWING WILL IN NO WAY BE COPIED, TO BE RETURNED ON DEMAND.	ASBY 22/87
許可なく複製、複製厳禁	CHKD 中野 22/87
	DRW. 中野 22/87
GAME BD AFTER BURNER	REV
DESCRIPTION	PART NO.
Machine Guns	SHEET 17 of 13

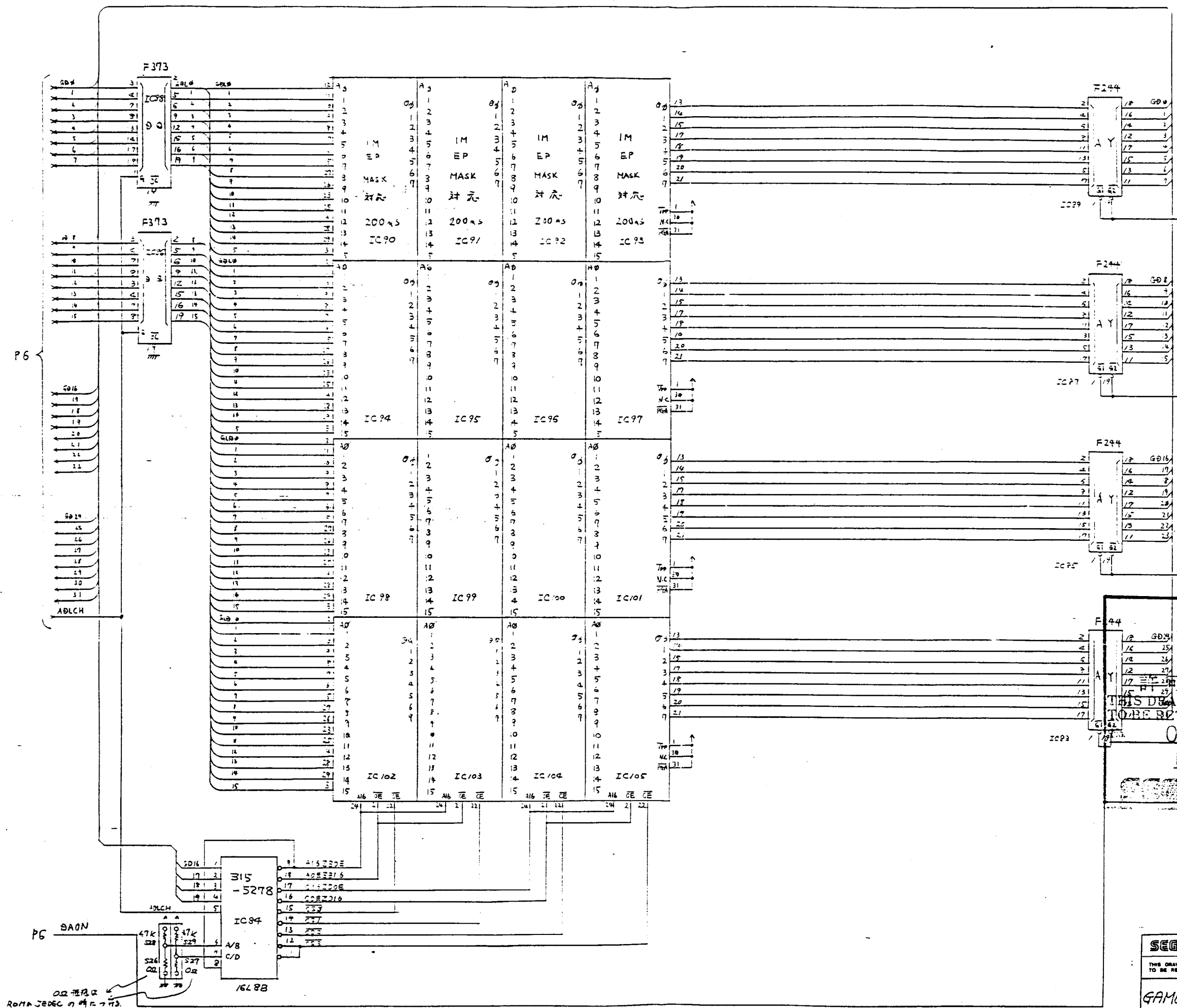

極 秘
TOP SECRET
 許可なく複製、複製厳禁
 THIS DRAWING WILL IN NO WAY BE COPIED,
 TO BE RETURNED ON DEMAND.
 0101 発行日: '87. 8. 27
 配布先: **海外事業部**

SEGA SEGA ENTERPRISES, LTD.	APP	2/2/87
THIS DRAWING WILL IN NO WAY BE COPIED, TO BE RETURNED ON DEMAND.	ASBY	2/2/87
GAME BD AFTER BURNER	CKD	中島
	DRW	中島
DESCRIPTION	REV	
	PART NO.	
	SHEET	2 of 13

Motion Picture Table

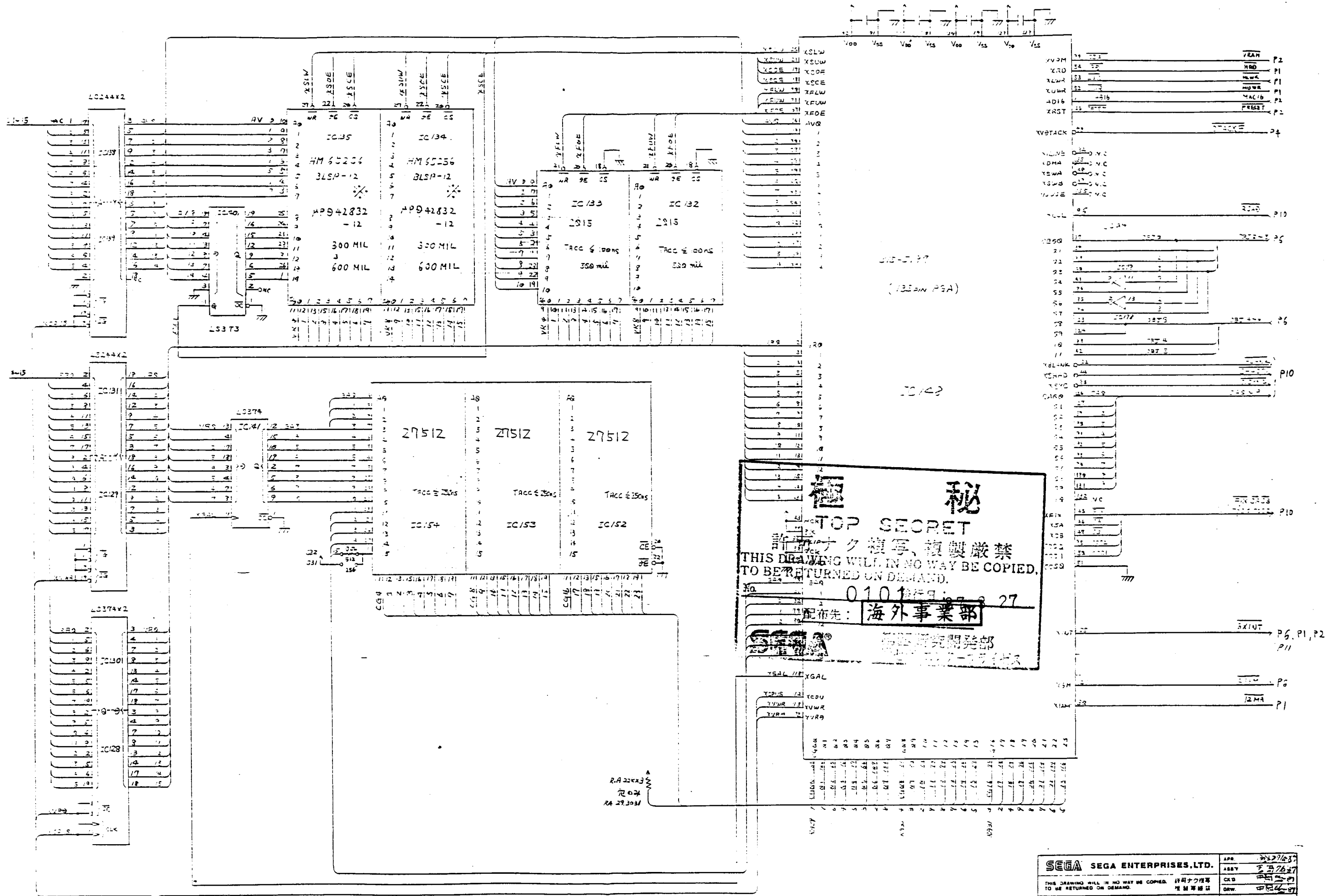

HM 65256 X2 = 1個/77 9.922

SEGA SEGA ENTERPRISES, LTD.	APR 20/83
THIS DRAWING WILL IN NO WAY BE COPIED, TO BE RETURNED ON DEMAND. 此図面は複製厳禁	ASBY 多田 26/87
SAME ED AFTER BURNER	CKD 多田 26/87
DESCRIPTION	DRW 多田 26/87
Background CRT	REV
	PART NO.
	SHEET 7 of 13

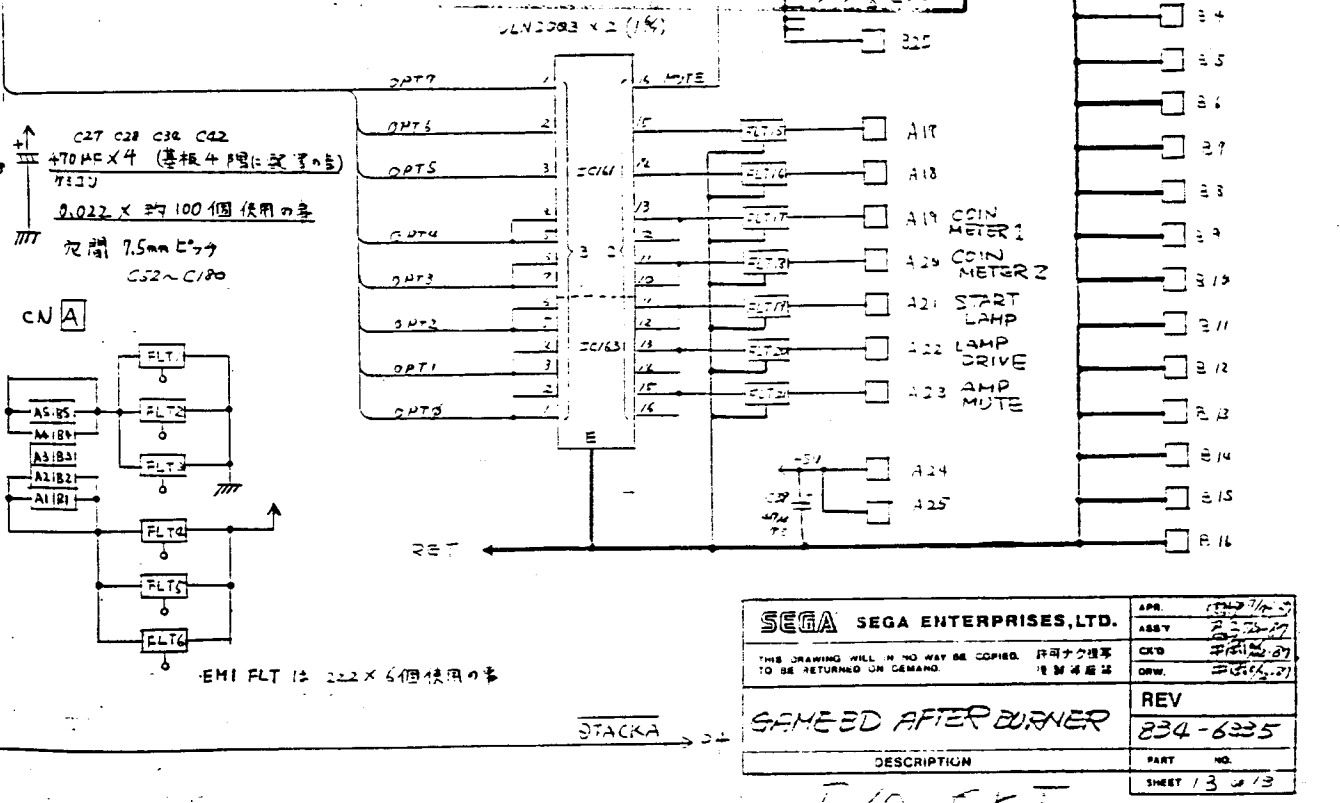
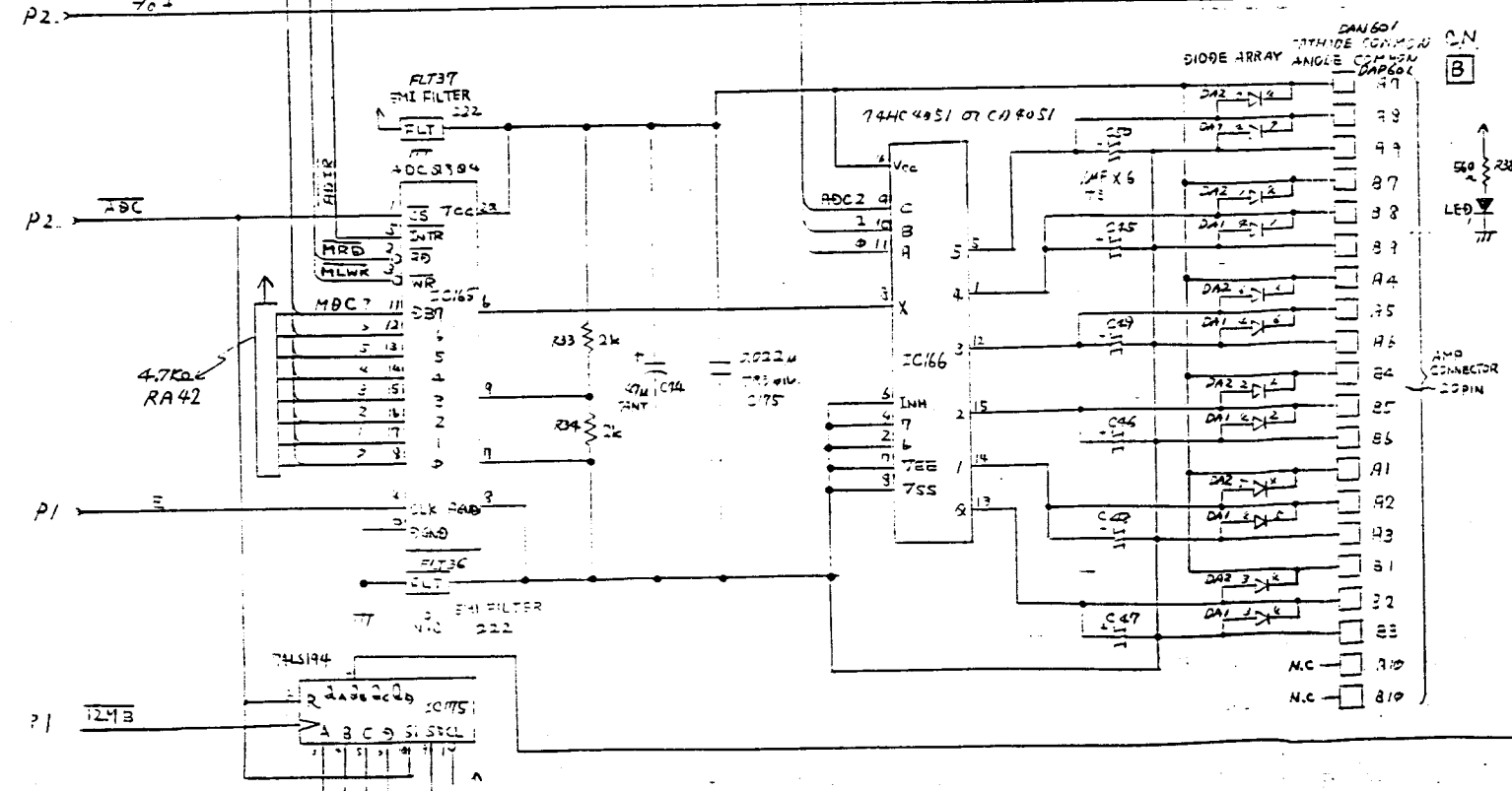
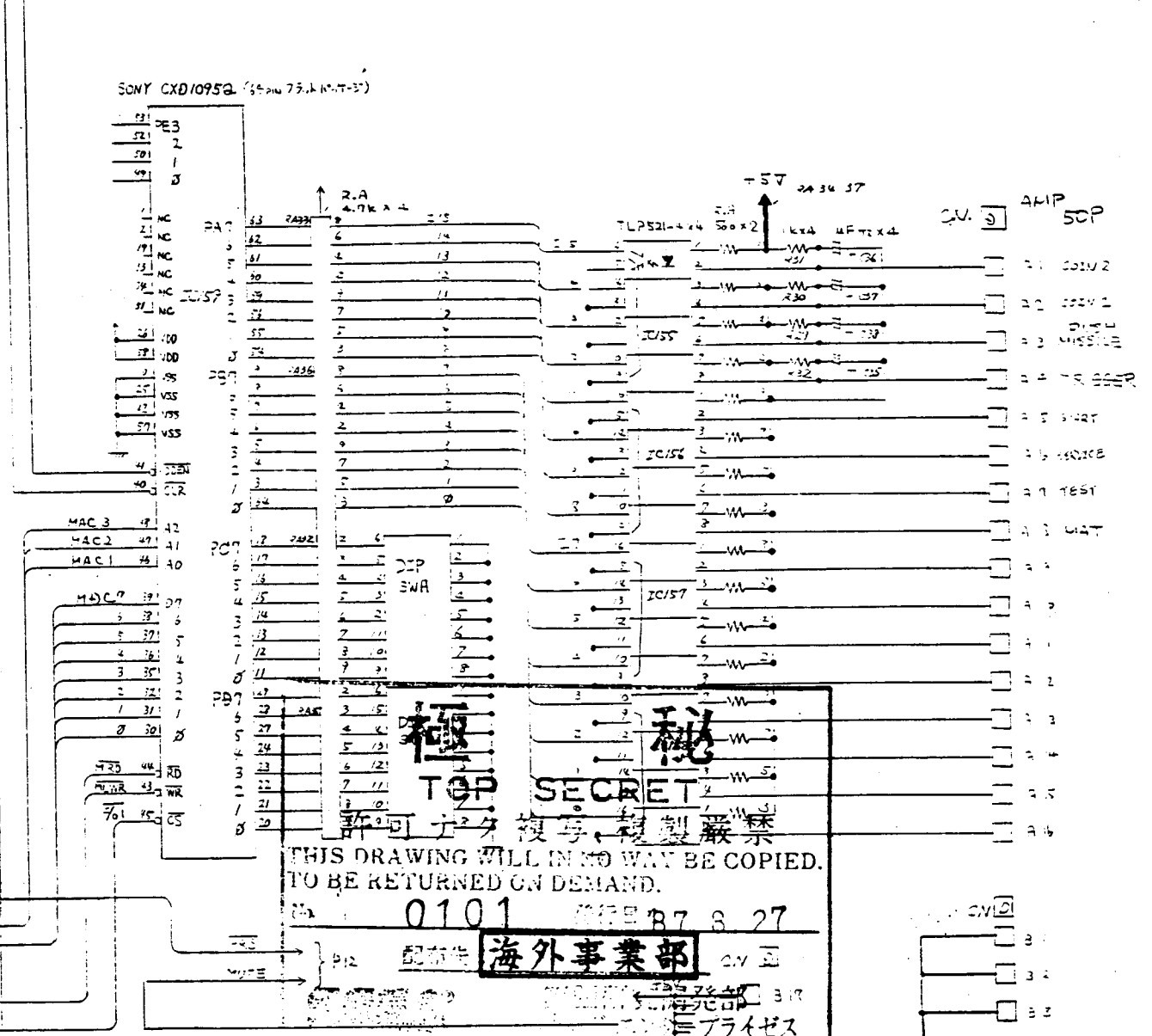
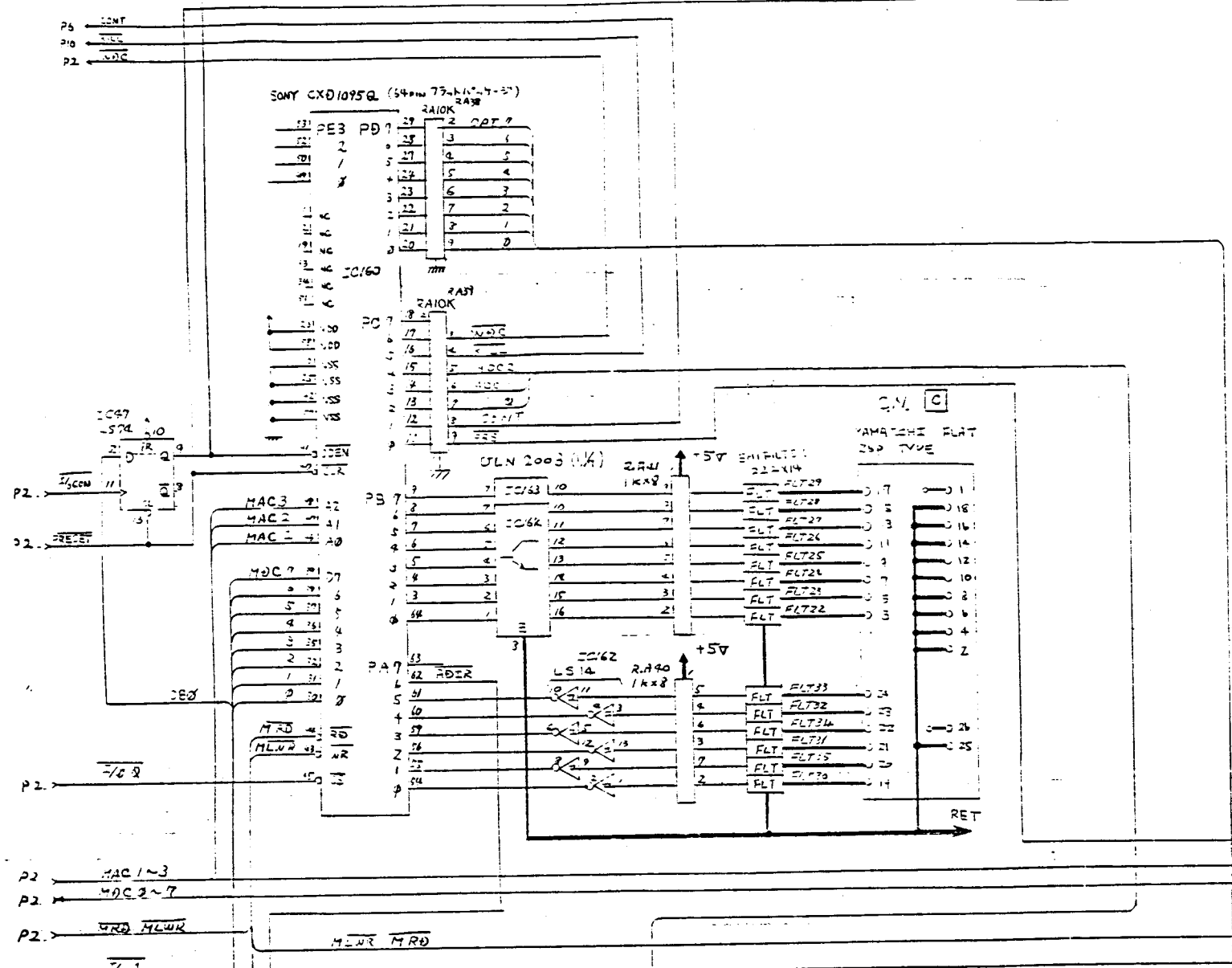

極秘
TOP SECRET
許可なく複製・複製厳禁

THIS DRAWING WILL IN NO WAY BE COPIED.
TO BE RETURNED ON DEMAND.

0101 778 B7 8 27

海外事業部

ブライゼス

SEGA SEGA ENTERPRISES, LTD.		APP	REV
THIS DRAWING WILL IN NO WAY BE COPIED. 許可なく複製・複製厳禁		ASSY	834-6335
TO BE RETURNED ON DEMAND. 許可なく複製・複製厳禁		CRD	834-6335
DRAW		REV	834-6335
DESCRIPTION		PART	NO.
STACKA		I/O CKT	
SHEET 13 of 13			