

Applications of Pointers (1A)

Copyright (c) 2024 - 2010 Young W. Lim.

Permission is granted to copy, distribute and/or modify this document under the terms of the GNU Free Documentation License, Version 1.2 or any later version published by the Free Software Foundation; with no Invariant Sections, no Front-Cover Texts, and no Back-Cover Texts. A copy of the license is included in the section entitled "GNU Free Documentation License".

Please send corrections (or suggestions) to youngwlim@hotmail.com.
This document was produced by using LibreOffice.

& address-of operator

* dereference operator

Address-of operator and dereferencing operator

*the address of a variable :
address-of operator **&***

*the content at an address :
dereferencing operator ******

& variable :
returns the address of a variable

variable *has memory locations
whose value can be changed
by an assignment*

(variable *must be an lvalue*)

*** address** :
returns the value at the address

*** address** *has memory locations
whose value can be changed
by an assignment*

(* address *is an lvalue*)

Ivalue and rvalue in assignments

an assignment statement

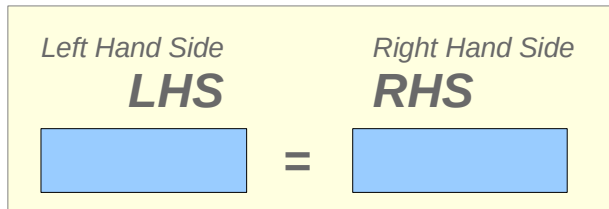

```
int a, b = 10 ;  
int * p, q = &a ;
```

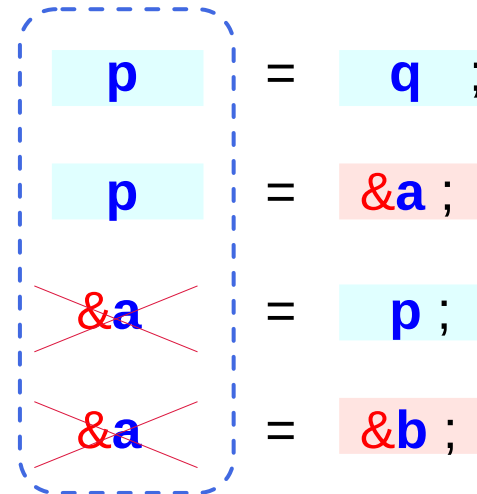
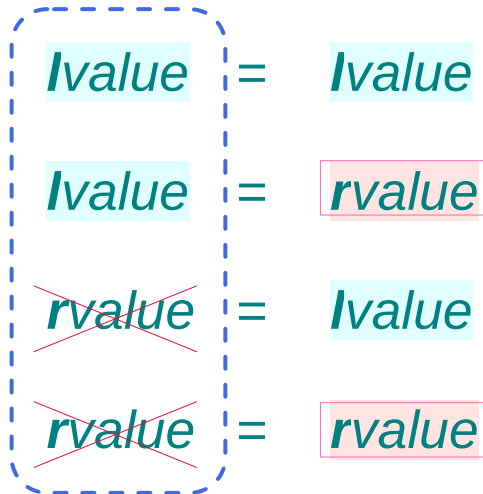

*in the LHS, only Ivalue can exist
rvalue can exist only in the RHS*

| | | | |
|------------|-----------|---------------|--------|
| a, b, p, q | : Ivalues | ... variables | ... RW |
| *p, *q | : Ivalues | ... variables | ... RW |
| &a, &b | : rvalues | ... constants | ... RO |

Ivalue and rvalue with * and & operators

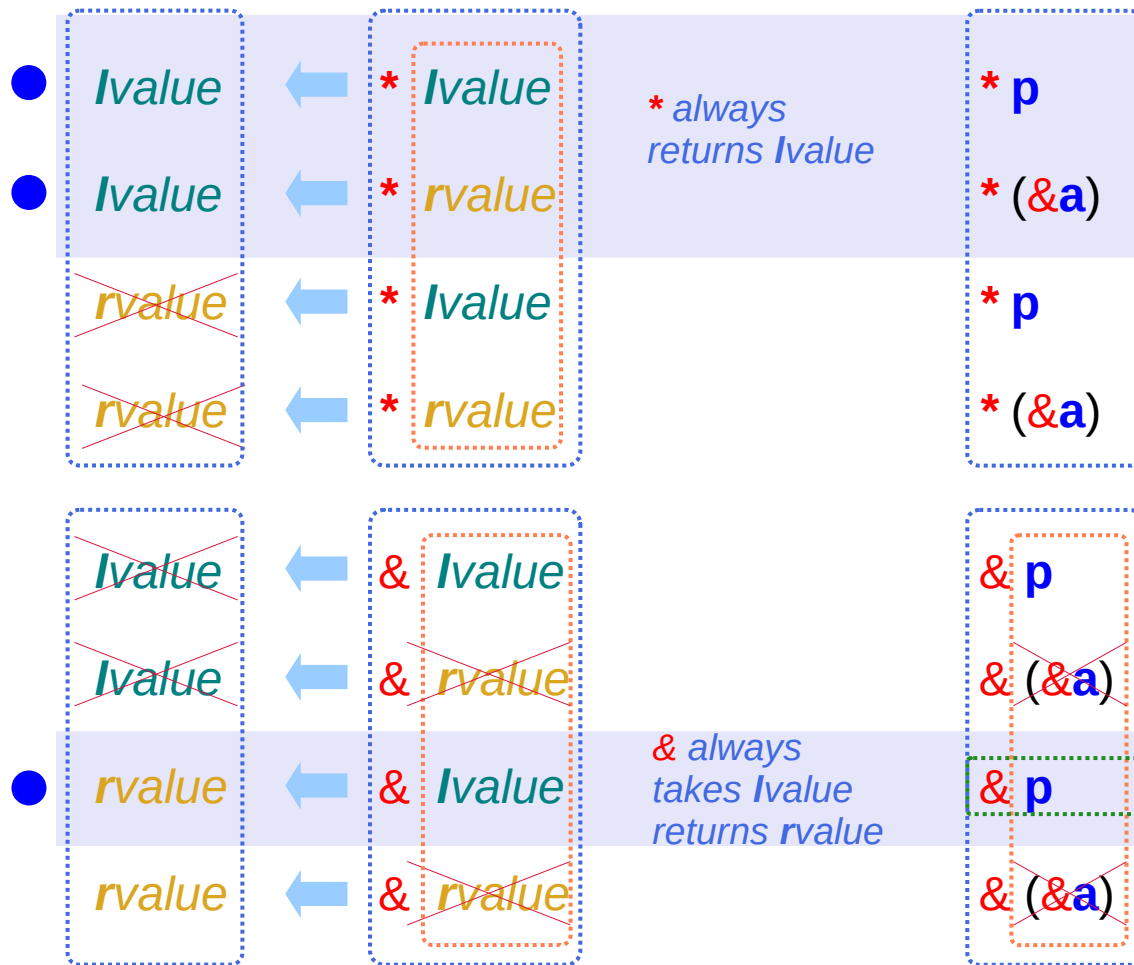

```
int a = 10 ;
int * p = &a ;
```

* can be applied to either an **lvalue** variable or a **rvalue** address

* **operand** becomes an **lvalue** variable thus can be applied successively.

& can be applied to only an **lvalue** variable and returns only an **rvalue** address

| | | | |
|---------------|-----------|---------------|--------|
| a, p | : lvalues | ... variables | ... RW |
| *p | : lvalues | ... variables | ... RW |
| &a | : rvalues | ... constants | ... RO |

Address-of & and dereference * C operators (1)

Primitive Data Type

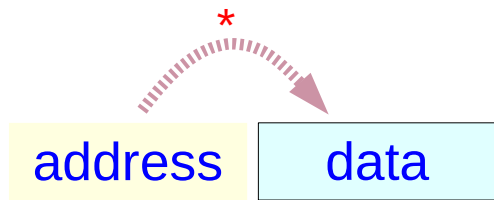

rvalue &a $\xrightarrow{*}$ *Ivalue* a
 constant variable
Ivalue p $\xrightarrow{*}$ *Ivalue* *p
 pointer variable

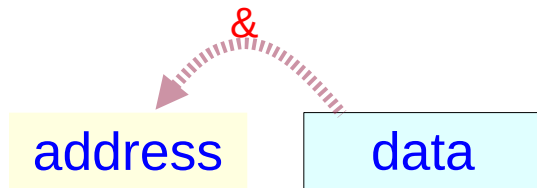

rvalue &a $\xleftarrow{\&}$ *Ivalue* a
 constant variable
~~*Ivalue* p $\xleftarrow{\&}$ *Ivalue* *p~~
~~pointer variable~~

Pointer Data Type

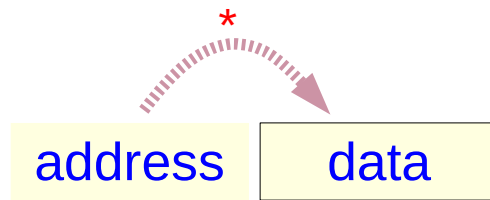

rvalue &q $\xrightarrow{*}$ *Ivalue* q
 constant double pointer
Ivalue q $\xrightarrow{*}$ *Ivalue* *q
 double pointer pointer

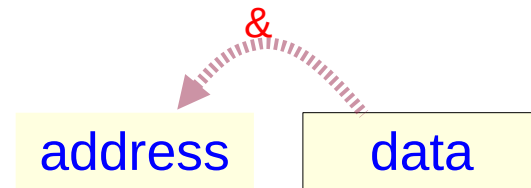

rvalue &q $\xleftarrow{\&}$ *Ivalue* q
 constant double pointer
~~*Ivalue* q $\xleftarrow{\&}$ *Ivalue* *q~~
~~double pointer pointer~~

```
int a ;
int * p ;
int ** q ;
```

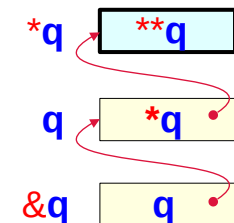
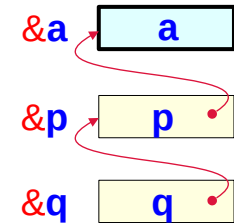

Type, Size, and Value attributes of an **Ivalue**

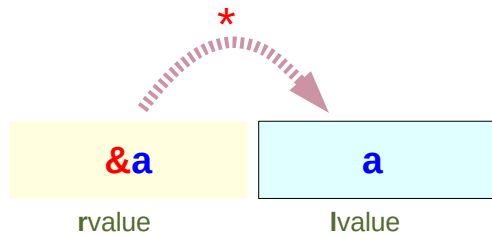

lvalue ← **rvalue*
a ***&a**

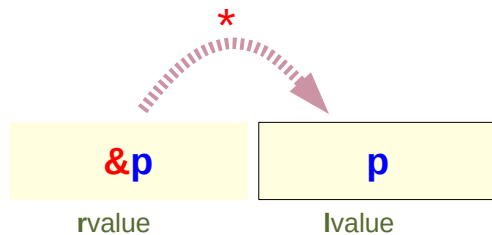

lvalue ← **rvalue*
p ***&p**

Ivalue is associated with a memory location

Ivalue has the following attributes

- Type
- Size
- Value

rvalue has the only attribute

- Value

assume the function `value()`

`value(lvalue)` returns
the **Value** attribute of **lvalue**

`value(rvalue)` returns
the **Value** attribute of **rvalue**

Address-of & and dereference * C operators (1)

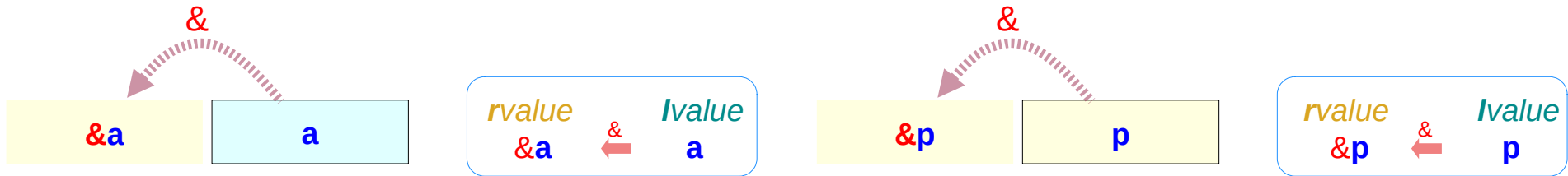
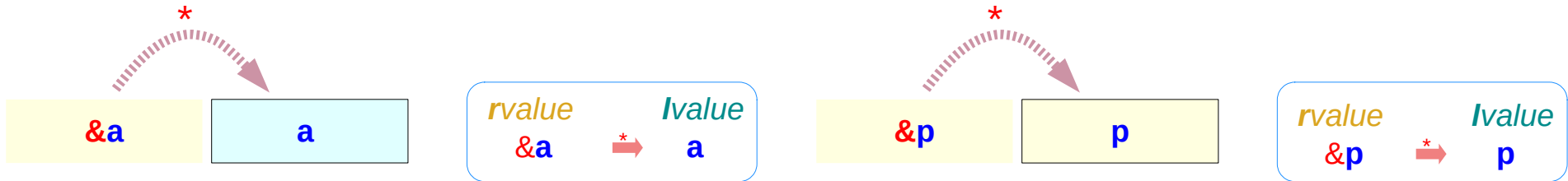

$$*\&a = a$$

$$*\&p = p$$

Address-of & and dereference * C operators (2)

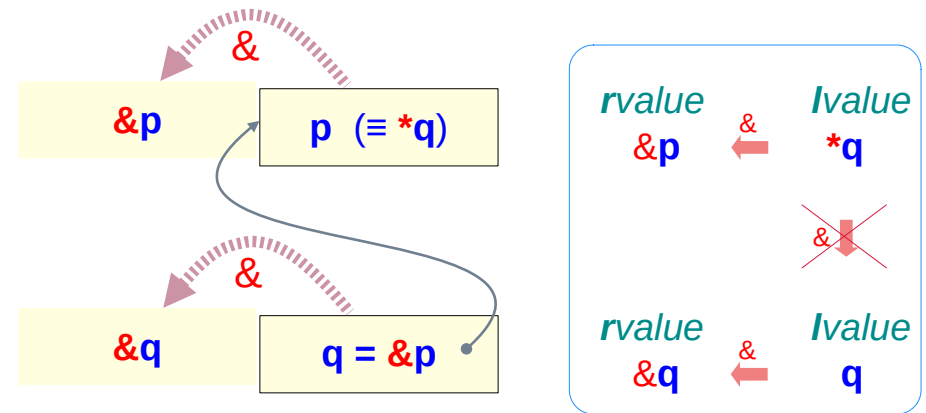
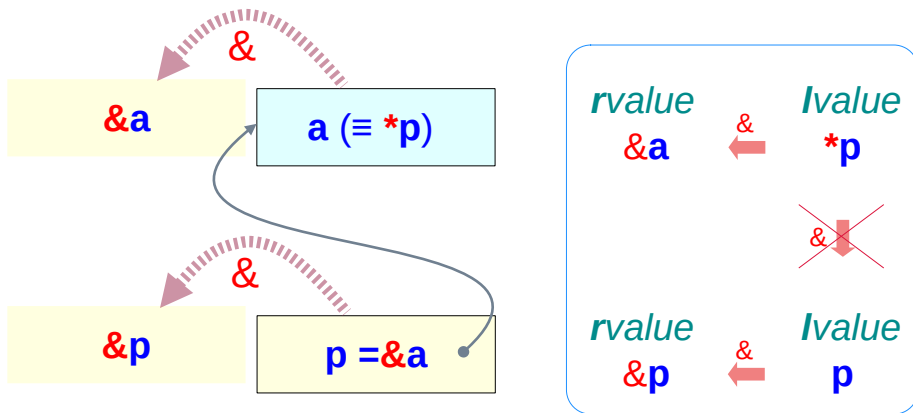
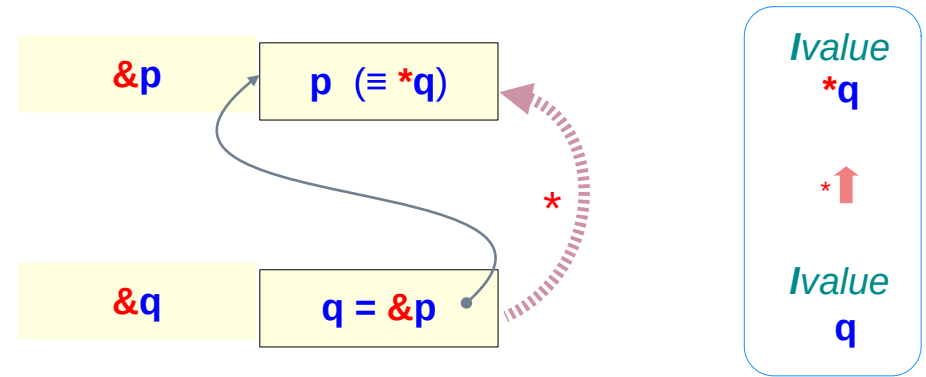
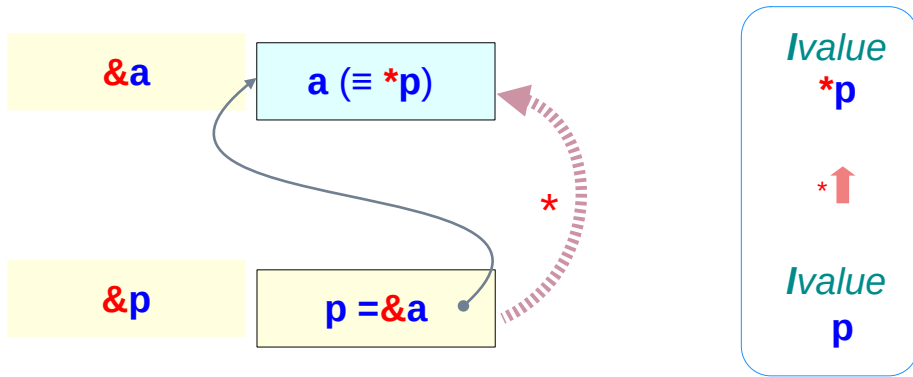

$*\&p = p$
 ~~$\&*p = p$~~ `value(p)`

$*\&q = q$
 ~~$\&*q = q$~~ `value(q)`

& and * operators in pointer de-referencing

Two step De-reference * operation

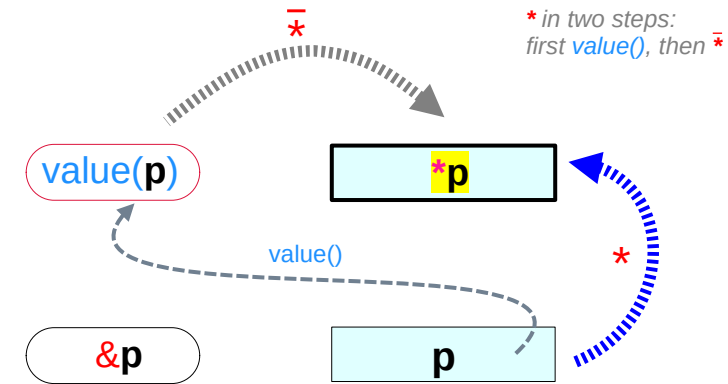
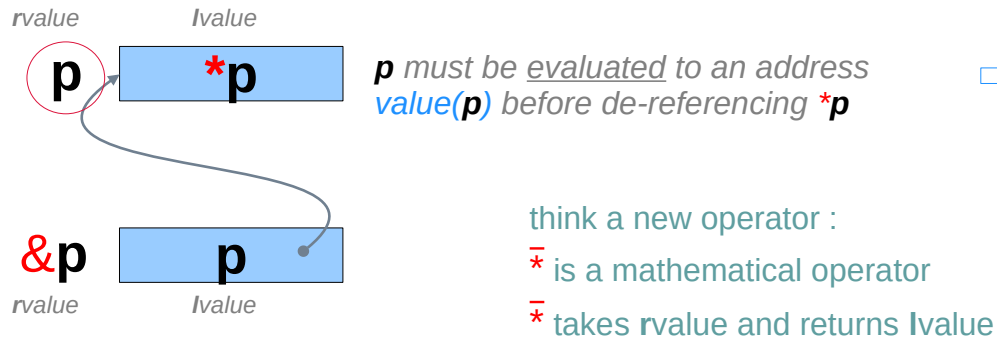

Two step Address-of & operation

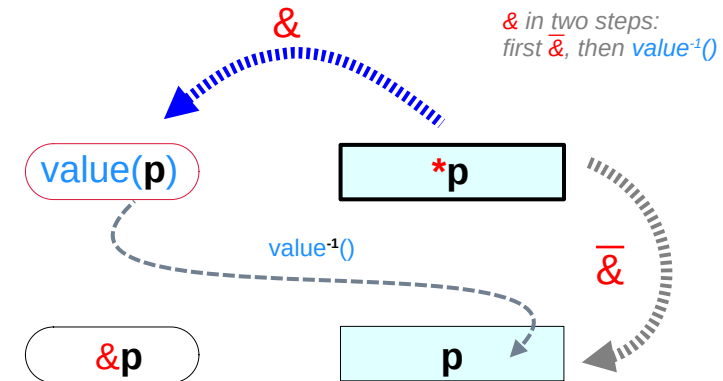
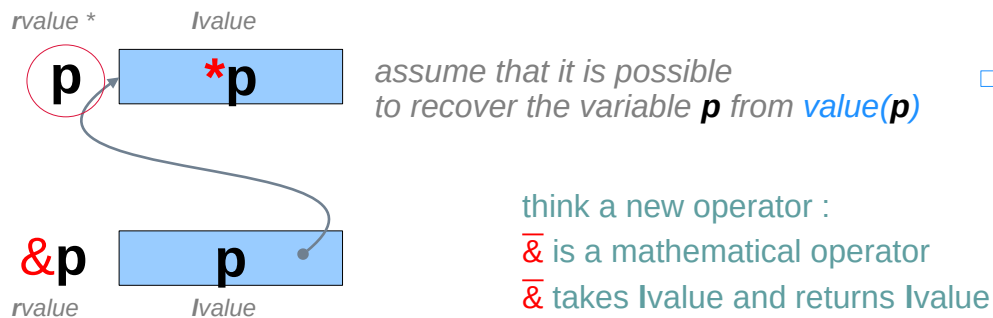

Introducing mathematical operators : $\bar{\&}$ and $\bar{*}$

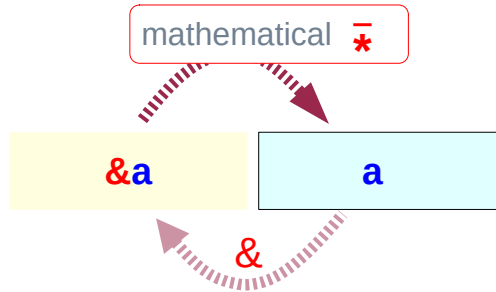

$$\bar{*} \&a = a$$

$\&a$

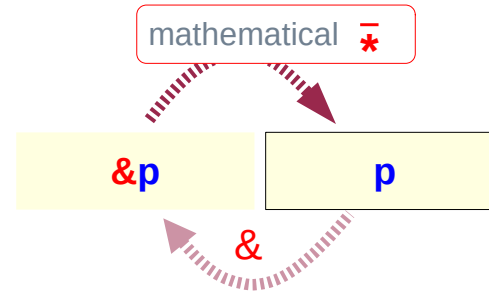

$$\bar{*} \&p = p$$

$\&p$

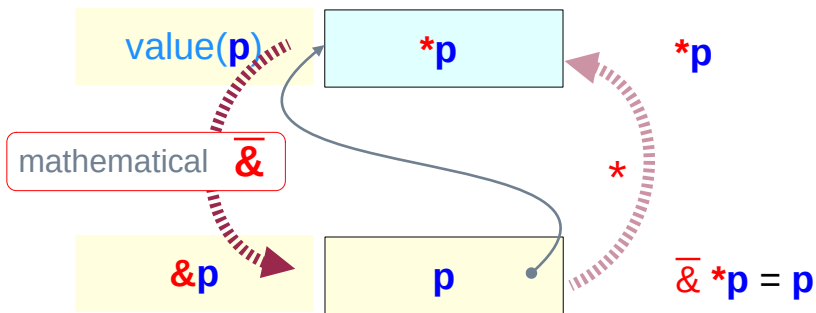

$$\bar{*} *p = p$$

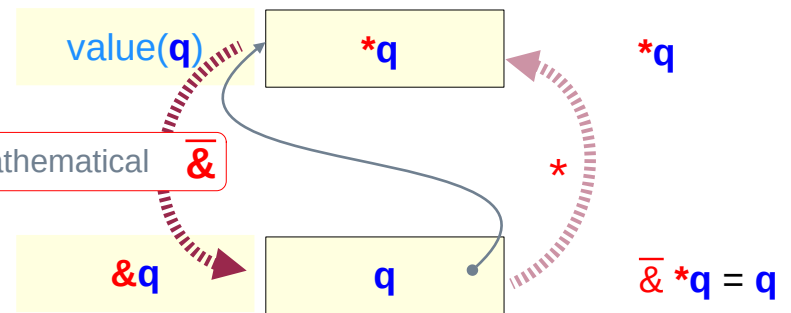

$$\bar{*} *q = q$$

Inverse operators $\bar{*}$ and $\&$

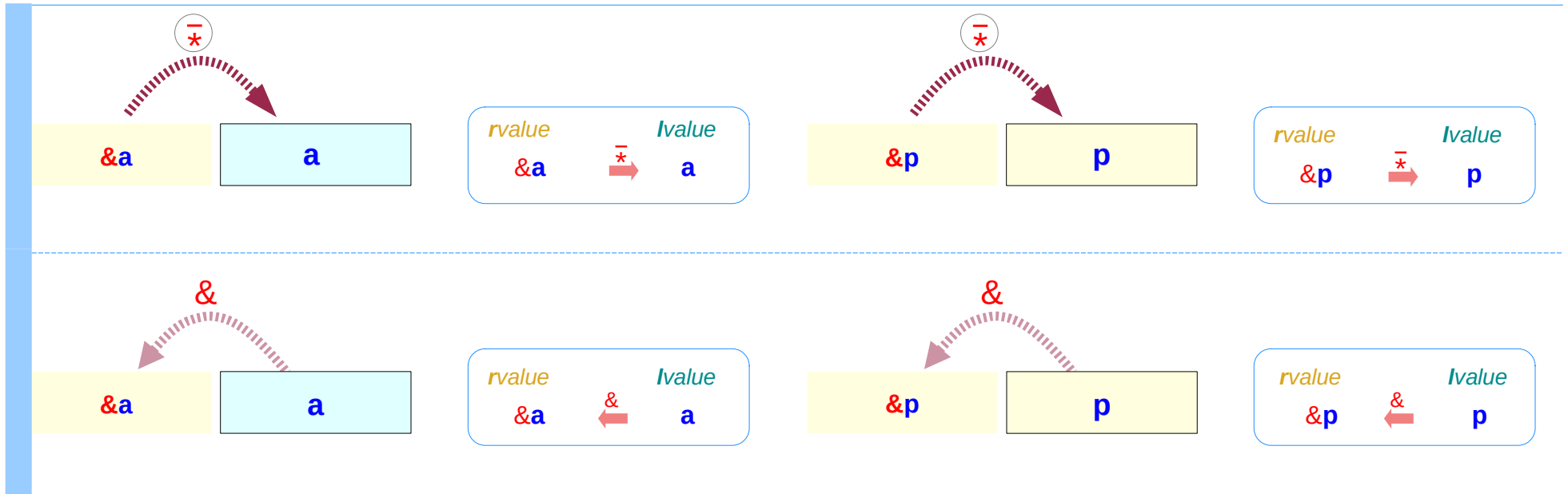

$$\bar{*}\&a = a$$

$$\&\bar{*}\&a = \&a$$

$\bar{*}$ and $\&$ are
inverse operators
to each other

$$\bar{*}\&p = p$$

$$\&\bar{*}\&p = \&p$$

$\bar{*}$ and $\&$ are
inverse operators
to each other

Inverse operators $\bar{\&}$ and $\bar{*}$

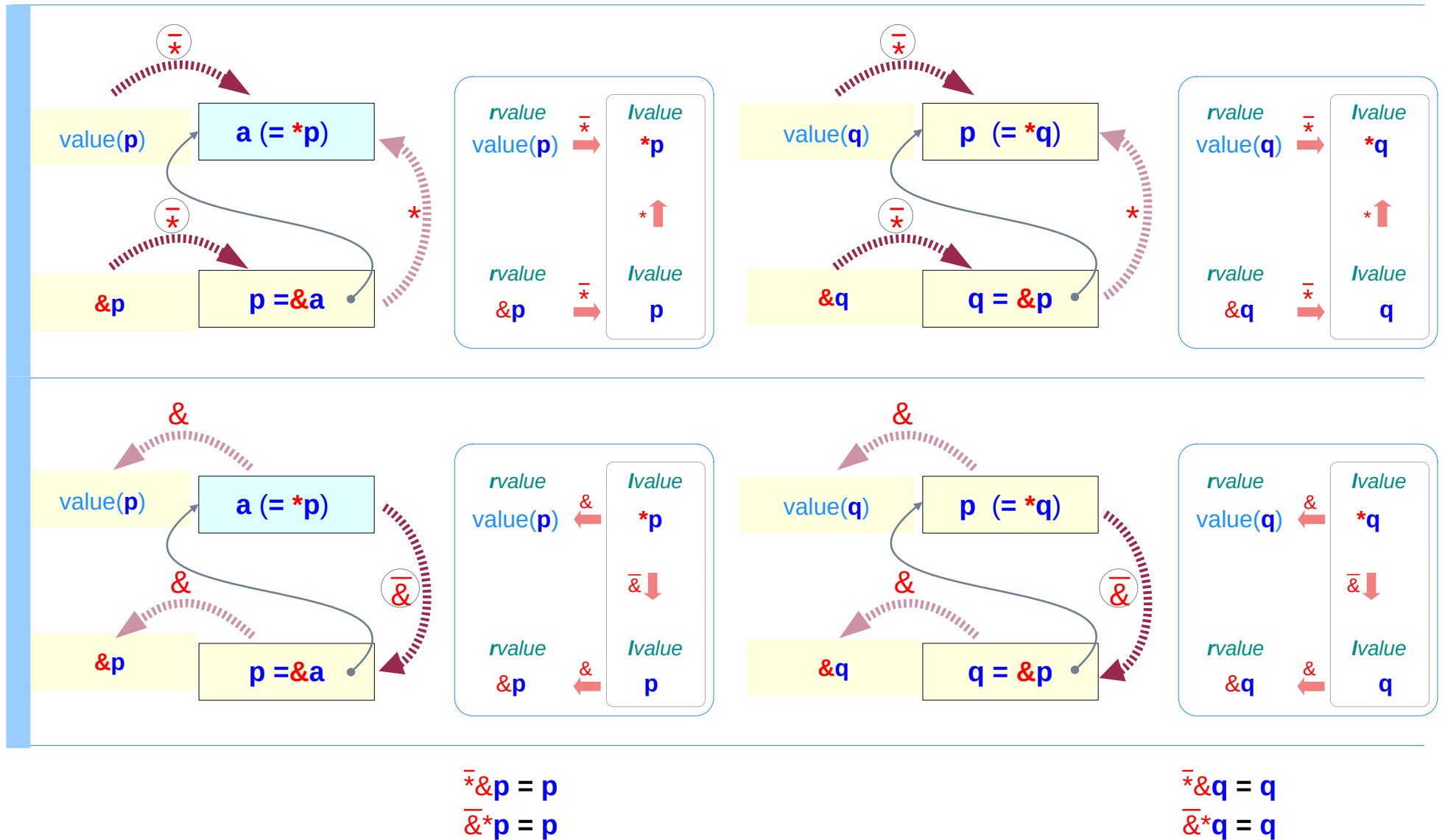

Examples of inverse operators

$\overline{*}&a \rightarrow a$

$\overline{*}&p \rightarrow p$

$\overline{*}&q \rightarrow q$

$\overline{*}value(p) \rightarrow *p \rightarrow a$

$\overline{*}value(q) \rightarrow *q \rightarrow p$

$\overline{*}value(*q) \rightarrow **q \rightarrow *p \rightarrow a$

$\overline{\&}*p \rightarrow p$

$\overline{\&}*q \rightarrow q$

$\overline{\&}**q \rightarrow *q$

Extended Operators

$*\&a \rightarrow a$

$*\&p \rightarrow p$

$*\&q \rightarrow q$

$*p \rightarrow a$

$*q \rightarrow p$

$**q \rightarrow *p \rightarrow a$

$\&*p \rightarrow \&a$

$\&*q \rightarrow \&p$

$\&**q \rightarrow \&a$

C Operators

```
int a;  
int * p = &a;  
int ** q = &p;
```

$\&a$ 

$\&p$ 

$\&q$ 

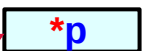
$value(p)$ 

$\&p$ 

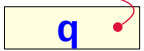
$\&q$ 

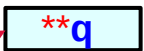
$value(*q)$ 

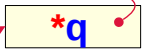
$value(q)$ 

$\&q$ 

Operands of mathematical operators : $\bar{\&}$ and $\bar{*}$

$\bar{*}$ address value

$\bar{\&} \bar{*} \text{value(P)}$ \longrightarrow value(P)

$\bar{*}$ $\bar{\&}$ variable

$\bar{*} \bar{\&} X$ \longrightarrow X

$\bar{\&}$ $* \text{ pointer}$
dereferenced pointer

$\bar{\&} * P$ \longrightarrow P

$\bar{\&}$ ~~pointer~~
must be a dereferenced pointer
not considering
simultaneous pointing

$* \bar{\&} Q$ \longrightarrow Q
Q must be a dereferenced pointer
i.e, $Q = *p \longrightarrow \bar{\&} Q = p$

& and mathematical $\bar{*}$

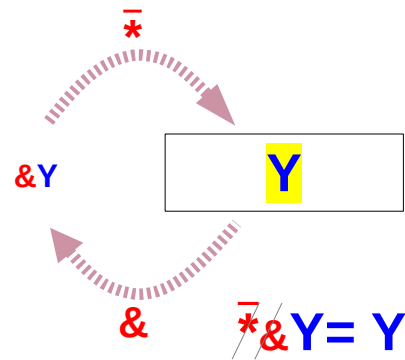
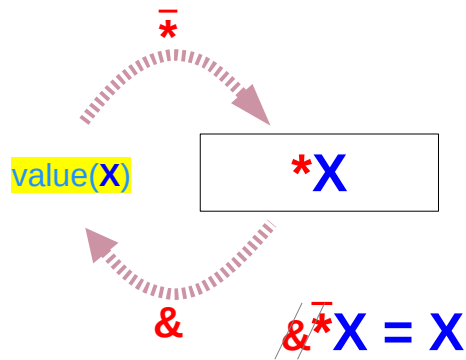

$$\begin{aligned} \& \bar{*} \text{value}(\mathbf{a}) &= \text{value}(\mathbf{a}) \\ \& \bar{*} \text{value}(\mathbf{p}) &= \text{value}(\mathbf{p}) \\ \& \bar{*} \text{value}(\mathbf{q}) &= \text{value}(\mathbf{q}) \end{aligned}$$

$$\begin{aligned} \& * \mathbf{a} &= \text{value}(\mathbf{a}) \\ \& * \mathbf{p} &= \text{value}(\mathbf{p}) \\ \& * \mathbf{q} &= \text{value}(\mathbf{q}) \end{aligned}$$

$$\begin{aligned} \bar{*} \& \mathbf{a} &= \mathbf{a} \\ \bar{*} \& \mathbf{p} &= \mathbf{p} \\ \bar{*} \& \mathbf{q} &= \mathbf{q} \end{aligned}$$

$$\begin{aligned} \bar{*} \& \mathbf{a} &= \mathbf{a} \\ \bar{*} \& \mathbf{p} &= \mathbf{p} \\ \bar{*} \& \mathbf{q} &= \mathbf{q} \end{aligned}$$

$$\begin{aligned} * \& \mathbf{a} &= \mathbf{a} \\ * \& \mathbf{p} &= \mathbf{p} \\ * \& \mathbf{q} &= \mathbf{q} \end{aligned}$$

C expressions

```
int a;
int * p = &a;
int ** q = &p;
```

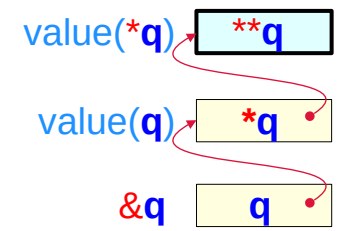
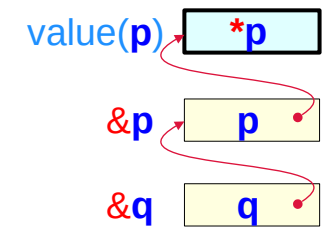
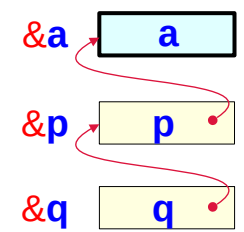

* and mathematical $\bar{\&}$

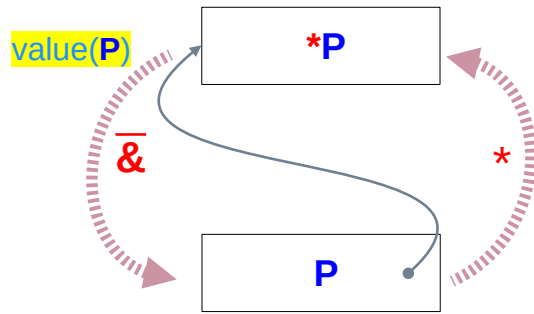

$$\bar{\&} * P = P$$

$$\bar{\&} * p = p$$

$$\bar{\&} * q = q$$

$$\bar{\&} * p = \text{value}(p)$$

$$\bar{\&} * q = \text{value}(q)$$

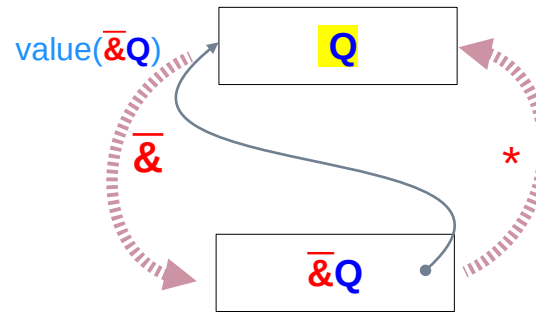

$$* \bar{\&} Q = Q$$

$$* \bar{\&} * p = * p$$

$$* \bar{\&} * q = * q$$

$$* \bar{\&} * p = * p$$

$$* \bar{\&} * q = * q$$

$$* \bar{\&} * p = * p$$

$$* \bar{\&} * q = * q$$

C operators

if not considering simultaneous pointing

```
int a;
int * p = &a;
int ** q = &p;
```

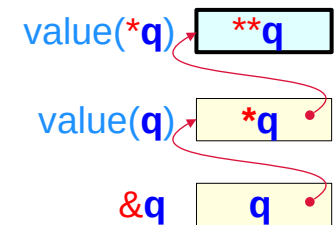
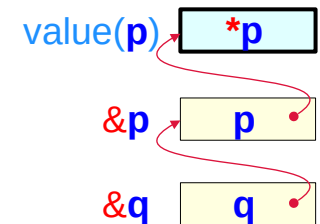
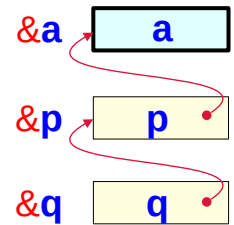

Requirements of address and data

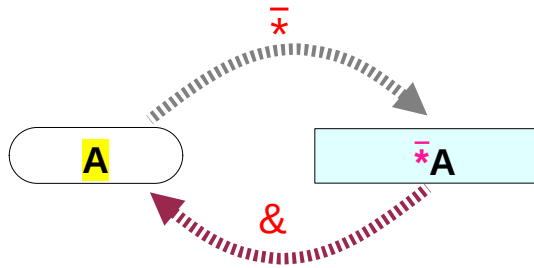

A : an address value - a number

`value(p)`, `&p`, `&x`

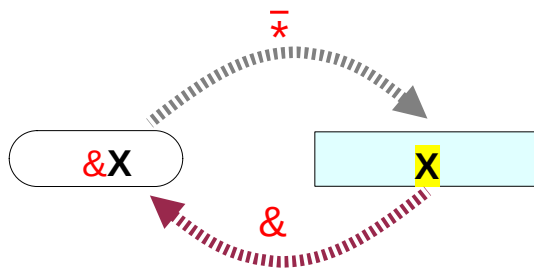

X : a variable `*p`, `p`, `a`

`*p` : a dereferenced variable

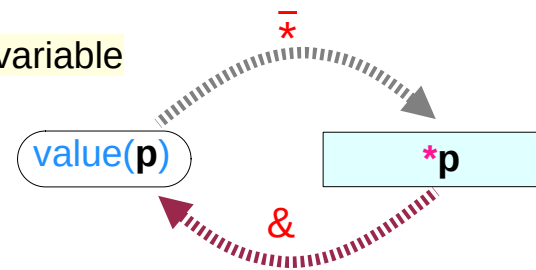

Pointer Dereferencing

`p` : a pointer variable

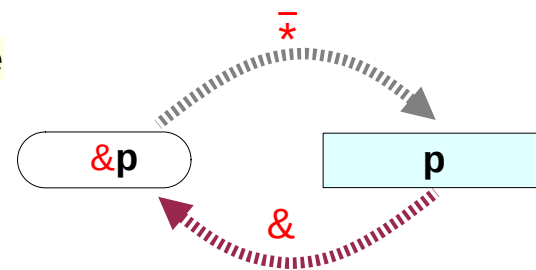

Pointer Data

`a` : a primitive variable

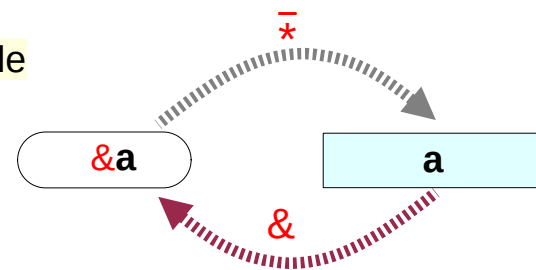

Non-pointer Data

Inverse relations of $\&$ and $\bar{*}$ operators

$*p$: a dereferenced variable

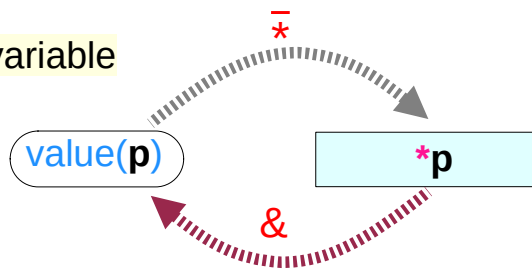

$$\bar{*} \text{value}(p) = *p$$

$$\bar{\&} \text{value}(p) = \& *p = \text{value}(p)$$

$$*\bar{\&} \text{value}(p) = *\bar{\&} *p = \bar{*} \text{value}(p) = *p$$

p : a pointer variable

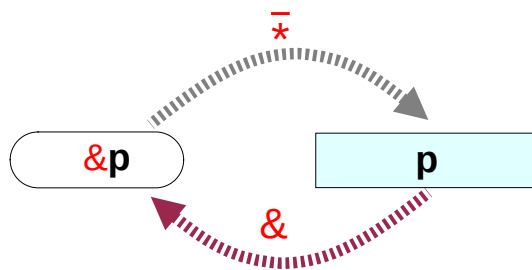

$$*\bar{\&} p = p$$

$$\bar{\&} \bar{*} p = \bar{\&} p$$

a : a primitive variable

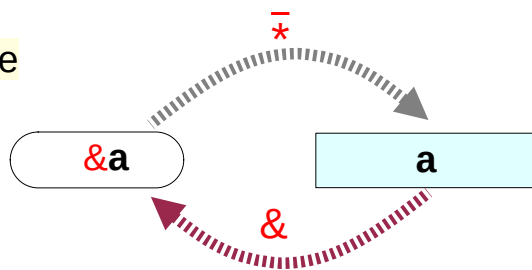

$$*\bar{\&} a = a$$

$$\bar{\&} \bar{*} a = \bar{\&} a$$

Requirements of pointed address and data

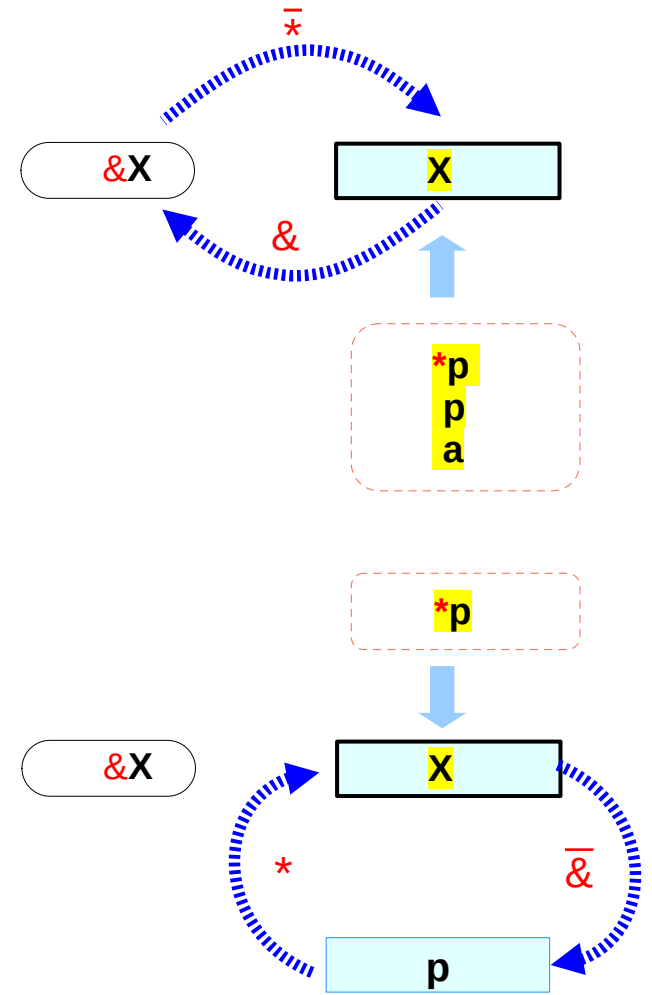
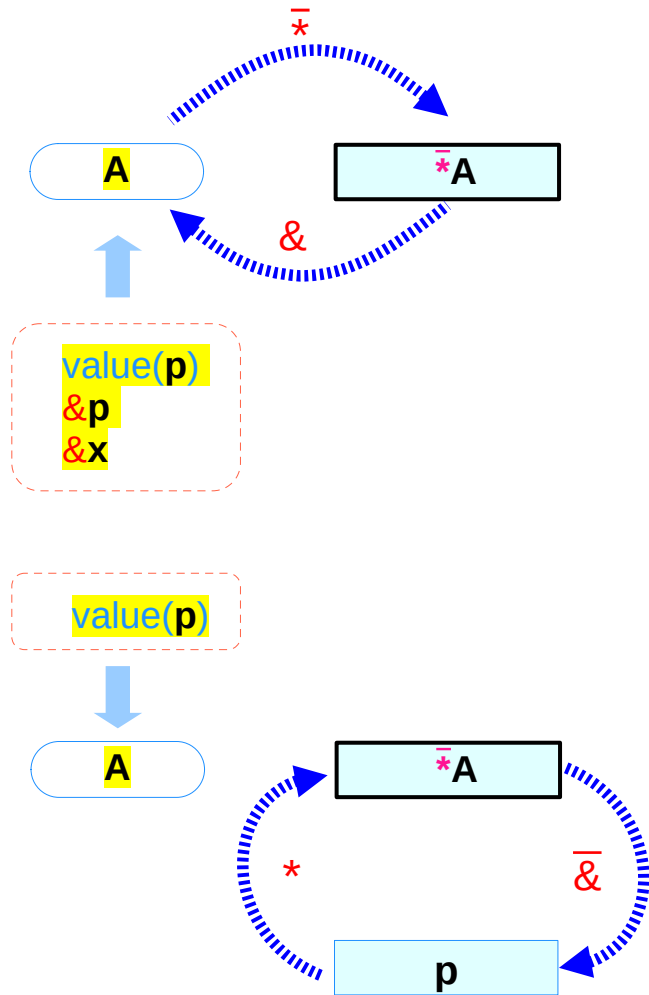

& and * operators in pointer de-referencing (1)

Two step De-reference * operation

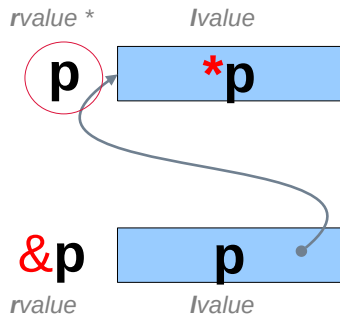

$$\begin{aligned} *p &= \bar{*} \text{value}(p) \\ \bar{*}A &= * \text{value}^{-1}(A) \end{aligned}$$

C Expressions Mixed Expressions

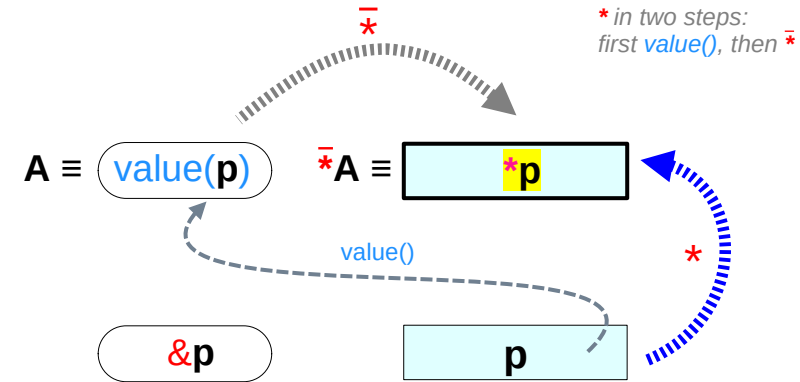

Two step Address-of & operation

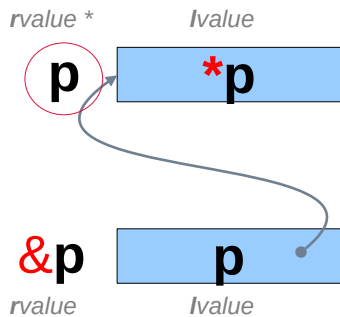

$$\begin{aligned} \&X &= \text{value}(\bar{\&}X) \\ \bar{\&}X &= \text{value}^{-1}(\&X) \end{aligned}$$

C Expressions Mixed Expressions

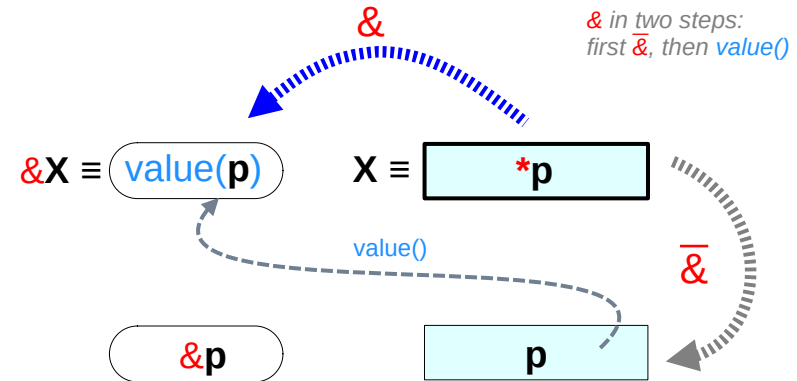

& and * operators in pointer de-referencing (2)

Two step De-reference * operation

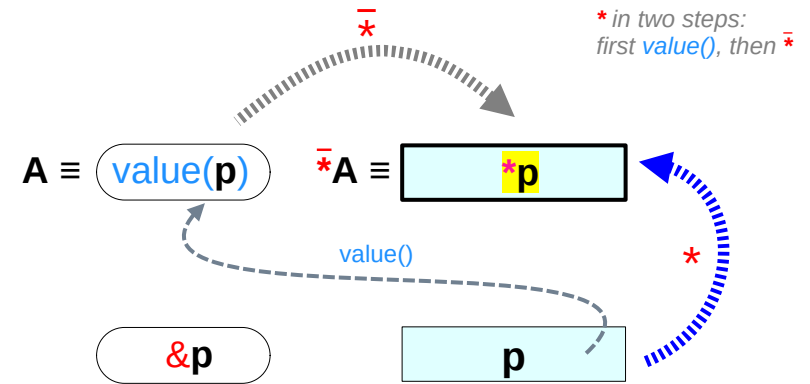
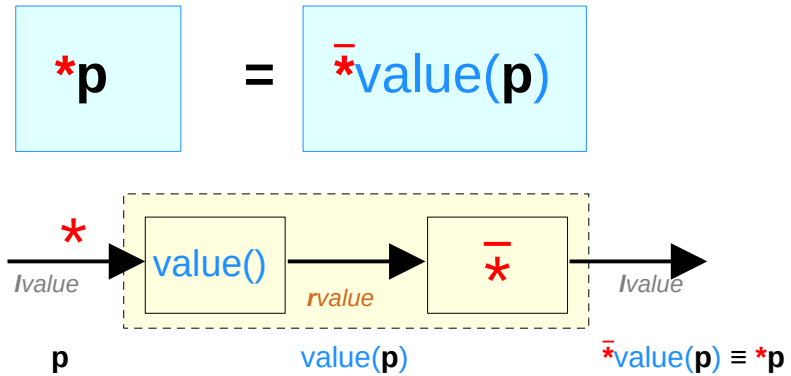

Two step Address-of & operation

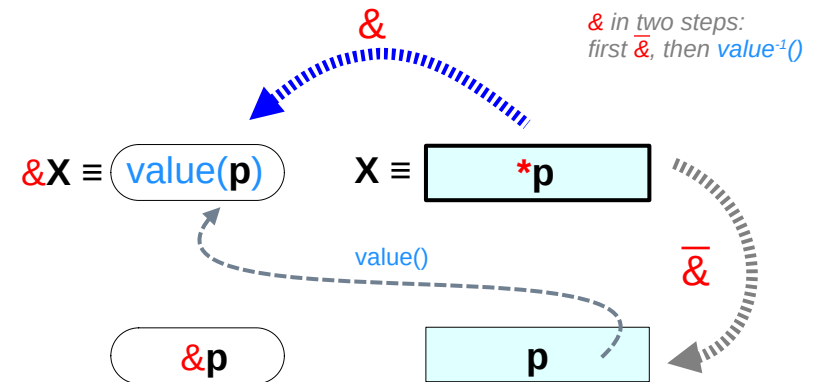
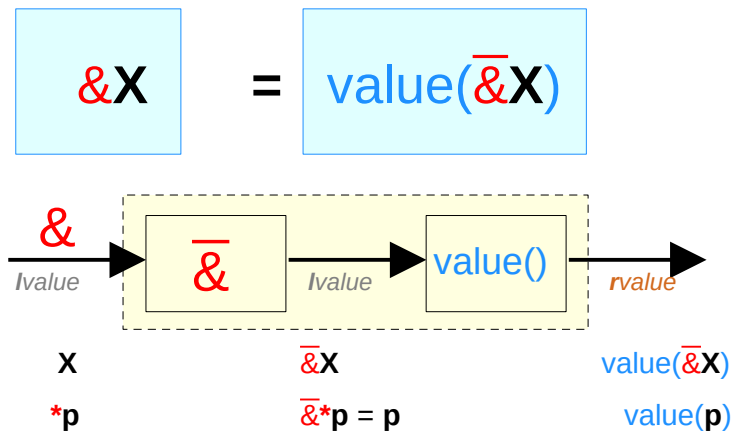

$\bar{\&}$ and $\bar{*}$ operators in pointer de-referencing (3)

Two step De-reference $\bar{*}$ operation

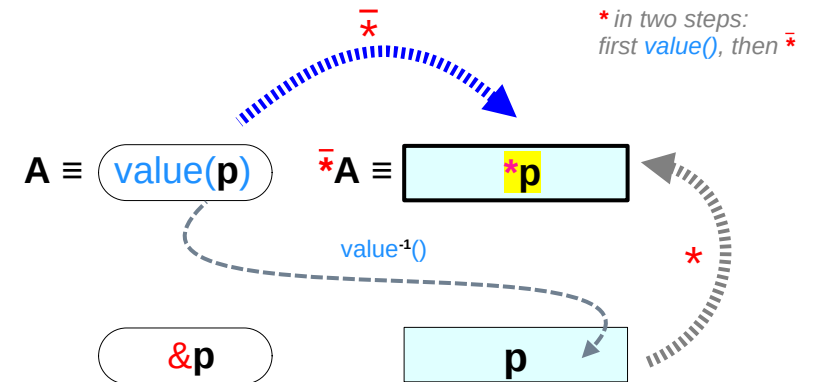
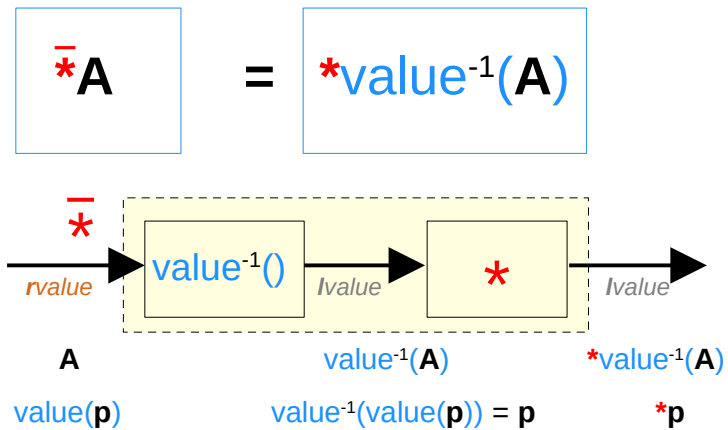

Two step Address-of $\bar{\&}$ operation

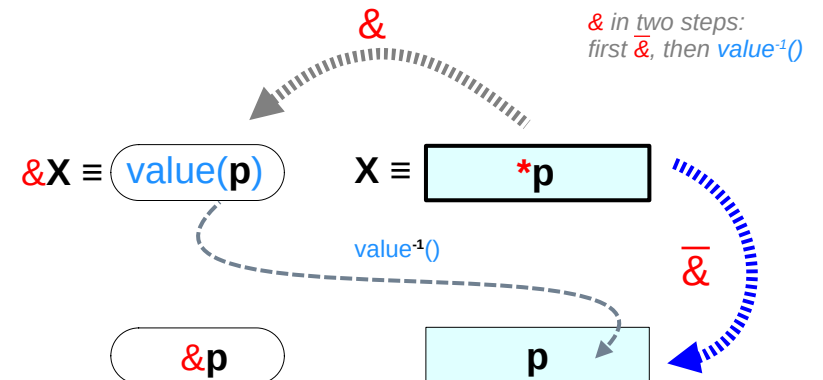
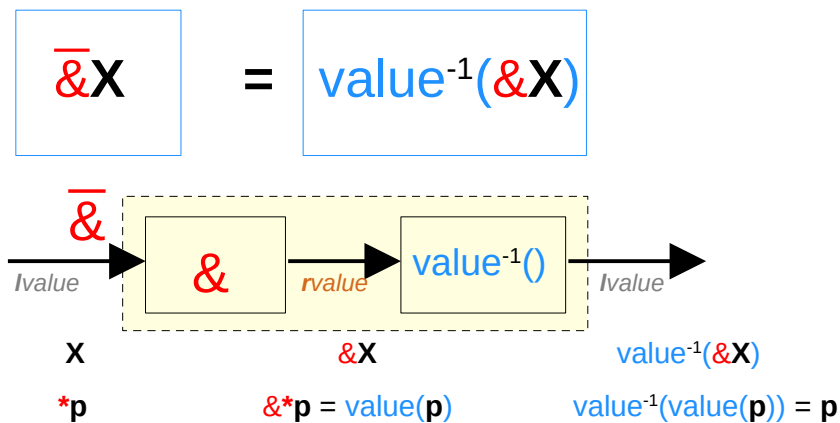

Two step address-of & and $\bar{\&}$ operators

for $\&X$, X can be $*p$, p , a

$$\&X = \text{value}(\bar{\&X})$$

C Expressions

for $\bar{\&X} = p$, X must be $*p$

$$\bar{\&X} = \text{value}^{-1}(\&X)$$

$*p$ a dereferenced variable
 p a pointer variable
 a a primitive variable

$\&X$

$$\&*p = \&* \text{value}(p) = \text{value}(p)$$

$\&p$

$\&a$

$*p$ a dereferenced variable
 ~~p a pointer variable~~
 ~~a a primitive variable~~

$$\bar{\&X} = p$$

$$\bar{\&*p} \equiv p$$

~~$\bar{\&p}$~~
 ~~$\bar{\&a}$~~

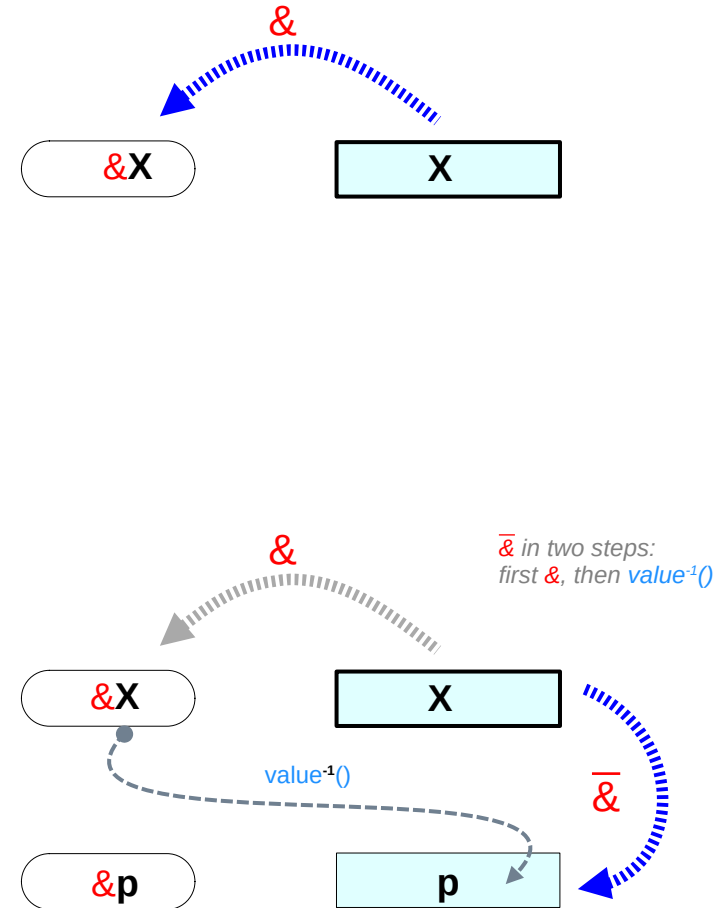

Two step de-reference $\bar{*}$ and $*$ operators

for $\bar{*}A$, A can be $\text{value}(p)$, $\&p$, $\&a$

$$\bar{*}A = *value^{-1}(A)$$

$\text{value}(p)$ value of a pointer variable
 $\&p$ address of a pointer variable
 $\&a$ address of a primitive variable

$\bar{*}A$

$\bar{*} \text{value}(p) = *p$

$\bar{*} \&p = p$

$\bar{*} \&a = a$

for $*A = *p$, A must be $\text{value}(p)$

$$*p = \bar{*} \text{value}(p)$$

C Expressions

$\text{value}(p)$ value of a pointer variable
 ~~$\&p$ address of a pointer variable~~
 ~~$\&a$ address of a primitive variable~~

$*p$

$*p \equiv \bar{*} \text{value}(p)$

~~$* \&p = p$~~

~~$* \&a = a$~~

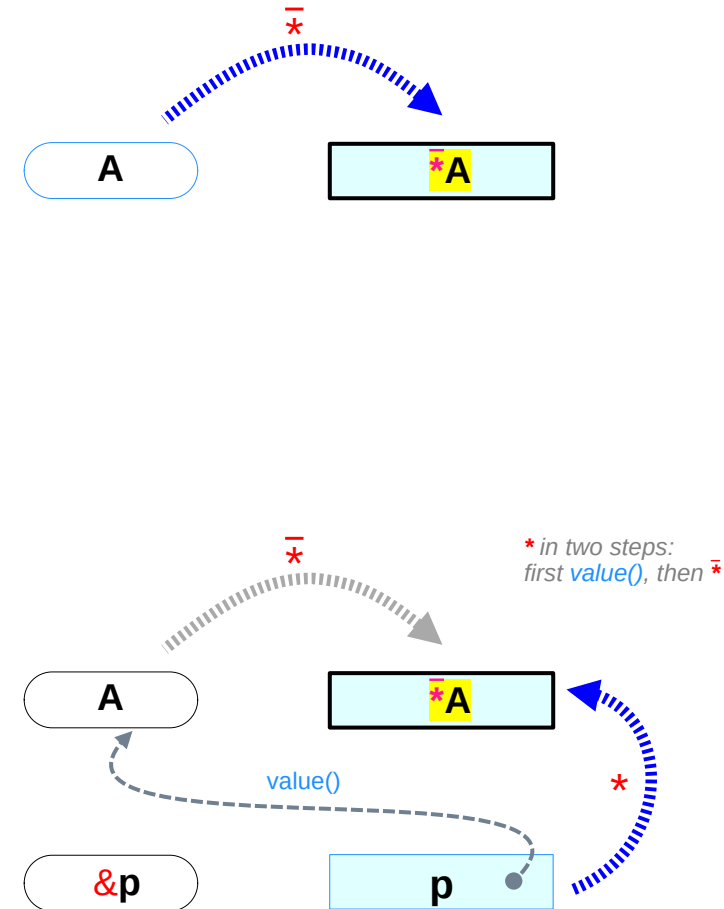

Inverse operators : $\&$ and $\bar{*}$ in pointer de-referencing

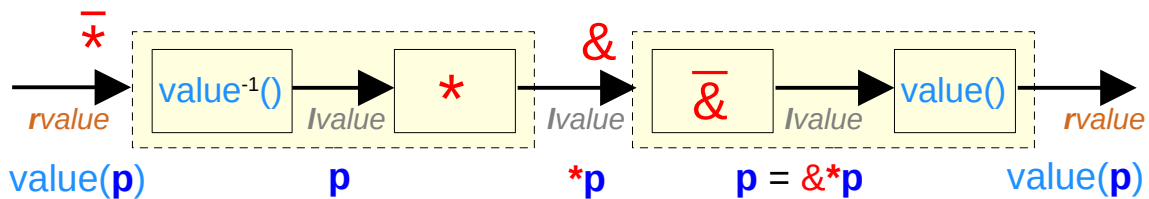
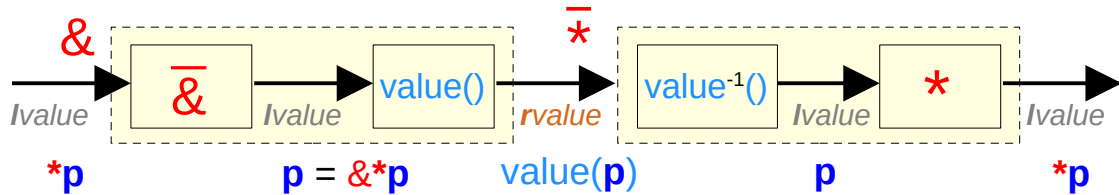
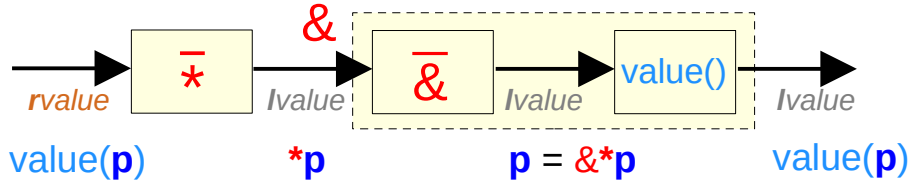
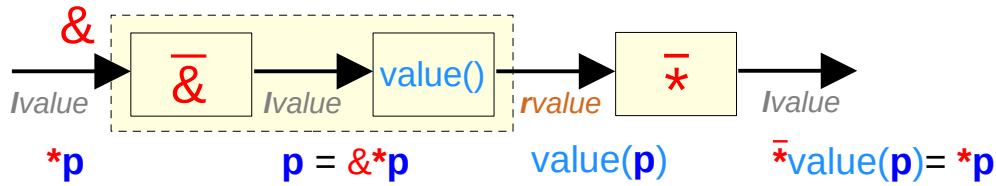

$\bar{*} value(p) = *p$
 $\&\bar{*} value(p) = \&*p = value(p)$
 $\bar{*}\&\bar{*}value(p) = \bar{*}\&*p = \bar{*}value(p) = *p$

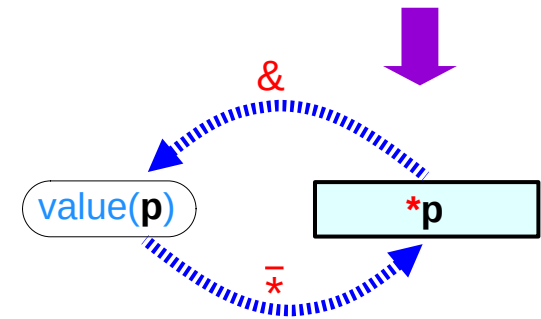
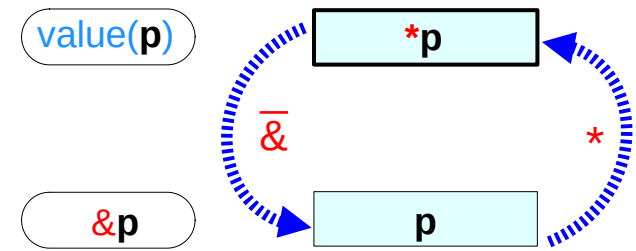

Inverse operators of & and *

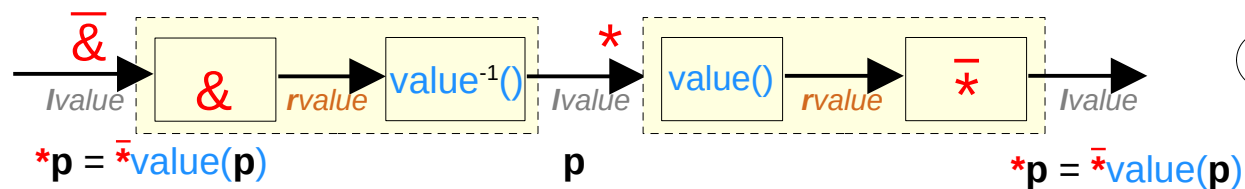
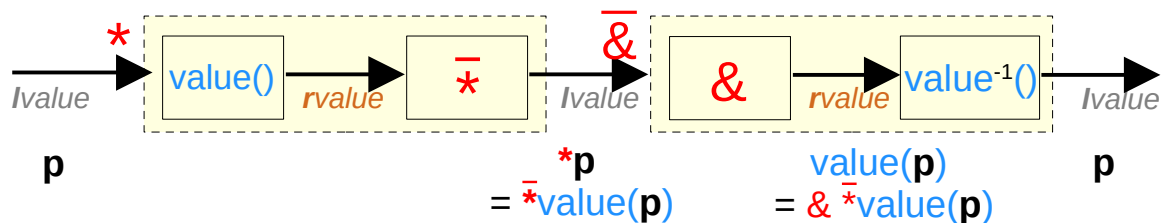
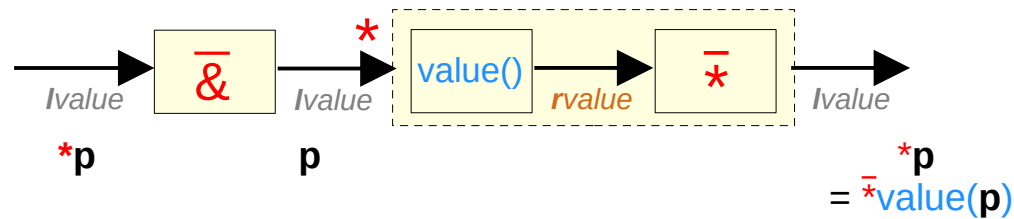
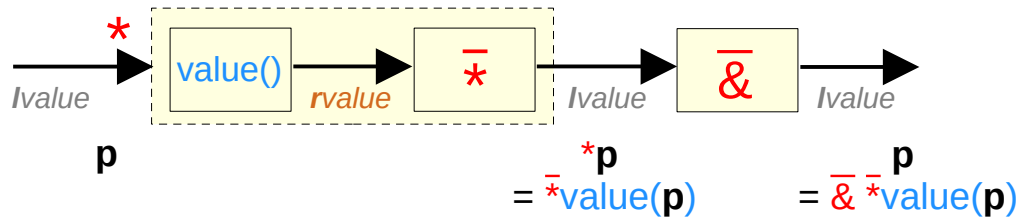

$\bar{*}value(p) = *p$
 $\bar{\&} * p = p$ $p = \bar{\&} \bar{*}value(p)$
 $* \bar{\&} * p = *p$ $value(p) = \bar{\&} \bar{*}value(p)$

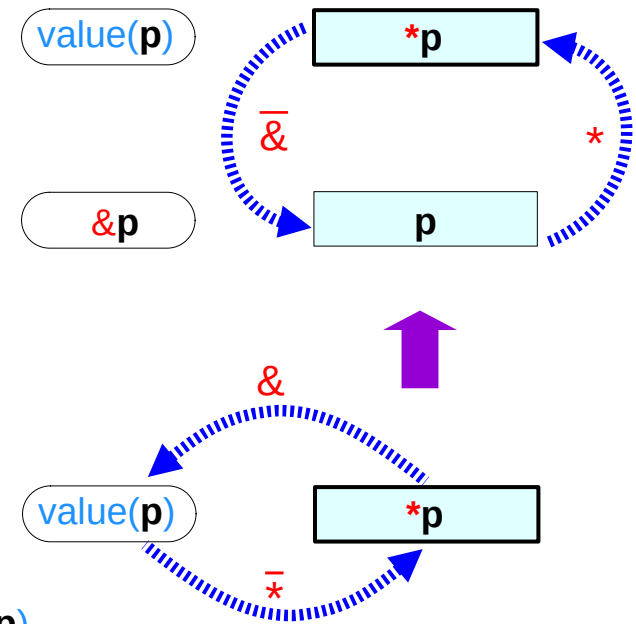

Inverse operators in pointer referencing (1)

$\bar{*}\&$

$\&\bar{*}$

$\bar{\&*}$

$*\bar{\&}$

$*\&$

$\&*$

$\&*$

$*\&$

`value(value(rvalue)) = rvalue`

$*\&$

With the new notation using $\bar{\&}$ and $\bar{*}$,
this is not a legitimate case

it should be $\bar{*}\&$, since $\&$ returns `rvalue`

but assuming successive applications
of `value()`, it gives correct answer

Inverse operators in pointer referencing (2)

$$\overline{*}&p = p$$

$$\overline{&}*value(p) = value(p)$$

$$\overline{&}*p = p$$

$$* \overline{&}*p = *p$$

value(value(rvalue)) = rvalue

$$*\overline{&}*p = *p$$

$$\overline{&}*p = value(p)$$

With the new notation using $\overline{&}$ and $\overline{*}$,
this is not a legitimate case,
But assuming successive applications
of `value()`, it gives correct answer

value(value(rvalue)) = rvvalue

$$\overline{&}*p = value(p)$$

$$*\overline{&}*p = *p$$

With the new notation using $\overline{&}$ and $\overline{*}$,
this is not a legitimate case,
But assuming successive applications
of `value()`, it gives correct answer

Inverse operators in pointer referencing (3)

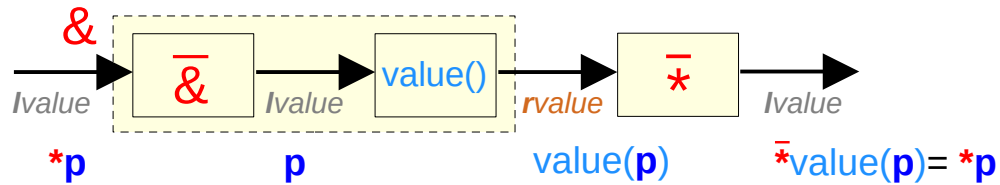

$$\bar{*}\bar{\&p} = p$$

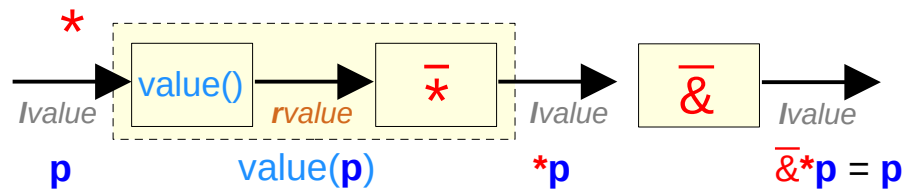

$$\bar{\&}*p = p$$

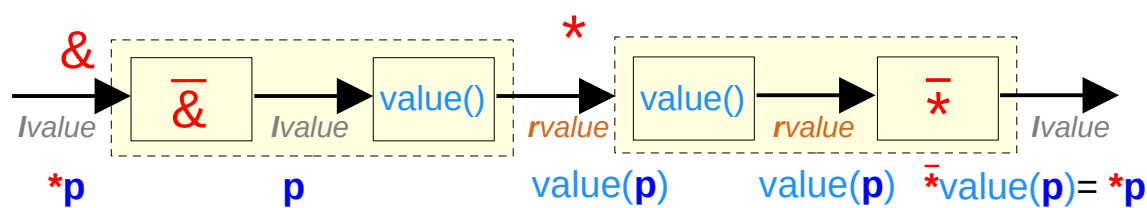

$\text{value}(\text{value}(\text{rvalue})) = \text{rvalue}$

$$*\bar{\&}*p = *p$$

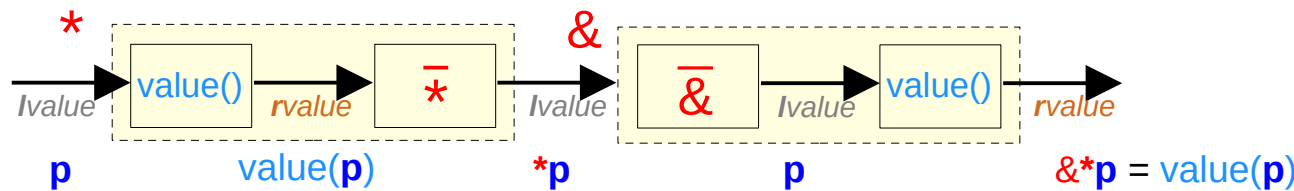

$$\bar{\&}*p = \text{value}(p)$$

Inverse operators in pointer referencing (4)

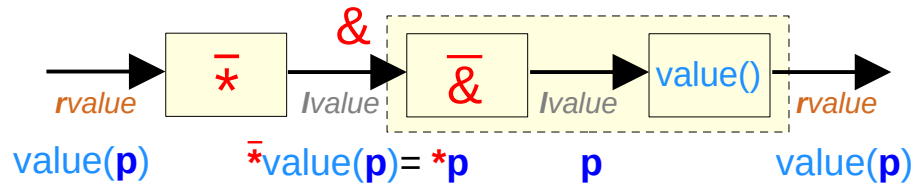

$$\boxed{\&\bar{*}}value(p) = value(p)$$

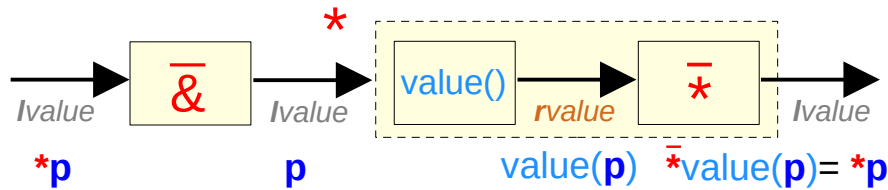

$$\boxed{*}\&value(p) = *p$$

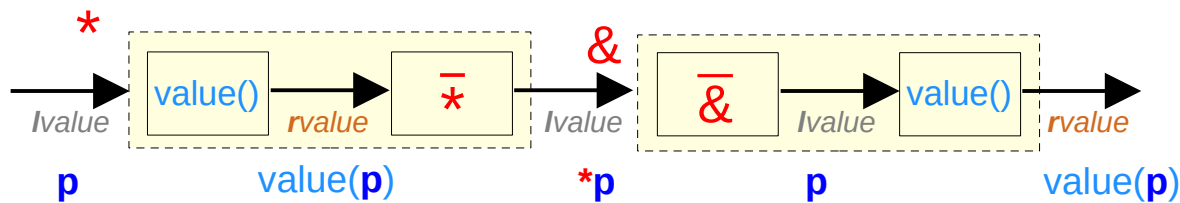

$$\boxed{\&\bar{*}}p = value(p)$$

$$value(value(rvalue)) = rvalue$$

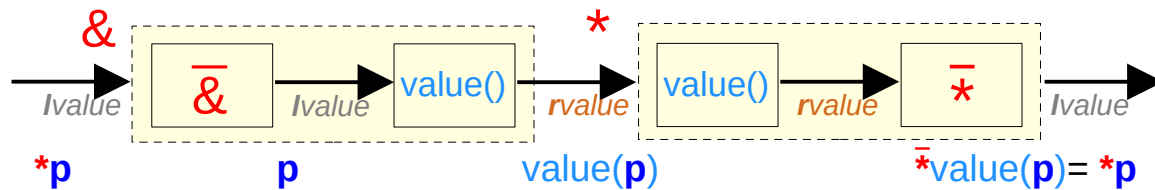

$$\boxed{*}\&p = *p$$

Inverse operators of & and *

$$\overline{*\cancel{&}}x = x$$

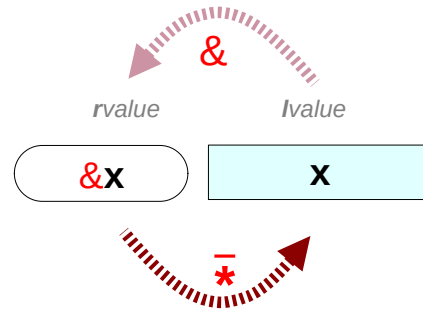

$$*p \equiv \overline{*\text{value}(p)}$$

$$\overline{*\cancel{&}}p = \text{value}(p)$$

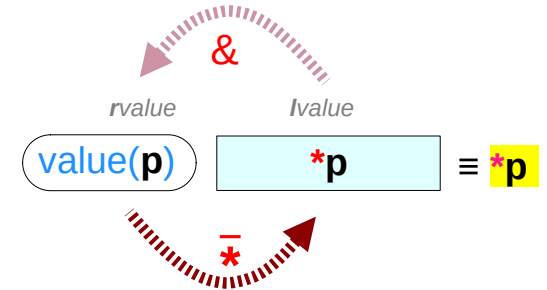

$$\overline{*\cancel{&}}p = p$$

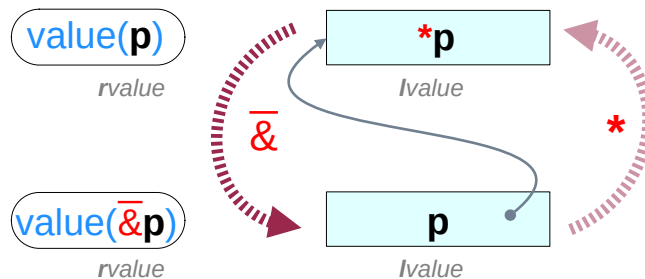

Inverse operators of & and *

$$\&x \equiv \text{value}(\bar{\&x})$$

$$\bar{\&x} = x$$

$$\bar{*}\text{value}(\bar{\&x}) = x$$

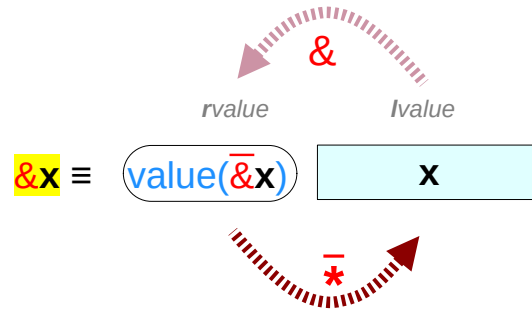

$$*p \equiv \bar{*}\text{value}(p)$$

$$\&*p = \text{value}(p)$$

$$\&*p = \text{value}(\bar{*}p)$$

$$\&*p = \text{value}(p)$$

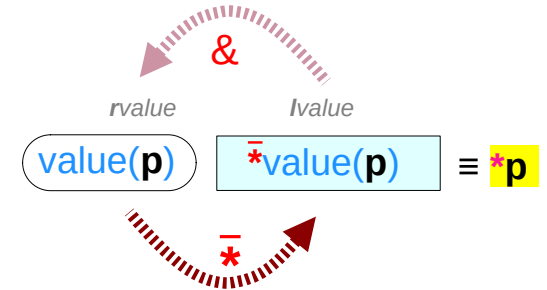

$$*p \equiv \bar{*}\text{value}(p)$$

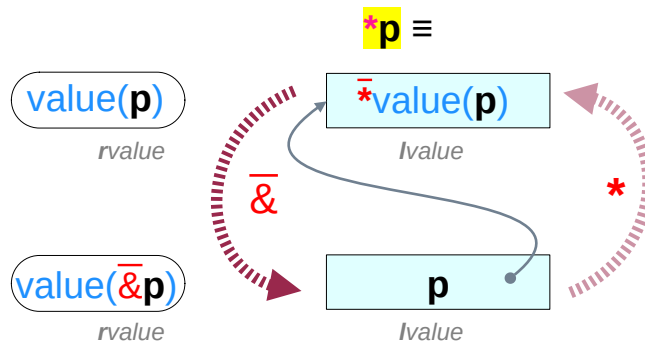

Inverse operators of & and *

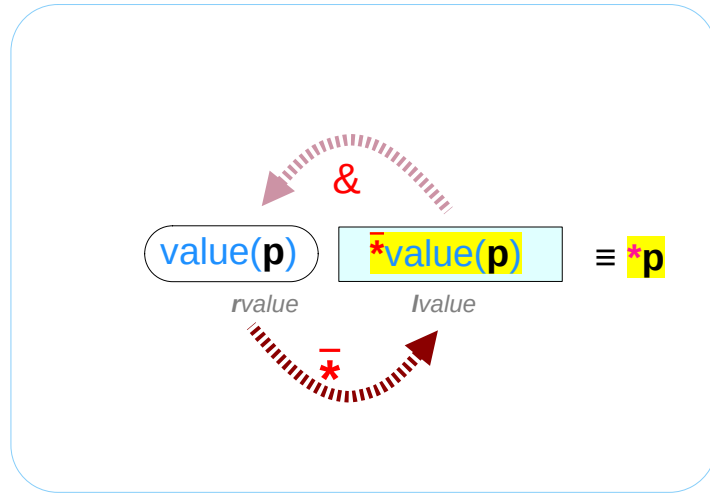

$$\bar{*} \text{value}(\bar{\&}x) = x$$

$$\bar{\&} \bar{*} \text{value}(p) = p$$

$$\bar{\&} * p = \text{value}(p)$$

$$\text{value}(\bar{\&} \bar{*} \text{value}(p)) \begin{cases} \text{value}(\bar{\&} * p) & \Rightarrow \text{value}(p) \\ \text{value}(\bar{\&} \bar{*} \text{value}(p)) & \Rightarrow \text{value}(p) \end{cases}$$

C operators and mathematical operators

Address-of operation

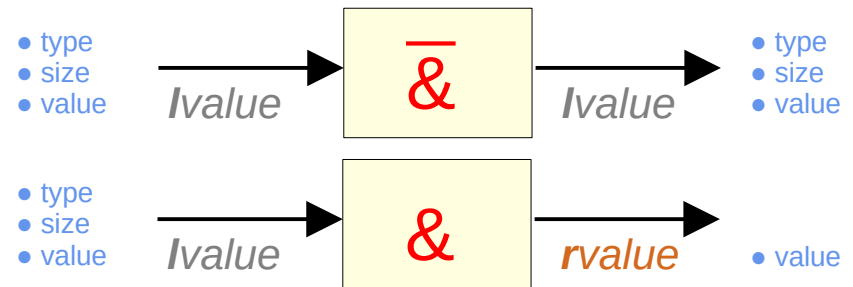

De-reference operation

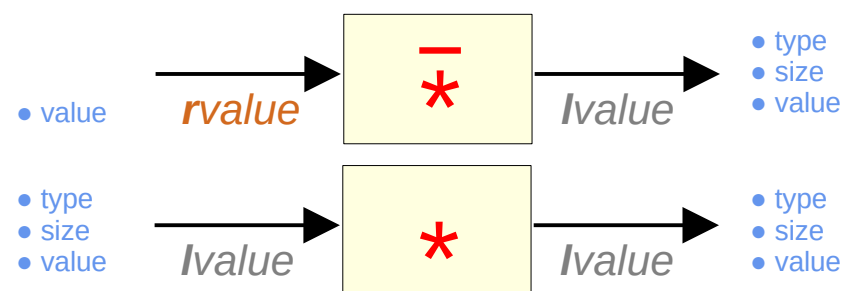
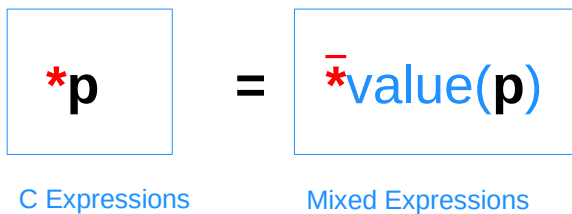

Ivalue and rvalue with * and & operators

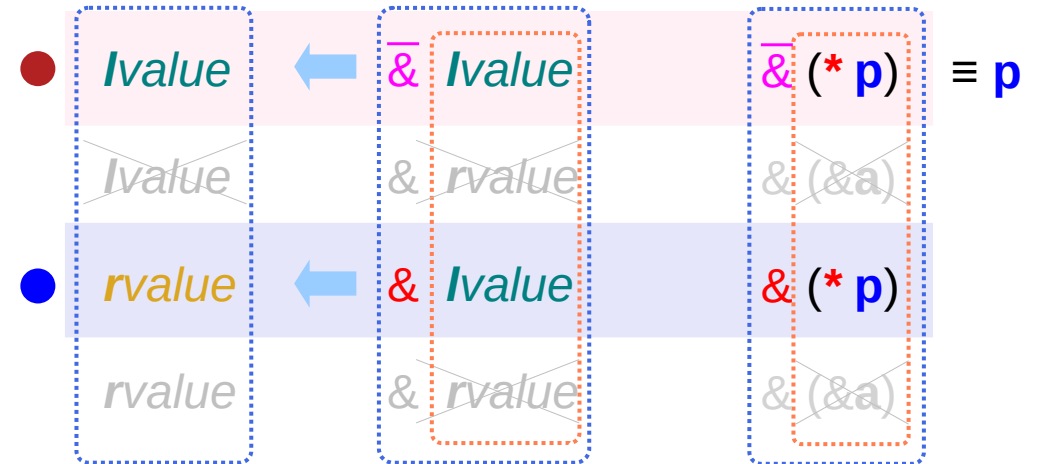
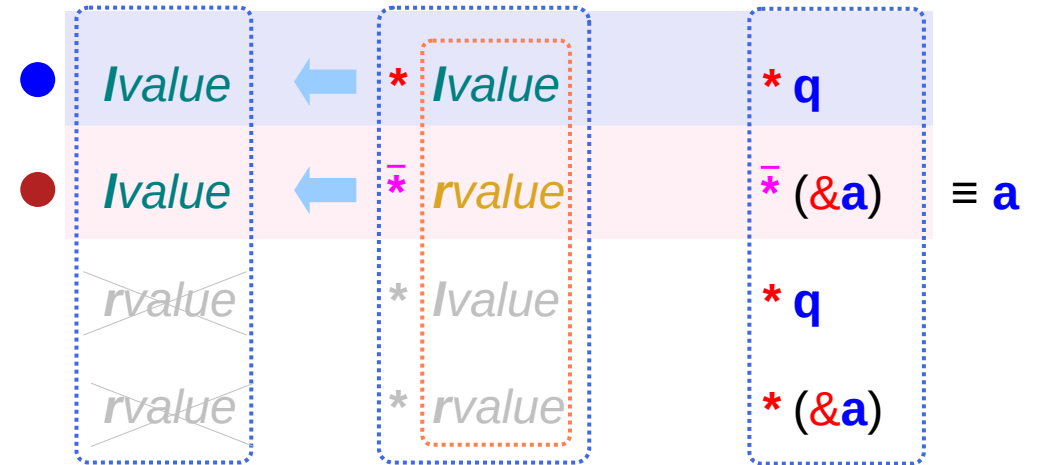
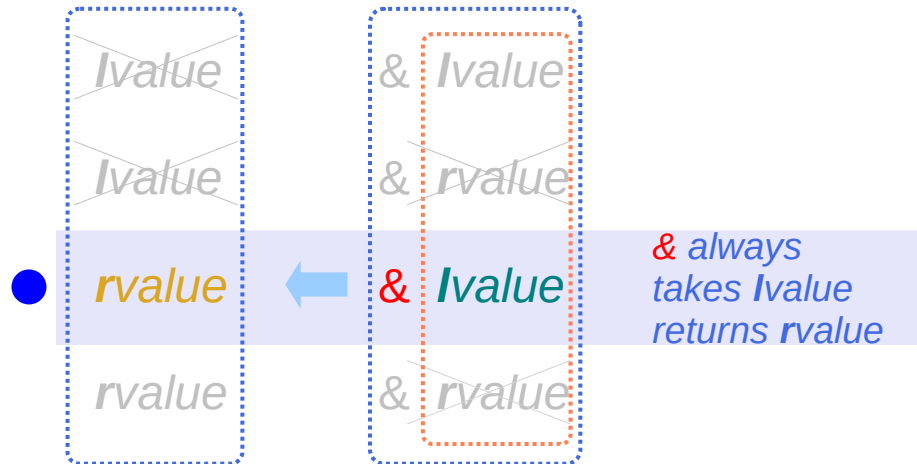
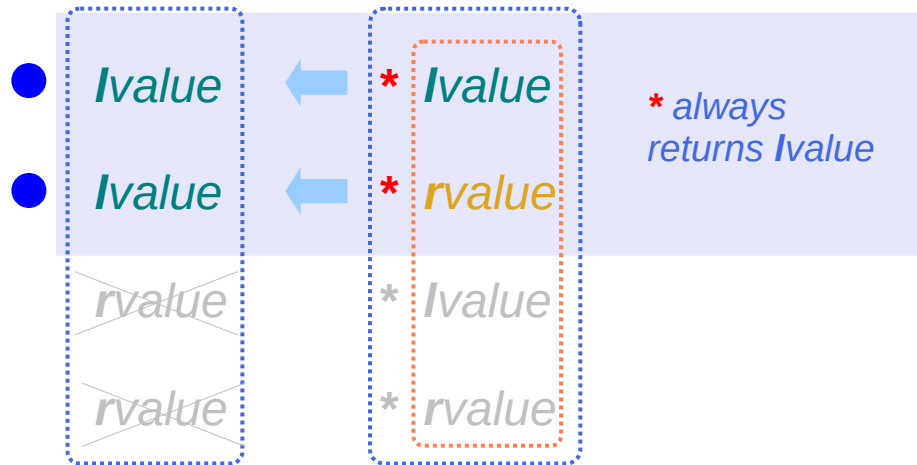

a, p, q : Ivalues ... variables ... RW
***p, *q, **q** : Ivalues ... variables ... RW
&a, &p, &q : rvalues ... constants ... RO

Recursive application of the address-of operator

~~&(&(&(c[i])[j])[k])~~

& C operator

can be applied to only **lvalue** variable

returns **address value**

thus, the above expression is **not** possible

successive application of & is **not** possible

In contrast, ***p** becomes a lvalue variable

***** operator can be applied successively.

$\bar{\&}(\bar{\&}(\bar{\&}(\mathbf{c}[\mathbf{i}])[\mathbf{j}])[\mathbf{k}])$

$\bar{\&}$ mathematical operator

Two step deferencing in type II (1) – without skipping

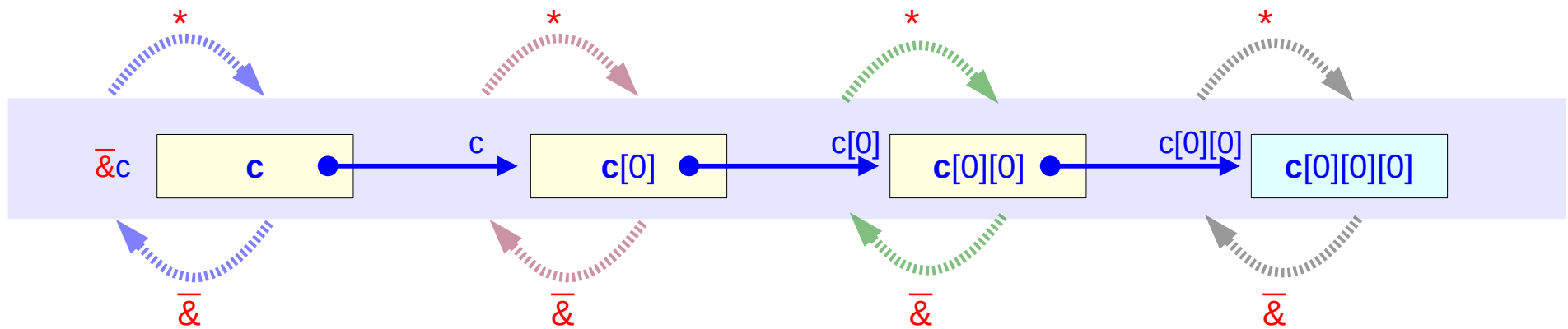

$\bar{\&}$: mathematical & operator

n-d access of a 1-d array

- **2-d** array access of a **1-d** array
- **3-d** array access of a **1-d** array
- Accessing a **contiguous 1-d** array
- Accessing a **non-contiguous 1-d** arrays

- Accessing **static** allocated arrays
- Accessing **dynamically** allocated arrays

2-d array access of a 1-d array

Array of Pointers

```
int    a [4] ;  
int *  b [3] ;
```

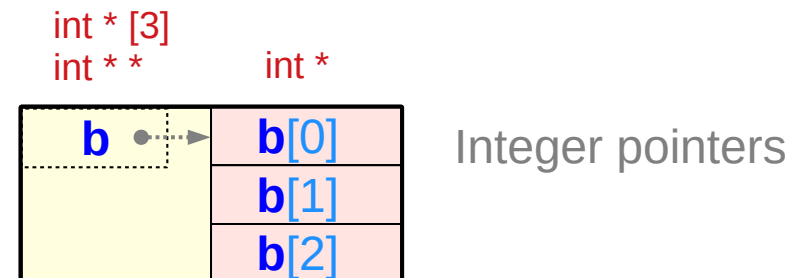
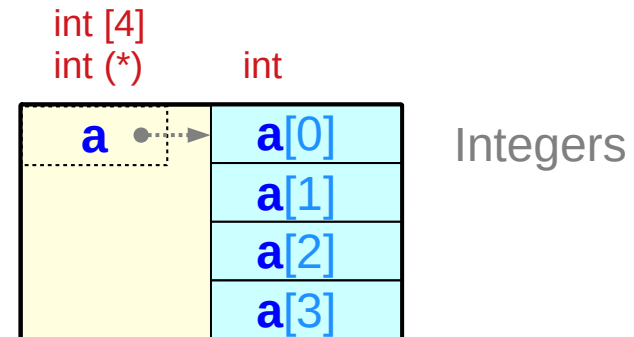
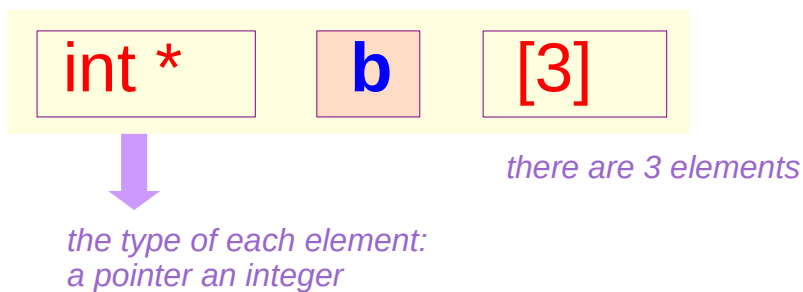
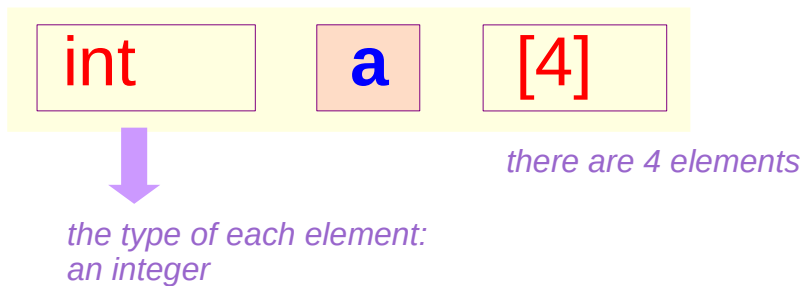

Array of Pointers – a type view

`int *` `b [3] ;` Pointer Array

`int` `a [4] ;`

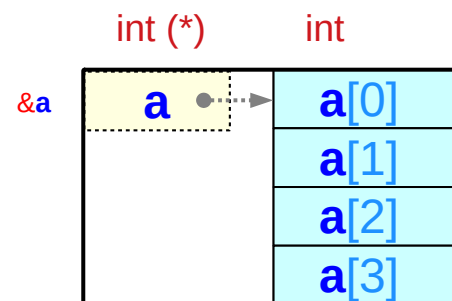
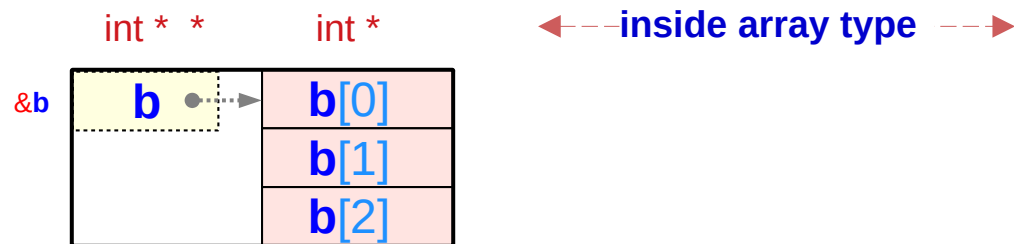
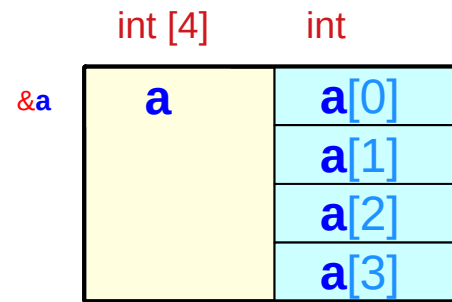
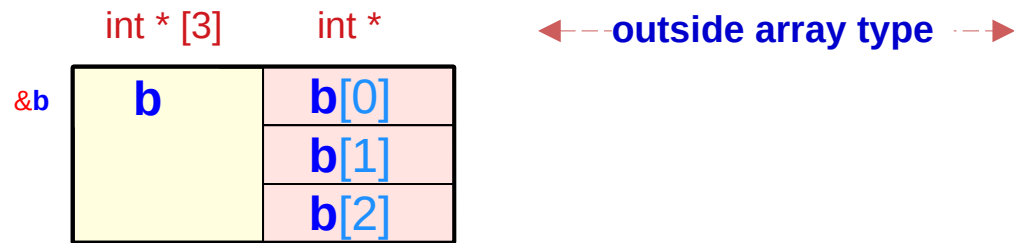

Array of Pointers – a variable view

```
int * b [3] ;
```

Pointer Array

```
int a [4] ;
```

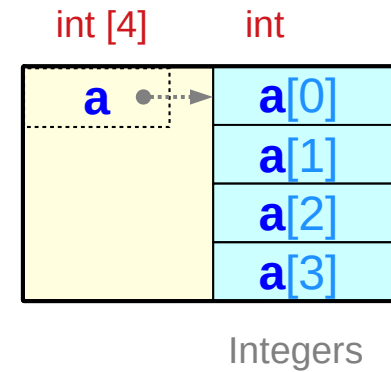
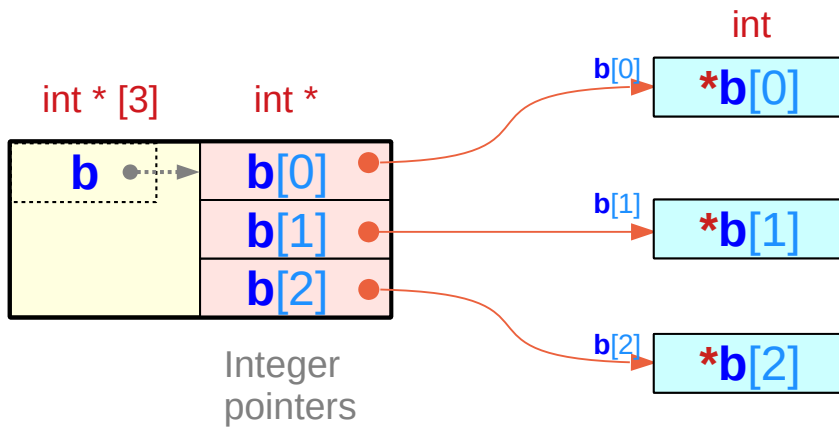

Assigning a 1-d array name

int *

b [3] ;

Pointer Array

int

a [4] ;

assignment

b[0] = a (= &a[0])

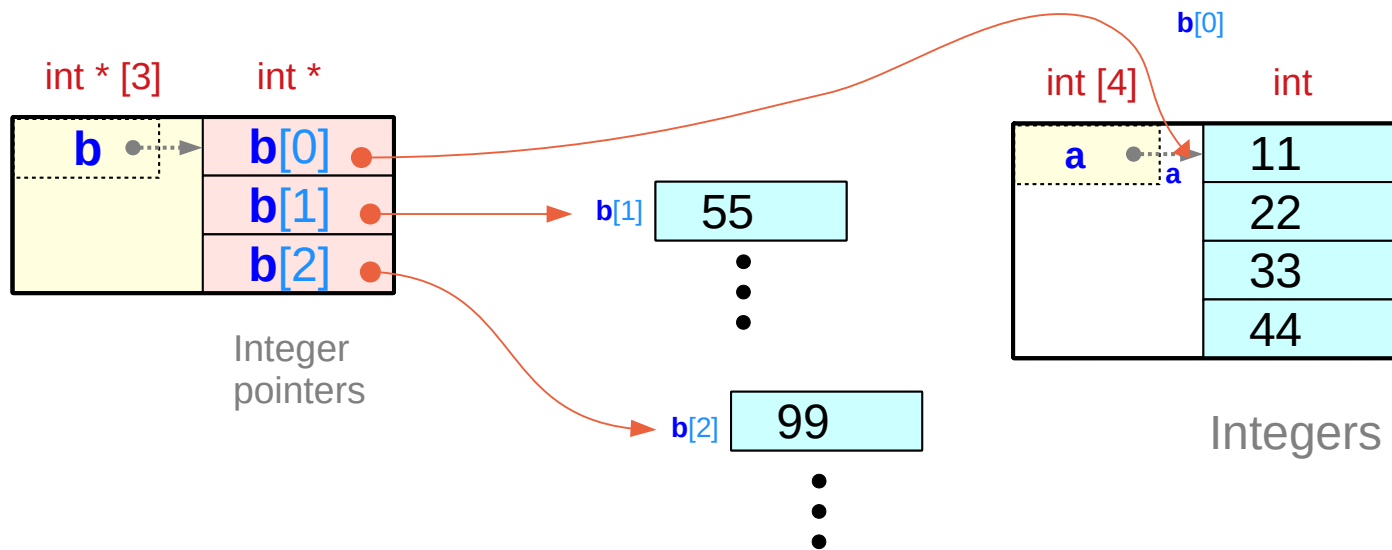

Assigning a 1-d array name – equivalence

`int *` `b [3] ;` Pointer Array

`int` `a [4] ;`

assignment

`b[0] = a (= &a[0])`

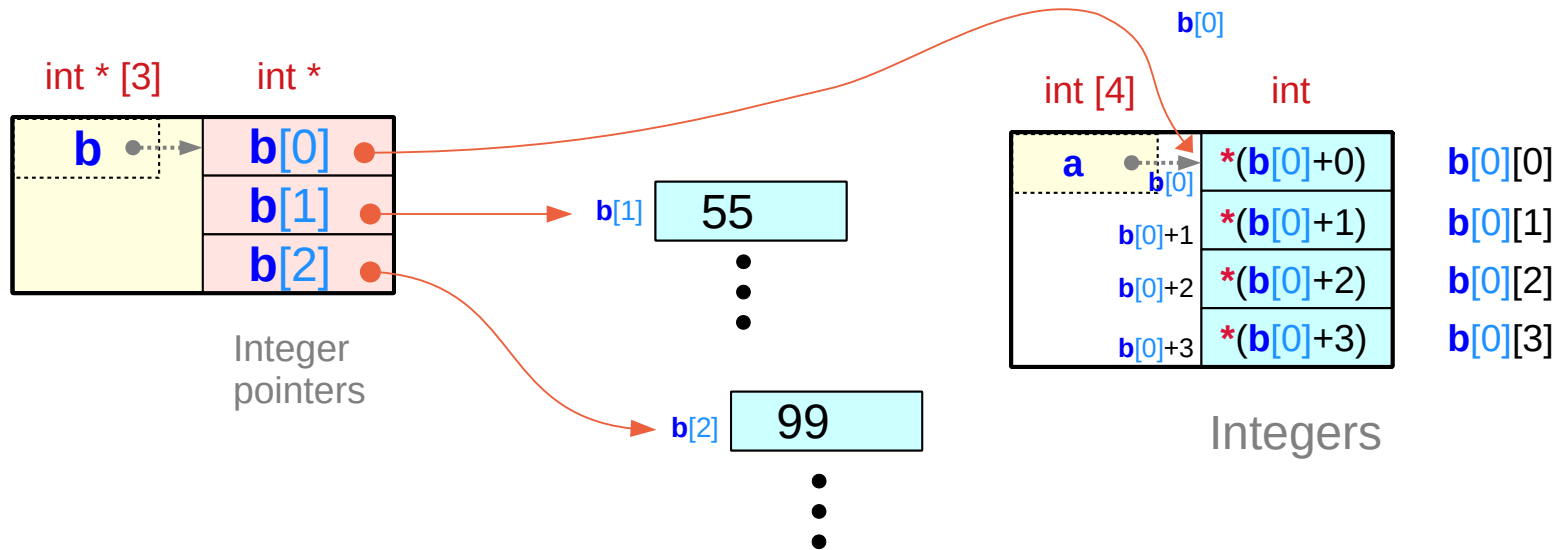

Array of Pointers – extended dimension

`int *`

`b [3] ;`

Pointer Array

`int`

`a [4] ;`

array name `b`

`int * [3]` `int *`

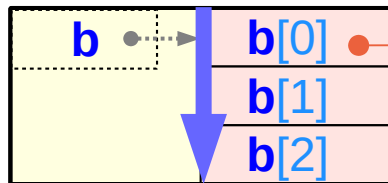

1st dim

assignment

`b[0] = a (= &a[0])`

array name `b[0]`

`int [4]` `int`

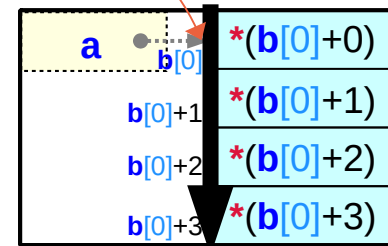

`b[0][0]`

`b[0][1]`

`b[0][2]`

`b[0][3]`

2nd dim

```
a[0] ≡ b[0][0] ≡ (*(b+0)+0)
a[1] ≡ b[0][1] ≡ (*(b+0)+1)
a[2] ≡ b[0][2] ≡ (*(b+0)+2)
a[3] ≡ b[0][3] ≡ (*(b+0)+3)
```

2-d access of 1-d arrays

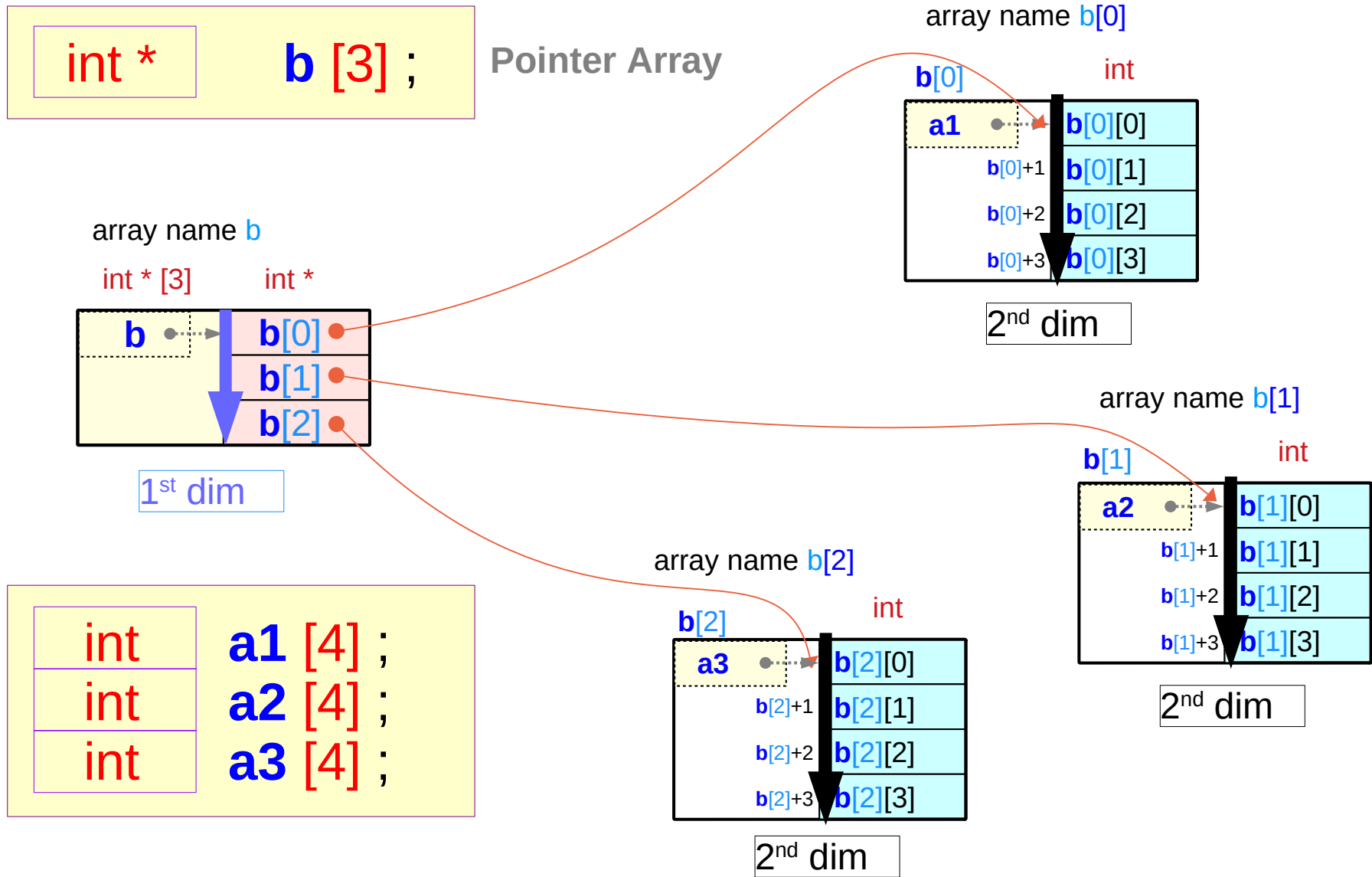

2-d access of a 1-d array

int *

b [3] ;

Pointer Array

int *

a [3*4] ;

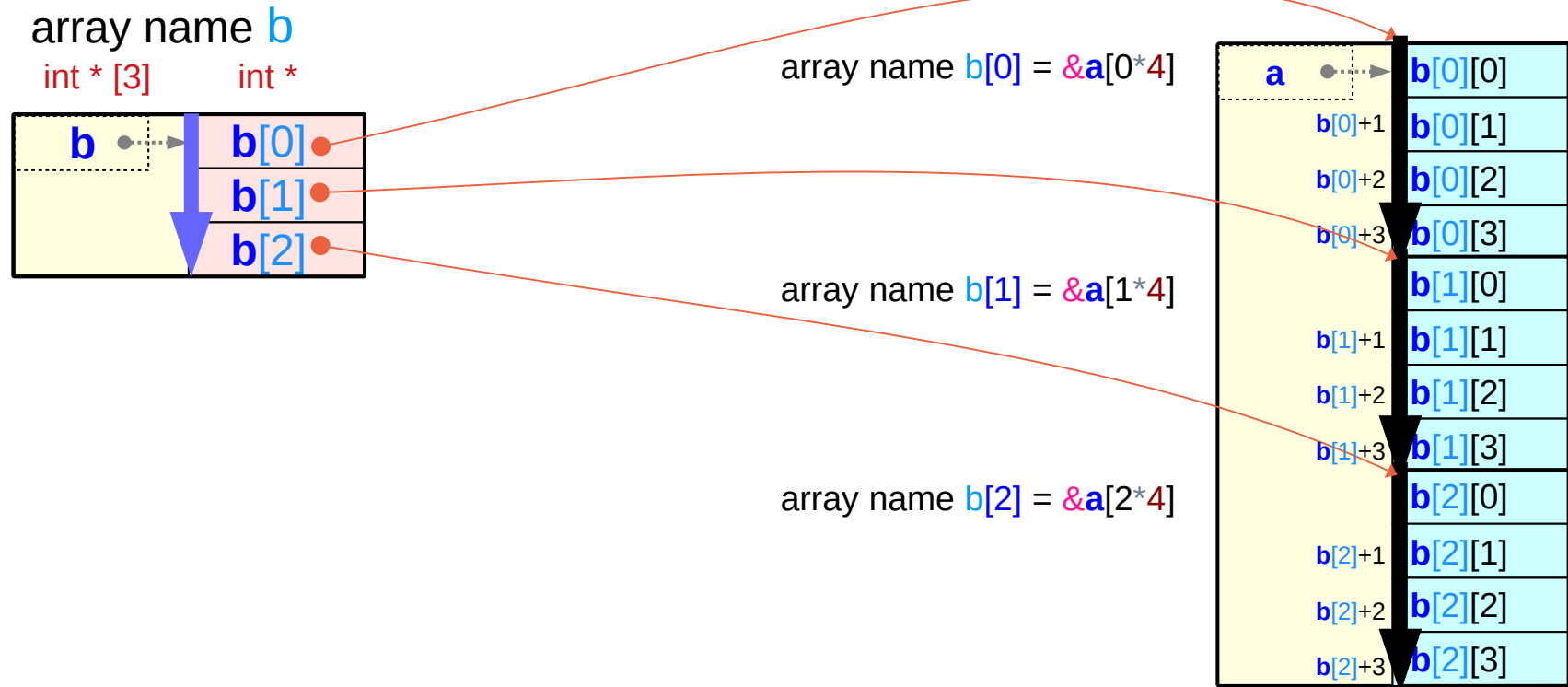

2-d access of a 1-d array – pointer array assignment

```
int * b [2*3] ;  
int a [2*3*4] ;
```

```
b[j] = &a[j*4] (= a+j*4)
```

```
b[j] + k = a+j*4 + k  
*(b[j] + k) = *(a+j*4 + k)
```

```
b[j][k] ≡ a[j*4 + k]
```

```
j = [0:5]      k = [0:3]
```

```
j*4+k = [0:23]
```

constraint : contiguous b[i][j] over j

2-d access of a 1-d array

```
b[i][j]      ≡    *( b[i] + j )  
              ↕              ↕  
a[i*4+j]    ≡    *( a+i*4 + j )
```

1-d access of a 1-d array

constraint : contiguous a[i*4+j] over j

3-d array access of a 1-d array

3-d access of a 1-d array (1)

```
int **   c [2] ;
int *   b [2*3] ;
int     a [2*3*4] ;
```

```
int *   b [2*3] ;
int     a [2*3*4] ;
```

$$b[j] = \&a[j*4] \quad (= a+j*4)$$

$$b[j] + k = a+j*4 + k$$

$$*(b[j] + k) = *(a+j*4 + k)$$

$$b[j][k] \equiv a[j*4 + k]$$

$j = [0:5] \quad k = [0:3]$
 $j*4+k = [0:23]$

```
int **   c [2] ;
int *   b [2*3] ;
```

$$c[i] = \&b[i*3] \quad (= b+i*3)$$

$$c[i] + j = b+i*3 + j$$

$$*(c[i] + j) = *(b+i*3 + j)$$

$$c[i][j] = b[i*3 + j]$$

$$c[i][j] + k = b[i*3 + j] + k$$

$$*(c[i][j] + k) = b[i*3 + j][k]$$

$$c[i][j][k] = a[(i*3 + j)*4 + k]$$

$$c[i][j][k] \equiv a[(i*3+j)*4+k]$$

$i = [0:1] \quad j = [0:2] \quad k = [0:3]$
 $(i*3+j)*4+k = [0:23]$

3-d access of a 1-d array (2)

| | |
|--------|--------------------|
| int ** | c [2] ; |
| int * | b [2*3] ; |
| int | a [2*3*4] ; |

$$\begin{aligned} \mathbf{a[k]} &\equiv *(\mathbf{a+k}) \\ \mathbf{b[j][k]} &\equiv *(*(\mathbf{b+j})+k) \\ \mathbf{c[i][j][k]} &\equiv *(*(*(\mathbf{c+i})+j)+k) \end{aligned}$$

constraint : contiguous a[i], b[i], c[i]

Assignments

$$\begin{aligned} \mathbf{c[i]} &= \&\mathbf{b[i*3]} \quad (= \mathbf{b+i*3}) \\ \mathbf{b[j]} &= \&\mathbf{a[j*4]} \quad (= \mathbf{a+j*4}) \end{aligned}$$

Initializing pointer arrays **b** and **c**



3-d access of a 1-d array

$$\begin{aligned} \mathbf{c[i][j][k]} &\equiv *(\mathbf{c[i][j]} + k) \\ \mathbf{b[i*3+j][k]} &\equiv *(\mathbf{b[i*3+j]} + k) \\ \mathbf{a[(i*3+j)*4 + k]} &\equiv *(\mathbf{a+(i*3+j)*4 + k}) \end{aligned}$$

1-d access of a 1-d array

3-d access of a 1-d array (3)

| | |
|--------|--------------------|
| int ** | c [2] ; |
| int * | b [2*3] ; |
| int | a [2*3*4] ; |

| | |
|--------------------|---|
| a [k] | ≡ * (a +k) |
| b [j][k] | ≡ * (* (b +j)+k) |
| c [i][j][k] | ≡ * (* (* (c +i)+j)+k) |

| |
|-----------------------------|
| ((c[i])[j])[k] |
| ≡ ((b+i*3)[j])[k] ← |
| ≡ (b[i*3+j])[k] |
| ≡ (a+(i*3+j)*4)[k] ← |
| ≡ a[(i*3+j)*4+k] |

$$c[i] = \&b[i*3] = b+i*3$$

$$b[j] = \&a[j*4] = a+j*4$$

| |
|---|
| * (* (* (c +i)+j)+k) |
| ≡ * (* (b +i*3+j)+k) |
| ≡ * (b [i*3+j]+k) |
| ≡ * (a +(i*3+j)*4+k) |
| ≡ a [(i*3+j)*4+k] |

Equivalence relations in pointer array assignments

$$\begin{aligned}c[i] &= \&b[i*3] = b+i*3 \\ b[j] &= \&a[j*4] = a+j*4\end{aligned}$$

substitute $c[i]$ in $*(c[i]+j)$

substitute $b[m]$ in $*(b[m]+k)$

$$m = i*3+j$$



$$\begin{aligned}c[i][j] &\stackrel{\text{substitute } c[i]}{=} *(c[i]+j) \\ &= *(b+i*3+j) = b[i*3+j]\end{aligned}$$

$$\begin{aligned}b[m][k] &\stackrel{\text{substitute } b[m]}{=} *(b[m]+k) \\ &= *(a+m*4+k) = a[m*4+k]\end{aligned}$$

$$c[i][j][k] = b[i*3+j][k] = a[(i*3+j)*4+k]$$

$$\begin{aligned}c[i] &= \&b[i*3] = b+i*3 \\ b[j] &= \&a[j*4] = a+j*4\end{aligned}$$

substitute $c[i]$ in $(c[i])[j]$

substitute $b[m]$ in $(b[m])[k]$

$$m = i*3+j$$



$$\begin{aligned}c[i][j] &\stackrel{\text{substitute } c[i]}{=} (b+i*3)[j] \\ &= *(b+i*3+j) = b[i*3+j]\end{aligned}$$

$$\begin{aligned}b[m][k] &\stackrel{\text{substitute } b[m]}{=} (a+m*4)[k] \\ &= *(a+m*4+k) = a[m*4+k]\end{aligned}$$

$$c[i][j][k] = b[i*3+j][k] = a[(i*3+j)*4+k]$$

Integer array **a** and pointer arrays **b**, **c**

```
int ** c [2] ;  
int * b [2*3] ;  
int a [2*3*4] ;
```

divide 2·3·4 elements of **a** into
six (= 2·3) partitions
each partition has 4 elements

divide 2·3 elements of **b** into
two (= 2) partitions
each partition has 3 elements

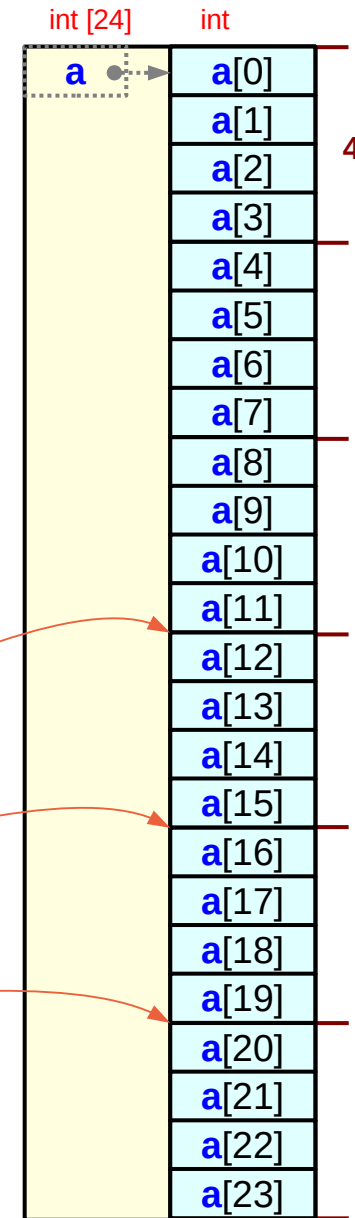
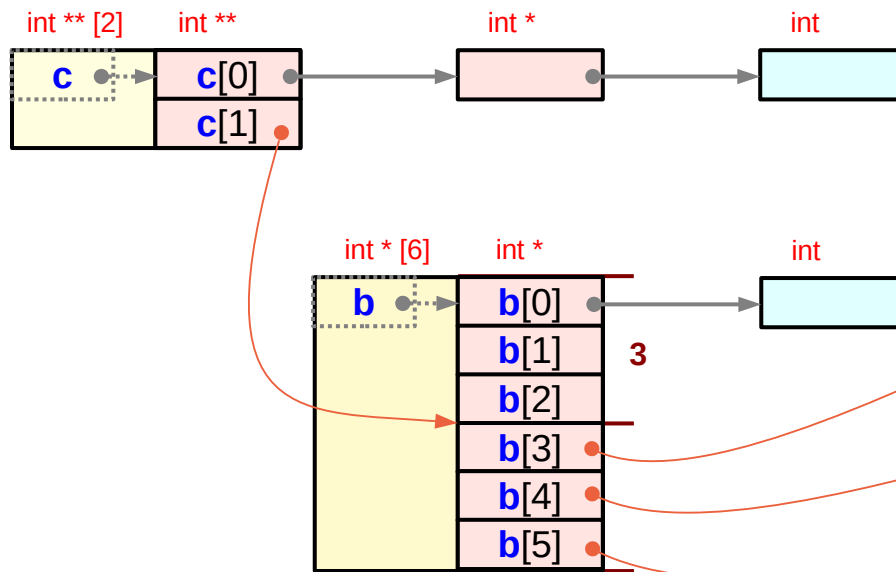

Pointer array initializations

| | |
|--------|--------------------|
| int ** | c [2] ; |
| int * | b [2*3] ; |
| int | a [2*3*4] ; |

$$c[i] = \&b[i*3] \quad (= b+i*3)$$

each element of **c** handles **3** elements of **b**
 → **3**-element partitions in **b**

$$b[j] = \&a[j*4] \quad (= a+j*4)$$

each element of **b** handles **4** elements of **a**
 → **4**-element partitions in **a**

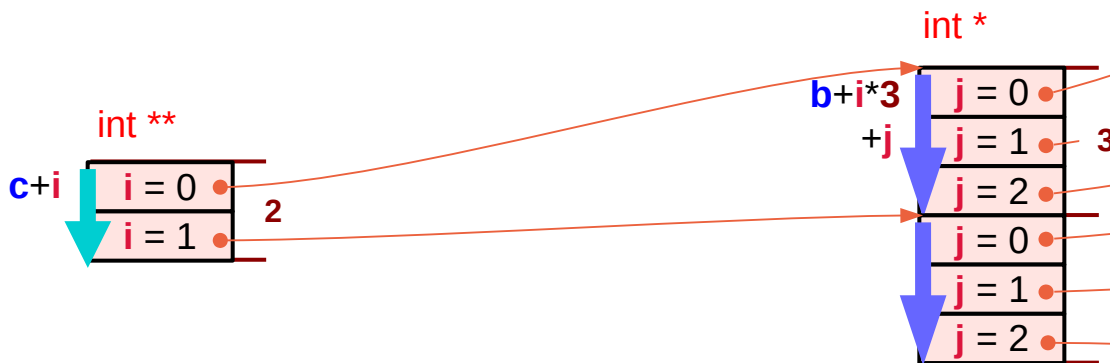

skipping **i** elements from **c**
 = skipping **i*3** elements from **b**
 = skipping **i*3*4** leaf elements from **a**

skipping **j** elements from **b**
 = skipping **j*4** leaf elements from **a**

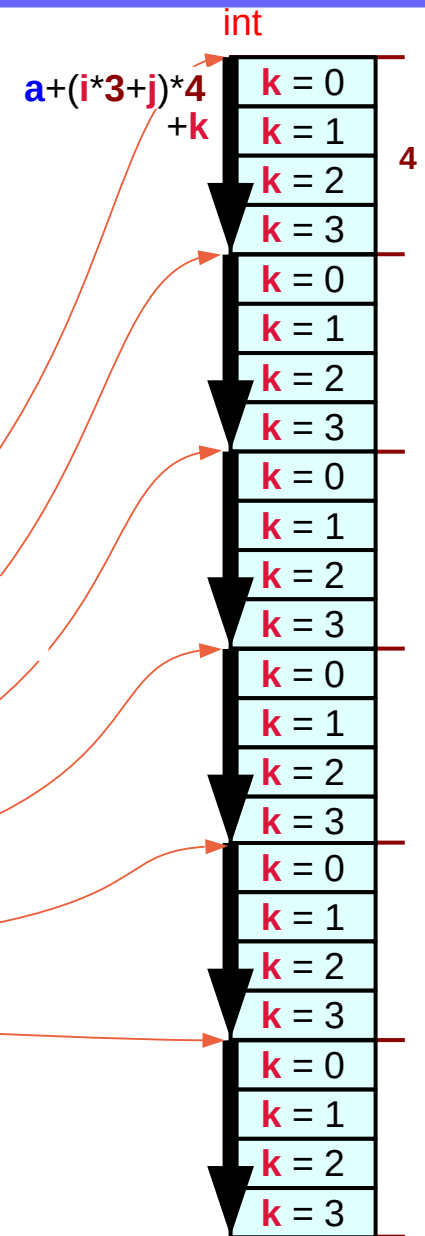

Partitioning arrays **a** and **b**

| | |
|--------|--------------------|
| int ** | c [2] ; |
| int * | b [2*3] ; |
| int | a [2*3*4] ; |

Assigning pointer array

b[j] = &**a**[j*4] (= **a**+j*4)
c[i] = &**b**[i*3] (= **b**+i*3)

c[0] = &**b**[0*3]; (= **b** + 0*3)
c[1] = &**b**[1*3]; (= **b** + 1*3)

b[0] = &**a**[0*4]; (= **a** + 0*4)
b[1] = &**a**[1*4]; (= **a** + 1*4)
b[2] = &**a**[2*4]; (= **a** + 2*4)
b[3] = &**a**[3*4]; (= **a** + 3*4)
b[4] = &**a**[4*4]; (= **a** + 4*4)
b[5] = &**a**[5*4]; (= **a** + 5*4)

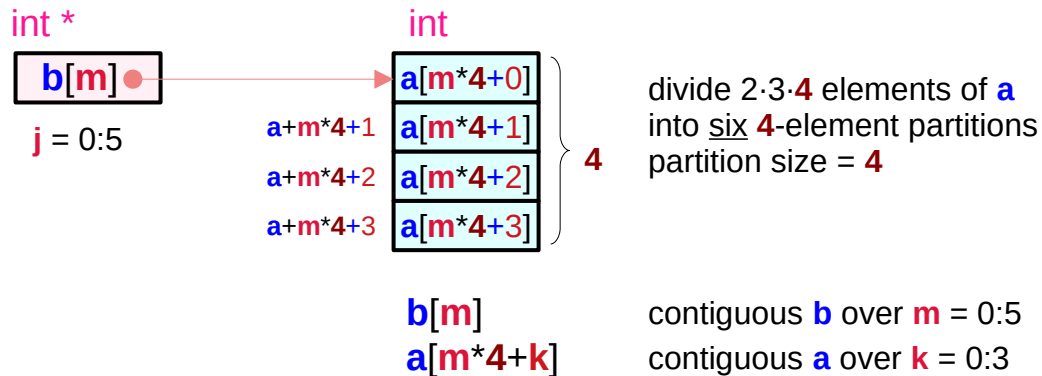
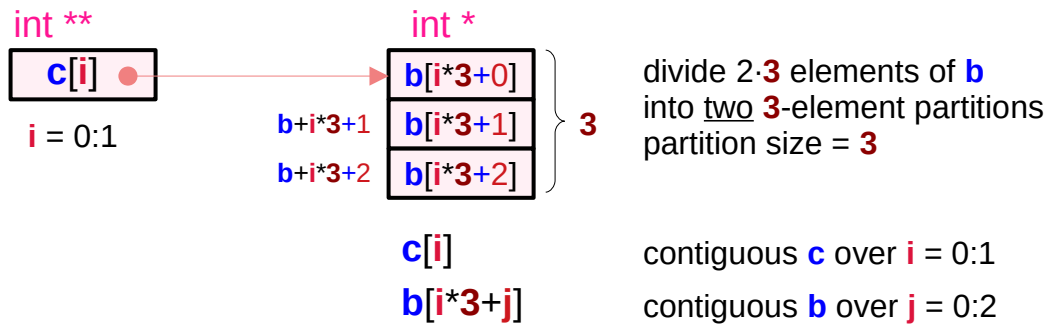

Skipping leaf elements

| | |
|--------|--------------------|
| int ** | c [2] ; |
| int * | b [2*3] ; |
| int | a [2*3*4] ; |

$$\mathbf{b[j] = \&a[j*4] \quad (= a+j*4)}$$

skipping 1 element in **b**
= skipping **4** leaf elements in **a**

$$\mathbf{c[i] = \&b[i*3] \quad (= b+i*3)}$$

skipping 1 element in **c**
= skipping **3** elements in **b**
= skipping **3*4** leaf elements in **a**

$$\mathbf{c[i][j][k] \equiv a[(i*3 + j)*4+k]}$$

skipping **i*3+j** elements from **b**
+ skipping **k** leaf elements from **a**
= skipping **(i*3+j)*4+k** leaf elements from **a**

$$\mathbf{c[i][j] \equiv b[i*3 + j]}$$

skipping **i** elements from **c**
+ skipping **j** elements from **b**
= skipping **i*3+j** elements from **b**

Contiguous constraints for $c[i][j][k]$

| | |
|--------|--------------------|
| int ** | c [2] ; |
| int * | b [2*3] ; |
| int | a [2*3*4] ; |



| | |
|--------------|--------------------------------------|
| b [j] | = & a [j*4] (= a +j*4) |
| c [i] | = & b [i*3] (= b +i*3) |



| | |
|--------------------------|---|
| c [i][j][k] | ≡ |
| a [(i*3 + j)*4+k] | |

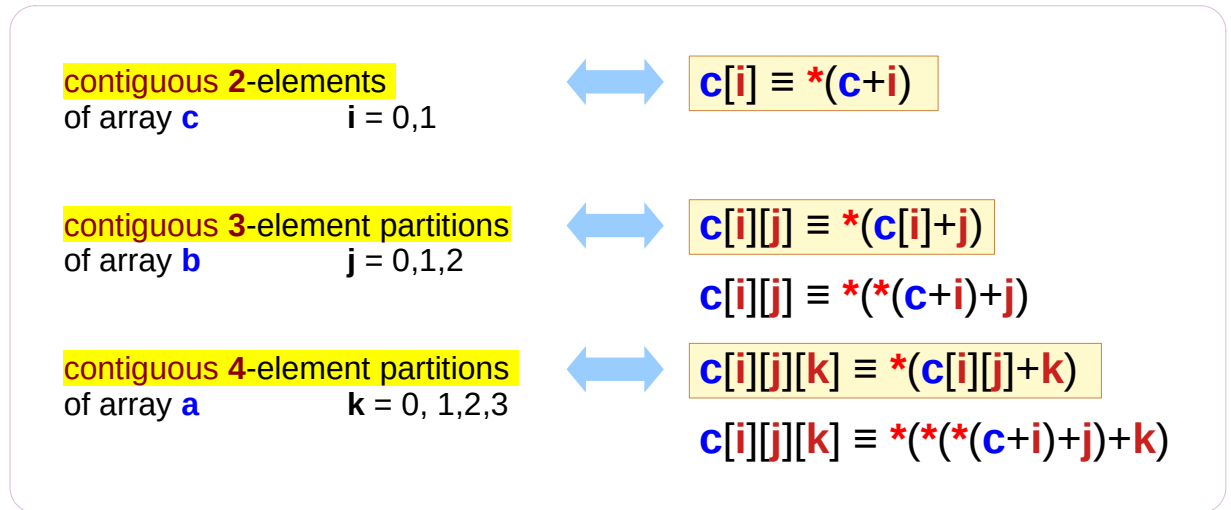
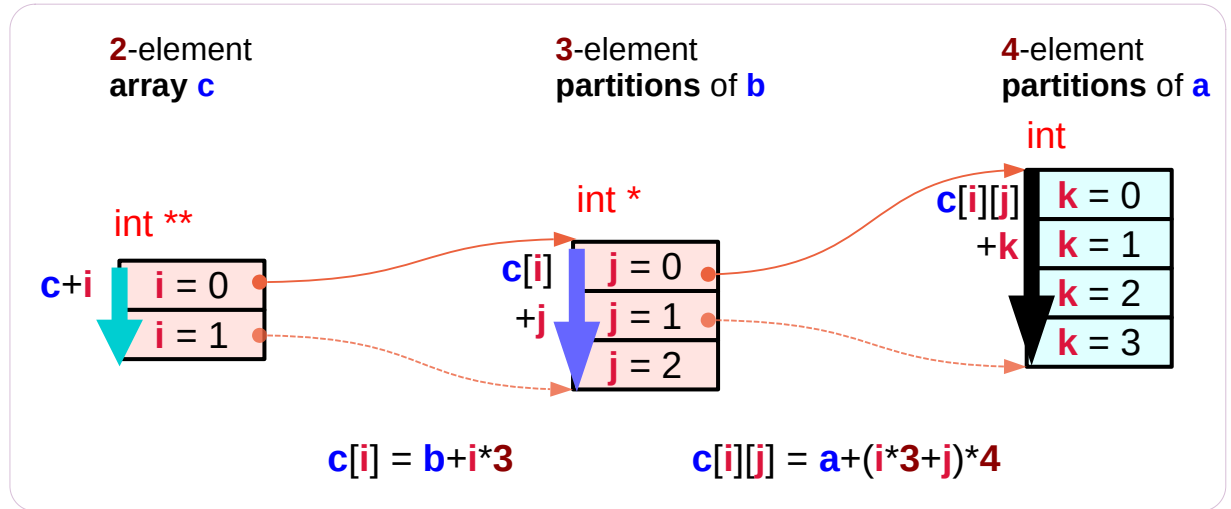

Minimal constraints and implementations

```
int c [2];      int b [2*3];   int c [2*3*4];
```

```
c[0] = &b[0*3];  b[0] = &a[0*4];  
c[1] = &b[1*3];  b[1] = &a[1*4];  
                b[2] = &a[2*4];  
                b[3] = &a[3*4];  
                b[4] = &a[4*4];  
                b[5] = &a[5*4];
```

```
int c [2];      int b1 [3];   int a1 [4];  
                int b2 [3];   int a2 [4];  
                int a3 [4];  
                int a4 [4];  
                int a5 [4];  
                int a6 [4];
```

```
c[0] = &b1[0];   b1[0] = &a1[0];  
c[1] = &b2[0];   b1[1] = &a2[0];  
                b1[2] = &a3[0];  
                b2[0] = &a4[0];  
                b2[1] = &a5[0];  
                b2[2] = &a6[0];
```

contiguous
2-element
array **c**

contiguous
2·3-element
array **b**

contiguous
2·3·4-element
array **a**

minimal constraints

contiguous
2-element
array **c**

two contiguous
3-element
partitions of **b**

six contiguous
4-element
partitions of **a**

two contiguous
3-element
arrays **bi**

six contiguous
4-element
arrays **ai**

Accessing a **contiguous 1-d** array

- **1-d** array access
- **2-d** array access
- **3-d** array access

Accessing an int array **a** as a **1-d** array

```
int    a [2*3*4] ;
```



```
a [k]
```

k = 0,1, ...,23

```
int a [2*3*4] ;
```

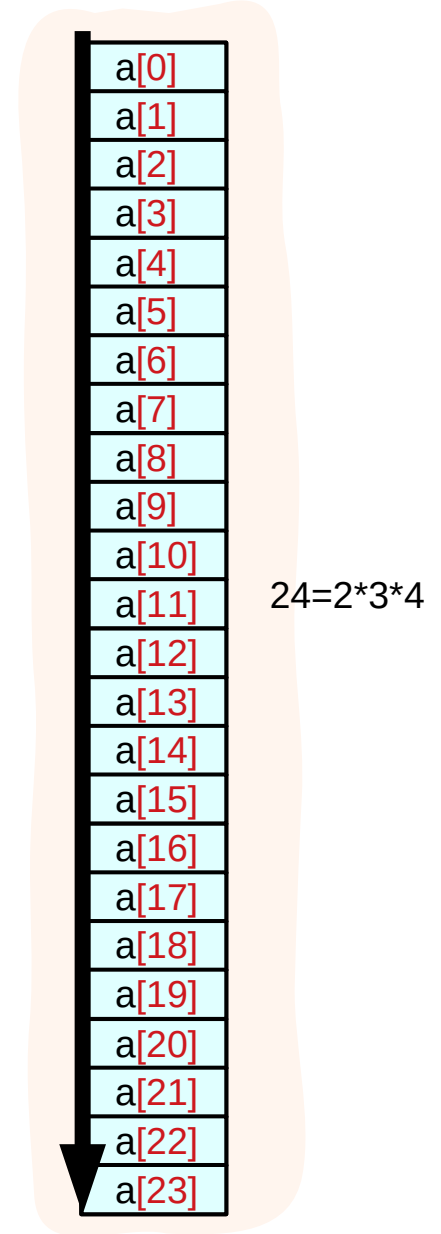

```
c[i][j][k] ≡ *(* (c+i)+j)+k    int ** c[2] ;  
b[j][k]    ≡ *(* (b+j)+k)      int * b[2*3] ;  
a[k]       ≡ *(a+k)            int a[2*3*4] ;
```

Accessing an int array **a** as a 2-d array using **b**

```
int    a [2*3*4] ;
int *  b [2*3] ;
```

```
b[j] = &a[j*4];
```

a, b take actual memory locations

$$b[j][k] \equiv a[j*4 + k]$$

$j = 0, 1, 2, 3, 4$
 $k = 0, 1, 2, 3$

```
c[i][j][k] ≡ *(* (c+i)+j)+k    int ** c[2] ;
b[j][k]    ≡ *(* (b+j)+k)      int * b[2*3] ;
a[k]       ≡ *(a+k)            int a[2*3*4] ;
```

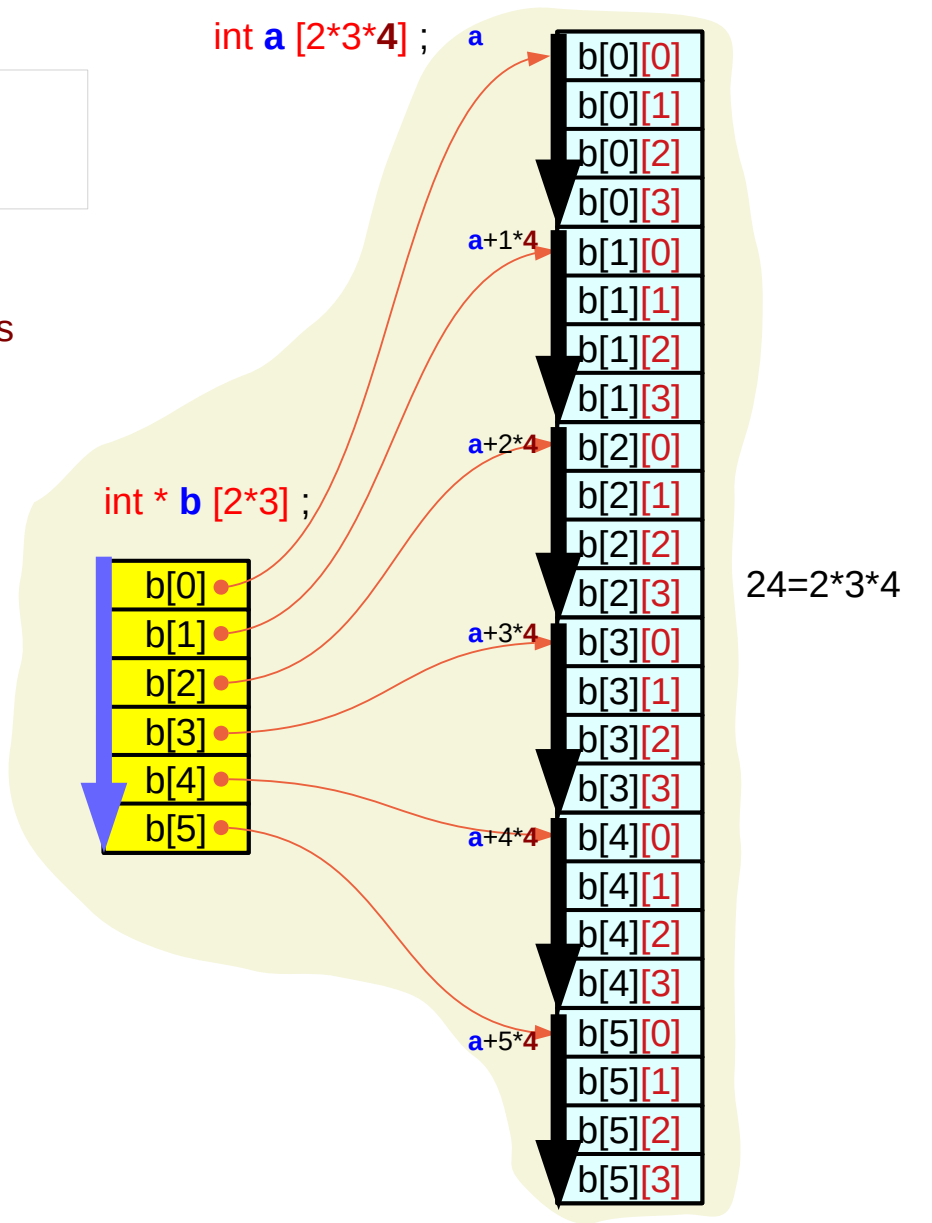

Accessing an int array **a** as a 3-d array

```
int    a [2*3*4] ;
int *  b [2*3]  ;
int ** c [2]    ;
```

```
c[i] = &b[i*3];
b[j] = &a[j*4];
```

a, **b**, **c** take actual memory locations

$$c[i][j][k] \equiv a[(i*3+j)*4+k]$$

i = 0, 1
j = 0, 1, 2
k = 0, 1, 2, 3

```
c[i][j][k] ≡ *(*(*c+i)+j)+k
b[j][k]    ≡ *(*b+j)+k
a[k]       ≡ *(a+k)

int ** c[2];
int * b[2*3];
int a[2*3*4];
```

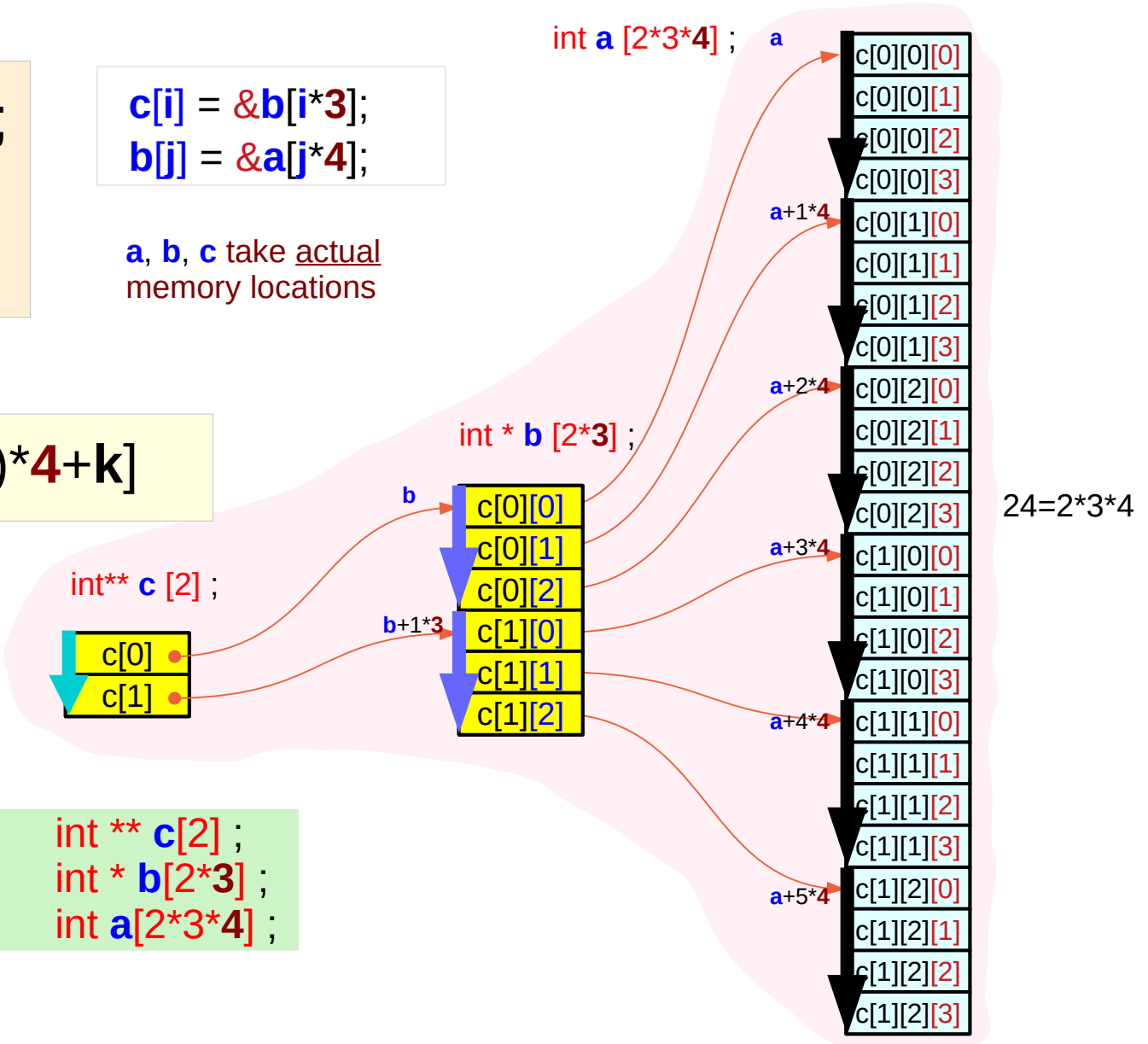

Accessing a **non-contiguous 1-d** arrays

- ◆ **3-d** array access

Accessing non-contiguous 1-d arrays as a 3-d array (1)

```
int    a [2*3*4] ;
int *  b [2*3] ;
int ** c [2] ;
```

```
c[i] = &b[i*3];
b[j] = &aj[0];
```

not c expressions

aj, b, c take actual memory locations

```
int a1 [4];
int a2 [4];
int a3 [4];
int a4 [4];
int a5 [4];
int a6 [4];
```

```
c [i][j][k]
```

i = 0, 1
j = 0, 1, 2
k = 0, 1, 2, 3

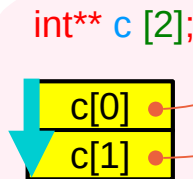

```
int* b [2*3];
```

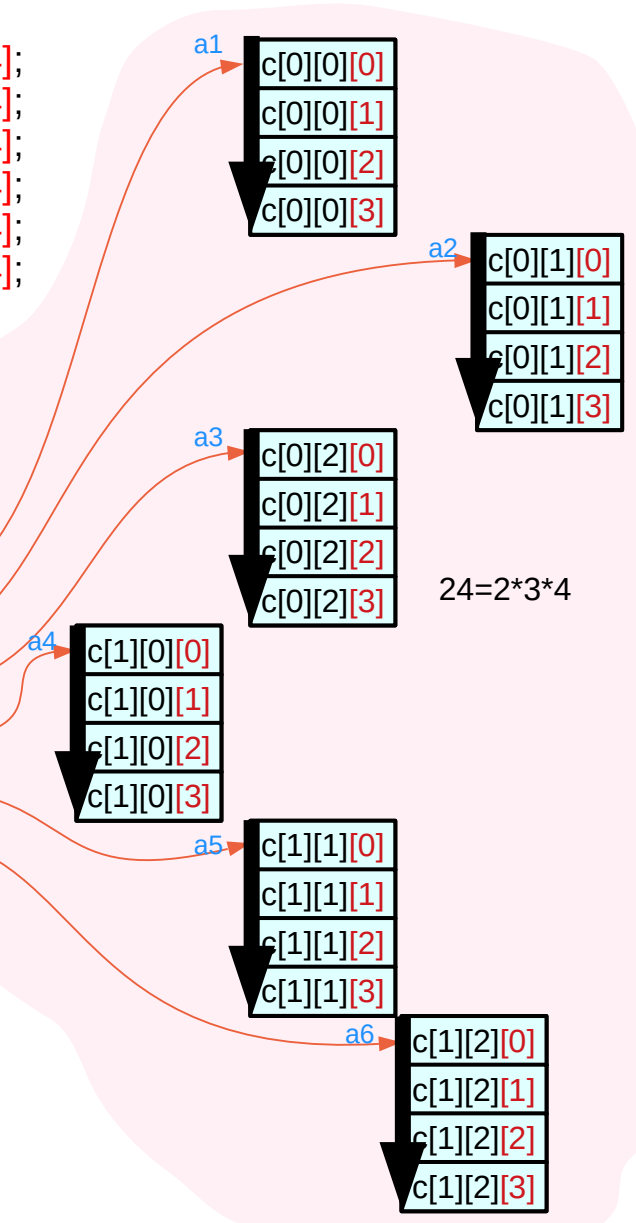
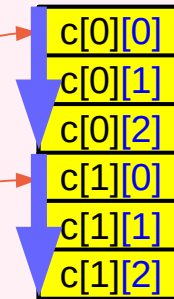

24=2*3*4

Because the physical **allocation** of array **c** and **b**,
the **contiguous constraints** can be **relaxed**
contiguous **c[i][j][k]** only for **k=0,1,2,3**

Accessing non-contiguous 1-d arrays as a 3-d array (2)

```
int    a [2*3*4] ;
int *  b [2*3] ;
int ** c [2] ;
```

not c expressions

```
c[i] = &bi[0];
bi[j] = &aj[0];
```

not c expressions
aj, bi, c take actual memory locations

```
int a1 [4];
int a2 [4];
int a3 [4];
int a4 [4];
int a5 [4];
int a6 [4];

int b1 [3];
int b2 [3];
```

```
c [i][j][k]
```

i = 0, 1
j = 0, 1, 2
k = 0, 1, 2, 3

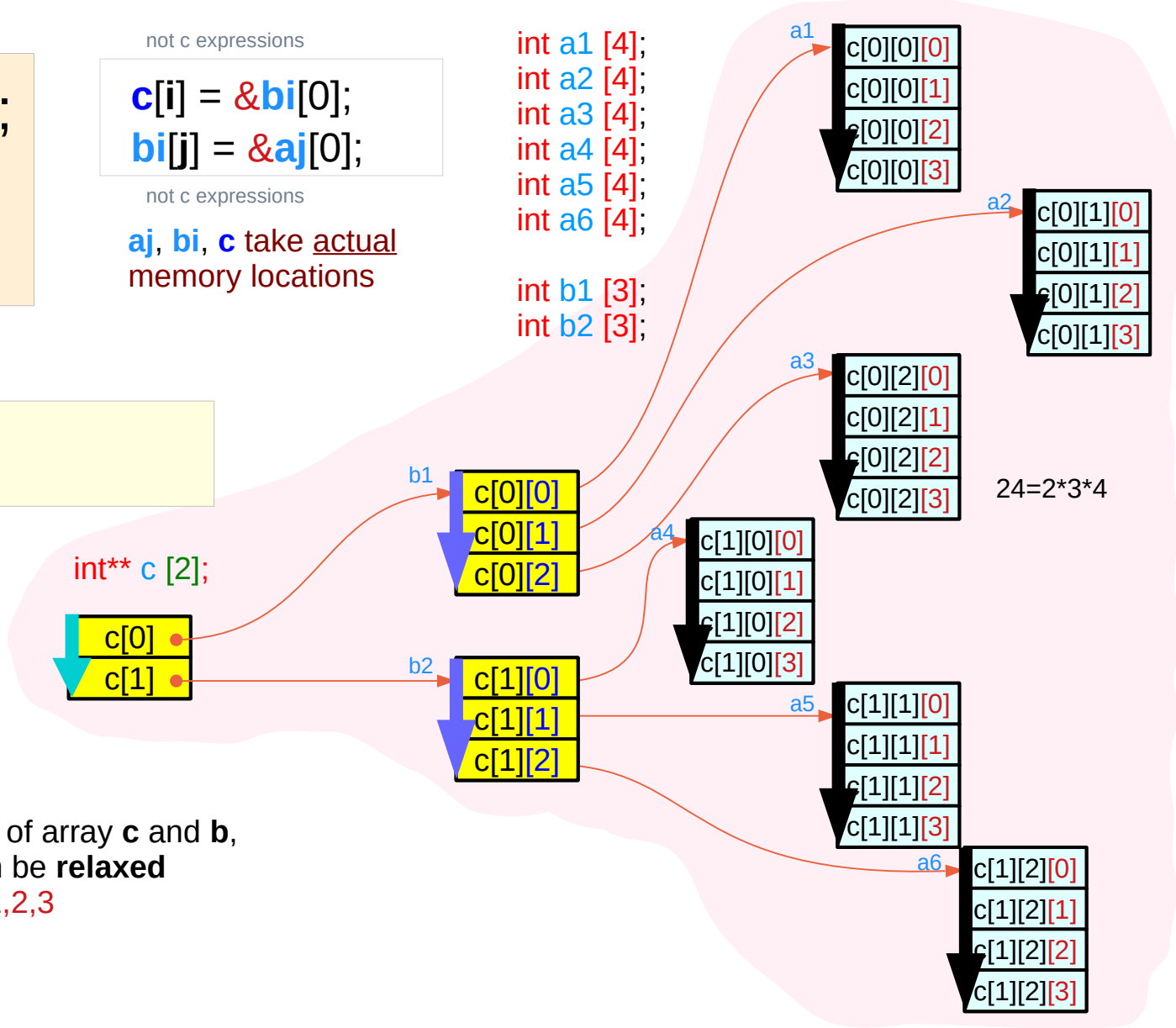
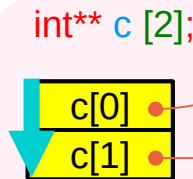

Because the physical **allocation** of array **c** and **b**,
the **contiguous constraints** can be **relaxed**
contiguous $c[i][j][k]$ only for $k=0,1,2,3$

Accessing **statically** allocated arrays

Accessing **dynamically** allocated arrays

Using arrays **a**, **b**, **c** – statically allocated

| | |
|--------|-------------------|
| int ** | c [2]; |
| int * | b [2*3]; |
| int | a [2*3*4]; |

static memory allocation

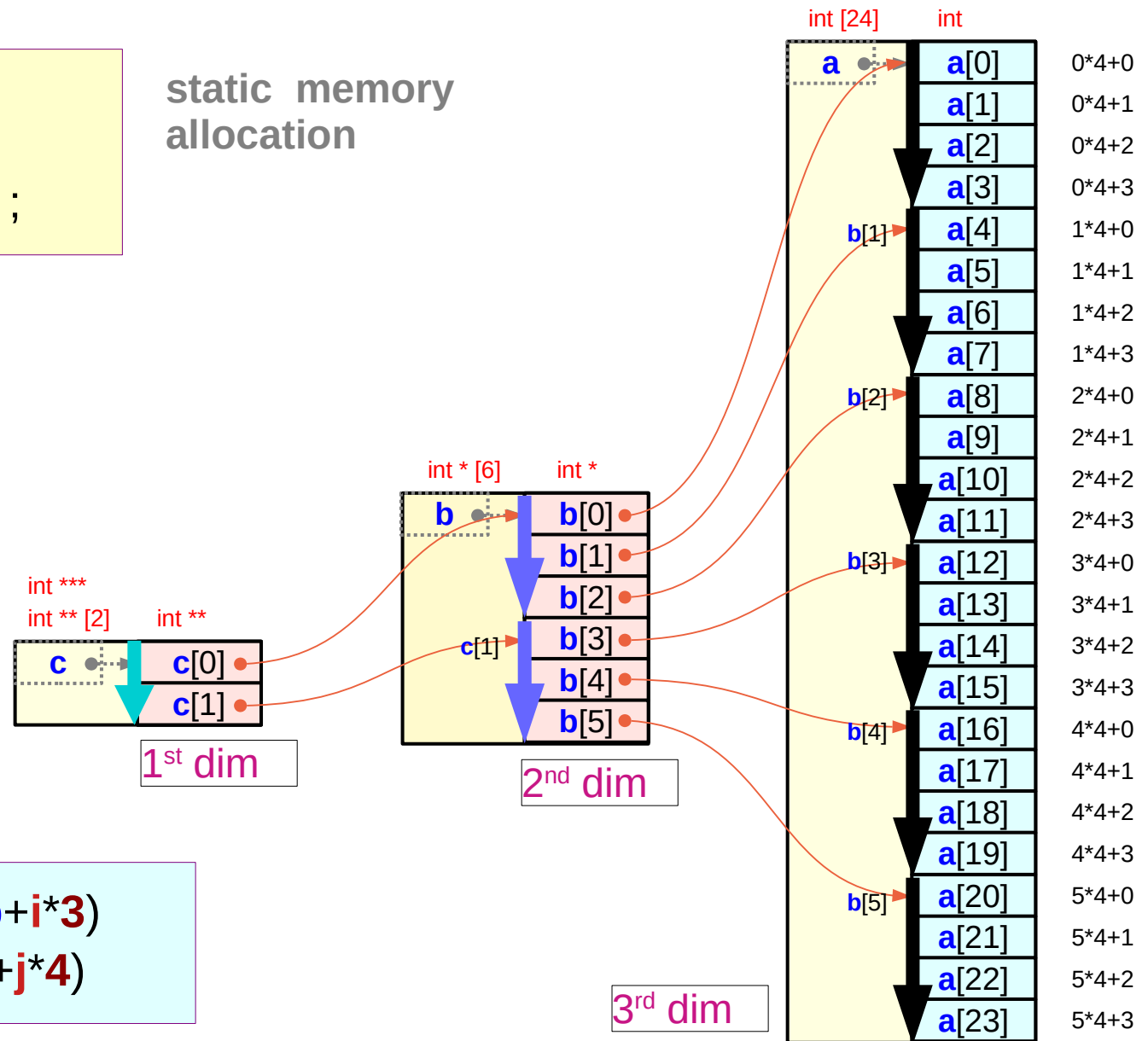

| | | | |
|--------------|---|---------------------|-------------------|
| c [i] | = | &b [i*3] | (= b +i*3) |
| b [j] | = | &a [j*4] | (= a +j*4) |

Using pointer **a**, **b**, **c** – dynamically allocated

```

int *** c = (int ***) malloc(2 * sizeof(int **));
int ** b = (int **) malloc(2*3 * sizeof(int *));
int * a = (int *) malloc(2*3*4 * sizeof(int));
    
```

dynamic memory allocation

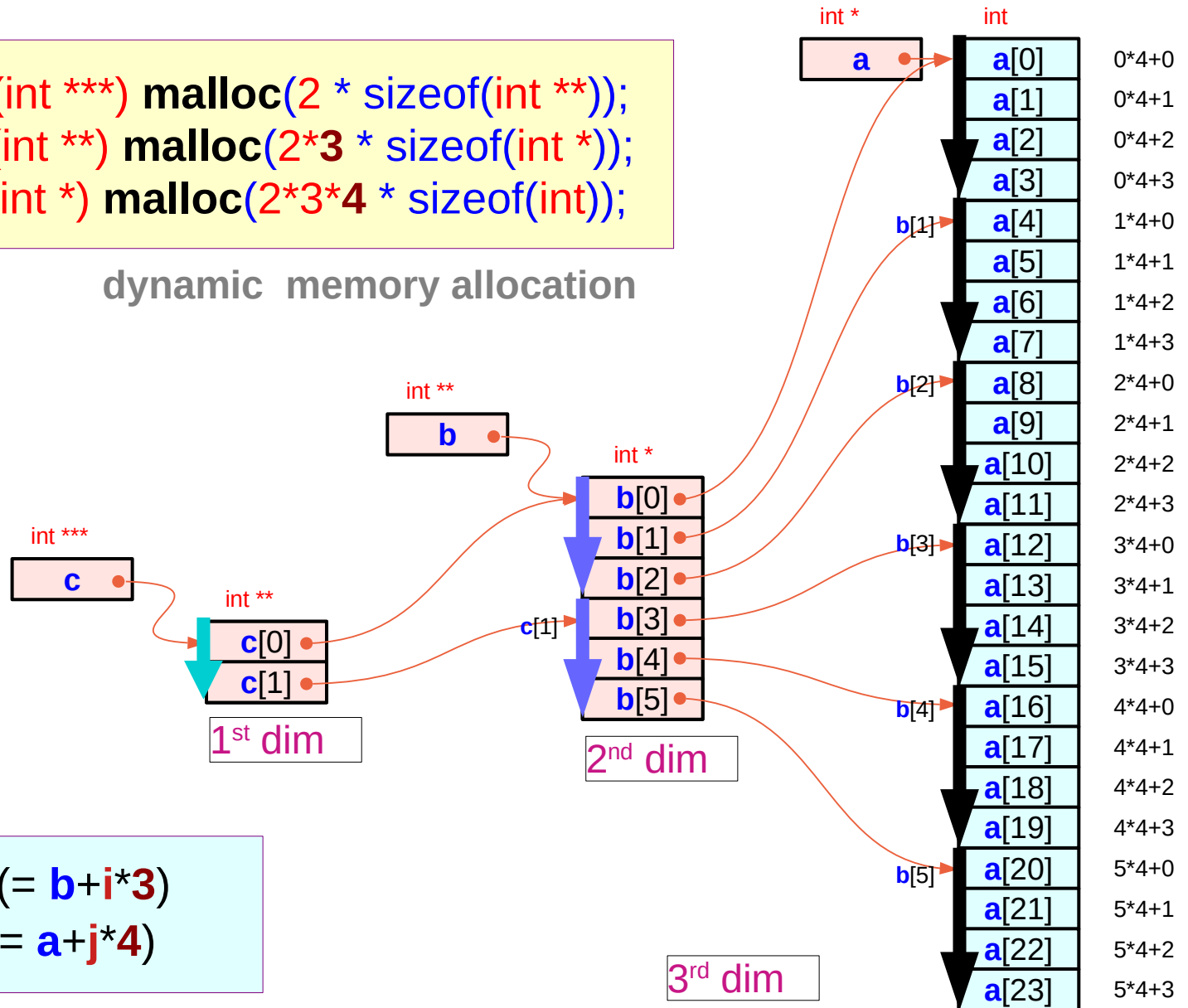

```

c[i] = &b[i*3] (= b+i*3)
b[j] = &a[j*4] (= a+j*4)
    
```

Static v.s. dynamic allocation (1)

| | | |
|--------|----------|----------|
| int ** | c | [2]; |
| int * | b | [2*3]; |
| int | a | [2*3*4]; |

static memory allocations

type(**c**) = int ** [2] → int ***

type(**b**) = int * [2*3] → int **

type(**a**) = int [2*3*4] → int *

sizeof(**c**) = 2 * sizeof(int **)

sizeof(**b**) = 2*3 * sizeof(int *)

sizeof(**a**) = 2*3*4 * sizeof(int)

value(**c**[i]) = **b** + 3*i

value(**b**[j]) = **a** + 4*j

| | | |
|---------|----------|---|
| int *** | c | = (int ***) malloc(2 * sizeof(int **)); |
| int ** | b | = (int **) malloc(2*3 * sizeof(int *)); |
| int * | a | = (int *) malloc(2*3*4 * sizeof(int)); |

dynamic memory allocations

type(**c**) = int ***

type(**b**) = int **

type(**a**) = int *

sizeof(**c**) = 4 bytes on 32-bit system

sizeof(**b**) = 4 bytes on 32-bit system

sizeof(**a**) = 4 bytes on 32-bit system

value(**c**[i]) = **b** + 3*i

value(**b**[j]) = **a** + 4*j

c[i] = **&b**[i*3] (= **b**+i*3)

b[j] = **&a**[j*4] (= **a**+j*4)

Static v.s. dynamic allocation (2)

- static allocation

```
int ** c [2];
int * b [2*3];
int a [2*3*4];
```

- dynamic allocation

```
int *** c = (int ***) malloc(2 * sizeof(int **));
int ** b = (int **) malloc(2*3 * sizeof(int *));
int * a = (int *) malloc(2*3*4 * sizeof(int));
```

```
c[i] = &b[i*3] (= b+i*3)
b[j] = &a[j*4] (= a+j*4)
```

$c[i][j][k]$

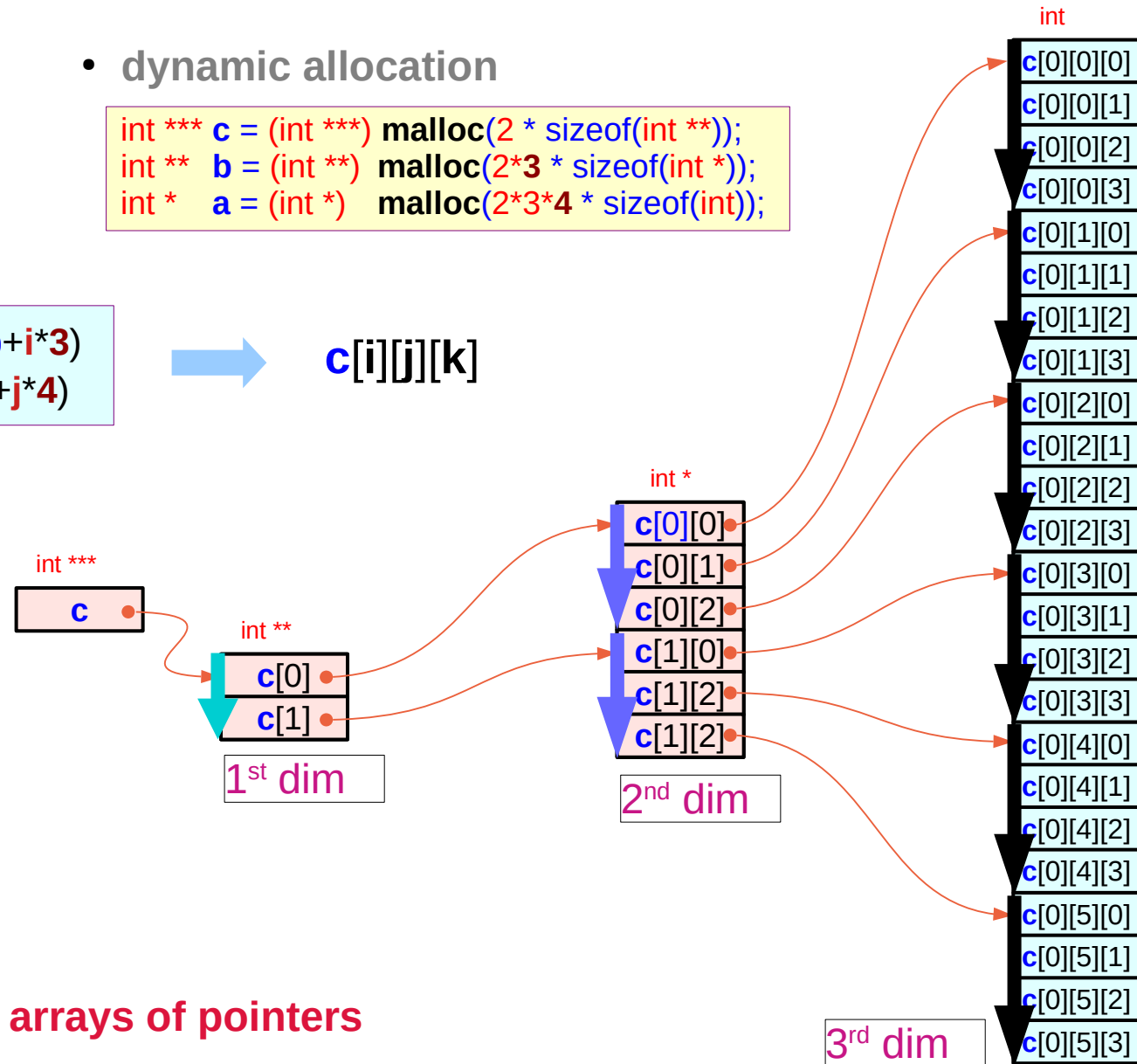

arrays of pointers

Static v.s. dynamic allocation (3)

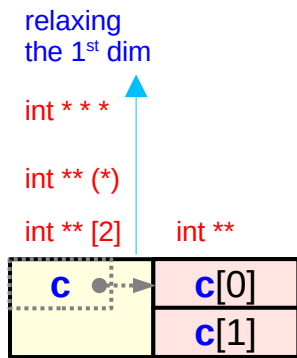

int ** c [2];

static memory allocation

```
int *** c = (int ***) malloc(2 * sizeof(int **));
```

malloc(2 * sizeof(int **));

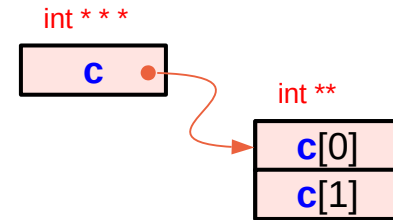
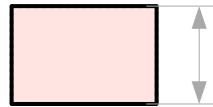

int *** c = (int ***) malloc(2 * sizeof(int **));

dynamic memory allocation

Static v.s. dynamic allocation (4)

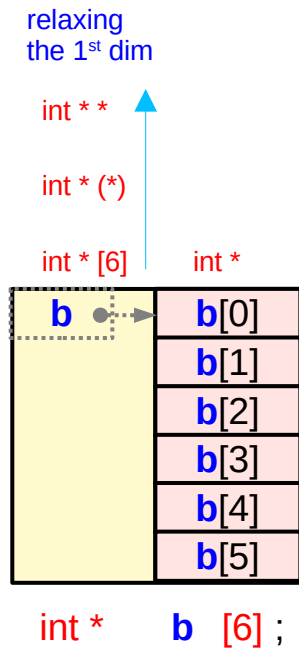

static memory allocation

```
int ** b = (int **) malloc(6 * sizeof(int *));
```

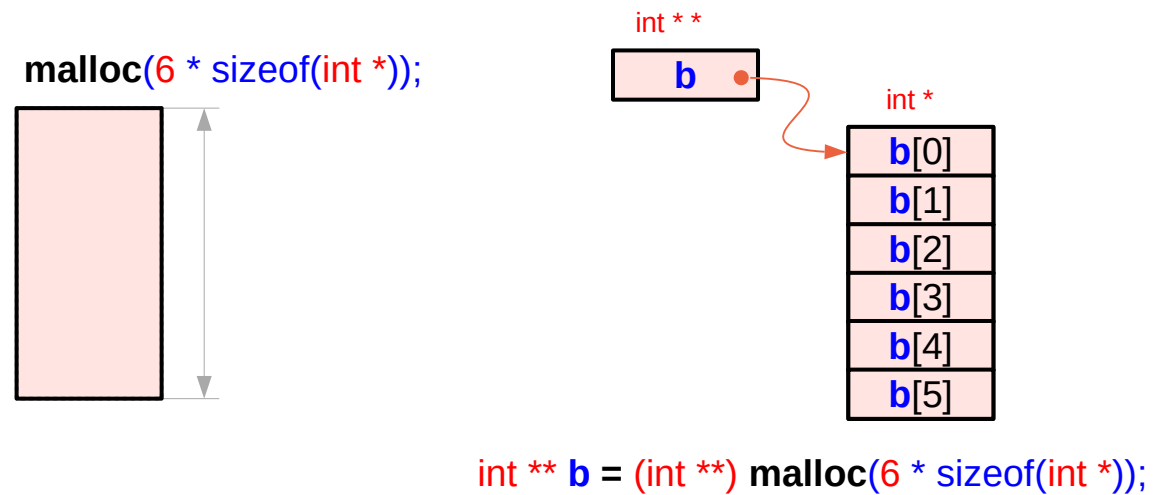

dynamic memory allocation

Static v.s. dynamic allocation (5)

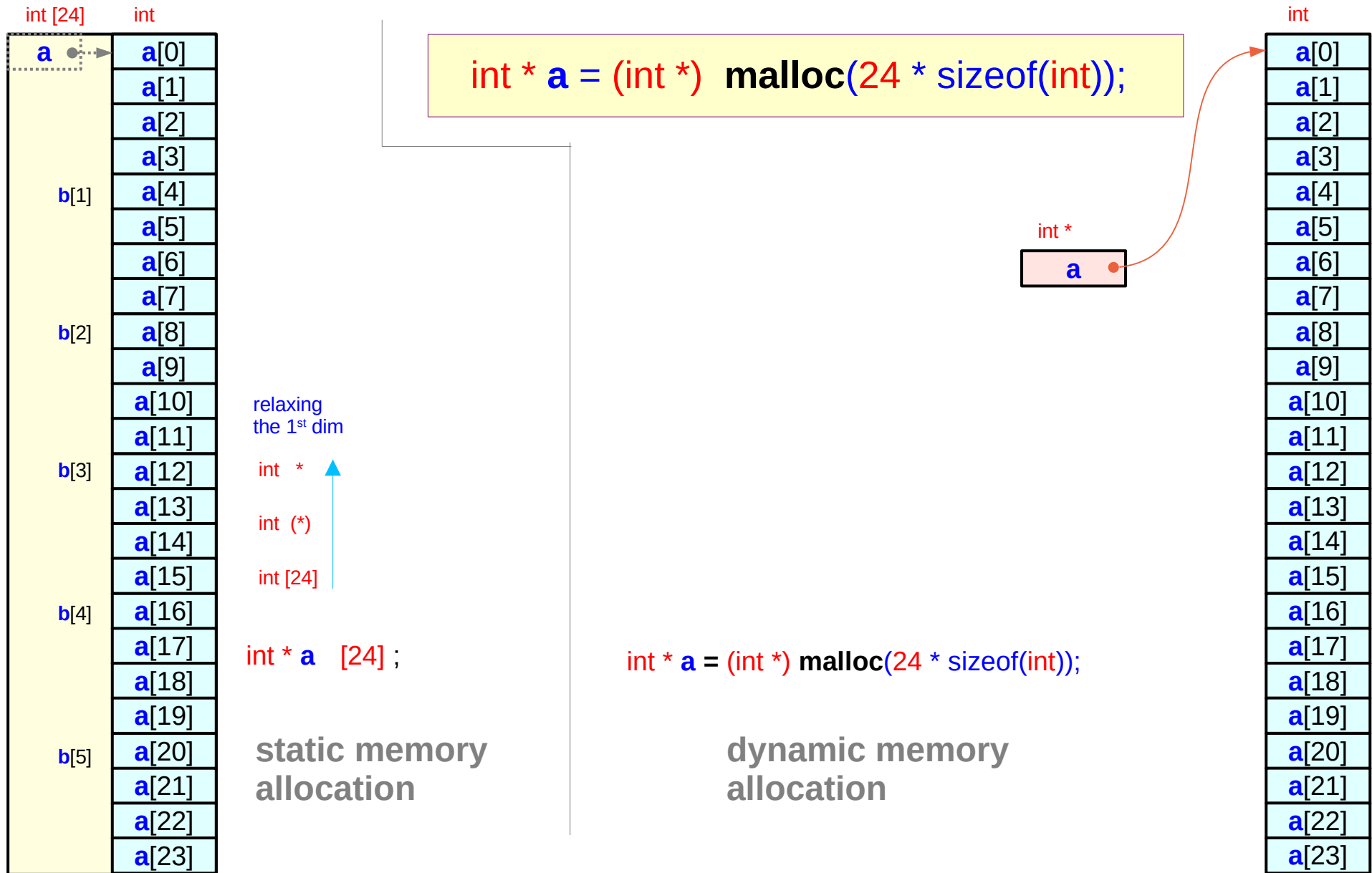

Finding sub-array sizes

```
int c [2][3][4] ;
```

$\text{sizeof}(\text{c}^{[2][3][4]}[\text{i}][\text{j}][0]) = \text{sizeof}(\text{int})$

$\text{sizeof}(\text{c}^{[2][3][4]}[\text{i}][0]) = 4 * \text{sizeof}(\text{int})$

$\text{sizeof}(\text{c}^{[2][3][4]}[\text{i}]) = 3 * 4 * \text{sizeof}(\text{int})$

$\text{sizeof}(\text{c}^{[2][3][4]}) = 2 * 3 * 4 * \text{sizeof}(\text{int})$

Pointer increments and byte addresses

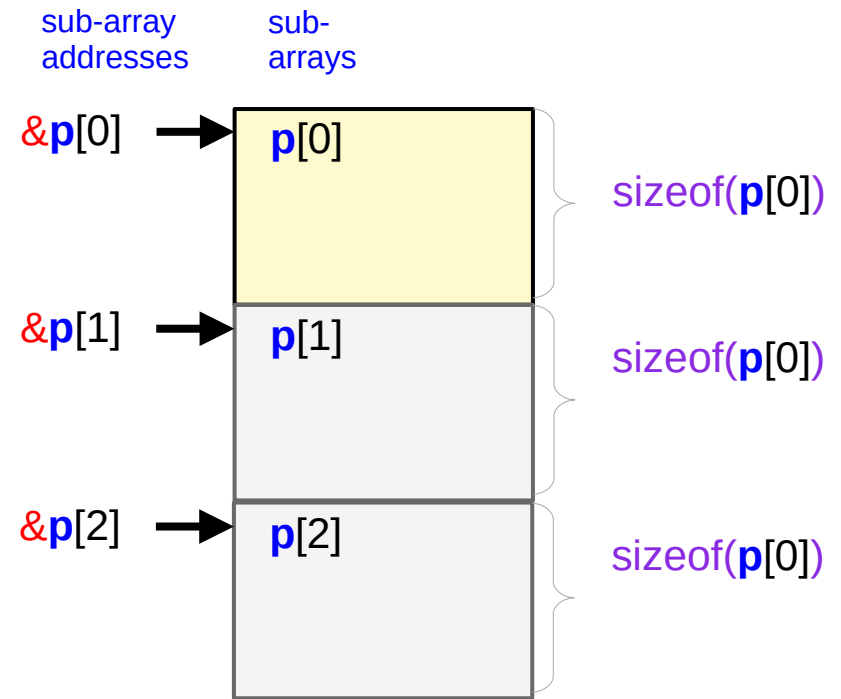
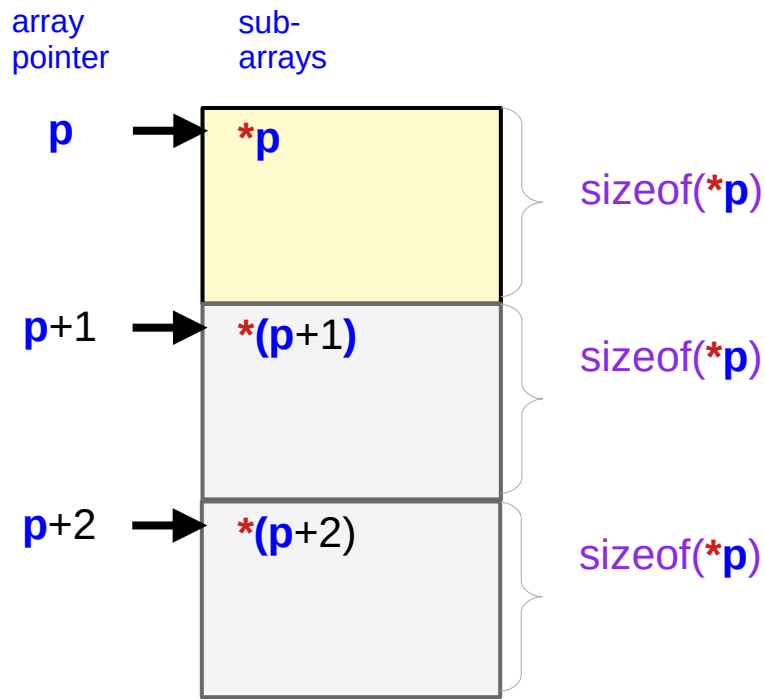

byte address byte address byte size

$$\text{value}(p+i) = \text{value}(p) + i * \text{sizeof}(*p)$$

math expression with an explicit size information

$$(p+i)\text{sizeof}(*p)$$

byte address byte address byte size

$$\text{value}(\&p[i]) = \text{value}(p) + i * \text{sizeof}(p[0])$$

math expression with an explicit size information

$$(\&p[i])\text{sizeof}(*p)$$

Byte addresses of subarrays $\&c[i]$, $\&c[i][j]$, $\&c[i][j][k]$

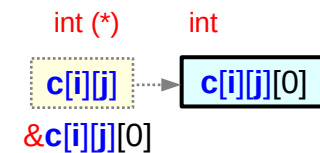
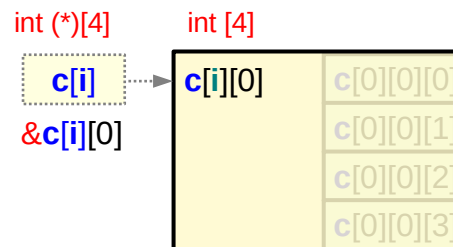
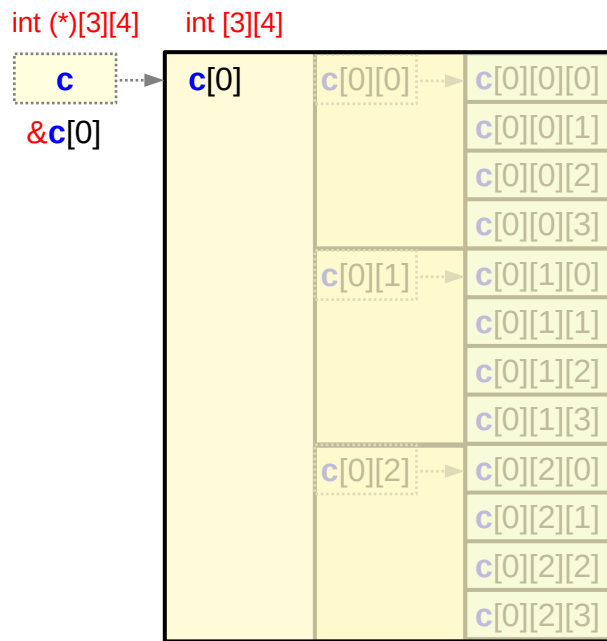

$i = 0:1$
 $j = 0:2$
 $k = 0:3$

$$\begin{aligned} \text{value}(\&c[i]) &= \text{value}(c+i) \\ &= \text{value}(c) + i * \text{sizeof}(*c) \\ &= \text{value}(c) + i * \text{sizeof}(c[0]) \\ &= \text{value}(c) + i * \text{sizeof}(\text{int}) * 3 * 4 \end{aligned}$$

skip i elements of $*c$ from c

$$(c + i)_{3 \cdot 4 \cdot 4}$$

$$\begin{aligned} \text{value}(\&c[i][j]) &= \text{value}(c[i]+j) \\ &= \text{value}(c[i]) + j * \text{sizeof}(*c[i]) \\ &= \text{value}(c[i]) + j * \text{sizeof}(c[i][0]) \\ &= \text{value}(c[i]) + j * \text{sizeof}(\text{int}) * 4 \end{aligned}$$

skip j elements of $*c[i]$ from $c[i]$

$$(c[i] + j)_{4 \cdot 4}$$

$$\begin{aligned} \text{value}(\&c[i][j][k]) &= \text{value}(c[i][j]+k) \\ &= \text{value}(c[i][j]) + k * \text{sizeof}(*c[i][j]) \\ &= \text{value}(c[i][j]) + k * \text{sizeof}(c[i][j][0]) \\ &= \text{value}(c[i][j]) + k * \text{sizeof}(\text{int}) \end{aligned}$$

skip k elements of $*c[i][j]$ from $c[i][j]$

$$(c[i][j] + k)_{1 \cdot 4}$$

Address replications and subarray addresses

Address Replication

transferring pointing address to the pointer that references itself

$$\&X = X$$

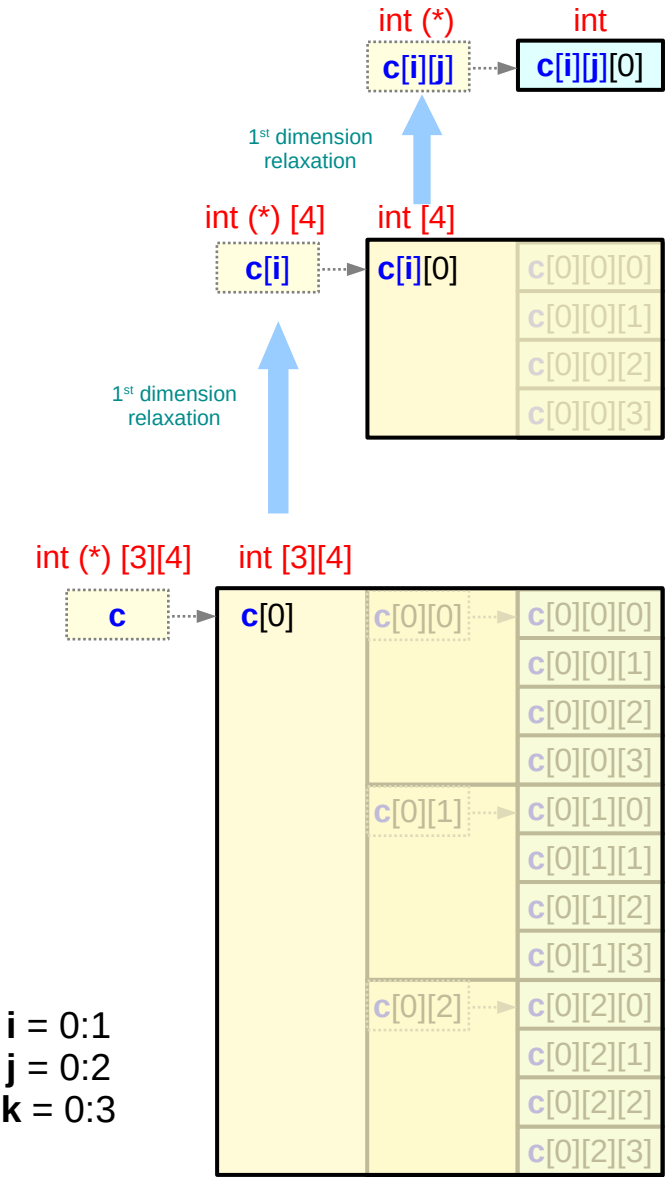
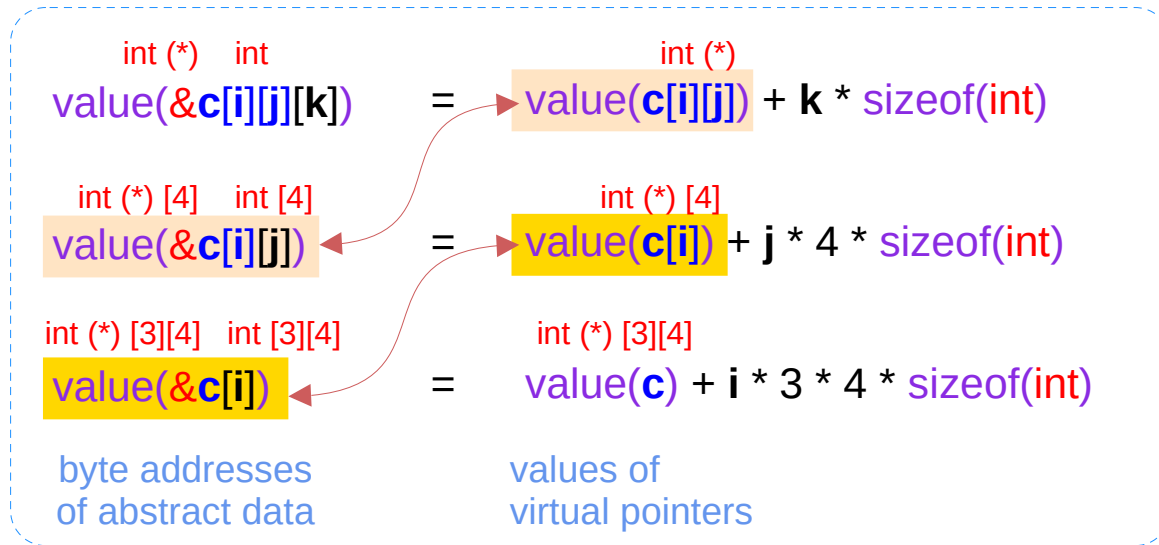

Address replications in a multi-dimensional array

```
int c [2][3][4] ;
```

equivalences

```
c[i][j] ≡ &c[i][j][0]
c[i]   ≡ &c[i][0]
c      ≡ &c[0]
```

address replication

```
value(c[i][j]) = value(&c[i][j])
value(c[i])    = value(&c[i])
value(c)       = value(&c)
```

c, c[0], c[0][0] :
these virtual pointers have
the same address value

a physical location
has a unique address



$c \equiv \&c[0]$

$c[0] \equiv \&c[0][0]$

$c[0][0] \equiv \&c[0][0][0]$

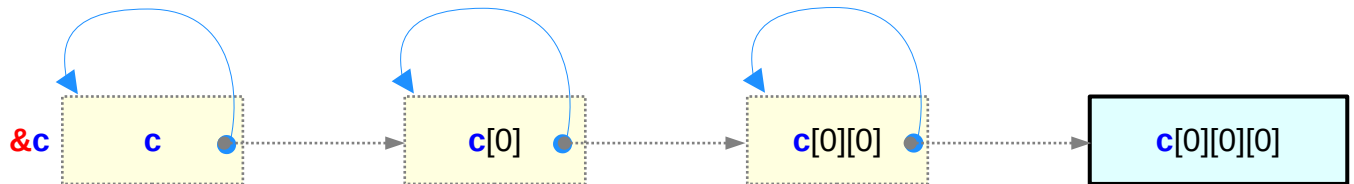
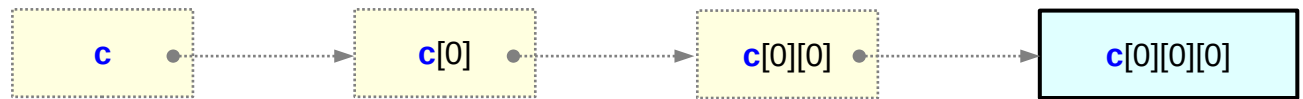

all have the same address value

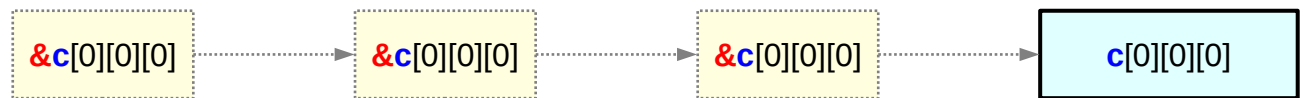

all have the same starting address

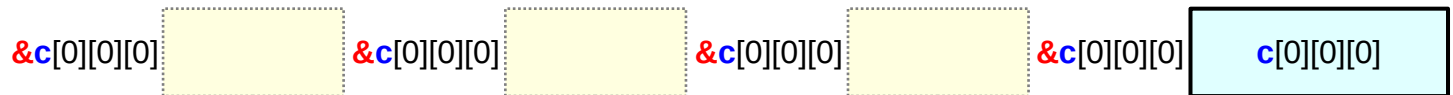

Referencing sub-arrays

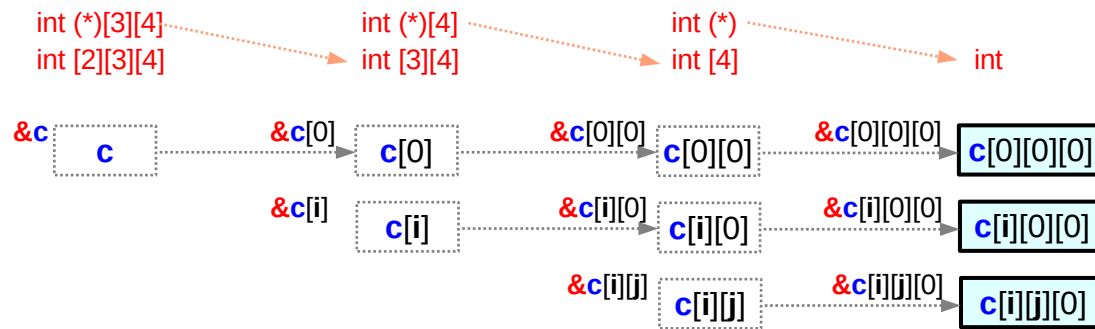

equivalence relations

$c[i][j] \equiv *(c[i]+j)$ $\&c[i][j] \equiv (c[i]+j)$ $\&c[i][0] \equiv c[i]$
 $c[i] \equiv *(c+i)$ $\&c[i] \equiv (c+i)$ $\&c[0] \equiv c$

address replication

$\text{value}(c[i][j]) = \text{value}(\&c[i][j]) = \text{value}(c[i]+j) = *value(c[i]+j)$
 $\text{value}(c[i]) = \text{value}(\&c[i]) = \text{value}(c+i) = *value(c+i)$

$c[i], c[i][0]$ point to the same data $c[i][0][0]$
 $c, c[0], c[0][0]$ point to the same data $c[0][0][0]$

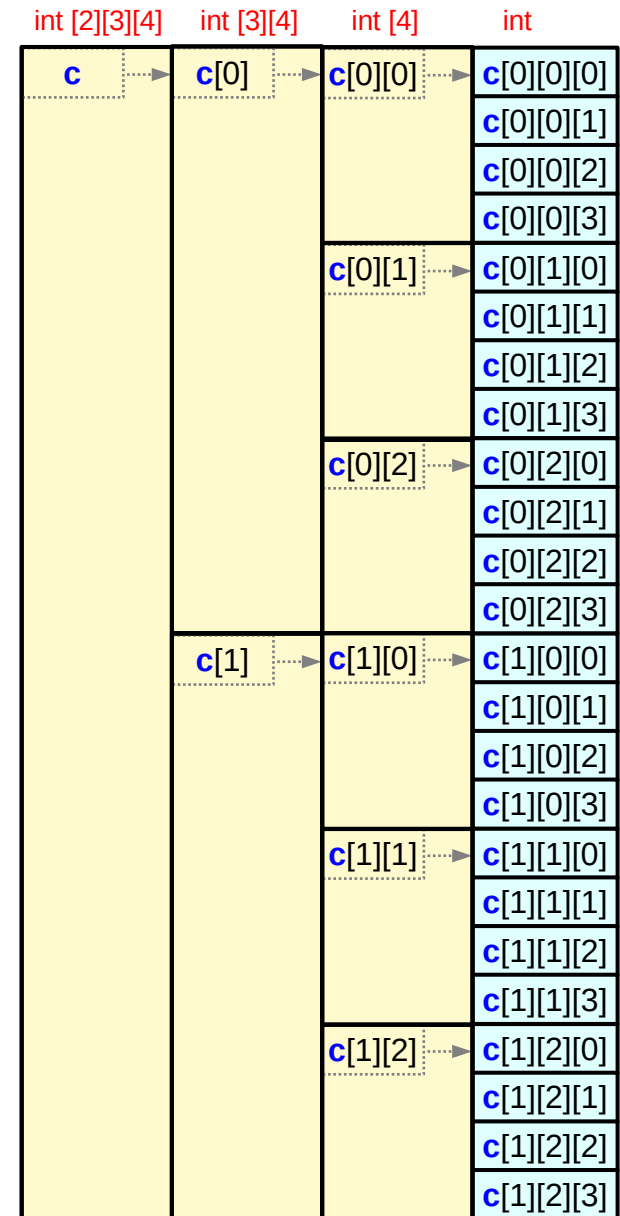

Types, sizes, and values of sub-arrays

```
int c [2][3][4] ;    static allocation
```

```
value(c) = value(c[0]) = value(c[0][0]) = &c[0][0][0]
          value(c[0][1]) = &c[0][1][0]
          value(c[0][2]) = &c[0][2][0]
          value(c[1]) = value(c[1][0]) = &c[1][0][0]
          value(c[1][1]) = &c[1][1][0]
          value(c[1][2]) = &c[1][2][0]
```

```
sizeof(c)    = 2*3*4 * sizeof(int)
sizeof(c[i]) = 3*4 * sizeof(int)
sizeof(c[i][j]) = 4 * sizeof(int)
```

```
type(c)      = int [2][3][4]
              int (*)[3][4]
type(c[i])   = int [3][4]
              int (*)[4]
type(c[i][j]) = int [4]
              int (*)
```

pointers to arrays

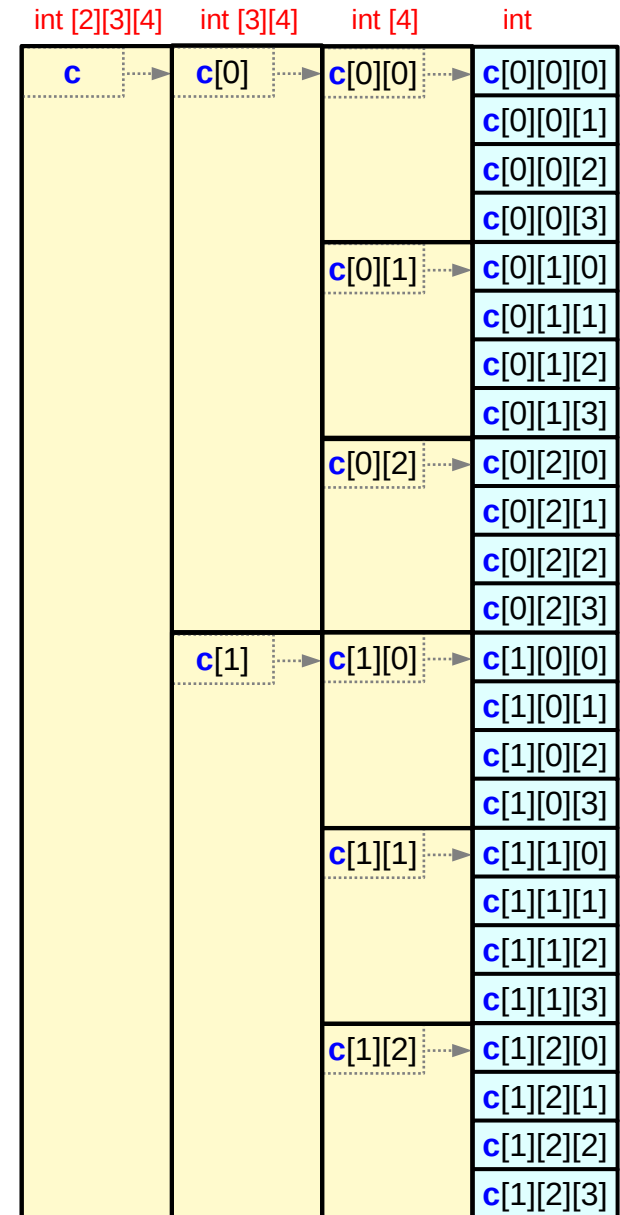

Using multi-dimensional arrays

Pointer Array Approach

– using explicit pointers

Array Pointer Approach

– using implicit pointers

Two types of 3-d array accesses

Pointer Array Approach (arrays of pointers)

Pointer Chain Type I

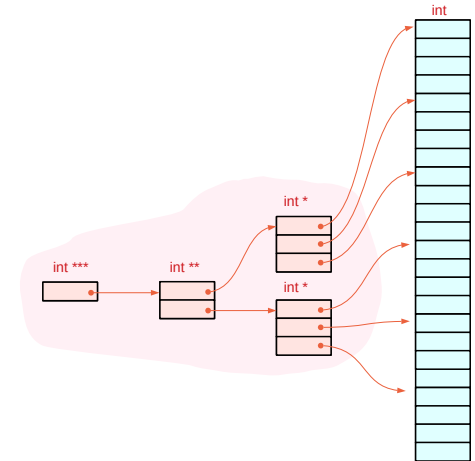
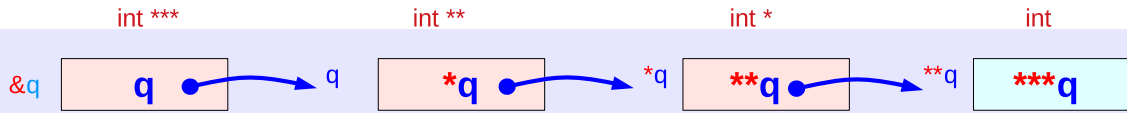

Array Pointer Approach (pointers to arrays)

Pointer Chain Type II

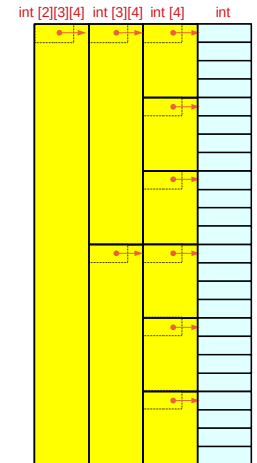
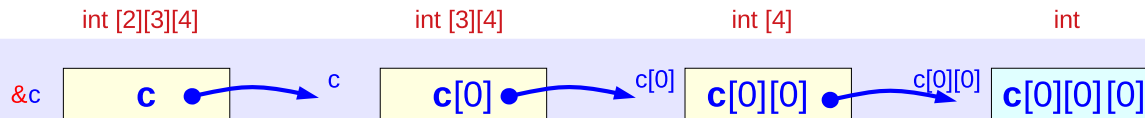

Pointer addition – math and c expressions

Accessing $c[i][j][k]$

– unified c expressions

skip i elements
of $c[i]$ from c

$(c + i)$

skip j elements
of $c[i][j]$ from $c[i]$

$(c[i] + j)$

skip k elements
of $c[i][j][k]$ from $c[i][j]$

$(c[i][j] + k)$

Pointer Array Approach

$(c + i)_{1 \cdot 4}$

$\text{sizeof}(*c) = 1 \cdot 4$

$(c[i] + j)_{1 \cdot 4}$

$\text{sizeof}(*c[i]) = 1 \cdot 4$

$(c[i][j] + k)_{1 \cdot 4}$

$\text{sizeof}(*c[i][j]) = 1 \cdot 4$

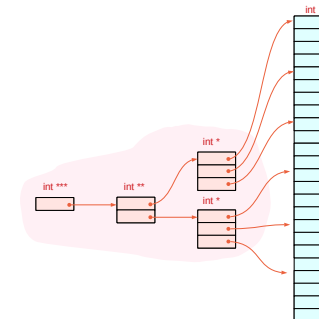

Array Pointer Approach

$(c + i)_{3 \cdot 4 \cdot 4}$

$\text{sizeof}(*c) = 3 \cdot 4 \cdot 4$

$(c[i] + j)_{4 \cdot 4}$

$\text{sizeof}(*c[i]) = 4 \cdot 4$

$(c[i][j] + k)_{1 \cdot 4}$

$\text{sizeof}(*c[i][j]) = 1 \cdot 4$

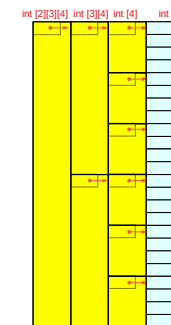

Accessing $c[i][j][k]$ element

Accessing $c[i][j][k]$

skip i elements
of $c[i]$ from c

$$(c + i)$$

skip j elements
of $c[i][j]$ from $c[i]$

$$(c[i] + j)$$

skip k elements
of $c[i][j][k]$ from $c[i][j]$

$$(c[i][j] + k)$$

Pointer Array Approach

skip $i * \text{sizeof}(\text{int}^{**})$
(= $i * 4$) bytes from c

$$(c + i)_{1.4}$$

skip $j * \text{sizeof}(\text{int}^*)$
(= $j * 4$) bytes from $c[i]$

$$(c[i] + j)_{1.4}$$

skip $k * \text{sizeof}(\text{int})$
(= $k * 4$) bytes from $c[i][j]$

$$(c[i][j] + k)_{1.4}$$

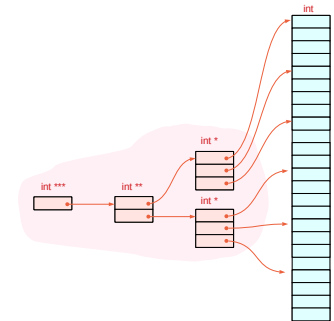

Array Pointer Approach

skip $i * \text{sizeof}(\text{int} [3][4])$
(= $i * 3 * 4 * 4$) bytes from c

$$(c + i)_{3.4.4}$$

skip $j * \text{sizeof}(\text{int} [4])$
(= $j * 4 * 4$) bytes from $c[i]$

$$(c[i] + j)_{4.4}$$

skip $k * \text{sizeof}(\text{int})$
(= $k * 4$) bytes from $c[i][j]$

$$(c[i][j] + k)_{1.4}$$

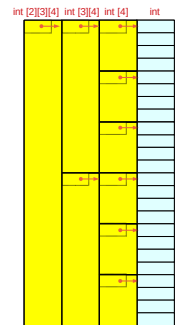

Accessing $c[i][j][k]$ – Pointer Array Approach

Pointer Array Approach

skip $i * \text{sizeof}(\text{int}^{**})$
= $i * 4$ bytes from c

$(c + i)_{1..4} \rightarrow c[i]$

skip $j * \text{sizeof}(\text{int}^*)$
= $j * 4$ bytes from $c[i]$

$(c[i] + j)_{1..4} \rightarrow c[i][j]$

skip $k * \text{sizeof}(\text{int})$
= $k * 4$ bytes from $c[i][j]$

$(c[i][j] + k)_{1..4} \rightarrow c[i][j][k]$

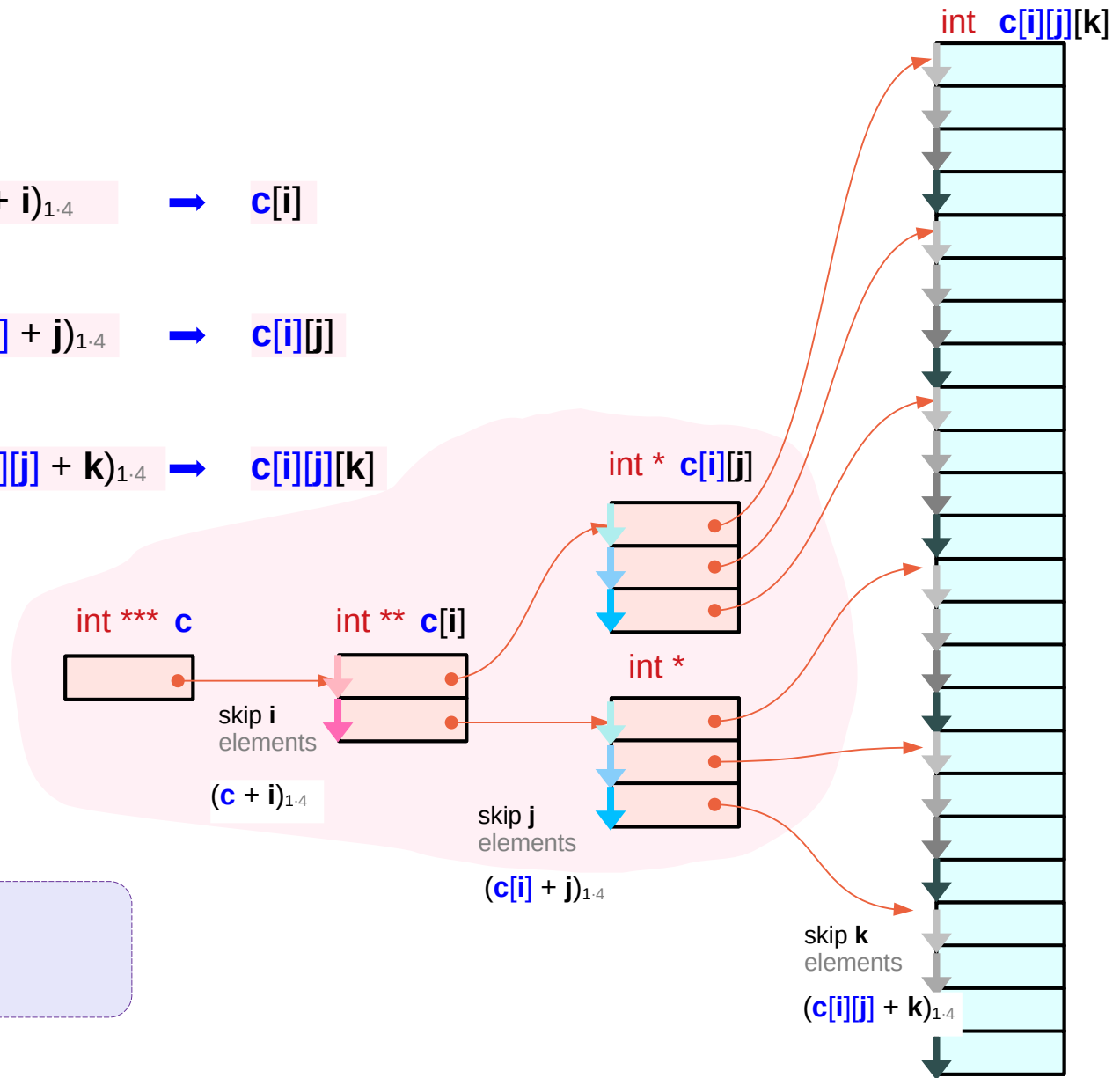

$\text{sizeof}(c[i][j][k]) = \text{sizeof}(\text{int}) = 4$
 $\text{sizeof}(c[i][j]) = \text{sizeof}(\text{int}^*) = 4$
 $\text{sizeof}(c[i]) = \text{sizeof}(\text{int}^{**}) = 4$

Accessing $c[i][j][k]$ – Array Pointer Approach

Array **Pointer** Approach

skip $i * \text{sizeof}(\text{int } [3][4])$
 $= i * 3 * 4 * 4$ bytes from c

$$(c + i)_{3 \cdot 4 \cdot 4} \rightarrow c[i]$$

skip $j * \text{sizeof}(\text{int } [4])$
 $= j * 4 * 4$ bytes from $c[i]$

$$(c[i] + j)_{4 \cdot 4} \rightarrow c[i][j]$$

skip $k * \text{sizeof}(\text{int})$
 $= k * 4$ bytes from $c[i][j]$

$$(c[i][j] + k)_{1 \cdot 4} \rightarrow c[i][j][k]$$

- *subarray partitioning*
- *address replication*

size information

$\text{sizeof}(c[i][j][k]) = \text{sizeof}(\text{int}) = 4$
 $\text{sizeof}(c[i][j]) = \text{sizeof}(\text{int } [4]) = 4 * 4$
 $\text{sizeof}(c[i]) = \text{sizeof}(\text{int } [3][4]) = 3 * 4 * 4$

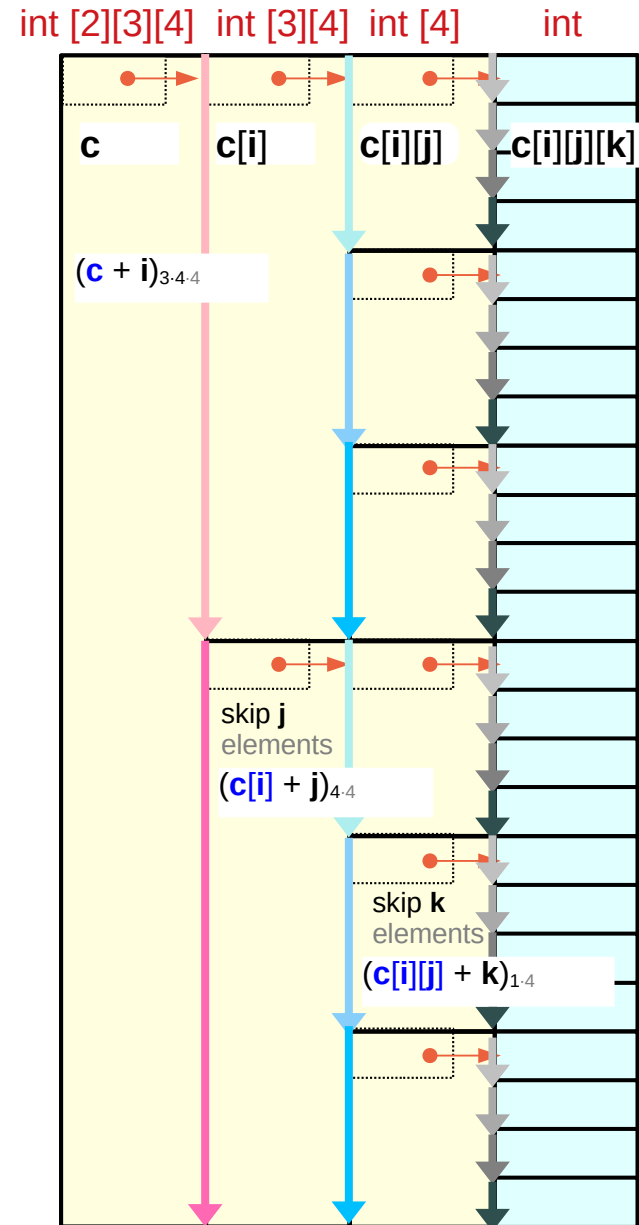

Array element address – Pointer Array Approach

equivalence relations – c expressions

$$\begin{aligned}\&c[i][j][k] &= (c[i][j] + k) \\ \&c[i][j] &= (c[i] + j) \\ \&c[i] &= (c + i)\end{aligned}$$

$$\begin{aligned}c[i][j][k] &= *(c[i][j] + k) \\ c[i][j] &= *(c[i] + j) \\ c[i] &= *(c + i)\end{aligned}$$

size information

$$\begin{aligned}\text{sizeof}(c[i][j][k]) &= \text{sizeof}(\text{int}) = 4 \\ \text{sizeof}(c[i][j]) &= \text{sizeof}(\text{int} *) = 4 \\ \text{sizeof}(c[i]) &= \text{sizeof}(\text{int} **) = 4\end{aligned}$$

address fetch – math expressions

$$\begin{aligned}\text{value}(c[i][j]) &\Rightarrow *value(c[i] + j)_{1.4} = *value(c[i] + j * 4) && \leftarrow \text{sizeof}(*c[i]) \\ \text{value}(c[i]) &\Rightarrow *value(c + i)_{1.4} = *value(c + i * 4) && \leftarrow \text{sizeof}(*c)\end{aligned}$$

address of c[i][j][k] – math expressions

$$\begin{aligned}\&c[i][j][k] &= \text{value}(c[i][j] + k)_{1.4} \\ &= \text{value}(*value(c[i] + j)_{1.4} + k * 4) \\ &= \text{value}(*value(*value(c + i)_{1.4} + j * 4) + k * 4) \\ &= \text{value}(*value(*value(c + i * 4) + j * 4) + k * 4)\end{aligned}$$
$$\begin{aligned}\&c[i][j][k] &\equiv (c[i][j] + k) \\ c[i][j] &\equiv *(c[i] + j) \\ c[i] &\equiv *(c + i)\end{aligned}$$

Array element address – Array Pointer Approach

equivalence relations – c expressions

$$\begin{aligned} &\&c[i][j][k] = (c[i][j] + k) \\ &\&c[i][j] = (c[i] + j) \\ &\&c[i] = (c + i) \end{aligned}$$

$$\begin{aligned} c[i][j][k] &= *(c[i][j] + k) \\ c[i][j] &= *(c[i] + j) \\ c[i] &= *(c + i) \end{aligned}$$

size information

$$\begin{aligned} \text{sizeof}(c[i][j][k]) &= \text{sizeof}(\text{int}) = 4 \\ \text{sizeof}(c[i][j]) &= \text{sizeof}(\text{int}[4]) = 4 * 4 \\ \text{sizeof}(c[i]) &= \text{sizeof}(\text{int}[3][4]) = 3 * 4 * 4 \end{aligned}$$

address replication – math expressions

$$\begin{aligned} \text{value}(c[i][j]) &= \text{value}(\&c[i][j]) &\Rightarrow \text{value}(c[i] + j)_{4 \cdot 4} = \text{value}(c[i]) + j * 4 * 4 &\leftarrow \text{sizeof}(*c[i]) \\ \text{value}(c[i]) &= \text{value}(\&c[i]) &\Rightarrow \text{value}(c + i)_{3 \cdot 4 \cdot 4} = \text{value}(c) + i * 3 * 4 * 4 &\leftarrow \text{sizeof}(*c) \end{aligned}$$

address of c[i][j][k] – math expressions

$$\begin{aligned} \&c[i][j][k] &= \text{value}(c[i][j] + k)_{1 \cdot 4} &\leftarrow \&c[i][j][k] \equiv c[i][j] + k \\ &= \text{value}(c[i] + j)_{4 \cdot 4} + k * 4 &\leftarrow \&c[i][j] \equiv c[i] + j &\leftarrow c[i][j] \text{ address replication} \\ &= \text{value}(c + i)_{3 \cdot 4 \cdot 4} + j * 4 * 4 + k * 4 &\leftarrow \&c[i] \equiv c + i &\leftarrow c[i] \text{ address replication} \\ &= \text{value}(c) + i * 3 * 4 * 4 + j * 4 * 4 + k * 4 \end{aligned}$$

- address replication
- combining size and address information

Accessing $c[i][j][k]$ via byte addresses

Pointer Array Approach

$$\begin{aligned}\&c[i][j][k] &= \text{value}((c[i][j] + k)_{1 \cdot 4}) &= \text{value}(c[i][j] + k * 4) \\ \&c[i][j] &= \text{value}((c[i] + j)_{1 \cdot 4}) &= \text{value}(c[i] + j * 4) \\ \&c[i] &= \text{value}((c + i)_{1 \cdot 4}) &= \text{value}(c + i * 4)\end{aligned}$$

$$\begin{aligned}c[i][j][k] &= *value(c[i][j] + k * 4) \\ &= *value(*value(c[i] + j * 4) + k * 4) \\ &= *value(*value(*value(c + i * 4) + j * 4) + k * 4)\end{aligned}$$

$$\begin{aligned}c[i][j][k] &= *value(c[i][j] + k * 4) \\ c[i][j] &= *value(c[i] + j * 4) \\ c[i] &= *value(c + i * 4)\end{aligned}$$

three memory accesses for $c[i][j][k]$

Array Pointer Approach

$$\begin{aligned}\&c[i][j][k] &= \text{value}((c[i][j] + k)_{1 \cdot 4}) &= \text{value}(c[i][j] + k * 4) \\ \&c[i][j] &= \text{value}((c[i] + j)_{4 \cdot 4}) &= \text{value}(c[i] + j * 4 * 4) \\ \&c[i] &= \text{value}((c + i)_{3 \cdot 4 \cdot 4}) &= \text{value}(c + i * 3 * 4 * 4)\end{aligned}$$

$$\begin{aligned}c[i][j][k] &= *value(c[i][j] + k * 4) \\ &= *value(*value(c[i] + j * 4 * 4) + k * 4) \\ &= *value(*value(*value(c + i * 3 * 4 * 4) + j * 4 * 4) + k * 4) \\ &= *value(value(value(c + i * 3 * 4 * 4) + j * 4 * 4) + k * 4) \\ &= *value(c + i * 3 * 4 * 4 + j * 4 * 4 + k * 4)\end{aligned}$$

$$\begin{aligned}c[i][j][k] &= *value(c[i][j] + k * 4) \\ c[i][j] &= *value(c[i] + j * 4 * 4) \\ c[i] &= *value(c + i * 3 * 4 * 4)\end{aligned}$$

address replication

single memory access for $c[i][j][k]$

Equivalence relations in $c[i][j][k]$

Pointer Array Approach

$$\begin{aligned} \&c[i][j][k] &= \text{value}(c[i][j] + k * 4) &= \text{value}(c[i][j]) + k * 4 \\ \&c[i][j] &= \text{value}(c[i] + j * 4) &= \text{value}(c[i]) + j * 4 \\ \&c[i] &= \text{value}(c + i * 4) &= \text{value}(c) + i * 4 \end{aligned}$$

different semantics !
be careful in mixed c and math expressions

$$\begin{aligned} c[i][j][k] &\neq *value(c[i][j]) + k * 4 \\ c[i][j] &\neq *value(c[i]) + j * 4 \\ c[i] &\neq *value(c) + i * 4 \end{aligned}$$

$$\begin{aligned} c[i][j][k] &= *value(c[i][j] + k * 4) \\ c[i][j] &= *value(c[i] + j * 4) \\ c[i] &= *value(c + i * 4) \end{aligned}$$

Array Pointer Approach

$$\begin{aligned} \&c[i][j][k] &= \text{value}(c[i][j] + k)_{1 \cdot 4} &= \text{value}(c[i][j]) + k * 4 \\ \&c[i][j] &= \text{value}(c[i] + j)_{4 \cdot 4} &= \text{value}(c[i]) + j * 4 * 4 \\ \&c[i] &= \text{value}(c + i)_{3 \cdot 4 \cdot 4} &= \text{value}(c) + i * 3 * 4 * 4 \end{aligned}$$

different semantics !
be careful in mixed c and math expressions

$$\begin{aligned} c[i][j][k] &\neq *value(c[i][j]) + k * 4 \\ c[i][j] &\neq *value(c[i]) + j * 4 * 4 \\ c[i] &\neq *value(c) + i * 3 * 4 * 4 \end{aligned}$$

$$\begin{aligned} c[i][j][k] &= *value(c[i][j] + k * 4) \\ c[i][j] &= *value(c[i] + j * 4 * 4) \\ c[i] &= *value(c + i * 3 * 4 * 4) \end{aligned}$$

Accessing $c[i][j][k]$

```
int c[L][M][N];
```

```
c[i]      ≡ *(c + i)  
c[i][j]   ≡ *(c[i] + j)  
c[i][j][k] ≡ *(c[i][j] + k)
```

```
&c[i]     ≡ (c + i)  
&c[i][j]  ≡ (c[i] + j)  
&c[i][j][k] ≡ (c[i][j] + k)
```

equivalence relations

multiple indirections

address replications

| | | | | | | |
|--------------|----------|----------------|----------|--------------------|---------------|------------------|
| $c[i]$ | \equiv | $*(c+i)$ | \equiv | $*(c+i)$ | \equiv | $(c+i)$ |
| $c[i][j]$ | \equiv | $*(c[i]+j)$ | \equiv | $*(*(c+i)+j)$ | \equiv | $((c+i)+j)$ |
| $c[i][j][k]$ | \equiv | $*(c[i][j]+k)$ | \equiv | $*(*(*(c+i)+j)+k)$ | \equiv | $((((c+i)+j)+k)$ |
| | | | | | \rightarrow | $*(c+i+j+k)$ |

Pointer Array Approach

Array Pointer Approach

Conditions for $c[i][j][k]$

Equivalence relations in $c[i][j][k]$

$$\begin{aligned}c[i][j][k] &\equiv *(c[i][j] + k) \\ *(c[i][j] + k) &\equiv *(*c[i] + j) + k \\ *(*c[i] + j) + k &\equiv *(*(*c + i) + j) + k\end{aligned}$$

$$\begin{aligned}c[i][j][k] &\equiv (c[i][j] + k) \\ c[i][j] &\equiv (c[i] + j) \\ c[i] &\equiv (c + i)\end{aligned}$$

Pointer Array Approach

$$\begin{aligned}c[i][j][k] &\equiv (c[i][j] + k) \\ c[i][j] &\equiv (c[i] + j) \\ c[i] &\equiv (c + i)\end{aligned}$$



contiguous 4 $c[i][j][k]$'s $4 * (\text{int } 4 \text{ bytes})$
contiguous 3 $c[i][j]$'s $3 * (\text{int } * 4 \text{ or } 8 \text{ bytes})$
contiguous 2 $c[i]$'s $2 * (\text{int } ** 4 \text{ or } 8 \text{ bytes})$

Array Pointer Approach

$$\begin{aligned}c[i][j][k] &\equiv (c[i][j] + k) \\ c[i][j] &\equiv (c[i] + j) \\ c[i] &\equiv (c + i)\end{aligned}$$



contiguous 4 $c[i][j][k]$'s $4 * (\text{int } 4 \text{ bytes})$
contiguous 3 $c[i][j]$'s $3 * (\text{int } [4] 4*4 \text{ bytes})$
contiguous 2 $c[i]$'s $2 * (\text{int } [3][4] 3*4*4 \text{ bytes})$

Skipping leaf elements

Continuity Constraints

$$\begin{aligned}c[i][j][k] &\equiv (c[i][j] + k) \\ c[i][j] &\equiv (c[i] + j) \\ c[i] &\equiv (c + i)\end{aligned}$$



contiguous $c[i][j][k]$ over $k=0:3$
contiguous $c[i][j]$ over $j=0:2$
contiguous $c[i]$ over $i=0:1$

Pointer Array Approach

$(c[i][j] + k)_{1..4}$ skip $k * 4$ bytes from $c[i][j]$
 $(c[i] + j)_{1..4}$ skip $j * 4$ bytes from $c[i]$
 $(c + i)_{1..4}$ skip $i * 4$ bytes from c

k leaf elements $k * 4$ bytes
 $j * 4$ leaf elements $j * 4 * 4$ bytes
 $i * 3 * 4$ leaf elements $i * 3 * 4 * 4$ bytes

Array Pointer Approach

$(c[i][j] + k)_{1..4}$ skip $k * 4$ bytes from $c[i][j]$
 $(c[i] + j)_{4..4}$ skip $j * 4 * 4$ bytes from $c[i]$
 $(c + i)_{3..4}$ skip $i * 3 * 4 * 4$ bytes from c

k leaf elements $k * 4$ bytes
 $j * 4$ leaf elements $j * 4 * 4$ bytes
 $i * 3 * 4$ leaf elements $i * 3 * 4 * 4$ bytes

3-d Access `c[i][j][k]`

Accessing $c[i][j][k]$ – Conditions

General requirements

```
 $c[i][j][k] = *(c[i][j]+k)$   
 $c[i][j] = *(c[i]+j)$   
 $c[i] = *(c+i)$ 
```

```
 $\&c[i][j][k] = c[i][j]+k$   
 $\&c[i][j] = c[i]+j$   
 $\&c[i] = c+i$ 
```

```
 $\&c[i][j][0] = c[i][j]$   
 $\&c[i][0] = c[i]$   
 $\&c[0] = c$ 
```

Pointer array approach

```
 $int^{**} c[2];$   
 $int^* b[2*3];$   
 $int c[2*3*4];$ 
```

```
 $c[i][j][k] :: int$   
 $c[i][j] :: int^*$   
 $c[i] :: int^{**}$ 
```

```
 $c[i] \leftarrow \&b[i*3]$   
 $b[j] \leftarrow \&a[j*4]$ 
```

Hierarchical Pointer Arrays

Array pointer approach

```
 $int c[2][3][4];$ 
```

```
 $c[i][j][k] :: int$   
 $c[i][j] :: int [4]$   
 $c[i] :: int [3][4]$ 
```

```
 $c \leftarrow \&c[0][0][0]$   
 $c[i] \leftarrow \&c[i][0][0]$   
 $c[i][j] \leftarrow \&c[i][j][0]$ 
```

Virtual Array Pointers

Accessing $c[i][j][k]$ – Pointer Array Approach (1)

$c[i] \leftarrow \&b[i*3]$
 $b[j] \leftarrow \&a[j*4]$

$[2][3][4]$



$c[i] \equiv *(c + i)$
 $c[i][j] \equiv *(c[i] + j)$
 $c[i][j][k] \equiv *(c[i][j] + k)$

$\&c[i] \equiv (c + i)$
 $\&c[i][j] \equiv (c[i] + j)$
 $\&c[i][j][k] \equiv (c[i][j] + k)$

$b[j] \equiv (a + j*4)$

$*(b[j]+k) = *(a+j*4+k);$

$b[j][k] \equiv a[j*4+k]$

$c[i] \equiv (b + i*3)$

$*(c[i]+j) = *(b+i*3+j);$

$c[i][j] \equiv b[i*3+j]$

$*(c[i][j]+k) = *(b[i*3+j]+k);$



$c[i][j] \equiv (a + (i*3+j)*4)$

$*(c[i][j]+k) = *(a+(i*3+j)*4+k);$

$c[i][j][k] \equiv a[(i*3+j)*4+k]$

```

int** c[2];
int* b[2*3];
int a[2*3*4];
    
```

Accessing $c[i][j][k]$ – Pointer Array Approach (2)

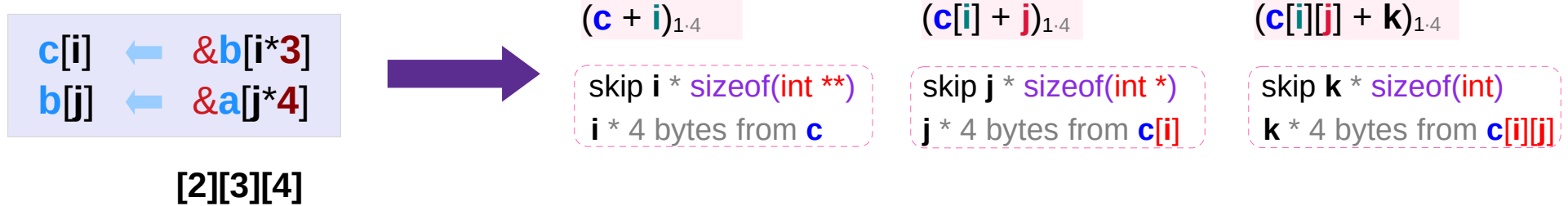

$b[j] \equiv (a + j*4)$

skip j elements of b skip $j*4$ elements of a

$c[i] \equiv (b + i*3)$

skip i elements of c skip $i*3$ elements of b

$b[j][k] \equiv a[j*4+k]$

skip j elements of $b +$
 skip k elements of a

$c[i][j] \equiv b[i*3+j]$

skip i elements of $c +$
 skip j elements of b

$c[i][j] \equiv (a + (i*3+j)*4)$

skip $i*3*4$ elements of $a +$
 skip $j*4$ elements of $a +$

```

int** c[2];
int* b[2*3];
int a[2*3*4];
    
```

$c[i][j][k] \equiv a[(i*3+j)*4+k]$

skip $i*3*4$ elements of $a +$
 skip $j*4$ elements of $a +$
 skip k elements of a

Accessing $c[i][j][k]$ – Array Pointer Approach (1)

| | | |
|-----------|---|----------------|
| c | ← | $\&c[0][0][0]$ |
| $c[i]$ | ← | $\&c[i][0][0]$ |
| $c[i][j]$ | ← | $\&c[i][j][0]$ |



| | | |
|--------------|----------|------------------|
| $c[i]$ | \equiv | $*(c + i)$ |
| $c[i][j]$ | \equiv | $*(c[i] + j)$ |
| $c[i][j][k]$ | \equiv | $*(c[i][j] + k)$ |

| | | |
|----------------|----------|-----------------|
| $\&c[i]$ | \equiv | $(c + i)$ |
| $\&c[i][j]$ | \equiv | $(c[i] + j)$ |
| $\&c[i][j][k]$ | \equiv | $(c[i][j] + k)$ |

[2][3][4]

| | | |
|---------------------|-----|----------------|
| $value(c)$ | $=$ | $\&c[0][0][0]$ |
| $value(c[i])$ | $=$ | $\&c[i][0][0]$ |
| $value(c[i][j])$ | $=$ | $\&c[i][j][0]$ |
| $value(c[i][j][k])$ | $=$ | $\&c[i][j][k]$ |



| | | |
|----------------------|-----|---------------------|
| $sizeof(c)$ | $=$ | $2*3*4*sizeof(int)$ |
| $sizeof(c[i])$ | $=$ | $3*4*sizeof(int)$ |
| $sizeof(c[i][j])$ | $=$ | $4*sizeof(int)$ |
| $sizeof(c[i][j][k])$ | $=$ | $sizeof(int)$ |



| | | |
|---------------------|-----|--------------------------------------|
| $value(c[i])$ | $=$ | $\&c[0][0][0] + i * 3*4*sizeof(int)$ |
| $value(c[i][j])$ | $=$ | $\&c[i][0][0] + j * 4*sizeof(int)$ |
| $value(c[i][j][k])$ | $=$ | $\&c[i][j][0] + k * sizeof(int)$ |



| | | |
|----------------|-----|---|
| $\&c[i]$ | $=$ | $value(c) + i * sizeof(*c)$ |
| $\&c[i][j]$ | $=$ | $value(c[i]) + j * sizeof(*c[i])$ |
| $\&c[i][j][k]$ | $=$ | $value(c[i][j]) + k * sizeof(*c[i][j])$ |



| | | |
|--------------|----------|------------------|
| $c[i]$ | \equiv | $*(c + i)$ |
| $c[i][j]$ | \equiv | $*(c[i] + j)$ |
| $c[i][j][k]$ | \equiv | $*(c[i][j] + k)$ |

Accessing $c[i][j][k]$ – Array Pointer Approach (2)

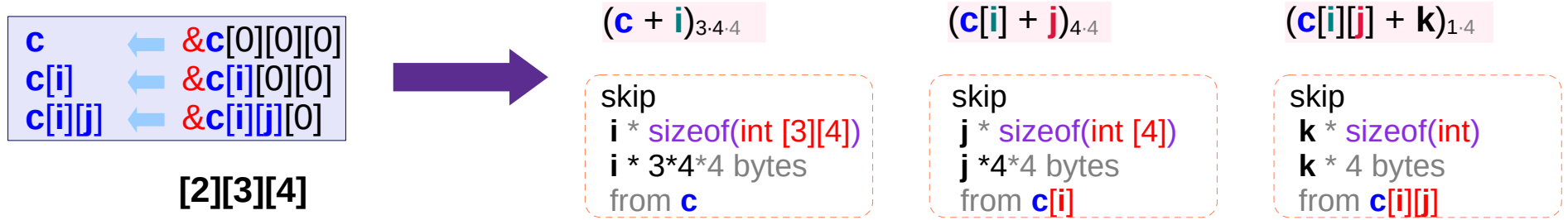

$$\text{value}(c[i]) = \&c[i][0][0]$$

$$\text{value}(c[i][j]) = \&c[i][j][0]$$

$$\text{value}(c[i][j][k]) = \&c[i][j][k]$$

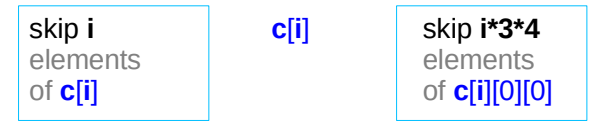
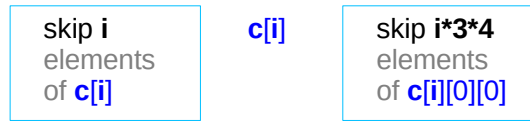
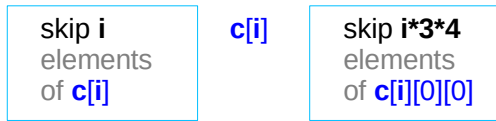

+

+

+

+

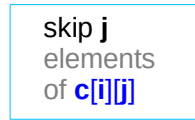

$c[i][j]$

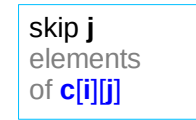
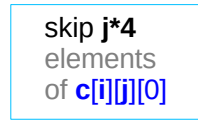

$c[i][j]$

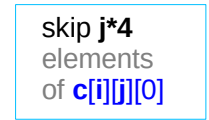

+

+



$c[i][j][k]$

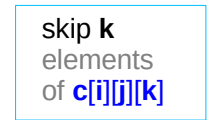

Pointer Chain Types

Pointer Chain Types

Pointer Chain Type I

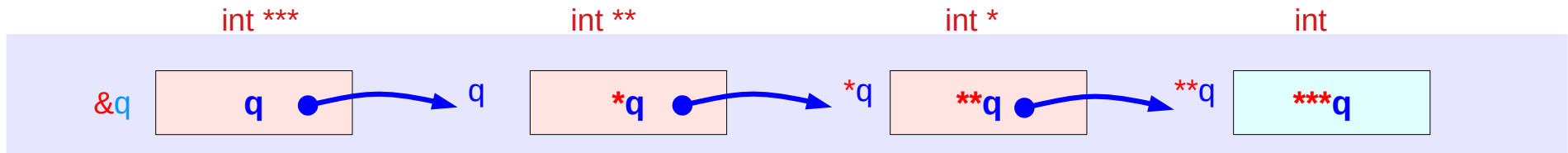

- **Pointer Array Approach** (index operations are handled by a user)

Pointer Chain Type II

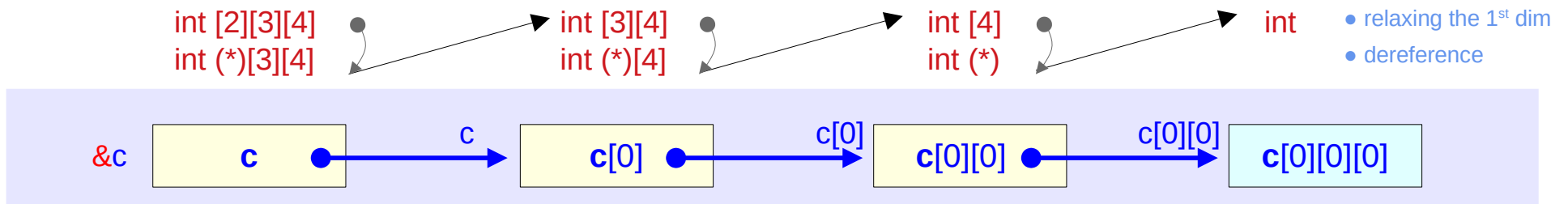

- **Array Pointer Approach** (index operations are handled by a compiler)

Examples of two step dereferencing in type II

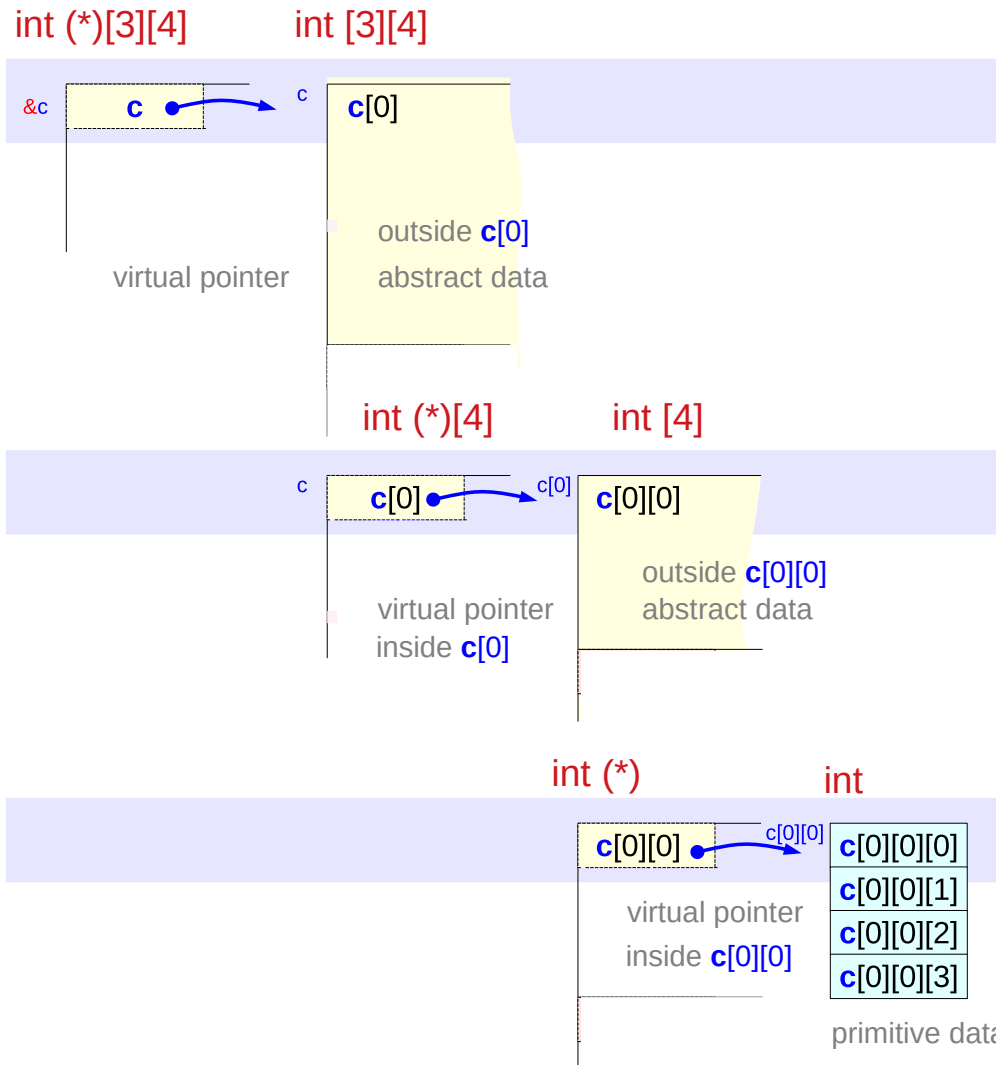

int [3][4]
c[0]
abstract data

relaxing
the 1st dim

sizeof(c[0]) =
3 * sizeof(c[0][0])

within an array c[0]
of int[3][4] type, c[0]
can be relaxed to
a pointer of
int (*)[4] type

c[0][0] = *(c[0]+0)_{4,4}
Math Expression

int (*)[4]
c[0]
virtual pointer

int [4]
c[0][0]
abstract data
relaxing
the 1st dim

sizeof(c[0][0]) =
4 * sizeof(c[0][0][0])

within an array c[0][0]
of int [4] type, c[0][0]
can be relaxed to
a pointer of
int (*) type

c[0][0][0] = *(c[0][0]+0)_{1,4}
Math Expression

int (*)
c[0][0]
virtual pointer

int
c[0][0][0]
abstract data

Pointer Chains in Type II (1)

Pointer Chain Type II

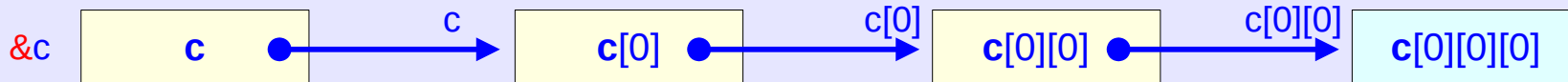
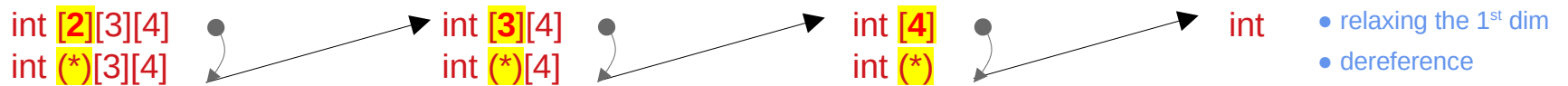

c points to **2** elements
 $\text{sizeof}(c) = 2 * \text{sizeof}(c[i])$

$c[i]$ $i=0,1$
 $*(c+i)_{3,4,4}$

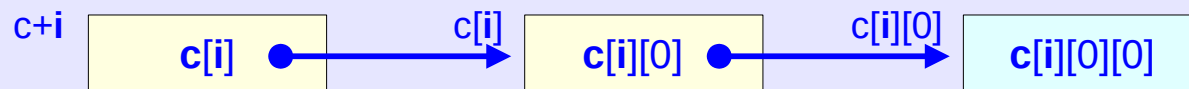

$c[i]$ points to **3** elements
 $\text{sizeof}(c[i]) = 3 * \text{sizeof}(c[i][j])$

$c[i][j]$ $j=0,1,2$
 $*(c[i]+j)_{4,4}$

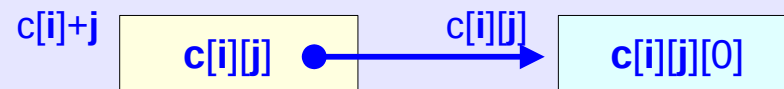

$c[i][j]$ points to **4** elements
 $\text{sizeof}(c[i][j]) = 4 * \text{sizeof}(c[i][j][k])$

$c[i][j][k]$ $k=0,1,2,3$
 $*(c[i][j]+k)_{1,4}$

Pointer Chains in Type II (2)

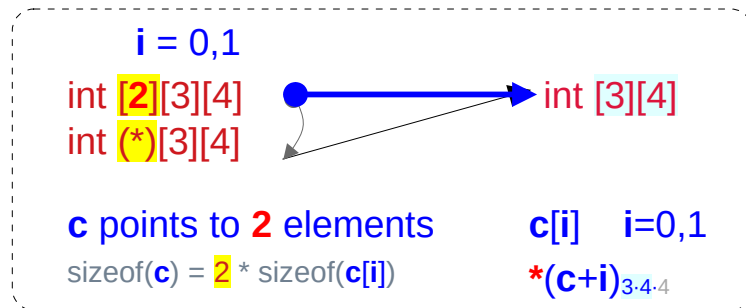

- relaxing the 1st dim
- dereference

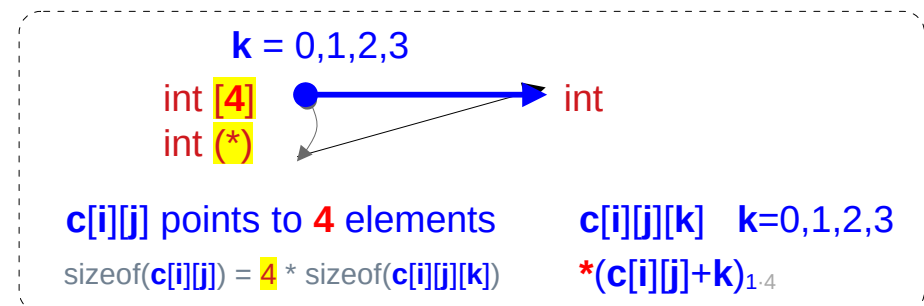
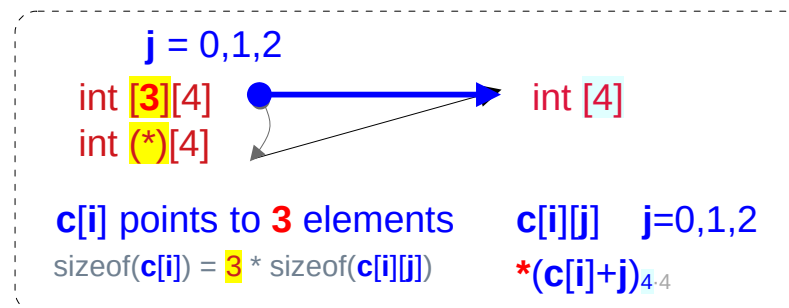

Pointer Chain Type I – * and & operators

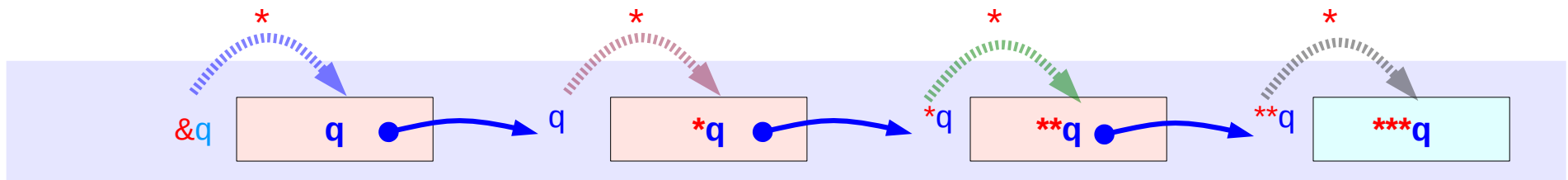

$$*(\&q) \equiv q$$

C expression $*(\&q)$ equals to the variable q

$$*(q) \equiv *q$$

C expression $*(q)$ equals to the variable q

$$*(*q) \equiv **q$$

C expression $*(*q)$ equals to the variable $**q$

$$**(**q) \equiv ***q$$

C expression $**(**q)$ equals to the variable $***q$

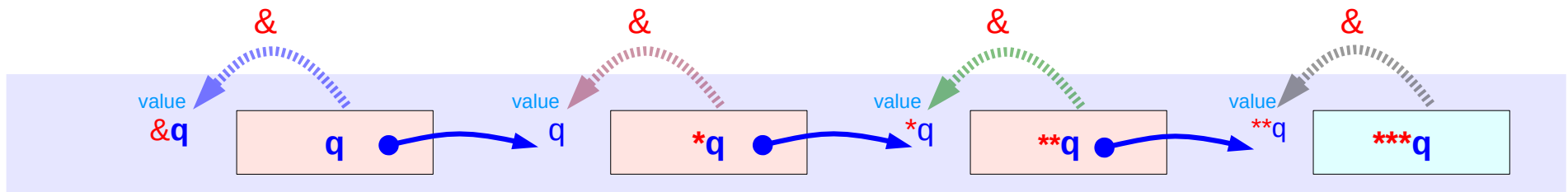

$$\&q \equiv \text{value}(\&q)$$

C expression $\&q$ equals to $\text{value}(\&q)$ which is the address value of a variable q

$$\&(*q) \equiv \text{value}(q)$$

C expression $\&(*q)$ equals to $\text{value}(q)$ which is the address value of a variable $*q$

$$\&(**q) \equiv \text{value}(*q)$$

C expression $\&(**q)$ equals to $\text{value}(*q)$ which is the address value of a variable $**q$

$$\&(** *q) \equiv \text{value}(**q)$$

C expression $\&(** *q)$ equals to $\text{value}(**q)$ which is the address value of a variable $***q$

Pointer Chain Type II – * and & operators

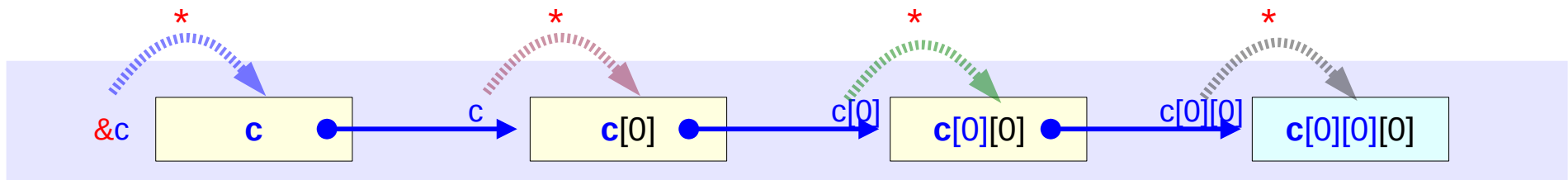

$$*(\&c) \equiv c$$

$$*(c) \equiv c[0]$$

$$*(c[0]) \equiv c[0][0]$$

$$*(c[0][0]) \equiv c[0][0][0]$$

(int (*)[3][4]) **c** can be viewed as a pointer to (int [3][4]) **c[0]**

(int (*)[4]) **c[0]** can be viewed as a pointer to (int [4]) **c[0][0]**

(int (*) **c[0][0]** can be viewed as a pointer to (int) **c[0][0][0]**

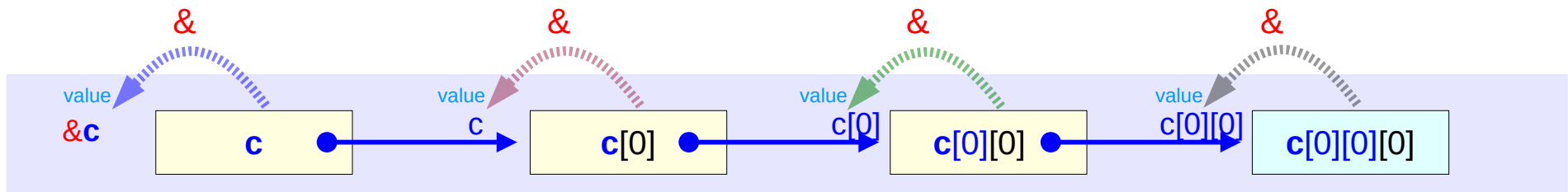

$$\&c \equiv \text{value}(\&c)$$

$$\&(c[0]) \equiv \text{value}(c)$$

$$\&(c[0][0]) \equiv \text{value}(c[0])$$

$$\&(c[0][0][0]) \equiv \text{value}(c[0][0])$$

(int (*)[3][4]) **c** has the address value of (int [3][4]) **c[0]**

(int (*)[4]) **c[0]** has the address value of (int [4]) **c[0][0]**

(int (*) **c[0][0]** has the address value of (int) **c[0][0][0]**

Pointer Chain Type I – skipping elements

Pointer Chain Type I

multiple indirection

size: pointer size

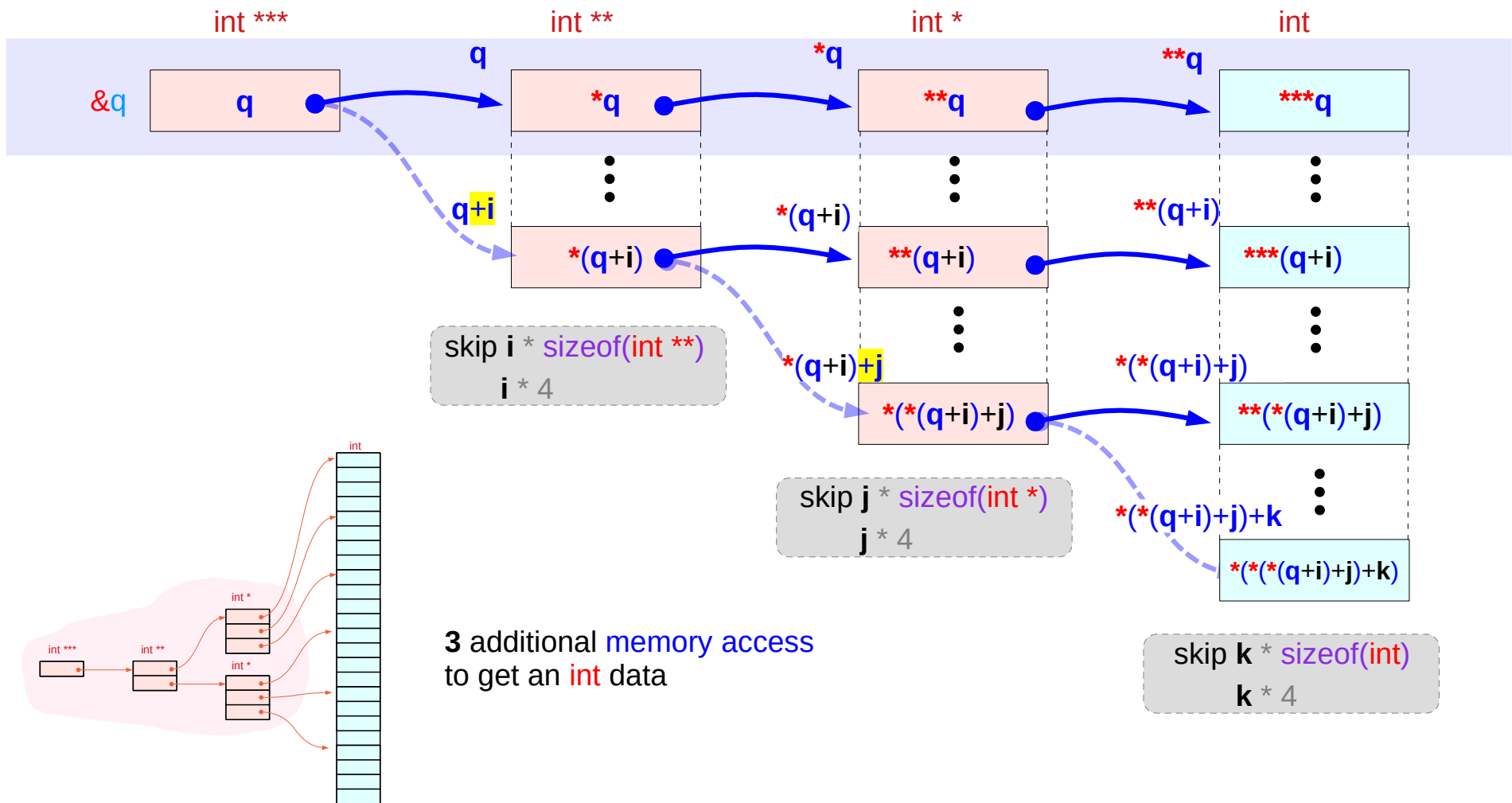

Pointer Chain Type II – skipping elements

Pointer Chain Type II

virtual pointer to an abstract data

size: abstract data size

int [2][3][4]
int (*)[3][4]

int [3][4]
int (*)[4]

int [4]
int (*)

int

- relaxing the 1st dim
- dereference

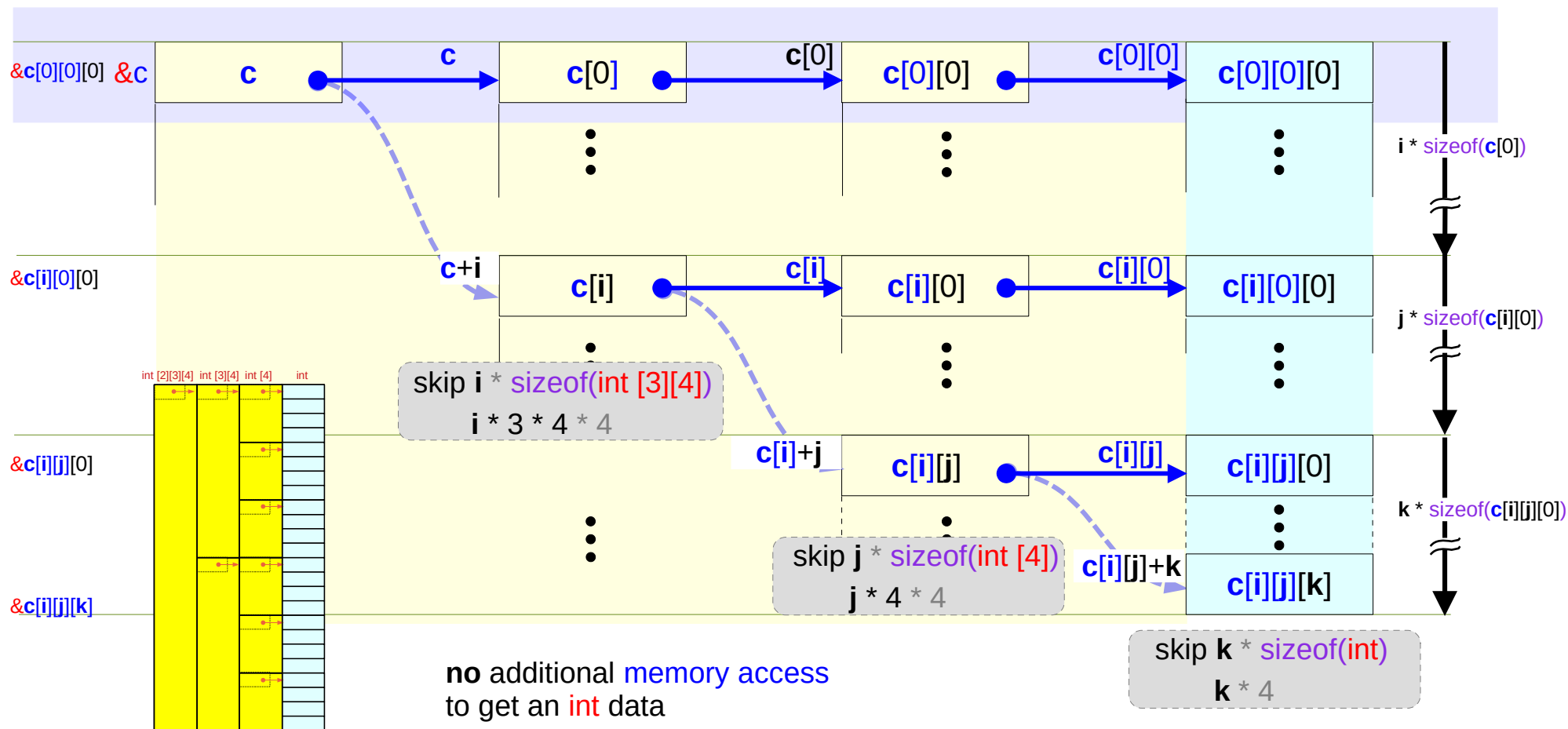

Two step dereferencing in type II (1) – without skipping

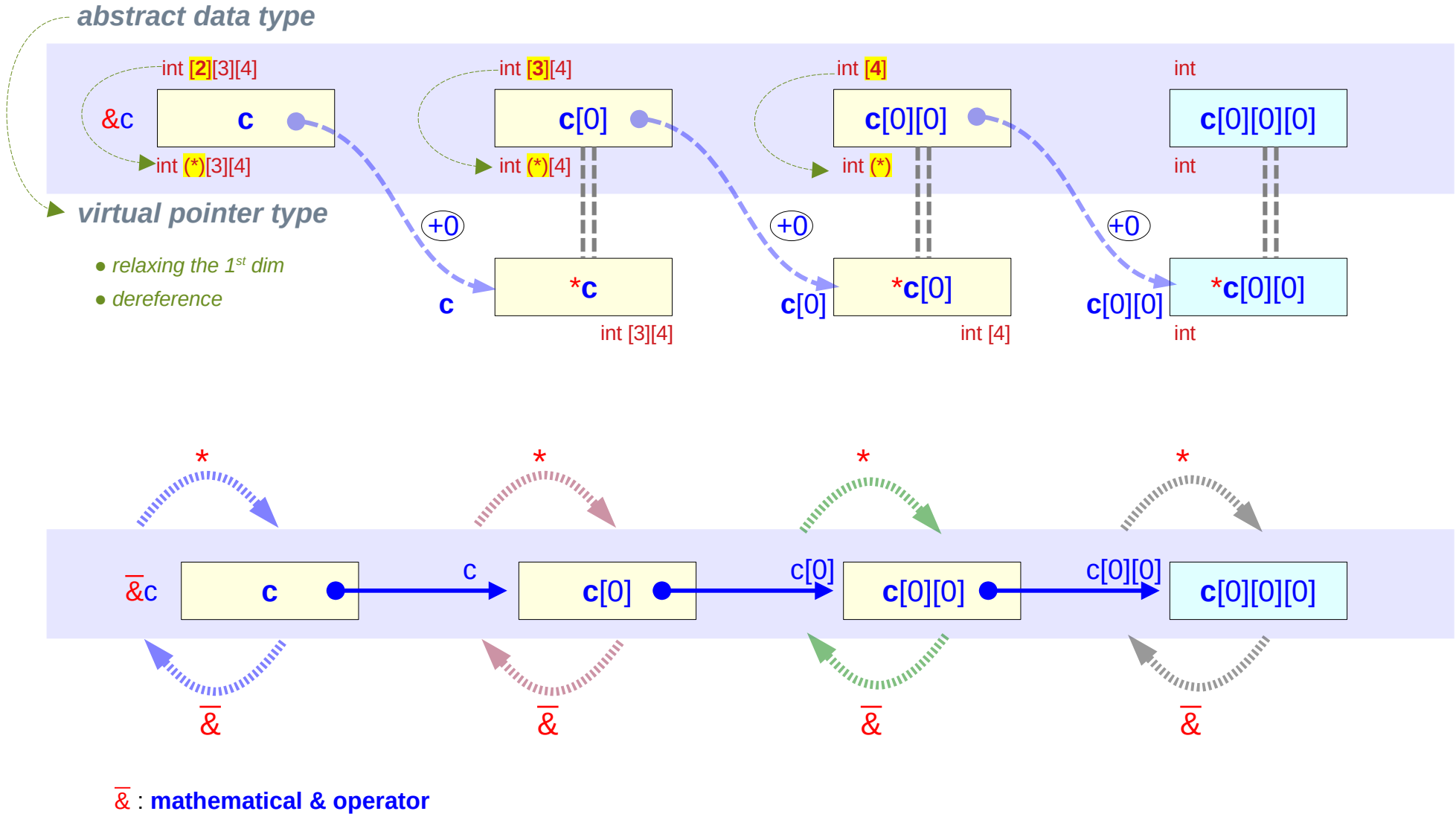

Two step dereferencing in type II (2) – with skipping

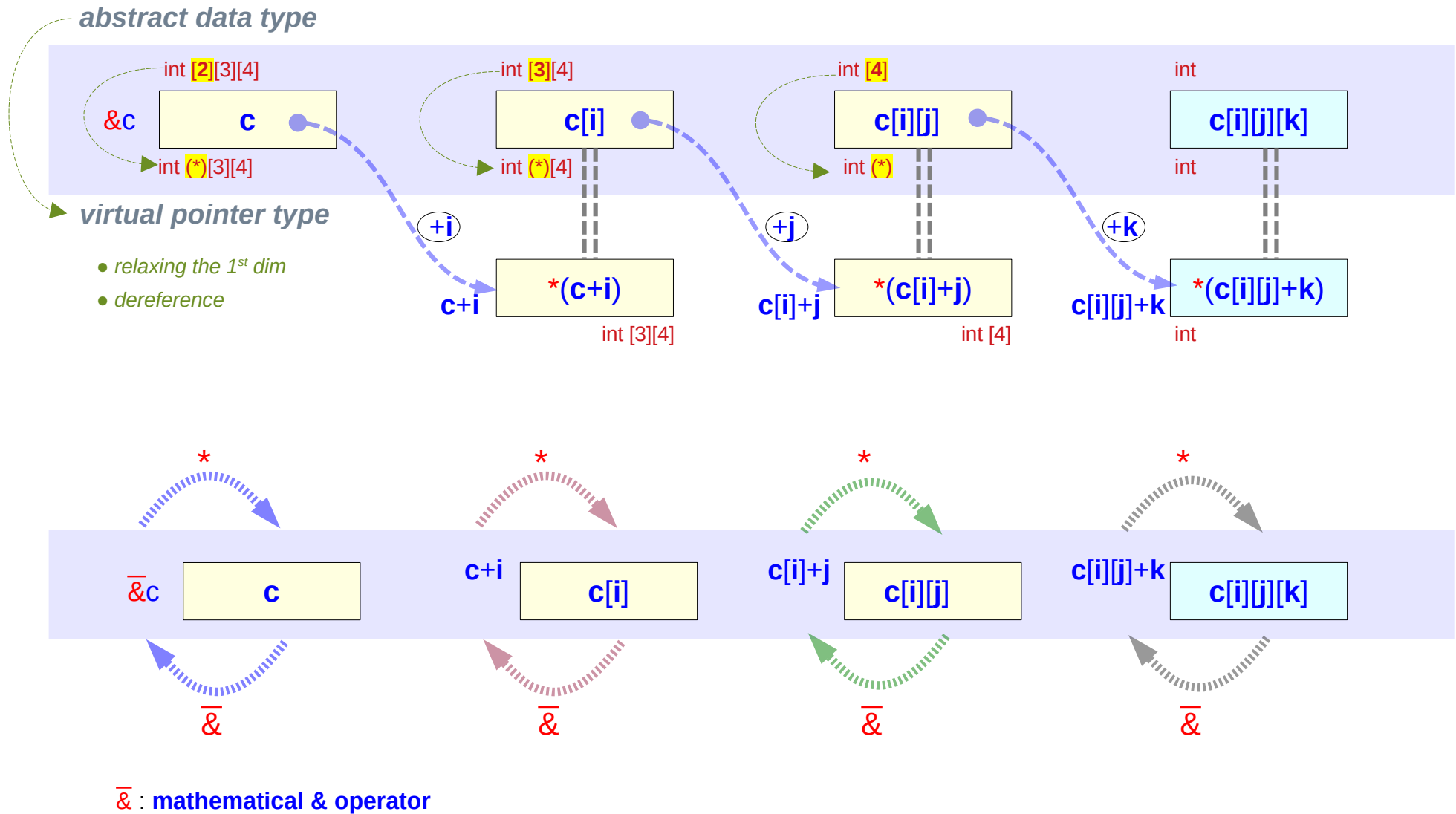

Two step deferencing in type II (3)

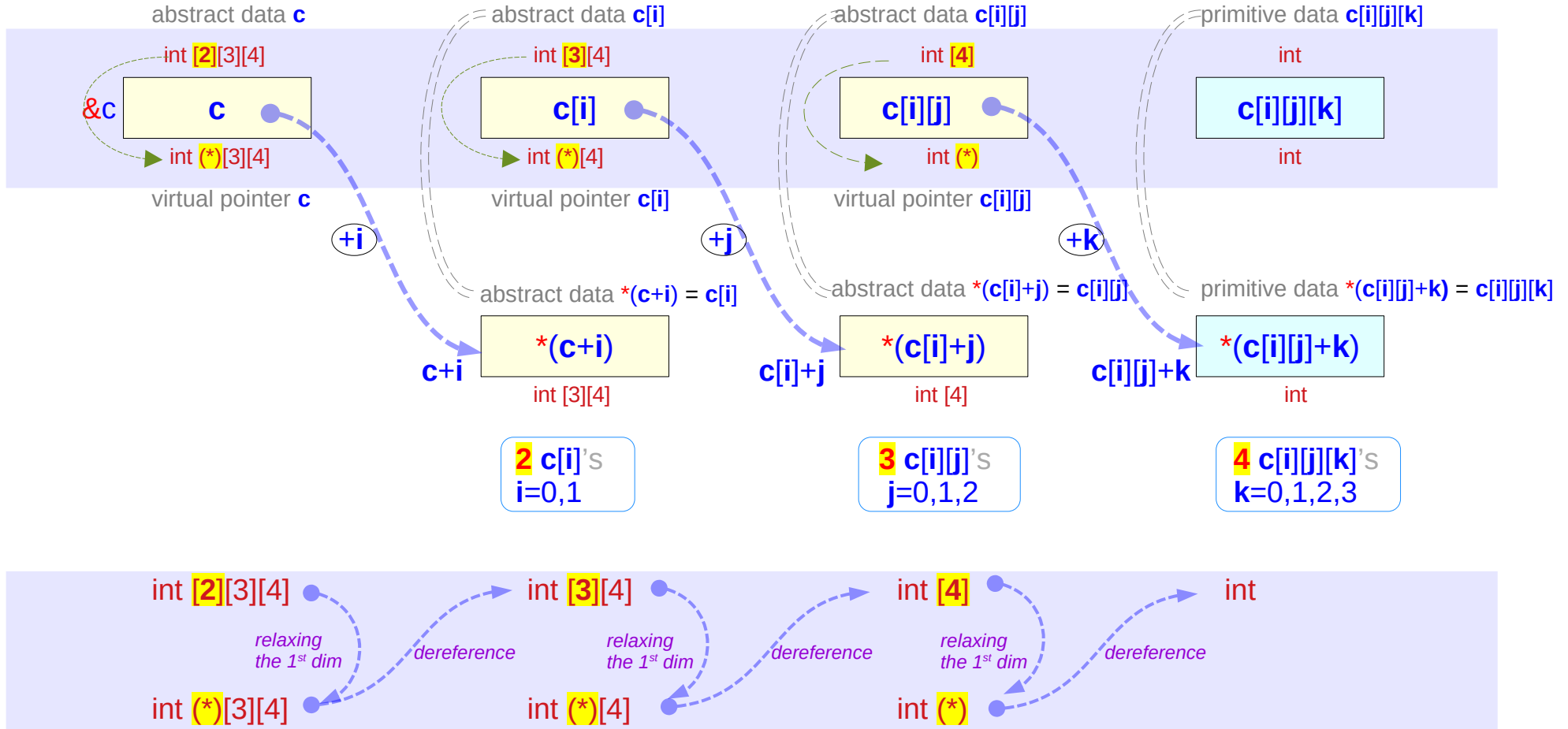

Skipping elements

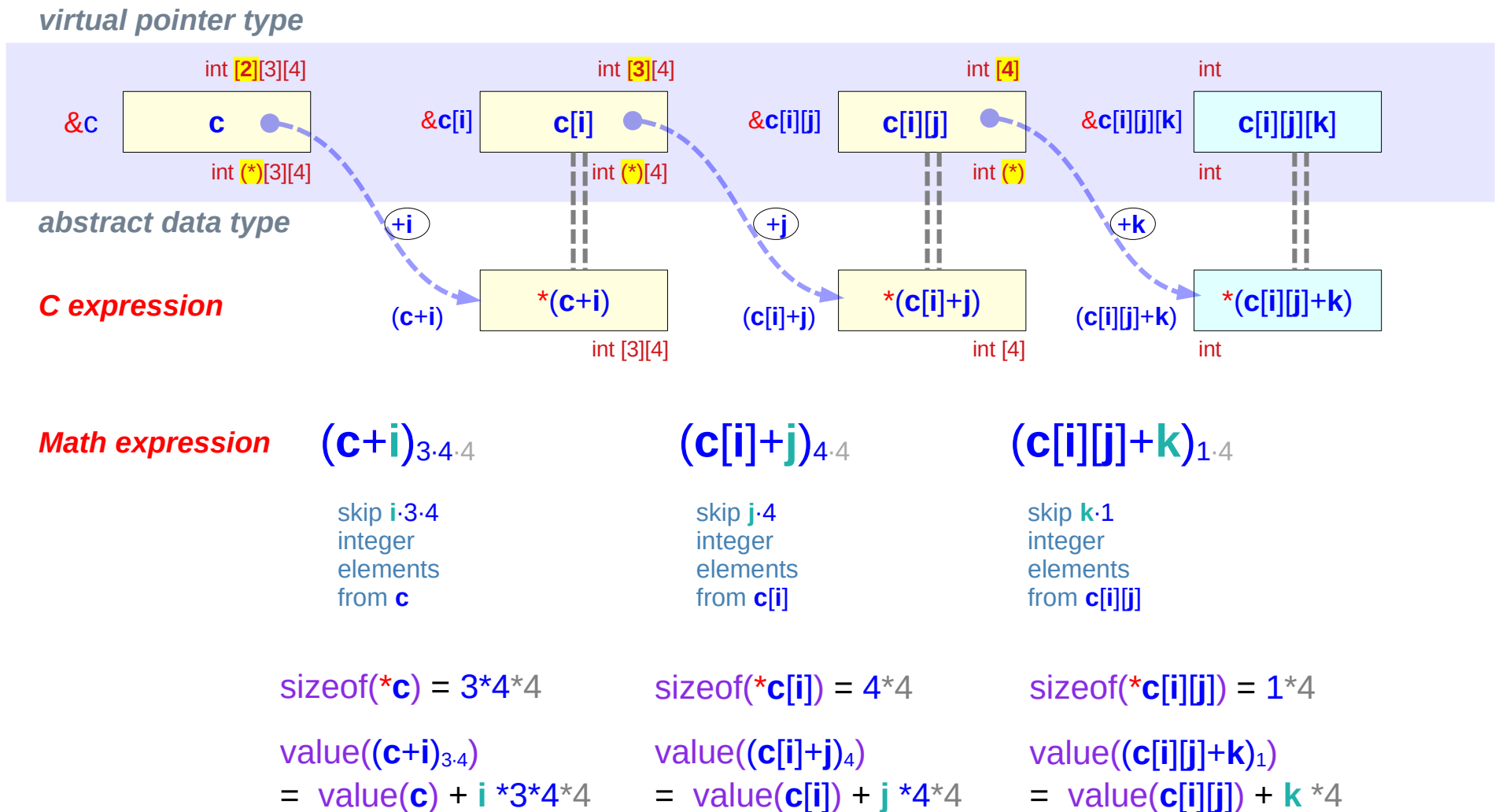

Address replication

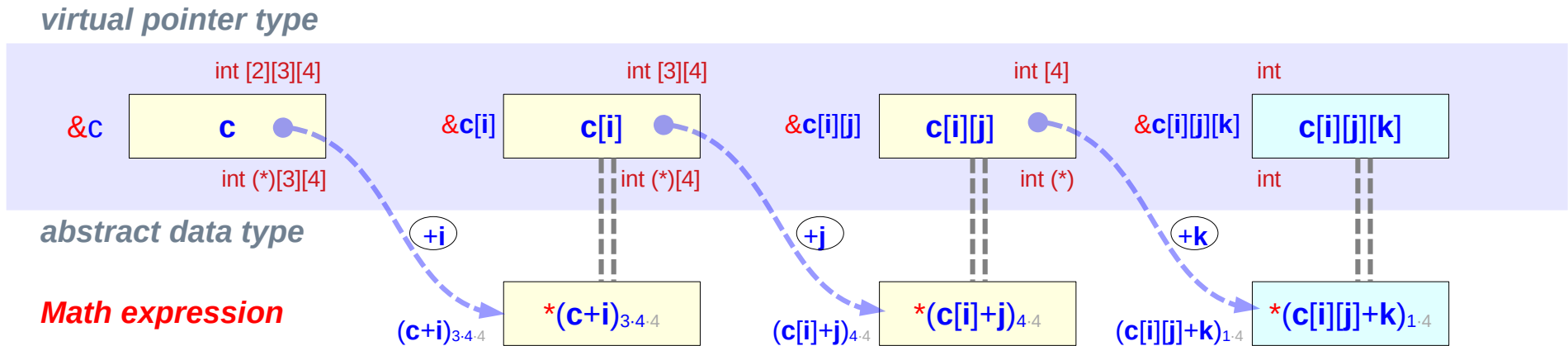

equivalence relations – c expressions

$$\begin{aligned} \mathbf{c[i][j][k]} &= \mathbf{*(c[i][j] + k)} \\ \mathbf{c[i][j]} &= \mathbf{*(c[i] + j)} \\ \mathbf{c[i]} &= \mathbf{*(c + i)} \end{aligned}$$

$$\begin{aligned} \mathbf{\&c[i][j][k]} &= \mathbf{(c[i][j] + k)} \\ \mathbf{\&c[i][j]} &= \mathbf{(c[i] + j)} \\ \mathbf{\&c[i]} &= \mathbf{(c + i)} \end{aligned}$$

address replication – math expressions

$$\begin{aligned} \text{value}(\mathbf{c[i][j]}) &= \text{value}(\mathbf{(c[i] + j)_{4.4}}) \\ \text{value}(\mathbf{c[i]}) &= \text{value}(\mathbf{(c + i)_{3.4.4}}) \end{aligned}$$

Applying address replication

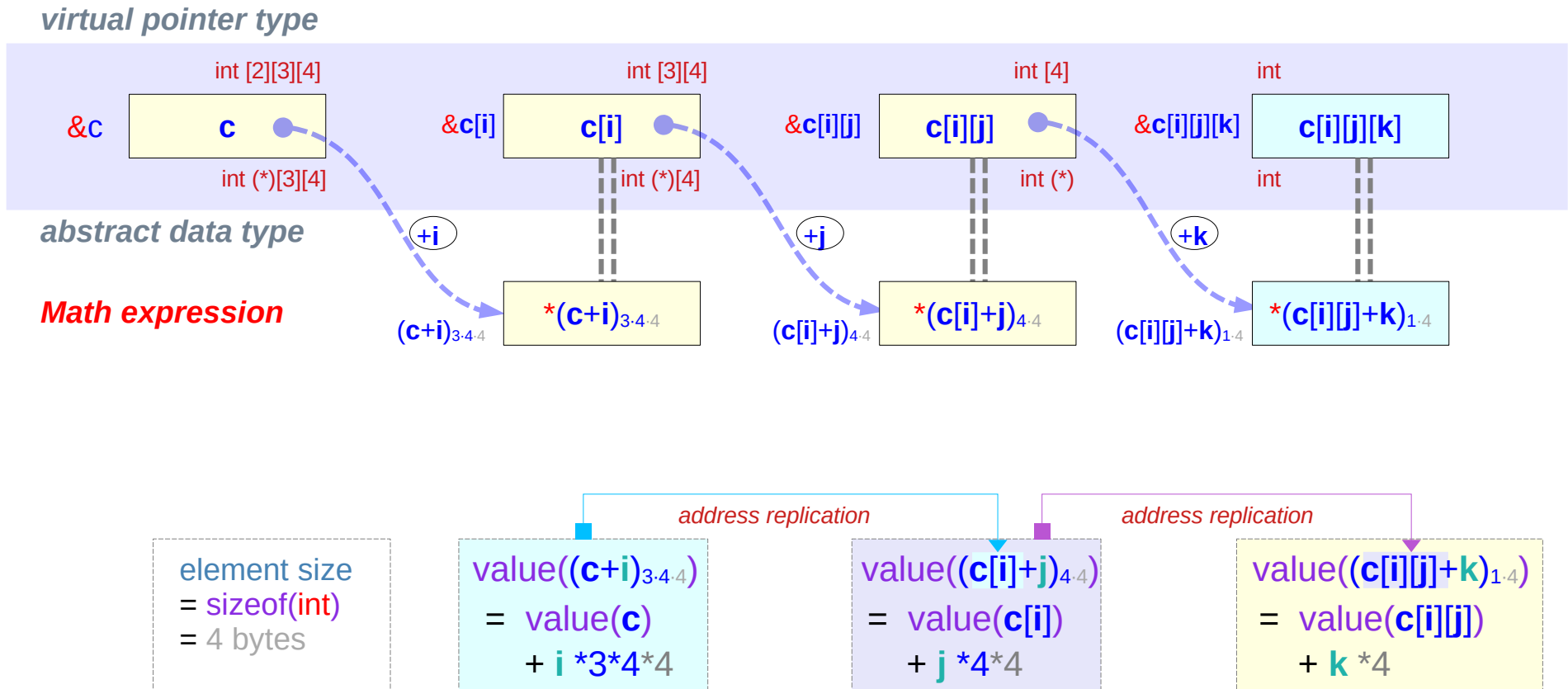

const pointers

const type, const pointer type (1)

```
const int * p;
```

```
int * const q ;
```

```
const int * const r ;
```



```
int * p;
```

```
int * q ;
```

```
int * r ;
```



constant *must not be changed*
must not be updated
must not be written
must not be assigned

const type, const pointer type (2)

const int * p ;

constant integer

*p : constant integer value

int * **const q** ;

constant pointer

q : constant (int *) pointer

const int * **const r** ;

constant integer

*r : constant integer value

const int * **const r** ;

constant pointer

r : constant (int *) pointer

const []

group with the following

const type, const pointer type (3)

`const int *p;`

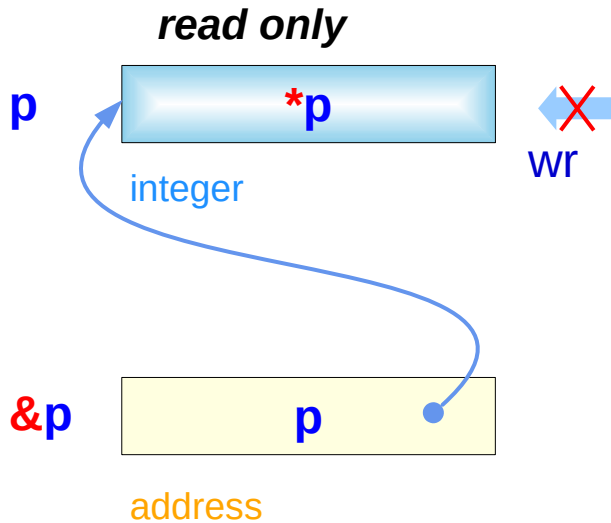

`int *const q;`

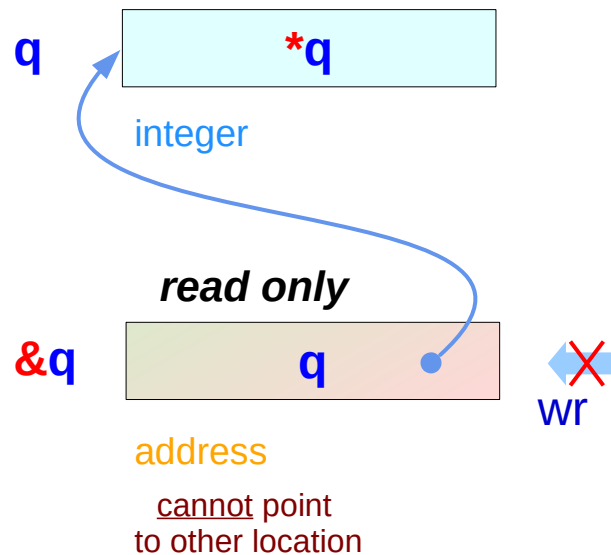

`const int *const r;`

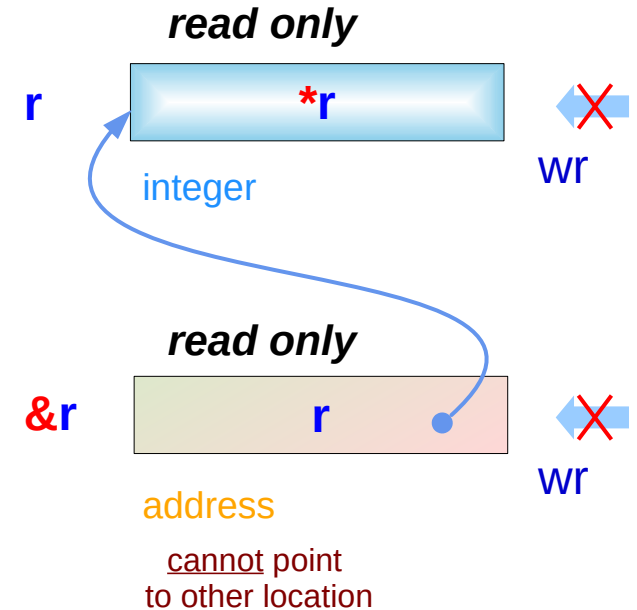

const examples (1)

```
const int * pc;  
int * p, i;  
const int ic;
```

```
pc = &i; // (const int *) ← (int *)  
*pc = 5; // (const int) error
```

Writing to the writable memory location (i)
is forbidden via **pc** ... (no harm, OK)

```
p = &ic; // (int *) ← (const int *) warning  
*p = 5; // (int)
```

Writing to the read only memory location (ic)
is not forbidden via **p** ... (hazardous, not OK)

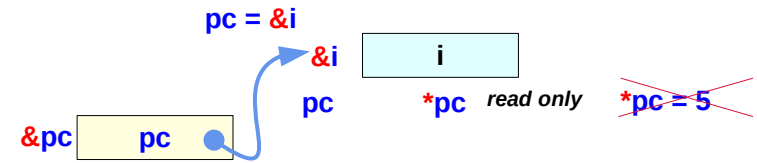

pc can point to **i**
***pc** must be **const**

the same memory location
that can be written via **i**
cannot be written via ***pc**

***pc** should not write
the writable memory location

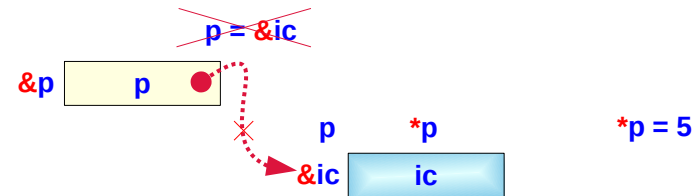

Assume **p** points to **const ic**

the same memory location
that cannot be written via **ic**,
can be written via ***p**

thus ***p** can write
the **const** memory location

therefore, **p** should not point to **const ic**

const examples (2)

```
const int * pc;  
    int * p, i = 5;  
const int ic = 7;
```

```
p = &i;  
pc = &ic
```

// more constrained type ← general type (O)

```
pc = &i; // (const int * ← int *)  
pc = p; // (const int * ← int *)
```

// general type ← more constrained type (X)

```
p = &ic; // (int * ← const int *) warning  
p = pc; // (int * ← const int *) warning
```

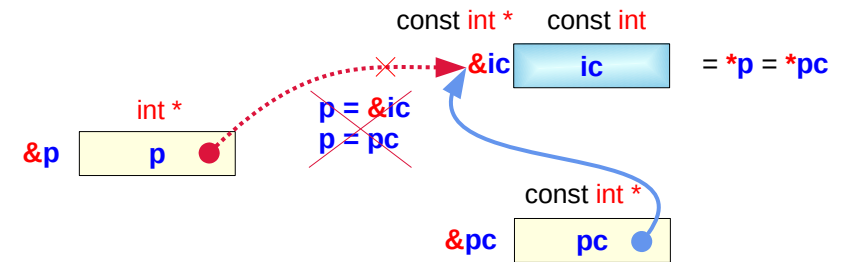
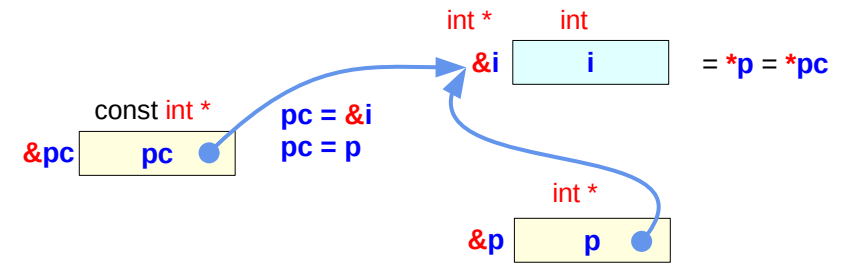

C A Reference Manual, Harbison & Steele Jr.

const examples (3)

```
const int * pc;
      int * p, i;
const int ic;
```

```
p = &i; // (int *) ← (int *)
*p = 5; // (int)
pc = &i; // (const int *) ← (int *)
*pc = 5; // (const int) error
```

```
p = &ic; // (int *) ← (const int *) warning
*p = 5; // (int)
pc = &ic; // (const int *) ← (const int *)
*pc = 5; // (const int) error
```

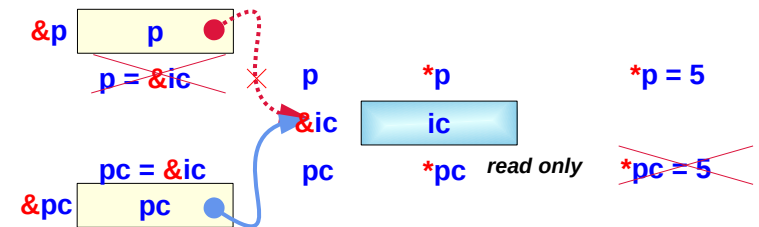
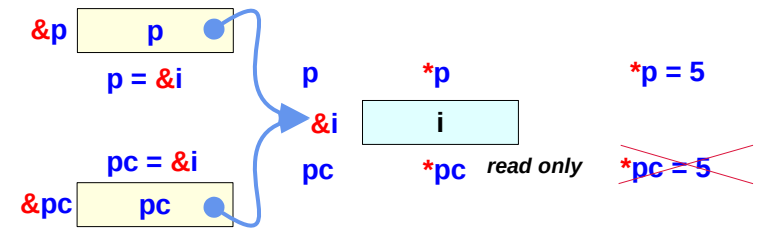
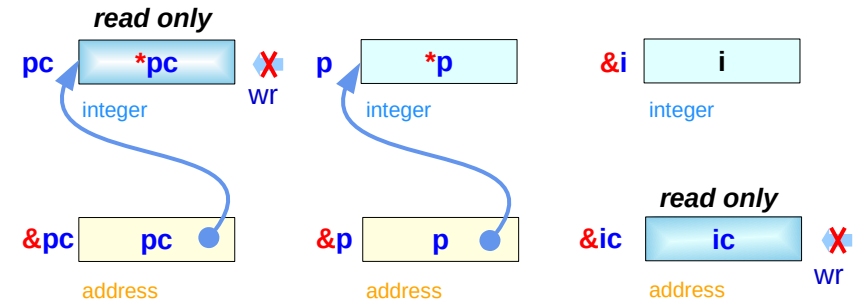

C A Reference Manual, Harbison & Steele Jr.

const examples (4)

```
const int * pc;
      int * p, i;
const int ic;
```

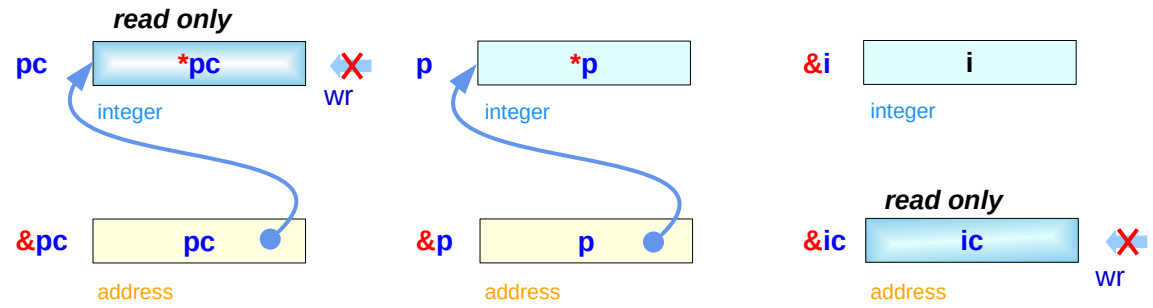

```
pc = p = &i;
pc = &ic
*p = 5;
*pc = 5;           // invalid   *pc :: cons int
```

```
pc = &i;           // (const int * ← int *)
pc = p;           // (const int * ← int *)
p = &ic;          // invalid (int * ← const int *)
p = pc;          // invalid (int * ← const int *)
p = (int *) &ic; // type cast
p = (int *) pc;  // type cast
```

C A Reference Manual, Harbison & Steele Jr.

References

- [1] Essential C, Nick Parlante
- [2] Efficient C Programming, Mark A. Weiss
- [3] C A Reference Manual, Samuel P. Harbison & Guy L. Steele Jr.
- [4] C Language Express, I. K. Chun