

Lambda Calculus - Combinators (8A)

Copyright (c) 2024 - 2016 Young W. Lim.

Permission is granted to copy, distribute and/or modify this document under the terms of the GNU Free Documentation License, Version 1.2 or any later version published by the Free Software Foundation; with no Invariant Sections, no Front-Cover Texts, and no Back-Cover Texts. A copy of the license is included in the section entitled "GNU Free Documentation License".

Please send corrections (or suggestions) to youngwlim@hotmail.com.

This document was produced by using LibreOffice.

Fix point (1)

In mathematics, a **fixed point** (fixpoint), also known as an **invariant point**, is a **value** that does not change under a given **transformation**.

Specifically, for **functions**, a **fixed point** is an **element** that is mapped to **itself** by the **function**.

Formally, **c** is a **fixed point** of a **function f** if **c** belongs to both the **domain** and the **codomain** of **f**, and **$f(c) = c$** .

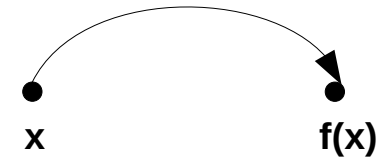

c fixed point **$f(c) = c$**

[https://en.wikipedia.org/wiki/Fixed_point_\(mathematics\)](https://en.wikipedia.org/wiki/Fixed_point_(mathematics))

Fix point (2)

For example, if f is defined on the real numbers by

$$f(x) = x^2 - 3x + 4,$$

then 2 is a fixed point of f , because $f(2) = 2$.

Not all functions have **fixed points**: for example,

$f(x) = x + 1$, has no fixed points,

since x is never equal to $x + 1$ for any real number.

In graphical terms, a **fixed-point** x means

the point $(x, f(x))$ is on the line $y = x$, or in other words

the graph of f has a point in common with that line.

[https://en.wikipedia.org/wiki/Fixed_point_\(mathematics\)](https://en.wikipedia.org/wiki/Fixed_point_(mathematics))

Extensionality (1)

In logic, **extensionality**, or **extensional equality**, refers to principles that judge **objects** to be **equal** if they have the same **external properties**.

It stands in contrast to the concept of **intensionality**, which is concerned with whether the **internal definitions** of **objects** are the same.

<https://en.wikipedia.org/wiki/Extensionality>

Extensionality (2)

Consider the two **functions** **f** and **g** mapping from and to natural numbers, defined as follows:

To find **f(n)**, first add 5 to **n**, then multiply by **2**. $(n + 5)*2$

To find **g(n)**, first multiply **n** by **2**, then add 10. $2*n + 10$

These functions are **extensionally equal**; given the same input, both functions always produce the same value.

But the definitions of the functions are not equal, and in that **intensional** sense the functions are not the same.

extensionally equal

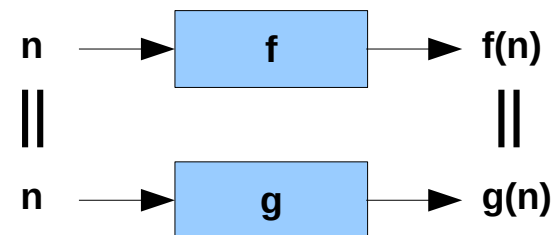

intensionally unequal

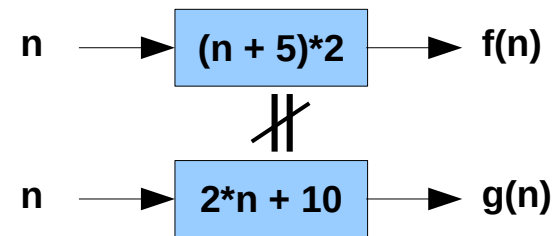

<https://en.wikipedia.org/wiki/Extensionality>

Extensionality (3)

Similarly, in natural language
there are many **predicates** (relations)
that are **intensionally** different
but are **extensionally** identical.

For example, suppose that a town has one person named Joe,
who is also the oldest person in the town.

Then, the two predicates "being called Joe",
and "being the oldest person in this town"
are **intensionally** distinct,
but **extensionally** equal
for the (current) population of this town.

<https://en.wikipedia.org/wiki/Extensionality>

Combinatory Logic

Combinatory logic is a notation to eliminate the need for **quantified variables** in **mathematical logic**.

It was introduced by **Moses Schönfinke** and **Haskell Curry**, and has more recently been used in computer science as a theoretical model of computation and also as a basis for the design of functional programming languages.

It is based on **combinators**

without using **quantified variables**

theoretical model of computation
functional programming

combinators

https://en.wikipedia.org/wiki/Combinatory_logic

Combinator

combinators were introduced by Schönfinkel in 1920 with the idea of providing an analogous way

- to build up **functions**
- to remove any mention of **variables**
- particularly in **predicate logic**.

A **combinator** is a **higher-order function** that uses only **function application**

earlier defined **combinators** to define a **result** from its **arguments**.

Combinators:
define a result by its **argument**
without free **variables**

https://en.wikipedia.org/wiki/Combinatory_logic

Combinator Definitions (1)

Combinator : A **lambda expression** containing no free variables.

the word is usually understood more specifically to refer to certain **combinators** of special importance, in particular the following four:

I = $\lambda x . x$

K = $\lambda x . \lambda y . x$

S = $\lambda x . \lambda y . \lambda z . x(z)(y(z))$

Y = $\lambda f . (\lambda u . f(u(u))) (\lambda u . f(u(u)))$

Identity

Constant function

Substitution operator

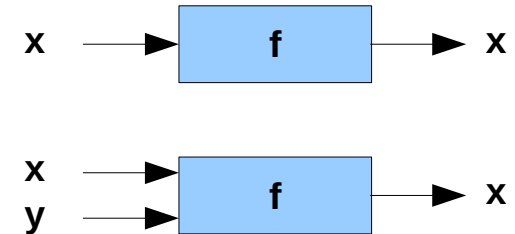

<https://www.encyclopedia.com/computing/dictionaries-thesauruses-pictures-and-press-releases/combinator>

Combinator informal description (1-1)

Informally, a **tree** (xy) can be thought of as a **function** x applied to an **argument** y .

When **evaluated** (i.e., when the function is "applied" to the **argument**), the tree "returns a value", i.e., transforms into another **tree**.

The "function", "argument" and the "value" are either **combinators** or **binary trees**.

If they are **binary trees**, they may be thought of as **functions** too, if needed.

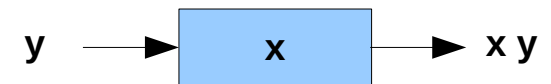
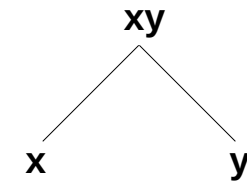

https://en.wikipedia.org/wiki/SKI_combinator_calculus

Combinator informal description (1-2)

Although the most formal representation of the objects in this system requires **binary trees**, for simpler typesetting they are often represented as **parenthesized expressions**, as a shorthand for the tree they represent.

Any **subtrees** may be **parenthesized**, but often only the right-side subtrees are **parenthesized**, with **left associativity** implied for any unparenthesized applications.

For example, **ISK** means **((IS)K)**.

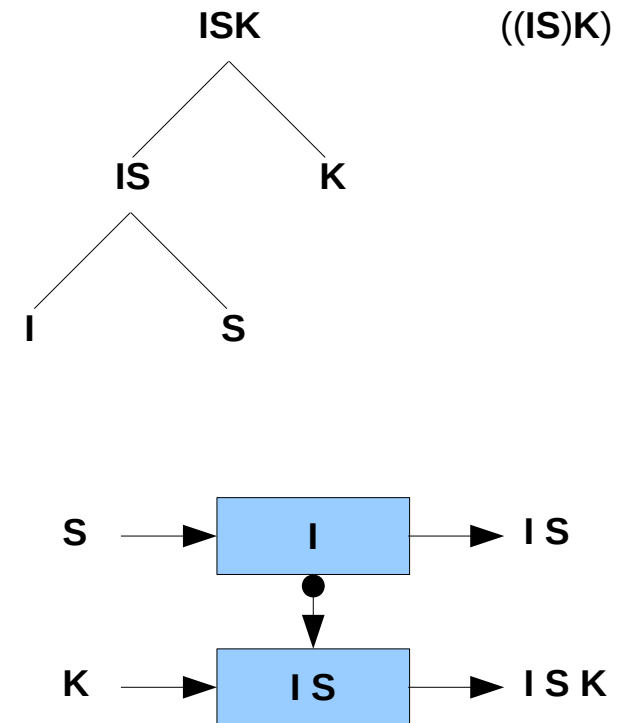

https://en.wikipedia.org/wiki/SKI_combinator_calculus

Combinator informal description (1-3)

a tree whose **left subtree** is the tree **KS**
and whose **right subtree** is the tree **SK**
can be written as **KS(SK)**.

If more explicitness is desired,
the implied parentheses can be included as well: **((KS)(SK))**.

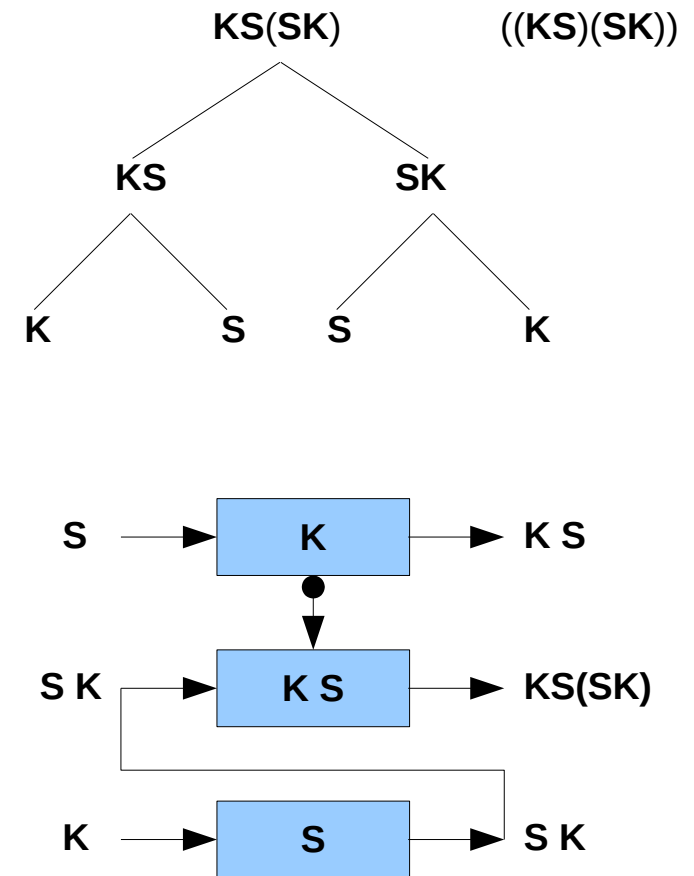

https://en.wikipedia.org/wiki/SKI_combinator_calculus

I combinator

The **evaluation operation** is defined as follows:

x, **y**, and **z** represent **expressions**
made from the **functions S**, **K**, and **I**, and **set values**:

I returns its argument:

$$I x = x$$



https://en.wikipedia.org/wiki/SKI_combinator_calculus

Examples of Combinators (1-1)

The simplest example of a **combinator** is **I**, the **identity combinator**, defined by

$$(I\ x) = x \quad \text{for all terms } x.$$

https://en.wikipedia.org/wiki/Combinatory_logic

K combinator

K, when applied to any argument **x**,
yields a one-argument **constant function** **K x**,
which, when applied to any argument **y**, returns **x**:

$$\mathbf{K} \ x \ y = x$$

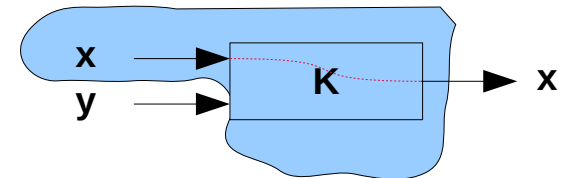
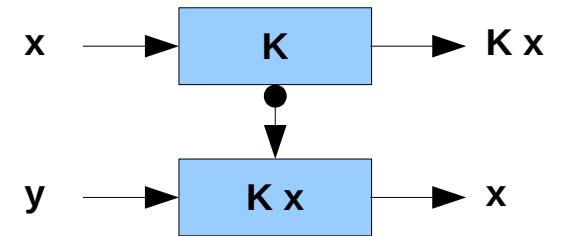
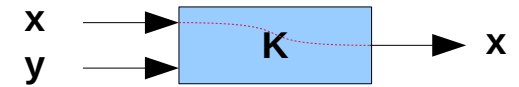

https://en.wikipedia.org/wiki/SKI_combinator_calculus

Examples of Combinators (1-2)

Another simple **combinator** is **K**,

which manufactures **constant functions**:

(K x) is the **function** which, for any **argument**, returns **x**, so we say

$$((K x) y) = x \quad \text{for all terms } x \text{ and } y.$$

Or, following the convention for **multiple application**,

$$(K x y) = x$$

https://en.wikipedia.org/wiki/Combinatory_logic

S combinator

S is a **substitution** operator.

takes three arguments (**x y z**)

returns the result of **x z** applied to the result of **y z**

the first argument (**x**) applied to the third (**z**),

which is then applied to the result

of the second argument (**y**) applied to the third (**z**).

$$\mathbf{S\ x\ y\ z = x\ z\ (y\ z)}$$

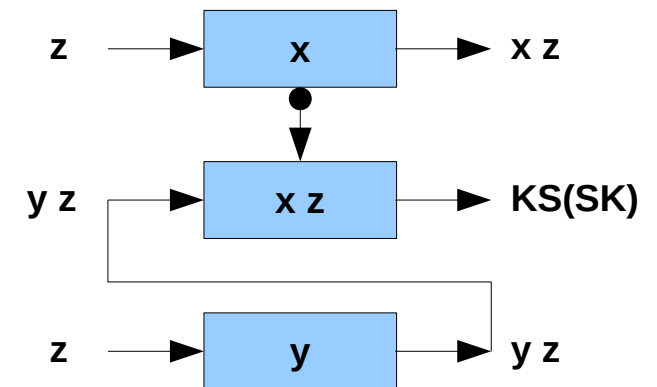
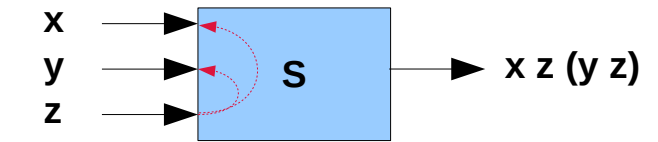

a **function** of **x z** with the **argument** **y z**
a **function** of **x** with the **argument** **z**
a **function** of **y** with the **argument** **z**

https://en.wikipedia.org/wiki/SKI_combinator_calculus

Examples of Combinators (2-1)

A third **combinator** is **S**, which is a generalized version of **application**:

$$(S\ x\ y\ z) = (x\ z\ (y\ z))$$

S applies **x** to **y**

after first substituting **z** into each of them (**x** and **y**)

x is applied to **y**

inside the **environment** **z**.

https://en.wikipedia.org/wiki/Combinatory_logic

Examples of Combinators (2-2)

Given **S** and **K**, **I** itself is *unnecessary*,
since it can be built from the other two:

$$((S K K) x)$$
$$= (S K K x)$$
$$= (K x (K x))$$
$$= x$$

for any **term** x .

https://en.wikipedia.org/wiki/Combinatory_logic

Combinator informal description (3-1)

SKSK evaluates to **KK(SK)** by the **S-rule**.

Then if we evaluate **KK(SK)**, we get **K** by the **K-rule**.

As no further rule can be applied, the computation halts here.

For all trees **x** and all trees **y**,

SKxy will always evaluate to **y** in two steps, **Ky(xy) = y**,

so the ultimate result of evaluating **SKxy**

will always equal the result of evaluating **y**.

We say that **SKx** and **I** are "functionally equivalent" for any **x**
because they always yield the same result when applied to any **y**.

$$\mathbf{S} \mathbf{x} \mathbf{y} \mathbf{z} = \mathbf{x} \mathbf{z} (\mathbf{y} \mathbf{z}) \quad \text{S-rule}$$

$$\mathbf{S} \mathbf{K} \mathbf{S} \mathbf{K} = \mathbf{K} \mathbf{K} (\mathbf{S} \mathbf{K})$$

$$\mathbf{K} \mathbf{x} \mathbf{y} = \mathbf{x} \quad \text{K-rule}$$

$$\mathbf{K} \mathbf{K} (\mathbf{S} \mathbf{K}) = \mathbf{K}$$

$$\mathbf{S} \mathbf{K} \mathbf{x} \mathbf{y} = \mathbf{K} \mathbf{y} (\mathbf{x} \mathbf{y}) = \mathbf{y}$$

$$\mathbf{I} \mathbf{y} = \mathbf{y}$$

https://en.wikipedia.org/wiki/SKI_combinator_calculus

Combinator informal description (3-2)

it can be shown that **SKI calculus** is not the minimum system that can fully perform the computations of **lambda calculus**,

as all occurrences of **I** in any expression can be replaced by **(SKK)** or **(SKS)** or **(SK x)** for any **x**, and the resulting expression will yield the same result.

So the "**I**" is merely syntactic sugar.

Since **I** is optional, the system is also referred as **SK calculus** or **SK combinator calculus**.

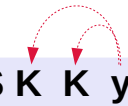
$$S K K y = K y (K y) = y$$

$$I y = y$$

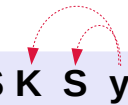
$$S K S y = K y (S y) = y$$

$$I y = y$$

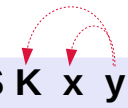
$$S K x y = K y (x y) = y$$

$$I y = y$$

https://en.wikipedia.org/wiki/SKI_combinator_calculus

Examples of Combinators (3-1)

Note that although $((S K K) x) = (I x)$ for any x ,
 $(S K K)$ itself is not equal to I .

We say the terms are **extensionally equal**.

Extensional equality captures the mathematical notion
of the **equality** of **functions**:

that two **functions** are equal
if they always produce the same results for the same arguments.

https://en.wikipedia.org/wiki/Combinatory_logic

Examples of Combinators (3-2)

In contrast, the **terms** themselves,
together with the **reduction** of **primitive combinators**,
capture the notion of **intensional equality** of functions:

that two **functions** are equal
only if they have **identical implementations**
up to the expansion of **primitive combinators**.

https://en.wikipedia.org/wiki/Combinatory_logic

Examples of Combinators (3-3)

There are many ways to implement an **identity function**;
(S K K) and **I** are among these ways.

(S K S) is yet another.

We will use the word **equivalent** to indicate **extensional equality**,
reserving **equal** for **identical combinatorial terms**.

https://en.wikipedia.org/wiki/Combinatory_logic

Examples of Combinators (4)

A more interesting combinator is the **fixed point combinator** or **Y combinator**, which can be used to implement **recursion**.

https://en.wikipedia.org/wiki/Combinatory_logic

Combinator Definitions (2)

The **combinators** **I**, **K**, and **S** were introduced by Schönfinkel and Curry, who showed that any **λ -expression** can essentially be formed by combining them.

More recently **combinators** have been applied to the design of implementations for **functional languages**.

In particular **Y** (also called the **paradoxical combinator**) can be seen as producing **fixed points**, since **Y(f)** reduces to **f(Y(f))**.

$$I = \lambda x . x$$

$$K = \lambda x . \lambda y . x$$

$$S = \lambda x . \lambda y . \lambda z . x(z)(y(z))$$

$$Y = \lambda f . (\lambda u . f(u(u))) (\lambda u . f(u(u)))$$

<https://www.encyclopedia.com/computing/dictionaries-thesauruses-pictures-and-press-releases/combinator>

Combinatory Logic and Lambda Calculus (1)

Lambda calculus is concerned with objects called **lambda-terms**, which can be represented by the following three forms of strings:

v

$\lambda v. E_1$

$(E_1 E_2)$

where v is a variable name drawn from a predefined infinite set of variable names, and E_1 and E_2 are **lambda-terms**.

https://en.wikipedia.org/wiki/Combinatory_logic

Combinatory Logic and Lambda Calculus (2)

Terms of the form $\lambda v. E_1$ are called **abstractions**.

The variable v is called the **formal parameter** of the abstraction, and E_1 is the **body** of the abstraction.

The term $\lambda v. E_1$ represents the **function**

applied to an **argument**,

binds the **formal parameter** v to the **argument**

computes the resulting value of E_1

returns E_1 , with every occurrence of v replaced by the **argument**.

v

$\lambda v. E_1$

$(E_1 E_2)$

https://en.wikipedia.org/wiki/Combinatory_logic

Combinatory Logic and Lambda Calculus (3-1)

Terms of the form $(E_1 E_2)$ are called **applications**.

applications model **function invocation** or **execution**:
the **function** represented by E_1 is to be invoked,
with E_2 as its **argument**, and the result is computed.

https://en.wikipedia.org/wiki/Combinatory_logic

Combinatory Logic and Lambda Calculus (3-2)

If E_1 (the applicand) is an **abstraction**, the term may be reduced:
 E_2 , the **argument**, may be substituted into the **body** of E_1
in place of the **formal parameter** v of E_1 ,
and the result is a new **lambda term** which is equivalent to the old one.

If a **lambda term** contains no **subterms** of the form $((\lambda v. E_1) E_2)$
then it cannot be reduced, and is said to be in **normal form**.

https://en.wikipedia.org/wiki/Combinatory_logic

Combinatory Logic and Lambda Calculus (4)

The motivation for this definition of **reduction** is that it captures the essential behavior of all **mathematical functions**.

For example, consider the function that computes the square of a number. We might write

The **square** of **x** is $x * x$ (using $*$ to indicate multiplication.)

x here is the **formal parameter** of the function.

To evaluate the **square** for a particular **argument**, say 3, we insert it into the definition in place of the formal parameter:

The **square** of **3** is $3 * 3$

https://en.wikipedia.org/wiki/Combinatory_logic

Combinatory Logic and Lambda Calculus (5)

To evaluate the resulting expression $3 * 3$, we would have to resort to our knowledge of multiplication and the number 3.

Since any computation is simply a composition of the evaluation of suitable **functions** on suitable **primitive arguments**,

this simple **substitution principle** suffices to capture the essential mechanism of computation.

https://en.wikipedia.org/wiki/Combinatory_logic

Combinatory Logic and Lambda Calculus (6)

Moreover, in **lambda calculus**, notions such as '3' and '*' can be represented without any need for externally defined primitive operators or constants.

It is possible to identify **terms** in **lambda calculus**, which, when suitably interpreted, behave like the number 3 and like the multiplication operator *, q.v. **Church encoding**.

https://en.wikipedia.org/wiki/Combinatory_logic

Combinatory Logic and Lambda Calculus (7)

Lambda calculus is known to be computationally equivalent in power to many other plausible models for computation (including Turing machines);

that is, any calculation that can be accomplished in any of these other models can be expressed in lambda calculus, and vice versa.

According to the Church-Turing thesis, both models can express any possible computation.

https://en.wikipedia.org/wiki/Combinatory_logic

Combinatory Logic and Lambda Calculus (8-1)

lambda-calculus can represent any conceivable computation using only the simple notions of **function abstraction** and **application** based on simple textual **substitution** of **terms** for **variables**.

abstraction is not even *required*.

Combinatory logic is a model of computation equivalent to **lambda calculus**, but without **abstraction**.

https://en.wikipedia.org/wiki/Combinatory_logic

Combinatory Logic and Lambda Calculus (8-2)

Combinatory logic is a model of computation equivalent to **lambda calculus**, but without abstraction.

The advantage of this is that evaluating expressions in **lambda calculus** is quite complicated because the **semantics** of **substitution** must be specified with great care to avoid variable capture problems.

evaluating expressions in **combinatory logic** is much simpler, because there is no notion of **substitution**.

https://en.wikipedia.org/wiki/Combinatory_logic

Combinatory Calculus

abstraction is the only way to manufacture **functions**
in the **lambda calculus**

Instead of **abstraction**,
combinatory calculus provides a limited set of **primitive functions**
out of which other **functions** may be built.

https://en.wikipedia.org/wiki/Combinatory_logic

Combinatory Terms (1)

A **combinatory term** has one of the following **forms**:

Syntax	Name	Description
x	Variable	A character or string representing a combinatory term .
P	Primitive function	One of the combinator symbols I , K , S .
(M N)	Application	<u>Applying</u> a function to an argument . M and N are combinatory terms .

https://en.wikipedia.org/wiki/Combinatory_logic

Combinatory Terms (2)

The **primitive functions** are **combinators**, or **functions** that, when seen as **lambda terms**, contain no **free variables**.

To shorten the notations, a general convention is that $(E_1 E_2 E_3 \dots E_n)$, or even $E_1 E_2 E_3 \dots E_n$, denotes the term $(\dots ((E_1 E_2) E_3) \dots E_n)$.

This is the same general convention (left-associativity) as for multiple application in lambda calculus.

https://en.wikipedia.org/wiki/Combinatory_logic

Reductions in Combinatory Logic

In **combinatory logic**, each **primitive combinator** comes with a **reduction rule** of the form

$$(P x_1 \dots x_n) = E$$

where **E** is a **term** mentioning only **variables** from the set $\{x_1 \dots x_n\}$.

It is in this way that **primitive combinators** behave as **functions**.

https://en.wikipedia.org/wiki/Combinatory_logic

Fix-point combinator (1-1)

a **fixed-point combinator**

(or **fixpoint combinator**),

denoted **fix**, is a **higher-order function**

which takes a **function f** as **argument**

that returns some **fixed point (fix f)**

(a value that is mapped to itself)

of its **argument function f**, if one exists.

$$\mathbf{fix\ f = f\ (fix\ f)},$$

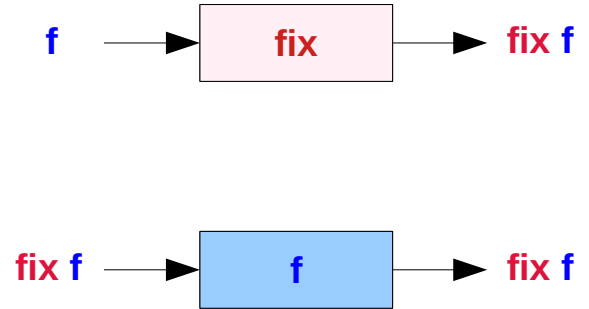

https://en.wikipedia.org/wiki/Fixed-point_combinator

Fix-point combinator (1-2)

some **fixed point** (**fix f**) of its **argument function f**, if one exists.

Formally, if the **function f** has one or more fixed points, then

$$\mathbf{fix\ f} = \mathbf{f\ (fix\ f)},$$

and hence, by repeated application,

$$\mathbf{fix\ f} = \mathbf{f\ (f\ (... f\ (fix\ f)\ ...))}$$

fix f fixed point

fix fixed point combinator

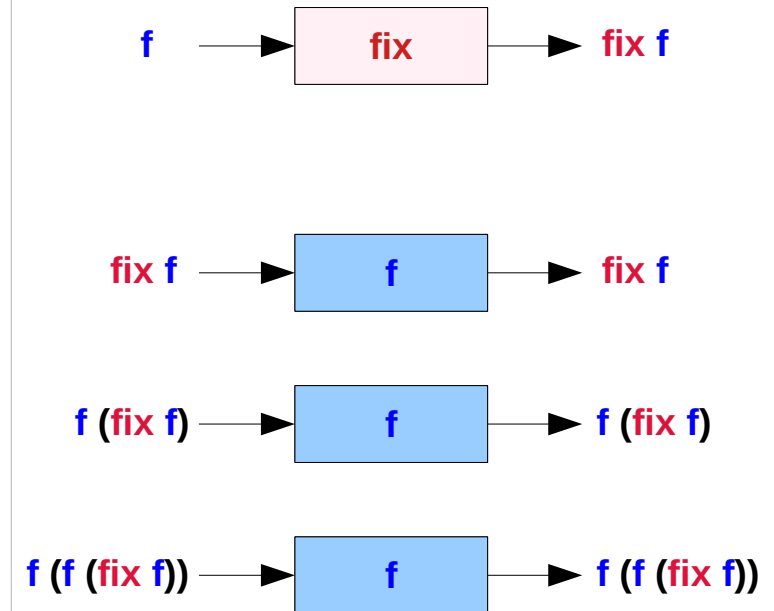

$$Y = (\lambda f. (\lambda x. f (x x)) (\lambda x. f (x x)))$$

$$Y g = g (Y g)$$

https://en.wikipedia.org/wiki/Fixed-point_combinator

Fix-point combinator (1111)

Every **recursively defined function** can be seen as a **fixed point** of some suitably defined **function closing** over the **recursive call** with an **extra argument**,

and therefore, using **Y**, every **recursively defined function** can be expressed as a **lambda expression**.

In particular, we can now cleanly define the **subtraction**, **multiplication** and **comparison predicate** of natural numbers recursively.

$$Y = \lambda f. (\lambda x. f (x x)) (\lambda x. f (x x))$$

$$Y g = g (Y g)$$

https://en.wikipedia.org/wiki/Lambda_calculus#Formal_definition

Fix-point combinator (3-1)

In the classical untyped **lambda calculus**, every function has a fixed point.

A particular implementation of fix is Curry's paradoxical **combinator Y**, represented by

$$Y = \lambda f. (\lambda x. f (x x)) (\lambda x. f (x x))$$

In functional programming, the **Y combinator** can be used to formally define **recursive functions** in a programming language that does not support **recursion**.

https://en.wikipedia.org/wiki/Fixed-point_combinator

Fix-point combinator (3-1)

$$Y = \lambda f. (\lambda x. f (x x)) (\lambda x. f (x x))$$

Y is a **function** that takes one **argument** **f** and returns the entire expression following the first period;

$$(\lambda x. f (x x)) (\lambda x. f (x x))$$

the expression $(\lambda x. f (x x))$ denotes a **function** that takes one **argument** **x**, thought of as a **function**, and returns the expression **f (x x)**,

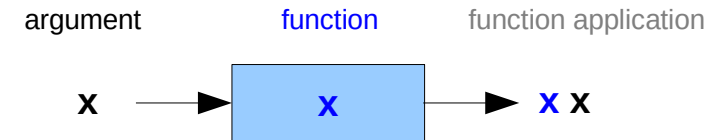

https://en.wikipedia.org/wiki/Fixed-point_combinator

Fix-point combinator (3-1)

$$Y = \lambda f. (\lambda x. f (x x)) (\lambda x. f (x x))$$

the expression $(\lambda x. f (x x))$ denotes a function

that takes one argument x ,

which is thought of as a function,

and returns the expression $f (x x)$,

where $(x x)$ denotes

a function x applied to itself as an argument.

Juxtaposition of expressions denotes function application, is left-associative, and has higher precedence than the period.)

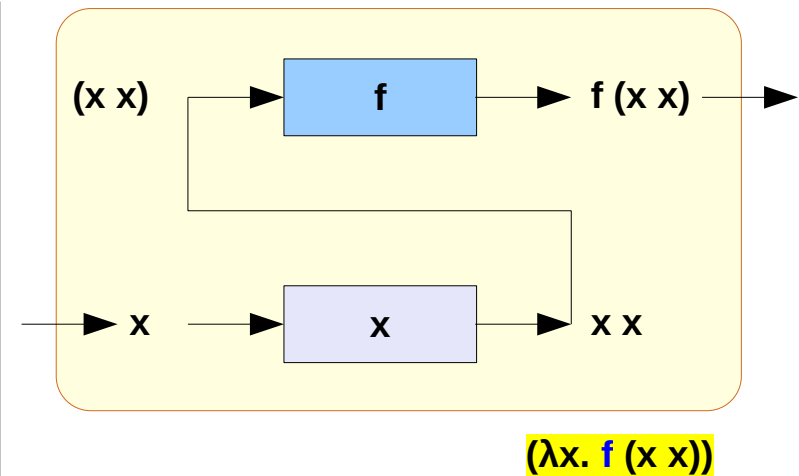

https://en.wikipedia.org/wiki/Fixed-point_combinator

Fix-point combinator (3-1)

$$Y = \lambda f. (\lambda x. f (x x)) (\lambda x. f (x x))$$

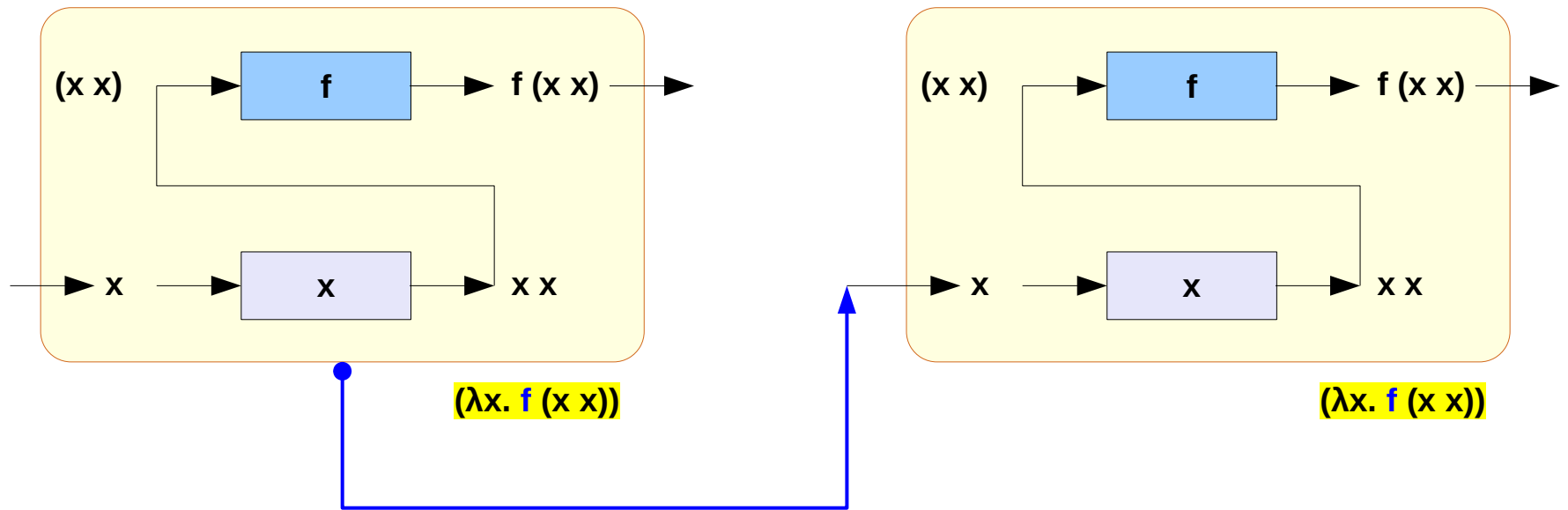

https://en.wikipedia.org/wiki/Fixed-point_combinator

Fix-point combinator (3-2)

The following calculation verifies that $Y\ g$ is indeed a **fixed point** of the function g :

$$Y\ g = (\lambda f. (\lambda x. f\ (x\ x))\ (\lambda x. f\ (x\ x)))\ g$$

$$= (\lambda x. g\ (x\ x))\ (\lambda x. g\ (x\ x))$$

$$= g\ ((\lambda x. g\ (x\ x))\ (\lambda x. g\ (x\ x)))$$

$$= g\ (Y\ g)$$

by the definition of Y

by β -reduction: replacing the **formal argument** f of Y with the **actual argument** g

by β -reduction: replacing the **formal argument** x of the first function with the **actual argument** $(\lambda x. g\ (x\ x))$

by second equality, above

https://en.wikipedia.org/wiki/Fixed-point_combinator

Fix-point combinator (3-3)

The following calculation verifies that $Y g$ is indeed a **fixed point** of the function g :

$$\begin{aligned} Y g &= (\lambda f. (\lambda x. f (x x)) (\lambda x. f (x x))) g && \text{by the definition of } Y \\ &= g (Y g) && \text{by second equality, above} \end{aligned}$$

The lambda term $g (Y g)$ may not, in general, β -reduce to the term $(Y g)$.

However, both terms β -reduce to the same term, as shown.

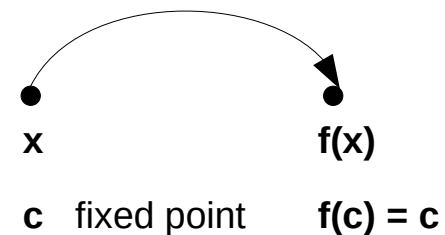
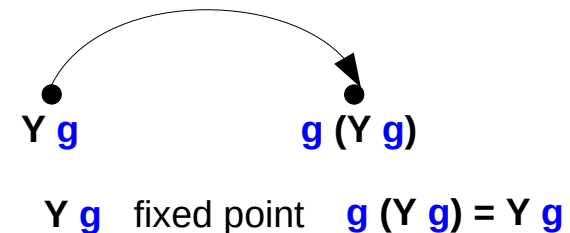

https://en.wikipedia.org/wiki/Fixed-point_combinator

Fix-point combinator (3-2)

This **combinator** may be used in implementing **Curry's paradox**.

The heart of Curry's paradox is that untyped **lambda calculus** is unsound as a **deductive system**,

and the **Y combinator** demonstrates this by allowing an **anonymous expression** to represent **zero**, or even many **values**.

This is inconsistent in **mathematical logic**.

https://en.wikipedia.org/wiki/Fixed-point_combinator

Fix-point combinator (3-3)

Applied to a function with one variable,
the **Y combinator** usually does not terminate.

More interesting results are obtained
by applying the Y combinator to functions of two or more variables.
the additional variables may be used as a **counter**, or **index**.
the resulting function behaves like a **while** or a **for** loop
in an imperative language.

$$Y = (\lambda f. (\lambda x. f (x x)) (\lambda x. f (x x)))$$

$$Y g = g (Y g)$$

https://en.wikipedia.org/wiki/Fixed-point_combinator

Fix-point combinator (3-3)

Used in this way, the **Y combinator** implements simple recursion.

The lambda calculus does not allow a **function** to appear as a **term** in its own **definition** as is possible in many programming languages,

but a **function** can be passed as an **argument** to a **higher-order function** that applies it in a recursive manner.

$$Y = (\lambda f. (\lambda x. f (x x)) (\lambda x. f (x x)))$$

$$Y g = g (Y g)$$

https://en.wikipedia.org/wiki/Fixed-point_combinator

The factorial function (1)

The factorial function provides a good example of how a fixed-point combinator may be used to define recursive functions.

The standard recursive definition of the factorial function in mathematics can be written as

$$\mathbf{fact\ n = \begin{cases} \mathbf{1} & \mathbf{if\ n = 0} \\ \mathbf{n\ fact\ (n-1)} & \mathbf{otherwise.} \end{cases}}$$

where **n** is a non-negative integer.

https://en.wikipedia.org/wiki/Fixed-point_combinator

The factorial function (2)

If we want to implement this in **lambda calculus**,
- integers are represented using **Church encoding**,
the problem is that the **lambda calculus**
does not allow the name of a **function** ('fact')
to be used in the function's definition.

this problem can be circumvented
using a **fixed-point combinator** **fix** as follows.

$$\mathbf{fix\ f = f\ (fix\ f)}$$

$$\mathbf{fix\ F = F\ (fix\ F)},$$

$$\mathbf{fix\ f = f\ (fix\ f)},$$

fix f fixed point

fix fixed point combinator

https://en.wikipedia.org/wiki/Fixed-point_combinator

The factorial function (3-1)

using a **fixed-point combinator** **fix** as follows.

$$\mathbf{fix\ f = f\ (fix\ f)}$$

$$\mathbf{fix\ F = F\ (fix\ F)},$$

Let the **fixed point** (**fix F**) of **F** as **fact**

$$\mathbf{fact \equiv fix\ F}$$

$$\mathbf{(fix\ F) = F\ (fix\ F)}$$

$$\mathbf{(fact) = F\ (fact)} \quad \text{fixed-point fact}$$

$$\mathbf{(fact\ n) = F\ (fact\ n)}$$

$$\mathbf{fix\ F = F\ (fix\ F)},$$

fix F fixed point

fix fixed point combinator

$$\mathbf{fact\ n = F\ fact\ n}$$

$$= (\text{IsZero } n) \quad 1$$

$$\quad (\text{multiply } n \text{ (fact (pred } n)))$$

https://en.wikipedia.org/wiki/Fixed-point_combinator

The factorial function (3-2)

a fixed-point combinator **fix**

$$\mathbf{fix\ F = F (fix\ F),}$$

the fixed point (**fix F**) of **F** as **fact**

$$\mathbf{(fact\ n) = F (fact\ n)}$$

define a function **F** of two arguments **f** and **n**:

$$\mathbf{F\ f\ n = (IsZero\ n)\ 1\ (multiply\ n\ (f\ (pred\ n)))}$$

$$\mathbf{F\ fact\ n = (IsZero\ n)\ 1\ (multiply\ n\ (fact\ (pred\ n)))}$$

$$\mathbf{fix\ F = F (fix\ F),}$$

fix F fixed point

fix fixed point combinator

$$\mathbf{fact\ n = F\ fact\ n}$$

$$= (IsZero\ n)\ 1$$

$$(multiply\ n\ (fact\ (pred\ n)))$$

https://en.wikipedia.org/wiki/Fixed-point_combinator

The factorial function (4)

$(\text{fact } n) = F (\text{fact } n)$

$F f n = (\text{IsZero } n) 1 (\text{multiply } n (f (\text{pred } n)))$

$F \text{fact } n = (\text{IsZero } n) 1 (\text{multiply } n (\text{fact } (\text{pred } n)))$

$\text{fact } n = F \text{fact } n$
 $= (\text{IsZero } n) 1 (\text{multiply } n (\text{fact } (\text{pred } n)))$

$n * \text{fact } (n-1)$

$\text{fix } F = F (\text{fix } F),$

$\text{fix } F$ fixed point

fix fixed point combinator

$\text{fact } n = F \text{fact } n$
 $= (\text{IsZero } n) 1$
 $(\text{multiply } n (\text{fact } (\text{pred } n)))$

https://en.wikipedia.org/wiki/Fixed-point_combinator

The factorial function (5)

```
fact n = F fact n
       = (IsZero n) 1 (multiply n (fact (pred n)))
```

here **(IsZero n)** is a function

that takes two arguments **1 (multiply n (fact (pred n)))**

and returns

its first argument **1** if **n=0**,

otherwise its second argument **(multiply n (f (pred n)))**

pred n evaluates to **n-1**

$$\text{fact } n = \begin{cases} 1 & \text{if } n = 0 \\ n \text{ fact } (n-1) & \text{otherwise.} \end{cases}$$

https://en.wikipedia.org/wiki/Fixed-point_combinator

Recursion (1-1)

recursion:

the definition of a **function** using the **function** itself.

A **function definition** containing itself inside itself, by value, leads to the whole value being of **infinite size**.

Other notations which support recursion **natively** overcome this by referring to the **function definition by name**.

https://en.wikipedia.org/wiki/Lambda_calculus#Formal_definition

Recursion (1-2)

Lambda calculus cannot express this:

all **functions** are **anonymous** in lambda calculus,
so we can't refer by name to a **value** which is yet to be defined,
inside the **lambda term** defining that same **value**.

however, a lambda expression can receive itself
as its own **argument**, for example in $(\lambda x.x x) E$.

Here **E** should be an **abstraction**,
applying its **parameter** to a **value** to express **recursion**.



a function receives itself
as its own **argument**

https://en.wikipedia.org/wiki/Lambda_calculus#Formal_definition

Recursion (1-3)

Consider the **factorial function** $F(n)$ **recursively defined** by

$$F(n) = 1, \text{ if } n = 0; \quad \text{else } n * F(n-1).$$

In the **lambda expression** which is to represent the **function** $F(n)$, a **parameter** (typically the first one) will be assumed to receive the **lambda expression** itself as its **value**, so that **calling** it - **applying** it to an **argument** will amount to **recursion**.

https://en.wikipedia.org/wiki/Lambda_calculus#Formal_definition

Recursion (2-1)

Thus to achieve *recursion*,
the *intended-as-self-referencing argument*
(called **r** here) must always be passed to itself
within the *function body*, at a call point:

r r
r r (n-1)

$G := \lambda r. \lambda n. (1, \text{ if } n = 0; \quad \text{else } n \times (r r (n-1)))$

with $r r x = F x = G r x$ to hold,

so $r = G$ and

$F := G G = (\lambda x. x x) G$

fix F = F (fix F)

fix F fixed point **fact**

fix fixed point **combinator**

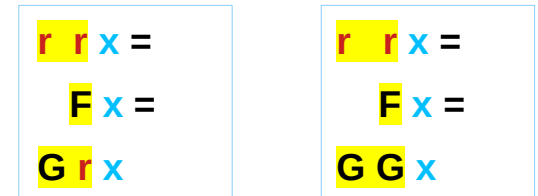

r = G

F = G G = r r

https://en.wikipedia.org/wiki/Lambda_calculus#Formal_definition

Recursion (2-1) – with a self-referencing argument

G is a recursive factorial function

G := $\lambda r. \lambda n. (1, \text{ if } n = 0; \text{ else } n \times (r r (n-1)))$

G must have two arguments

r x

G r x

in the body of **G**, self-referencing argument **r**
must always be passed to **r**, for recursion

r r x

F is the top level function with a single argument

x

F x

with **G r x = r r x = F x** to hold

r = G

F := **G G = ($\lambda x. x x$) G**



r = G

F = G G = r r

https://en.wikipedia.org/wiki/Lambda_calculus#Formal_definition

Recursion (3-1)

The **self-application** achieves **replication** here, passing the function's **lambda expression** on to the next invocation as an **argument value**, making it available to be referenced and called there.

$G := \lambda r. \lambda n. (1, \text{ if } n = 0; \text{ else } n \times (r r (n-1)))$

with $r r x = F x = G r x$ to hold, so $r = G$

This solves it but requires re-writing each **recursive call** as **self-application**.

$r r (n-1)$

https://en.wikipedia.org/wiki/Lambda_calculus#Formal_definition

Recursion (3-2)

$G := \lambda r. \lambda n. (1, \text{ if } n = 0; \text{ else } n \times (r r)(n-1))$

with $r r x = F x = G r x$ to hold, so $r = G$

We would like to have a generic solution,
without a need for any re-writes:

$G := \lambda r. \lambda n. (1, \text{ if } n = 0; \text{ else } n \times (r)(n-1))$

with $r x = F x = G r x$ to hold, so $r = G r =: \mathbf{FIX} G$ and

$r r x =$

$F x =$

$G r x$

$r r x =$

$F x =$

$G G x$

$r = G$

$F = G G = r r$

$r x =$

$F x =$

$G r x$

$r x =$

$F x =$

$G r x$

$r = G r$

$F = G r = r$

https://en.wikipedia.org/wiki/Lambda_calculus#Formal_definition

Recursion (2-1) without a self-referencing argument

G is a recursive factorial function

$G := \lambda r. \lambda n. (1, \text{ if } n = 0; \text{ else } n \times (r (n-1)))$

G must have two arguments

$r \ x$

$G \ r \ x$

in the body of **G**, no self-referencing argument **r**

$r \ x$

F is the top level function with a single argument

x

$F \ x$

with $r \ x = F \ x = G \ r \ x$ to hold

$r = G \ r$

$G \ r \ x =$

$r \ x =$

$F \ x$

$G \ r \ x =$

$r \ x =$

$G \ r \ x$

$r = G \ r$

$F = G \ r$

https://en.wikipedia.org/wiki/Lambda_calculus#Formal_definition

Recursion (3-3)

with $r x = F x = G r x$ to hold, so $r = G r =: \text{FIX } G$ and

$$r = G r$$

$$(\text{FIX } G) = G (\text{FIX } G)$$

$$r = g r$$

$$(\text{FIX } g) = G (\text{FIX } g)$$

Let $r = \text{FIX } G$,

Since $F = r = G r = \text{FIX } G$

$$F = G F$$

$F := \text{FIX } G$ where $\text{FIX } g := (r \text{ where } r = g r) = g (\text{FIX } g)$

$$\text{FIX } G = G (\text{FIX } G) = (\lambda n. (1, \text{ if } n = 0; \text{ else } n \times ((\text{FIX } G) (n-1))))$$

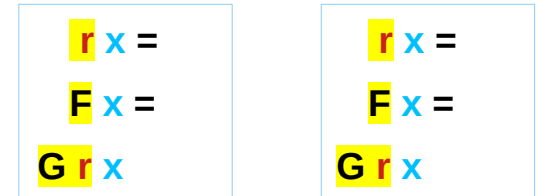

$$r = G r$$

$$F = G r = r$$

$$\text{fix } F = F (\text{fix } F)$$

fix **F** fixed point **fact**

fix fixed point combinator

https://en.wikipedia.org/wiki/Lambda_calculus#Formal_definition

Recursion (3-3)

$$G := \lambda r. \lambda n. (1, \text{ if } n = 0; \text{ else } n \times (r(n-1)))$$

with $r x = F x = G r x$ to hold, so $r = G r =: \text{FIX } G$ and

Let $r = \text{FIX } G$, (thus $F = \text{FIX } G$)

$$(\text{FIX } G) = G (\text{FIX } G)$$

$$(\text{FIX } g) = G (\text{FIX } g)$$

$$r = G r$$

$$r = g r$$

$$F = G F$$

$F := \text{FIX } G$ where $\text{FIX } g := (r \text{ where } r = g r) = g (\text{FIX } g)$

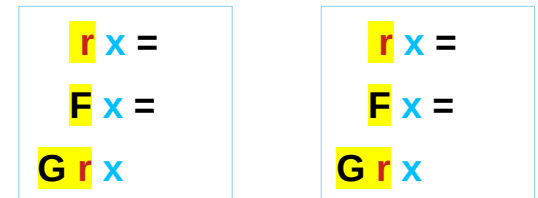
$$\text{FIX } G = G (\text{FIX } G) = (\lambda n. (1, \text{ if } n = 0; \text{ else } n \times ((\text{FIX } G) (n-1))))$$

$$r = G r$$

$$F = G r = r$$

$$\text{fix } F = F (\text{fix } F)$$

fix F fixed point **fact**

fix fixed point **combinator**

https://en.wikipedia.org/wiki/Lambda_calculus#Formal_definition

Recursion (4)

$$\mathbf{FIX\ G = G (FIX\ G) = (\lambda n. (1, \text{if } n = 0; \text{ else } n \times ((\mathbf{FIX\ G}) (n-1))))}$$

Given a **lambda term** with first argument representing **recursive call** (e.g. **G** here), the **fixed-point combinator** **FIX** will return a **self-replicating** lambda expression representing the **recursive function** (here, **F**).

The function does not need to be explicitly passed to itself at any point, for the **self-replication** is arranged in advance, when it is created, to be done each time it is called.

$$\mathbf{FIX\ F = F (FIX\ F)},$$

FIX F fixed point

FIX fixed point combinator

$$\mathbf{FIX\ F = F (FIX\ F) = fact}$$
$$\mathbf{(fact) = F (fact)}$$
$$\mathbf{(fact\ n) = F (fact\ n)}$$
$$\mathbf{F\ f\ n = (IsZero\ n)\ 1}$$
$$\mathbf{\quad\quad\quad (multiply\ n\ (f\ (pred\ n)))}$$

https://en.wikipedia.org/wiki/Lambda_calculus#Formal_definition

Recursion (5)

Thus the original **lambda expression (FIX G)** is **re-created** inside itself, at **call-point**, achieving **self-reference**.

In fact, there are many possible definitions for this **FIX** operator, the simplest of them being:

$$Y := \lambda g.(\lambda x.g (x x)) (\lambda x.g (x x))$$

$$\begin{aligned} Y g &= (\lambda x.g (x x)) (\lambda x.g (x x)) \\ &= g (\lambda x. (x x)) (\lambda x.g (x x)) \end{aligned}$$

https://en.wikipedia.org/wiki/Lambda_calculus#Formal_definition

Recursion (6)

In the lambda calculus, $Y\ g$ is a **fixed-point** of g , as it expands to:

$$\begin{aligned} & Y\ g \\ & (\lambda h.(\lambda x.h\ (x\ x))\ (\lambda x.h\ (x\ x)))\ g \\ & (\lambda x.g\ (x\ x))\ (\lambda x.g\ (x\ x)) \\ & g\ ((\lambda x.g\ (x\ x))\ (\lambda x.g\ (x\ x))) \\ & g\ (Y\ g) \end{aligned}$$

https://en.wikipedia.org/wiki/Lambda_calculus#Formal_definition

Recursion (7)

Now, to perform our recursive call to the factorial function, we would simply call $(Y\ G)\ n$, where n is the number we are calculating the factorial of.

Given $n = 4$, for example, this gives:

$(Y\ G)\ 4$
 $G\ (Y\ G)\ 4$
 $(\lambda r.\lambda n.(1, \text{ if } n = 0; \text{ else } n \times (r\ (n-1))))\ (Y\ G)\ 4$
 $(\lambda n.(1, \text{ if } n = 0; \text{ else } n \times ((Y\ G)\ (n-1))))\ 4$
 $1, \text{ if } 4 = 0; \text{ else } 4 \times ((Y\ G)\ (4-1))$
 $4 \times (G\ (Y\ G)\ (4-1))$

https://en.wikipedia.org/wiki/Lambda_calculus#Formal_definition

Recursion (8)

$4 \times ((\lambda n.(1, \text{if } n = 0; \text{ else } n \times ((Y \ G) (n-1)))) (4-1))$
 $4 \times (1, \text{if } 3 = 0; \text{ else } 3 \times ((Y \ G) (3-1)))$
 $4 \times (3 \times (G (Y \ G) (3-1)))$
 $4 \times (3 \times ((\lambda n.(1, \text{if } n = 0; \text{ else } n \times ((Y \ G) (n-1)))) (3-1)))$
 $4 \times (3 \times (1, \text{if } 2 = 0; \text{ else } 2 \times ((Y \ G) (2-1))))$
 $4 \times (3 \times (2 \times (G (Y \ G) (2-1))))$
 $4 \times (3 \times (2 \times ((\lambda n.(1, \text{if } n = 0; \text{ else } n \times ((Y \ G) (n-1)))) (2-1))))$
 $4 \times (3 \times (2 \times (1, \text{if } 1 = 0; \text{ else } 1 \times ((Y \ G) (1-1))))))$
 $4 \times (3 \times (2 \times (1 \times (G (Y \ G) (1-1))))))$
 $4 \times (3 \times (2 \times (1 \times ((\lambda n.(1, \text{if } n = 0; \text{ else } n \times ((Y \ G) (n-1)))) (1-1))))))$
 $4 \times (3 \times (2 \times (1 \times (1, \text{if } 0 = 0; \text{ else } 0 \times ((Y \ G) (0-1))))))$
 $4 \times (3 \times (2 \times (1 \times (1))))$

24

https://en.wikipedia.org/wiki/Lambda_calculus#Formal_definition

Recursion (9)

Every **recursively defined** function can be seen as a **fixed point** of some suitably defined function closing over the **recursive call** with an extra argument, and therefore, using **Y**, every **recursively defined** function can be expressed as a lambda expression.

In particular, we can now cleanly define the subtraction, multiplication and comparison predicate of natural numbers recursively.

https://en.wikipedia.org/wiki/Lambda_calculus#Formal_definition

Fix-point combinator (4)

Every **recursively defined function** can be seen as a **fixed point** of some **suitably defined function** closing over the **recursive call** with an extra **argument**,

and therefore, using **Y**, every **recursively defined function** can be expressed as a **lambda expression**.

In particular, we can now cleanly define the **subtraction**, **multiplication** and **comparison** predicate of natural numbers recursively.

https://en.wikipedia.org/wiki/Fixed-point_combinator

Fix-point combinator (5)

Applied to a **function** with one variable,
the **Y combinator** usually does not terminate.

More interesting results are obtained
by applying the **Y combinator** to **functions** of two or more variables.

The additional variables may be used as a counter, or index.

The resulting **function** behaves like a **while** or a **for** loop
in an imperative language.

Used in this way, the **Y combinator** implements simple **recursion**.

https://en.wikipedia.org/wiki/Fixed-point_combinator

Fix-point combinator (6)

In the **lambda calculus**, it is not possible to refer to the definition of a **function** inside its own body by name.

Recursion though may be achieved by obtaining the same function passed in as an **argument**, and then using that argument to make the recursive call, instead of using the function's own name, as is done in languages which do support recursion natively.

The **Y combinator** demonstrates this style of programming.

https://en.wikipedia.org/wiki/Fixed-point_combinator

Fix-point combinator (7)

An example implementation of **Y combinator** in two languages is presented below.

```
# Y Combinator in Python
```

```
Y=lambda f: (lambda x: f(x(x)))(lambda x: f(x(x)))
```

```
Y(Y)
```

https://en.wikipedia.org/wiki/Fixed-point_combinator

Iota combinator (1)

It is possible to define a **complete system** using only one (improper) **combinator**.

An example is Chris Barker's **iota combinator**, which can be expressed in terms of **S** and **K** as follows:

$$ix = xSK$$

https://en.wikipedia.org/wiki/SKI_combinator_calculus

Iota combinator (2)

It is possible to reconstruct **S**, **K**, and **I** from the **iota combinator**.

Applying **I** to itself gives $\mathbf{II} = \mathbf{ISK} = \mathbf{SSKK} = \mathbf{SK(KK)}$
 which is functionally equivalent to **I**.

$$\mathbf{Ix} = \mathbf{xSK}$$

$$\mathbf{II} = \mathbf{ISK}$$

$$\mathbf{IS} = \mathbf{SSK}$$

$$\mathbf{II} = (\mathbf{IS})\mathbf{K} = (\mathbf{SSK})\mathbf{K} = \mathbf{SK(KK)}$$

$$\mathbf{II} y = \mathbf{ISK}y = \mathbf{SK(KK)}y = \mathbf{Ky} (\mathbf{KK})y = y \quad \rightarrow \quad \mathbf{II} = \mathbf{I}$$

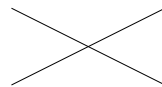

$$\mathbf{Ix} = \mathbf{xSK}$$

$$\mathbf{II} = \mathbf{ISK} \quad \text{and} \quad \mathbf{IS} = \mathbf{SSK}$$

$$(\mathbf{IS})\mathbf{K} = (\mathbf{SSK})\mathbf{K}$$

$$\mathbf{SSKK} = \mathbf{SKKK}$$

$$\mathbf{SKKK} = \mathbf{KKKK} = \mathbf{K}$$

$$\mathbf{K}(\mathbf{K}(\mathbf{KK})) = \mathbf{K}$$

$$\mathbf{II} y = \mathbf{ISK}y = \mathbf{SK(KK)}y = \mathbf{Ky} (\mathbf{KK})y = y$$

$$\mathbf{SK} x y = \mathbf{Ky} (x y) = y$$

$$\mathbf{I} y = y$$

https://en.wikipedia.org/wiki/SKI_combinator_calculus

Iota combinator (3)

K can be constructed by applying I twice to I ($= II$)
(which is equivalent to application of I to itself):

$$I(I(II)) = I(II SK) = I(ISK) = I(SK) = SKSK = K.$$

$$\begin{aligned} I(I(II)) &= I(II SK) \\ &= I(ISK) && \leftarrow II = I \\ &= I(SK) \\ &= (SK)SK \\ &= K \text{ } \textcircled{K} \text{ } SK \\ &= K \end{aligned}$$

$$IX = xSK$$

$$II = ISK$$

$$IS = SK$$

$$II = (IS)K = (SK)K = SK(KK)$$

$$II = I(SK) = (SK)SK = K \text{ } \textcircled{K} \text{ } SK = K$$

https://en.wikipedia.org/wiki/SKI_combinator_calculus

Iota combinator (4)

K can be constructed by applying **I** twice to **I** (= **II**)
(which is equivalent to application of **I** to itself):

$$I(I(II)) = I(II SK) = I(ISK) = I(SK) = SKSK = K.$$

Applying **I** one more time to **I(I(II))** gives

$$I(I(I(II))) = IK = KSK = S$$

$$IX = xSK$$

$$II = ISK$$

$$IS = SSK$$

$$II = (IS)K = (SSK)K = SK(KK)$$

$$\begin{aligned} I(I(II)) &= I(II SK) \\ &= I(ISK) \\ &= I(SK) \\ &= (SK)SK \end{aligned}$$

$$IX = xSK$$

$$II = I$$

$$III = K$$

$$IIII = S$$

https://en.wikipedia.org/wiki/SKI_combinator_calculus

Improper Combinator

Improper combinators, meaning that they are expressed in terms of other combinators rather than pure abstractions.

To be precise: in lambda calculus a proper combinator is an expression of the form $(\lambda.x_1x_2\dots P(x_1,x_2,\dots))$, where $P(x_1,x_2,\dots)$ only has x_1, x_2 etc. as free variables, and does not contain any abstractions.

So for example, $(\lambda xyz.x(zz))$ is a proper combinator, but $(\lambda x.x(\lambda y.y))$ is not, because it contains x applied to a lambda term.

<https://cs.stackexchange.com/questions/57507/basis-sets-for-combinator-calculus>

References

- [1] <ftp://ftp.geoinfo.tuwien.ac.at/navratil/HaskellTutorial.pdf>
- [2] <https://www.umiacs.umd.edu/~hal/docs/daume02yaht.pdf>