

2023-2024 OFFICIAL
RULES OF
BASEBALL



WBSC



2023-2024 OFFICIAL RULES OF BASEBALL

THIS IS THE WBSC OFFICIAL RULES OF BASEBALL, PUBLISHED BY THE WORLD BASEBALL SOFTBALL CONFEDERATION (WBSC). ITS APPLICATION IS COMPULSORY IN ALL WBSC COMPETITIONS.

ANY REFERENCE IN THESE WBSC OFFICIAL RULES OF BASEBALL TO "HE," "HIM" OR "HIS" SHALL BE DEEMED TO BE A REFERENCE TO "SHE," "HER" OR "HERS," AS THE CASE MAY BE, WHEN THE PERSON IS A FEMALE.

INDEX

CHAPTER 1	INTRODUCTION	9
RULE 1	OBJECTIVES	10
RULE 2	PLAYING FIELD	10
2.1	Infield and Outfield Dimensions	10
2.2	Home Plate	12
2.3	First, Second and Third Bases	12
2.4	Pitcher's Rubber	12
2.5	Pitcher's Mound	12
2.6	The Catcher's Box, the Batters' Box, etc.	12
RULE 3	EQUIPMENT	13
3.1	The Ball	13
3.2	The Bat	13
3.3	Players Uniforms	14
3.4	Gloves	15
3.5	Protective Equipment	16
3.6	Equipment on the Field	17
RULE 4	GAME PERSONNEL	17
4.1	Umpires	17
4.2	Field Manager	18
4.3	Coaches	19
RULE 5	PRE-GAME PROCEDURES	19
5.1	Field Condition	19
5.2	Pre-game Practice	20
5.3	Pre-game Meeting	21
5.4	Ground Rules	21
5.5	Exchange of Line-up Cards	21
5.6	Security	22
CHAPTER 2	GLOSSARY	23
RULE 6	DEFINITION OF TERMS	24
CHAPTER 3	BASEBALL RULES	37
RULE 7	GAME: BEGINNING AND ENDING	38
7.1	Starting the Game	38
7.2	Positions of the Offensive Team	38
7.3	Team Offensive Interference	38
7.4	Base Coaches	39
7.5	Positions of the Defensive Team	39
7.6	Substitutions	40
7.7	Regulation Game	42
7.8	Halted Game (Suspended, Postponed, and Tie Games)	44
7.9	Tie Game	45

7.10	No Game	45
7.11	Forfeited Game	45
7.12	Protested Game	46
7.13	Fight Rule	47
RULE 8	BALL IN PLAY	48
8.1	Live Ball	48
8.2	Immediate Dead Ball - Runners Return	50
8.3	Delayed Dead Ball - Runners Return or Advance	51
8.4	Immediate Dead Ball - Runners Advance	52
8.5	Calling Time and Dead Balls	53
8.6	Unsportsmanlike Conduct	54
RULE 9	BATTING	55
9.1	Batting Order	55
9.2	A Batter	55
9.3	Designated Hitter	55
9.4	The Batter's Box	58
9.5	The Batter's Box Rule	58
9.6	A Ball	59
9.7	Batter Illegal Action	60
9.8	Batting Out of Turn	61
9.9	Catcher Interference	62
9.10	When Batter-Runner is Out	63
RULE 10	BASE RUNNING	65
10.1	Legal Order of Bases	65
10.2	Batter Becomes Base Runner	66
10.3	Entitled to Bases or Occupying a Base	68
10.4	Advancing Bases	69
10.5	Dead Balls	71
10.6	Force Play-Slide Rule (Sliding to Bases on Double Play Attempts)	73
10.7	When Runners are Out	74
RULE 11	APPEAL PLAYS	77
11.1	When Runners are Out on Appeals	77
11.2	Effect of Preceding Runner's Failure to Touch a Base	80
11.3	Retiring the Side	80
RULE 12	INTERFERENCE, OBSTRUCTION AND CATCHER COLLISIONS	80
12.1	Batter or Runner Interference	80
12.2	Fielder Right of Way	83
12.3	Unintentional Interference	83
12.4	Spectator Interference	84
12.5	Umpire or Coach Interference	85
12.6	Interference with Squeeze Play or Steal of Home	85
12.7	Obstruction	85
12.8	Collision Rule	88

RULE 13	PITCHING	90
13.1	Pitching Positions	90
13.2	Legal Pitching Positions	90
13.3	Windup Position - Set Position	90
13.4	Warm-Up Pitches	92
13.5	Pitch Clock	92
13.6	Pitching Violations (Prohibitions)	94
13.7	Throwing to the Bases	96
13.8	Effect of Removing Pivot Foot from Plate	97
13.9	Ambidextrous Pitchers	97
13.10	Balks	97
13.11	Removing Pitcher	100
RULE 14	THE UMPIRE	104
14.1	Umpire Authority	104
14.2	Appeal of Umpire Decisions	105
14.3	Umpire Position	106
14.4	Reporting	107
14.5	General Instructions to Umpires	108
CHAPTER 4	SCORING	110
RULE 15	OFFICIAL SCORER	111
15.1	Scoring Director	111
15.2	Scorer	111
15.3	Game Over	113
15.4	Reports	114
RULE 16	BATTING RECORD	115
16.1	Batter Out of Turn	115
16.2	Hits	115
16.3	Extra Base Hits	117
16.4	Games Ended by Hit	119
16.5	The Sacrifices	120
16.6	Runs Batted In (RBI)	121
16.7	Stolen Bases and Caught Stealing	122
16.8	Bases on Balls	125
16.9	Strikeouts	126
RULE 17	FIELDING RECORD	126
17.1	Putouts	126
17.2	Assists	128
17.3	Errors	130
17.4	Double Plays and Triple Plays	134
17.5	Wild Pitches and Passed Balls	135
RULE 18	PITCHING RECORD	136
18.1	Work of the Pitchers	136
18.2	Pitchers' Decision	136

18.3	Earned Runs and Allowed Runs	139
18.4	Substitution of Pitchers and Runs Allowed	142
RULE 19	STATISTICS	146
19.1	Responsibilities	146
19.2	Preparation of Reports	147
19.3	Games Played	151
19.4	Extra Games	151
19.5	Individual Awards	152
19.6	Averages	152
19.7	Minimum Requirements to Qualify for Individual Prizes	153
19.8	Recording Cumulative Records	155
APPENDIX 1	WBCS BASEBALL WORLD CUPS	156
A1	BASEBALL RULES	157
A1.1	Designated Hitter	157
A1.2	Innings	157
A1.3	Protective Equipment	157
A1.4	Run Difference	157
A1.5	Exceptions to the WBCS Official Rules of Baseball	160
A1.6	Suspended Games	160
A1.7	Bat Regulations	162
A1.8	Pitch Count Limits at WBCS World Cups	164
A2	SCORING RULES	169
A2.1	Forfeited Games	169
A2.2	Winning Pitcher	169
A2.3	Pitchers Earned Run Average Coefficient	169
A2.4	Minimum Plate Appearance Coefficient	169
A2.5	Minimum Inning Pitched Coefficient	170
A3	OTHER MATTERS	170
A3.1	Electronic Devices	170
A3.2	Smoking or Smokeless Tobacco	170
APPENDIX 2	UMPIRE VIDEO REVIEW PROTOCOL & REGULATION	171
B1	GENERAL GUIDELINES	172
B2	REVIEWABLE CALLS FOR MANAGERS CHALLENGE	172
B2.1	Base Running	172
B2.2	Catch/No Catch Play	172
B2.3	Fair/Foul	173
B2.4	Force Plays	173
B2.5	Hit by Pitch	173
B2.6	Potential Home Run	173
B2.7	Collision Rule	173
B2.8	Non-Home Run Boundary	173
B2.9	Slide Rule	174
B2.10	Tag Plays	174



B3	REVIEWABLE CALLS BY CREW CHIEF INITIATIVE	175
B3.1	Challenge Protocol	175
B3.2	General Guidelines	176
B3.3	Challenge of a Reviewable Play by Both Managers	177
B3.4	Effect of Video Review Result on Post-Play Decision by Manager	180
B3.5	Specificity of the Challenge	180
B3.6	Irrevocable and Final	181
B3.7	Standard for Changing a Call	181
B3.8	Correcting an Incorrect Call	182
B3.9	Placement of Runners	182
B3.10	Base Running	184
B3.11	Hit by Pitch	184
B3.12	Collisions at Home Plate	185
B3.13	Plays NOT Reviewable	185
APPENDIX 3	GAME MANAGEMENT CLOCKS REGULATION	186
C1	PITCH CLOCK	187
C2	COACH / MANAGER PITCHER'S VISIT CLOCK	188
C3	PITCHING CHANGE CLOCK	189
C4	BETWEEN INNING CLOCK	190
C5	CLOCK INSTALLATION REQUIREMENTS	191
C5.1	Placement of Game Management Clocks	192
APPENDIX 4	DIAGRAM	193
D1	PLAYING FIELD	194
D1.1	For U-15 and above	194
D1.2	For U-15 and above (Metric)	195
D1.3	For U-12 Category	196
D1.4	For U-12 Category (Metric)	197
D2	HOME PLATE & BASES	198
D2.1	For U-15 and above	198
D2.2	For U-15 and above (Metric)	199
D2.3	For U-12 Category	200
D2.4	For U-12 Category (Metric)	201
D3	PITCHING MOUND	202
D3.1	For U-15 and above	202
D3.2	For U-15 and above (Metric)	203
D3.3	For U-12 Category	204
D3.4	For U-12 Category (Metric)	205
D4	FIELDERS GLOVE	206
D5	STRIKE ZONE	207
APPENDIX 5	CROSS REFERENCE	208

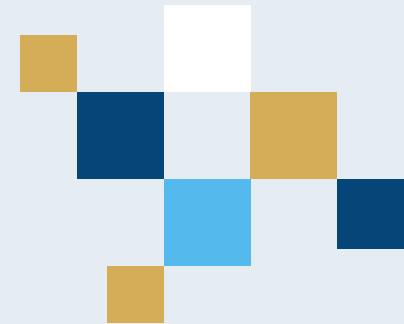

CHAPTER 01. INTRODUCTION



RULE 1. OBJECTIVES

- 1.1** The offensive team's objective is to have its batter's become runners and its runners advance to home plate.
- 1.2** The defensive team's objective is to prevent players from becoming runners and to prevent their advancement around the bases.
- 1.3** When a batter becomes a runner and touches all bases legally, that individual shall score one run for his team.
- Exception:** A run does not score if a runner touches home plate while the third out is made.
- 1.4** The objective of each team is to win by scoring more runs than the opposing team.
- 1.5** The winner of the game is the team which has scored more runs in accordance with the rules at the end of the game.

RULE 2. PLAYING FIELD

2.1 INFIELD AND OUTFIELD DIMENSIONS

- 2.1.1** The infield shall be a 90-foot square (27.43 m²). The measurement to first and third bases is to the back edge of each base and the apex or back point of home plate.
- 2.1.2** The outfield shall be the area between two foul lines formed by extending two side of the square. The distance from the apex of home plate to the nearest fence, stand or other obstruction on fair territory shall be 275 feet (83.82 m) or more to each foul pole. The distance to both right and left centre field should be 375 feet (114.30 m), 400 feet (121.92 m) to straightaway centre field. The foul poles should be painted a fluorescent yellow.
- 2.1.3** The following field dimensions shall be used for the WBSC Baseball World Cups as specified below:

WBSC BASEBALL WORLD CUPS OFFICIAL FIELD DIMENSIONS	U-12	U-15	U-18	U-23	WOMEN'S
Distance between bases	75 ft (22.86 m)	90 ft (27.43 m)			
Distance from home plate to pitcher plate	51 ft (15.54 m)	60 ft 6" (18.43 m)			
Distance from home plate to second base	97 ft 5" (29.70 m)	127.3 ft 3/8" (38.79 m)			
Distance from home plate to backstop	25 ft (7.62 m)	60 ft (18.29 m)			
Distance from home plate to next batter's box	15.4 ft (4.70 m)	37 ft (11.27 m)			
Three-foot lane	35 ft (10.66 m)	45 ft (13.71 m)			
Distance from home plate to left and right field fence	220 ft (67 m)	325 ft (99 m)	min. 275 ft (83.82 m) max. 290 ft (88.40 m)		
Distance from home plate to centre field fence	270 ft (82.30 m)	400 ft (121.90 m)	min. 340 ft (103.63 m) max. 360 ft (109.73 m)		
Outfield fence height	min. 3.5 ft (1.06 m) max. 6 ft (1.83 m)	6 ft (1.83 m)	min. 3.5 ft (1.06 m) max. 6 ft (1.83 m)		
Radius	74 ft (22.55 m)	95 ft (28.95 m)			
Pitching mound height	6" (0.15 m)	10" (0.25 m)			
Pitching mound diameter	14 ft (4.27 m)	18 ft (5.48 m)			
Batter's box dimensions	3 ft (0.91 m) x 6 ft (1.82 m)	4 ft (1.22 m) x 6 ft (1.83 m)			
Home plate circle diameter	20.22 ft (6.16 m)	26 ft (7.92 m)			
Pitcher plate dimensions	6" x 2 ft (0.15 m x 0.60 m)				
Bases dimensions	15" x 15" x 5" (0.38 m x 0.38 m x 0.12 m)				
Coach's box dimensions	4 ft x 8 ft (1.21 m x 2.43 m)	10 ft x 20 ft (3 m x 6 m)			

2.2 HOME PLATE

Home plate shall be marked by a five-sided slab of whitened rubber or similar material. One edge is 17 inches (0.43 m) long, two are 8 1/2 inches (0.21 m) and two are 12 inches (0.3 m). It shall be set in the ground so that the two 12-inch (0.3 m) edges coincide with the diamond lines extending to home plate from first base and third base and with the 17-inch (0.43 m) edge facing the pitcher. The top edges of home plate shall be bevelled, and the base shall be fixed in the ground level with the ground surface.

2.3 FIRST, SECOND AND THIRD BASES

First, second and third base shall be white canvas bags, or rubber covered bags, securely attached to the ground. The bags shall be 15 inches square (0.38 m²) filled with soft material minimum of 3 inches (0.07 m) and not more than 5 inches (0.12 m). The first and third base bags shall be entirely within the infield. The second base bag shall be centred on second base.

2.4 PITCHER'S RUBBER

The pitcher's rubber is a rectangular whitened rubber slab. 24 inches (0.6 m) by 6 inches (0.15 m), set in the ground with the nearest edge at a distance of 60 feet 6 inches (18.44 m) from the back point of home plate.

2.5 PITCHER'S MOUND

The top of the pitcher's rubber must be 10 inches (0.25 m) above the top surface of home plate. The 10-inch (0.25 m) height can be measured easily using a line level. There should be a gradual slope of 1 inch (0.03 m) per foot from a point 6 inches (0.15 m) in front of the pitcher's rubber to a point 6 feet (1.83 m) toward home plate. From this point the mound should slope and blend into the grade of the rest of the playing surface.

Note: Portable pitcher's mound are legal.

2.6 THE CATCHER'S BOX, THE BATTERS' BOX, ETC.

The catcher's box, batters' box, coaches' boxes and the three foot batter runners' lane shall be laid out before the start of the game in accordance with the Appendix 4. All lines must be marked with chalk or nonburning white material and must be 2 to 3 inches (0.05 m - 0.07 m) wide.

RULE 3. EQUIPMENT**3.1 THE BALL**

The ball shall be a sphere formed by yarn wound around a small core of cork, rubber, or similar material, covered with two strips of white horsehide or cowhide, tightly stitched together. It shall weigh not less than 5 ounces (0.14 kg) and not more than 5 1/4 ounces (0.15 kg) and measure no less than 9 inches (0.22 m) and no more than 9 1/4 inches (0.24 m) in circumference.

No player, coach or manager shall discolour or damage the ball by rubbing it with soil, rosin, licorice, sandpaper, emery paper or any other foreign substance.

Penalty: The Umpire will remove the ball and the offender from the game. In addition, the offender will be suspended automatically for 10 games.

3.2 THE BAT

3.2.1 The bat shall be made of wood or of other materials as it complies with the WBCS specifications as written in this rule.

3.2.1.1 It shall be a smooth, rounded stick with a constant radius at any point.

3.2.1.2 There must be a direct line from the centre of the knob to the centre of the large end.

3.2.1.3 The knob and the end plug, if any, must be firmly attached.

3.2.1.4 The bat shall not be more than 42 inches (1.06 m) of length.

3.2.1.5 The diameter of a bat shall not be more than 2 5/8 inches (0.06 m), nor less than 2 1/4 inches (0.05 m).

3.2.1.6 The bat handle may be covered or treated with any material or substance to improve the grip but must not exceed more than 18 inches (0.45 m) from its end. Any such material or substance that exceeds the 18-inch (0.45 m) limit shall be cause for the bat to be removed from the game.

Note: A non approved bat must be removed. Any bat that has been altered shall be removed from play. If the Umpire discovers that the bat does not conform to Rule 3.2.1.6 above until a time or after which the bat has been used in play, it shall not be grounds for declaring the batter out or ejected from the game.

Penalty: If a batter entering the batter's box is discovered with non approved bat or is discovered having used non approved bat prior to the next player entering the batter's box, the plate Umpire has to warn the manager of the offensive team in case it would be the first violation. At the second violation the manager of the team will be ejected from the game.

3.2.2 The players can only use one-piece wooden bats that are included in the Official WBSC approved wood bat list published in the current year.

3.2.3 Use of composite bats is prohibited (composite bats refer to wood bats wrapped with fiberglass or other components or a combination of pieces rather than one solid piece of wood- these bats are not permitted to be used).

3.3 PLAYERS UNIFORMS

3.3.1 The uniforms of all participating players, coaches and manager of the team shall be of the same colour and style.

3.3.2 It is required that each team have two sets of uniform jerseys of contrasting colours. It is the responsibility of the visiting team to wear a contrasting uniform colour to the jersey worn by the home team. It is recommended that both teams wear the full pregame or regular game uniforms when entering the playing field.

3.3.3 All uniforms must include numbers on the back of the shirt. These numbers shall be at least 6 inches (0.15 m) in height.

3.3.4 Except for the standard shoe plate or toe plate, no player shall attach anything to the sole or heel of the shoe. Shoes with pointed metal spikes like golf or track shoes, shall not be allowed.

3.3.5 Polished metal or glass buttons are not allowed on a uniform. If a pitcher wears a helmet, it must have a nonglossy finish.

3.3.6 Any part of an undershirt exposed to view shall be of the same solid colour other than white. Sleeve lengths may vary for everyone, but each player must wear sleeves of approximately the same length (torn or ragged sleeves are not allowed). Compression type sleeves, if worn by a pitcher, must be covered by an undershirt, or worn on both arms.

3.3.7 A player or coach may wear a jacket under the uniform top if it is the same colour as the team's undershirts. Only a pitcher may wear a jacket as an outer garment while as a base runner. When worn, it is to be buttoned or zipped. A pitcher may wear a jacket under the uniform top while batting. No other player is permitted to wear a jacket as the outer garment while serving as a base runner or a defensive player.

3.3.8 When coaching the bases, the uniform game jersey must be worn. If a team jacket or wind shirt is worn, it must include the team's official logo and be consistent with the team's uniform colour and apparel. If both coaches opt to wear a jacket, the jackets must be uniform. At all other times, coaches are allowed to wear a team issued jacket or wind shirt.

3.3.9 No player whose uniform does not conform to that of his teammates shall be permitted to participate in a game.

3.3.10 No player shall attach to his uniform tape or other material of different colour from his uniform.

3.4 GLOVES

3.4.1 The catcher may wear a glove or mitt of any dimension.

3.4.2 The first baseman's glove or mitt must not be more than 13 inches (0.33 m) long or 8 inches (0.2 m) wide. The webbing shall not be constructed to form a net type of trap. The length measurement of any glove or mitt shall be from the bottom edge or heel straight up across the palm. The width measurement for the first baseman's mitt shall be from the centre of the base section between the thumb and the first finger to the outside edge of the little finger.

The crotch area for the first baseman's mitt shall not exceed 5 inches (0.12 m) in length, 4 1/2 inches (0.11 m) in width at the top and 3 1/2 inches (0.08 m) at the base.

3.4.3 Every player except the catcher and first baseman is restricted to the use of a fielder's glove not more than 13 inches (0.33 m) long and not more than 8 inches (0.2 m) wide. For the fielder's glove the measurement shall be from the base of the inside seam of the first finger to the outside edge of the little finger. These measurements shall not exceed 5 3/4 inches (0.14 m) in width at the top and 3 1/2 inches (0.08 m) at the base.

3.4.4 The pitcher's glove may not be white or grey, exclusive of piping nor, in the judgement of the Umpire, be distracting in any way.

3.4.4.1 No pitcher shall attach to his glove any foreign material of a colour different from the glove.

3.4.4.2 The Umpire shall remove from the game any glove that violates Rule 3.4.4, either on his own initiative or at the recommendation of another Umpire or upon complaint of the opposing manager that the Umpire agrees has merit.

3.5 PROTECTIVE EQUIPMENT

3.5.1 Double ear flap helmets are mandatory for the hitters and base runners, and it is also recommended that base coaches wear the skull caps. For catchers including warm-up and bullpen catchers wearing protective gear is required.

Note: The skull caps for coaches is not required, only recommended.

3.5.2 All catchers must wear a protective helmet and face mask while catching.

3.5.3 All bat/ball boys shall wear a double ear flap protective helmet.

3.5.4 Single ear flap is acceptable for the U-23, Premier 12 and Olympics.

3.5.5 Elbow pads. A player is permitted to wear one elbow protection pad that does not exceed 10 inches (0.25 m) in length, as measured when the pad is lying flat.

3.6 EQUIPMENT ON THE FIELD

No Equipment shall be left lying on the field, either in fair territory or foul territory.

RULE 4. GAME PERSONNEL

4.1 UMPIRES

Umpire responsibilities before the game shall be:

4.1.1 Require strict observance of all rules governing the game and equipment of players.

4.1.2 Be sure that all playing lines are clearly marked in accordance with the rules.

4.1.3 Receive from the home team or Local Organising Committee (LOC) a supply of regulation baseballs. The Umpires shall inspect the baseballs and ensure that they are properly rubbed so that the gloss is removed. The Umpires shall be the sole judge of the balls to be used in the game.

4.1.4 Make sure that the home team or LOC have at least one dozen regulation baseballs in reserve if needed.

4.1.5 The plate Umpire should have at least two baseballs in his possession and make sure that there is a supply to replenish if needed. Such balls shall be put in play when:

4.1.5.1 A ball has been batted out of the playing field or into the spectator area.

4.1.5.2 A ball has become discoloured or unfit for further use.

4.1.5.3 The pitcher requests a new ball.

4.1.5.4 A ball has been thrown into the stands.

Note: The Umpire should not give a new ball to the pitcher or player until all play has ended and the previously play is dead. After a thrown ball or batted ball goes out of the playing field, play will not be resumed until the runners have reached



their respective bases to which they are entitled. After a home run has been hit out of the playing area, the Umpire shall not deliver a new ball to the pitcher or the catcher until the batter that hit the home run has crossed the plate.

- 4.1.6 Umpires will make sure that an official rosin bag is placed on the ground behind the pitcher's rubber prior to the start of each game.
- 4.1.7 Before the start of the game, the Umpires shall check the condition of the field.
- 4.1.8 The home plate Umpire shall order the playing field lights turned on whenever in his opinion darkness makes further play dangerous.
- 4.1.9 Umpires will attempt to have them turned on at the top of an inning to be fair to both teams, if possible.

Note: Consideration will be given by the Umpire to have the lights turned on to begin an inning where possible.

Note: All delegation and federation personnel with field, dugout and clubhouse credentials should follow all World Baseball Softball Confederation (WBSC) rules and regulations and leave the playing field sixty (60) minutes prior to the scheduled game time. Not following these rules shall result in that person losing their respective credential privileges and the federation being disciplined by the WBSC.

4.2 FIELD MANAGER

- 4.2.1 The field manager is the person appointed by the federation or team and confirmed at the Tournament Technical Meeting or by the league, and he is responsible for the team's actions on and off the field. This person will also represent the team in the technical meeting and communications with the Umpires, Technical Commissioners, and the opposing team.
- 4.2.2 The manager may advise the crew chief that he has delegated specific duties prescribed by the rules to a player or coach, and any action of such designated representative shall be official. The manager will always be responsible for his team's conduct, observance of the rules and deference to the Umpires, Technical Commissioners, and all event staff.



- 4.2.3 The field manager shall be the only person allowed to argue, challenge, or protest an Umpire's call.
- 4.2.4 If a manager has been ejected or leaves the field, he shall designate a coach or player as his substitute, and that substitute manager shall have the same responsibilities and duty of the manager.
- 4.2.5 If the manager fails or refuses to designate his substitute before leaving, the crew chief shall designate a team member as the substitute manager.

4.3 COACHES

- 4.3.1 The coaches under the field manager shall be persons appointed by the federation or team to assist the field manager in responsibilities with the team's conduct during competition play and off the field, observance of the WBSC Official Rules of Baseball and deference to the Umpire and Technical Commissioners.
- 4.3.2 An assistant coach is a person who assists the manager. The assistant coach is ineligible to compete as a player. Assistant coaches may not leave their position, dugout, or bullpen area to appeal any play on the field.
- 4.3.3 At no time will a coach or team delegate be allowed to argue, challenge, or protest an Umpire's call on the field. All on field issues concerned with arguments, challenges and protested calls shall not be handled by coaches unless appointed by an ejected manager or non-present manager.

RULE 5. PRE-GAME PROCEDURES

5.1 FIELD CONDITION

The home team or for a tournament the Technical Commissioners shall decide whether a game is delayed because of unsatisfactory conditions of weather or playing field.

Should bad weather or unfit conditions prevail during a game, the crew chief may consult with the Technical Commissioners





to determine suspension, resumption, or termination of play. In case of lightning, the Technical Commissioners and crew chief will consult with any lightning guidelines from the LOC or league.

The Umpires shall not call the game until at least 30 minutes after they have suspended play. If it is a tournament game, the Technical Commissioners will determine when to suspend or cancel a game.

5.2 PRE-GAME PRACTICE

5.2.1 If batting practice is scheduled and the field is deemed playable by the Technical Commissioners, the visiting team must be allowed a minimum of 40 minutes of batting practice on the game field, assuming satisfactory weather and field conditions.

5.2.2 A pitching screen must be provided by the LOC or home team.

5.2.3 It is recommended that the LOC or home team provide a batting cage.

5.2.4 It is recommended that a screen 8 feet (2.44 m) high and 6 feet (1.83 m) wide be provided for the first base area during batting practice.

5.2.5 Each bullpen must be provided with a minimum of two mounds with regulation pitching rubbers and home plates and be in good condition for pregame warmup for the visiting team.

5.2.6 Pre-Game Rundown:

- 5.2.6.1** U-12 Baseball World Cup
- 20 minutes home team BP
 - 20 minutes visiting team BP
 - 10 minutes home team infield
 - 10 minutes visiting team infield

- 5.2.6.2** U-15 Baseball World Cup
- 30 minutes home team BP
 - 30 minutes visiting team BP
 - 10 minutes home team infield
 - 10 minutes visiting team infield

5.2.6.3 U-18, U-23, Women's Baseball World Cups and Premier12

- 40 minutes home team BP
- 40 minutes visiting team BP
- 10 minutes home team infield
- 10 minutes visiting team infield

5.3 PRE-GAME MEETING

5.3.1 Ten minutes before the scheduled starting time, the plate Umpire will conduct the pregame meeting with the representatives of the two teams

5.3.2 The Plate Umpire will receive from the home team and visiting team their respective batting orders in triplicate. The Umpire will make sure that the copies are identical, keep one copy, give one copy to the opposing manager, and give one copy to the Technical Commissioners. The Umpire now is officially in charge of the game, and the line-ups are official.

5.3.3 The plate Umpire will then go over the ground rules and any rules questions asked by the managers.

5.4 GROUND RULES

A local ground rule may be adopted where unusual conditions prevail if agreeable with the visiting team. No ground rule shall conflict with the official playing rules. Whenever the teams do not agree, ground rules shall be determined by the Umpires. It is recommended that ground rules be posted in each dugout.

5.5 EXCHANGE OF LINE-UP CARDS

Unless the home team or LOC have given previous notice that the game has been postponed or delayed in starting the Umpires will enter the playing field ten minutes before the scheduled time for the game to begin and will proceed directly to home plate. Both opposing managers will also be at the home plate meeting. In sequence:

5.5.1 First, the home manager shall give his batting order to the plate Umpire in triplicate.

5.5.2 Second, the visiting manager shall give his batting order to the plate Umpire in triplicate.





5.5.3 The line-up shall include the name, uniform number, and field position of each player in the starting line-up plus the pitcher. If, a designated hitter (DH) is to be used, the line-up card shall designate which hitter is to be the designated hitter. All other potential substitute players should also be listed, but the failure to list a player shall not make that player ineligible to enter the game.

5.6 SECURITY

The responsibility for crowd control rests with the Home Team or Local Organising Committee (LOC). No person shall be allowed on the playing field during a game except players and coaches in uniform, managers, news photographers authorised by the home team or WBSC, Umpires, police officers and other employees of the home team or WBSC or the LOC. Profanity, racial comments or other intimidating actions directed at officials, players coaches or other team representatives will not be tolerated. Individuals making such remarks may be removed from the site of competition.

The home team or LOC shall provide police protection sufficient to preserve order. If a person, or persons enter the playing field during a game or interfere in any way with the play, the visiting team may refuse to play until the field is cleared.

If the field is not cleared in a reasonable amount of time, approximately 15 minutes after the team's refusal to play, the crew chief may forfeit the game.

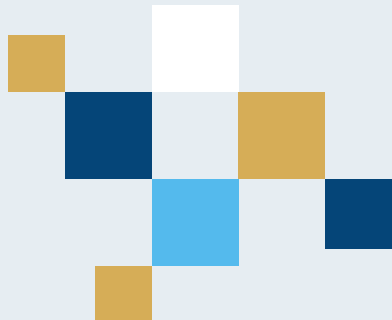

CHAPTER 02.

GLOSSARY

RULE 6. DEFINITION OF TERMS

- 6.1 APPEAL:** The act of a manager, coach or player claiming a violation of the rules by the opposing team.
- 6.2 BALK:** An illegal act by the pitcher with runners on base. Penalty is all runners advance one base.
- 6.3 BALL:** A pitch that does not enter the strike zone in flight. If the pitch touches the ground and bounces through the strike zone it is a "ball."
- 6.4 BASE:** One of four points that must be touched by a runner in order to score a run. More usually applied to the canvas bags except for the rubber home plate.
- 6.5 BASE COACH:** A team member or a coach in uniform who is stationed in the coach's box at first and third.
- 6.6 BASE ON BALLS:** Is an award of first base granted to the batter who while at bat receives four pitches outside the strike zone. Also awarded when the opposing manager signals to the home plate Umpire for an intentional walk.
- 6.7 BATTER:** The offensive player positioned in the batter's box.
- 6.8 BATTER-RUNNER:** A term that identifies the offensive player who has just finished his turn at bat and has either been put out or reached base safely before the play ends.
- 6.9 BATTER'S BOX:** The area where the batter is positioned for his turn at bat.
- 6.10 BATTERY:** The term used when referring to the pitcher and the catcher.
- 6.11 BENCH OR DUGOUT:** The area reserved for each team personnel in proper uniform involved in the game.
- 6.12 BULLPEN:** An area in foul territory or outside the playing field where substitute pitchers and catchers and other players warmup. It must have two regulation mounds and home plate. Facilities should be the same for both teams. Pitchers should warmup in the designated area not on the playing field.
- 6.13 BUNT:** A batted ball not swung at, but intentionally met with the bat and tapped slowly within the infield. If the attempt to bunt results in a foul ball that is not legally caught, it is a strike.
- 6.14 CALLED GAME:** A game in which for any reason the Umpire in chief terminates play.
- 6.15 CATCH:** A ball in flight, is caught, when a fielder has held the ball long enough to show complete control. If a fielder makes a catch but drops the ball when he is attempting a throw, it is still considered a catch. If the fielder ends up with secure possession of the ball even if it has been touched or juggled by another fielder as long as it has not touched a member of the offensive team, or Umpire. This is considered a catch. It is not a catch if the fielder is touching dead ball territory when he makes the catch.
- 6.16 CATCHER:** The fielder who takes his defensive position back of home plate.
- 6.17 CATCHER'S BOX:** It is the area where the catcher shall stand until the pitcher delivers the pitch.
- 6.18 COACH:** A team member in uniform appointed by the manager to perform such duties as the manager may designate, such as but not limited to acting as a base coach.
- 6.19 DEAD BALL:** A ball out of play. A dead ball stops the game, and no plays can happen or take place until the Umpire resumes the game.
- 6.20 DEFENCE OR DEFENSE:** The team or any player of the team on the field.
- 6.21 DESIGNATED HITTER:** The designated hitter is a player who bats in place of the pitcher. The designated hitter does not play in the field. The designated hitter can also be the Pitcher/Designated Hitter (P/DH) and stay as a DH if removed from the mound. He can

also stay as the pitcher if he is pinch hit for. See Rule 9.3

- 6.22 DISQUALIFIED PLAYER:** A player who no longer is eligible to participate in the game but has not been ejected. For example, injured player, or substituted player.
- 6.23 DOUBLE PLAY:** A play by the defence in which two offensive players are put out as a result of continuous action, providing there is no error between putouts.
- 6.23.1** A force double play is one in which both putouts are force plays.
- 6.23.2** A reverse double play is one in which the first out is a force play and the second out is made on a runner for whom the force is removed by reason of the first out.
- Example:** Runner on first base, one out. Batter grounds to first baseman who steps on the bag (one out) and throws to second baseman or shortstop for the second out (tag Play).
- Bases loaded, no outs. Batter grounds to third baseman who steps on the bag (one out) then throws to catcher for the second out (tag play).
- 6.24 DOUBLEHEADER:** Two regularly scheduled or rescheduled games, played in immediate succession.
- 6.25 EJECTION:** The immediate removal of a player, manager, or team personnel from any further participation from the current game. The game officials have the authority to eject a player, manager, or team personnel for misconduct or unsportsmanlike action.
- 6.26 FAIR BALL:** A fair ball is a legally batted ball that:
- 6.26.1** Settles on fair ground between home plate and first base or between home plate and third base.
- 6.26.2** Is on or over fair ground when bounding to the outfield past first or third base.
- 6.26.3** First falls on fair ground on or beyond first or third base.
- 6.26.4** First touches a player, Umpire, or any piece of equipment while

over fair territory. A batted ball that hits the pitcher's rubber and rebounds untouched to foul territory between first and home or third and home is a foul ball.

Note: A fair fly must be judged according to the relative position of the ball and the foul line and not as to whether the fielder is on a fair or foul ground at the time the ball is first touched.

- 6.26.5** Touches a base in fair territory unless previously touched by a fielder or runner while the ball was in foul territory.
- 6.26.6** Passes out of the playing field in flight while over fair territory.
- Note:** If a batted ball hits the top of the fence while in fair territory and then bounces over the fence, it is a home run.
- 6.27 FAIR TERRITORY:** The part of the playing field within and including the first and third base lines from home plate to the bottom of the playing field fence and perpendicularly upwards. Both foul lines are in fair territory.
- 6.28 FIELDER:** Is any defensive player.
- 6.29 FIELDER'S CHOICE:** The act of a fielder who, in playing a fair ground ball, attempts to or does retire another base runner rather than throwing to first base to put out the batter-runner.
- 6.30 FLAGRANT COLLISION:** A collision between a base runner and a fielder in which the runner maliciously attempts to dislodge the ball.
- 6.31 FLY BALL:** A batted ball that goes high in the air directly off the bat.
- 6.32 FORCE PLAY:** A play in which a runner legally loses the right to occupy a base by reason of the batter becoming a runner.
- Note:** On a dropped third strike, when the batter is not entitled to run to first base, any advancing runner must be tagged to be declared out.
- 6.33 FORFEITED GAME:** A game declared ended and awarded to the offended team by the Umpire in chief.

- 6.34 FOUL BALL:** A foul ball is a legally batted ball that:
- 6.34.1** Settles on foul ground between home plate and first base or between home plate and third base.
 - 6.34.2** Bounds past first or third base over foul ground.
 - 6.34.3** First falls on foul ground beyond first or third base.
 - 6.34.4** While on or over foul ground, touches an Umpire, a player, or any object other than the playing surface.
 - 6.34.5** Hits the batter in the batter's box or hits the dirt or home plate and then hits the batter or the bat, which is in the hand or hands of the batter, while in the batter's box.
 - 6.34.6** Hits the pitcher's rubber and rebounds into foul territory between home plate and first or third base, without touching a fielder.
- Note:** A foul fly shall be judged according to the relative position of the ball and the foul line, including the foul pole, and not whether the fielder is on foul or fair territory at the time he touches the ball.
- 6.35 FOUL TERRITORY:** That part of the playing field outside the first and third base lines extended to the fence and perpendicularly upwards.
 - 6.36 FOUL TIP:** A batted ball that goes sharp and directly from the bat to the catcher and is caught legally by the catcher. It is a strike, and the ball is in play.
 - 6.37 GROUND BALL:** A batted ball that rolls or bounces close to the ground.
 - 6.38 HALF SWING:** An attempt by the batter to stop the forward motion of the bat while swinging, which puts the batter in jeopardy of a strike being called. The half swing shall be called a strike if the barrel head of the bat passes the batter's front hip. This does not apply to a bunt attempt when the batter pulls the bat back.
 - 6.39 HOME TEAM:** The team on whose field the game is played. If the game is played on neutral grounds, the home team shall be determined by mutual agreement.

- 6.40 ILLEGAL:** Anything contrary to these rules.
- 6.41 ILLEGAL BAT:** A bat that has been tampered with in such a way to improve the distance factor or cause an unusual reaction on the baseball.
- 6.41 ILLEGAL PITCH:** A pitch delivered to the batter without the pitcher's pivot foot in contact with the pitcher's rubber or the pitcher making a quick pitch. With runners on base, it is a balk.
- 6.42 ILLEGALLY BATTED BALL:** A ball hit by the batter with one or both feet on the ground and entirely outside the batter's box, or a ball hit with an illegal bat.
- 6.43 IN FLIGHT:** Any batted, thrown, or pitched ball that has not touched the ground or some object other than a player.
- 6.44 INFIELD:** That area within the 90-foot square (27.43 m²) bounded by home plate, first, second and third bases.
- 6.45 INFIELD FLY:** A fair fly ball (not including a line drive or an attempted bunt) which can be caught by an infielder with ordinary effort, when first and second, or first, second and third bases are occupied, before two are out. The pitcher, catcher or any outfielders who are in the infield on the said play, shall be considered infielders for the purpose of this rule.

The ball is alive, and runners may advance at the risk of the ball being caught, or they can retouch and advance after the ball is touched, the same as on any fly ball. If the hit becomes a foul ball, it is treated the same as any foul.

When it seems apparent that a batted ball will be an Infield Fly, the Umpire shall immediately declare "Infield Fly" for the benefit of the runners. If the ball is near the baselines, the Umpire shall declare "Infield Fly, If Fair."

If a declared Infield Fly is allowed to fall untouched to the ground, and bounces foul before passing first or third base, it is a foul ball. If a declared Infield Fly falls untouched to the ground outside the baseline, and bounces fair before passing first or third base, it is an Infield Fly.

Comment: If interference is called during an Infield Fly, the ball remains alive until it is determined whether the ball is fair or foul. If fair, both the runner who interfered with the fielder and the batter are out. If foul, even if caught, the runner is out, and the batter returns to bat.

- 6.46 INFIELDER:** Fielders (usually four) who are positioned in the infield area.
- 6.47 INNING:** That portion of a game within which the teams alternate on offence and defence and in which there are three putouts for each team. Each team's time at bat is a half-inning.
- 6.48 INTERFERENCE:** An act that hinders or prevents a player from making a play. The following are the most prevalent:
- 6.48.1** Offensive Interference is an act by the team at bat which interferes with, impedes, hinders, or confuses any fielder attempting to make a play.
- 6.48.2** Defensive Interference is an act by a fielder (usually the catcher) that hinders or prevents a batter from hitting a pitch.
- 6.48.3** Umpire's Interference occurs when a plate Umpire hinders, impedes, or prevents a catcher's throw attempting to prevent a stolen base or retire a runner on a pick off play. Also, when a fair ball touches an Umpire in fair territory before passing a fielder, other than the pitcher.
- 6.48.4** Spectator Interference occurs when a spectator or an object thrown by a spectator, hinders a player's attempt to make a play on a live ball, by going onto the playing field, or reaching out of the stands and over the playing field.
- 6.49 LEGAL:** Everything in accordance with these rules.
- 6.50 LIVE BALL:** After the pitcher engages the rubber with possession of the ball and the batter has assumed his position in the batter's box, the Umpire calls, or signals "Play."
- 6.51 LINE DRIVE:** A batted ball that goes sharp and direct from the bat to a fielder without touching the ground.

- 6.52 MANAGER:** The manager is a person appointed by the team to be responsible for the team's actions on the field, and to represent the team in communications with the Umpire and the opposing team.
- 6.53 MISCONDUCT:** It is any act of dishonesty, unsportsmanlike conduct or unprofessional behaviour that discredits the game.
- 6.54 OBSTRUCTION:** Is the act of a fielder who, while not in possession of the ball and not in the act of fielding the ball, impedes the progress of any runner. See specific rule sections for action to be taken.
- 6.55 OFFENCE OR OFFENSE:** The team at bat.
- 6.56 OFFICIAL SCORER:** See Chapter 5
- 6.57 ORDINARY EFFORT:** Is the effort that a fielder of average skill at a position in that league or classification should exhibit on a play, with consideration given to the condition of the field and weather conditions.
- 6.58 OUT:** A declaration by the Umpire that a player who is trying for a base is not entitled to that base.
- 6.59 OUTFIELDER:** Fielders (usually three) who occupy positions most distant from home plate between the infielders and the outfield fence.
- 6.60 OVERSLIDE:** Is the act of an offensive player when his slide to a base, other than when advancing from home to first base, is with such momentum that he loses contact with the base.
- 6.61 PICKOFF:** When a pitcher or catcher throws to a base between pitches in an attempt to retire a runner who is either leading off or about to begin stealing the next base, or to keep a runner close to the base.
- 6.62 PINCH HITTER:** An eligible substitute player who is not listed in the line-up and bats for a player listed in the line-up.
- 6.63 PINCH RUNNER:** An eligible substitute player who is not listed in the line-up and runs for a player listed in the line-up.

- 6.64 PITCH:** The ball delivered by the pitcher to the batter while in contact with the pitcher's rubber.
- 6.65 PITCHER:** The fielder designated to deliver the pitch to the batter.
- 6.66 PITCHER'S PIVOT FOOT:** The foot in contact with the pitching rubber when the pitcher is in the act of delivering the ball.
- Note:** For a right-handed pitcher the right foot is the pivot foot. For a left-handed pitcher the left foot is the pivot foot.
- Some portion of the pitcher's pivot foot must be in contact with the pitching rubber for the pitch to be legal.
- 6.67 PLAY:** The order given by the Umpire to begin the game or resume play.
- 6.68 QUICK PITCH:** An illegal pitch made with the obvious intent to catch the batter off balance.
- 6.69 RETOUCH:** Is the act of a runner in returning to a base as legally required.
- 6.70 RUN:** Is the score made by an offensive player who advances from batter to runner and touches first, second, third and home plate in that order.
- 6.71 RUN DIFFERENCE RULE:** The rule by which a game ends at a point if a team is losing by a certain amount of runs.
- 6.71.1 U-12:**
If a team is losing by fifteen (15) or more runs after having batted at least in four (4) innings the game is ended at that point. If a team is losing by ten (10) or more runs after having batted at least five (5) innings, the game is ended at that point.
- 6.71.2 U-15, U-18, U-23 & WOMEN'S:**
If a team is losing by ten (10) or more runs after having batted at least in five (5) innings, the game is ended at that point.
- Exception:** If the last batter in a game hits a home run out of the playing field, the batter-runner and all runners on base are

permitted to score, in accordance with the base running rules, and the game ends when the batter-runner touches home plate.

Approved Ruling: The batter hits a home run out of the playing field to win the game in the last half of the seventh inning or an extra inning but is called out for passing a preceding runner. The game ends immediately when the winning run is scored, unless there are two outs and the winning run has not yet reached home plate when the runner passes another, in which case the inning is over and only those runs that scored before the runner passes another shall count.

- 6.72 RUN DOWN:** The act of the defence in an attempt to put out a runner between bases.
- 6.73 RUNNER:** An offensive player who is advancing to, returning to, or touching a base.
- 6.74 SAFE:** Is a declaration by the Umpire that a runner is entitled to the base for which he is trying.
- 6.75 SET POSITION:** Is one of the two legal pitching positions. Usually used with runners on base.
- Note:** With a runner or runners on base, a pitcher will be presumed to be pitching from the set position if he stands with his pivot foot in contact with and parallel to the pitcher's plate, and his other foot in front of the pitcher's plate, unless he notifies the Umpire that he will be pitching from the windup position under such circumstances prior to the beginning of an at bat. A pitcher will be permitted to notify the Umpire that he is pitching from the windup position within an at bat only in the following events:
- A substitution by the offensive team.
 - Immediately upon the advancement of one or more runners. For example, after one or more base runners advance but before the delivery of the next pitch.
- 6.76 SQUEEZE PLAY:** A play whereby a team, with a runner on third base, attempts to score that runner by means of a bunt.

- 6.77 STRIKE:** A legal pitch when called by the Umpire. A strike is:
- 6.77.1** A legal pitch struck at by the batter without the ball touching the bat.
- 6.77.2** A legal pitch that enters the strike zone (See Appendix 4 for the diagram) in flight and is not struck at.
- Note:** The plate Umpire should determine if the pitch is a strike in relationship to the batter's normal position as the pitch crosses home plate. Any part of the ball passing over any part of the plate, from the bottom of the kneecaps to the midpoint between the top of the shoulders and the top of the uniform pants, is a strike. The pitch should be judged to be a strike or a ball as it crosses home plate, not where it is caught by the catcher.
- If a pitched ball strikes the ground in front of the batter and the batter swings at it, the ball is in play if hit and a strike if missed.
- 6.77.3** A legal pitch that becomes a foul not caught on the fly when the batter has fewer than two strikes.
- 6.77.4** An attempt to bunt the ball that results in a foul not legally caught.
- 6.77.5** A legal pitch that is in the strike zone and that touches the batter, regardless of whether he swings or not (the ball is immediately dead, the pitch is a strike, no runners may advance, and the batter is not awarded first base).
- 6.77.6** A foul tip.
- 6.77.7** After the offensive warning and the batter fails to take a position in the batter's box immediately after ordered by the Umpire and the 20 second limit expires.
- 6.77.8** Awarded if the batter deliberately steps back in the box or swings in such a manner to attempt to create catcher's interference. If the swing hits the catcher or the mitt, the batter will be called out. All base runners shall return to the base occupied at the time of the pitch.
- 6.78 STRIKE ZONE:** The area over home plate from the bottom of the kneecaps to the midpoint between the top of the shoulders and

the top of the uniform pants. The strike zone shall be determined from the batter's stance as the batter is prepared to swing at a pitched ball. See Diagram in Appendix 4.

- 6.79 SUBSTITUTE:** A substitute is an eligible roster player who is not one of the players listed on the line-up card and has not been withdrawn or disqualified.
- 6.80 SUSPENDED GAME:** A game that is stopped because of weather, curfew, or other reason. To be completed at a later date.
- 6.81 TAG:** A tag is the action of a fielder in touching a base with his body while holding the ball, or with his hand or glove, or touching a runner with the ball, or with his hand or glove holding the ball (not including hanging laces alone), while holding the ball securely and firmly in his hand or glove. It is not a tag, however, if simultaneously or immediately following his touching a base or touching a runner, the fielder drops the ball. In establishing the validity of the tag, the fielder shall hold the ball long enough to prove that he has complete control of the ball. If the fielder has made a tag and drops the ball while in the act of making a throw following the tag, the tag shall be adjudged to have been made.
- 6.82 THROW:** A throw is the act of propelling the ball with the hand and arm to a given objective and is to be distinguished, always, from the pitch.
- 6.83 TIE GAME:** Is a regulation game which is called when each team has the same number of runs.
- 6.84 TIME:** The interruption of play by any Umpire, calling or signalling the ball dead.
- 6.85 TIME OF PITCH:** The time of pitch shall be determined when:
- 6.85.1** In the windup position, when the pitcher makes any movement connected with the delivery to the plate.
- 6.85.2** In the set position, when the pitcher begins his natural movement associated with the pitcher's delivery of the ball after the pitcher has come set with both hands together in front of his body.

- 
- 6.86 TOUCH:** To touch a player or Umpire is to touch any part of his body, or any uniform or equipment worn by him, but not any jewellery, worn by a player.
- 6.87 TRIPLE PLAY:** A continuous play by the defence in which three players are put out without an error between the putouts.
- 6.88 WILD PITCH:** Is one so high, so low, or so wide of the plate that it cannot be handled with ordinary effort by the catcher.
- 6.89 WINDUP:** One of two legal pitching positions, usually made with no runners on base.

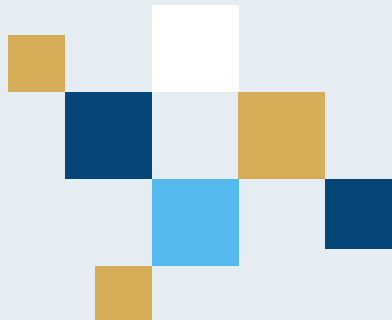

CHAPTER 03.

BASEBALL RULES

RULE 7. GAME: BEGINNING AND ENDING

The game begins when all the defensive players have taken their defensive positions on the field of play. The first batter of the offensive team shall take his position in the batter's box, the Umpire in chief shall call "PLAY"

The ball is alive and in play and remains alive until the Umpire calls "Time" or the ball becomes dead.

7.1 STARTING THE GAME

The game begins when the home plate Umpire (chief Umpire) calls "Play." After the Umpire calls "Play" the ball is alive and in play.

7.2 POSITIONS OF THE OFFENSIVE TEAM

The offensive team shall:

- 7.2.1 Follow the batting order submitted by the manager, throughout the game unless a player is substituted for another.
- 7.2.2 The first batter in each inning after the first inning shall be the player whose name follows that of the last player who legally completed his turn at bat in the previous inning.

7.3 TEAM OFFENSIVE INTERFERENCE

If there is interference with a live ball (thrown or batted) by anyone other than players, coaches or Umpires, the Umpires shall rule as to whether the act is intentional or unintentional.

- 7.3.1 If it is intentional, the ball is declared dead immediately when it is interfered with, and the Umpire shall award the offended team appropriately that in his opinion would have resulted had the interference not taken place.
 - 7.3.1.1 It is intentional if a coach, player, bat person, photographer, or other home field person fields, kicks or pushes a ball, regardless of motive.
 - 7.3.1.2 The Umpire shall declare intentional interference and take any action required to rectify the interference, whether it is an out, extra bases, if a spectator intentionally reaches out of the stands or goes onto the playing field. The ball is dead immediately.

7.3.2 If it is unintentional interference, the ball remains alive and in play. It is unintentional interference if a base coach, bat person, photographer or any other field attendant tries to evade the ball and it touches that individual or if it touches that person without that person being aware the ball was coming.

7.3.3 It is not interference if the player is going outside the playing field during a play, and the spectator interferes with a possible catch in the stands or over a fence.

7.4 BASE COACHES

- 7.4.1 The team at bat shall station two base coaches in uniform on the field during its time at bat who occupies the coach's box at first or third base to direct the batter or runner.
- 7.4.2 Base coaches must remain within the coach's box. At the time of the pitch, the base coach may not be closer to the foul line than the inside edge of the coaches' box and no closer to home plate than the front edge of the box. A coach may leave the coach's box to signal the player to slide or advance or return to a base as long as the individual does not interfere with the play.

Penalty: Upon complaint by the opposing manager, the Umpire shall strictly enforce the rule. The Umpire shall warn the coach and instruct him to return to the box. If the coach does not return to the box, they shall be removed from the game.

7.5 POSITIONS OF THE DEFENSIVE TEAM

At the start of or during a game, all defensive players except the catcher must be in fair territory when the ball is put in play.

7.5.1 The catcher must stand with both feet within the lines of the catcher's box until the pitcher releases the ball.

Penalty: Balk. All runners awarded one base.

7.5.2 The pitcher must be in a legal position while delivering the ball to the batter.

7.5.3 Any fielder may position himself anywhere in fair territory, except the pitcher and the catcher.

7.6 SUBSTITUTIONS

7.6.1 Each team shall always have nine eligible players in the game.

7.6.2 Any pitcher named may be replaced after the first opposing batter (or the batter's substitute) has been put out or has advanced to first base or the side has been retired. In case of injury or illness, a pitcher may be replaced immediately. If the pitcher is replaced, the substitute pitcher shall pitch to the batter then at bat, or any substitute batter, until such batter is put out or reaches first base, or until the offensive team is put out, unless the substitute pitcher sustains injury or illness which, in the Umpire-in-chief's judgment, incapacitates him for further play as a pitcher.

Note: When a pitcher is removed as a pitcher but remains in the game, the pitcher will not be allowed to assume a position other than a pitcher more than once in the same inning.

A substitute becomes a player when he has been reported to the Umpire-in-chief and the new player is written into the Umpire-in-chief's line-up card.

If a pitcher is brought into the game but has not faced one batter (or retired the side) when the game is stopped for weather, such pitcher may, but is not required to, continue pitching when the game is resumed.

No player removed for a substitute before the suspension of play may return to the line-up when the game is resumed.

7.6.3 Any player other than the pitcher or designated hitter may be substituted for at any time when the ball is dead, and the substituted player must take the place of the replaced player in the team's batting order.

Note: If the pitcher is removed from the game as a pitcher but will remain in the game and bat for the DH, that change must be announced at the time the pitcher is removed.

7.6.4 The designated hitter may enter the game on defence once but must bat in the original position in the line-up. The pitcher must then bat in the position vacated by the player leaving the game. See Designated Hitter Rule 9.3.

7.6.5 If two or more substitute players of the defensive team enter the game simultaneously, to avoid any confusion the manager immediately shall designate to the Umpire-in-chief the position of each in the team's batting order. If this is not done immediately, the Umpire shall place them in the batting order.

Note: When the pitcher is not the designated hitter, moving the pitcher to a defensive position and bringing in only one new substitute player does not constitute multiple substitution for the purpose of batting-order changes. The pitcher moved to the defensive position must bat in the spot of the defensive player replaced and the new pitcher must bat in the DH position.

If a double switch is being made, the manager or coach shall first notify the plate Umpire. The Umpire-in-chief must be informed of the multiple substitutions and interchanged batting order before the manager calls for a new pitcher (regardless of whether the manager or coach announces the double-switch before crossing the foul line). Signalling or motioning to the bullpen is to be considered an official substitution for the new pitcher. It is not permissible for the manager to go to the mound, call for a new pitcher, and then inform the Umpire of multiple substitutions with the intention of interchanging the batting order.

7.6.6 A base runner shall not be replaced by another player whose name appears or has appeared in the batting order for that game.

Note: This rule is intended to eliminate the practice of using so-called courtesy runners. No player in the game shall be permitted to act as a courtesy runner for a teammate. No player who has been in the game and has been taken out for a substitute shall return as a courtesy runner. Any player not in the line-up, if used as a runner, shall be considered as a substitute player.

7.6.7 After having been notified or confirmed by the manager or another coach in uniform of the team making the substitution, the Umpire shall record any substitutions on the line-up card and then announce immediately or cause to be announced any substitutions. Should there be no announcement of substitution, the substitute becomes a legal player when:

7.6.7.1 A runner takes the place of another base runner.

7.6.7.2 A pitcher engages the pitcher's rubber.

7.6.7.3 A fielder reaches the position usually occupied by the fielder being replaced and play commences; or

7.6.7.4 A batter enters the batter's box.

Note: Any play made by, or on, any of the above-mentioned unreported substitutes shall be legal. There is no penalty.

7.6.8 If a player substitutes for an injured teammate, other than the pitcher, the individual shall be allowed five warm-up throws.

7.6.9 A withdrawn player may sit on the bench, warm up pitchers, and act as a base coach. If a substitute enters the game in place of a player-manager, the manager may thereafter go to the coaching lines at his discretion.

7.6.10 A player once removed from a game shall not re-enter that game. If a player who has been substituted for attempts to re-enter, or re-enters, the game in any capacity, the Umpire-in-chief shall direct the player's manager to remove such player from the game immediately upon noticing the player's presence or upon being informed of the player's improper presence by another Umpire or by either manager. If such direction to remove the substituted for player occurs before play commences with the player improperly in the game, then the substitute player may enter the game. If such direction to remove the substituted-for player occurs after play has commenced with the substituted-for player in the game, then the substitute player shall be deemed to have been removed from the game (in addition to the removal of the substituted-for player) and shall not enter the game.

Note: Any play that occurs while a player appears in a game after having been substituted for shall count. If, in an Umpire's judgment, the player re-entered the game knowing that he had been removed, the Umpire may eject the manager.

7.7 REGULATION GAME

7.7.1 A regulation game consists of seven (7) or nine (9) innings, unless extended because of a tie score, or shortened

7.7.1.1 Because the home team does not need its half of the seventh inning or only a fraction of it.

7.7.1.2 Because the Umpire in chief calls the game.

7.7.2 If the score is tied after seven (7) or nine (9) innings play shall continue until:

7.7.2.1 The visiting team has scored more total runs than the home team at the end of a completed inning.

7.7.2.2 The home team scores the winning run in an uncompleted inning.

7.7.3 If a game is called, it is a regulation game:

7.7.3.1 If four (4) innings for seven (7) inning-game and five (5) innings for nine (9) inning-game have been completed.

7.7.3.2 If the home team has scored more runs in four or four and a fraction half innings than the visiting team has scored in five completed half-innings.

7.7.3.3 If the home team scores one or more runs in its half of the fifth inning to tie the score.

7.7.4 If a regulation game is called with the score tied, it shall become a suspended game.

7.7.5 If a game is postponed or otherwise called before it has become a regulation game, the Umpire in chief shall declare it "No Game," unless the game is called pursuant to Rule 7.8, which shall be a suspended game at any time after it starts.

7.7.6 The score of a regulation game is the total number of runs scored by each team at the moment the game ends.

7.7.6.1 The game ends when the visiting completes its half of the seventh inning if the home team is ahead.

7.7.6.2 The game ends when the seventh inning is completed if the visiting team is ahead.



7.7.6.3 If the home team scores the winning run in its half of the seventh inning (or its half of an extra inning after a tie), the game ends immediately when the winning run is scored.

7.7.7 A called game ends at the moment the Umpire terminates play, unless it becomes a suspended game pursuant to Rule 7.8.

Comment: Please see the Appendix 1. For the U-12 games are six (6) innings.

7.8 HALTED GAME (SUSPENDED, POSTPONED, AND TIE GAMES)

7.8.1 A game shall become a suspended game that must be completed at a future date if the game is terminated for any of the following reasons:

7.8.1.1 A curfew imposed by law.

7.8.1.2 A time limit permissible under Federation rules.

7.8.1.3 Light failure, malfunction of, or unintentional operator error in, a mechanical or field device or equipment under the control of the home team (e.g., a tarpaulin, or water sprinklers).

7.8.1.4 Darkness, when a law prevents the lights from being turned on.

7.8.1.5 Weather, if a regulation game is called while an inning is in progress and before the inning is completed, and the visiting team has scored one or more runs to take the lead, and the home team has not retaken the lead.

7.8.1.6 It is a regulation game that is called with the score tied.

7.8.1.7 The game has not become a regulation game (4 1/2 innings with the home team ahead, or 5 innings with the visiting team ahead or tied).

No game called because of a curfew, weather, a time limit, or with a tied score shall be a suspended game unless it has progressed far enough to have been a regulation game.

7.8.2. A suspended game shall be resumed at the exact point of suspension of the original game. The completion of a suspended game is a continuation of the original game. The line-up and batting order of both teams shall be the same as the line-up and batting order at the moment of suspension. Any player may be replaced by a player who had not been in the game prior to the suspension. No player removed before the suspension may be returned to the line-up.

7.9 TIE GAME

A regulation tie game shall be declared by the Umpire in chief:

7.9.1 If the score is tied when play is terminated after five or more equal innings.

7.9.2 If the team that went to bat second is at bat when play is terminated and has scored during the uncompleted inning the same number of runs as the other team.

Any regulation game called by the Umpire with the score tied shall be declared a "tie" game.

Note: All individual and team averages from a tie game shall be incorporated into the official playing record.

7.10 NO GAME

The Umpire shall declare "No Game" if play is terminated before five innings have been completed.

Exception: If the home team is at bat in the bottom of the fifth inning and ties the game before the completion of that inning, the Umpire shall declare the game legally tied.

If the home team has scored more runs or is leading after four and a half innings, the Umpire shall award the game to the home team and it will be counted as a legal game.

7.11 FORFEITED GAME

A game shall be forfeited only as a last resort in favour of the team not at fault in the following cases:

7.11.1 If a team refuses to take the field within five minutes after the Umpire has called "Play," unless the delay is unavoidable.





- 7.11.2 If, after the game has started, one team refuses to play.
- 7.11.3 If a team employs manoeuvres or methods to obviously delay or shorten the game.
- 7.11.4 After the Umpire has warned a team, that team wilfully continues to violate any rules of the game.
- 7.11.5 A team fails to obey within a reasonable time the Umpire's order for removal of a player from the game.
- 7.11.6 A game shall be forfeited to the opposing team when a team in unable or refuses to put nine players on the field.
- 7.11.7 If both teams are equally at fault and the situation is so out of control that the game cannot be safely continued, or if neither team has enough players available to continue the game, a double forfeit will be declared.
- 7.12 **PROTESTED GAME**
For regular season games, each National Federation should adopt a procedure for protesting a game when a manager claims that an Umpire's decision is in violation of these rules. No protest shall be permitted on a judgement call by an Umpire.
- 7.12.1 Any protest by the manager of a team must be made at the time of the play that caused the protest and before any play is resumed. If the game ends in a protestable decision, the offended team has until all infielders have left fair territory and the catcher has cleared the dirt circle to voice its protest intentions. All protests must be made to the Umpire-in-chief.
- 7.12.2 When a manager claims that an Umpire's decision violated WBSC rules, the Umpire-in-chief must allow the manager the right to file a protest; announce to each manager, to the Official Scorer and the public address announcer that the game is being played under protest. Lastly, the Umpire must record the game situation at the time of protest.
- 7.12.3 No part of the game will be allowed to be replayed, even if the protest is upheld, if the play in question did not affect the outcome of the game.

- 7.12.4 If the protest is upheld and could have had a bearing on the outcome of the game, then the game is replayed from the point of the protest.
- 7.12.5 Once a manager is ejected, he may not protest a game situation. If a protest is to be lodged, it must be done by the substitute for the manager.

Example: With one out and runners on second and third bases, the batter hits a fair fly ball that was caught. The runner on third tagged up after the catch but the player on second did not. The runner on third had crossed home plate before the ball was played at second base for the third out. The Umpire did not allow the run to score. The question whether the runners left their bases before the catch and whether the play at second base was made before the player on third crossed home plate are solely matters of judgement and may not be protested.

7.13 FIGHT RULE

The World Baseball and Softball Confederation (WBSC) has no tolerance for physical abuse or fighting at its tournaments. The WBSC fight rule penalises any team members (players, coaches, manager, or team personnel), for fighting whether it is before, during or after a game has been played. The team manager and its coaches must know that they are responsible for the actions of their players.

The penalties for this rule will be enforced by the Tournament Technical Commission in consultation with the Technical Director and the Umpire Director. Suspended players, coaches, manager, or any team personnel, will be prohibited from any communication or contact, direct or indirect, with the team, coaches, manager, or bench personnel from the start of the game to the completion of the game, including all extra innings.

- 7.13.1 Fighting - Any physical abuse of an opponent, including attempting to strike with the arms, hands, legs, feet, or any equipment in a combative manner or intentionally spitting at an opponent.
- 7.13.2 Physical abuse of Game Officials or Umpires - Any threat of physical intimidation or harm to include pushing, shoving, contact, kicking dirt on an Umpire or Technical Commissioner, spitting, spraying, throwing at or attempting to make physical contact.



- 7.13.3** Team personnel leaving position – Any team personnel leaving their position to potentially participate in a verbal or physical confrontation, or a fight shall include players, coaches, manager, and team personnel.

The position is determined by where the individual is located at the time a confrontation takes place. For example, dugout, bullpen, coaching box, on base, at bat, or a defensive position.

Penalty: These are considered a WBC “A” Level infractions. Fighting is subject to a suspension of a minimum of 3 games and up to two (2) years, and a minimum penalty of \$2,000 USD.

Note: If a bench clearing fight develops, Umpires should stay clear and let coaches, managers, and other players break up the fight. Umpires should attempt to identify all offenders and consult with their crew as to what action they deem necessary.

RULE 8. BALL IN PLAY

8.1 LIVE BALL

The ball is alive and in play after the Umpire calls “Play.” The ball is alive and in play until for legal cause, or at the Umpires call of “Time” suspending play, the ball becomes dead. While the ball is dead, no player may be put out, no bases may be run and no runs may be scored, except that runners may advance one or more bases as the result of acts that occurred while the ball was alive (such as, but not limited to, a balk, an overthrow, interference, a home run, or other fair hit out of the playing field).

Note: Umpires must not permit the unnecessary calling of “Time” by players and coaches when it is an obvious tactic to delay the game.

The Umpire shall not call time until a play has been completed.

- 8.1.1** If a thrown ball accidentally strikes a coach in foul territory, or a pitched or thrown ball strikes an Umpire, the ball remains in play.

- 8.1.2** If a fair hit ball passes by all infielders or it is touched by a fielder and then touches a runner or an Umpire, the ball is in play and the runner is not out. If said ball should touch the runner or Umpire while still in flight, it shall be considered a ground ball. It cannot be caught as a fly ball.

- 8.1.3** If a fielder, after making a legal catch, steps or falls into any dead ball area, the ball is dead and each runner shall advance one base, without liability to be put out, from his last legally touched base at the time the fielder entered such dead ball area.

- 8.1.4** A fielder is considered not to have fallen and the ball is live if the individual is held from falling or stepping into a dugout or dead ball area by game personnel or spectators.

- 8.1.5** If the fielder makes a legal catch and goes through or over any fence or into a dead ball area, the ball is dead even if the fielder lands feet first. The batter is out and, if not the third out of an inning, runner or runners advance one base from the last legally occupied base.

- 8.1.6** If a detached batting helmet accidentally is hit with a live ball, the ball remains in play.

- 8.1.7** If the live ball should come apart in a game, it is in play until the action is completed.

- 8.1.8** If a thrown or batted ball that remains in live ball territory accidentally hits a spectator, authorised on field personnel or animal, the ball is live.

Note: If a pitched ball strikes a bird in flight or other animal on the playing field, the pitch is nullified, and play shall be resumed with the previous count.

- 8.1.9** If a fair hit ball touches an Umpire after it passes a fielder other than the pitcher, or is touched by a fielder, including the pitcher, the ball is in play.

- 8.1.10** A batted ball that strikes a power line, tree limb or other overhead object in the field of play remains live, unless it is in the local ground rules.

8.2 IMMEDIATE DEAD BALL - RUNNERS RETURN

The ball becomes dead and base runners return when:

- 8.2.1** A foul ball is hit that is not caught. Runners return and the Umpire shall not put the ball in play until all runners have retouched their bases.
- 8.2.2** A ball is illegally batted.
- 8.2.3** A coach intentionally interferes with a thrown ball.
- 8.2.4** If a batter swings and misses a pitch and carries the bat all the way around and, in the Umpire's judgement, unintentionally hits the catcher or the ball behind him on the backswing, it shall be called a strike only (not interference). The ball is dead, and no runner shall advance on the play.
- 8.2.4.1** If the follow through hits the catcher and occurs in a situation where the batter normally would become a runner because of a third strike not held by the catcher, the ball shall be dead, and the batter declared out. No runner may advance.
- 8.2.4.2** If the catcher is in the act of making a throw to retire a runner and the batter is in the batter's box and his normal follow through unintentionally strikes the catcher or the ball while the catcher is in the act of throwing, "Time" is called, and runners return (unless the catcher's initial throw directly retires the runner).
- 8.2.5** A fair ball touches a runner in fair territory before touching any infielder including the pitcher or an Umpire and before passing an infielder (other than the pitcher) who has a chance to make a play on the ball. The runner who is touched by the fair ball is out, and no other runner may advance or score, except when forced.

Note: If a fair ball goes through or by an infielder and touches a runner immediately in back of him or touches the runner after having been deflected by any fielder including the pitcher, the Umpire shall not declare the runner out for being touched by a batted ball. This refers to a ball that passes through the infielder's legs, or by his immediate vicinity, and strikes the runner directly behind the infielder. In making such a decision, the Umpire must

be convinced that the ball passed through, or by, the infielder and that no other infielder had a chance to make a play on the ball.

Penalty: The ball is dead, and the runner hit by the batted ball is declared out. The batter is awarded first base with a single. Remaining runners advance if forced.

- 8.2.6** A fair ball touches an Umpire before touching a fielder and before passing a fielder other than the pitcher.

Penalty: The ball is dead, and the batter is awarded first base with a single. Runners advance if forced.

Note: If a fair ball touches an Umpire after having passed a fielder other than the pitcher, or having been touched by a fielder, including the pitcher, the ball is in play.

- 8.2.7** Interference is called on another runner.

Note: If the Umpire declares the batter, batter-runner or a runner out for offensive interference, all other runners shall return to the last base that was legally attained at the time of the interference.

- 8.2.8** If any runner intentionally interferes with a batted or thrown ball with a helmet or other personal equipment, the ball is dead, the runner is out, and any runner in advance of the interference shall return to the base last occupied at the time of interference. The batter-runner is awarded first base.

- 8.2.9** If a fielder reaches into a dugout, bullpen or dead ball area to catch a foul fly ball and an opponent interferes with the attempted catch, the batter shall be declared out and no runners shall advance.

8.3 DELAYED DEAD BALL - RUNNERS RETURN OR ADVANCE

The ball becomes dead, and runners advance one base or return to their bases without the liability to be put out when:

- 8.3.1** The plate Umpire interferes with the catcher's throw attempting to prevent a stolen base or retire a runner on a pick off play, runners may not advance.



Note: The interference is disregarded if the catcher's throw retires the runner.

- 8.3.2** The batter interferes with the catcher's fielding or throwing by stepping out of the batter's box or making any other movement that hinders the catcher's play at home base.

Penalty: Batter is out. Unless the runner attempting to advance is put out, or if runner trying to score is called out for batter's interference.

8.4 IMMEDIATE DEAD BALL - RUNNERS ADVANCE

The ball becomes dead and base runners advance one base without liability to be put out when:

- 8.4.1** A legal pitch hits a runner trying to score.

Exception: Any legal pitch hits a runner trying to score, immediate dead ball, base runners advance if they were stealing with the pitch. If they were not stealing, all base runners remain at the base they occupied at the time of the pitch.

- 8.4.2** A pitched ball touches a batter or any part of his clothing while in the legal batting position. Runners if forced advance. This does not include any jewellery.
- 8.4.3** A spectator or any other individual intentionally interferes with any thrown or batted ball. The ball is dead at the moment of interference and the Umpire shall impose penalties as to nullify that act of interference.
- 8.4.4** A pitched ball lodges in the Umpire or catcher's equipment other than the catcher's glove and remains out of play, or goes over, through or wedges in the field padding or fence.
- 8.4.5** When a fielder, after making a legal catch, steps or falls into any out of play area. Ball is dead and all other runners advance one base from their last legally occupied base at the time the fielder entered out of play area.

8.5 CALLING TIME AND DEAD BALLS

- 8.5.1** When an Umpire suspends play, he shall call "Time." At the Umpire in chief's call of "Play," the suspension is lifted and play resumes. Between the call of "Time" and the call of "Play" the ball is dead.
- 8.5.2** The ball becomes dead when an Umpire calls "Time." The Umpire in chief shall call "Time":
- 8.5.2.1** When in his judgement weather, darkness or similar conditions make immediate further play impossible.
- 8.5.2.2** When light failure makes it difficult or impossible for the Umpires to follow the play.
- 8.5.2.3** When an accident incapacitates a player or an Umpire.
- 8.5.2.4** If an accident to a runner is such to prevent him from proceeding to a base to which he is entitled, as on a home run hit out of the playing field, or an award of one or more bases, a substitute runner shall be permitted to complete the play.
- 8.5.2.5** When a manager requests "Time" for a substitution, or for a conference with one of his players.
- 8.5.2.6** When an Umpire wishes to examine the ball, to consult with either manager, or for any similar reason.
- 8.5.2.7** When a fielder, after catching a fly ball, steps or falls into any out of play area. All other runners shall advance one base, without liability to be put out, from his last legally occupied base at the time the fielder entered such out of play area.
- 8.5.2.8** When an Umpire orders a player or any other person removed from the playing field.
- 8.5.2.9** Except in the cases stated in Rules 8.5.2.2 and 8.5.2.3, no Umpire shall call "Time" while a play is in progress.



8.5.2.10 A player or Umpire is injured. If injury occurs during a live ball, time shall not be called until no further advance or putout is possible. If a player is injured and cannot proceed to the awarded base, a substitute runner may be used to complete the play.

8.5.2.11 An unusual circumstance interferes with the normal progress of the game. Such as, spectators running on the field, animal, ball, or other object on the field.

After the ball is dead, play shall be resumed when the pitcher takes his place on the pitcher's plate with a new ball or the same ball in his possession and the plate Umpire calls "Play." The plate Umpire shall call "Play" as soon as the pitcher takes his place on the rubber with the ball in his possession.

8.6 UNSPORTSMANLIKE CONDUCT

No manager, player, coach, or team personnel shall at any time:

8.6.1 Incite or attempt to incite, by word, sign or actions that dispute an Umpire's decision and potentially incites a demonstration by spectators.

8.6.2 Call "Time" or employ any other words or phrase or commit any act while the ball is in play for the purpose of trying to make the pitcher commit a balk.

Penalty: The offender will be removed from the game and will leave the playing field. If a balk is committed, it will be disregarded.

8.6.3 Use language which will in any manner refer to or reflect upon opposing players, an Umpire, or any spectator.

8.6.4 Make intentional contact with any Umpire in any manner.

8.6.5 Take a position in the batter's line of vision, and with deliberate intent act in a manner to distract the batter.

RULE 9. BATTING

9.1 BATTING ORDER

9.1.1 Each player of the side at bat shall become a batter and must take a position within the batter's box in the order that the name appears in the team's batting order.

9.1.2 The batting order will be followed throughout the game unless a player is substituted for another. In that case the substitute will take the place of the replaced player in the batting order.

9.1.3 The first batter in each inning after the first inning will be the player whose name follows that of the last player who legally completed his time at bat in the preceding inning.

9.2 A BATTER

An offensive player who enters the batter's box with the intention of aiding their team to score runs. They continue to be a batter until they are declared out by the Umpire or become a batter-runner.

9.3 DESIGNATED HITTER

The designated hitter (DH) is a player designated to bat for the starting pitcher and all subsequent pitchers.

Basic principles:

9.3.1 A hitter may be designated to bat for the starting pitcher and all subsequent pitchers in any game without otherwise affecting the status of the pitcher(s) in the game. A DH for the pitcher, if any, must be selected prior to the game and must be included in the starting line-up cards presented to the Umpire-in-chief. If a manager lists 10 players in the team's line-up card, but fails to indicate one as the DH, and an Umpire or either manager (or designee of either manager who presents the team's line-up card) notices the error, the Umpire-in-chief shall direct the manager who had made the omission to designate which of the nine players, other than the pitcher, will be the DH. It is important for the Umpire-in-chief and representatives from both teams verify that the line-ups presented at the pregame meeting are correct.

- 9.3.2** The DH named in the starting line-up must come to bat at least one time, unless the opposing team changes pitchers or the DH becomes ill or injured before the player's spot in the line-up comes to bat.
- 9.3.3** It is not mandatory that a team designate a hitter for the pitcher. If the starting pitcher is listed in the batting order, the pitcher automatically becomes the DH. In this case, the pitcher is to be considered as two players, both the pitcher and DH (P/DH) and can be substituted for as such
- 9.3.4** Pinch-hitters for a DH may be used. Any substitute hitter for a DH becomes the DH. A replaced DH (including a P/DH who has been replaced as DH) shall not re-enter the game in any other capacity.
- 9.3.5** The DH may be used on defence, continuing to bat in the same position in the batting order, but the pitcher must then bat in the place of the substituted defensive player, unless more than one substitution is made, and the manager then must designate their spots in the batting order.
- 9.3.6** A runner may be substituted for the DH and the runner assumes the role of DH. A DH may not pinch-run.
- 9.3.7** A DH is "locked" into the batting order. No multiple substitutions may be made that will alter the batting order of the DH.
- 9.3.8** Once the game pitcher is switched from the mound to a position on defence, such a move will terminate the DH role for that team for the remainder of that game.
- 9.3.9** Once a pinch-hitter bats for any player in the batting order and then enters the game to pitch, such a move will terminate the DH role for that team for the remainder of the game.
- 9.3.10** The game pitcher may pinch-hit or pinch-run only for the DH and become the P/DH.
- 9.3.11** If a manager lists 10 players in his team's line-up card, but fails to indicate one as the DH and the opposing manager brings the failure to list a DH to the attention of the Umpire in chief after the game starts, then:

- 9.3.11.1** The listed player who has not assumed a position on defence is the DH, if the team has taken the field on defence; or
- 9.3.11.2** If the team has not yet taken the field on defence, the manager of that team shall indicate which player should have been listed as the DH.
- 9.3.12** Once a DH assumes a position on defence other than pitcher (i.e., becoming the P/DH), such move will terminate the DH role for that team for the remainder of that game.
- 9.3.13** A substitute for the DH need not be announced until it is the DH's turn to bat.
- 9.3.14** If a player on defence goes to the mound (i.e., replaces the pitcher), this move will terminate the DH's role for that team for the remainder of the game. The DH may assume the defensive player's position in the field.

Note: When the P/DH is replaced as the DH, the individual may remain in the game as a pitcher. However, the P/DH cannot afterward move to a defensive position and cannot return as the DH. Once a player leaves the offensive line-up they cannot return.

If a game pitcher is switched from the mound to a defensive position, this will terminate the DH's role for the rest of the game. The pitcher just removed from the mound may bat in the DH's spot in the batting order; or if more than one defensive change is made, the pitcher (not a P/DH) may bat in place of any one of the substituted players (manager will designate the place in the batting order to the Umpire). The player may return as a pitcher once unless the pitcher was removed as pitcher on a second trip during the same inning or after the third charged defensive conference involving a manager or coach.

At the time of a pitching change, the manager shall indicate to the plate Umpire the playing status of the removed player. Once the manager has reached the dugout, the manager may not move the replaced pitcher (or P/DH) to a defensive position or have the replaced pitcher remain as DH.

Example: Home team relief pitcher Jones pitched the top of the ninth inning. He was not playing as a P/DH. For the top of the tenth inning, Jones moved to first base and relief pitcher Smith entered the game as the pitcher. Jones was placed in the eighth spot in the order where the first baseman Carter was hitting, and Smith was slotted into the third spot for the DH Anderson.

9.4 THE BATTER'S BOX

9.4.1 The batter shall take his position in the batter's box promptly when it is his time at bat.

9.4.2 The batter shall not leave his position in the batter's box after the pitcher comes to Set Position or starts his windup.

Penalty: If the pitcher pitches, the Umpire shall call "Ball" or "Strike," as the case may be.

9.5 THE BATTER'S BOX RULE

This rule is designed to speed up play by controlling the actions of the batter between pitches.

9.5.1 The batter must keep one foot in the batter's box between pitches. Failure to keep one foot in the batter's box shall result in a strike being called on the batter. The batter may only step out of the batter's box with both feet in the following circumstances:

9.5.1.1 When the ball is hit.

9.5.1.2 On a swing, provided it is the momentum of the swing that takes him out of the batter's box.

9.5.1.3 If forced out of the batter's box to a valid pitch.

9.5.1.4 On a wild pitch or passed ball.

9.5.1.5 On an attempted play at the plate or by the catcher on an advancing runner or by any player.

9.5.1.6 If the catcher is attempting to make a play (i.e. pop fly).

9.5.1.7 If time has been called, or the plate Umpire leaves his

position to perform other duties not directly connected with the calling of plays.

9.5.1.8 If the pitcher leaves the mound.

9.5.1.9 On a three-ball count that the batter thinks the pitch was a ball.

9.5.1.10 On a checked swing.

9.5.1.11 On a bunt attempt.

Penalty: A delay of the game caused by the failure of the batter to keep one foot in the batter's box between pitches will result in the ball being declared dead and a strike awarded against the batter. The plate Umpire shall call and signal "DEAD BALL," point to the batter's box and say "BATTER'S BOX VIOLATION," awarding a strike on the batter and giving the new count.

9.5.2 The batter may leave the batter's box and the dirt area when time is granted for the purpose of:

9.5.2.1 Making a substitution.

9.5.2.2 An offensive conference.

9.5.2.3 A defensive conference.

9.5.2.4 An Injury or potential injury

9.6 A BALL

A ball is:

9.6.1 A pitched ball at which the batter does not strike, and which does not enter the strike zone on the fly.

9.6.2 Called by the Umpire when the pitcher makes an illegal pitch or a quick return pitch with the bases unoccupied unless the batter safely reaches base.

9.6.3 Called by the Umpire when the pitcher takes the signal from an illegal position.

9.6.4 Called by the Umpire when the pitcher fails to begin his pitching motion within 20 seconds in violation of the clock rule.

9.7 BATTER ILLEGAL ACTION

A batter is out for illegal action when:

9.7.1 A ball hit, fair or foul, by the batter when either one or both batter's feet are upon the ground entirely outside the lines of the batter's box or when touching home plate; or

9.7.2 A ball is hit with a bat that is an illegal bat. A bat that, in the Umpire's judgement has been altered or tampered with

Comment: A batter shall be deemed to have used or attempted to use an illegal bat if he brings such a bat into the batter's box.

No advancement on the bases will be allowed (except advancements that are not caused by the use of an illegal bat, e.g., stolen base, balk, wild pitch, passed ball) and any out or outs made during a play shall stand. In addition to being called out, the player shall be ejected from the game.

9.7.3 He steps from one batter's box to the other while the pitcher is in position ready to pitch.

9.7.4 He interferes with the catcher's fielding or throwing by stepping out of the batter's box or making any other movement that hinders the catcher's play at home base.

9.7.5 He throws his bat into fair or foul territory and hits a catcher (including the catcher's glove) and the catcher was attempting to catch a pitch with a runner(s) on base and/or the pitch was a third strike.

Exception: to Rule 9.7.4 and Rule 9.7.5

If the batter interferes with the catcher, the plate Umpire shall call "interference." The batter is out and the ball is dead. No player may advance on such interference (offensive interference) and all runners must return to the last base that was, in the judgement of the Umpire, legally touched at the time of the interference.

If, however, the catcher makes a play and the runner attempting to advance is put out, it is to be assumed there was no actual interference, and that runner is out, not the batter. Any other runners on the base at the time may advance as the ruling is that there is no actual interference if a runner is retired. In that case play proceeds just as if no violation had been called.

If a batter strikes at a ball and misses and swings so hard he carries the bat all the way around and, in the Umpire's judgement, unintentionally hits the catcher or the ball in back of him on the backswing, it shall be called a strike only (not interference). The ball will be dead, however, and no runner shall advance on the play.

9.8 BATTING OUT OF TURN

9.8.1 A batter shall be called out, on appeal, when he fails to bat in his proper turn, and another batter completes a time at bat in his place.

9.8.2 The proper batter may take his place in the batter's box at any time before the improper batter becomes a runner or is put out, and any balls and strikes shall be counted in the proper batter's time at bat.

9.8.3 When an improper batter becomes a runner or is put out, and the defensive team appeals to the Umpire before the first pitch to the next batter of either team, or before any play or attempted play, the Umpire shall (1) declare the proper batter out; and (2) nullify any advance or score made because of a ball batted by the improper batter or because of the improper batter's advance to first base on a hit, an error, a base on balls, a hit batter or otherwise.

9.8.4 If a runner advances, while the improper batter is at bat, on a stolen base, balk, wild pitch or passed ball, such advance is legal.

9.8.5 When an improper batter becomes a runner or is put out, and a pitch is made to the next batter of either team before an appeal is made, the improper batter thereby becomes the proper batter, and the results of his time at bat become legal.

9.8.6 When the proper batter is called out because he has failed to bat in the proper turn, the next batter shall be the batter whose name follows that of the proper batter thus called out.

9.8.7 When an improper batter becomes a proper batter because no appeal is made before the next pitch, the next batter shall be the batter whose name follows that of such legalised improper batter. The instant an improper batter's actions are legalised, the batting order picks up with the name following that of the legalised improper batter.

Note: The Umpire shall not direct the attention of any person to the presence in the batter's box of an improper batter. This rule is designed to require constant vigilance by the players and managers of both teams.

There are two fundamentals to keep in mind:

- When a player bats out of turn, the proper batter is the player called out.
- If an improper batter bats and reaches base or is out and no appeal is made before a pitch to the next batter, or before any play or attempted play, the improper batter is considered to have batted in proper turn and establishes the order that is to follow.

Example:

Play 1: Runners on first and third. Charles bats in place of Baker. Charles grounds to short; runner forced at second; Charles beats relay to first; runner on third scores. An appeal is made.

Ruling: Baker is declared out. Runners return to first and third. Charles is next batter.

Play 2: Runners on first and third. Charles bats in place of Baker. Charles grounds to short; runner forced at second; Charles is out at first for double play; runner on third scores. An appeal is made.

Ruling: Baker is declared out. Runners return to first and third. Charles is next batter.

9.9 CATCHER INTERFERENCE

The batter becomes a runner and is entitled to first base without liability to be put out (provided he advances to and touches first base) when the catcher or any fielder interferes with him. If a play follows the interference, the manager of the offence may choose

to decline the interference penalty and accept the result of the play. Such action shall be made immediately at the end of the play. However, if the batter reaches first base on a hit, an error, a base on balls, a hit batsman, or otherwise, and all other runners advance at least one base, the play stands, and the interference is disregarded.

Example: Plays the manager might elect to take the play: Runner on second base. Catcher interferes with the batter. As he bunts the ball fairly sending runner to third base. The manager may rather have runner on third base with an out on the play than have runners on second and first.

Runner on third, one out, batter hits a fly ball to the outfield that the runner scores, but catcher's interference was called. The offensive manager may elect to take the run and have batter called out or have the runner remain at third and batter awarded first base.

Any runner attempting to steal on a catcher's interference with the batter's swing shall be awarded the base the runner is attempting to reach. If a runner is not attempting to steal on the catcher's interference, the runner is not entitled to the next base, unless he is forced to advance because of the batter being awarded first base.

If there is catcher's interference on a squeeze play or a steal of home, the batter is awarded first base, the run scores and all other runners advance one base on the balk created by the interference.

9.10 WHEN BATTER-RUNNER IS OUT

A batter is out when:

9.10.1 His fair or foul fly ball (other than a foul tip) is legally caught by a fielder.

9.10.2 The catcher catches a called, swinging or foul tip third strike.

9.10.3 Three strikes are called, and first base is occupied with less than two out.

9.10.4 After a third strike or after he hits a fair ball, he or first base is tagged before he touches first base.

- 9.10.5** After hitting or bunting a fair ball, his bat hits the ball a second time in fair territory. The ball is dead, and no runners may advance. If he drops his bat and the ball rolls against the bat in fair territory, and in the Umpire's judgement, there was no intention to interfere with the course of the ball, the ball is live and in play. If the batter is in a legal position in the batter's box, and, in the judgement of the Umpire, there was no intent to interfere with the course of the ball, a batted ball that strikes the batter or his bat will be ruled a foul ball.
- 9.10.6** He bunts foul on third strike
- 9.10.7** Swings at a third strike and misses and the ball touches any part of the batter's body or not swung at, and the pitched ball hits the batter while the pitch is in the strike zone.
- 9.10.8** Has a foot completely outside the lines of the batter's box and touching the ground.
- 9.10.9** His fair ball touches him before touching a fielder.
- 9.10.10** After hitting or bunting a ball that continues to move over foul territory, he intentionally deflects the course of the ball in any manner while running to first base.
- 9.10.11** In running the last half of the distance from home plate to first base, while the ball is being fielded to first base, he runs outside (to the right of) the three-foot lane, or inside (to the left of) the foul line, and in the Umpire's judgement in so doing interferes with the fielder taking the throw at first base. Exception: he may run outside (to the right of) the three-foot lane or inside (to the left of) the foul line to avoid a fielder attempting to field a batted ball.
- Comment:** The lines marking the three-foot lane are a part of that lane and a batter-runner is required to have both feet within the three-foot lane or on the lines marking the lane. The batter-runner is permitted to exit the three-foot lane by means of a step, stride, reach or slide in the immediate vicinity of first base for the sole purpose of touching first base.
- 9.10.12** An infielder intentionally drops a fair fly ball or line drive with first, first and second, first and third, or first, second and third base occupied before two are out.

Approved Ruling: In this situation, the batter is not out if the infielder permits the ball to drop untouched to the ground, except when the Infield Fly rule applies.

- 9.10.13** A preceding runner who, in the Umpire's judgement, intentionally interfere with a fielder who is attempting to catch a thrown ball or to throw a ball in an attempt to complete any play.
- Note:** The ball is declared dead, and runners must return to the base that was occupied at the time of the pitch.
- 9.10.14** With two out, a runner on third base, and two strikes on the batter, the runner attempts to steal home on a legal pitch and the ball touches the runner in the batter's strike zone the Umpire will call "Strike Three," the batter is out and the run does not count. Before two are out, the Umpire shall call "Strike Three," the ball is dead, and the run counts.
- 9.10.15** A member of his team (other than a runner) hinders a fielder's attempt to catch or field a batted ball.

RULE 10. BASE RUNNING

Base running happens once the batter safely reaches first base. Base runners then attempt to advance to second base, third base, then finally score at home plate before there are three outs.

10.1 LEGAL ORDER OF BASES

The runner must touch each base in legal order (first, second, third and home) and, when obliged to return while the ball is in play, must retouch the base or bases in reverse order.

Penalty: For failure to touch a base while advancing or returning. The runner is out if the fielder touches him with the ball in his hands before returning to each untouched base. If the base missed was one to which the runner was forced, the runner is out when tagged or if the ball is held by a fielder on any base the runner failed to touch (including home plate).

A base runner after reaching a base legally, cannot run the bases in reverse order to either confuse the fielders or to make a travesty of the game. A runner violating this rule is out.

If a runner is in a run down between bases and the following runner occupies the same base that the first runner has left, the second runner cannot be put out while occupying said base. If the first runner, however, returns safely to the base last touched and both runners are then occupying the same base, the second runner is out, if touched with the ball and there is no force.

Note: No runner shall advance on an interference play called on another runner. A runner is considered to occupy a base until he legally has reached and touched the next base.

The failure of a preceding runner to touch or retouch a base (and who is therefore declared out) shall not affect the status of a following runner who touches each base in proper order, except that, after two are out, a following runner cannot score a run when a preceding runner is declared out for failing to touch a base.

10.2 BATTER BECOMES BASE RUNNER

The batter becomes a base runner:

10.2.1 Immediately after the individual makes a fair hit.

Note: If the batter hits a pitch that touches the ground first, the following action shall be the same as if hit the ball in flight.

10.2.2 The third strike called by the Umpire is not caught, providing:

- First base is unoccupied.
- First base is occupied with two out.

Note: A batter who does not realise his situation on a third strike not caught, and who is not in the process of running to first base, shall be declared out once he leaves the dirt circle surrounding home plate.

10.2.3 If the pitch touches the ground and bounces through the strike zone it is a "ball." If such a pitch touches the batter he shall be awarded first base. If the batter swings at such a pitch after two strikes, the ball cannot be caught.

10.2.4 A fair ball, after having passed a fielder other than the pitcher, or after having been touched by a fielder, including the pitcher, shall touch an Umpire or runner on fair territory.

10.2.5 A fair ball passes over a fence or into the stands at a distance from home plate of 250 feet (76.2 m) or more. Such hit entitles the batter to a home run when he shall have touched all bases legally. A fair fly ball that passes out of the playing field at a point less than 250 feet (76.2 m) from home plate shall entitle the batter to advance to second base only.

10.2.6 A fair ball, after touching the ground, bounds into the stands, or passes through, over or under a fence, or through or under a scoreboard, or through or under shrubbery, or vines on the fence, in which case the batter and the runners shall be entitled to advance two bases.

10.2.7 Any fair ball which, either before or after touching the ground, passes through or under a fence, or through or under a scoreboard, or through any opening in the fence or scoreboard, or through or under shrubbery, or vines on the fence, or which sticks in a fence or scoreboard, in which case the batter and the runners shall be entitled to two bases.

10.2.8 Any bounding fair ball is deflected by the fielder into the stands, or over or under a fence on fair or foul territory, in which case the batter and all runners shall be entitled to advance two bases.

10.2.9 Any fair fly ball is deflected by the fielder into the stands, or over the fence into foul territory, in which case the batter shall be entitled to advance to second base. If it is deflected into the stands or over the fence in fair territory, the batter shall be entitled to a home run. However, should such a fair fly ball be deflected at a point less than 250 feet (76.2 m) from home plate, the batter shall be entitled to two bases only.

The batter becomes a runner and is entitled to first base without the liability to be put out (provided he advances to and touches first base):

10.2.10 After four balls have been called by the Umpire or if awarded an intentional base on balls.



10.2.11 When hit by a pitched ball at which the individual is not attempting to strike the ball is immediately dead.

10.2.11.1 A batter may not make a movement to intentionally get hit by the pitch, no matter where the pitch is. He must also avoid being hit whenever possible, unless the pitch is within the batter's box occupied by the batter. If the batter's reaction is determined to be intentional, then:

- If the ball is in the strike zone when it touches the batter, or if the batter moves to intentionally get hit by the pitch, it shall be called a strike and the batter is not awarded first base.
- If the ball is within the batter's box occupied by the batter and the batter makes no movement to intentionally get hit by the pitch, the batter is awarded first base.

10.2.11.2 If the pitch is ball four, the batter will be awarded first base and credited for being hit by the pitch (the ball is dead).

10.2.12 If any defensive player interferes with the batter's swing or prevents the individual from striking at a pitched ball.

10.2.13 A fair ball touches an Umpire or a runner on fair territory before touching a fielder.

Note: If a fair ball touches an Umpire after having passed a fielder other than the pitcher, or having touched a fielder, including the pitcher, the ball is in play.

10.3 ENTITLED TO BASES OR OCCUPYING A BASE

10.3.1 A runner acquires the right to an unoccupied base when he touches it before he is put out. He is then entitled to it until he is put out or forced to vacate it for another runner legally entitled to that base.

10.3.2 Two runners may not occupy a base, but if, while the ball is alive, two runners are touching a base, the following runner shall be out when tagged and the preceding runner is entitled to the base, unless Rule 10.4 applies.

10.4 ADVANCING BASES

In advancing, a runner shall touch first, second, third and home base in order. If forced to return, he shall retouch all bases in reverse order.

If a runner is forced to advance because the batter becomes a runner and two runners are touching a base to which the following runner is forced, the following runner is entitled to the base and the preceding runner shall be out when tagged or when a fielder has the ball and touches the base to which that preceding runner is forced.

Each runner, other than the batter, may without liability to be put out, advance one base when:

10.4.1 There is a balk.

10.4.2 The batter's advance without liability to be put out forces the runner to vacate his base, or when the batter hits a fair ball that touches another runner or the Umpire before the ball has been touched by, or has passed a fielder, if the runner is forced to advance.

10.4.3 A fielder, after catching a fly ball, steps or falls into any out of play area. When a fielder, after having made a legal catch, steps or falls into any out of play area, the ball is dead and each runner shall advance one base, without the liability to be put out, from his last legally occupied base at the time the fielder entered out of play area.

10.4.4 A spectator or any other individual intentionally interferes with any thrown or batted ball.

10.4.5 While the runner is attempting to steal a base, the batter is interfered with by the catcher or any other fielder.

10.4.6 A fielder deliberately touches a pitched ball with his cap, mask or any part of his uniform detached from its proper place on his person. The ball is in play, and the award is made from the position of the runner at the time the ball was touched.

10.4.7 Each runner including the batter-runner may, without liability to be put out, advance:



- 10.4.7.1 To home plate, scoring a run, if a fair ball goes out of the playing field in flight and he touches all the bases legally. Or if a fair ball which, in the Umpire's judgement, would have gone out of the playing field in flight, is deflected by the act of a fielder in throwing his glove, cap, or any article of his clothing.
- 10.4.7.2 Three bases, if a fielder deliberately touches a fair ball with his cap, mask or any part of his uniform detached from its proper place. The ball is in play and the batter may advance to home plate at his own risk.
- 10.4.7.3 Three bases, if a fielder deliberately throws his glove at and touches a fair ball. The ball is in play and the batter may advance to home plate at his own risk.
- 10.4.7.4 Two bases, if a fielder deliberately touches a thrown ball with his cap, mask or any part of his uniform detached from its proper place. The ball is in play.
- 10.4.7.5 Two bases, if a fielder deliberately throws his glove at and touches a thrown ball. The ball is in play.

Note: The Umpire must rule that the thrown glove or detached cap, mask has touched the ball. There is no penalty if the ball is NOT touched.

There is no penalty if the glove of the fielder is knock off by the force of a batted or thrown ball, or if his glove flies off his hand in an obvious effort to make a legitimate catch.

- 10.4.7.6 Two bases, if a fair ball bounces or is deflected into the stands outside the first or third base foul lines. Or if goes through or under a field fence, a scoreboard, shrubbery, or vines on the fence or if it sticks in the fence, shrubbery, scoreboard, or vines.
- 10.4.7.7 Two bases when, with no spectators on the playing field, a thrown ball goes into the stands or into a bench or over, through, under a field fence or a slanting part of the screen above the backstop or stays in the meshes of a wire screen protecting spectators. The ball is dead. When such wild throw is the first play by an infielder, the Umpire,

in awarding such bases, shall be governed by the position of the runners at the time the ball was pitched. In all other cases the Umpire shall be governed by the position of the runners at the time the wild throw was made.

Note: In certain circumstances it is impossible to award a runner two bases. For example: Runner on first. Batter hits a fly to short right. Runner holds up between first and second and batter comes around first and pulls up behind him. Ball falls safely. Outfielder, in throwing to first base, throws the ball into the stands.

Ruling: Since no runner, when the ball is dead, may advance beyond the base to which he is entitled, the runner originally on first base goes to third base and the batter runner is held at second base.

- 10.4.7.8 One base, if a pitched ball to the batter or thrown by the pitcher from his position on the pitcher's plate to a base to catch a runner, goes into the stands or a bench or through or over a fence or backstop. The ball is dead.

Approved Ruling: When a wild pitch or a passed ball goes through or by the catcher or deflects off the catcher and goes directly out of play, the award is one base. If, however, the pitched or thrown ball goes through the catcher or the fielder but remains in play and the catcher or fielder inadvertently deflects it to the stands or dugout or other area in dead ball territory, the award is two base from the position of the runners at the time of the pitch or throw.

10.5 DEAD BALLS

The ball becomes dead, and runners advance one base, or return to their bases, without liability to be put out, when:

- 10.5.1 A pitched ball touches a batter, or his clothing, while in his legal batting position, runners, if forced, advance
- 10.5.2 The plate Umpire interferes with the catcher's throw attempting to prevent a stolen base or retire a runner on a pick-off play, runners may not advance.

Note: The interference will be disregarded if the catcher's throw retires the runner.

While the ball is dead no player may be put out, no bases may be run and no runs may be scored, except that runners may advance one or more bases as the result of acts which occurred while the ball was alive (such as, but not limited to a balk, an overthrow, interference, or a homerun or other fair ball hit out of the playing field).

Umpire Interference can also happen when an Umpire interferes with a catcher returning the ball to the pitcher.

- 10.5.3** A balk is committed, runners advance.
- 10.5.4** A ball is illegally batted; runners return.
- 10.5.5** A foul ball is not caught, in which case runners return to their bases. The plate Umpire will not put the ball in play until all runners have retouched their bases.
- 10.5.6** A fair ball touches a runner or an Umpire on fair territory before it touches an infielder including the pitcher or touches an Umpire before it has passed an infielder other than the pitcher, runners advance, if they are forced.

If a fair ball goes through, or by, an infielder and no other infielder has a chance to make a play on the ball and the ball touches a runner immediately behind the infielder that the ball went through, or by, the ball is in play and the Umpire shall not declare the runner out. If a fair ball touches a runner after being deflected by an infielder, the ball is in play and the Umpire shall not declare the runner out.

Comment: If a fair ball touches an Umpire working in the infield after it has gone past, or over, the pitcher, it is a dead ball. If a batted ball is deflected by a fielder in fair territory and hits a runner or an Umpire while still in flight and then caught by an infielder it shall not be a catch, but the ball shall remain in play.

- 10.5.7** A pitched ball lodges in the catcher's mask or paraphernalia, or in or against the Umpire's body, mask, or paraphernalia, and remains out of play, runners advance one base.

Comment: If a foul tip hits the Umpire and is caught by a fielder on the rebound, the ball is "dead" and the batter cannot be called out. The same shall apply where such foul tip lodges in the Umpire's mask or other paraphernalia.

If a third strike (not a foul tip) passes the catcher and hits an Umpire, the ball is in play. If that ball rebounds and is caught by a fielder before it touches the ground, the batter is not out on such a catch, but the ball remains in play and the batter may be retired at first base or touched with the ball for the out.

If a pitched ball lodges in the Umpire's or catcher's mask or paraphernalia, and remains out of play, on the third strike or fourth ball, then the batter is entitled to first base and all runners advance one base. If the count on the batter is less than three balls, runners advance one base.

If a ball is intentionally placed inside a player's uniform (e.g., a pants pocket) for the purpose of deceiving a base runner, the Umpire shall call "Time." The Umpire will place all runners at least one base (or more if warranted, in the Umpire's judgement, to nullify the action of the ball being put out of play), from the base they originally occupied.

- 10.5.8** Any legal pitch touches a runner trying to score, runners advance.

10.6 FORCE PLAY-SLIDE RULE (SLIDING TO BASES ON DOUBLE PLAY ATTEMPTS)

If a runner does not engage in a bona fide slide, and initiates (or attempts to make) contact with the fielder for the purpose of breaking up a double play, he should be called for interference under this rule. A "bona fide slide" for purposes of this rule occurs when the runner:

- 10.6.1** Begins his slide (i.e., makes contact with the ground) before reaching the base.
- 10.6.2** Is able and attempts to reach the base with his hand or foot.
- 10.6.3** Is able and attempts to remain on the base (except home plate) after completion of the slide.
- 10.6.4** Slides within reach of the base without changing his pathway for the purpose of initiating contact with a fielder.

A runner who engages in a “bona fide slide” shall not be called for interference under this rule. Even in cases where the runner makes contact with the fielder as a consequence of a permissible slide. In addition, interference shall not be called where a runner’s contact with the fielder was caused by the fielder being positioned in (or moving into) the runner’s legal pathway to the base.

Notwithstanding the above, a slide shall not be a “bona fide slide” if a runner engages in a “roll block,” or intentionally initiates (or attempts to initiate) contact with the fielder by elevating and kicking his leg above the fielder’s knee or throwing his arm or his upper body.

If the Umpire determines that the runner violated this rule, the Umpire shall declare both the runner and batter-runner out. Note, however, that if the runner has already been put out then the runner on whom the defence was attempting to make a play shall be declared out.

Note: Runners cannot advance, and runs do not score.

10.7 WHEN RUNNERS ARE OUT

Any runner is out when:

- 10.7.1** In running to a base, he runs more than 3 feet (0.91 m) away from his base path to avoid being tagged unless his action is to avoid interference with a fielder fielding a batted ball. A runner’s base path is established when the tag attempt occurs and is a straight line from the runner to the base he is attempting to reach safely.
- 10.7.2** After touching first base, he leaves the base path, obviously abandoning his effort to touch the next base.
- 10.7.3** He intentionally interferes with a thrown ball or hinders a fielder attempting to make a play on a batted ball.
- 10.7.4** He is tagged, when the ball is alive, while off his base.

Exception: A batter-runner cannot be tagged out after overrunning or over-sliding first base if he returns immediately to the base. Makes no attempt to advance to the next base.

10.7.5 He fails to retouch his base after a fair or foul ball is legally caught before he, or his base, is tagged by a fielder. He shall not be called out for failure to retouch his base after the first following pitch, or any play or attempted play. This is an appeal play.

10.7.6 He or the next base is tagged before he touches the next base, after he has been forced to advance by reason of the batter becoming a runner. However, if a following runner is put out on a force play, the force is removed as soon as the runner touches the base to which he is forced to advance, and if he overslides or overruns the base, the runner must be tagged to be put out. However, if the forced runner, after touching the next base, retreats for any reason towards the base he had last occupied, the force play is reinstated, and he can again be put out if the defence tags the base to which he is forced.

Play: Runner on first and three balls on the batter. Runner steals on the next pitch, which is ball four, but after having touched second, he overslides or overruns that base. Catcher’s throw catches him before he can return.

Ruling: Runner is out. Force is removed.

Comment: Oversliding and overrunning situations arise at bases other than first base. For instance, before two are out, and runners on first and second, or first, second and third, the ball is hit to an infielder who tries for the double play. The runner on first beats the throw to second base but overslides the base. The relay throw is made to first base and the batter runner is out. The first baseman, seeing the runner at second base off the bag, makes the return throw to second and the runner is tagged off the base. Meanwhile runners have crossed the plate. Is this a force play? Was the force removed when the batter runner was out at first base? Do the runs that crossed the plate during this play and before the third out was made when the runner was tagged at second, count?

The runs score. It is not a force play. It is a tag play.

10.7.7 He is touched by a fair ball in fair territory before the ball has gone through or by an infielder and no other infielder has a chance to make a play on the ball. The ball is dead, and no runner may score, nor runners advance, except runners forced to advance.

Exception: If a runner is touching his base when hit by an Infield Fly, he is not out, although the batter is out. If a runner is touched by an Infield Fly when he is not touching his base, and before the ball has gone through, or by an infielder and no other infielder has a chance to make a play on the ball, both the runner and batter are out. Regardless of whether a runner is touching his base or not when touched by an Infield Fly before the ball has gone through or by an infielder and no other infielder has a chance to make a play on the ball, the ball is dead and no runner may score, nor runners advance, except runners forced to advance.

- 10.7.8** He attempts to score on a play in which the batter interferes with the play at home base before two are out. With two out, the interference puts the batter out and no score counts.
- 10.7.9** He passes a preceding runner before that runner is out.
- 10.7.10** After he has acquired legal possession of a base, he runs the bases in reverse order for the purpose of confusing the defence or making a travesty of the game. The Umpire shall immediately call "Time" and declare the runner out.
- 10.7.11** He fails to return at once to first base after overrunning or oversliding that base. If he attempts to run to second, he is out when tagged. If, after overrunning or oversliding first base he starts toward the dugout, or toward his position, and fails to return to first base at once, he is out, on appeal, when he or the base is tagged.
- 10.7.12** In running or sliding to home plate, he fails to touch home plate and makes no attempt to return to the plate, when a fielder holds the ball in his hand, while touching home base, and appeals to the Umpire for the decision.
- Note:** This rule applies only when the runner is on his way to the bench and the catcher would be required to chase him. It does not apply to the ordinary play when a runner misses the plate and then immediately makes an effort to touch the plate before being tagged. In that case, the runner must be tagged.
- 10.7.13** A play is being made on him and a member of his team (other than a runner) hinders a fielder's attempt to field a thrown ball.

- 10.7.14** A coach, touches or holds a runner, physically assists the runner in returning to or leaving a base.
- 10.7.15** While third base is occupied, the third base coach runs in the direction of home plate on or near the base line while a fielder is making or trying to make a play and thereby draws a throw to home plate. The base runner on third shall be declared out for the coach's interference.
- 10.7.16** A batter runner throws the bat, which interferes with a defensive player making a play.
- 10.7.17** The runner deliberately knocks the ball from the fielder's hand. The ball is immediately dead.
- 10.7.18** A batter or any other runner who has just been put out interferes with a play being made on a runner.

RULE 11. APPEAL PLAYS

11.1 WHEN RUNNERS ARE OUT ON APPEALS

- A runner shall be called out on appeals that occur because of a base running error when:
- 11.1.1** The base runner does not retouch the base before a fielder tags the runner or the base after a fair or foul fly ball is touched in making a legal catch.
- 11.1.2** With the ball in play, while advancing or returning to a base, he fails to touch each base in order before he, or a missed base is tagged.

Approved Ruling:

- 11.1.3** No runner may return to touch a missed base after a following runner has scored.

11.1.4 When the ball is dead, no runner may return to touch a missed base or one he has left after he has advanced to and touched a base beyond the missed base.

Play: A batter hits the ball out of the park or a ground rule double and misses first base (ball is dead) he may return to first base to correct his mistake before he touches second. If he touches second, he may not return to first and if defensive team appeals, he is declared out at first.

Batter hits the ball to shortstop who throws wild into the stands. Ball is dead. Batter runner misses first base but is awarded second base on the overthrow. Even though the Umpire has awarded the runner second base, the runner must touch first base before he proceeds to second base. These are appeal plays.

11.1.5 The runner starts from a position behind the base in order to get a running start, whether on a pitch or tagging up for a fly ball.

11.1.6 He fails to touch home plate and makes no attempt to return to that base, and home plate is tagged.

Any appeal under this rule must be made before the next pitch, or any play or attempted play. If the violation occurs during a play which ends a half inning, the appeal must be made before the defensive team leaves the field. For the purpose of identifying left the field, the pitcher and all infielders have left fair territory and the catcher has left his position.

11.1.7 The procedure for a base running appeal play is as follows:

11.1.7.1 A live ball is returned to the base.

11.1.7.2 If the ball is dead, the pitcher must receive a ball from the Umpire and then take a position on the pitcher's rubber. After the Umpire calls "PLAY" the pitcher may legally step back off the rubber and return the ball to the base and the fielder may tag the runner or the base.

11.1.8 An appeal is not to be interpreted as a play or an attempted play. Exception: if the pitcher balks on an appeal attempt, it is considered a play.

11.1.9 The defensive team receives only one chance on an appeal. In the case of multiple appeals, if the defence errs during its first appeal attempt or any base runner advances, the defence loses its right to appeal any runner at any base.

11.1.10 If the offensive team initiates a play before the next pitch, the defensive team does not lose its right to appeal.

Example: Two outs. R2 misses third base on his way to home plate. Batter-runner stops at first base. If the defensive team appeals at third base and is successful, that is the third out and no runs score. Batter-runner knows this so he takes off for second base before the defensive teams appeals. If the defensive team makes a play on him and retires him, they still have the opportunity to appeal R2 missing third base.

11.1.11 If there is possibly more than one runner involved in an appeal at a base, the defensive team must declare on which runner the appeal is being made. If the defensive team fails to identify which runner, the Umpire should give no signal. If the appeal is made on the improper runner, the Umpire shall give the safe sign and no further appeal shall be allowed at that base.

11.1.12 If there are two or more appeals during a play, which could make a total of "four outs" in an inning, the defensive team may choose to take any out it desires.

11.1.13 If there are two outs before the appeal on a runner, the appeal becoming the third out, no runners following the appealed out shall score. If the appeal is a force out, no runners preceding or following the appealed out shall score.

11.1.14 It is not a balk for a pitcher, while in contact with the rubber (does not step back) to throw to an unoccupied base for the purpose of making an appeal play.

Comment: An appeal should be clearly intended as an appeal, either by a verbal request by the player or an act that unmistakably indicates an appeal to the Umpire. A player inadvertently stepping on the base with a ball in his hand, would not constitute an appeal. Time is not out when an appeal is being made.

11.2 EFFECT OF PRECEDING RUNNER'S FAILURE TO TOUCH A BASE

Unless two are out, the status of a following runner is not affected by a preceding runner's failure to touch or retouch a base. If, upon appeal, the preceding runner is the third out, no runners following him shall score. If such third out is the result of a force play, neither preceding nor following runners shall score.

11.3 RETIRING THE SIDE

When three offensive players are legally put out, that team takes the field and the opposing team becomes the offensive team.

RULE 12. INTERFERENCE, OBSTRUCTION AND CATCHER COLLISIONS

12.1 BATTER OR RUNNER INTERFERENCE

It is interference by a batter or a runner when:

12.1.1 After a third strike that is not caught by the catcher, the batter-runner clearly hinders the catcher in his attempt to field the ball. Such batter-runner is out, the ball is dead, and all other runners return to the bases they occupied at the time of pitch. If a pitch that is not caught remains in the vicinity of home plate and it is inadvertently deflected by the batter or Umpire, the ball is dead and the runners return to the bases they occupied at the time of the pitch (but if the pitch was strike three, the batter is out).

Comment: If the pitched ball deflects off the catcher or Umpire and subsequently touches the batter-runner, it is not considered interference unless, in the judgement of the Umpire, the batter-runner clearly hinders the catcher in his attempt to field the ball.

12.1.2 He intentionally deflects the course of a foul ball in any manner.

12.1.3 Before two are out and a runner on third base, the batter hinders a fielder in making a play at home base, the runner is out.

12.1.4 Any member or members of the offensive team stand or gather around any base to which a runner is advancing, to confuse, hinder

or adding to the difficulty of making the play. Such runner will be declared out for the interference of his teammate or teammates.

12.1.5 Any batter or runner who has just been put out, or any runner who has just scored, hinders, or impedes any following play being made on a runner. Such runner will be declared out for the interference of his teammate.

12.1.6 If, in the judgement of the Umpire, a base runner wilfully and deliberately interferes with a batted ball or a fielder in the act of fielding a batted ball with the obvious intent to break up a double play, the ball is dead. The Umpire shall call the runner out for interference and also call out the batter-runner because of the action of his teammate. In no event may bases be run or runs scored because of such action by a runner.

12.1.7 If, in the judgement of the Umpire, a batter-runner wilfully and deliberately interferes with a batted ball or a fielder in the act of fielding a batted ball with the obvious intent to break up a double play, the ball is dead. The Umpire shall call the batter-runner out for interference and shall call out the runner who had advanced closest to home plate regardless of where the double play might have been possible. In no event may bases be run because of such interference.

12.1.8 In the judgement of the Umpire, the base coach at third base, or first base, by touching or holding the runner, physically assists him in returning to or leaving third base or first base.

12.1.9 With a runner on third base, the base coach leaves his box and runs in the direction of home plate or near the baseline while a fielder is attempting to make a play on a batted or thrown ball, and thereby draws a throw to home plate.

12.1.10 He fails to avoid a fielder who is attempting to field a batted ball, or intentionally interferes with a thrown ball, provided that if two or more fielders attempt to field a batted ball, and the runner comes in contact with one or more of them, the Umpire shall determine which fielder is entitled to the benefit of this rule, and shall not declare the runner out for coming in contact with a fielder other than the one the Umpire determines to be entitled to field such a ball. The Umpire shall call the runner

out. If the third out occurs because a runner is declared out for interference on a foul batted ball, the batter-runner is considered to have completed his at bat, and the first batter up the following inning will be the player who follows him in the batting order (if there are less than two outs, the batter will complete his at-bat). If the batter-runner is adjudged not to have hindered a fielder attempting to make a play on a batted ball, and if the base runner's interference is adjudged not to be intentional, the batter-runner shall be awarded first base.

- 12.1.11** A fair ball touches him in fair territory before touching a fielder. If a ball goes through, or by, an infielder, and touches a runner immediately back of him, or touches the runner after having been deflected by a fielder, the Umpire shall not declare the runner out for being touched by a batted ball. In making such decision the Umpire must be convinced that the ball passed through, or by, the fielder, and that no other infielder had the opportunity to make a play on the ball. If, in the judgement of the Umpire, the runner deliberately and intentionally kicks such a batted ball on which the infielder has missed a play, then the runner shall be called out for interference.

PENALTY FOR INTERFERENCE

The runner is out and the ball is dead.

If the Umpire declares the batter, batter-runner, or a runner out for interference, all other runners shall return to the last base that was in the judgement of the Umpire, legally touched at the time of the interference, unless otherwise provided by these rules.

In the event the batter-runner has not reached first base, all runners shall return to the base last occupied at the time of the pitch, provided, however, if during an intervening play at the plate with less than two outs a runner scores, and then the batter-runner is called out for interference outside the three-foot lane, the runner is safe, and the run shall count.

Comment: A runner who is adjudged to have hindered a fielder who is attempting to make a play on a batted ball is out whether it was intentional or not.

If, however, the runner has contact with a legally occupied base when he hinders the fielder, he shall not be called out unless, in the Umpire's judgement, such hindrance, whether it occurs on fair or foul territory, is intentional. If the Umpire declares the hindrance intentional, the following

penalty shall be applied: With less than two out, the Umpire shall declare both the runner and batter-runner out. With two out, the Umpire shall declare the batter out.

If, in a run-down between third base and home plate, the succeeding runner has advanced and is standing on third base when the runner in a run-down is called out for offensive interference, the Umpire shall send the runner standing on third base back to second base.

This same principle applies if there is a run-down between second and third base and the following runner has reached second (the reasoning is that no runner shall advance on an interference play and a runner is considered to occupy a base until he legally has reached the next succeeding base).

12.2 FIELDER RIGHT OF WAY

The players, coaches, or any member of a team at bat must vacate any space or area (including both dugouts or bullpens) needed by a fielder who is attempting to field a batted or thrown ball. If a member of the team at bat (other than a runner) hinders a fielder's attempt to catch or field a batted ball, the ball is dead, the batter is declared out and all runners return to the bases occupied at the time of the pitch. If a member of the team at bat (other than a runner) hinders a fielder's attempt to field a thrown ball, the ball is dead, the runner on whom the play is being made shall be declared out and all runners return to the last legally occupied base at the time of the interference.

12.3 UNINTENTIONAL INTERFERENCE

In case of unintentional interference with play by any person authorised to be on the playing field (except members of the team at bat who are participating in the game, or a base coach, any of whom interfere with a fielder attempting to field a batted or thrown ball, or an Umpire) the ball is alive and in play. If the interference is intentional, the ball shall be dead at the moment of the interference and the Umpire shall impose such penalties as in his opinion will nullify the act of interference.

The question of intentional or unintentional interference shall be decided based on the person's action. For example: a bat boy, ball attendant, policeman, etc., who tries to avoid being touched by a thrown or batted ball but still is touched by the ball would be considered unintentional interference. If, however, he picks up the ball, catches it, or touches the ball by intentionally pushing

or kicking at the ball, this act would be considered intentional interference.

Play: Batter hits ball to third baseman, who fields the ball but throws it wild past the first baseman. The first base coach falls to the ground in trying to avoid being hit by the ball. The first baseman going to retrieve the ball runs into the coach. The batter-runner finally ends up on third base. Whether the Umpire should call interference on the part of the coach is up to the judgment of the Umpire and if the Umpire felt that the coach did all he could to avoid interfering with the play, no interference need be called. If, in the judgement of the Umpire, the coach was attempting to make it appear that he was trying not to interfere, the Umpire should rule interference.

12.4 SPECTATOR INTERFERENCE

When there is spectator interference with any thrown or batted ball, the ball shall be dead at the moment of interference and the Umpire shall impose such penalties as in his opinion will nullify the act of interference.

Penalty: If spectator interference clearly prevents a fielder from catching a fly ball, the Umpire shall declare the batter out.

Comment: If a spectator reaches over, under, or through a barrier and touching a ball in play or interfering with a fielder trying to make a play. Batter and runners shall be placed where in the Umpire's judgement they would have been had the interference not occurred.

No interference will be called when a fielder reaches over a fence, railing or into the stands to catch a ball. He does so at his own risk. However, should a spectator reach out on the playing field side of the fence, railing and clearly prevents the fielder from catching the ball, then the batter will be called out for spectator interference.

Example: Runner on third base, one out and a batter hits a fly ball deep to the outfield (fair or foul). Spectator clearly interferes with the outfielder attempting to catch the fly ball. Umpire calls the batter out for spectator interference. Ball is dead at the time of the call. Umpire decides that because of the distance the ball was hit, the runner on third base would have scored after the catch if the fielder had caught the ball which was interfered with, therefore, the

runner is permitted to score. This might not be the case if the fly ball was a short distance from home plate.

12.5 UMPIRE OR COACH INTERFERENCE

Umpire interference occurs when a plate Umpire hinders, impedes, or prevents a catcher's throw attempting to prevent a stolen base or retire a runner on a pick-off play.

Note: Ball is dead. Runners may not advance.

Another is when a fair ball touches an Umpire on fair territory before passing a fielder.

Note: Ball is dead. Batter-runner is awarded first, all other runners advance if they are forced.

Umpire interference may also occur when an Umpire interferes with a catcher returning the ball to the pitcher.

Note: Ball is dead. Runners may not advance.

If a coach intentionally interferes with a thrown ball, the runner is out. Any other runners must return to the last base touched.

If a thrown ball or pitched ball strikes an Umpire, the ball is in play and the base runner or runners are entitled to advance at their own risk.

If a thrown ball hits a base coach in foul territory, the ball is in play.

12.6 INTERFERENCE WITH SQUEEZE PLAY OR STEAL OF HOME

If the catcher interferes on a squeeze play or a steal of home, that is if the catcher does not have possession of the ball or touches the batter or his bat, the pitcher shall be charged with a balk, the batter shall be awarded first base on the interference and the ball is dead.

12.7 OBSTRUCTION

Obstruction is the act of a fielder who, while not in possession of the ball and not in the act of fielding the ball, impedes the progress of any runner. If a fielder is about to receive a thrown ball and if the ball is in flight directly toward and near enough to the fielder so he must occupy his position to receive the ball he may be considered "in the act of fielding the ball." It is entirely up to the judgement of the Umpire as to whether a fielder is in the act of fielding a ball.

After a fielder has made an attempt to field the ball and missed, he can no longer be in the “act of fielding” the ball. For example: an infielder dives at a ground ball and the ball passes him and he continues to lie on the ground and delays or impedes the progress of the runner, he very likely has obstructed the runner.

There are two types of obstruction. These types are commonly referred to as Type A Obstruction and Type B Obstruction.

TYPE A OBSTRUCTION

Type A Obstruction occurs when the defence is making a play on the runner who was obstructed or when the batter-runner is obstructed before first base.

That is the rule definition of obstruction. However, to better understand the rule we have to know what is meant by “not in possession of the ball” and “in the act of fielding the ball.”

What is the definition of “in the act of fielding the ball”? The Umpire must know what is a legal attempt at fielding the ball. The definition is a legitimate effort by a fielder to retire a runner. What is a legitimate effort? Reasonable and ordinary effort. For example, if a fielder mishandles a ground ball but it is within a step and a reach, then he is considered to be making a play.

Some common examples of Type A Obstruction are:

- 12.7.1** The batter-runner is obstructed before reaching first base on a ground ball to an infielder.
- 12.7.2** A runner is obstructed while in a rundown.
- 12.7.3** A runner is obstructed as a fielder is throwing to a base in an attempt to retire that runner (including a pickoff attempt or a stolen base attempt).

When Type A obstruction occurs, the Umpire shall call or signal “OBSTRUCTION.”

If a play is being made on the obstructed runner, or if the batter-runner is obstructed before he touches first base, the ball is dead and all runners shall advance, without liability to be put out, to the bases they would have reached, in the Umpire’s judgement, if there had been no obstruction. The obstructed runner shall be awarded at least one base beyond the base he had last legally touched before the obstruction.

Any preceding runners, forced to advance by the award of bases as the penalty for obstruction, shall advance without liability to be put out.

Exception: If the batter-runner is obstructed before first base (a form of Type A Obstruction) after he has hit a fly ball, and that fly ball is legally caught by a fielder, the play shall proceed with no reference to the obstruction. In this situation, the obstruction on the batter-runner has no impact on the batter-runner’s ability to advance on the bases because the batted ball was caught.

Comment: When a play is being made on an obstructed runner, the Umpire shall signal obstruction in the same manner that he calls “Time,” with both hands overhead. The ball is immediately dead when this signal is given. However, should a thrown ball be in flight before the obstruction is called by the Umpire, the runners are to be awarded such bases on wild throws as they would have been awarded had not obstruction occurred. On a play where the runner was trapped between second and third and obstructed by the third baseman going into third while the throw is in flight from the shortstop, if such throw goes into the dugout the obstructed runner is to be awarded home base. Any other runners on base in this situation would also be awarded two bases from the base they last legally touched before obstruction was called.

TYPE B OBSTRUCTION

Type B Obstruction is when the runner is obstructed while NO PLAY is being made on that runner.

Some common examples of Type B Obstruction are:

- 12.7.4** The batter-runner is obstructed (usually by the first baseman, but it could be another fielder) after rounding first base on a hit to the outfield.
- 12.7.5** A runner is held or pushed by a fielder after a missed or wild throw gets past that fielder.
- 12.7.6** A runner is forced to change course or direction because a fielder (while not in possession of the ball or in the act of making a play) is standing in his way.

12.7.7 The batter-runner is obstructed before first base on a base hit to the outfield.

When Type B obstruction occurs, the Umpire should point at the offence and vocalise "That's Obstruction." The play shall proceed until no further action is possible. If a subsequent play is made on a previously obstructed runner and that runner is tagged out before he has reached the base that he would have reached had the obstruction not occurred, the Umpire shall call "Time" at the moment that the obstructed runner is tagged out. The Umpire will impose any penalties that will nullify the obstruction, awarding the obstructed runner the base that he would have reached had the obstruction not occurred. The Umpire may consider many factors in determining where to place an obstructed runner. The position of the ball when the obstruction occurred, the position of the runner when the obstruction occurred, the speed of the runner at the time of the obstruction and after the obstruction occurred. Also, if the base coach is holding the runner. The umpiring crew may consult with one another to reasonably determine where the runners should be placed in order to nullify the obstruction.

Comment: When the ball is not dead on obstruction and an obstructed runner advances beyond the base which, in the Umpire's judgement, he would have been awarded because of being obstructed, he does so at his own peril and may be tagged out. This is a judgement call.

Note: The catcher, without the ball in his possession, has no right to block the pathway of the runner attempting to score. The base line belongs to the runner and the catcher should be there only when he is fielding a ball or when he already has the ball in his possession.

12.8 COLLISION RULE

The WBSC is concerned about unnecessary and violent collisions primarily with the catcher at home plate, and with infielders at all bases. The intent of this rule is to encourage base runners and defensive players to avoid such collisions whenever possible.

12.8.1 When there is a collision between a runner and a fielder who clearly is in possession of the ball, the Umpire shall judge:

12.8.1.1 Whether the collision by the runner was avoidable (could

the runner have reached the plate without colliding) or unavoidable (the runner's path to the plate was blocked).

12.8.1.2 Whether the runner was attempting to reach the plate or attempting to dislodge the ball from the fielder. Contact above the waist shall be judged by the Umpire as an attempt to dislodge the ball from the fielder.

12.8.1.3 Whether the runner was using flagrant contact to maliciously dislodge the ball.

Penalty: If the runner attempted to dislodge the ball, the runner shall be declared out even if the fielder loses possession of the ball. The ball is dead and all other base runners shall return to the last base touched at the time of the interference.

If the fielder blocks the path of the base runner to the plate, the runner may make contact, slide into, or collide with a fielder as long as the runner is making a legitimate attempt to reach the plate.

If the flagrant or malicious contact by the runner was before the runner's touching the plate, the runner shall be declared out and ejected from the game. The ball is dead immediately. All other base runners shall return to the base they occupied at the time of the interference.

12.8.1.4 If the contact was after a preceding runner had touched home plate, the preceding runner will be ruled safe, the ball becomes dead immediately and all other base runners will return to the base they had last touched prior to the contact.

12.8.1.5 If the runner is safe and the collision is malicious, the runner shall be ruled safe and ejected from the game.

12.8.2 If the defensive player blocks the plate or base line clearly without possession of the ball, obstruction shall be called. The Umpire shall point and call, "That's Obstruction." The Umpire shall let the play continue until all play has ceased, call time, and award any bases that are justified per WBSC Official Rules of Baseball. The obstructed runner is awarded at least one base beyond the base last touched legally before the obstruction.

12.8.2.1 If the base runner collides flagrantly, the runner shall be declared safe on the obstruction, but will be ejected from the game. The ball is dead.

12.8.2.2 If the runner's path to the base is blocked and all stipulations above are fulfilled, it is considered unavoidable contact.

RULE 13. PITCHING

13.1 PITCHING POSITIONS

There are two legal pitching positions. The wind-up and the set position. Either one can be used at any time.

13.2 LEGAL PITCHING POSITIONS

Pitchers must take signs from the catcher while in contact with the pitcher's plate.

Comment: Pitchers may disengage the rubber after taking their signs but may not step quickly onto the rubber and pitch. This may be judged a quick pitch by the Umpire. When the pitcher disengages the rubber, he must drop his hands to his sides. Pitchers will not be allowed to disengage the rubber after taking each sign. The pitcher cannot take a second step toward home plate with either foot or otherwise reset his pivot foot in his delivery of the pitch. If there is a runner, or runners, on base it is a balk, if the bases are unoccupied, it should be treated as an illegal pitch.

13.3 WINDUP POSITION - SET POSITION

13.3.1 WINDUP POSITION

The pitcher shall stand facing the batter, his pivot foot in contact with the pitcher's plate and the other foot free. He shall not raise either foot from the ground, except that in his actual delivery of the ball to the batter, he may take one step backward, and one step forward with his free foot. From this position any natural movement associated with his delivery of the ball to the batter commits him to the pitch without interruption or alteration.

When a pitcher holds the ball with both hands in front of his body, with his pivot foot in contact with the pitcher's plate and his other foot free, he will be considered in the Windup Position.

Comment: In the Windup Position, a pitcher is permitted to have his "free" foot on the rubber, in front of the rubber, behind the rubber or off the side of the rubber. From the Windup Position, the pitcher may:

- deliver the ball to the batter, or
- step and throw to a base in an attempt to pick-off a runner, or
- disengage the rubber (if he does, he must drop his hand to his sides).

In disengaging the rubber, the pitcher must step off with his pivot foot and not his free foot first. He may not go into a set or stretch position—if he does it is a balk.

13.3.2 THE SET POSITION

Set Position shall be indicated by the pitcher when he stands facing the batter with the pivot foot in contact with, and the other foot in front of, the pitcher's plate, holding the ball in both hands in front of his body and coming to a complete stop. From such Set Position, he may:

- a) deliver the ball to the batter
- b) throw to a base or step backward off the pitcher's plate with his pivot foot.

Before assuming Set Position, the pitcher may elect to make any natural preliminary motion such as that known as "the stretch." But if he so elects, he shall come to Set Position before delivering the ball to the batter. After assuming Set Position, any natural motion associated with his delivery of the ball to the batter commits him to the pitch without alteration or interruption.

Before coming to a set position, the pitcher shall have one hand on his side; from this position he shall go to his set position as defined in Rule 13.3.2 (b) without interruption and in one continuous motion.

The pitcher, following his stretch, must (a) hold the ball in both hands in front of his body and (b) come to a complete stop. This must be enforced. Umpires should watch this closely, where the pitcher fails to make a complete "stop" called for in the rules, the Umpire should immediately call a "Balk."

Comment: With no runners on base, the pitcher is not required to come to a complete stop when using the Set Position. If, however, in the Umpire's judgment, a pitcher delivers the ball in a deliberate effort to catch the batter off guard, this delivery shall be deemed a quick pitch, which the penalty is a ball. With a runner or runners on base, a pitcher will be presumed to be pitching from the Set Position if he stands with his pivot foot parallel and in contact to the pitcher's plate, and his other foot in front of the pitcher's plate, unless he notifies the Umpire that he will be pitching from the Windup Position under such circumstances prior to the beginning of an at-bat. A pitcher will be permitted to notify the Umpire that he is pitching from the Windup Position within an at-bat only in the event of (i) a substitution by the offensive team; or (ii) immediately upon the advancement of one or more runners (i.e., after one or more base runners advance but before the delivery of the next pitch).

13.4 WARM-UP PITCHES

The pitcher is allowed to warm up at the beginning of each inning. He can throw as many as eight warm up pitches provided they are within the allotted time allowed for in between inning. The catcher will be instructed to throw the ball to second base with thirty seconds left on the clock.

Penalty: For the first offence by that pitcher, they will be warned. Any subsequent violation by that pitcher, will be penalised with a ball awarded to the batter.

For a relief pitcher entering the game, must complete and may not exceed eight warm up pitches within the time. The catcher will be instructed no more throws with fifteen seconds left on the clock.

Penalty: For the first offence by that pitcher, they will be warned. Any subsequent violation by the same team will be penalised with a ball awarded to the next batter of the inning.

13.5 PITCH CLOCK

The implementation of game management clocks supports the efforts to maintain a reasonable pace of game, helping to create a better experience for fans in the stadium and viewers around the globe.

13.5.1 The pitch clock will be set at twenty seconds.

- 13.5.2** Pitch clocks will be visible from the field of play and dugouts.
- 13.5.3** The pitch clock will be in effect ONLY with NO runners on base for the entire game, including any extra innings.
- 13.5.4** It will be activated when the pitcher receives the ball on the mound area.
- 13.5.5** Once the 20 second clock has started, the batter has 10 seconds to enter the batter's box.
- 13.5.6** The batter must keep one foot in the batter's box between pitches. Failure to keep one foot in the batter's box shall result in a strike being called on the batter. The batter may only step out of the batter's box with both feet in the following circumstances:
- 13.5.6.1** When the ball is hit.
- 13.5.6.2** On a swing, provided it is the momentum of the swing that takes them out of the batter's box.
- 13.5.6.3** If forced out of the batter's box to a valid pitch.
- 13.5.6.4** On a wild pitch.
- 13.5.6.5** On an attempted play at the plate or by the catcher on an advancing runner or by any player.
- 13.5.6.6** If the catcher is attempting to make a play (i.e. pop fly).
- 13.5.6.7** If time has been called, or the plate Umpire leaves his position to perform other duties not directly connected with the calling of plays.
- 13.5.6.8** If the pitcher leaves the mound.
- 13.5.6.9** On a three-ball count that the batter thinks the pitch was a ball.
- 13.5.6.10** On a check swing.
- 13.5.6.11** On a bunt attempt.

13.5.7 When the Umpire indicated “PLAY BALL”, after the batter leaves the batter’s box as a result of one of the exceptions listed above, the Umpire shall do so once all play has ceased, and the batter is in or near the batter’s box, the pitcher has possession of the ball on the mound, or the catcher is in a position to return the ball to the pitcher. The Umpire shall signal for the clock to begin. This includes a foul ball, a dead ball or “TIME” being called, even if the batter does not leave the batter’s box.

13.5.8 A pitcher stepping off the rubber will not stop the clock unless the Umpire grants the pitcher time.

13.5.9 If either the pitcher or batter is granted time by the Umpire with five or more seconds showing on the clock, the player in question will not get a reset of the full 20 seconds. The clock will be restarted when the Home Plate Umpire signals “PLAY BALL.”

13.6 PITCHING VIOLATIONS (PROHIBITIONS)

The pitcher shall not:

13.6.1 Make an illegal pitch or quick pitch with no one on base.

Penalty: Call a Ball unless the batter reaches first base.

13.6.2 Intentionally or unintentionally drop the ball while in contact with the pitcher’s plate (rubber).

Penalty: With no one on base, if the ball drops or slips out of the pitcher’s hand, intentionally or accidentally, it is a no pitch if the ball does NOT cross the foul line. If it does cross the foul line, it is a ball. If there is a runner or runners on base and the ball is dropped, it is a balk.

13.6.3 Delay the game at any time. The pitcher has 20 seconds with no runners on base.

Penalty: After a warning for each pitcher, a ball will be called each time the rule is violated.

13.6.4 Go to the mouth while in contact with the pitcher’s plate or in the 18-foot (5.49 m) circle surrounding the pitcher’s plate. The pitcher must clearly wipe the fingers of his pitching hand dry before touching the ball or the pitcher’s plate.

Exception: In cold weather, the Umpire may announce to both teams that it is allowed for the pitcher to blow on his hand, on or off the rubber.

Penalty: the Umpire will remove the ball from play and issue a warning to the pitcher. Any subsequent violation shall be called a ball.

13.6.5 Rub the ball on his glove, person, or clothing. Blow, cough or spit on the ball, either hand or glove. Apply any foreign substance of any kind to the ball. Deface the ball in any manner. Have on his person, or in his possession, any foreign substance.

Penalty: Eject the pitcher from the game. If in the judgement of the Umpire the pitcher did not intend to alter the characteristics of the baseball, then the Umpire MAY, at the Umpire’s discretion, warn the pitcher in lieu of ejecting him from the game. If the pitcher persists in violating this rule, the Umpire shall eject the pitcher from the game.

13.6.6 Intentionally delay the game by throwing the ball to players other than the catcher when the batter is in the batter’s box and is ready to hit. Except in an attempt to retire a runner.

13.6.7 Intentionally throw at the batter. If in the Umpire’s judgement it was intentional, the Umpire may:

13.6.7.1 Eject the pitcher, or the pitcher and manager from the game.

13.6.7.2 May warn the pitcher and the manager of both teams that another such pitch will result in the immediate ejection of that pitcher or a replacement pitcher and the manager.

If, in the Umpire’s judgement, both teams may be officially warned prior to the game or at any time during the game.

Comment: No one, manager, coach or team personnel may come on the playing field to argue a warning issued by the Umpires. To throw at a batter’s head is unsportsmanlike and dangerous. It is condemned by everyone. Umpires should act without hesitation in enforcing this rule.

13.6.8 Pitch both right-handed and left-handed to the same batter during a plate appearance. (See Rule 13.9 Ambidextrous Pitcher).

13.6.9 Take the signs from the catcher with the pivot foot not touching the pitcher's plate. If a pitcher changes pitching hands during a batter's time at bat, the Umpire will:

13.6.9.1 Call a balk if a runner(s) is on base.

13.6.9.2 Call a ball for an illegal pitch if no runner is on base.

13.6.9.3 Warn the pitcher.

13.6.9.4 Eject the pitcher if the violation is repeated.

Note: If a pinch hitter replaces a batter during an at bat, the pitcher may change pitching hands.

If the batter is a switch hitter, an ambidextrous pitcher must declare which hand he will pitch to the batter.

13.6.10 A pitcher is not allowed to jump or push forward off the pitcher's plate with his pivot foot and then bring his foot to the ground and make a second push-off prior to delivering the pitch.

Penalty: This is an illegal pitch and shall be called a balk with runners on base.

Note: A pitcher is not in violation if he pushes off the pitcher's plate with the pivot foot and maintains contact with the ground with the pivot foot without a second push-off from the ground.

13.7 THROWING TO THE BASES

At any time during the pitcher's preliminary movements and until his natural pitching motion commits him to pitch, he may throw to any base, provided he steps directly to such base before making the throw.

Comment: The pitcher must step ahead of the throw. A snap throw followed by the step directly toward the base is a BALK.

13.8 EFFECT OF REMOVING PIVOT FOOT FROM PLATE

If the pitcher removes his pivot foot from contact with the pitcher's plate by stepping backward with that foot, he thereby becomes an infielder and if he makes a wild throw from that position, it shall be considered the same as a wild throw by any other infielder.

13.9 AMBIDEXTROUS PITCHERS

A pitcher must indicate visually to the plate Umpire, the batter and any runners the hand with which he intends to pitch, which may be done by wearing his glove on the other hand while touching the pitcher's plate. The pitcher is not permitted to pitch with the other hand until the batter is retired, the batter becomes a runner, the inning ends, the batter is substituted for by a pinch-hitter or the pitcher incurs an injury. In the event a pitcher switches pitching hands during an at-bat because he has suffered an injury, the pitcher may not, for the remainder of the game, pitch with the hand from which he has switched. The pitcher shall not be given the opportunity to throw any preparatory pitches after switching pitching hands. Any change of pitching hands must be indicated clearly to the plate Umpire.

13.10 BALKS

A balk is an illegal act by the pitcher with a runner(s) on base. All runners advance one base. Exception: if after the balk, the batter reaches base due to a hit, error, base on balls, hit batter or otherwise, and all runners advance at least one base, the play stands and the balk is ignored.

If there is a runner or runners, a balk shall be called for the following action by a pitcher:

13.10.1 While touching the pitcher's plate, any feinting motion without completing the throw toward the batter or toward first or third base.

13.10.2 When, before throwing to any base from a pitching position, the pitcher feints a throw to a base and, without breaking contact with the rubber, throws to another base.

13.10.3 While in a pitching position, throw to any base in an attempt to retire a runner without first stepping directly toward such base; or throw or feint a throw toward any base when it is not an attempt to retire a runner or prevent the runner from advancing.

13.10.4 The pitcher, while touching the pitcher's rubber, must step toward the base, preceding or simultaneous with any move toward that base. The pitcher is committed, upon raising the lead leg, to throw to the base being faced to second base or to the plate. When throwing or feinting a throw to a base not being faced, the pitcher must step immediately, directly and gain ground toward that base.

Note: If the pitcher throws to the first or third baseman who is playing off the base, a balk shall not be called if the fielder moves toward the occupied base in an attempt to retire the runner.

13.10.5 The "spin" or "open" move to second base is legal if the pitcher raises the lead leg and immediately, with a continuous motion, steps directly toward second base. The pitcher need not throw.

13.10.6 The pitcher shall step "ahead of the throw." A snap throw followed by a step directly toward the base is a balk.

13.10.7 The pitcher may not prematurely flex either leg before stepping directly and throwing to first base.

13.10.8 The jump-turn move is legal if the pitcher's free foot steps toward and gains ground to the base that the ball is being thrown. Otherwise, a balk shall be called.

13.10.9 Stepping toward second base without completing the throw is legal if the base is occupied by a runner or there is an attempt to retire a runner.

13.10.10 Making an illegal pitch, such as a quick pitch.

Note: If a runner on third base breaks for home plate, the pitcher may speed up the delivery but must continue to use a normal pitching sequence and arm action.

13.10.11 Unnecessarily delaying the game.

13.10.12 While not in possession of the ball, the pitcher stands with either foot or both feet on any part of the dirt area (circle) of the mound during a hidden-ball play attempt.

13.10.13 Failing to throw to the batter immediately after making any motion

with any part of the body such as the pitcher habitually uses in the delivery.

Note: If the pitcher, with a runner on base, stops or hesitates the delivery because the batter steps out of the box, holds up a hand or uses any other action as if calling time, it shall not be a balk. The rule has been violated by both the batter and the pitcher, and the Umpire shall call "Time" and begin the play anew.

13.10.14 The pitcher takes either hand off the ball after having taken a stretch or set position unless making a pitch or throwing to any base.

Note: The pitcher may momentarily adjust the ball in the glove and separate the hands if it is prior to assuming a legal pitching position.

13.10.15 The pitcher pitches while the catcher is not in the catcher's box. The catcher must have at least one foot within the catcher's box until the pitcher begins the pitching motion; Note: This is an illegal pitch with no runners on base.

13.10.16 The pitcher delivers the pitch from the set position without coming to a complete and discernible stop, or the pitcher comes to more than one stop from the set position (see Article 13.3.2 Comment); Note: With the bases unoccupied, the pitcher does not need to come to a complete and discernible stop.

13.10.17 From the set position, if the entire free foot or any part of the stride leg breaks the plane of the back edge of the pitcher's rubber and the pitcher does not throw or feint a motion to second base or pitch to home plate.

13.10.18 When the pitcher makes a natural pitching motion while not touching the pitcher's rubber.

Note:

a. If the balk immediately is followed by a pitch that permits the batter and each runner to advance a minimum of one base, the balk is ignored, and the ball remains live. Example: The batter and all runner(s) advance when a wild pitch is either ball four or strike three.

- b. If a balk immediately is followed by a wild throw by the pitcher to a base that permits a runner(s) to advance to or beyond the base to which that runner is entitled. The Umpire will call the balk in the usual manner but shall not call "Time" until all play has ceased (runners have stopped trying to advance and/or a fielder is in possession of the ball in the infield).

Note: After a balk that is followed by a base hit or a wild throw to a base or the plate, a runner who misses the first base to which the runner is advancing and who, before the next pitch, is called out on appeal, shall be contemplated as having advanced one base for the purpose of this rule.

- c. If only the runner advances to or beyond the base to which he is entitled because of a wild pitch after a balk, the balk is still acknowledged.

Note: A runner(s) may advance beyond the base that is entitled at the runner's own risk.

When a balk occurs, the pitch is nullified, and the batter will resume the at-bat with the count that existed unless:

- d. The wild pitch was ball four on which all runners (including the batter-runner) advanced one base.
- e. The wild pitch was strike three on which the batter and all other runners advanced one base. In both situations (a) and (b) above, play proceeds without reference to the balk, because all runners (including the batter-runner) advanced one base on the pitch after the balk.

Note: If the balk is followed by a wild pitch that allows a runner to attempt to go beyond the base that he would have been awarded because of the balk, the runner advances at his own risk; he is either safe or out as a result of the play. The balk is still "acknowledged" as it relates to the batter, and he will resume the at-bat with the count that existed when the balk occurred.

13.11 REMOVING PITCHER

The conditions for removal of the pitcher are as follows:

- 13.11.1 A manager is allowed to be involved in a maximum of 3 free trips plus one extra free trip for every three innings in the event of an extra inning game.

- 13.11.1.1 A free trip is a defensive charged conference involving a manager, coach, or bench personnel in which the pitcher is not removed.

- 13.11.1.2 The manager cannot circumvent this rule by asking a player to act for him, and neither can the manager or his representative leave the bench or dugout and approach the base lines to confer with the pitcher for the purpose of evading this rule.

- 13.11.1.3 If a manager holds a defensive conference with a defensive player, it shall be considered a charged defensive conference whether the player goes to the mound or not.

- 13.11.1.4 Unused free trips to the mound during the first nine innings in a nine inning game, or seven in a seven inning game may not be used during any extra innings.

- 13.11.1.5 For the purpose of identifying trips to the mound on a batter, a player becomes the batter as soon as the previous batter reaches base or is put out. The new batter does not have to enter the batter's box to be considered the batter.

- 13.11.1.6 In a situation where a player is bleeding, a decision to substitute for the player must be made within 10 minutes from the time play is stopped.

- 13.11.1.7 During a free trip or a time out to allow a substitution for the pitcher, a defensive player may warm up another defensive player, provided it does not delay the game. The player warming up must be in the current line-up and remain in fair territory during the charged conference or timeout. For example, a bullpen catcher is not allowed to participate in this type of warm-up.

- 13.11.1.8 The plate Umpire shall record on the line-up card each free trip and the inning in which it occurred.

- 13.11.2 If a manager, coach or his nonplaying representative goes to the mound a second time in the inning to talk to the same pitcher, or if a manager, coach or non-playing representative has already been involved in 3 of the defensive charged conferences during regulation

play, the pitcher must be removed from the pitcher's position for the remainder of the game. The coach is to indicate the relief pitcher to an Umpire immediately after crossing the foul line.

Note: If, after one trip to the same pitcher in the same inning, or three free trips in a game, the coach goes to the plate Umpire to announce a pitching change (does not go to the mound), a second trip shall be charged (when the change is recorded on the official line-up card). If moved to a defensive position, the pitcher shall not return to pitch.

- 13.11.3** A manager may not make a second trip to the mound in the same inning with the same batter at bat. However, if a pinch hitter is substituted, the manager may make a second trip but must remove the pitcher.
- 13.11.3.1** In this pinch-hitter situation, a relief pitcher, having just been brought into pitch, may not be removed from the game before pitching completely to one batter or the side has been retired.
- 13.11.3.2** If the manager previously has used the allowed free trips and mistakenly is allowed to go to the mound for a conference, the pitcher shall be removed from the position after the batter completes the turn at bat. The pitcher may not re-enter the game as a pitcher.
- 13.11.3.3** If the manager starts to the mound for a second trip with the same batter at bat in the same inning, the Umpire shall warn that this act is not permitted. If the manager continues to the mound, the manager shall be ejected and the pitcher must complete pitching to the batter; when the batter's turn is completed, the pitcher shall be removed from the game. The manager should be warned of the impending removal so that another pitcher can start warming up. The substitute pitcher shall be permitted the eight preparatory pitches unless circumstances justify additional pitches.

Note: If the Umpire originally fails to recognise that the manager is making a second trip during the same batter, the manager shall not be penalised.

- 13.11.4** The trip to the mound (which may include a conference with the infielders) begins when the manager crosses the foul line and shall be concluded when the manager leaves the dirt circle, or the pitcher begins his eight warm-up pitches.
- 13.11.5** A pitcher who is removed from the pitching position but remains in the game as a defensive player may return to the mound only once.
- 13.11.6** When the game pitcher crosses the foul line on the way to the mound to start an inning, he shall pitch to the first batter until such batter is put out or reaches base, unless a pinch hitter is substituted or the batter or the pitcher sustains an injury or illness, which incapacitates him from continuing.
- A manager or coach is deemed to have concluded his visit to the mound when he leaves the 18-foot (5.49 m) circle surrounding the pitcher's rubber.

Comment: If the manager or coach goes to the catcher or infielder and that player then goes to the mound or the pitcher comes to him at his position before there is an intervening play (a pitch or other play) that will be treated the same as the manager, coach or bench personnel going to the mound. Any attempt to circumvent this rule by the manager or coach bench personnel by going to the catcher or any infielder and then that player going to the mound to talk with the pitcher will constitute a trip to the mound. If the coach goes to the mound and removes a pitcher and then the manager goes to the mound to talk with the new pitcher, that will constitute one trip to that new pitcher that inning.

A manager or coach shall not be considered to have finished his visit to the mound if he temporarily leaved the 18-foot (5.49 m) circle surrounding the pitcher's runner for purposes of notifying the Umpire that a double switch or substitution is being made. In a case where a manager has made his first trip to the mound and then returns the second time to the mound in the same inning with the same pitcher in a game and the same batter at bat, after being warned by the Umpire that he cannot return to the mound, the manager will be removed from the game and the pitcher will be required to pitch to that batter until he is retired or gets on base.

After the batter is retired, or becomes a runner, then that pitcher must be removed from the game. The manager should be notified that his pitcher will be removed from the game after he pitches to one hitter, so he can have a substitute pitcher warmed up. In such an occurrence, the substitute pitcher will be allowed as much time to warm up as the Umpire deems necessary.

For the purpose of this rule, replacing the pitcher will be considered one trip to that pitcher that inning, regardless of whether the manager or coach chooses to go to the mound, or whether the pitcher remains in the game at a different position on defence.

RULE 14. THE UMPIRE

Game officials are referred to as Umpires. There is an Umpire in chief (plate Umpire) and one, two, three or five field Umpires.

14.1 UMPIRE AUTHORITY

Each Umpire has the following authority:

- 14.1.1** To order a player, manager, coach, or team personnel to do or refrain from doing anything that affects the administering of these rules and to enforce prescribed penalties.
- 14.1.2** To rule on any point not specifically covered in these rules.
- 14.1.3** To disqualify any player, manager, coach, or team personnel for objecting to decisions or for unsportsmanlike conduct or language and to eject such disqualified person from the playing field. If a player is disqualified while a play is in progress, the disqualification shall not take effect until there is no further action is possible in that play.
- 14.1.4** To disqualify, at his discretion from the playing field, any person whose duties permit his presence on the field, such as ground crew members, photographers, newsmen, broadcasting crew members, and any spectator or other person not authorised to be on the playing field.

Note: Umpire jurisdiction regarding personal confrontations and unsportsmanlike conduct directed toward them begins when the Umpires enter the game site and ends when the Umpires have left the game site.

14.2 APPEAL OF UMPIRE DECISIONS

- 14.2.1** Any Umpire's decision which involves judgment, such as, but not limited to, whether a batted ball is fair or foul, whether a pitch is a strike or a ball, or whether a runner is safe or out, is final. No player, manager, coach, or team personnel may object to any such judgment. Players leaving their position in the field or on base, or managers or coaches leaving the bench or coaches box to argue balls and strikes will not be permitted. They will be warned if they start for the plate to protest, but if they continue, they will be ejected immediately from the game.
- 14.2.2** If there is reasonable doubt that any Umpire's decision may conflict with the rules, the manager may appeal the decision and ask that a correct ruling be made. Such appeal shall be made only to the Umpire who made the protested call.
- 14.2.3** If a decision is appealed, the Umpire making the decision may ask another Umpire for information before making a final ruling. No Umpire shall criticise or interfere with another Umpire's decision, unless asked. However, if there is a misinterpretation of a rule, it should be brought to the attention of the Umpire-in-chief. If the Umpire's change a call that has been made, then they have the authority to take all steps that they may deem necessary, in their discretion, to eliminate the results and consequences of the earlier call that they are reversing, including placing runners where they think those runners would have been after the play, had the ultimate call been made as the initial call, disregarding interference or obstruction that may have occurred on the play. Failures of runners to tag up based upon the initial call on the field, runners passing other runners or missing bases, all in the discretion of the Umpires. Correction of a missed ball-strike count shall not be permitted after a pitch is thrown to a following batter, or in the case of the final batter of an inning or game, after all infielders of the defensive team leave fair territory.

Note: The defensive team may request the plate Umpire to ask his partner for help on a half swing when the plate Umpire call a pitch a ball. But not when the pitch is called a strike. Appeals on a half swing must be made before the next pitch or any play or attempted play. Baserunners must be alert to the possibility that the base Umpire on appeal from the plate Umpire may reverse the call of a ball to the call of strike, in which the runner is in jeopardy of being thrown out by the catcher's throw. Also, the catcher must be alert in a base stealing situation if a ball call is reversed to a strike by the base Umpire upon appeal from the plate Umpire. The ball is in play on appeal on a half swing.

- 14.2.4** No Umpire may be replaced during a game unless he is injured or becomes ill.
- 14.2.5** If there are two or more Umpires, one shall be designated Umpire-in-chief and the other field Umpires.

14.3 UMPIRE POSITION

- 14.3.1** The Umpire in chief shall stand behind the catcher. He is called the plate Umpire. His duties shall be to:
- 14.3.1.1** Take full charge of, and be responsible for, the proper conduct of the game.
- 14.3.1.2** Call and count balls and strikes.
- 14.3.1.3** Call and declare fair balls and fouls except those commonly called by field Umpires.
- 14.3.1.4** Make all decisions on the batter.
- 14.3.1.5** Make all decisions except those commonly reserved for the field Umpires.
- 14.3.1.6** Decide when a game shall be forfeited.
- 14.3.1.7** Have the lights turned on when necessary for safety reasons. Whenever possible, this should be done at the beginning of an inning.

- 14.3.1.8** If a time limit has been set, announce the fact and the time set before the game starts.
- 14.3.1.9** Inform the Official Scorer of the official batting order, and any changes in the line-ups and batting order, on request.
- 14.3.1.10** Announce any special ground rules, at his discretion.
- 14.3.1.11** Eject a player, manager, coach or team member.

14.3.2 A field Umpire may take any position on the playing field he thinks best suited to make impending decisions on the bases. His duties shall be to:

- 14.3.2.1** Make all decisions on the bases except those specifically reserved to the Umpire in chief.
- 14.3.2.2** Take concurrent jurisdiction with the Umpire in chief in calling "Time," balks, illegal pitches, or defacement or discolouration of the ball by any player.
- 14.3.2.3** Aid the Umpire in chief in every manner in enforcing the rules, and excepting the power to forfeit the game, shall have equal authority with the Umpire in chief in administering and enforcing the rules and maintaining discipline.

14.3.3 If different decisions should be made on one play by different Umpires, the Umpire in chief shall call all the Umpires into consultation, the Umpire in chief (unless another Umpire may have been designated by the League) shall determine which decision shall prevail, based on which Umpire was in the best position and which decision was most likely correct. Play shall proceed as if only the final decision had been made.

14.4 REPORTING

The Umpire shall report to the Federation, League or WBSC office within twelve hours after the end of a game all violations of rules and other incidents worthy of comment, including the disqualification of any trainer, manager, coach or player, and the reason therefor.

When any trainer, manager, coach, or player is disqualified for a flagrant offence such as the use of obscene or indecent language, or an assault upon an Umpire, trainer, manager, coach or player, the Umpire shall forward full particulars to the Federation, League office within four hours after the end of the game.

14.5 GENERAL INSTRUCTIONS TO UMPIRES

Umpires, on the field, should not indulge in conversation with players. Keep out of the coaching box and do not talk to the coach on duty.

Keep your uniform in good condition. Be active and alert on the field.

Always be courteous to team officials, avoid visiting team locker rooms and dugouts.

When you enter a ballpark, your sole duty is to Umpire a ball game as the representative of baseball.

Keep the game moving. A ball game is often helped by energetic and earnest work of the Umpires. You are the only official representative of baseball on the ball field. It is often a trying position which requires the exercise of much patience and good judgment, but do not forget that the first essential in working out of a bad situation is to keep your own temper and self-control.

You no doubt are going to make mistakes, but never attempt to “even up” after having made one. Make all decisions as you see them and forget which is the home or visiting teams.

Keep your eye on the ball while it is in play. It is more important to know just where a fly ball fell, or a thrown ball finished up, than whether or not a runner missed a base. Do not call the plays too quickly or turn away too fast when a fielder is throwing to complete a double play. Watch out for dropped balls after you have called a player out.

Do not come running with your arm up or down, denoting “out” or “safe.” Wait until the play is completed before making any arm motion.

Each Umpire team should work out a simple set of signals, so the proper Umpire can always right a manifestly wrong decision when convinced he has made an error. If sure you got the play correctly, do not be stampeded by players’ appeals to “ask the other man.”

If not sure, ask one of your associates. Do not carry this to extremes, be alert and get your own plays. The first requisite is to get decisions correctly. If in doubt don’t hesitate to consult your associate. Umpire dignity is important but never as important as “being right.”

Most important rule for Umpires is always
“BE IN POSITION TO SEE EVERY PLAY.”

Even though your decision may be 100% right, players still question it if they feel you were not in a spot to see the play clearly and definitely.

Finally, be courteous, impartial and firm, and so compel respect from all.

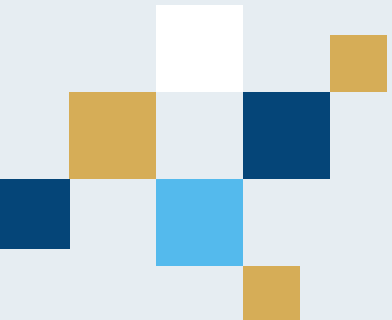

CHAPTER 04. SCORING

RULE 15. OFFICIAL SCORER

15.1 SCORING DIRECTOR

The WBCS will appoint a Scoring Director in each competition, who will designate an Official Scorer and up to two assistant scorers for each game of the tournament.

15.2 SCORER

The Official Scorer shall have the exclusive and sole authority to make and record all decisions that refer to the official scoring rules that involve a decision based on his or her judgment, such as whether a batter's advance to first base is for a hit or for an error. The Official Scorer is an official representative of the WBCS, and has the right and deserves the respect, consideration and dignity proper to his position, he will have the full protection of the WBCS and its bodies. The Official Scorer shall inform the Scoring Director about any offence, aggression or attempted aggression received from any manager, coach, player, employee, director or representative of a team, in the course of or because of the exercise of their duties and functions as Official Scorer.

The Official Scorer, in order to ensure the optimal performance of his tasks, will perform functions and observe the game from a suitable location and according to his position and responsibilities. The Official Scorer must inform his decisions through the channels and means established by the WBCS in a timely manner.

15.2.1 The Official Scorer shall record all of the actions of a game and his decisions in accordance with the WBCS Official Rules of Baseball and the WBCS Scoring Manual.

15.2.1.1 The Official Scorer shall record on the official score sheet the name of each player and his position or positions assumed during the game, in the order in which the player batted, or could have batted if the game did not end before the player completed his turn.

15.2.1.2 When a player has not switched positions with another player but is placed in a different place than his position for reasons of defensive strategies for a given batter of the opposing team (defensive shift), the Official Scorer will not record this movement as a new defensive position.



- 15.2.1.3** The Official Scorer shall note on the official score sheet, any player who enters the game as a substitute batter or runner, whether or not the player continues in the game after that.
- 15.2.1.4** The Official Scorer must include the name of any substitute player announced but replaced by another substitute player before entering the game. Any subsequent substitute shall be recorded as a substitute batter or runner for the player he is replacing.
- 15.2.1.5** The Official Scorer must check the score sheet, for this he must verify that the sum of the total times at bat of a team, sacrifice bunts, sacrifice flies, bases on balls received, batters hit by pitches, batters awarded first base because of interference or obstruction, is equal to the sum of the total runs scored, runners left on base and outs made by the opposing team minus runners placed on base by application of the tie-break rule.

- 15.2.2** The Official Scorer must write down all the actions of the game at the time they happen in the game, with respect to the decisions related to the judgement will have up to a maximum of fifteen (15) minutes at the conclusion or suspension of the game to make any modification. No appraisal decision can be changed later, unless the Official Scorer requests it to the Scoring Director and the latter, evaluating the reasons and arguments presented, authorises it.

The Official Scorer will not be authorised or able to make a decision that is in conflict with the WBSC Official Rules of Baseball and shall conform strictly to what is indicated in the official scoring rules. The Official Scorer will not make any decision that is in conflict with the decision of an Umpire, however, he will have the authority to decide on any point that is not specified in the WBSC Official Rules of Baseball.

- 15.2.2.1** A player or team may request the WBSC to review a judgement decision made by an Official Scorer in a game in which such player or team participated.

The request must be made through a written notification or by any electronic means established by the WBSC within 12 hours after the conclusion of such game.

- 15.2.2.2** The WBSC in conjunction with the Scoring Director of the competition, after analysing the arguments and evidence presented, may request the Official Scorer to change a decision if it is concluded that the decision of the Official Scorer has been erroneous. After this procedure no decision will be changed.

- 15.2.2.3** The WBSC through the Scoring Director may request to change any decision of an Official Scorer that contradicts these WBSC Official Rules of Baseball and will take whatever action is necessary with the aim of correcting any statistics that need amendment as a result of such an incorrectly noted decision.

- 15.2.3** The Official Scorer must immediately notify the Technical Commissioner or the head of the Umpires of the game if the teams change from offence to defence or vice versa, before making three outs, or continue playing after the third out.

- 15.2.4** The Official Scorer shall not call the attention of the Umpires or any member of the teams, due to the fact that a batter is batting out of turn.

15.3 GAME OVER

- 15.3.1** When a regulation game is called, the Official Scorer shall include all individual and team records up to the time the game ends as stated in WBSC Official Rules of Baseball Rule 7.7, 7.8 and 7.9.

If the game ends in a tie, the Official Scorer will not credit a winning or losing pitcher.

- 15.3.2** When a game ends by run difference according to what is established in the WBSC Official Rules of Baseball the game will be a regulation game and the Official Scorer must include all the individual and team record.

- 15.3.2.1** When a game ends on run difference, the Official Scorer must apply all considerations set forth in the WBSC Official Rules of Baseball regarding the winning run and the value of hits.

- 15.3.3** If the game is suspended or played under protest, the Official Scorer shall make a note of the exact situation of the game at the time of the protest or suspension, including the score (runs by each team), the number of outs, the position of the runners on base, the count of balls and strikes of the batter, the line-up of each team and the players that have been substituted from the game of both teams.

This aspect is very important since, if a suspended or protested game is to be resumed, it must continue in exactly the same situation as it existed at the time of the suspension, that is, if a protested game is ordered to be played again from the time of the protest, the game must resume with exactly the situation that existed just before the protested play.

- 15.3.4** When a regulation game is forfeited, the Official Scorer will include all individual and team statistics up to the time of the forfeit. If a game is forfeited prior to being a regulation game, the Official Scorer will not include any individual or team statistics but will only record and report the reason for the forfeiture.

15.3.4.1 If the winning team by forfeit has the lead at the time of forfeit, the Official Scorer shall credit as the winning and losing pitchers the pitchers who would have qualified if the game had been called at the time of forfeiture.

15.3.4.2 If the winning team by forfeit is losing or if the game is tied at the time of the forfeit, the Official Scorer shall not credit a winning or losing pitcher.

15.4 REPORTS

After each game, including forfeited and/or protested games, the Official Scorer, based on the provisions of these WBSC Official Rules of Baseball and the technical regulations of each tournament, will make the respective report using the formats established by the WBSC, which will be delivered to the Scoring Director of the competition.

The Official Scorer will likewise send the report of any suspended game after it has been completed, or after it becomes an official game because it could not be completed.

RULE 16. BATTING RECORD

16.1 BATTER OUT OF TURN

When a batter does not appear to bat in his proper turn, and another batter in the batting order completes the turn in his place, it is an out-of-turn batter and the opposing team has the right to appeal.

When a player bats out of turn and is put out, and as a result of an appeal play by the opposing team before a pitch is made, the proper batter is declared out, the Official Scorer shall score the proper batter with a time at bat, and the putout and any assist are credited to the fielders who made the putout during the action.

If an improper batter becomes a runner as a result of an appeal play by the opposing team before a pitch is made, the proper batter is called out for missing his turn at bat, the Official Scorer shall score the proper batter who was due to bat, a time at bat and credit the catcher with a putout, and ignore all the actions which occurred after the improper batter reached first base.

If more than one batter bats out of turn consecutively, the Official Scorer shall record all plays exactly as they occur, ignoring the turn at bat of the player(s) who failed to bat in the correct order and score their turns as a Lost Turn.

The Official Scorer will never alert the Umpires or any member of either team if a player is batting out of turn.

16.2 HITS

A hit is a statistic credited to a batter when said batter reaches a base without errors and safely as outlined in these WBSC Official Rules of Baseball.

16.2.1 The Official Scorer shall credit the batter with a hit when:

16.2.1.1 The batter reaches first base or a subsequent base with a fair ball which remains on the playing field, or hits the fence before being touched by a fielder, or passes over the fence

16.2.1.2 The batter reaches first base by hitting a fair zone ball with such force or so slowly that any fielder attempting to make a play on it has no opportunity to do so.

The Official Scorer shall credit a hit if the fielder attempting to catch the ball is unable to make the play, even though such fielder deflects the ball and prevents another fielder from making a play that could put out the batter-runner or another runner.

- 16.2.1.3 The batter reaches first base safely by hitting a fair ball which gives an irregular bounce that a fielder cannot catch it with ordinary effort; or it touches the pitcher's plate or any other base (including home) before it is touched by a fielder and rebounds in such a way that a fielder cannot catch it with ordinary effort.
- 16.2.1.4 The batter reaches first base safely by hitting a fair ball that has not been touched by a fielder and is in fair territory when it reaches the outfield, unless in the judgment of the Official Scorer it could have been caught with ordinary effort.
- 16.2.1.5 A fair ball that has not been touched by a fielder touches a runner or Umpire, unless the runner is called out for being touched by an infield fly in which case the Official Scorer shall not credit a hit.
- 16.2.1.6 A defensive fielder attempts unsuccessfully to put out a preceding runner and, in the judgment of the Official Scorer, the batter-runner would not have been put out at first base with ordinary effort.
- 16.2.1.7 A fielder makes an exceptional fielding play of a batted ball and such play is unsuccessful in putting out the batter or a base runner.

In any situation the Official Scorer should always give the batter the benefit of the doubt.

16.2.2 The Official Scorer shall not credit a hit to the batter when:

- 16.2.2.1 A runner is forced out by a batted ball, or would have been forced out except for a fielding error.
- 16.2.2.2 After the batter hits the ball, a runner who is required to advance because the batter becomes a runner, misses

touching the first base to which he is advancing and is called out on appeal.

- 16.2.2.3 When an infielder catches a batted ball and puts out a preceding runner who is attempting to advance a base or return to his original base, or could have been put out with ordinary effort except for a fielding error.
- 16.2.2.4 A fielder fails in his attempt to put out a preceding runner and in the Official Scorer's judgment the batter-runner could have been put out at first base. It will not apply if the fielder merely looks or feints toward another base before attempting to make the out at first base.
- 16.2.2.5 A runner is called out for interfering with a fielder attempting to catch a batted ball, unless in the judgement of the Official Scorer the batter-runner would have been safe had the interference not occurred.

In all actions listed in WBCS Official Rules of Baseball Rule 16.2.2, the batter will be credited with one time At Bat, but not a hit.

16.3 EXTRA BASE HITS

16.3.1 The Official Scorer may score a hit as a one base hit, two base hit, three base hit, or four base hits (home run), when it is not the result of an error or an out. In the following way:

- 16.3.1.1 It is a one base hit if the batter stops at first base, it is a two base hit if the batter stops at second base, it is a three-base hit if the batter stops at third base, it is a home run if the batter touches all the bases and scores.
- 16.3.1.2 When, with one or more runners on base, the batter advances more than one base on a hit and the defending team attempts to put out a preceding runner, the Official Scorer shall determine whether the batter legitimately earned a two-base hit or a three-base hit or if the batter advanced beyond first base on a fielder's choice.

The Official Scorer shall not credit the batter with a three-base hit when a preceding runner is put out at home, or might have been put out but for an error.

The Official Scorer shall not credit the batter with a two-base hit when a preceding runner trying to advance from first base is put out at third base, or would have been put out but for an error.

The Official Scorer, except as noted above, shall not determine the value of hits by the number of bases advanced by a preceding runner. A batter may deserve a two-base hit even though a preceding runner advanced one or no bases, likewise the batter may deserve a one-base hit even though he reaches second base and the preceding runner advances two bases.

16.3.1.3 To clarify what is stated in this rule, the following examples are indicated:

Example: With a runner on first base, the batter hits a base hit to the right fielder who tries unsuccessfully to throw out the runner on third base, on the throw the batter reaches second base. The Official Scorer shall credit the batter with a one base hit.

With a runner on second base, the batter hits a fly ball, the runner waits to see if the ball is caught and when it lands, he advances only to third base, the batter-runner reaches second base. The Official Scorer shall credit a two-base hit to the batter.

With a runner on third base, the batter hits a fly ball into the outfield, the runner steps forward, but runs back to tag up thinking the ball will be caught. The ball falls safe, but the runner cannot score although the batter has reached second base. The Official Scorer shall credit a two-base hit to the batter.

16.3.2 When the batter attempts to get a two-base hit or a three-base hit through a slide, he must hold the last base to which he advances.

If the batter-runner slides when passing the base and is out before returning safely to the base, he shall be credited with as many bases as he has reached safely.

If the batter-runner slides past second base and is out, the Official Scorer shall credit him with a one-base hit; if he slides past third base and is put out, the Official Scorer shall credit him with a two-base hit.

16.3.3 When the batter, after making a safe hit, overruns second or third base and is out trying to return, the Official Scorer will credit him with a safe hit to the value of the last base touched by him.

If the batter-runner overruns or attempts to run past second base after reaching that base and attempts to return and is put out, the Official Scorer shall credit him with a two-base hit.

If the batter-runner overruns third base after reaching that base and then attempts to return and is put out, the Official Scorer shall credit him with a three-base hit.

16.3.4 When the batter-runner is awarded two bases, three bases, or a home run in accordance with the provisions set forth in WBSC Official Rules of Baseball (Rule 10.4.7.1 through 10.4.7.5), the Official Scorer, as the case may be, shall credit a two-base hit, a three-base hit, or a home run.

16.3.5 When the batter, after making a safe hit, is called out on appeal for missing a base, the last base he safely touched shall determine whether the Official Scorer shall credit him with a one base hit, a two-base hit, or a three-base hit.

If the batter-runner is called out by missing home, the Official Scorer shall credit him with a three-base hit. If the batter-runner is called out for missing third base, the Official Scorer shall credit him with a two-base hit. If the batter-runner is called out for missing second base, the Official Scorer shall credit him with a one-base hit. If the batter-runner is called out for not touching first base, the Official Scorer must credit him with an At Bat, but not with a hit.

16.4 GAMES ENDED BY HIT

16.4.1 When the batter ends a game with a safe hit that drives in as many runs as are necessary to give his team the win, the Official Scorer shall credit him with a hit of as many bases that are advanced by the runner who scored the winning run and only if the batter covered as many bases as the runner advanced who scored the winning run.

This rule shall apply even if the batter-runner is theoretically entitled to more bases for having been awarded an automatic extra base hit in accordance with the provisions in WBSC Official Rules of Baseball Rule 10.4.7.

16.4.2 The Official Scorer shall credit the batter with a base touched during the normal course of a play, even if the winning run has scored moments before on the same play.

Example: The game is tied in the bottom of the seventh inning, the home team has a runner on second base, and the batter bats a hit into the outfield. The runner scores after the batter-runner touched first base and continued toward second base, but just before the batter-runner touched second base. If the batter-runner reaches second base, the Official Scorer shall credit him with a two-base hit.

16.4.3 When the batter ends a game by hitting a home run out of the playing field, he and all runners on base are entitled to score.

16.5 THE SACRIFICES

The Official Scorer in accordance with what is indicated in these WBSC Official Rules of Baseball may credit the batter with two types of sacrifices, by a bunt or fly ball. No time At Bat should be charged to the batter for either of these plays.

16.5.1 SACRIFICE BUNT

The Official Scorer shall credit the batter with a sacrifice bunt when, with less than two outs, the batter advances one or more runners with a bunt and is put out at first base, or would have been put out except for a fielding error. If in the judgment of the Official Scorer the batter hit the ball solely with the intention of getting a hit and not sacrificing his own chance of reaching first base for the purpose of advancing a runner or runners, he shall charge the batter one time At Bat.

In order to determine that it was a sacrifice bunt, in addition to what is indicated in these WBSC Official Rules of Baseball, the Official Scorer must consider all the circumstances that occurred at the time of the plate appearance, such as the inning, the number of outs, and the score of the teams.

A sacrifice bunt shall be credited to the batter when, with less than two outs, a fielder catches a bunt and fails without error to attempt to put out a preceding runner advancing one base. If in the judgment of the Official Scorer an ordinary effort would not have served to put out the batter or a runner, he shall score a hit and not a sacrifice bunt.

The Official Scorer shall give the batter the benefit of the doubt when assessing that a batter sacrificed his time At Bat with the intention of advancing a runner or runners.

When the runner is out, or would have been put out except for a fielding error, while he is attempting to advance one base on a bunt, a sacrifice bunt shall not be scored and the Official Scorer shall charge the batter with a time At Bat.

16.5.2 SACRIFICE FLY

The Official Scorer shall score a sacrifice fly when with less than two out, the batter hits a fly ball or a line drive played by an outfielder or an infielder in the outfield or who is running towards that area regardless of whether they are either in fair or foul territory and:

16.5.2.1 The ball is caught and a runner scores.

16.5.2.2 The ball is dropped and a runner scores and in the judgment of the Official Scorer the runner could have scored had the catch been made.

The Official Scorer shall score a sacrifice fly even if another runner is out in a force play after the batter became a runner.

16.6 RUNS BATTED IN (RBI)

An RBI is a statistic credited to the batter when his batting action allows his team to score one or more runs.

16.6.1 The Official Scorer shall credit the batter with one RBI for every run that scores:

16.6.1.1 not assisted by an error, and as part of a play initiated by a hit by the batter, a sacrifice bunt, a sacrifice fly, an infield out, or a fielder's choice.

16.6.1.2 when the bases are loaded and the batter becomes a runner on a base on balls, hit by a pitched ball, interference or obstruction.

16.6.1.3 when, with less than two out, an error is made on a play on which a runner would normally score from third base.

16.6.2 The Official Scorer shall not credit an RBI to the batter when:

16.6.2.1 The batter hits a ground ball for a forced double play or a reverse forced double play.

16.6.2.2 A fielder is charged with an error because he did not catch a throw at first base that would have completed a forced double play.

16.6.3 The Official Scorer must determine whether he credits a batter with an RBI when a fielder holds the ball or throws to a wrong base. Usually if the runner keeps running, the Official Scorer should credit an RBI, however if the runner stops and then restarts when he notices the misplay, the Official Scorer should credit the run as scored on a fielder's choice.

16.7 STOLEN BASES AND CAUGHT STEALING

16.7.1 A stolen base is a statistic credited to a runner when he advances one base without the aid of a hit, a put out, an error, a force out, a fielder's choice, a wild pitch, a passed ball, or a balk.

The Official Scorer shall credit a stolen base when:

16.7.1.1 A runner leaves for the next base before the pitcher delivers the ball.

16.7.1.2 A runner leaves for the next base before the pitcher delivers the ball and the pitch results in what commonly is scored as a wild pitch or a passed ball.

The Official Scorer shall credit the runner with a stolen base and shall disregard the misplay, unless the stealing runner advances an additional base, or another runner also advances an extra base. In this case, the Official Scorer, in addition to the stolen base, shall score a wild pitch or a passed ball.

16.7.1.3 A runner attempts to steal a base and the catcher makes a bad throw trying to prevent the stolen base. The Official Scorer shall not record an error unless that bad throw allows the stealing runner to advance an additional base or allow another runner to advance. In this situation, the Official

Scorer shall score, in addition to the stolen base, an error to the catcher.

16.7.1.4 A runner attempting to steal a base is picked off base and avoids being put out on a run-down play and advances to the next base without the aid of an error.

If another runner also advances on the play, both runners shall be credited with a stolen base.

If a runner advances a base while another runner who attempted to steal a base avoids being put out in a run-down play and returns safely to the base he originally occupied without the aid of an error, the Official Scorer shall credit a stolen base to the advanced runner.

16.7.2 The Official Scorer shall not credit a stolen base when:

16.7.2.1 A double or triple steal is attempted, and a runner is thrown out before reaching the base he attempted to steal. No other runner shall be credited with a stolen base.

16.7.2.2 A runner is put out after oversliding a base, while he is attempting either to return to that base, or to advance to the next base.

16.7.2.3 A runner advances because of the defensive team's indifference to prevent such advance which will be scored as a fielder's choice. The Official Scorer shall consider, in judging that it is an indifference of the defence the following aspects:

- The inning and the score of the game.
- The attitude of the fielders to keep the runner close to the base he was occupying.
- If the pitcher had made attempts to turn to the base occupied by the runner.
- If the fielder who normally covers the base to which the runner made any movement, makes no attempts to cover or catch a throw to such base.
- If the defending team had a strategic reason not to impede the runner's advance.
- Whether the defending team is inadmissibly attempting to deny the runner credit for the stolen base.

16.7.2.4 To clarify the above, the following examples are presented:

Example: In the top of the seventh inning, with the home team winning by 9 runs, the visiting team's batter reaches first base. The runner tries to steal second base and the catcher after receiving the pitch does not make the throw, nor do the players defending second base make an attempt to cover second base. The Official Scorer can judge that there was indifference from the defence.

With a runner on first and third base, the Official Scorer should normally credit a stolen base when the runner on first advances to second base, if in his judgment the play was not attempted on the said runner to prevent the runner from third base scoring on the play to second base.

The Official Scorer may conclude that the defending team impermissibly is trying to deny a runner credit for a stolen base, if the defensive team fails to defend the advance of a runner who is close to equalling and beat a record or lead a stat.

16.7.3 A caught stealing is a statistic recorded on a runner who was put out or would have been put out had an error not been made when said runner attempts to steal a base. A caught stealing should be credited to the catcher or pitcher who contributes in making a runner out, or would have been out, if an error had not occurred in an attempt to steal a base.

16.7.4 The Official Scorer shall also note that a runner was caught stealing when:

16.7.4.1 He is caught off base and attempts to advance to the next base. Any movement or feint the runner makes towards the next base will be considered an attempt to advance.

16.7.4.2 Goes over the base when sliding in his attempt to steal the base and he's tagged out.

16.7.4.3 A runner attempting to steal a base is safe because a throw has been missed. In which case an assist will be credited to the player who made the throw, an error charged to the fielder who missed or did not catch the

throw and a caught stealing charged to the runner.

16.7.5 The Official Scorer shall not score a caught stealing when:

16.7.5.1 As a result of a possible wild pitch or passed ball, a runner is put out attempting to advance. In this instance the runner would not have been credited with a stolen base had he arrived safely.

16.7.5.2 A runner is awarded an extra base because of an obstruction or when a runner is called out for interference by the batter.

16.8 BASES ON BALLS

16.8.1 The Official Scorer shall credit a base on balls to a batter awarded first base, who during his time At Bat receives four pitched balls outside the strike zone.

16.8.1.1 When the fourth pitch outside the strike zone (ball) touches the batter, the Official Scorer shall record it as a batter hit by the pitcher.

16.8.1.2 When a batter who received a base on balls is called out for refusing to advance to first base, the Official Scorer shall not credit the base on balls and charge him with a time At Bat.

16.8.1.3 The Official Scorer shall record an intentional base on balls when a batter is awarded first base because the defensive team's manager so indicates to the Umpire-in-chief his intention not to pitch to a batter for strategic reasons or when the pitcher makes no attempt to throw the last pitch to the batter into the strike zone, but purposely throws the ball outside.

16.8.2 The Official Scorer shall follow the procedure set forth in these WBSC Official Rules of Baseball when more than one pitcher is involved in awarding a base on balls (Rule 18.4.2.3), or when a substitute batter enters the game with a count already on the replaced batter and receives a base on balls (Rule 18.4.2.1).

16.9 STRIKEOUTS

- 16.9.1** A Strikeout is a statistic credited to a pitcher and charged to a batter when the Umpire-in-chief calls three strikes on the batter.
- 16.9.2** The Official Scorer shall record a strikeout when a batter:
- 16.9.2.1** Is called out on a third strike caught by the catcher.
 - 16.9.2.2** Is called out for a third strike not caught by the catcher when there is a runner on first base with less than two out.
 - 16.9.2.3** Becomes a runner because a third strike is not caught.
 - 16.9.2.4** Bunts foul on a third strike, unless such bunt results in a foul fly caught by any fielder in foul territory. In this case the Official Scorer will not record the strikeout and will credit the fielder who caught the ball with an out.
- 16.9.3** When the batter leaves the game with two strikes on his count and the substitute batter completes the strikeout, the Official Scorer shall record the strikeout and time at bat for the first batter. If the substitute batter completes the turn in any other way, including a walk, the Official Scorer shall record the action to the substitute batter.

RULE 17. FIELDING RECORD**17.1 PUTOUTS**

- 17.1.1** An out is one of the three game actions necessary to end the turn of the offensive team. The Official Scorer shall credit an out made by a fielder, whose action causes the batter-runner or a runner to be removed.
- 17.1.2** The Official Scorer shall credit an out to each fielder who:
- 17.1.2.1** Catches a ball that is in the air, whether it is in fair or foul territory.

17.1.2.2 Catches a batted or thrown ball and touches a base to put out a batter or runner, even if he does so on an appeal play.

17.1.2.3 Tags a runner when he is off the base to which he is legally entitled.

17.1.3 The Official Scorer shall credit an automatic out to the catcher when a batter is called out for:

17.1.3.1 Being called out on strikes.

17.1.3.2 An Illegally batted ball.

17.1.3.3 Bunting the ball foul on the third strike, except when such bunt on the third strike is caught by any fielder.

17.1.3.4 Having been touched by a ball hit by him.

17.1.3.5 Having interfered with the catcher.

17.1.3.6 Not batting in his own turn. See Rule 16.1 – Batter out of turn.

17.1.3.7 Refusing to touch first base after receiving a base on balls, being hit by a pitch, or being awarded first base for interference of the catcher.

17.1.3.8 The Official Scorer shall also credit an automatic out to the catcher when a runner is called out for refusing to advance from third base to home.

17.1.4 The Official Scorer shall credit an automatic out on the following plays, for which he shall not credit an assist except as specified in these WBSC Official Rules of Baseball:

17.1.4.1 When the batter is called out for an infield fly that is not caught, the Official Scorer shall credit the out to the player of the defence who in his judgment may have made the catch.

17.1.4.2 When a runner is called out for being touched by a batted ball from in fair territory (including an infield fly), the Official Scorer shall credit the out to the player closest to the ball.

- 17.1.4.3** When a runner is called out for running outside of the 3-foot (0.91 m) line to avoid being tagged, the Official Scorer shall credit the out to the fielder that the runner evaded.
- 17.1.4.4** When a runner is called out for passing another runner, the Official Scorer shall credit the out to the nearest fielder at the point where the pass occurred.
- 17.1.4.5** When a runner is called out for running the bases in reverse order, the Official Scorer shall credit the out to the fielder who is covering the base from which the runner started his run.
- 17.1.4.6** When a runner is called out for interfering with a fielder, the Official Scorer shall credit the out to the fielder with whom the runner interfered, unless the fielder was in the act of throwing the ball when the interference occurred. In this case, the Official Scorer will credit the out to the fielder towards whom the throw was directed and will also credit an assist to the fielder whose throw was interfered with.
- 17.1.4.7** When a batter-runner is called out for interference by a preceding runner, as stated in Rule 12.1.5, the Official Scorer shall credit the out to the first baseman. If the interfered fielder was in the act of throwing the ball, the Official Scorer will also credit him with an assist. The Official Scorer will credit only one assist on that or any other play under the provisions of these WBSC Official Rules of Baseball.

17.2 ASSISTS

- 17.2.1** An assist is a statistic credited to a fielder whose action contributes to a batter-runner or runner being put out.
- 17.2.2** The Official Scorer shall credit an assist to each defending player who:
- 17.2.2.1** Throws or deflects a batted or thrown ball in such a way as to produce an out, or that could have been out but was not due to a subsequent error by another fielder.
- 17.2.2.1.1** Simple ineffective contact with the ball should not be considered as an assist. The Official Scorer

should appreciate that to deflect means to stop, slow down or change the direction of the ball and thereby effectively assist in putting out the batter or a runner.

- 17.2.2.1.2** Only one assist and no more shall be credited to each fielder who throws or deflects the ball on a run-down play, which results in an out or could have been out unless for a later error.
- 17.2.2.1.3** If an out results from an appeal within the natural course of the play, the Official Scorer shall credit an assist to each fielder who participated in the play and whose action allowed the out to be made, except to the fielder making the out.
- 17.2.2.1.4** If an out is made from an appeal play after the previous play has ended and is initiated by the pitcher throwing to a fielder, the Official Scorer shall credit the pitcher and him alone with an assist.

17.2.2.2 Throws or deflects a ball during a play that results in a runner being called out for interference or running off the line.

17.2.3 The Official Scorer shall not credit an assist to:

- 17.2.3.1** The pitcher for a strikeout, unless the pitcher fielded a third strike that was not caught by the catcher and makes a throw that results in an out or could have been out unless for a later error.
- 17.2.3.2** The pitcher when, after a legal pitch received by the catcher, a runner is put out, the catcher catches a runner off base, throws out a runner attempting to steal a base or tags a runner who tries to score.
- 17.2.3.3** A fielder whose wild throw allows a runner to advance, even if that runner is subsequently put out as a result of a continuous play.

A play that follows a bad play, whether an error or not, is a new play and the player committing the bad play will not be credited with an assist unless he participates in the new play.

Example: A batted ball is caught by the second baseman who throws to first base to put out the batter.

His throw is off target and cannot be caught by the first baseman. Due to the bad throw, the batter-runner tries to advance to second base but is put out after the catcher recovered the ball and threw it to the shortstop who made the out. The Official Scorer must only credit an out to the shortstop and an assist to the catcher.

17.3 ERRORS

- 17.3.1** An error is a statistic that will be charged to a fielder whose bad action on a play benefits the offensive team.
- 17.3.1.1** Slow handling of the ball by a fielder that does not involve mechanical misplay shall not be interpreted as an error.
- Example:** A fielder cleanly fields a groundball but does not throw to first base in time to put batter out.
- 17.3.1.2** It is not necessary for a fielder to touch the ball to be charged with an error.
- 17.3.2** The Official Scorer shall credit an error to a fielder when he:
- 17.3.2.1** Makes a bad play such as dropping, missing or not catching the ball or making a bad throw in such a way that the bad play prolongs the presence at bat of the batter, prolongs the presence of a runner on base, or allows a runner to advance one or more bases.
- 17.3.2.2** Drops a fly ball in foul territory that prolongs the presence at bat of the batter, even though he later reaches first base or is put out.
- 17.3.2.3** Lets a batted groundball pass between his legs or drops a fly ball without being touched, but in the Official Scorer's judgment the fielder could have caught the ball with ordinary effort and made the out.
- 17.3.2.4** As an infielder lets a batted ground ball pass either side of the infield, and in the judgment of the Official Scorer a fielder in that position making ordinary effort would have caught the ball and retired the batter or another runner.

- 17.3.2.5** As an outfielder misses a batted fly ball that falls to the ground, and in the judgment of the Official Scorer a fielder in that position making ordinary effort would have caught the ball.
- 17.3.2.6** Catches a thrown ball or a batted ground ball in time to make the batter-runner out and does not touch first base or the batter-runner.
- 17.3.2.7** Catches a thrown or batted ball in time to put out any runner on a force play and fails to touch the base or the runner.
- 17.3.2.8** Makes a bad throw to prevent a runner from advancing and that bad throw allows the runner to advance one or more bases beyond those he would have reached if the bad throw had not occurred.
- 17.3.2.9** Makes a bad throw that allows a runner to reach a base safely and in the judgment of the Official Scorer a good throw would have put out the runner, unless the bad throw was made to avoid a stolen base.
- 17.3.2.10** Throws the ball so low, high or wide, or that bounces on the ground and a runner who could be out reaches one or more bases as a result of that bad throw, the Official Scorer will charge an error to the player who made the bad throw.
- 17.3.2.11** Makes a throw that bounces irregularly, hits a base or the pitcher's plate, or touches a runner, fielder, or Umpire, and the action allows one or more runners to advance.
- The Official Scorer will charge an error to the fielder whose throw was good and well directed, even if it appears to be an unfair decision.
- Example:** An outfielder makes an accurate throw to second base, but it hits the base and bounces back into the outfield area and allows a runner or runners to advance, as each base that a runner advances must be justified.

17.3.2.12 Fails to stop or attempt to stop an accurate throw that allows a runner or runners to advance, provided there is reason to make the throw. If said throw is made towards second base, the Official Scorer will determine which fielder should have covered such base, second base or shortstop, for which he must charge the error to the negligent fielder.

If in the opinion of the Official Scorer there was no reason to make the throw, the error should be charged to the fielder who made the throw.

17.3.2.13 Induces another fielder to make an error. For example, by colliding with another fielder he hinders his teammate from catching a batted ball. The Official Scorer shall charge an error to the defending player who interfered and exempt the hindered player from the error.

17.3.3 The Official Scorer will charge only one error on a bad throw, regardless of the number of bases advanced by one or more runners.

17.3.3.1 When an Umpire awards the batter, or a runner or runners one or more bases because of interference or obstruction, the Official Scorer shall charge an error to the fielder who committed it, regardless of how many bases the batter, or runner or runners have advanced.

If the Official Scorer considers that the obstruction does not change the play, he will not charge the error to the fielder who committed it.

17.3.4 The Official Scorer shall not record mental or judgmental errors as errors, unless determined in these WBSC Official Rules of Baseball. A mental error by a player in defence that causes a bad play or leads to a physical error, such as throwing the ball into the stands or throwing or letting it roll to the mound, thinking there are three outs and thereby allowing one runner or more runners advance, will not be considered a mental error for the purposes of this rule. Therefore, the Official Scorer will charge an error to the fielder who makes such a mistake.

17.3.4.1 The Official Scorer shall not charge an error to the pitcher who fails to cover first base on a play in which the batter-runner safely reaches first base.

17.3.4.2 The Official Scorer shall not charge an error to a fielder who erroneously throws to a wrong base.

17.3.5 The Official Scorer shall not charge an error:

17.3.5.1 To the catcher when, after receiving the pitch, he makes a misplay attempting to prevent a runner from stealing a base, unless the misplay allows the runner attempting to steal to advance one or more bases beyond the initial base he was attempting to steal, or allows another runner or runners to advance one or more bases.

17.3.5.2 To a fielder who makes a bad throw attempting to put out a runner, and in the judgment of the Official Scorer the runner would not have been put out with a perfect throw (ordinary effort), unless the bad throw allows any runner to advance further than the base that he would have reached if there had been no bad throw.

17.3.5.3 To a fielder who makes a bad throw with the intent to complete a double play or triple play, unless the bad throw allows any runner to advance beyond the base he would have reached had the bad throw not occurred.

When a fielder fails to catch a thrown ball, which would otherwise have completed a double play or triple play, the Official Scorer shall charge an error to the fielder who did not catch the ball and credit an assist to the fielder who made the throw.

17.3.5.4 To a fielder when, after failing to catch a batted ground ball, or after dropping a batted fly ball or line drive, or a thrown ball, he recovers the ball in time to force out a runner at any base.

17.3.5.5 To a fielder who deliberately prolongs a time at bat of a batter with a runner on third base and with less than two outs, and drops a batted ball in foul territory with the intent that that runner not score a run after the catch.

17.3.5.6 A wild pitch or a passed ball is scored.

17.3.5.7 When the batter is awarded first base for a base on balls, for being hit by a pitch, or for a wild pitch or passed ball. (See Rule 17.5).

17.3.5.8 When a runner or runners advance as a result of a wild pitch, a passed ball or a balk.

17.3.5.8.1 When the fourth called ball is a wild pitch or passed ball and:

- The batter-runner advances one base beyond first base.
- Any runner forced to advance due to a base on balls advances more than one base.
- A runner who is not forced to advance, advances one or more extra bases. In this case, the Official Scorer shall note the base on balls to the batter and the wild pitch or passed ball to justify the advancement of the runner or runners.

17.3.5.8.2 When the catcher recovers the ball after a wild pitch or passed ball on the third strike and puts out the batter-runner by tagging him or with a throw to first base and another runner or runners advance on the play. In this situation, the Official Scorer will record the strikeout, putout, and assists, if any, and justify advancing the other runner or runners on a fielder's choice.

17.4 DOUBLE PLAYS AND TRIPLE PLAYS

17.4.1 The Official Scorer shall credit participation in a double play or triple play to each fielder who makes an out or an assist when two or three players are put out, between the moment a pitch is thrown and the moment that the ball becomes dead or is again in the possession of the pitcher in his pitching position, unless an error or bad play occurs between the outs.

17.4.1.1 The Official Scorer shall also credit a double play or triple play, if after the ball is in possession of the pitcher an appeal play is made resulting in an additional out.

17.4.1.2 If the double or triple play is the result of "preceding runner interference", the Official Scorer shall not credit a grounded into double play to the batter. See WBSC Official Rules of Baseball Rule 19.2.1.16.

17.4.1.3 The Official Scorer will credit a participation in a double play or triple play in the case of a forced double play, or a reverse double play.

17.4.2 The Official Scorer shall record the batter with a grounded into double play when with less than two outs, with one or more runners forced, there is a batted ball grounded to the infield that causes two or three outs on the forced runners or would have if there had not been an error on the play.

17.5 WILD PITCHES AND PASSED BALLS

17.5.1 The Official Scorer shall charge the pitcher with a wild pitch when:

17.5.1.1 A legally pitched ball is so high, or so low, or so far off the plate that the catcher cannot catch or stop it with ordinary effort, thereby allowing a runner or runners to advance.

17.5.1.2 A legally pitched ball touches the ground or home plate before reaching the catcher and cannot be caught by the catcher, allowing a runner or runners to advance.

17.5.1.3 The third strike is a wild pitch that cannot be caught by the catcher and allows the batter-runner to reach first base. The Official Scorer will score a strikeout and a wild pitch.

17.5.2 The Official Scorer shall charge a passed ball to the catcher when:

17.5.2.1 He fails to catch or control a legally thrown ball that could have been caught or controlled with ordinary effort, thereby allowing one or more runners to advance.

17.5.2.2 The third strike is a pitch not controlled by the catcher who could have caught it with ordinary effort and allows the batter-runner to reach first base. The Official Scorer will score a strikeout and a passed ball.

17.5.3 The Official Scorer shall not charge a wild pitch or passed ball if the defending team makes an out before any runner advances.

Example: With a runner on first base a pitch touches the ground and the catcher cannot catch it, but the catcher manages to recover the ball and throws to second base in time to throw out the runner. In this case the Official Scorer will not charge the pitcher with a wild pitch.

With a runner on first base the catcher fails to catch a pitch that the Official Scorer judged could have been caught. The catcher manages to recover the ball and throws to second base in time to put the runner out. The Official Scorer will not charge the catcher with a passed ball.

In both examples the Official Scorer will record the advance of any other runner as a fielder's choice.

RULE 18. PITCHING RECORD

18.1 WORK OF THE PITCHERS

The Official Scorer for the purposes of these WBSC Official Rules of Baseball must take into consideration the following:

- Starting Pitcher: is the pitcher who throws the first pitch to the leadoff batters in both line-ups.
- Relief Pitcher: is a pitcher who enters the game after the starting pitcher is removed for any reason (injury, ineffectiveness, ejection or strategy).

18.2 PITCHERS' DECISION

The Official Scorer shall credit in each game a winning pitcher, a losing pitcher and, if applicable, credit a pitcher with a save.

18.2.1 WINNING PITCHER:

Obviously, he must belong to the winning team of the game and the Official Scorer will credit as the winning pitcher the one who was in the game (pitching) when his team takes the lead on the scoreboard, or during the offensive inning in which said pitcher is removed from the game, and his team does not lose such advantage.

The Official Scorer must also consider the following:

- 18.2.1.1** Whenever the score is tied, the game becomes a new game with respect to determining the winning pitcher.
- 18.2.1.2** When the opposing team ties or takes the lead, all pitchers who participated in the game up to that point and were removed are excluded from being credited with the win.
- 18.2.1.3** If the pitcher against whom the opposing team tied or took the lead continues to pitch, and his team regains the lead and holds it until the end of the game, that pitcher shall be credited with the win.
- 18.2.1.4** A starting pitcher to claim the win in the game must pitch at least the minimum of inning as specified in the Appendix A2.2:
- 18.2.1.5** When a starting pitcher is eligible for the win but does not pitch the minimum required innings, the Official Scorer shall credit the winning pitcher to the relief pitcher, if there was only one. If more relief pitchers have participated, the Official Scorer will credit the one who, in his opinion, was the most effective in obtaining the win.
- 18.2.1.6** To credit the win to a relief pitcher, he must pitch at least one complete inning, or be the pitcher when a fundamental and crucial out is made for the development and result of the game.
- 18.2.1.7** The first relief pitcher who pitches effectively may not necessarily be credited with the win. The Official Scorer must credit the victory to the relief pitcher who, in his opinion, was the most effective.
 - The Official Scorer in determining the most effective relief pitcher must consider the number of runs and earned runs allowed, runners placed on base by each relief pitcher and the game situation at the time of each relief pitcher's appearance.

- If two or more relief pitchers were similarly effective, the Official Scorer should assume that the first relief pitcher to participate in the game is the winner.

18.2.1.8 The Official Scorer shall not credit as the winning pitcher the relief pitcher who had a brief and ineffective appearance, and at least one subsequent relief pitcher pitches effectively to help maintain his team's lead. In such a case, the Official Scorer shall credit the subsequent relief pitcher who, in his judgment, was more effective with the win.

The Official Scorer shall consider the appearance of a relief pitcher to be brief and ineffective when he pitches less than one inning and, in his performance, allows the opposing team to score two or more runs, even if those runs are recorded to the previous pitcher's statistics.

18.2.2 LOSING PITCHER:

Undoubtedly, he must belong to the losing team of the game and the Official Scorer will credit as the losing pitcher the pitcher responsible for allowing the run that gives the opposing team the lead that it maintains until the end of the game.

The Official Scorer must also keep in mind the following:

18.2.2.1 Each time the score is tied the game becomes a new game with respect to determining the losing pitcher.

18.2.2.2 A pitcher must have all runs scored by runners he has left on base recorded, regardless of whether the runs were scored when a subsequent pitcher is pitching, except for considerations set forth in these WBSC Official Rules of Baseball Rule 18.4.1.

18.2.3 SAVED GAME (RELIEF PITCHERS):

The Official Scorer shall credit a relief pitcher with a save when his team wins the game and:

18.2.3.1 He is the pitcher who finishes said game.

18.2.3.2 He is not the winning pitcher.

18.2.3.3 He pitched at least one-third of an inning (one out).

18.2.3.4 Meets one of these conditions:

- He enters the game with a lead of no more than three runs and pitches at least one inning;
- He enters the game, regardless of the count, when the possible tying run is on base or is one of the first two batters he faces (is the batter at bat, or is the batter in the on-deck circle); or
- He pitches at least:
 - Three innings in a game scheduled on nine innings; or
 - Two innings in a game scheduled on seven or six innings, only if the game lasts at least 5 innings.

18.2.4 THE OFFICIAL SCORER WILL ACCREDIT:

18.2.4.1 A COMPLETE GAME to the pitcher who starts and ends the game, that is, who pitches all the innings that his team has on defence without the participation of a relief pitcher.

18.2.4.2 A SHUTOUT to the pitcher who pitches a complete game and does not allow any runs to be scored. As he pitched for every out of the game and did not allow a run, he must also be the winning pitcher.

- The Official Scorer shall not credit any pitcher with a shutout who does not pitch the entire game, unless he goes in to pitch with no out, before the opposing team has scored a run in the first inning, ends said inning and pitches the remainder of the game without allowing any runs.
- When two or more pitchers combine to pitch a scoreless game, all pitchers will receive credit for participating in a combined shutout and it shall be indicated in the competition statistics.

18.3 EARNED RUNS AND ALLOWED RUNS

18.3.1 The Official Scorer shall record an earned run when the opposing team scores a run that is the responsibility of the pitcher, i.e., each time a runner scores a run assisted by a hit, walk, batter hit by a pitch, stolen base, sacrifice bunt or fly, putout, fielder's choice, balk, wild pitch (including a wild pitch on a third strike), before the defending team has had an opportunity to retire the offensive team.

For purposes of determining whether or not a run is earned, an intentional walk will be interpreted in the same manner as any other walk; a wild pitch or a balk is a pitcher's responsibility therefore like walks it contributes in exactly the same way for an earned run.

Example: Pitcher 1 puts out Batter A, Batter B hits a three-base hit (triple), with Batter C at bat, the pitcher balks, and the runner (Batter B) scores. The pitcher puts out Batter C and Batter D to end the inning.

The offensive team scored a run, which is recorded as earned by Pitcher 1 because it was scored due to the balk.

- 18.3.2** The Official Scorer to determine earned runs shall reconstruct the inning without passed balls or errors (excluding catcher's interference). When the Official Scorer credits a fielder with an error, the pitcher will always be given the benefit of the doubt with respect to determining what base or bases a runner or runners would have reached on a play without errors.

The Official Scorer shall recognise that an error by the pitcher will be treated the same as an error by another fielder.

18.3.3 THE OFFICIAL SCORER SHALL NOT RECORD AN EARNED RUN WHEN:

- 18.3.3.1** A batter-runner reaches first base as follows:

- 18.3.3.1.1** For an error of a player to the defence.

Example: Pitcher 1 retires the first two batters of the inning; Batter C reaches first base on an error by a fielder, Batter D hits a home run, and then the pitcher puts out the next batter.

The offensive team scored two runs. The run scored by Batter C is unearned because he reached first base on an error. The run scored by Batter D is unearned because Batter C should have been the third out of the inning.

- 18.3.3.1.2** For a hit or other play after his time at bat was prolonging by a foul fly that was not caught by a

fielder and the Official Scorer credited the fielder with an error for such fault.

Example: Pitcher 1 retires the first two batters of the inning; Batter C hits a ball into foul territory and the Official Scorer records an error by a player on defence who was able to catch the ball with ordinary effort and failed to do so prolonging the batter's turn. Batter C hits a home run and the pitcher gets the next batter out.

The offensive team scored a run, which was unearned for Pitcher 1, as the defence's error extended Batter C's turn, which should have been the third out of the inning.

- 18.3.3.1.3** For defensive interference or obstruction

When a batter is awarded first base on catcher's interference and scores, the run will not count as an earned run. However, the Official Scorer in this case will not assume that such batter would have been out in the absence of defensive interference, since he did not have the opportunity to complete the at-bat and it is unknown how it would have ended.

Example: Pitcher 1 gets the first two batters out, Batter C is awarded first base on catcher's interference, Batter D hits a home run, and then Batter E is the third out of the inning.

The offensive team scored two runs, of which only one will be credited as earned for Pitcher 1, that of Batter D who hit the home run, as the Official Scorer cannot assume that Batter C would have been put out to end the innings if there was no interference.

- 18.3.3.2** A run is scored by a runner whose time on bases was prolonged by an error and who could have been put out on the play without the error.

Example: With one out, Batter B reaches first base on a safe hit; Batter C grounds the ball to the second baseman

who attempts to throw out Batter B but throws the ball wild. An error is scored by the Official Scorer for the misplay and for allowing the runner to advance. Batter D grounds out at first base and both runners advance one base. Batter E get a safe hit, Batter B scores, and Batter C advances to third. Batter F is the last out of the inning.

The offensive team scored a run, which is not earned due to the error of the defence which prolonged the life on base of Batter B as he should have been out.

- 18.3.3.3** A run was scored as a runner advanced one or more bases on an error, passed ball, defensive interference, or obstruction and in the judgment of the Official Scorer that run would not have been scored without the aid of the misplay.

Example: Pitcher 1 retires the first batter of the inning, Batter B reaches first base on a hit. Batter C hits a two-base hit (double) and Batter B advances to third base. Batter D is the second out by strikeout. During the at bat of the Batter E, the catcher incurs a passed ball and Batter B scores a run. Batter E is subsequently out and the inning ends.

The offensive team scored a run, which cannot be credited as an earned run to Pitcher 1 as Batter B would not have scored without the aid of the passed ball.

18.4 SUBSTITUTION OF PITCHERS AND RUNS ALLOWED

- 18.4.1** When pitchers are changed during an inning, the Official Scorer shall not record to the relief pitcher any runs (earned or unearned) scored by a runner who was on base at the time he came in to pitch, nor any runs scored by any runner who reached base on a fielder's choice in which the defence put out a runner left on base by the previous pitcher.

When a pitcher leaves runners on base and is relieved, he shall be responsible for as many runs subsequently scored as the number of runners he left on base when he left the game, unless such runners are put out without the action of the batter. For example, caught stealing, caught off base, or called out for interference when the batter-runner does not reach first base on the play.

The Official Scorer shall charge each pitcher for the number of runners he put on base, rather than charging each runner individually.

Example 1: Pitcher 1 allows a hit by Batter A and is then relieved by Pitcher 2. Batter B grounds out and Batter A advances to second base; Batter C strikes out and is the second out. Batter D hits safely and Batter A scores. The following batters are put out and the inning ends.

The run scored must be charged to Pitcher 1.

Example 2: Pitcher 1 hits Batter A with a pitch and is then relieved by Pitcher 2. Batter B hits a ground ball to the infield that allows the defence to put out Batter A. Batter C grounds out and Batter B advances to second base. Batter D hits a two-base hit (double) and Batter B scores.

The run scored must be charged to Pitcher 1.

Example 3: Pitcher 1 throws a walk to Batter A and is relieved by Pitcher 2. Batter B hits a two-base hit (double) and Batter A advances to third base. Batter C grounds to second base, Batter A is out at home plate and Batter B advances to third base. Batter D is the second out of the inning on a fly ball and all runners remain where they are. Batter E gets a safe hit and Batter B scores. Batter F is the third out of the inning.

The run scored must be charged to Pitcher 1.

Example 4: Pitcher 1 allows a hit by Batter A and is relieved by Pitcher 2. Batter B is hit with a pitch, Batter A advances to second base. Batter C hits a fly ball and is out. During Batter D's at bat, Batter A is caught off base for the second out of the inning. Batter D hits a three-base hit (triple) and Batter B scores. Batter E is the third out of the inning.

The run scored by Batter B will be credited to Pitcher 2.

Example 5: Pitcher 1 hits Batter A with a pitch and is relieved by Pitcher 2. Batter B gets a hit and Pitcher 2 is relieved by Pitcher 3. Batter C hits a ground ball to the infield and Batter A is out at third base. Batter D also hits a ground ball to the infield and Batter B is out. Batter E hits a home run and three runs are scored (Batter

C, Batter D and Batter E). The next batter is the third out of the inning.

The Official Scorer shall record one run to Pitcher 1, one run to Pitcher 2 and one run to Pitcher 3.

Example 6: Pitcher 1 allows a two-base hit (double) by Batter A and is relieved by Pitcher 2. Batter B is walked. Batter C is hit with a pitch. Batter D hits a ground ball to the infield and the defence puts Batter A out at home plate. Batter E hits a two-base hit (double) and Batter B and Batter C score on the run. The following batters are put out and the inning ends.

The Official Scorer shall award one run to Pitcher 1 and one run to Pitcher 2.

Example 7: Pitcher 1 throws a walk to Batter A and is relieved by Pitcher 2. Pitcher 2 allows a hit by Batter B and on the play Batter A attempts to reach third base and is put out. Batter B advanced to second base on the throw. Batter C hits a three-base hit (triple) and Batter B scores. The following batters strike out and the inning ends.

The run scored must be charged to Pitcher 2.

18.4.2 A relief pitcher shall not be liable when the first batter he faces reaches first base by four balls, if such batter has a lead in balls and strikes when the substitution is made.

18.4.2.1 If when the pitcher's substitution is made the batter's count is:

- 2 balls, 0 strike
- 2 balls, 1 strike
- 3 balls, 0 strike
- 3 balls, 1 strike
- 3 balls, 2 strikes

and the batter receives a walk, the Official Scorer shall credit that batter and the base on balls to the previous pitcher and not to the relief pitcher.

18.4.2.2 Any other action by that batter, such as a hit, an error, a fielder's choice, a force out, or hit by a pitch will be credited to the relief pitcher. These conditions do not contradict or

conflict with what is indicated in WBSC Official Rules of Baseball Rule 18.4.1.

18.4.2.3 If when the pitcher is changed the batter's count is:

- 2 balls, 2 strikes
- 1 ball, 2 strikes
- 1 ball, 1 strike
- 1 ball, 0 strike
- 0 ball, 2 strikes
- 0 ball, 1 strike

the Official Scorer shall credit that batter and his action to the relief pitcher.

18.4.3 When a pitching change is made during an inning, the relief pitcher will not benefit from previous out opportunities that have not been taken when determining earned runs.

18.4.3.1 The intent is to credit each relief pitcher with earned runs for which they are solely responsible.

18.4.3.2 In some situations, runs recorded as earned for the relief pitcher may be charged as unearned runs for the team.

Example 1: After two outs, Pitcher 1 allows Batter A to walk. Batter B reaches first base on an error by a defensive player. Pitcher 2 enters the game as a relief pitcher. Batter C hits a home run, scoring all runners. Batter D is the third out of the inning.

The Official Scorer will credit two unearned runs to Pitcher 1, one earned run to Pitcher 2 and three unearned runs for the team, as the inning should have ended when the error was made.

Example 2: After two outs, Pitcher 1 hits Batter A with a pitch followed by Batter B who gets a safe hit, and is then relieved by Pitcher 2. Batter C reaches first base on an error by a fielder with other runners advancing one base. Batter D hits a home run, scoring four runs. The next batter is out and the inning ends.

The Official Scorer shall score two unearned runs to Pitcher 1 and two unearned runs to Pitcher 2 as the inning would have ended when the error was made.

Example 3: Pitcher 1 allows a hit by Batter A. Batter B reaches first base on an error by a fielder and Batter A advances to second base. Pitcher 2 relieves Pitcher 1. Batter C hits a home run and three runs are scored. The following two batters, D & E are retired. Batter F reaches first base on an error by a fielder. Batter G is hit by a pitch. Batter H hits a three-base hit (triple) and two runs are scored. The next batter is out and the inning is over.

The Official Scorer shall score two runs to Pitcher 1, one earned and one unearned; and three runs to Pitcher 2 with only one being an earned run.

RULE 19. STATISTICS

19.1 RESPONSIBILITIES

The Scoring Director, based on the records of the Official Scorer and assistant scorer(s), after each game is declared over, including forfeited games, will be responsible for managing and preparing the report that includes all individual and collective records for each player and team, for each championship game and accumulated for the entire competition. The reports must include all the statistics specified in these rules related to offence (batting) and defence for each player who appears in a game of the competition, as well as the statistics relating to the pitchers.

- 19.1.1** The Scoring Director will publish said report through the formats, means and periods established by the WBSC for each competition.
- 19.1.2** If there is any discrepancy between the report prepared by the Scoring Director and the records of an Official Scorer, they must consult each other to resolve any difference.
- 19.1.3** At the end of the tournament, the Scoring Director must prepare a final report listing all the records and individual and collective

performances, the individual leaders and the most outstanding players in accordance with the guidelines established in these WBSC Official Rules of Baseball and for the competition.

19.2 PREPARATION OF REPORTS

For the preparation and management of the reports, the Scoring Director must include:

19.2.1 The following data and statistics for each batter and runner:

- 19.2.1.1** Name and last name, if he bats right or left handed or is a switch hitter, and for fielders it must include which hand he throws with. In addition, the report of each game must include the batting order and position or positions played by each player.
- 19.2.1.2** AB - Number of times At Bat, except for those times at bat where the player:
 - Hits a sacrifice bunt.
 - Hits a sacrifice fly.
 - Is awarded first base on four balls (walking) intentionally or not.
 - Is hit by a pitch.
 - Is awarded first base because of interference or obstruction.
- 19.2.1.3** R - Number of runs scored.
- 19.2.1.4** H - Total number of safe hits.
- 19.2.1.5** RBI - Number of runs batted in.
- 19.2.1.6** 2B - Number of two-base hits (doubles).
- 19.2.1.7** 3B - Number of three-base hits (triples).
- 19.2.1.8** HR - Number of home runs.
- 19.2.1.9** BB - Total number of bases on balls received.
- 19.2.1.10** SB - Number of stolen bases.

19.2.1.11 CS - Number of times caught stealing.

19.2.1.12 HP - Number of times hit by a pitch.

19.2.1.13 SH - Sacrifice bunts.

19.2.1.14 SF - Sacrifice fly.

19.2.1.15 K - Strikeouts received.

19.2.1.16 GDP - Number of times the batter grounded into double plays; the Official Scorer shall not charge a batter for grounded into double play if the batter-runner is called out for interference by a preceding runner.

19.2.1.17 IO - Number of times awarded first base for interference or obstruction.

19.2.1.18 TB - Total number of bases reached by safe hits.

19.2.1.19 IBB - Separate list of intentional bases on balls received.

19.2.2 The following statistics for each fielder:

19.2.2.1 PO - Number of outs made.

19.2.2.2 A - Number of assists made.

19.2.2.3 E - Number of errors made.

19.2.2.4 DP - Number of double plays in which he participated.

19.2.2.5 TP - Number of triple plays in which he participated.

19.2.2.6 IP - Number of innings played by each fielder, noted on the line opposite his name. When a fielder is substituted or changes position during an inning, the number is calculated according to the number of putouts he has made in that position.

19.2.3 The following statistics for each pitcher:

19.2.3.1 Name and last name, throwing hand.

19.2.3.2 IP - Number of innings pitched, to calculate them the Official Scorer must count each out made as a third (1/3) of an inning.

Examples: If a starting pitcher is relieved in the seventh inning with one out, the Official Scorer will credit him 6 1/3 (6.1) innings.

If a starting pitcher is relieved in the fifth inning with no outs, the Official Scorer will credit him 4 full innings (4.0) and indicate how many batters that pitcher faced in the fifth.

If a relief pitcher retires two batters and is substituted, the Official Scorer will credit him with 2/3 innings pitched (0.2).

19.2.3.3 H - Number of hits allowed.

19.2.3.4 R - Number of runs allowed.

19.2.3.5 ER - Number of earned runs allowed.

19.2.3.6 BB - Total number of bases on balls awarded.

19.2.3.7 SO - Number of struck out batters.

19.2.3.8 WP - Number of wild pitches.

19.2.3.9 HP - Number of batters hit by a pitch.

19.2.3.10 BK - Number of balks.

19.2.3.11 IBB - Number of all intentional walks awarded.

19.2.3.12 SH - Number of sacrifice bunts allowed.

19.2.3.13 SF - Number of sacrifice flies allowed.

19.2.3.14 2B - Number of two-base hits allowed.

19.2.3.15 3B - Number of three-base hits allowed.

19.2.3.16 HR - Number of home runs allowed.

19.2.3.17 IO - Number of batters awarded first base for interference or obstruction.

19.2.3.18 AB - Number of batters who officially batted against the pitcher, taking into consideration what is indicated in WBSC Official Rules of Baseball Rule 19.2.1.2.

19.2.3.19 BF-Total number of batters he faced.

19.2.4 The following data or information:

19.2.4.1 In each game indicate the date, place and stadium where it was played, the names of the teams and the players who participated.

19.2.4.2 Name of the winning pitcher.

19.2.4.3 Name of the losing pitcher.

19.2.4.4 If any, name of the pitcher to whom a save is credited.

19.2.4.5 The score inning by inning for each team.

19.2.4.6 If the game was won in the last half of an inning, indicate the number of outs when the winning run was scored.

19.2.4.7 Names of Umpires, listed in this order: Umpire-in-chief, first base Umpire, second base Umpire, third base Umpire and if applicable, left field and right field Umpires.

19.2.4.8 Name of the Official Scorer, assistant scorer(s) and Technical Commissioners.

19.2.4.9 Time it took to play the game, discounting delays due to weather, lighting failure or any technological failure not related to the action of the game. A delay in attending to an injured player, manager, base coach, or an Umpire must also be taken into account in calculating the time of the game.

19.2.4.10 Official attendance, which will be provided by the organising committee of the competition.

19.2.5 The following additional data:

19.2.5.1 Name of the starting pitcher and the pitcher who finished for each team.

19.2.5.2 Number of passed balls committed by each catcher.

19.2.5.3 Name of the players who participated in double and triple plays.

19.2.5.4 Number of runners left on base by each team. This total will include all runners who remained on base for any reason and who did not score or were put out. The Official Scorer shall include in this total a batter-runner whose hit resulted in another runner being put out for the third out.

19.2.5.5 Name of the batters who homered with the bases loaded (grand slam).

19.3 GAMES PLAYED

When a player appears in the batting order at the start of a game and is substituted before he plays in defence, he will not be credited in the defensive statistics unless he actually plays that position during the game. However, all players mentioned or included in the batting order will be credited with one game played in the offensive (batting) statistics.

19.3.1 A player will be credited with playing defence if that player is on the field for at least one pitch or play.

19.3.2 If a game is called, for example, for weather reasons, after a substitute player enters the game, but before a pitch or play is made, such player shall be credited with one game played in the batting statistics, but not in defensive stats.

19.4 EXTRA GAMES

Any game played to resolve a tie in the standings after the end of the scheduled round to determine the individual leaders must be included in the competition statistics.

19.5 INDIVIDUAL AWARDS

In each competition the individual work of the players will be recognised, evaluating the statistics of the offence (batting) and defence, including the pitchers. Such recognition will be adjusted to show the following:

19.5.1 OFFENSIVE:

19.5.1.1 The leader in batting average, slugging and on base will be the player who has the highest average in each category and has the minimum or more than the appearances required.

19.5.1.2 The leaders in home runs, triples, doubles, and singles, runs batted in, runs scored and stolen bases, will be the player who accumulated the most to their credit.

19.5.2 PITCHERS:

19.5.2.1 The pitching leader by earned run average allowed will be the one with the lowest average and has played in the minimum or more than the required innings.

19.5.2.2 The leaders in strikeouts achieved, most games won and most games saved, will be the player who accumulated the most in each category.

19.5.3 DEFENCE:

The defensive leaders will be those who have the highest fielding average in their position and have also played the minimum or more than the games required in the respective defensive position.

19.5.4 The WBSC may present different and/or additional prizes and recognition to those indicated in these WBSC Official Rules of Baseball for each specific competition.

19.6 AVERAGES

The calculation of the averages will be obtained through the following formulas:

19.6.1 Batting average, divide the total number of safe hits by the total times at bat $[H / AB]$.

19.6.2 Slugging average, divide the total bases reached by safe hits by the number of times at bat $[TB / AB]$.

19.6.3 On-base percentage, divide the total number of safe hits plus all the bases on balls received and hit by a pitch, by the total number of times at bat, plus all the bases on balls received, plus hits by pitch, plus sacrifice flies. For the calculation of the on-base percentage, the number of times a batter reaches first base due to interference or obstruction will not be taken into account. $[(H + BB + HP) / (AB + BB + HP + SF)]$.

19.6.4 Average of games won and lost, divide the total of games won by the total of games won and games lost $[W / (W + L)]$.

19.6.5 Pitcher's earned run average, multiply the total number of earned runs allowed by the pitcher by the number of innings (IC) scheduled for the competition or category (see Appendix A2.3), divide the result by the total number of innings pitched (including the fractions or third of an inning) $[ER * IC / IP]$.

19.6.6 Fielding average (defence), add the total of outs made plus the assists made and divide this by the total of the sum of outs, assists and errors made- $[(PO + A) / (PO + A + E)]$.

19.7 MINIMUM REQUIREMENTS TO QUALIFY FOR INDIVIDUAL PRIZES

19.7.1. To qualify for the batting, slugging and on-base percentage title, players must have a minimum number of appearances at the plate, which will be obtained by multiplying the number of games played by the number of appearances specified in Appendix A2.4.

Total plate appearances shall include official at-bats, plus bases on balls, times hit by a pitch, sacrifice bunts, sacrifice flies, and the number of times the batter is awarded first base for interference or obstruction.

If despite the minimum plate appearances required, a player with fewer than the required number of appearances has the highest batting average, slugging percentage or on-base percentage if charged with the required number of plate appearances as official times at bat, then that player will be awarded the respective prize, as the case may be.



Fractions of home plate appearances shall be rounded up or down to the nearest whole number.

Note: In the Premier12, if a team has played 8 games, to qualify for the batting, slugging and on-base percentage, a player must have a minimum of 22 appearances at the plate (8 games x 2.7 appearances = 21.6).

19.7.2 To qualify for the pitching titles of earned runs allowed and average games won and lost, pitchers must have a minimum innings pitched performance of at least as many innings as the number of games played by their team multiplied by the coefficient specified in Appendix A2.5. Fractions of innings for the minimum number required shall be rounded to the nearest third of an inning.

Example: In the Premier12, if a team played 8 games, to qualify for the titles of earned run average and average games won and lost, a pitcher must have a minimum of 6.1 (6 1/3) innings pitched (8 games x 0.8 = 6.4).

19.7.3 The individual leaders in defence will be the players with the highest average at each position who have participated in the following minimum number of games:

19.7.3.1 Catchers: must have participated as a catcher in at least half (50%) of the number of games scheduled for his team in the competition.

19.7.3.2 Infielders and outfielders: must have participated in the position in at least two thirds (67%) of the number of games scheduled for their team in the competition.

19.7.3.3 Pitchers: must have pitched in at least as many innings as the number of games scheduled for his team in the competition, unless another pitcher has an equal or higher fielding average and has participated in a greater number of plays in fewer innings.

19.8 RECORDING CUMULATIVE RECORDS

19.8.1 CONSECUTIVE HITTING STREAKS:

The record for consecutive hits will not be finalised if the batter's appearance at the plate ends in a walk, hit by a pitch, defensive interference, or a sacrifice bunt. A sacrifice fly will end the record.

19.8.2 CONSECUTIVE GAMES HITTING STREAKS:

The record for hits in consecutive games will not end if all of the player's appearances at home plate in a game (one or more) result in a base on balls, hit by a pitch, defensive interference or tag or sacrifice. The record will end if the player hits a sacrifice fly.

A player's record for hitting in consecutive games will be determined by the consecutive games in which he participates and not by the games played by his team.

19.8.3 CONSECUTIVE GAMES PLAYING STREAKS:

The record for consecutive games played will be extended if the player plays at least half an inning on defence, or if he completes an at-bat by reaching a base or being put out. An appearance only as a pinch runner will not extend the record. The record will continue if a player is ejected from a game before he can meet the established requirements.

19.8.4 For the purpose of cumulative record keeping guidelines, all performances to complete a suspended game will be considered as having occurred on the original date of the game.



APPENDIX 01.

WBSC BASEBALL WORLD CUPS

A1. BASEBALL RULES

All games will be played under the event year of the WBSC Official Rules of Baseball and Baseball Umpire Manual Procedures and Interpretations unless noted in this section.

A1.1 DESIGNATED HITTER

The designated hitter is accepted at all WBSC Tournaments except U-12 Baseball World Cup. See WBSC Official Rules of Baseball Rule 9.3.

A1.2 INNINGS

The WBSC Executive Board has established a number of innings for each WBSC Baseball World Cups as mentioned below:

U-12 BASEBALL WORLD CUP	6 innings
U-15, U-18, U-23 & WOMEN'S BASEBALL WORLD CUP	7 innings
PREMIER12	9 innings

A1.3 PROTECTIVE EQUIPMENT

For U-18 and below, double ear-flap helmet is mandatory, while for U-23 and Premier12, single ear-flap helmet is acceptable for the hitter, base-runners. It is also recommended that base coaches wear the skull caps. For catchers including warm-up and bullpen catchers, wearing protective gear is required.

Note: The skull caps for coaches is not required but highly recommended.

A1.4 RUN DIFFERENCE

A1.4.1 RUN DIFFERENCE RULE

A1.4.1.1 U-12 BASEBALL WORLD CUP

For six inning games, if a team is losing by fifteen (15) or more runs after having batted at least in four (4) innings, the games is ended at that point. If a team is losing by ten (10) or more runs after having batted at least in five (5) innings, the game is ended at that point. However, run difference rules will not apply to the World Championship game while it is enforced for the Bronze medal game.

A1.4.1.2 U-15, U-18, U-23 & WOMEN'S BASEBALL WORLD CUP

If a team is losing by ten (10) or more runs after having batted at least in five (5) innings, the game is ended at that point. However, run difference rules will not apply to the World Championship game while it is enforced for the Bronze medal game.

A1.4.2 EXTRA INNING RULES

Note: The runners put on 1B and 2B as effect of the Extra Inning Rules shall be considered as “ghost runners” in charge to the pitcher who starts the extra inning. In any case the runs scored by such players, or by any runner who reaches base on a fielder’s choice in which the defence puts out a “ghost runner”, will always be considered as unearned runs.

A1.4.2.1 U-12 BASEBALL WORLD CUP

If the game remains tied after the completion of six (6) innings, the following procedures will be implemented during extra innings:

A1.4.2.1.1 Each team will begin the 7th inning (and any subsequent necessary extra innings) with a player on first and second, no outs.

A1.4.2.1.2 The line-up will continue as in any other inning. For example, if the 6th inning ends with the #8 hitter having made the last plate appearance (PA), the 7th inning begins with the #9 at bat and the 2B runner is the #7, and 1B runner is the #8 in the line-up, or any pinch runners for these players.

A1.4.2.1.3 With the exception of beginning the inning with runners on 1B and 2B with no one out, all other WBSC Official Rules of Baseball and WBSC Tournament Regulations will remain in effect during extra innings required to determine a winner.

A1.4.2.1.4 The traditional system of the visiting team hitting in the top of the inning and the home team hitting

in the bottom of the inning (if needed) will remain in effect until a winner is determined.

A1.4.2.2 U-15, U-18, U-23 & WOMEN'S BASEBALL WORLD CUP

If the game remains tied after the completion of seven (7) innings, the following procedures will be implemented during extra innings:

A1.4.2.2.1 Each team will begin the 8th inning (and any subsequent necessary extra innings) with a player on first and second, no outs.

A1.4.2.2.2 The line-up will continue as in any other inning. For example, if the 7th inning ends with the #8 hitter having made the last plate appearance (PA), the 8th inning begins with the #9 at bat and the 2B runner is the #7, and 1B runner is the #8 in the line-up, or any pinch runners for these players.

A1.4.2.2.3 With the exception of beginning the inning with runners on 1B and 2B with no one out, all other WBSC Official Rules of Baseball and WBSC Tournament Regulations will remain in effect during extra innings required to determine a winner.

The traditional system of the visiting team hitting in the top of the inning and the home team hitting in the bottom of the inning (if needed) will remain in effect until a winner is determined.

A1.4.2.3 PREMIER12

If the game remains tied after the completion of nine (9) innings, the following procedures will be implemented during extra innings:

A1.4.2.3.1 Each team will begin the 10th inning (and any subsequent necessary extra innings) with a player on first and second, no outs.

A1.4.2.3.2 The line-up will continue as in any other inning. For example, if the 9th inning ends with the #8 hitter having made the last plate appearance

(PA), the 10th inning begins with the #9 at bat and the 2B runner is the #7, and 1B runner is the #8 in the line-up, or any pinch runners for these players.

A1.4.2.3.3 With the exception of beginning the inning with runners on 1B and 2B with no one out, all other WBSC Official Rules of Baseball and WBSC Tournament Regulations will remain in effect during extra innings required to determine a winner.

A1.5 EXCEPTIONS TO THE WBSC OFFICIAL RULES OF BASEBALL

A1.5.1 In the event of inclement weather or other unforeseen conditions, the Technical Commissioners assigned to the game will have the responsibility of determining the start of a game. (Note: See Rule 5.1)

A1.5.2 When a batter hits a home run, members of his team shall not be allowed to touch the hitter until he has passed home plate. Failure to observe this rule will result in a warning to the team manager and if it occurs again the Team will be fined and the team manager shall be ejected from the game.

A1.5.3 This exception only applies to U-12.

A1.5.3.1 STEALING

Stealing, lead off and pickoffs are allowed, however no headfirst slides to home plate are permitted.

Note: The runner sliding headfirst into home plate is called out. The ball stays in play until all play has stopped.

A1.6 SUSPENDED GAMES

A1.6.1 In case a game is stopped because of weather, curfew or other reason, the following will apply:

A1.6.1.1 Before a contest becomes a regulation game, it is not an official game and shall be resumed at the exact point of suspension.

A1.6.1.2 After it becomes a regulation game, it is ruled a complete game.

A1.6.1.3 When it is tied or when the visiting team takes the lead in an uncompleted inning, and after it has become a regulation game, it shall be ruled a suspended game and shall be resumed at the exact point of suspension and played to a completion. The scheduling of completion of suspended game shall be given priority by the Technical Commission in order to complete it as soon as possible.

A1.6.1.4 All suspended, tied or games not played shall be re-scheduled by the Technical Commission and the WBSC Events Department in order to resume or start them following the suspension order if applicable. The new schedule has to be officially approved in writing by the WBSC Executive Director before being released to all participants.

A1.6.1.5 If there are difficulties concerning the closing date, only the games necessary to establish the final positions of the first three teams will be re-scheduled. No team shall be asked to play more than two games on the same day unless the case warranted by exceptional circumstances and agreed upon by both teams affected by this measure. Would the exceptional circumstances persist and would any of the involved teams refuse to play two games on the same day, the WBSC Executive Director has the authority officially to determine whether they must play or not and the team or teams will be under the obligation to do it if the decision of the WBSC Executive Director establishes it as to be so. If the team or teams do not agree to play, they will lose the game by forfeit to appear.

A1.6.1.6 As per the WBSC Official Rules of Baseball, for nine (9) inning games, a game is considered a regulation game if five innings have been completed (4 1/2 innings if the home team is winning) and the Umpire calls the game. For six (6) or seven (7) inning games, a game is considered a regulation game if four innings have been completed (3 1/2 if the home team is winning) and the Umpire calls the game. In all WBSC sanctioned events,

the Umpires must wait a minimum of sixty (60) minutes and no more than ninety (90) minutes, before making a decision about whether to call the game and make it become a regulation game.

A1.6.1.7 If a play is in progress at the moment of a failure of the field's lighting system and an additional action is impossible, the game is considered suspended. Whenever the lights are restored, the game shall continue in the same situation that existed at the beginning of the play which was interrupted due to lack of lighting.

A1.7 BAT REGULATIONS

Note: The list is available at WBSC website.

A non approved bat must be removed. Any bat that has been altered shall be removed from play.

A1.7.1 U-12 BASEBALL WORLD CUP

The bat shall be made of wood or of other materials as it complies with WBSC specifications as written in this rule:

- It shall be smooth, rounded stick with a constant radius at any point.
- There must be a direct line from the centre of the knob to the centre of the large end.
- The knob and the end plug, if any, must be firmly attached.
- The bat shall not be more than 33 inches (0.83 m) of length.
- The diameter of a bat shall not be more than 2 5/8 inches (0.06 m) nor less than 2 1/4 inches (0.05 m).
- One piece wood bats can be used as long as they are included in the current year's Official List of Approved Bats by the WBSC.
- Non-wood or multi-piece wood bats shall have a Bat Performance Factor (BPF) of 1 or less. If the BPF is not visibly indicated on the bat, manufacturer's proof and/or alternate equivalent certification may be presented to the Technical Commission for approval.

A1.7.2 U-15 BASEBALL WORLD CUP

Bats that are allowed for use at U-15 Baseball World Cups must be "Batted Ball Coefficient or Restitution" (BBCOR) certified:

- A bat is BBCOR certified and so clearly indicated on the bat.

- The entire bat must be round with a constant radius at any point and the finish of the hitting area must be smooth.
- There must be a direct line from the centre of the knob to the centre of the large end. The knob and end plug (if applicable) must be firmly attached.
- The maximum length is 34 inches (0.86 m) and the maximum diameter is 2 5/8 inches (0.06 m).
- A bat may not weigh, numerically, more than three units less than the length of the bat (e.g. a 34-inch (0.86 m) long bat cannot be less than 31 ounces (0.87 kg) in weight.
- One piece wood bats can be used as long as they are included in the current year's Official List of Approved Bats by the WBSC.

A1.7.3 U-18 AND U-23 BASEBALL WORLD CUP

The players can only use one-piece wooden bats that are included in the Official WBSC Approved-Wood Bat List published in the current year. Refer to Annex IV of the WBSC Baseball World Cups Tournament Regulations or the WBSC website.

Use of composite bats is prohibited (composite bats refer to wood bats wrapped with fiberglass or other components or a combination of pieces rather than one solid piece of wood – the use of these bats is not permitted).

A1.7.4 WOMEN'S BASEBALL WORLD CUP

The use of non-wooden bats is authorised, as long as they comply with the following requirements:

- The entire bat must be round with a constant radius at any point and the finish of the hitting area must be smooth,
- There must be a direct line from the centre of the knob to the centre of the largest end. The knob and end plug (if applicable) must be firmly attached.
- The maximum length is 36 inches (0.91 m), and the maximum diameter is 2 3/4 inches (0.07 m).
- A bat may not weigh, numerically, more than five units less than the length of the bat (e.g. a 35-inch (0.89 m) long bat cannot be less than 30 ounces (0.85 kg) in weight.
- It is mandatory that all bats have an identification mark 18 inches (0.45 m) from the end of the handle.
- Use of wooden bats is also authorised, as long as they are included in the current year official approved list published by WBSC.

A1.8 PITCH COUNT LIMITS AT WBCS WORLD CUPS

WBCS cares about the well-being and proper development of youth athletes. The intent of this rule is to protect young athlete’s arms during the growth period, therefore setting a pitch limit for certain youth Baseball World Cups. It is the responsibility of the team coaches to track their pitchers’ pitch counts at all times, and to ensure that no athletes go beyond the maximum number of pitches in their respective age categories.

If a pitcher reaches the maximum number of pitches during an active at bat, the pitcher may finish the same batter but must be removed at the end of the at bat.

If the Team Manager fails to substitute the pitcher prior to surpassing the maximum number of pitches allowed, for the safety of the athlete the Technical Commissioner will ask the Home Plate Umpire to stop the game and the pitcher shall be substituted. The Team Manager and/or the National Federation will then be subject to the corresponding infraction penalties (see specific penalties below).

A.1.8.1 U-12 BASEBALL WORLD CUP

Each pitcher must observe a day(s) rest as follows:

NUMBER OF PITCHES	1 – 30	31 – 45	46 – 60	61 – 75	Max. 85
REST DAYS	No rest	1 day	2 days	3 days	4 days

The Technical Commissioner will ultimately determine the accurate pitch count by using all the information gathered from the Official Scorers plus his own work and render any final decisions on protests.

Note:

- Pitch count is to be accurately recorded by Official Scorers, and pitchers who are not available to pitch will be listed in a daily report;
- Pitch count thrown by the same pitchers in games on the same day will be added to determine availability of pitchers;
- A pitcher can only pitch on three (3) consecutive days if pitch count on the two previous days does not exceed thirty (30) pitches. It should be noted when a pitcher pitches on consecutive days, their pitch count from the previous day(s) will be used to determine the number of pitches allowed for the day. For example, if a pitcher throws 29 pitches over two days, they are

allowed to throw the third day because the pitch count total was under 30, but they can only throw a maximum of 56 pitches on the third day (maximum of 85 minus the 29). Whatever the amount of pitches thrown on the three consecutive days will determine the days rest needed. In the above example, the pitcher would require the full 4 days of rest;

- If pitcher’s day 1 + day 2 exceeds thirty (30), they require at least one (1) day rest. Pitcher cannot pitch four (4) consecutive days. One (1) day rest is needed; and
- When a pitcher reaches any of the thresholds, he may not play as a pitcher according to the corresponding rest day(s), however the pitcher is allowed to play as a position player during such rest.

Penalty:

- Ejection of the Team Manager;
- Team Manager suspended for at least the next scheduled game (including possible re-scheduled games) of the team in the same competition; and
- National Federation fined with A-Level infraction, pitch count limit violation, minimum of \$2,000 USD.

Example of Pitch Count Rule:

PITCHER	DAY 1	DAY 2	DAY 3	DAY 4	DAY 5	DAY 6	DAY 7
PITCHER 1	25	11	X				
PITCHER 2	45	X					
PITCHER 3	60	X	X				
PITCHER 4	75	X	X	X			
PITCHER 5	85	X	X	X	X		
PITCHER 6	15	5	5	X			
PITCHER 7	15	5	15	X			
PITCHER 8	15	5	26	X	X		
PITCHER 9	15	5	41	X	X	X	
PITCHER 10	15	5	65 (max)	X	X	X	X

- Pitcher availability
- 55 Sample number of pitches
- X Mandatory rest day pursuant to WBCS U-12 BWC Regulations

A1.8.2 U-15 BASEBALL WORLD CUP

Each pitcher must observe a day(s) rest as follows:

NUMBER OF PITCHES	1 - 35	36 - 50	51 - 65	66 - 80	Max. 95
REST DAYS	No rest	1 day	2 days	3 days	4 days

(no more than 95 pitches will be allowed)

The Technical Commissioner will ultimately determine the accurate pitch count by using all the information gathered from the Official Scorers plus his own work and render any final decisions on protests.

Note:

- a. Pitch count is to be accurately recorded by Official Scorers, and pitchers who are not available to pitch will be listed in a daily report;
- b. Pitch count thrown by the same pitchers in games on the same day will be added to determine availability of pitchers;
- c. A pitcher can only pitch on three (3) consecutive days if pitch count on the two previous days does not exceed thirty-five (35) pitches. It should be noted when a pitcher pitches on consecutive days, their pitch count from the previous day(s) will be used to determine the number of pitches allowed for the day. For example, if a pitcher throws 34 pitches over two days, they are allowed to throw the third day because the pitch count total was under 35, but they can only throw a maximum of 61 pitches on the third day (maximum of 95 minus the 34). Whatever the amount of pitches thrown on the three consecutive days will determine the days rest needed. In the above example, the pitcher would require the full 4 days of rest;
- d. If pitch count is thirty-six (36) or above on those two days, the said pitcher will require one (1) day of rest;
- e. Pitcher cannot pitch four (4) consecutive days. At least one (1) day-rest is needed;
- f. When a pitcher reaches any of the thresholds, he may not play as a pitcher according to the corresponding rest day(s), however the pitcher is allowed to play as a position player during such rest.

Penalty:

- Ejection of the Team Manager;
- Team Manager suspended for at least the next scheduled game (including possible re-scheduled games) of the team in the same competition; and

- National Federation fined with A-Level infraction, pitch count limit violation, minimum of \$2,000 USD.

Example of Pitch Count Rule:

PITCHER	DAY 1	DAY 2	DAY 3	DAY 4	DAY 5	DAY 6	DAY 7
PITCHER 1	25	11	X				
PITCHER 2	50	X					
PITCHER 3	65	X	X				
PITCHER 4	80	X	X	X			
PITCHER 5	95	X	X	X	X		
PITCHER 6	15	15	4	X			
PITCHER 7	15	15	15	X			
PITCHER 8	15	15	21	X	X		
PITCHER 9	15	15	36	X	X	X	
PITCHER 10	15	15	65 (max)	X	X	X	X

- Pitcher availability
- 55 Sample number of pitches
- X Mandatory rest day pursuant to WBCS U-15 BWC Regulations

A1.8.3 U-18 BASEBALL WORLD CUP

Each pitcher must observe a day(s) rest as follows:

NUMBER OF PITCHES	1 - 40	41 - 55	56 - 75	76 - 90	91 - 105
REST DAYS	No rest	1 day	2 days	3 days	4 days

The Technical Commissioner will ultimately determine the accurate pitch count by using all the information gathered from the Official Scorers plus his own work and render any final decisions on protests.

Note:

- a. Pitch count is to be accurately recorded by Official Scorers, and pitchers who are not available to pitch will be listed in a daily report;
- b. Pitch count thrown by the same pitchers in games on the same day will be added to determine availability of pitchers;
- c. A pitcher can only pitch on three (3) consecutive days if pitch count on the two previous days does not exceed forty

(40) pitches. It should be noted when a pitcher pitches on consecutive days, their pitch count from the previous day(s) will be used to determine the number of pitches allowed for the day. For example, if a pitcher throws 39 pitches over two days, they are allowed to throw the third day because the pitch count total was under 40, but they can only throw a maximum of 66 pitches on the third day (maximum of 105 minus the 39). Whatever the amount of pitches thrown on the three consecutive days will determine the days rest needed. In the above example, the pitcher would require the full 4 days of rest;

- d. If pitch count is forty-one (41) or above on those two days, the said pitcher will require one (1) day of rest;
- e. Pitcher cannot pitch four (4) consecutive days. At least one (1) day-rest is needed;
- f. When a pitcher reaches any of the thresholds, he may not play as a pitcher according to the corresponding rest day(s), however the pitcher is allowed to play as a position player during such rest.

Penalty:

- Ejection of the Team Manager;
- Team Manager suspended for at least the next scheduled game (including possible re-scheduled games) of the team in the same competition; and
- National Federation fined with A-Level infraction, pitch count limit violation, minimum of \$2,000 USD.

Example of Pitch count Rule:

PITCHER	DAY 1	DAY 2	DAY 3	DAY 4	DAY 5	DAY 6	DAY 7
PITCHER 1	25	16	X				
PITCHER 2	50	X					
PITCHER 3	65	X	X				
PITCHER 4	80	X	X	X			
PITCHER 5	95	X	X	X	X		
PITCHER 6	15	20	4	X			
PITCHER 7	15	20	20	X			
PITCHER 8	15	20	21	X	X		
PITCHER 9	15	20	41	X	X	X	
PITCHER 10	15	20	70 (max)	X	X	X	X

	Pitcher availability
55	Sample number of pitches
X	Mandatory rest day pursuant to WBSC U-18 BWC Regulations

A1.8.4 U-23 AND WOMEN'S BASEBALL WORLD CUP

There is no pitch count limitations for U-23 and Women's Baseball World Cups.

A2. SCORING RULES

A2.1 FORFEITED GAMES

In this case the Official Scorer will consider the final score as the flowing table, regardless of the existing result at the time the game was forfeited.

U-12 BASEBALL WORLD CUP	6 innings	6-0
U-15, U-18, U-23 & WOMEN'S BASEBALL WORLD CUP	7 innings	7-0
PREMIER12	9 innings	9-0

A2.2 WINNING PITCHER

A starting pitcher to claim victory in the game must pitch at least:

PREMIER12	5 innings	4 innings in a regulation game of 5 innings
U-15, U-18, U-23 & WOMEN'S BASEBALL WORLD CUP	4 innings	3 innings in a regulation game of 4 or 5 innings
U-12 BASEBALL WORLD CUP	4 innings	3 innings in a regulation game of 4 or 5 innings

A2.3 PITCHERS EARNED RUN AVERAGE COEFFICIENT

PREMIER12	9
U-23, U-18, U-15 & WOMEN'S BASEBALL WORLD CUP	7
U-12 BASEBALL WORLD CUP	6

A2.4 MINIMUM PLATE APPEARANCE COEFFICIENT

PREMIER12	2.7
U-23, U-18, U-15 & WOMEN'S BASEBALL WORLD CUP	2.1
U-12 BASEBALL WORLD CUP	1.6

A2.5 MINIMUM INNING PITCHED COEFFICIENT

PREMIER12	0.8
U-23 & WOMEN'S BASEBALL WORLD CUP	1.7
U-18, U-15, U-12 BASEBALL WORLD CUP	1.5

A3. OTHER MATTERS**A3.1 ELECTRONIC DEVICES**

The use of electronic devices is forbidden during the games. None of the electronic devices such as cellular phones, laptops, tablets, video cameras, walkie-talkies, shall be used to communicate to on-field personnel, those in the dugout, bullpen, clubhouse and stands. The only exception to this rule is the use of phone/cellular phone to communicate between dugout and bullpen, however such device must be approved by WBSC in advance. No microphones or cameras are permitted in the dugout, bullpens or on the field of play without approval of WBSC. The participating teams must obtain approval of WBSC before using any other or new electronic equipment during a game.

A3.2 SMOKING OR SMOKELESS TOBACCO

Any members of team delegation are not permitted to smoke in places that are visible to the public including audiences on media outlets such as TV, Internet streaming. It is the responsibility of team delegation leader to ensure such smoking is not seen by public as long as they are in game venues and practice facilities as well as other tournament official activities. In addition, team delegations should only smoke in a smoking area if one is designated by LOC. Any violation of this rule will be taken seriously, and violators would be subject to disciplinary action as WBSC may deem appropriate. The use of smokeless tobacco is also prohibited for team delegation members during televised interviews or appearances. While spectators are permitted into the stadium, the delegation leader must ensure that such tobacco products (including tobacco tins or packages) are not visible to audience.

**APPENDIX
02.****UMPIRE VIDEO REVIEW
PROTOCOL & REGULATION**

The implementation of WBSC's play call video review system intends to support our Umpiring crews with the latest technology tools to ensure the highest degree of fairness possible in competition. In this document the general guidelines, the list of reviewable calls and the protocol to challenge a call are listed.

B1. GENERAL GUIDELINES

- B1.1** Each team manager will have one (1) challenge per seven (7) innings of play.
- B1.2** Managers may only challenge calls included in the list of “Reviewable Calls for Managers Challenge”.
- B1.3** If the challenged call is overturned, the manager will maintain the challenge. If the call is upheld, the manager will lose the challenge.
- B1.4** If the game goes into extra innings, each Team will have one (1) challenge.
- B1.5** Beginning in the top of the 6th inning, the Crew Chief can choose to review any reviewable calls if manager is out of challenges.
- Exception:** Potential Home Run calls are reviewable at all times as detailed in section “Reviewable Calls by Crew Chief Initiative”.
- B1.6** Except in the case of potential home run calls, the crew chief shall not initiate video review of any play or call if the requesting manager has a challenge remaining.

B2. REVIEWABLE CALLS FOR MANAGERS CHALLENGE

- B2.1 BASE RUNNING**
- Runner passing the runner in front of him/her.
 - Time plays.
 - Runner missing a base while advancing. Defence must appeal prior to review.
 - Runner(s) leaving early during a tag-up play.
 - Runner(s) failing to retouch a base when required.
- B2.2 CATCH/NO CATCH PLAY**
- Any play attempted by one of the outfielders.
 - Any play attempted by an infielder if he/she is forced to go back into outfield to make the play.

- Any fly ball in foul territory is reviewable.
- Play in the infield is NOT reviewable.

Note: Infield limit at Umpire’s discretion.

B2.3 FAIR/FOUL

- Ball must land at or beyond the set position of the 1st/3rd base Umpire.
- Foul ball landing in front of Umpire IS NOT reviewable. Exception: Ball swung at or bunted, called fair landing in front of Umpire is reviewable to see if the ball hit the batter. The call could be overturned to a foul ball. Runners would not be in jeopardy.

B2.4 FORCE PLAYS

- Any force play at any base is reviewable.

B2.5 HIT BY PITCH

- Any hit by pitch is reviewable.
- If the hit by pitch occurs on a check swing, the check swing must be appealed prior to asking for review.

B2.6 POTENTIAL HOME RUN

- Any potential or Home Run call may be challenged.

Note: Manager may ask Crew Chief for review without counting as a challenge. Umpire crew should check on potential Home Run if any doubt. If Crew Chief does not concede review, manager may challenge.

B2.7 COLLISION RULE

- Any collision at any base is reviewable.
- Safe/out call will be reviewed while judging potential violation.

Note: If multiple plays, manager must state at once which ones are being challenged.

B2.8 NON-HOME RUN BOUNDARY

- Any ball/felder entering dead ball territory.
- Spectator interference with a play (all types).
- Specific tournament ground rules (i.e. ball striking catwalk at a dome).

Note: If a ball hits the catwalk and falls in the infield, not reviewable. Only reviewable if it falls in the outfield.

- Balls lodged during a play (i.e. ball stuck in temporary fence).

Note: balls stuck reviewable even if a player goes after it and tries to retrieve it.

- Placement of runners after a non-Home Run boundary call. The call prompting the challenge will also be reviewed.

B2.9 SLIDE RULE

- When a runner hindered/impeded the fielder and engaged in a bona fide slide on a double play attempt:
 - If both calls favour the offence (safe/safe), the defence may challenge.
 - If both calls favour the defence (out/out), the offence may challenge.
 - If one call favours the offence and one call favours the defence (out/safe, safe/out), both Teams may challenge. Exception: if out call is 3rd out.

Note: Infielder must make attempt to throw to be reviewable.

On-field crew will determine a double play attempt on a non-throw.

If challenging both calls, manager must state it at once or pick which one he is challenging.

The original calls on the field will dictate whether a play requires one or two trips to review. A Team adversely affected by a review can still challenge provided the change of the initial call made a previous call relevant and the manager had no incentive to seek review originally. This request for a manager's challenge or Crew Chief Review must be made immediately after the announcement of the Video Review Official's decision.

B2.10 TAG PLAYS

- A runner potentially being pushed off is NOT reviewable.

B3. REVIEWABLE CALLS BY CREW CHIEF INITIATIVE

- Any reviewable calls upon start of the 6th inning.
- Potential Home Runs.
- Record Keeping situations such:
 - Counts.
 - Outs.
 - Score.
- Proper/Improper line-up.
- Substitutions.
- Rules review if potential protest by manager.
- To ask/clarify if a call is reviewable.
- Ground rules review.

B3.1 CHALLENGE PROTOCOL

- B3.1.1** Upon an Umpire's call and the completion of a play, a manager wishing to challenge a call has ten (10) seconds to signal the Home Plate Umpire to hold with his hand.
- B3.1.2** The manager will then have twenty (20) seconds to decide whether to initiate the challenge or drop the hold.
- B3.1.3** If challenging a call, the manager must head to home plate and indicate to the Home Plate Umpire the call that is being challenged.
- B3.1.4** If reviewable, the Home Plate Umpire will signal that the call will be reviewed. The Crew Chief and the call Umpire will then head to the video review area to communicate via headphones with the review booth.
- B3.1.5** When a review is initiated by the Crew Chief, both managers will be informed of the call that is being reviewed.
- B3.1.6** The Official assigned to the video review booth will evaluate the call and make the final call, which will be relayed to the Crew Chief.
- B3.1.7** Upon completion of the review, the Crew Chief will signal whether the call stands or is overturned.

B3.1.8 The call by the video review Official will be final and may not be argued by neither member of a Team. Any Team member (player, coach, or team personnel) arguing a call that has been reviewed will be automatically ejected from the game.

B3.1.9 Team on defence must stay on the field after the third out of an inning if a HOLD is requested by the opposing manager. If the challenge is requested, the Team will remain on the field until the call has been reviewed.

B3.1.10 For Teams on defence, the manager must challenge a call before signalling a possible pitching change and/or a no pitch intentional walk.

B3.1.11 For Teams on offence, the manager must challenge before the pitcher steps onto the warning track or crosses the foul line.

Exception: Crew Chief may allow if defensive manager signalled pitching change/intentional walk in an accelerated manner to prevent offensive challenge).

B3.2 GENERAL GUIDELINES

B3.2.1 Only the team manager is authorised and permitted to request or initiate Video Review. If the manager cannot perform his/her responsibilities due to injury, illness, ejection, removal, or other legitimate reasons, in which case the coach designated to assume the manager's responsibilities shall have the sole right to request or initiate Video Review.

B3.2.2 Crew Chief Review – At any time during a game, a Crew Chief may, in his sole discretion, initiate a Video Review of a potential Home Run call. With respect to other reviewable calls, beginning in the 6th inning, a Crew Chief may, in his/her sole discretion, conduct Video Review upon his/her own initiative or upon the request of a manager who has no remaining manager challenges.

B3.2.3 Duration of Video Review. The Video Review Official shall make a decision on a call under Video Review within two minutes after the Crew Chief and Video Review Official confirm which call is subject to Video review. In the event the call is overturned, the Video Review Official's placements of runners (or such other

actions necessary to place both Teams in the same position that they would have been had the changed call been correct in the first instance) may occur after the expiration of the two-minute clock.

B3.2.4 If the Crew Chief determines that a team's request for a manager's challenge is untimely, the play shall not be reviewed, the Umpire's call shall stand. The team will NOT be charged with a challenge. The decision of the crew chief will be final to determine whether a manager's challenge is timely.

B3.2.5 If a manager challenges a call that is not eligible for review, the Crew Chief will inform him that the call is not reviewable, and the team will not be charged a challenge. If the Crew Chief is unsure of whether a call challenged by the manager is eligible for review, he may consult with the Video Official prior to making the determination. If either the team or Crew Chief invokes Video Review of a call that the Video Official determines is not subject to review, he will inform the Crew Chief that the play is not reviewable, and the team will not be charged with a challenge. To the extent that the WBSC Official Rules of Baseball require the defensive team to appeal a play eligible for Video Review (e.g., a runner missing a base), Video Review may not be initiated until the Umpires rule on the appeal.

B3.3 CHALLENGE OF A REVIEWABLE PLAY BY BOTH MANAGERS

B3.3.1 Both managers may challenge different reviewable calls within the same reviewable play. These challenges may be in the form of a manager's challenge or a request for a Crew Chief review, to the extent available.

B3.3.2 The Video Review Official shall review all challenges properly initiated and shall review the challenged calls in the order in which the calls occurred during the game. If the decision of the Video Review Official on an earlier reviewable call renders moot a later reviewable call, the Video Review Official shall not review the subsequent call. If a call challenged by a Team is not reviewed by the Video Review Official by operation of the foregoing rule, that manager's challenge shall be deemed rescinded, and the Team shall not be charged with the challenge.

B3.3.3 If manager challenges by both Teams are not invoked simultaneously, the second Team must invoke its challenge before the Crew Chief makes communication contact with the Video Review Official; provided, however, that any Team adversely affected by a Video Review Official's decision to change a call has the right to use a manager's challenge or request that a Crew Chief review another reviewable call in the same play, provided that:

B3.3.3.1 The manager of the adversely affected Team makes the manager's challenge or requests the Crew Chief review immediately after the announcement of the Video Review Official's decision.

B3.3.3.2 The change of the initial call affects the relevance of the subsequent call to the outcome of the play.

B3.3.3.3 The Team adversely affected by the change in the initial call had no incentive to seek Video Review of the subsequent call until after the Video Review Official reversed the initial call. For purposes of this Regulation, the advancement of a runner (other than the batter-runner) pursuant to a non-call of WBSC Official Rules of Baseball Rule 10.6 (Sliding to Bases on Double Play Attempts) shall not be considered an incentive for the defensive Team to seek Video Review.

Example: With two outs and no one on base, the Umpires call a line drive hit to the outfield a trap but call the batter-runner out when trying to advance to second base. The defensive Team had no incentive to challenge the trap call because the batter-runner was called out at second base to end the inning. However, if the offensive Team challenges the tag call at second base, and the Video Review Official overturns the call, the defensive Team will be afforded the opportunity to challenge or request review of the trap call in the outfield by informing the Crew Chief of the challenge or request immediately after learning of the Video Review Official's decision.

With one out and a runner on second, the batter hits a long fly ball to centre field that is caught. The runner on second, who had rounded third base at the time of the catch, fails to retouch third base on his way back to second base. He is tagged out at second base. The defensive Team had no incentive to appeal or otherwise challenge the runner's failure to retouch third base because the

runner was called out at second base to end the inning. However, if the offensive Team challenges the tag call at second base, and the Video Review Official overturns the call, the defensive Team will be afforded the opportunity to challenge the runner's failure to retouch third base. Because that play is an appeal play within the meaning of the Official Rules of Baseball, the defensive Team must first appeal the play. If the Umpire calls the runner safe at third on such appeal, the defensive Team then will be afforded the opportunity to challenge the appeal play by informing the Crew Chief of the challenge immediately after the safe call.

With no outs and runners on first and second, the Umpire calls a double play and the runner on second advances to third. The offensive Team challenges the double play. If the Video Review Official overturns the double play and one or both of the runners is ruled safe, the defensive Team will be afforded an opportunity to challenge the Umpire's non-call of WBSC Official Rules of Baseball Rule 10.6.

B3.3.4 If any of the conditions set forth in Section 3 above is met and an additional call within a single play is subject to its own subsequent Video Review and the decision by the Video Review Official renders irrelevant a manager's challenge previously used by the opposing manager on that play, then the opposing manager's previous challenge shall be deemed rescinded, and the Team shall not be charged with such challenge.

Example: With two outs and a runner on first, the batter hits a fly ball to the outfield that is ruled "no catch," and the runner is called "out" trying to reach third base, which results in the third out of the inning. The offensive manager challenges the call at third base, and the Video Review Official determines that the runner was safe. The defensive manager then challenges the "no catch" call on the batted ball to the outfield, and the Video Review Official overturns the call to a "catch," which results in the third out of the inning. The offensive manager's challenge of the call on the runner at third base is irrelevant because the batter is out by virtue of the fly ball being caught in the outfield, and therefore such previous challenge on the play would be deemed rescinded.

B3.4 EFFECT OF VIDEO REVIEW RESULT ON POST-PLAY DECISION BY MANAGER

If a call is overturned on Video Review, any decisions made by a manager after the play and influenced by the incorrect call shall be nullified. Such manager shall be permitted to reaffirm or change his strategic decision based on the result of the play as determined by the Video Review Official.

Example: The defensive manager signals for a pitching change after a play and, subsequently, the offensive manager timely initiates a challenge or the Crew Chief initiates Video Review. The Video Review results in an overturned call. Any pitching change, or attempted pitching change, made by the defensive manager shall be nullified unless reaffirmed by him after the Video Review Official's decision is announced.

With no outs and a runner on third base, the batter's bat hits the catcher's glove as he swings at a pitch and catcher's interference is called. On the swing, a fly ball is hit to left field and caught. The runner on third base tags up and scores on a close play at the plate. Pursuant to WBSC Official Rules of Baseball Rule 9.10, because of the catcher's interference, the offensive manager may elect either the interference penalty (i.e., batter awarded first base and runner returns to third base) or the result of the play (i.e., batter is out and runner scores). The offensive manager elects to accept the result of the play. The defensive manager then challenges the call at home plate, and the Video Review Official overturns the call and rules the runner out at home plate. Knowing the final result of the play as determined by the Video Review Official, the offensive manager's decision to accept the result of the play shall be nullified unless reaffirmed by him after the Video Review Official's decision is announced.

B3.5 SPECIFICITY OF THE CHALLENGE

When invoking a manager's challenge or otherwise requesting a Crew Chief review, it is the manager's responsibility to ensure that the Umpire knows the specific calls for which he/she is seeking Video Review, but the manager need not state the reason for his/her belief that the call was incorrect. (For example, in order to challenge an "out" call on a force play at first base, the manager need not state that the throw pulled the fielder off the bag, the runner reached first base before the ball was caught, etc.) Moreover, the Video Review Official shall have no authority

to review any calls other than those included in a manager's challenge or those accepted by the Crew Chief.

Example: A runner is called safe on a rundown because the Umpire rules that the fielder missed the tag. The defensive Team challenges the tag call with a manager's challenge. During Video Review. The Video Review Official confirms that the tag was missed but observes that the runner who was called safe was passed by a preceding runner in violation of WBSC Official Rules of Baseball Rule 10.7.9. The Video Review Official cannot correct the Umpires non-call regarding the passed runner because the manager only challenged the tag call.

With nobody on base, a batter-runner is called out on a close, but routine, force play at first base. It is sufficient for the manager to communicate that he is challenging the call without any further specificity.

B3.6 IRREVOCABLE AND FINAL

B3.6.1 Once a manager informs an Umpire that he wishes to exercise a manager's challenge, it may not be rescinded. A manager should not point to the headset unless he/she is sure that he/she wants to initiate a challenge.

B3.6.2 WBSC Official Rules of Baseball Rule 7.12 shall have no applicability to these Video Review Regulations. No protest shall ever be permitted on judgement decisions by the Video Review Official. Moreover, a violation of any rule or procedure set forth herein shall not constitute a basis for protesting a game.

B3.6.3 In circumstances in which Video review is not available (e.g., the call is not reviewable, no manager challenge or Crew Chief review is available or after the start of the sixth inning, the Crew Chief has communicated that he/she has declined to initiate Video Review), if a manager, coach, player or team personnel makes reference to having observed a video review that purportedly contradicts the call under dispute, such person is subject to immediate ejection from the game.

B3.7 STANDARD FOR CHANGING A CALL

To change a reviewable call, the Video Review Official must determine that there is clear and convincing evidence to change

the original call that was made on the field of play. In other words, the original decision of the Umpire shall stand unchanged unless the evidence obtained by the Video Review Official leads him/her to definitively conclude that the call on the field was incorrect.

B3.8 CORRECTING AN INCORRECT CALL

Consistent with WBSC Official Rules of Baseball Rule 14.2.3, if Video Review results in a change to a call that had been made on the field, the Video Review Official, to the extent feasible, shall exercise his/her discretion to place both Teams in the same position they would have been in had the call on the field been correct. This shall include placing runners where he/she thinks those runners would have been at the conclusion of the reviewed play if the reviewed call had been correctly made in the first instance, disregarding interference or obstruction that may have occurred on the play, failures of runners to tag up based upon the initial call on the field, runners passing other runners, missing bases, etc.

B3.9 PLACEMENT OF RUNNERS

B3.9.1 VIDEO REVIEW OFFICIAL'S RESPONSIBILITY:

All decisions regarding the placement of base runners resulting from a call that is overturned pursuant to the Regulations shall be made by the Video Review Official in accordance with the standard set forth in the WBSC Official Rules of Baseball.

B3.9.2 BOOK AWARDS & DISCRETION:

Unless directed otherwise by the WBSC Official Rules of Baseball (for example, WBSC Official Rules of Baseball Rule 10.2.5 – 10.2.9, 10.4.3 and 10.4.7.7 the Video Review Official shall place the base runners on the bases he/she believes they would have reached had the reviewed call been made correctly. For example, WBSC Official Rules of Baseball Rule 12.4 Comment states, "Batter and runners shall be placed where in the Umpire's judgement they would have had the interference not occurred." Rule 12.7.3 states, "All runners shall advance, without liability to be put out, to the bases they would have reached, in the Umpire's judgement, if there had been no obstruction.") any doubt regarding the placement of runners should be resolved in favour of the last base legally touched at the time of the challenged call. More than one base should not be awarded unless it is obvious to the Video Review

Official that a runner would have safely advanced beyond one base had the call been made correctly, or the WBSC Official Rules of Baseball otherwise require such advancement.

B3.9.3 FACTORS TO CONSIDER:

The Video Review Official should consider several factors when placing the runners, including: (a) the depth of fly balls; (b) the speed of runners; (c) the location of runners on the field when the play occurred; (d) the number of outs at the time of the play; and (e) whether the incorrect call affected the subsequent behaviour or conduct of the offensive or defensive players.

B3.9.4 SUBSEQUENT CALLS AND OUTS:

If the Video Review Official determines that an incorrect call on the field had no effect on the subsequent behaviour or conduct of the offensive or defensive players, the Video Review Official shall change the incorrect call, but let stand any on-field calls or plays unaffected by the incorrect call. The Video Review Official may not declare a runner out based on a play the Umpire believes would have occurred subsequent to the play subject to the play subject to Video Review.

Example: A runner attempts to advance to second base on a force play. The runner fails to touch second base, and the second baseman fails to tag the runner or the base, but the Umpire calls the runner "out." The runner, believing he is out, makes no attempt to touch second base and leaves the field. The offensive manager challenges the call, and the Video Review Official determines that the second baseman did not tag the runner or the base. The Video Review Official shall reverse the call on the field, declare the runner "safe" and place him/her at second base.

B3.9.5 SCORING:

The Video Review Official shall determine whether base runners would have scored had the call been made correctly, and award or nullify runs scored by a Team where appropriate.

B3.9.6 FINAL AND BINDING:

The decision of the Video Review Official regarding the placement of runners, or runners being declared out, shall be final and binding on both Teams. On-field personnel shall be ejected if they argue or otherwise challenge the placement of runners.

B3.10 BASE RUNNING

When reviewing a play at home plate, if the Video Review Official determines both that the runner did not touch home plate and that the fielder did not tag the runner (or, in the case of a force play, did not touch home plate), the Video Review Official shall rule the runner “safe” at home plate unless the defensive manager appeals the failure of the runner to touch home plate prior to the Crew Chief making contact with the Video Review Official.

Example: A runner attempts to score on a play at the plate. The catcher misses the tag on the runner, and the runner fails to touch home plate, but the Umpire calls a tag and the runner “out.” The offensive manager challenges the call, and the Video Review Official determines that the catcher missed the tag. The Video Review Official shall disregard the failure of the runner to touch home plate, declare the runner “safe” and score the run. If, however, the catcher tags the runner after his initial attempt, after the initial call of the Umpire, and before the runner touches home plate, the Video Review Official shall declare the runner “out” and not score the run.

B3.11 HIT BY PITCH

Those plays for which there is a possibility that a pitched ball touches a batter, or his clothing. See, e.g., Rules 10.5 and 10.2.11. Any doubt as to whether a pitched ball hit the bat (as opposed to the batter or his clothing) should be resolved by the Home Plate Umpire at that moment as hitting the bat and not the batter, and the Umpire should declare a fair or foul ball under the circumstances. Notwithstanding the foregoing, whether the ball was in the strike zone when it touched the batter, and whether the batter made any attempt to avoid being touched by the ball, shall not be reviewable. See Rule 10.2.11.

Example: A pitch strikes the batter, but the Umpire erroneously rules that the pitch struck the bat instead and rules “foul ball.” The manager on offence appropriately invokes Video Review and the Video Review Official reverses the call. The Crew Chief shall declare the ball dead at the moment it struck the batter and rule accordingly.

A pitch strikes the bat, but the Umpire erroneously rules “hit batter-dead ball.” The manager on defence appropriately invokes Video Review and the Video Review Official reverses the call. If the ball lands foul, the Video Review Official shall call the ball “foul.” If the

ball lands fair, the Video Review Official may take into consideration whether the defensive Team attempts to retire the batter-runner, whether the batter-runner attempts to take a base, the batter-runner’s attempt to deceive the defensive Team and the Umpires on the field, and other relevant factors, in placing the batter-runner, calling him out, or calling the ball “foul” (if a “foul ball” ruling would result in a third strike, the pitch would be reviewed).

B3.12 COLLISIONS AT HOME PLATE

An Umpire’s decision to call or not call a violation of WBSC Official Rules of Baseball Rule 12.8 and WBSC Collision Rule.

Example: A runner collides with a catcher and touches home plate on a close play at home plate, but the home plate Umpire calls the runner out for having violated WBSC Official Rules of Baseball Rule 12.8 and Appendixes. The manager on offence invokes Video Review to challenge the application of Rule 12.8. If the Video Review Official overturns the call that Rule 12.8 was violated, then he also shall determine whether the runner was tagged out before touching home plate.

Note: Whenever Video Review of a call involving the application of WBSC Official Rules of Baseball Rule 12.8 is initiated, the Video Review Official also shall review any other reviewable call on the runner on at home plate on that play (e.g., whether the runner was tagged out at home plate even if Rule 12.8 was not violated).

B3.13 PLAYS NOT REVIEWABLE

The following plays WILL NOT be subject to review:

- The Umpire’s judgement on whether a base runner rounded first base in an attempt to advance to second base.
- The Umpire’s judgement on whether a base runner was pushed off a base.
- The Umpire’s judgement on whether a base runner abandoned his effort to advance in accordance with WBSC Official Rules of Baseball Rule 10.7.2.

APPENDIX 03.

GAME MANAGEMENT CLOCKS REGULATION

The implementation of game management clocks at all WBSC Baseball Tournaments supports the efforts to maintain a reasonable pace of game, helping to create a better experience for fans in the stadium and viewers around the globe.

All Game Management clocks at WBSC Events will be operated by an Official WBSC Umpire assigned by the Tournament Umpire Director.

Listed below are the general guidelines and regulations for each of the Game Management clocks.

C1. PITCH CLOCK

- The pitch clock will be set at twenty (20) seconds.
- Pitch clocks will be visible from the field of play and dugouts.
- The pitch clock will be in effect ONLY with NO runners on base for the entire game, including any extra innings.
- It will be activated when the pitcher receives the ball on the mound area.
- Once the 20 second clock has started, the batter has 10 seconds to enter the batter's box.
- The batter must keep one foot in the batter's box between pitches. Failure to keep one foot in the batter's box shall result in a strike being called on the batter.
- The batter may only step out of the batter's box with both feet in the following circumstances:
 - a) When the ball is hit.
 - b) On a swing, provided it is the momentum of the swing that takes them out of the batter's box.
 - c) If forced out of the batter's box to a valid pitch.
 - d) If the catcher is attempting to make a play (i.e. pop fly).
 - e) If time has been called, or the plate Umpire leaves his/her position to perform other duties not directly connected with the calling of plays.
 - f) If the pitcher leaves the mound.
 - g) On a three-ball count that the batter thinks the pitch was a ball.
 - h) On a check swing.
 - i) On a bunt attempt.
- When the Umpire indicates "PLAY BALL", after the batter leaves the batter's box as a result of one of the exceptions listed above, the Umpire shall do so once all play has ceased, and the batter is in or near the batter's box, the pitcher has possession of the ball on the mound, or the catcher is in a position to return the ball to the pitcher. The Umpire shall signal for the clock to begin. This includes a foul ball, a dead ball or "TIME" being called, even if the batter does not leave the batter's box.
- A pitcher stepping off the rubber will not stop the clock unless the Umpire grants the pitcher time.
- If either the pitcher or batter is granted time by the Umpire with five



or more seconds showing on the clock, the player in question will not get a reset of the full 20 seconds. The clock will be restarted when the Home Plate Umpire signals PLAY BALL.

Penalty: The first time a pitcher violates the 20 second clock, he shall be warned by the Umpire. Any subsequent violations by the same pitcher will be penalised with a ball awarded to the batter. There will be one warning per pitcher.

- If the batter is not in the batter's box ready to take the pitch with five seconds or less showing on the clock and time expires, both the batter and the team manager shall be warned by the Umpire. Any subsequent violations by any batter will be penalised with a strike awarded to the pitcher. There will be one Team warning per game.
- A delay of the game caused by the failure of the batter to keep one foot in the batter's box between pitches will result in the ball being declared dead and a strike awarded against the batter. The Home Plate Umpire shall call and signal "DEAD BALL", point to the batter's box and say, "BATTER'S BOX VIOLATION", awarding a strike on the batter and giving the new count.

C2. COACH / MANAGER PITCHER'S VISIT CLOCK

- The coach/manager's visit clock will be set at thirty (30) seconds.
- Clock will be visible from the field of play and dugouts.
- The coach/manager's visit clock will be in effect when time is requested by the coach/manager to visit the pitcher.
- It will be activated when the coach/manager steps across the foul line on his/her way to the mound.
- The coach/manager shall start walking back towards dugout before the clock reaches zero (0) seconds.

Penalty: The first time the coach/manager violates the visit clock, the team manager shall be warned by the Umpire. Any subsequent violations by the same Team will be penalised with a ball awarded to the current batter of the inning. The Umpire will then activate the pitch clock for the following pitch.

C3. PITCHING CHANGE CLOCK

- The pitching change clock will be set at ninety (90) seconds.
- Clock will be visible from the field of play and dugouts.
- The pitching change clock will be in effect ONLY when play is halted to make the substitution (i.e., following a pitching mound visit by coach/manager).
- It will be activated when the pitcher coming from the bullpen steps onto the warning track.
- The pitcher may not exceed eight (8) warm up pitches within the time.
- The catcher will be instructed no more throws with fifteen (15) seconds left on the clock.
- The batter must be entering the batter's box as time expires or when instructed by the Home Plate Umpire.

Penalty: The first time the defence violates the pitching change clock, the team manager shall be warned by the Umpire. Any subsequent violations by the same Team will be penalised with a ball awarded to the next batter of the inning. The Umpire will then activate the pitch clock for the following pitch.

- The first time the offence violates the pitching change clock, the team manager shall be warned by the Umpire. Any subsequent violations by the same Team will be penalised with a strike awarded to the pitcher. The Umpire will then activate the pitch clock for the following pitch.

Note: Time allowance for pitching changes may be modified slightly if a game is televised live. In such cases, the Umpire Director/Crew Chief will inform Teams accordingly.

C4. BETWEEN INNING CLOCK

- The between innings clock will be set at ninety (90) seconds.
 - Clock will be visible from the field of play and dugouts.
 - The clock will be in effect for the entire game, including any extra innings.
- Exception:** 5th inning field maintenance of five (5) minutes and/or adjustment up to one-hundred and twenty (120) seconds if Live TV requests so.
- It will be activated once the defensive pitcher has reached the foul line near their dugout.
 - The pitcher may complete a maximum of 8 warm up pitches within the time.
 - The catcher will be instructed a throw to second base with thirty (30) seconds left on the clock.
 - The batter must be entering the batter's box as time expires or when instructed by the Home Plate Umpire.

Penalty: The first time the defence violates the between innings clock, the team manager shall be warned by the Umpire. Any subsequent violations by the same Team will be penalised with a ball awarded to the first batter of the inning. The Umpire will then activate the pitch clock for the following pitch.

- The first time the offence violates the between innings clock, the team manager shall be warned by the Umpire. Any subsequent violations by the same Team will be penalised with a strike awarded to the pitcher. The Umpire will then activate the pitch clock for the following pitch.

Note: Time allowance for between inning breaks may be modified if a game is televised live. In such cases, the Umpire Director/Crew Chief will inform Teams accordingly.

C5. CLOCK INSTALLATION REQUIREMENTS

Each competition venue shall provide two (2) clocks in accordance to the following specifications:

INFIELD CLOCK	DESCRIPTION
REQUIREMENT	<ul style="list-style-type: none"> - A four-digit clock. - Located in clear view of the pitcher, not interfering with backstop publicity. - Remote controllable and synchronised with the outfield clock. - To be secured to the wall, preferably flush with the existing backstop. - Durable display to withstand being hit by a ball repeatedly and inclement weather. - To be padded on top and sides for player's safety, especially if it projects out of the backstop.
DIGIT SIZE	- Minimum height 24" (0.61 m)

OUTFIELD CLOCK	DESCRIPTION
REQUIREMENT	<ul style="list-style-type: none"> - A four-digit clock. - Located outside the FOP, not interfering the Batter's Eye. It can be added to an existing video board. - Remote controllable and synchronised with the infield clock. - Durable display to withstand being hit by a ball repeatedly and inclement weather.
DIGIT SIZE	- Minimum height 30" (0.76 m)

C5.1 PLACEMENT OF GAME MANAGEMENT CLOCKS

- The clocks shall be placed where they can be easily viewed by the players, managers, Umpires, and spectators.
- One OUTFIELD CLOCK shall be placed either to the left or right of the Batter's Eye (see location options in diagram below) to be visible by the batter and the plate Umpire.
- One INFIELD CLOCK shall be placed in the backstop area closer to the first base or third base dugouts (see location options in diagram below) to be visible to the pitcher and one or more of the base Umpires.
- Exact location of each clock may vary slightly based on venue's characteristics.

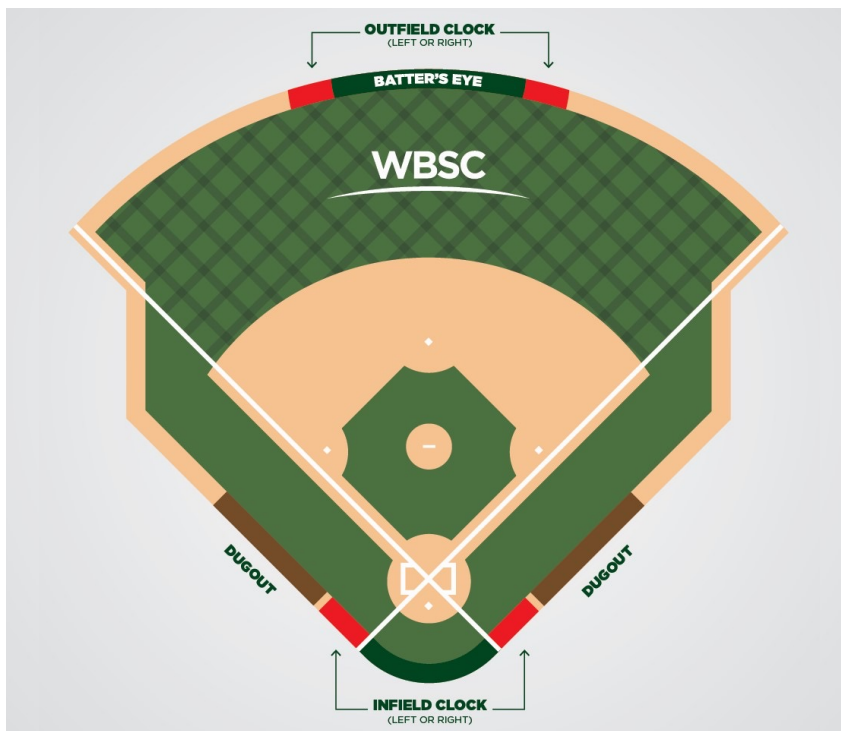

PLACEMENT OF GAME MANAGEMENT CLOCKS

APPENDIX 04. DIAGRAM

D1	PLAYING FIELD
D1.1	for U-15 and above
D1.2	for U-15 and above (Metric)
D1.3	for U-12
D1.4	for U-12 (Metric)
D2	HOMEPLATE & BASES
D2.1	for U-15 and above
D2.2	for U-15 and above (Metric)
D2.3	for U-12
D2.4	for U-12 (Metric)
D3	PITCHING MOUND
D3.1	for U-15 and above
D3.2	for U-15 and above (Metric)
D3.3	for U-12
D3.4	for U-12 (Metric)
D4	FIELDERS GLOVE
D5	STRIKE ZONE

D1. PLAYING FIELD

D1.1 FOR U-15 AND ABOVE

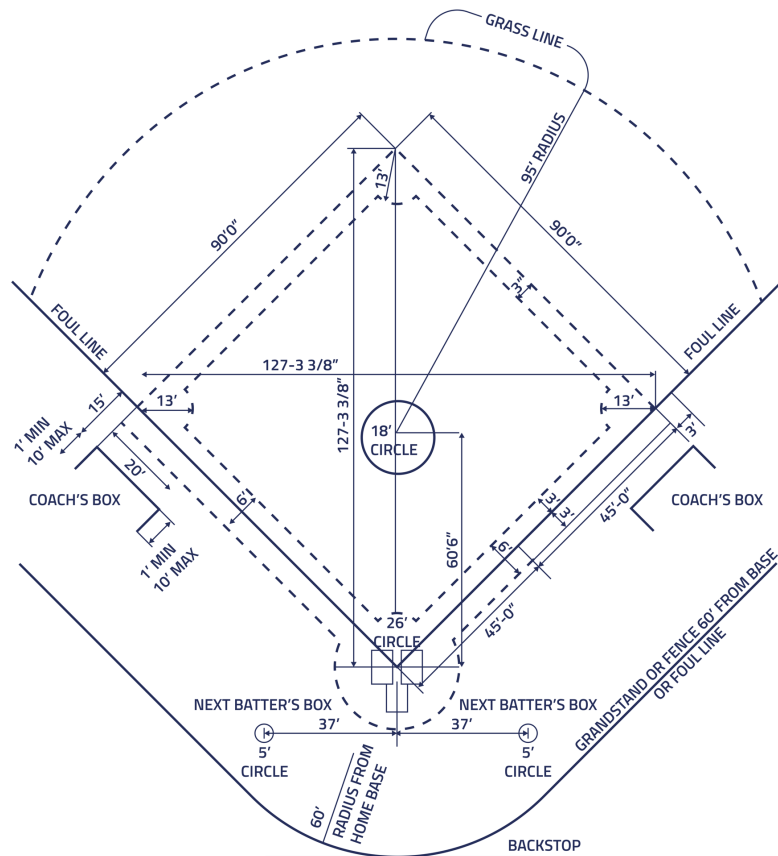

PLAYING FIELD

D1.2 FOR U-15 AND ABOVE (METRIC)

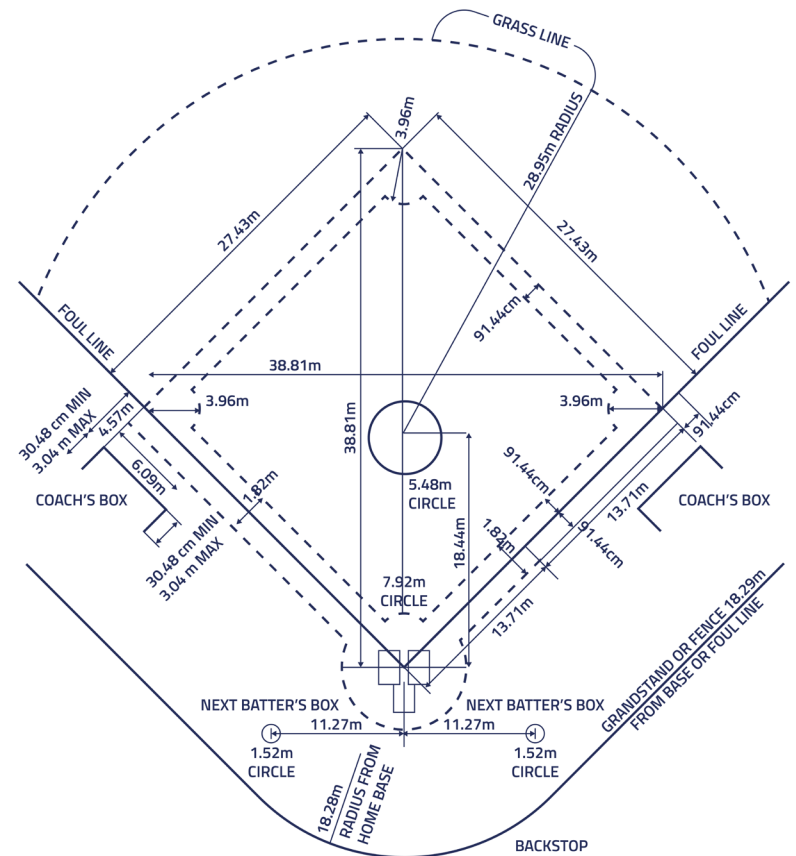



PLAYING FIELD

D1.3 FOR U-12 CATEGORY

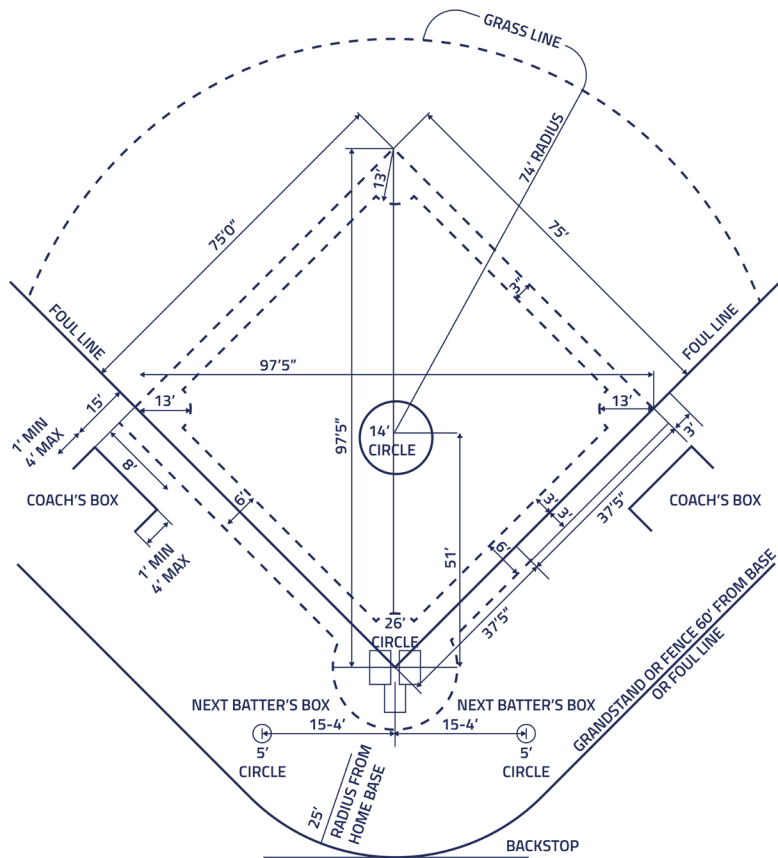

PLAYING FIELD

D1.4 FOR U-12 CATEGORY (METRIC)

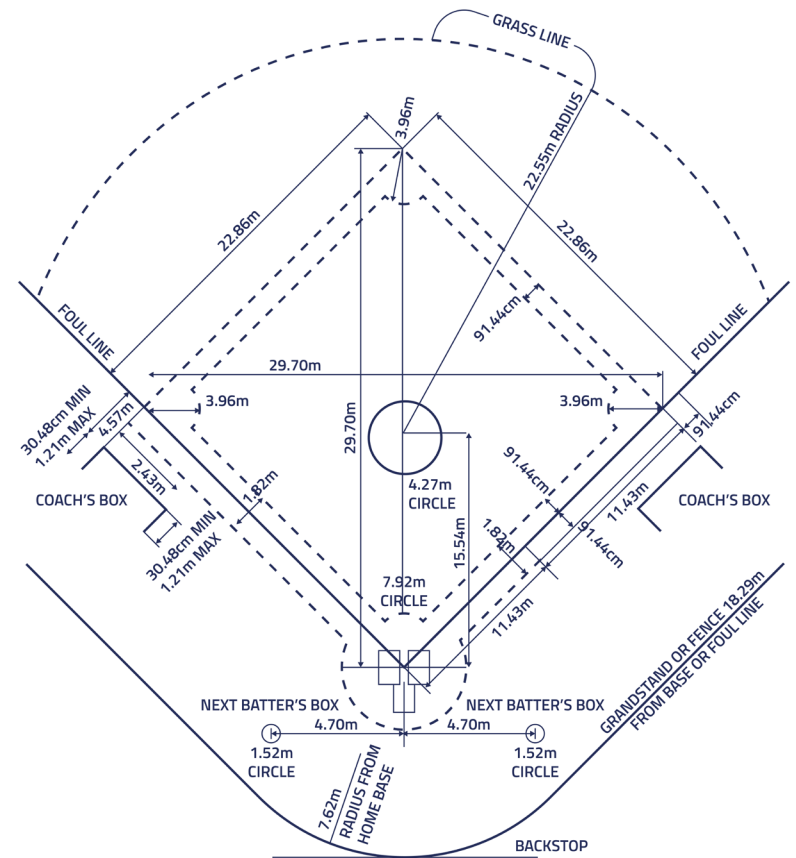

D2. HOME PLATE & BASES

D2.1 FOR U-15 AND ABOVE

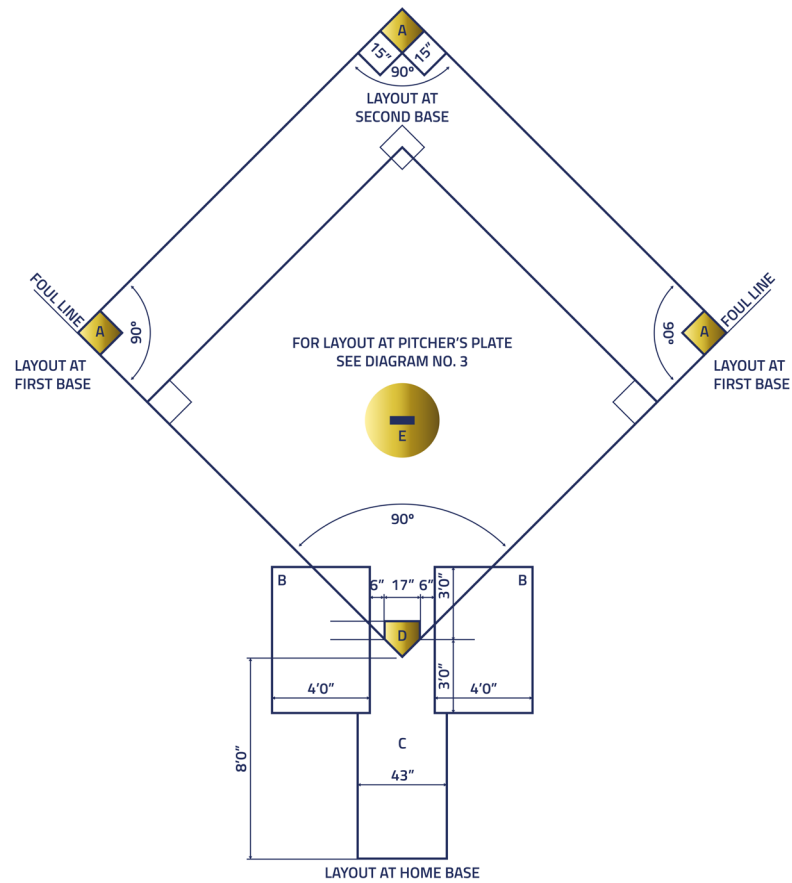

HOME PLATE & BASES

D2.2 FOR U-15 AND ABOVE (METRIC)

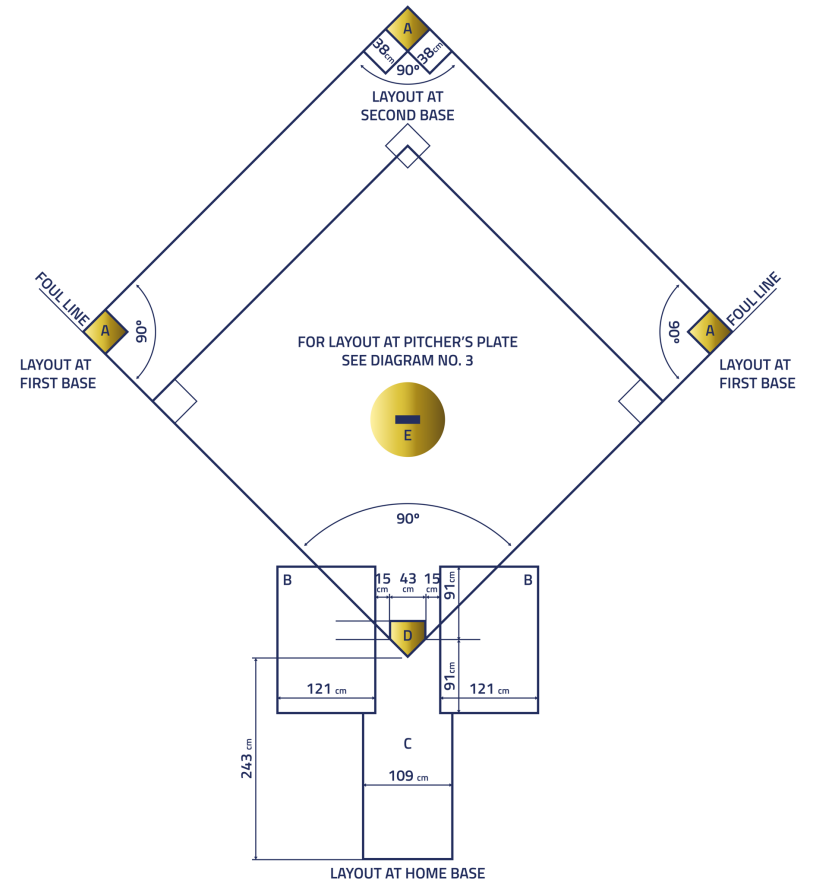



HOME PLATE & BASES

D2.3 FOR U-12 CATEGORY

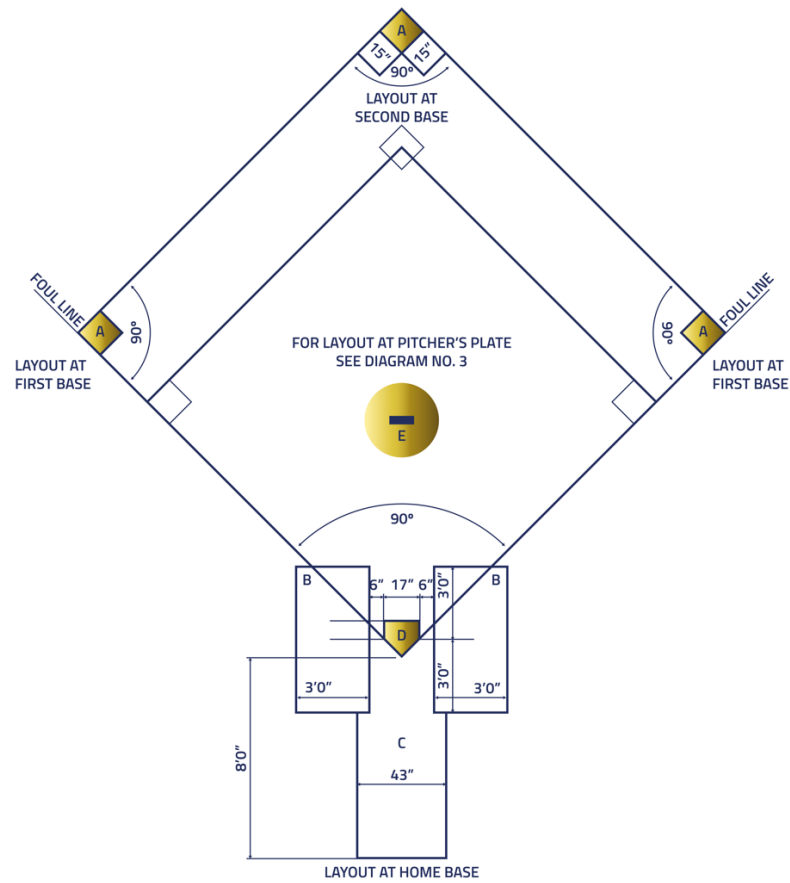

HOME PLATE & BASES

D2.4 FOR U-12 CATEGORY (METRIC)

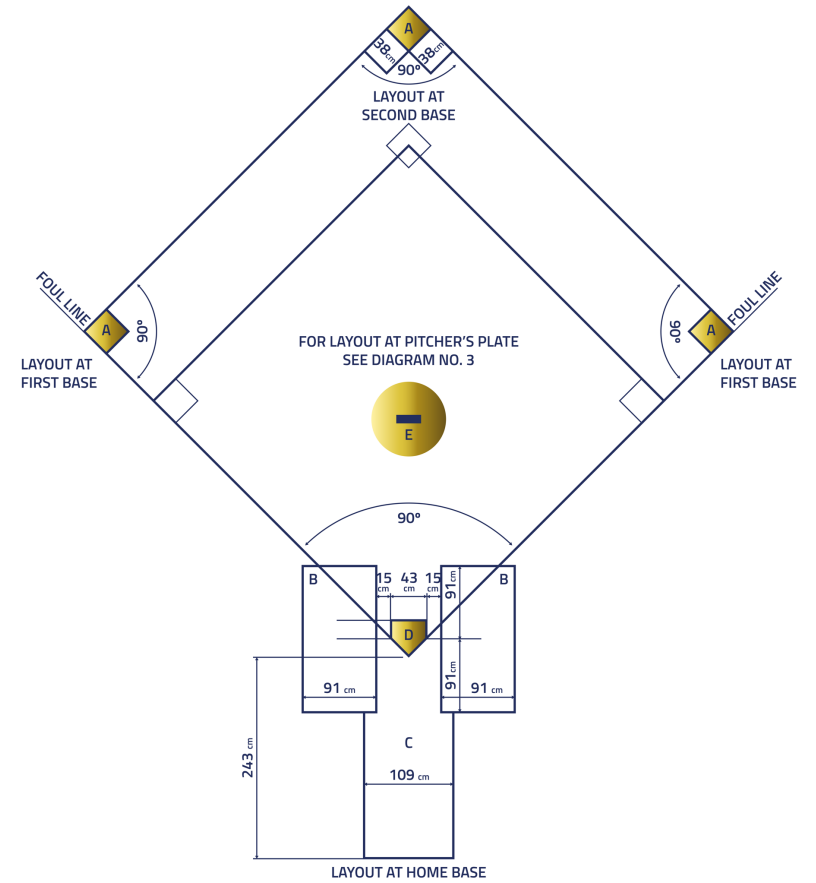

D3. PITCHING MOUND

D3.1 FOR U-15 AND ABOVE

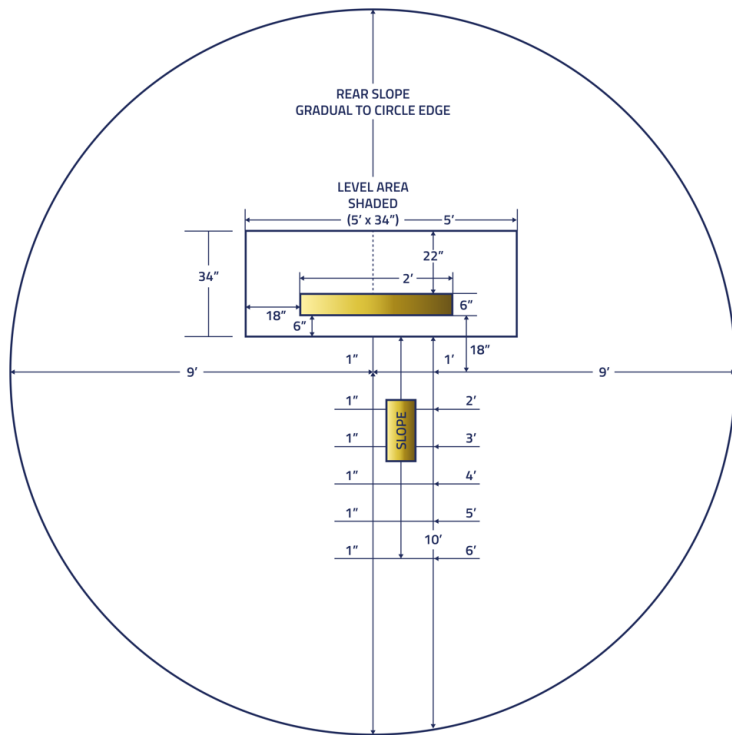

PITCHING MOUND

D3.2 FOR U-15 AND ABOVE (METRIC)

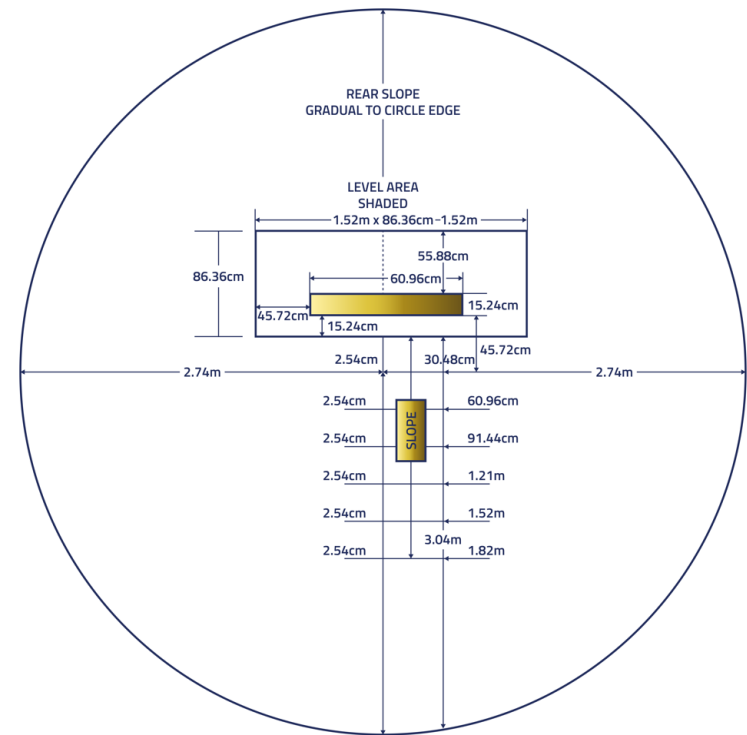



PITCHING MOUND

D3.3 FOR U-12 CATEGORY

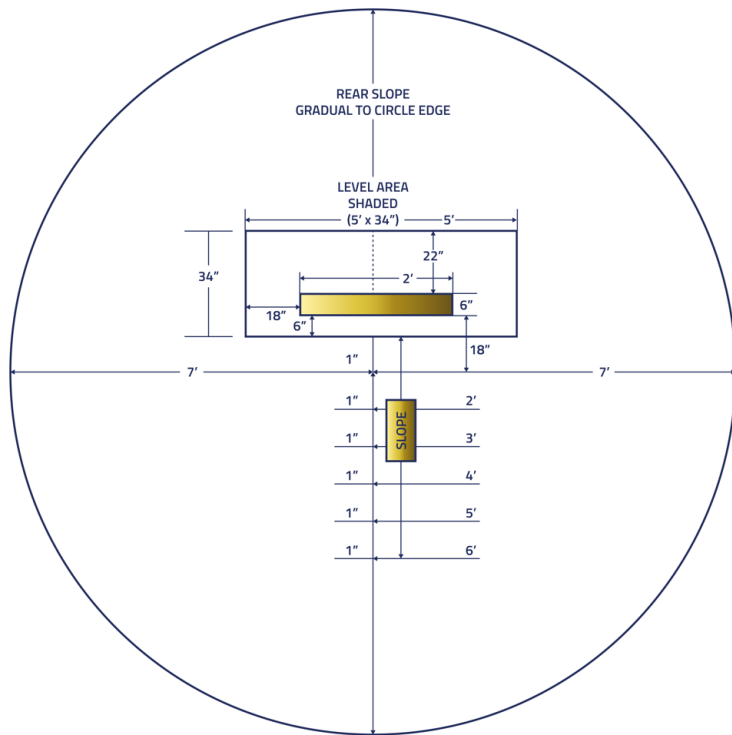

PITCHING MOUND

D3.4 FOR U-12 CATEGORY (METRIC)

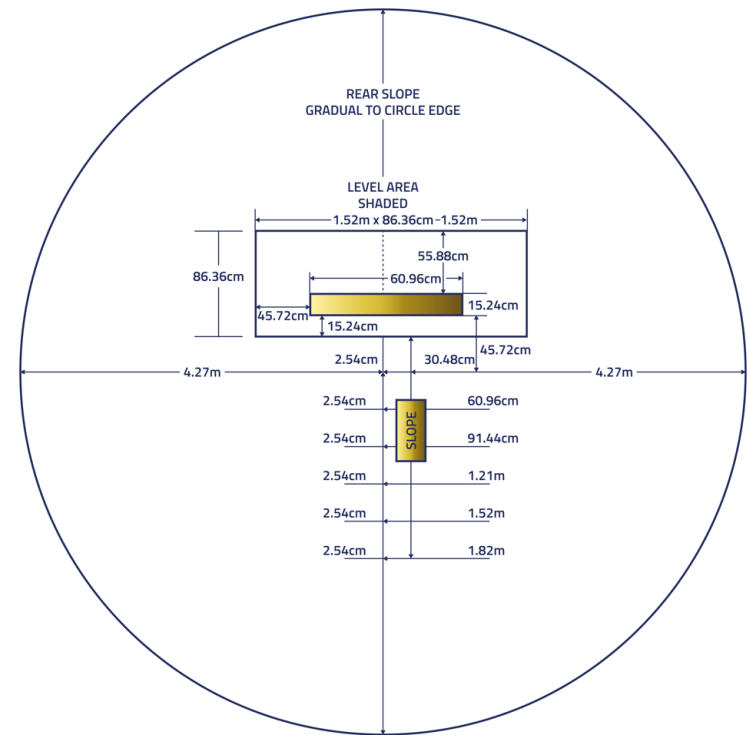

D4. FIELDERS GLOVE

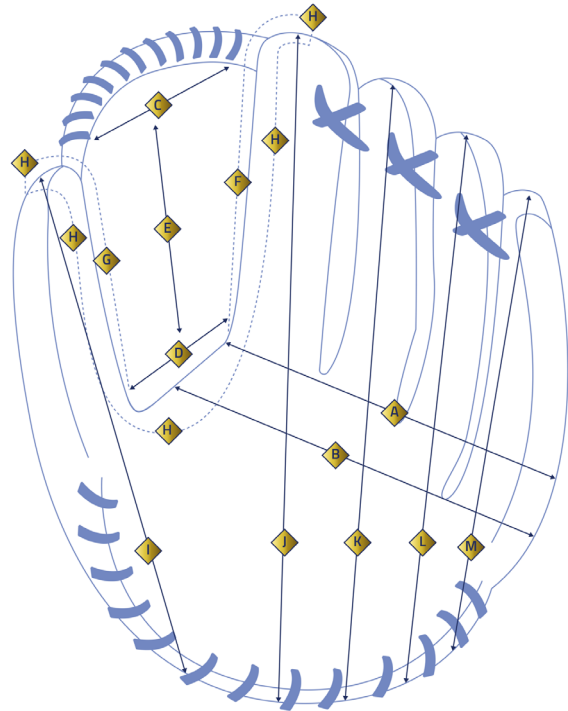

A	Palm width (top)	7 ¾ in (19.68 cm)
B	Palm width (bottom)	8 in (20.32 cm)
C	Top opening of web Webbing not to be wider than 4 ½ in (11.43 cm) at any point	3 ½ in (8.89 cm)
D	Bottom opening of web	3 ½ in (8.89 cm)
E	Web top to bottom	5 ¾ in (14.60 cm)
F	1 st finger crotch seam	5 ½ in (13.97 cm)
G	Thumb crotch seam	5 ½ in (13.97 cm)
H	Crotch seam	13 ¾ in (34.92 cm)
I	Thumb top to bottom edge	7 ¾ in (19.68 cm)
J	1 st finger top to bottom edge	13 in (34.92 cm)
K	2 nd finger top to bottom edge	11 ¾ in (29.84 cm)
L	3 rd finger top to bottom edge	10 ¾ in (27.30 cm)
M	4 th finger top to bottom edge	9 in (22.86 cm)

D5. STRIKE ZONE

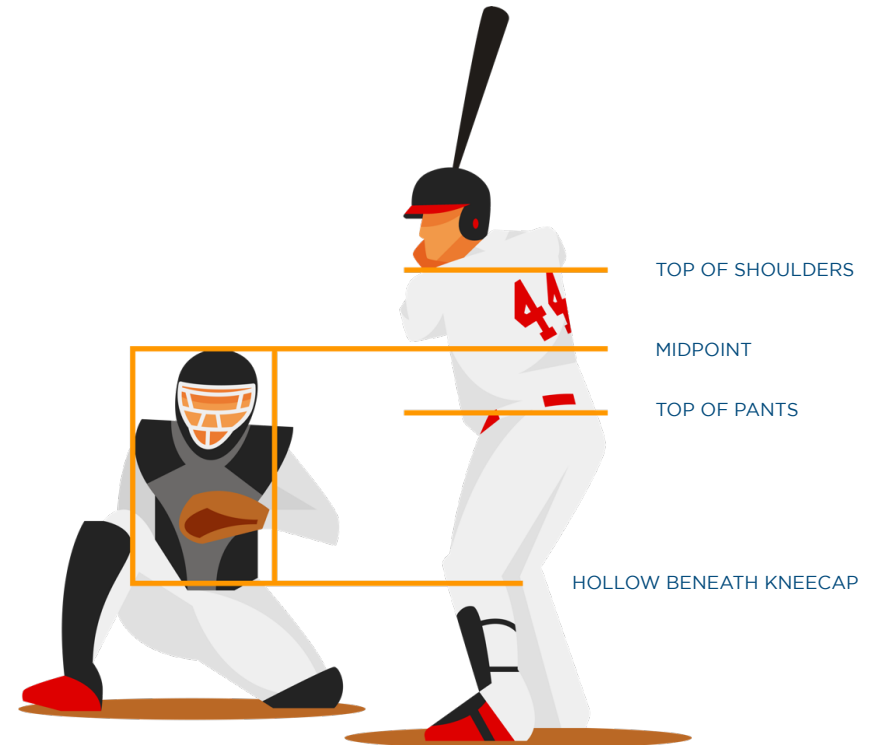

TOP OF SHOULDERS

MIDPOINT

TOP OF PANTS

HOLLOW BENEATH KNEECAP

APPENDIX 05. CROSS REFERENCE

OFFICIAL BASEBALL RULES	WBCS OFFICIAL RULES OF BASEBALL
Rule 1.01	Rule 1
Rule 2.00	Rule 2
Rule 2.01	Rule 2.1
Rule 2.02	Rule 2.2
Rule 2.03	Rule 2.3
Rule 2.04	Rule 2.4 - 2.5
Rule 2.05	Rule 6.1
Rule 3.01	Rule 3.1
Rule 3.02	Rule 3.2
Rule 3.03	Rule 3.3
Rule 3.04	Rule 3.4
Rule 3.05	Rule 3.4
Rule 3.06	Rule 3.4
Rule 3.07	Rule 3.4
Rule 3.08	Rule 3.5
Rule 3.09	N/A
Rule 3.10	Rule 3.6
Rule 4.01	Rule 4.1
Rule 4.02	Rule 4.2
Rule 4.03	Rule 5.5
Rule 4.04	Rule 5.1
Rule 4.05	Rule 5.4
Rule 4.07	Rule 5.6
Rule 5.01	Rule 7.1
Rule 5.02	Rule 7.5
Rule 5.03	Rule 7.4
Rule 5.04	Rule 9
Rule 5.04(a)	Rule 9.1
Rule 5.04(b)	Rule 9.4
Rule 5.04(c)	Rule 6.13
Rule 5.05	Rule 10.2
Rule 5.06	Rule 10
Rule 5.06(a)	Rule 10.3
Rule 5.06(b)	Rule 10.4
Rule 5.06(c)	Rule 10.5
Rule 5.07	Rule 13
Rule 5.07(a)	Rule 13.2
Rule 5.07(a)(1)	Rule 13.2
Rule 5.07(a)(2)	Rule 13.3.2
Rule 5.07(b)	Rule 13.4
Rule 5.07(c)	N/A
Rule 5.07(d)	Rule 13.7
Rule 5.07(e)	Rule 13.8
Rule 5.07(f)	Rule 13.9
Rule 5.08	N/A
Rule 5.09(a)	Rule 9.10
Rule 5.09(b)	Rule 10.7
Rule 5.09(c)	Rule 11
Rule 5.09(d)	Rule 11.2
Rule 5.09(e)	Rule 11.3

OFFICIAL BASEBALL RULES	WBCS OFFICIAL RULES OF BASEBALL
Rule 5.10	N/A
Rule 5.11	Rule 9.3
Rule 5.12	Rule 8.5
Rule 6.01	Rule 12
Rule 6.01(a)	Rule 12.1
Rule 6.01(b)	Rule 12.1
Rule 6.01(c)	Rule 9.10
Rule 6.01(d)	Rule 12.3
Rule 6.01(e)	Rule 12.4
Rule 6.01(f)	Rule 12.5
Rule 6.01(g)	Rule 12.6
Rule 6.01(h)	Rule 12.7
Rule 6.01(i)	Rule 12.8
Rule 6.01(j)	Rule 10.6
Rule 6.02	Rule 13
Rule 6.02(a)	Rule 13.10
Rule 6.02(b)	N/A
Rule 6.03(a)	Rule 9.7
Rule 6.03(b)	Rule 9.8
Rule 6.04	Rule 8.6
Rule 7.01	Rule 7.7
Rule 7.02	Rule 7.8 - 7.9
Rule 7.03	Rule 7.11
Rule 7.04	Rule 7.12
Rule 8.00	Rule 14
Rule 8.01	Rule 14.1
Rule 8.02	Rule 14.2
Rule 8.03	Rule 14.3
Rule 8.04	Rule 14.4
Rule 9.00	Rule 15
Rule 9.01	Rule 15.2
Rule 9.02	Rule 15.4
Rule 9.04	Rule 16.6
Rule 9.05	Rule 16.2
Rule 9.07	Rule 16.7
Rule 9.08	Rule 16.5
Rule 9.10	Rule 17.2
Rule 9.11	Rule 17.4
Rule 9.12	Rule 17.3
Rule 9.13	Rule 17.5
Rule 9.14	Rule 16.8
Rule 9.15	Rule 16.9
Rule 9.16	Rule 18.3
Rule 9.17	Rule 18.2
Rule 9.18	Rule 18.2
Rule 9.19	Rule 18.2
Rule 9.20	Rule 19.1
Rule 9.22	Rule 19.7
Rule 9.23	Rule 19.8



2023-2024
**OFFICIAL
RULES OF
BASEBALL**

WBSC HEADQUARTERS
Avenue Général-Guisan, 45
CH-1009 Pully | Switzerland

OFFICE
Phone: +41 21 318 8240
Fax: +41 21 318 8241
E-mail: office@wbsc.org



WBSC

