

Document I-5

Document title: A.A. Blagonravov, Editor in Chief, *Collected Works of K.E. Tsiolkovskiy, Volume II - Reactive Flying Machines*, Translation of "K.E. Tsiolkovskiy, *Sobraniye Sochineniy, Tom II - Reaktivnyye Letatel'nyye Apparaty*," Izdatel'stvo Akademii Nauk SSSR, Moscow, 1954, NASA TT F-237, 1965, pp. 72-117.

Konstantin Tsiolkovskiy was a school teacher who lived in the small town of Kaluga, Russia. He is regarded by the Russians as the founder of Soviet rocketry, much as Robert Goddard and Hermann Oberth are regarded as the fathers of American and German rocketry in their respective countries. He is responsible for associating the term Sputnik, or "fellow traveller," to artificial satellites. But Tsiolkovskiy's work was almost entirely theoretical and was not widely known or translated outside of Russia, until after his death.

This article, written in 1898 and first published in 1903, established the fundamentals of orbital mechanics and proposed the then-radical use of both liquid oxygen and liquid hydrogen as fuel. It appeared seventeen years before Goddard repeated much of the work in the United States and twenty-three years before he began the first experiments with liquid propellants. It was also the first detailed discussion of a manned space station. The fact that it was not translated until much later meant that its impact on rocket research around the world was minimal.

[72]

Exploration of the Universe with Reaction Machines

Heights Reached by Balloons; Their Size and Weight; the Temperature and Density of the Atmosphere

1. So far small unmanned aerostats carrying automatic observation equipment have risen to altitudes of not more than 22 km.

Above this height the difficulties of ascending to higher altitudes by balloon increases rapidly.

Suppose an aerostat is required to climb to an altitude of 27 km carrying a load of 1 kg. The air density at an altitude of 27 km is about $\frac{1}{50}$ of the density at the surface (760 mm pressure and 0°C). This means that at this altitude a balloon must occupy a volume 50 times greater than on the ground. At sea level, it is filled with, say, at least 2 cubic meters of hydrogen, which at the given altitude will occupy 100 cubic meters. At the same time, the balloon will lift a load of 1 kg, i.e., the automatic instruments, and the balloon itself will weigh about 1 kg. Assuming the diameter of the envelope to be 5.8 m meters, its surface area will be at least 103 square meters. Therefore, every square meter of the material, including the reinforcing mesh sewn into it, should weigh 10 g.

One square meter of ordinary writing paper weighs 100 g, while one square meter of cigarette paper weighs 50 g. Thus even cigarette paper would be five times heavier than the material needed for our balloon. Such a material could not be used in the balloon, as an envelope made from it would tear and allow the gas to leak at a rapid rate.

Large balloons may have thicker envelopes. Thus, a balloon [73] with the unprecedentedly large diameter of 58 meters would have an envelope, one square meter of which would weigh about 100 g, i.e., about as much as ordinary writing paper. It would lift a load of 1,000 kg, which is much more than an automatic recorder would weigh.

If we reduce this load to one kilogram, using the same gigantic aerostat, we can make the envelope twice as heavy. In general, such a balloon, while expensive, would be perfectly feasible. At an altitude of 27 km it would occupy a volume of 100,000 cubic meters, and the surface area of its envelope would be 10,300 square meters.

And yet, how miserable these results seem! A mere 27 km. How then could the instruments be raised higher? The aerostat would have to be still larger. But here it should not be forgotten that as the size increases the forces acting on the envelope dominate more and more over the resistance of the material.

Raising instruments beyond the limits of the atmosphere by means of an aerostat is, of course, inconceivable; observations of shooting stars reveal that those limits lie no higher than 200-300 km. In theory, the top of the atmosphere may even be set at 54 km, if we base our calculations on a decrease in air temperature by 5°C per kilometer, which is fairly close to reality, at least with respect to the accessible layers of the atmosphere.*

I present a table of altitudes, temperatures and air densities calculated on this basis. It shows how rapidly the difficulties increase with altitude.

The divisor in the last column indicates the degree of difficulty in constructing a balloon. [74]

Depth of atmosphere in km†	Temperature in °C	Air Density
0	0	1
6	- 30	1 : 2
12	- 60	1 : 4.32
18	- 90	1 : 10.6
24	- 120	1 : 30.5
30	- 150	1 : 116
36	- 180	1 : 584
42	- 210	1 : 3900
48	- 240	1 : 28 000
54.5	- 272	0

2. Let us now consider another possible means of reaching high-altitudes—cannon-launched projectiles.

In practice, the initial velocity of a shell does not exceed 1,200 m/sec. Such a projectile, if launched vertically, would rise to an altitude of 73 km, if the ascent took place in a vacuum. In air, however, the height reached would be much lower depending on the shape and mass of the projectile.

If the shape of the projectile were suitable, it might reach a considerable height; but instruments could not be housed inside the projectile, since they would be smashed into fragments on its return to Earth or even while it was still moving through the barrel of the cannon. The danger would be less if the projectile were shot from a [75] tube, but even then it would still be enormous. Suppose, for the sake of simplicity, that the gas pressure on the projectile was uniform, so that the acceleration was $W \text{ m/sec}^2$. Then the same acceleration would also be imparted to all the objects inside the projectile, objects forced to share the same motion. As a result, inside the projectile there would develop a relative,

† Editor's note: According to recent data, in the stratosphere, between 11 and 35 km, the temperature is constant and equal to -56.5°C. In the region between 35 and 50 km a rise in temperature to -30-35°C is observed.

* It is now known that the decrease in temperature continues only as far up as the boundary of the troposphere, i.e., up to 11 km.

apparent gravity,* equal to W/g , where g is acceleration due to gravity at the Earth's surface.

The length of the cannon L may be expressed by the formula

$$L = \frac{V^2}{2(W-g)},$$

whence

$$W = \frac{V^2}{2L} + g,$$

where V is the velocity acquired by the projectile on leaving the muzzle.

It is clear from the formula that W , and hence the increase in relative gravity in the projectile, decreases with increasing barrel length if V is constant, i.e., the longer the cannon the greater the safety of the instruments during the firing of the projectile. But even if the cannon were, in theory, extremely long, which is not feasible in practice, the apparent gravity in the projectile, as the latter accelerates through the barrel, would [76] become so enormous that the sensitive instruments would hardly be able to withstand it. This would make it all the more impossible to dispatch a living organism in the projectile, should this be found necessary.

3. Let us assume that we have succeeded in building a cannon approximately 300 m tall. Suppose it has been erected next to the Eiffel Tower which, of course, is the same height, and let the projectile, under the uniform pressure of the gases, attain a muzzle velocity sufficient to carry it beyond the limits of the atmosphere, e.g., to an altitude of 300 km above the surface. Then the velocity V required for this purpose may be calculated from the formula

$$V = \sqrt{2g \cdot h} **,$$

where h is the maximum altitude (we obtain approximately 2,450 m/sec). From the last two formulas, on eliminating V , we obtain

$$\frac{W}{g} = \frac{h}{L} + 1;$$

where W/g expresses the relative or apparent gravity within the projectile. From the formula we find it to be equal to 1001.

Therefore, the weight of all the instruments inside the projectile would increase by more than a thousandfold, i.e., an object weighing one kilogram would experience a pressure of 1,000 kg [77] due to the apparent gravity. There is hardly any physical instrument that can withstand such a pressure. And what a tremendous shock would be experienced by a living organism in a short-barreled cannon and during the ascent to an altitude of more than 300 km!

In order not to lead anyone astray by the words "relative or apparent gravity," let me say that by this I mean a force dependent on the acceleration of a body (for example, a projectile). It also appears during the uniform motion of a body, provided this motion is curvilinear; it is then termed centrifugal force. In general, relative gravity always appears

* g force (Editor's note).

**In these calculations air resistance was not taken into account (Editor's note).

whenever a body is acted upon by some mechanical force that disturbs its inertial motion. Relative gravity operates as long as the force engendering it continues to act; once the latter ceases to act, the relative gravity disappears without a trace. If I term this force gravity, it is only because its temporary effect is exactly the same as that of a gravitational force. Just as every material point of a body is subject to gravitation, so relative gravity affects every particle of a body enclosed in a projectile; this is because relative gravity depends on inertia, by which all the material parts of a body are equally affected. Thus, the instruments inside the projectile will become 1,001 times heavier. Even if they could be preserved intact through this terrifying, though momentary (0.24 sec) intensification in relative gravity, there would still be many other obstacles to the use of cannons as a means of reaching the celestial space.

First and foremost, there is the difficulty of building such cannons, even in the future; second, there is the tremendous initial velocity of the projectile. Actually, in the dense lower layers of the atmosphere the projectile would lose much of its velocity owing to air resistance; now this loss in velocity would also considerably reduce the altitude reached by the projectile. Besides, it is difficult to obtain a uniform gas pressure on the projectile, as the latter moves through the cannon barrel, so that the intensification of gravity will be much greater than calculated (1,001). Finally, the safe return of projectile to Earth would be more than doubtful.

Rocket Versus Cannon

4. Thus, the tremendous increase in gravity alone is definitely enough to dispel any notion of using cannons for our purpose.

Instead of cannons or aerostats, I propose the use of reaction [78] machines to explore the atmosphere. By reaction machine I mean a kind of rocket, but a specially designed rocket on a grandiose scale. The idea is not new, but the calculations yield such remarkable results that they simply cannot be ignored.

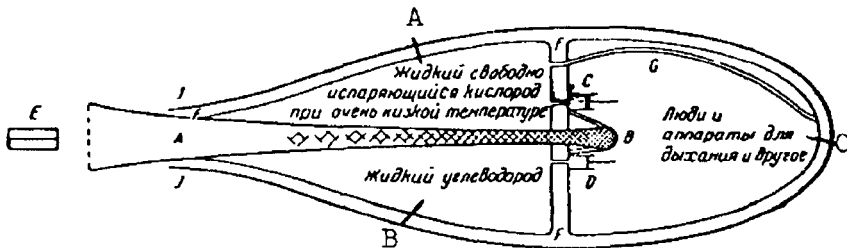

Figure 1

- A -Freely evaporating liquid oxygen at very low temperature.
- B -Liquid hydrocarbon.
- C -Crew, breathing apparatus, etc.

I am far from having investigated every side of the matter, nor have I attempted to solve the practical problems relating to the feasibility of the concept; however, it is already possible to behold, across the veil, such tantalizing and significant glimpses of the distant future as could hardly be dreamed of.

Visualize the following projectile: an elongated metal chamber (the shape of least resistance) equipped with electric light, oxygen, and means of absorbing carbon dioxide, odors, and other animal secretions; a chamber, in short, designed to protect not only various physical instruments but also a human pilot (we shall consider the problem in its broadest terms). The chamber is partly occupied by a large store of substances which, on

being mixed, immediately form an explosive mass. This mixture, on exploding in a controlled and [79] fairly uniform manner at a chosen point, flows in the form of hot gases through tubes with flared ends (Fig. 1), shaped like a cornucopia or a trumpet. These tubes are arranged lengthwise along the walls of the chamber. At the narrow end of the tube the explosives are mixed: this is where the dense, burning gases are obtained. After undergoing intense rarefaction and cooling, the gases explode outward into space at a tremendous relative velocity at the other, flared end of the tube. Clearly, under definite conditions, such a projectile will ascend like a rocket.

Automatic instruments are needed to control the motion of the rocket, as I shall call it, and the force of the explosion in accordance with a predetermined schedule.

Schematic View of the Rocket

The two liquid gases are separated by a partition. The place where the gases are mixed and exploded is shown, as is the flared outlet for the intensely rarefied and cooled vapors. The tube is surrounded by a jacket with a rapidly circulating liquid metal. The control surfaces serving to steer the rocket are also visible.

If the resultant of the explosion forces does not pass through the center of inertia of the projectile, the projectile will rotate and, therefore, will not be suitable. Now, it is quite impossible to attain a mathematically precise coincidence of this kind, because the center of inertia is bound to fluctuate owing to the motion of the substances contained by the projectile, in the same way as the direction of the resultant of the gas pressure inside a cannon barrel cannot be mathematically fixed. So long as the projectile is still in the air, it can be guided with control surfaces like a bird, but what can be done in an airless medium where the ether can not provide any appreciable support?

If the resultant is as close as possible to the center of inertia of the projectile, the rotation will be fairly slow. But as soon as it commences, we can shift some mass inside the projectile until the ensuing displacement of the center of inertia causes the projectile to incline in the opposite direction. Thus, by sensing the movements of the projectile and shifting a small mass inside it, we can cause the projectile to swing now in one, now in the other direction, so that the general direction of action of the explosives and the general direction of motion of the projectile do not change.

[80] It may be that manual steering of the projectile will be not only difficult but even infeasible. In this case, it will be necessary to resort to automatic control.

The Earth's gravitational attraction cannot be used as the principal regulating force, since the projectile will be governed only by relative gravity due to the acceleration W , the direction of which will coincide with the relative direction of the outflowing gases or be directly opposite to their resultant pressure. And since this direction varies with the rotation of the projectile, the relative gravity is unsuitable as the basis of a guidance system.

On the other hand, it is possible to use a magnetic needle or the strength of the Sun's rays focused by means of a biconvex lens. Whenever the projectile rotates, the small, bright image of the sun will change its relative position in the projectile, thus causing the expansion of a gas, or creating a pressure or an electric current, and hence the movement of a counterweight to restore the direction of the projectile, so that the light spot again falls on a neutral, insensitive part of the mechanism.

There should be two such automatically actuated masses.

Another basis for the guidance system of the projectile could be a small chamber with two disks rapidly rotating in different planes. The chamber is suspended so that its position or, more exactly, direction is independent of the direction of the projectile. When the projectile rotates, the chamber (if we ignore the friction) retains the same absolute direction (relative to the stars) thanks to its inertia; this property manifests itself to a high degree when the chamber disks rotate rapidly. If fine springs attached to the chamber changed their relative position during the rotation of the projectile, this change could be used to excite a current and produce a shift in the position of the counterweights.

Lastly, rotation of the mouth of the tube might also serve as a means of keeping the projectile on course. The simplest means of steering the rocket would be dual control surfaces mounted externally, close to the mouth of the tube. As for preventing the rotation of the rocket about its longitudinal axis, this can be accomplished by rotating a plate located in the gas flow and aligned with the direction of this flow.*

[81]

Advantages of the Rocket

5. Before expounding the theory of the rocket or similar reaction-propelled devices, I shall try to interest the reader in the advantages of the rocket as compared with the cannon-launched projectile:

a) Our device, compared with the gigantic cannon, is as light as a feather, relatively cheap, and comparatively easy to realize.

b) The pressure of the explosives, being fairly uniform, creates a uniform acceleration which develops a relative gravity; we can adjust the magnitude of this temporary gravity as desired, i.e., by regulating the force of the explosion, and make it arbitrarily small or many times greater than normal terrestrial gravity. If we assume for simplicity's sake that the force of the explosion diminishes in proportion to the mass of the projectile plus the mass of the remaining, still unexploded fuel, the acceleration of the projectile, and hence the relative gravity, will be constant. Thus, with respect to apparent gravity, a rocket can safely be used to dispatch not only measuring instruments but also human beings, whereas a cannon-launched projectile, even one shot from a colossal cannon as tall as the Eiffel Tower, involves a 1,001-fold increase in relative gravity in ascending to 300 km.

c) Another important advantage of the rocket is that its velocity can be made to increase at a desired rate and in a desired direction; it may be kept constant; or it may uniformly decrease, thus making possible a safe landing. Everything depends on a reliable explosion regulator.

d) At take-off, when the atmosphere is dense and the air resistance at high speeds enormous, the rocket moves comparatively slowly and therefore the losses due to air resistance are low; moreover, the rocket does not become overheated.

The velocity of a rocket increases only very slowly; but later on, as it ascends to more and more rarefied layers of the atmosphere, it can be made to increase more rapidly, until, finally, in airless space the velocity reaches a maximum. Thus, the work done in overcoming air resistance is reduced to a minimum.

[82]

The Rocket in an Atmosphereless, Gravitationless Medium The Mass Ratio of the Rocket

6. First let us consider the effect in an atmosphereless, gravitationless medium. As regards the atmosphere, we shall consider only its resistance to the motion of the projectile, disregarding its resistance to the expulsion of exhaust gases. The effect of the atmosphere on the explosion is not altogether clear; on the one hand, it is favorable, since the exploding substances receive some support from the material medium, thus contributing to an increase in the rocket's velocity; on the other hand, the density and pressure of the atmosphere interfere with the expansion of the gases beyond certain known limits, so that these gases do not acquire the velocity they would acquire if expelled in a void. The latter effect is unfavorable, since the increase in the velocity of the rocket is proportional to the

*It is noteworthy that here Tsiolkovskiy anticipates the development of modern exhaust control vanes (Editor's note).

velocity of the expelled explosion products.

7. Let us denote by M_1 the mass the projectile together with all it contains, except the supply of explosives; by M_2 , the total mass of the explosives; and, lastly, by M , the variable mass of the explosives remaining in the projectile in unexploded form at a given instant.

Thus, the total mass of the rocket at the commencement of the explosion will be: $(M_1 + M_2)$; some time later, however, it will be expressed by the variable $(M_1 + M)$; and finally, when the explosion ends, by the constant M_1 .

In order for the rocket to attain its maximum velocity, it must expel the explosion products in a fixed direction relative to the stars. Therefore it must not rotate and, in order for it not to rotate, the resultant of the explosive forces—which passes through their center of pressure—must at the same time pass through the center of inertia of the whole complex of speeding masses. We have already solved the problem of how to accomplish this in practice.

Thus, assuming the optimal expulsion of the gases in a single direction, we obtain the following differential equation based on the law of conservation of momentum:

$$[83] \quad dV(M_1 + M) = V_1 dM \quad (8)$$

9. Here dM is an infinitely small mass of explosive material expelled from the mouth of the tube at a constant (relative to the rocket) velocity V_1 .

10. I should point out that on the basis of the law of relative motion, given the same conditions, the relative velocity of the exhaust elements is the same throughout the period of the explosion. dV is the increment in the velocity of the rocket together with the remaining unconsumed explosives; this increment, dV , is due to the expulsion of an element dM at the velocity V_1 . We shall determine the latter in the proper place.

11. Separating the variables in equation (8) and integrating, we obtain

$$\frac{1}{V_1} \int dV = - \int \frac{dM}{M_1 + M} + C, \quad (12)$$

or

$$\frac{V}{V_1} = -\ln(M_1 + M) + C. \quad (13)$$

where C is a constant. When $M = M_2$, i.e., before the explosion, $V = 0$; thus we find

$$C = +\ln(M_1 + M_2); \quad (14)$$

and hence

$$\frac{V}{V_1} = \ln\left(\frac{M_1 + M_2}{M_1 + M}\right). \quad (15)$$

[84] The velocity of the projectile will be a maximum when $M = 0$, i.e., when the entire fuel supply M_2 has been burned; then, putting $M = 0$ in the preceding equation, we have

$$\frac{V}{V_1} = \ln\left(1 + \frac{M_2}{M_1}\right). \quad (16)$$

Hence we see that the velocity V of the projectile increases without limit with increase in the amount M_2 of explosives. This means that we can attain different final velocities for different voyages, depending on the store of explosives taken on board. Equation (16) also shows that a definite quantity of explosive is consumed, the velocity of the rocket does not depend on the rate or uniformity of the explosion, so long as the particles of exhaust material move at the same velocity V_1 with respect to the projectile.

17. However, as the quantity M_2 increases, the velocity V of the rocket increases ever more slowly, though without limit. It increases more or less as the logarithm of the increase in the amount of explosives M_2 (if M_2 is large compared with M_1 , i.e., if the mass of the explosives is several times larger than the mass of the projectile).

18. Further calculations will be of interest, once we have determined V_1 , i.e., the relative and final velocity of the explosion products. Since a gas or vapor leaving the mouth of the tube is much rarefied and cooled (if the tube is sufficiently long) and may even solidify—turn into particles of dust rushing at terrific speeds—it may be assumed that, when an explosion occurs, the entire energy of combustion or chemical combination is transformed into the motion of the combustion products or into kinetic energy. In fact, imagine a given amount of gas expanding in a void, without any restrictions: it will expand in all directions and, consequently, cool until it turns into droplets of liquid or a mist.

This mist will turn into minute crystals, no longer due to expansion but rather to evaporation and radiation into space.

[85] On expanding the gas will release all its manifest and part of its latent energy, which will ultimately be converted into rapid motion of the minute crystals in all directions—since the gas expanded freely. If, however, the gas is forced to expand in a tubular chamber, the tube will orient the motion of the gas molecules in a fixed direction, which is the method we use to propel our rocket.

It would seem that the energy of molecular motion is converted into kinetic motion as long as a substance remains in the gaseous or vapor state. But this is not quite so. In fact, part of the substance may turn to liquid; this involves the release of energy (latent heat of vaporization), which is transmitted to the part remaining as a vapor, thus delaying its transition to the liquid state.

We can observe an effect of this kind in a steam cylinder when steam does work owing to its own expansion and the valve from the boiler to the cylinder is closed. In this case, whatever the temperature of the steam, part of it turns into a mist, i.e., the liquid state, while the rest remains as a vapor and continues to do work, borrowing the latent heat of the condensed and liquefied fraction.

Thus, the molecular energy will continue to be transformed into kinetic energy at least until the liquid state is reached. Once the entire mass turns into droplets, the conversion to kinetic energy will cease almost completely, because the vapors of liquids and solids have only an insignificant pressure when the temperature is low, and their practical utilization is difficult, requiring enormous tubes.

In addition, an insignificant part of the energy is lost, i.e., is not converted into kinetic energy, due to friction against the walls of the tube and the radiation of heat from the heated parts of the tube. However, the tube can be encased in a jacket through which a liquid metal is circulated; this liquid metal will convey heat from the intensely heated end of the tube to the end cooled by the rarefaction of the vapor. Thus, the losses due to radiation and conduction can also be recovered or minimized. In view of the short duration of the explosion, which takes 2 to 5 min at most, the loss due to radiation is negligible, even without any special precautions; the circulation of the liquid metal in the tube jacket is more important for another purpose: the maintenance of a uniformly low tube wall temperature, i.e., the preservation of the mechanical strength of the tube. Despite this it may happen that part of the tube will melt, oxidize, and be carried away by the gases and vapors. To prevent this, the inside walls of the tube could be lined with some special refractory material: carbon, tungsten, etc. Some of the carbon may burn away, but the relatively

cool metal tube will suffer little loss of strength.

As for the gaseous product of combustion of carbon—carbon [86] dioxide—this will only intensify the thrust of the rocket. Some kind of crucible material, some mixture of substances, might be used. However, I shall not attempt to solve these and other problems pertaining to reaction-propulsion machines.

In many cases I am limited to guesses or hypotheses. I am not deluding myself and I am perfectly aware that I am not solving the problem in its entirety, that a thousand times more work than I have done must be invested in its solution. My aim is to arouse interest by pointing out its great future significance and the feasibility of a solution....

The liquefaction of hydrogen and oxygen involves no special difficulty. Hydrogen could be replaced by liquid or liquefied hydrocarbons, for example, by acetylene or oil. These liquids must be separated by a partition. Their temperature is very low; therefore it would be expedient to allow them to surround either jackets with circulating liquid metal or the tubes themselves.

Experience will show which is better. Some metals become stronger when cooled; these are the metals that should be employed, copper, for example. I do not recall this clearly, but it seems that experiments on the resistance of iron in liquid air have revealed that its strength at such low temperatures is virtually dozens of times greater. I cannot guarantee the reliability of these experiments, but, in relation to the problem discussed here, they deserve the most diligent attention.* (Why not cool ordinary cannon in the same way before firing, since liquid air is now so easily obtainable.)

[87] Liquid oxygen and liquid hydrogen, when pumped from lands and supplied in a fixed ratio to the narrow inlet of the tube, where they progressively combine, constitute an excellent explosive. The water vapor obtained from the chemical combination of these liquids will expand at a tremendously high temperature in the direction of the wide end or mouth of the tube, until it cools to a liquid racing toward the outlet in the form of an ultrafine mist.

19. Hydrogen and oxygen in the gaseous state release 3825 calories on combining to form 1 kg of water. By the word "calorie" I mean the amount of heat required to raise one kilogram of water through 1°C.

This figure (3825 calories) will be somewhat lower in the present case, since the oxygen and hydrogen are in the liquid rather than in the gaseous state, to which this particular number of calories relates. In fact, the liquids must first be heated and then converted to the gaseous state, which requires some expenditure of energy. In view of the insignificant amount of energy required, as compared with the chemical energy, we shall not reduce this figure (the question has not been completely clarified by science; but we are merely taking oxygen and hydrogen as an example).

Assuming the mechanical equivalent of heat to be 427 kgm, we find that 3825 calories corresponds to 1633 kgm of work; this is enough to raise the explosion products, i.e., one kilogram of matter, to an altitude of 1633 km above the surface of the Earth, that the force of gravity is constant. This work, converted into motion, corresponds to the kinetic

*The author mentions a metal, iron, which has proved to be unsuitable with regard to its strength at low temperatures, as already pointed out by R. Lademann in his article "Zum Raketenproblem" (On the Rocket Problem) in the issue of April 28, 1927, of the periodical ZFM.

The author replies in the appendix to the book "Kosmicheskaya raketa, opynaya podgotovka" (The Space Rocket – Experimental Preparations):

"Concerning the increase in the strength of iron at the temperature of liquid air, in 1903 I merely repeated information that I had read elsewhere, and I shall certainly not insist that it is true, once it has been proved to be untrue. In practice, the explosion tube could not attain such a degree of coldness. It is cooled by oil which, in turn, is cooled by liquid air. It is enough if the tube does not melt or burn, the petroleum does not boil, and the liquid air does not vaporize too quickly. There is no need to reach the temperature of liquid air in the explosion tube." (Editor's note in "Izbrannyye trudy K. E. Tsiolkovskogo" (Selected Works of K. E. Tsiolkovskiy), Book II - "Reaktivnoye dvizheniye" (Reaction propulsion), Moscow, ONTI, 1934.)

energy of a mass of one kilogram moving at a velocity of 5700 m/sec. I know of no group of substances that, on combining chemically, could release such a tremendous amount of energy per unit mass of the resulting product. Moreover, some substances on combining do not form volatile products at all, which is not at all suitable for our purposes. Thus, silicon, on burning in oxygen ($\text{Si} + \text{O}_2 = \text{SiO}_2$), releases an enormous amount of heat, namely, 3654 calories per unit of mass of the resulting product (SiO_2) but, [88] unfortunately the product is non-volatile.

Having taken liquid oxygen and hydrogen as the most suitable materials for creating an explosion, I gave a somewhat exaggerated figure for their chemical energy per unit mass of product (H_2O), since in a rocket the explosive substances must be in the liquid and not the gaseous state and, moreover, at a very low temperature.

I consider it pertinent to console the reader with the thought that we may expect not only this energy (3825 calories) but an incomparably greater energy in the future, if and when our still embryonic ideas are found to be feasible. In fact, on considering the amount of energy produced by various chemical processes, we find that as a general rule, though naturally with some exceptions, the amount of energy per unit mass of the products of chemical combination depends on the atomic weight of the combining elements: the lower the atomic weight, the greater the heat released during chemical combination. Thus, the formation of sulfur dioxide is accompanied by the release of only 1250 calories, and the formation of cupric oxide by only 546 calories, whereas when carbon dioxide CO_2 is formed, the carbon releases 2204 calories per unit mass of CO_2 hydrogen combining with oxygen, as we have seen, releases even more (3825).

To relate these data to the idea I have just formulated, let me remind you that the atomic weights of the elements named are: hydrogen, 1; oxygen, 15; carbon, 12; sulfur, 32; silicon, 28; copper, 63.

Of course, many exceptions to this rule can be cited, but in general it is valid. In fact, if we imagine a series of points the abscissas of which express the sum (or mathematical product) of the atomic weights of the combining elements, and the ordinates—the corresponding energy of chemical combination, then, on drawing a smooth curve through these points (as close to them as possible), we observe a steady decrease in the ordinates with increase in the abscissas, just as our theory suggests. For this reason, if at some time so-called simple substances prove to be complex and are separated into new elements, the atomic weights of these elements should be smaller than those of the simple substances known to us.

Accordingly, newly discovered elements, upon combining chemically, must release an incomparably larger amount of energy than bodies currently considered simple and having a comparatively large atomic weight.

The very existence of the ether with its almost infinite expansibility and the enormous velocity of its atoms implies that these atoms have an infinitesimally small atomic weight and infinite energy when they combine.

[89] 20. However this may be, for the time being we cannot count on more than 5700 m/sec as the maximum V_1 (see 15 and 19). With time, however, who knows, this figure may increase several times over.

Assuming 5700 m/sec, we can calculate from formula (16) not only the velocity ratio V/V_1 but also the absolute value of the final (maximum) velocity V of the projectile as a

function of its $\frac{M_2}{M_1}$ ratio.

21. It is evident from formula (16) that the mass of the rocket together with all passengers and equipment, M_1 may be arbitrarily large without thereby detracting in any way from the velocity V of the projectile, so long as the supply of explosives, M_2 , increases in direct proportion to M_1 .

Thus, projectiles of any size with any number of passengers may be given any desired velocity. However, as we have seen, an increase in the velocity of the rocket is accompanied by an incomparably more rapid increase in the mass of the explosives. Therefore, though it may be easy to increase the mass of a projectile destined for outer space, it is correspondingly difficult to increase its velocity.

Flight Velocities as a Function of Fuel Consumption

22. From equation (16) we obtain the following table.

[89]

$\frac{M_2}{M_1}$	$\frac{V}{V_1}$	Velocity m/sec	$\frac{M_2}{M_1}$	$\frac{V}{V_1}$	Velocity m/sec
0.1	0.095	543	7	2.079	11 800
0.2	0.182	1 037	8	2.197	12 500
0.3	0.262	1 493	9	2.303	13 100
0.4	0.336	1 915	10	2.398	13 650
0.5	0.405	2 308	19	2.996	17 100
1	0.693	3 920	20	3.044	17 330
2	1.098	6 260	30	3.434	19 560
3	1.386	7 880	50	3.932	22 400
4	1.609	9 170	100	4.615	26 280
5	1.792	10 100	193	5.268	30 038
6	1.946	11 100	Infinite	Infinite	Infinite

[90] 23. From this table it is clear that the velocities attainable by reaction propulsion are far from negligible. Thus, when the mass of explosives exceeds 193 times the mass M_1 of the projectile (rocket), the velocity during the final moments of the explosion, when the entire supply of explosives M_2 has been consumed, is equal to the velocity of the Earth around the Sun. It should not be supposed that such an enormous mass of explosives requires a commensurate amount of high-strength material for the vessels in which it is stored. In fact, hydrogen and oxygen in liquid form develop high pressure only if the vessels containing them are closed and if the gases themselves get heated due to the influence surrounding, comparatively warm bodies. [91] In the present case, the liquefied gases must have a free outlet to the tube into which they flow constantly in liquid form and where, on chemically combining, they explode.

The continuous and rapid flow of gases, corresponding to the evaporation of the liquids, cools the latter until their vapors exert hardly any pressure on the surrounding walls. Thus, the vessels containing the explosives need not be made very massive.

24. When the mass of the explosives is equal to the mass of the rocket $\left(\frac{M_2}{M_1} = 1\right)$, the

velocity of the latter is nearly twice as great as would be necessary for a stone or cannon ball, launched by "Selenians" from the surface of the Moon, to leave the Moon forever and become an Earth satellite, a second Moon.

This velocity (3920 m/sec) is nearly enough for bodies launched from the surface of Mars or Mercury to leave these planets forever.

If the mass ratio $\frac{M_2}{M_1} = 3$ then, when the entire supply of explosives has been consumed, the projectile will have attained a velocity almost great enough to cause it to revolve like a satellite about the Earth beyond the limits of the atmosphere.

If $\frac{M_2}{M_1} = 6$, the velocity of the rocket will be nearly great enough for it to leave Earth forever and revolve around the Sun like an independent planet. If the supply of explosives is big enough, the asteroid belt and even the heavy planets could be reached.

25. It is evident from the table that even if the supply of explosives is small, the final velocity of the projectile will still be adequate for practical purposes. Thus, if the fuel supply accounts for only 0.1 of the rockets weight, the velocity will be 543 m/sec, which is sufficient for the rocket to ascend to 15 km. The table also shows that if the supply is small, after completion of the explosion the velocity will be approximately proportional to the mass of the fuel (M_2); therefore, in this case, the maximum height will be proportional to the square of this mass (M_2). Thus, if the supply of explosives is equal to half the rocket's

mass $\left(\frac{M_2}{M_1}\right) = 0.5$, the rocket will fly far beyond the limits of the atmosphere.

[92]

Efficiency of Rocket During Ascent

26. It is of interest to determine the fraction of the total work done by the explosives, i.e., their chemical energy, that is transmitted to the rocket.

The work done by the explosives may be expressed as $\frac{V_1^2}{2}M_2$; the mechanical work done by a rocket with the velocity V may be expressed in the same unite: $\frac{V^2}{2}M_1$, or, on the basis of formula (16)

$$\frac{V^2}{2}M_1 = \frac{V_1^2}{2}M_1 \left\{ \ln \left(1 + \frac{M_2}{M_1} \right) \right\}^2.$$

On dividing the work done by the rocket by the work done by the explosives, we obtain

$$\frac{M_2}{M_1} \left\{ \ln \left(1 + \frac{M_2}{M_1} \right) \right\}^2.$$

From this formula we can derive the table of energy utilization by the rocket.

From the table and the formula it is clear that when the amount of explosives is very

small, the utilization (efficiency) is equal to $\frac{M_2}{M_1}$ i.e., the smaller the relative amount of explosives.*

[93]

$\frac{M_2}{M_1}$	Utilization	$\frac{M_2}{M_1}$	Utilization
0.1	0.090	7	0.62
0.2	0.165	8	0.60
0.3	0.223	9	0.59
0.4	0.282	10	0.58
0.5	0.328	19	0.47
1	0.480	20	0.46
2	0.600	30	0.39
3	0.64	50	0.31
4	0.65	100	0.21
5	0.64	193	0.144
6	0.63	Infinity	Zero

[94] Further, as the relative amount of explosives increases, the utilization increases and reaches a maximum (0.65) when $M_2/M_1 = 4$.

Any further increase in the proportion of explosives will gradually but steadily reduce their utilization. When the supply of explosives is infinitely large, the utilization falls to zero, just as when the supply is infinitely small. It is also clear from the table that when M_2/M_1 ranges between 2 and 10 the utilization exceeds one half, i.e., more than half the potential energy of the explosives is transmitted to the rocket in the form of kinetic energy. In general, from 1 to 20 it is extremely high and close to 0.5.

Rockets Under the Influence of Gravity. Vertical Ascent

27. We have determined the velocity acquired by the rocket in a gravitationless vacuum as a function of the mass of the rocket, the mass of the explosives and their energy of chemical combination.

We shall now consider the effect of gravity on the vertical motion of the projectile.

When not influenced by gravity, the rocket can acquire dizzy speeds and can utilize a considerable proportion of the explosive energy. This also holds true in a gravitational

*In fact, $\ln(1+x) = x - \frac{x^2}{2} + \frac{x^3}{3} - \frac{x^4}{4} \dots$

Therefore, approximately, $\frac{M_1}{M_2} \left\{ \ln \left(1 + \frac{M_2}{M_1} \right) \right\}^2 = \frac{M_1}{M_2} \cdot \frac{M_2^2}{M_1^2} = \frac{M_2}{M_1}$.

environment, so long as the explosion is instantaneous. But this kind of explosion is not suitable for our purposes, since it would result in a lethal shock which could be endured neither by the projectile nor by the equipment and passengers. Clearly, we need a slow explosion; but if the explosion is slow, the useful effect diminishes and may even vanish.

Suppose the explosion is so weak that the resulting acceleration of the rocket is equal to the Earth's acceleration g . Then throughout the explosion the projectile will hang motionlessly in the air without support.

Of course, it will not acquire any velocity, and the utilization of the explosives, in whatever quantity they are present, will be zero. Thus, it is extremely important to analyze the effect of gravity on the projectile.

[95] **Determining the Acquired Velocity. Examination of the Numerical Values Obtained. Maximum Height.**

When a rocket moves in a gravitationless medium, the time t during which its entire supply of explosives is consumed, is

$$t = \frac{V}{p}, \quad (28)$$

where V is the velocity of the projectile on completion of the explosion, and p is the constant acceleration imparted to the rocket by the explosives per second.*

In this simple case of uniform acceleration the force of the explosion, i.e., the amount of fuel expended during the explosion per unit of time, will not be constant, but will continually diminish in proportion to the decrease in the mass of the projectile as its supply of explosives is depleted.

29. Knowing p , or the acceleration in a gravitationless medium, we can also determine the apparent (temporary) gravity inside the rocket during its acceleration or during the explosion.

Taking the force of gravity at the Earth's surface as unity, we find the temporary gravity to be p/g , where g is the Earth's acceleration; this formula shows how many times the pressure acting on the base of all the objects in the rocket exceeds the pressure that acts on the same objects when placed on the living room table under normal conditions. It is highly important to know the value of relative gravity in the projectile, since it affects the reliability of the instruments and the health of those setting out to explore the frontiers of space.

[96] 30. Under the influence of a constant or variable gravity of any intensity, the time taken to consume a given supply of explosives will be the same as when there is no gravity at all; it can be expressed by formula (28) or by the following formula:

$$t = \frac{V_2}{p-g}, \quad (31)$$

where V_2 is velocity of the rocket on completion of the explosion in a gravitational medium with constant acceleration g . Here, of course, it is assumed that p and g are parallel and opposite; $p-g$ expresses the visible acceleration of the projectile (with respect to the Earth), which is the result of two opposite forces: the force of the explosion and the force of gravity.

*It is assumed that the mass of the rocket varies in accordance with an exponential law; then the acceleration p due to the thrust will be constant (Editor's note).

32. The action of the force of gravity on the projectile in no way affects the relative gravity inside the projectile, and here the formula p/g still applies. For example, if $p = 0$, i.e., if there is no explosion, there is no temporary gravity, because $p/g = 0$. This means that if the explosion ceases and the projectile moves in some direction solely due to its own momentum and the gravitational attraction of the Sun, Earth, and other stars and planets, an observer inside the projectile will himself apparently be completely weightless, and not even the most sensitive spring balance will register when used to weigh any of the objects present inside the rocket along with the observer. On falling or rising inside the rocket under the action of inertia, even at the very surface of the Earth, the observer will not experience the least heaviness unless, of course, the projectile encounters some obstacle in the form of, say, the resistance of the atmosphere, water or solid earth.

33. If $p = g$, i.e., if the pressure of the exploding gases is equal to the weight of the projectile ($p/g = 1$), the relative gravity will be equal to terrestrial gravity. If it was stationary at the outset, the projectile will remain stationary throughout the explosion. If, however, the projectile had a certain (upward, lateral, downward) velocity before the explosion, this velocity will remain absolutely unchanged until the entire supply of explosives is consumed; thus the body, that is, the rocket, is balanced and moves as if by inertia in a [97] gravitational medium.

On the basis of formulas (28) and (31) we obtain

$$V = V_2 \left(\frac{p}{p-g} \right). \quad (34)$$

Hence, knowing the velocity V_2 that must be acquired by the projectile after the explosion, we can calculate V , from which, with the aid of formula (16), we can also determine the necessary amount of explosives M_2 .

From equations (16) and (34) we obtain:

$$V_2 = -V_1 \left(1 - \frac{g}{p} \right) \cdot \ln \left(\frac{M_2}{M_1} + 1 \right). \quad (35)$$

36. From this, as from the preceding formula, it follows that the velocity acquired by the rocket is smaller in the presence of gravity than in its absence (16). The velocity V_2 may even be zero despite an abundant supply of explosives if $(p/g) = 1$, i.e., if the acceleration imparted to the projectile by the explosives is equal to the terrestrial acceleration, or if the gas pressure is equal and directly opposite to the effect of gravitational attraction (cf. formulas (34) and (35)).

In this case the rocket will stand motionless for a few minutes without rising and, once the supply of explosives has been consumed, will fall like a stone.

37. The greater the value of p in relation to g , the greater the velocity V_2 acquired by the projectile, given a specific amount of explosives M_2 (formula (35)).

[98] Therefore, if the aim is to climb higher, p must be made as large as possible, i.e., the explosion must be as energetic as possible. This, however, requires, first, a sturdier and more massive projectile and, second, sturdier equipment and instruments inside the projectile, because, according to (32), the relative gravity inside the projectile will be extremely large and, in particular, dangerous to any human observer aboard the rocket.

At any rate, on the basis of formula (35) in the limit

$$V_2 = -V_1 \cdot \ln \left(\frac{M_2}{M_1} + 1 \right),$$

i.e., if p is infinitely large or the explosion instantaneous, the velocity V_2 of the rocket in a gravitational environment will be the same as in a gravitationless environment.

According to formula (30), the explosion time is independent of gravity; it depends solely on the ratio M_2/M_1 and the rate of explosion p .

39. It is important to determine this rate. Suppose in formula (28) $V = 11,100$ m/sec (22) and $p = g = 9.9$ m/sec², then $t = 1133$ sec. This means that in a gravitationless medium the rocket would fly for less than 19 minutes with uniform acceleration, even if the amount of explosives were six times the mass of the projectile (22).

In the event of the explosion occurring at the surface of our planet, however, the rocket would stand motionless for the same period of time.

40. In $M_2/M_1 = 1$ then according to the table, $V = 3920$ m/sec; therefore $t = 400$ sec or $6^{2/3}$ min.

When $M_2/M_1 = 0.1$ $V = 543$ m/sec, $t = 55.4$ sec, i.e., less than a minute. In this case the projectile would stand motionless at the Earth's surface for $55^{1/2}$ sec.

Hence we can see that an explosion at the surface of a planet, and in general in any medium that is not free of gravity, may be completely ineffective—even if it occurs over a prolonged period of time—if it is of insufficient force; in fact, the projectile then [99] remains stationary and will have no translational velocity unless some has been previously acquired (It will then move over a certain distance at uniform speed). If this motion is upward, the projectile will do some work. If the original velocity is horizontal, the motion will also be horizontal; then no work will be done,* but the projectile could serve the same purpose as a locomotive, steamship or steerable aerostat. The projectile could function in this way only for a few minutes, while the explosion takes place, but even during such a short period of time it could traverse considerable distances, particularly when moving above the atmosphere. However, we do not consider that the rocket is of any practical value for flights through the air.

The time during which a projectile can remain in a gravitational medium proportional to g , i.e., to the force of gravity.

Thus, on the Moon the projectile could stand motionless, without support, for 2 hours if $\frac{M_2}{M_1} = 6$.

41. In formula (35) for an environment with $\frac{g}{p} = 10$ let us put $\frac{M_2}{M_1} = 1$; we then calcu-

late $V_2 = 9990$ m/sec. Accordingly, the relative gravity will be 10 g , i.e., throughout the explosion time (about 2 min), a person weighing 70 kg will experience gravity ten times as great as on Earth, and, on a spring balance, will weigh 700 kg. This gravity can be safely endured by the traveler only if he observes special precautions: if he is immersed in a special fluid, under special conditions.

On the basis of formula (28) we can also calculate the explosion time, or the duration of the period of intensified gravity; we obtain 113 sec, i.e., less than 2 min. This is very little, and it is amazing that in such a negligible interval of time a projectile could acquire a velocity nearly sufficient to leave the Earth and move around the Sun like a new planet.

We found $V_2 = 9990$ m/sec, i.e., a velocity only slightly less than the velocity V acquirable in a gravitationless medium under the same explosion conditions (22).

But since during the explosion the projectile also climbs to a [100] certain height, the idea suggests itself that the total work done by the explosives is not less than in a gravitationless medium.

*If no allowance is made for the work done in overcoming atmospheric drag (Editor's note).

44. We shall now consider this question.

The acceleration of the projectile in a gravitational medium may be expressed as:

$$P_1 = p - g.$$

At a distance of not more than several hundred versts from the Earth's surface we can assume that g is constant; this does not introduce any appreciable error, and moreover the error will be on the safe side, i.e., the actual figures will be more favorable than those calculated.

The height h reached by the projectile during time t (explosion time) will be

$$h = \frac{1}{2} p_1 t^2 = \frac{p-g}{2} \cdot t^2. \tag{45}$$

Eliminating t , in accordance with equation (31) we obtain

$$h = \frac{V_2^2}{2(p-g)}, \tag{46}$$

where V_2 is the velocity of the projectile in a gravitational medium after the entire supply of explosives has been consumed. Now, on eliminating V_2 , from (34) and (46) we obtain

$$h = \frac{p-g}{2p^2} \cdot V^2 = \frac{V^2}{2p} \left(1 - \frac{g}{p}\right), \tag{47}$$

where V is the velocity acquired by the rocket in a gravitationless medium.

[101]

Efficiency

The useful work done by the explosives in such a medium may be expressed by:*

$$T = \frac{V^2}{2g}. \tag{48}$$

On the other hand, depending on the height reached by the projectile and its velocity at the end of the explosion, the work T_1 done in a gravitational medium may be expressed as

$$T_1 = h + \frac{V^2}{2g}. \tag{49}$$

The ratio of $\frac{T_1}{T}$ (T being the ideal value) is thus

$$\frac{T_1}{T} = \frac{2hg + V^2}{V^2}. \tag{50}$$

On eliminating h and V by means of formulas (46) and (34), we find

*The calculations in formulas (48) and (49) are for a projectile with a weight equal to unity (Editor's note).

$$[102] \quad \frac{T_1}{T} = \left(1 - \frac{g}{p}\right), \quad (51)$$

i.e., the work done in a gravitational medium by a given mass of explosives M_2 is less than in a gravitationless medium: this difference $\frac{g}{p}$ is the smaller the higher the exhaust velocity of the gases or the greater the pressure p . For example, under the conditions of note 41 the loss is only $1/10$, while the utilization, according to (51), is 0.9. When $p = g$, or when the projectile hovers in the air, lacking even a constant velocity, the loss will be complete (1) and the utilization will be zero. The utilization will also be zero if the projectile has a constant horizontal velocity.

52. In note 41 we found $V_2 = 9990$ m/sec. Applying formula (46) to this case, we find $h = 565$ km; this means that during the explosion the projectile will travel far beyond the limits of the atmosphere and at the same time acquire a velocity of 9990 m/sec.

Note that this velocity is less than that in a gravitationless medium by 1110 m/sec or exactly $1/10$ of the velocity in a gravitationless medium (22).

Hence it is clear that the loss of velocity obeys the same law as the loss of work (51). Strictly, this also follows from formula (34) which, after transformation, yields

$$V_2 = V \left(1 - \frac{g}{p}\right), \text{ or } V - V_2 = V \cdot \frac{g}{p}.$$

From (51) we find

$$T = T_1 \cdot \left(\frac{p}{p-g}\right), \quad (56)$$

where T_1 is the work done on the projectile by the explosives in a [103] gravitational medium with an acceleration equal to g .

In order for the projectile to perform the necessary work of climbing, overcoming atmospheric resistance, and acquiring the desired velocity, the total work done must equal T_1 .

Having calculated all these forms of work, we find T from formula (56). Knowing T , we can calculate V , i.e., the velocity in a gravitationless medium, from the formula

$$T = M_1 \cdot \frac{V^2}{2g}.$$

Knowing V , we can also calculate the required mass of explosives from formula (16). Thus, we find

$$M_2 = M_1 \left[e^{\sqrt{\frac{T_1 p}{T_2 (p-g)}}} - 1 \right].$$

In the calculations, for the sake of brevity, $\left(M_1 \frac{V^2}{2g} \right)$ has been replaced by T_2 .

Thus, knowing the mass of the projectile M_1 , together with all it contains apart from the fuel M_2 the mechanical work T_2 done by explosives when their mass is equal to that of

the projectile M_1 , the work T_1 , which must be done by the projectile during its vertical ascent, the acceleration due to the explosion p and gravity g , we can also determine the amount of explosives M_2 required to lift the mass M_1 of the projectile.

The ratio $\frac{T_1}{T_2}$ in the formula will not change if we reduce it by [104] M_1 , so that T_1

and T_2 may be construed as the mechanical work T_1 done by a unit mass of the projectile and the mechanical work T_2 done by a unit of explosives, respectively.

In general, the gravity g may be construed as the sum of the accelerations due to gravity and the resistance of the medium. But gravity steadily decreases with increasing distance from the Earth's center, so that an increasing fraction of the mechanical work of the explosives is utilized. On the other hand, atmospheric resistance, while very insignificant in comparison with the weight of the projectile, as we shall see, reduces the utilization of the energy of the explosives.

Further, it can be seen that the latter losses, which continue for some time as the projectile races through the atmosphere, are abundantly offset by the gain due to the decrease in gravitational attraction at the considerable distances (500 km) at which the explosion ceases.

Thus, formula (20) can be boldly applied to the vertical flight of a projectile, despite the complications due to the variation in gravity and the resistance of the atmosphere $g = 9.8$.

Gravitational Field. Vertical Return to Earth

59. First let us consider the process of stopping in a gravitationless medium or a momentary halt in a gravitational medium.

Suppose, for example, that, owing to the force produced by the explosion of some (not all) of the gases, a rocket acquires a velocity of 10,000 m/sec (22). Now in order to stop it, we must give it the same velocity but in the opposite direction. Clearly, in accordance with (22), the remaining amount of explosives must be five times greater than the mass M_1 of the projectile. Therefore, on completion of the first part of the explosion (in order to acquire translational velocity) the projectile must have a supply of explosives, the mass of which may be expressed as $5M_1 = M_2$.

60. The total mass including the explosives will be $M_2 + M_1 = 5M_1 + M_1 = 6M_1$. This mass $6M_1$ must have been given a velocity of 10,000 m/sec by the original explosion, and this requires an additional amount of explosives which should also be five times greater (22) than [105] the mass of the projectile plus the mass of the explosives needed to stop the rocket, i.e., $6M_1 \times 5$; thus we obtain $30 M_1$ which, together with the explosives needed for stopping the rocket, makes $35 M_1$.

Using the symbol $q = \frac{M_2}{M_1}$ to denote the number of times the mass of the explosives

exceeds the mass of the projectile, we may express as follows the above reasoning concerning the total mass of explosives $\frac{M_3}{M_1}$ needed to acquire and annihilate a given velocity as follows:

$$\frac{M_3}{M_1} = q + (1 + q) \cdot q = q(2 + q),$$

or, adding and subtracting one from the second part of this equation, we obtain

$$\frac{M_3}{M_1} = 1 + 2q + q^2 - 1 = (1+q)^2 - 1. \quad (61)$$

whence we find

$$\frac{M_3}{M_1} + 1 = (1+q)^2. \quad (62)$$

This last expression is easy to remember.

If q is very small, the amount of explosives is approximately $2q$ (because q^2 will be negligible), i.e., twice as much as needed solely for acquiring a given velocity.

63. On the basis of the above formulas and table (22) we compile the following table:

[106]

V, m/sec	$\frac{M_2}{M_1}$	$\frac{M_3}{M_1}$	V, m/sec	$\frac{M_2}{M_1}$	$\frac{M_3}{M_1}$
543	0.1	0.21	11 800	7	63
1 037	0.2	0.44	12 500	8	80
1 493	0.3	0.69	13 100	9	99
1 915	0.4	0.96	13 650	10	120
2 308	0.5	1.25	17 100	19	399
3 920	1	3	17 330	20	440
6 260	2	8	19 560	30	960
7 880	3	15	22 400	50	2 600
9 170	4	24	26 280	100	10 200
10 100	5	35	30 038	193	37 248
11 100	6	48			

[107] It is evident from this table that if we wanted to acquire and lose a very high velocity an impossibly large supply of explosives would be needed.

From (62) and (16) we have

$$\frac{M_3}{M_1} + 1 = e^{\frac{-2V}{V_1}}, \text{ or } \frac{M_3}{M_1} = e^{\frac{-2V}{V_1}} - 1.$$

Note that the ratio $-\frac{2V}{V_1}$ is positive, because the velocities of the projectile and the gases are opposite in direction and therefore differ in sign.

64. If we are in a gravitational medium, then, in the simple case of vertical motion, the process of coming to a halt descending to Earth will be as follows: when, owing to its acquired velocity, the rocket has risen to a certain altitude and stopped there, its earthward fall will begin.

When the projectile reaches the point in its flight where the action of the explosives ceased, it is subjected again to the action of the remainder in the case direction and order. Clearly, when the explosives cease to act and the entire supply is consumed, the rocket will come to a halt at the Earth's surface, whence the flight began. The method of ascent is exactly the same as the method of descent, the only difference being that the velocities are reversed at every point along the path.

Coming to a halt in a gravitational field requires more work and explosives than in a gravitationless medium, and therefore q [in formulas (61) and (62)] must be greater.

Denoting this greater value of q by q_1 , on the basis of the foregoing, we find that

$$\frac{q}{q_1} = \frac{T_1}{T} = 1 - \frac{g}{p}, \quad (65)$$

whence

$$[108] \quad q_1 = q \left(\frac{p}{p-g} \right);$$

substituting q_1 for q in equation (62), we obtain

$$\frac{M_4}{M_1} = (1 + q_1)^2 - 1 = \left(1 + \frac{pq}{p-g} \right)^2 - 1, \quad (66)$$

here M_4 denotes the amount or mass of explosives needed to ascend from a given point and return to the same point for a rocket coming to a complete stop and traveling in a gravitational medium.

67. On the basis of this last formula we can compile the following table, assuming that $p/g = 10$, i.e., that the pressure of the explosives is 10 times greater than the weight of the rocket together with the remaining explosives.

Gravitational Field. Oblique Ascent

68. Although a vertical ascent would appear to be more expedient, since the atmosphere is then traversed more rapidly and the projectile rises to a greater height, the work done in rising through the atmosphere is very insignificant compared with the total work done by the explosives and, moreover, given an oblique ascent it is possible to construct a permanent observatory that would travel for an indeterminate length of time around the Earth, like the Moon, beyond the limits of the atmosphere. Furthermore, and most important, in an oblique ascent far more of the explosive energy is utilized than in a vertical ascent. Let us first consider the special case of horizontal rocket flight [Fig. 2].

[109]

In a Gravitational Field

V, m/sec	$\frac{M_2}{M_3}$	$\frac{M_4}{M_1}$
543	0.1	0.235
1 497	0.3	0.778
2 308	0.5	1.420
3 920	1.0	4.457
6 260	2	9.383
7 880	3	17.78
9 170	4	28.64
10 100	5	41.98
11 100	6	57.78
11 800	7	76.05

Denoting by R the resultant of the horizontal acceleration of the rocket, by p the acceleration due to the explosion, and by g the acceleration due to gravity, we have

$$R = \sqrt{p^2 - g^2} . \quad (70)$$

[110] On the basis of the latter formula,* the kinetic energy acquired by the projectile during time t equals

$$\frac{R}{2} \cdot t^2 \cdot \left(\frac{R}{g}\right) = \frac{R^2}{2g} \cdot t^2 = \frac{p^2 - g^2}{2g} \cdot t^2 , \quad (71)$$

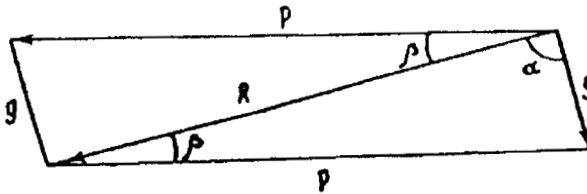

Figure 2

where t is the explosion time. This is also the total useful work done on the rocket. In fact, if we assume the direction of gravity to be constant (which in practice is true only for a short trajectory) the rocket does not climb at all. The work done by the explosives on the rocket in a gravitationless medium is**

*Here Tsiolkovskiy calculates the work done by the resultant referred to unit weight of the rocket (Editor's note).

**Tsiolkovskiy calculates the work done by the reaction force referred to unit weight of the rocket (Editor's note).

$$\frac{p}{2} t^2 = \frac{p^2 t^2}{2g} \tag{72}$$

Dividing the useful work (71) by the total work (72), we obtain [111] the efficiency for horizontal flight.

$$\left(\frac{p^2 - g^2}{2g} \cdot t\right) : \left(\frac{p^2}{2g} \cdot t\right) = 1 - \left(\frac{g}{p}\right)^2 \tag{73}$$

As before, the air resistance has not yet been taken into account.

From this last formula it is evident that the loss of work as compared with a gravitationless medium may be expressed by $\left(\frac{g}{p}\right)^2$. Hence it follows that this loss is much smaller than during a vertical ascent. Thus, for example, if $\frac{g}{p} = 1/10$, the loss will be 1/100 or 1%, whereas in a vertical ascent it would be expressed by $\frac{g}{p}$, i.e., would equal 1/10, that is, 10%.

74. Here is a table in which β is the angle of inclination of the force p to the horizon.

Horizontal Motion

$\frac{p}{g}$	$\left(\frac{g}{p}\right)^2$	$\frac{g}{p}$	β°
1	1	1	90
2	1 : 4	1 : 2	30
3	1 : 9	1 : 3	19.5
4	1 : 16	1 : 4	14.5
5	1 : 25	1 : 5	11.5
10	1 : 100	1 : 10	5.7
100	1 : 10 000	1 : 100	0.57

[112] **Oblique Ascent. Work done in Lifting the Projectile Referred to the Work in a Gravitationless Medium. Loss of Work.**

75. Now let us solve the general problem—for any angle of inclination of the resultant R . A horizontal trajectory or resultant is undesirable, since a projectile flying horizontally must travel a vastly greater distance through the atmosphere and do a correspondingly greater amount of work in cutting through the air.

Thus, let us keep in mind that α , the angle of inclination of the resultant to the vertical, is greater than a right angle; we have

$$R = \sqrt{p^2 + g^2 + 2pg \cos \gamma} \tag{76}$$

where $\gamma = \alpha + \beta$ (obtuse angle of parallelogram) in accordance with the sketch.

Further

$$\gamma = \alpha + \beta ; \sin \alpha : \sin \beta : \sin \gamma = p : g : R \quad (77)$$

and

$$\cos \alpha = \frac{R^2 + g^2 - p^2}{2Rg} . \quad (78)$$

The kinetic energy is expressed by the formula (71), where R is found from equation (76). The vertical acceleration of the resultant R

$$R_1 = \sin (\alpha - 90^\circ) R = -\cos \alpha R. \quad (79)$$

[113] Therefore, the work done in lifting the projectile will be

$$\frac{R_1}{2} t^2 = \frac{-\cos \alpha}{2} R t^2 , \quad (80)$$

where t is the explosion time for the entire supply of explosives. The total work done on the projectile in a gravitational medium [in accordance with (71) and (80)]

$$T_1 = \frac{R^2}{2g} t^2 - \frac{R t^2 \cos \alpha}{2} = \frac{R t^2}{2} \left(\frac{R}{g} - \cos \alpha \right) . \quad (81)$$

Here ascent of the projectile through unit height in a medium with an acceleration of one g is taken as the unit of work. If $\alpha \gg 90^\circ$, in the case of the ascent of the projectile, for example, then $(-\cos \alpha)$ is positive, and vice versa.

In a gravitationless medium the work will be $\frac{P^2}{2g} t^2 = T$ in accordance with (72), (let

us not forget that the explosion time t is independent of the gravitational forces).

Taking the ratio of these two values of the work, we obtain the efficiency of the explosion as compared with its efficiency in a gravitationless medium, namely:

$$\frac{T_1}{T} = \frac{R t^2}{2} \left(\frac{R}{g} - \cos \alpha \right) : \left(\frac{P^2}{2g} t^2 \right) = \frac{R}{p} \left(\frac{R}{p} - \frac{g}{p} \cos \alpha \right) . \quad (82)$$

Eliminating R in accordance with formula (76), we find

$$[114] \quad \frac{T_1}{T} = 1 + \frac{g^2}{p^2} + 2 \cos \gamma \cdot \frac{g}{p} - \cos \alpha \cdot \frac{g}{p} \sqrt{1 + \frac{g^2}{p^2} + 2 \cos \gamma \frac{g}{p}} .$$

Formulas (51) and (73), for example, are merely special cases of this formula, as may be readily ascertained.

84. We shall now find a use for this formula. Assume that a rocket is ascending at an

angle of 14.5° to the horizon; the sine of this angle is 0.25; this means that the atmospheric resistance is four times greater than the value for vertical flight, since it is more or less inversely proportional to the sine of the angle of inclination ($\alpha - 90^\circ$) of the trajectory to the horizontal.

85. The angle $\alpha = 90 + 14 \frac{1}{2} = 104 \frac{1}{2}^\circ$; $\cos \alpha = 0.25$; knowing a we can also find β . In fact, from (77) we find

$$\sin \beta = \sin \alpha \frac{g}{p}$$

thus, if $\frac{g}{p} = 0.1$;

$$\sin \beta = 0.0968; \beta = 5 \frac{1}{2}^\circ,$$

whence

$$\gamma = 110^\circ, \cos \gamma = 0.342.$$

Now we calculate the efficiency to be 0.966. The loss is 0.034 or about $\frac{1}{20}$ or, more accurately, 3.4%.

This loss is one-third of the loss in a vertical ascent, not a bad result, especially if we consider that, even in an oblique ascent ($14 \frac{1}{2}^\circ$), the atmospheric resistance is still less than 1% of the work done in lifting the projectile.

[115]

Oblique Motion

Degrees				Utilization	Loss
$\alpha-90$	α	β	$\gamma=\alpha+\beta$		
0	90	$5 \frac{3}{4}$	$95 \frac{2}{3}$	0.9900	1 : 100
2	92	$5 \frac{2}{3}$	$97 \frac{2}{3}$	0.9860	1 : 72
5	95	$5 \frac{2}{3}$	$100 \frac{2}{3}$	0.9800	1 : 53
10	100	$5 \frac{2}{3}$	$105 \frac{2}{3}$	0.9731	1 : 37
15	105	$5 \frac{1}{2}$	$110 \frac{1}{2}$	0.9651	1 : 29
20	110	$5 \frac{1}{3}$	$115 \frac{1}{3}$	0.9573	1 : 23.4
30	120	5	125	0.9426	1 : 17.4
40	130	$4 \frac{1}{3}$	$134 \frac{1}{3}$	0.9300	1 : 14.3
45	135	4	139	0.9246	1 : 13.3
90	180	0	180	0.9000	1 : 10

[116] 86. We propose the above table for various approaches: the first column shows the inclination to the horizontal; the last column, the loss of work; β is the deviation of the direction of the pressure exerted by the explosives from the actual line of motion (69).

87. For very small angles of inclination ($\alpha-90^\circ$) the formula can be much simplified, by replacing the trigonometric values by their arcs and making other simplifications.

We then obtain the following expression for the loss of work:

$$x^2 + \delta x \left(1 - \frac{x}{2}\right) + \delta^2 x^2 \left(x - \frac{\delta}{2}\right),$$

where δ denotes the angle of inclination ($\alpha - 90^\circ$), expressed as the length of its arc, the radius of white is equal to unity, and x denotes the ratio g/p . On discarding the small quantities of higher orders, we obtain for the loss

$$x^2 + \delta x = \left(\frac{g}{p}\right)^2 + \delta \frac{g}{p}.$$

Let us put $\delta = 0.02 N$, where 0.02 is the part of a circle corresponding to roughly 1° ($1/7$) and N is the number of these new degrees. Then the loss of work may be roughly expressed as

$$\frac{g^2}{p^2} + 0.02 \frac{g}{p} N.$$

From this formula we can readily compile the following table, assuming that

$$\frac{g}{p} = 0.1 :$$

[117]

N	0	0.5	1	2	3	4	5	6	10
Loss	1/100	1/91	1/83	1/70	1/60	1/55	1/50	1/45	1/33

Hence we see that even at large angles (up to 10°) the discrepancy between this table and the previous, more accurate one is quite small.

We could have considered many other factors too: the work done by gravity, the resistance of the atmosphere; we still have not explained how the explorer could spend a long, even unlimited, time in an environment without even a trace of oxygen. We have not even mentioned the heating of the projectile during its short flight through the atmosphere, nor have we given a general picture of the flight itself and of the extremely interesting phenomena that would (theoretically) accompany it. We have scarcely outlined the magnificent prospects of eventually attaining this still distant goal. Lastly, we could also have considered the subject of rocket trajectories in outer space.

Document I-6

Document title: Hermann Oberth, Rockets in Planetary Space, Translation of "Die Rakete zu den Planetenräumen," Verlag von R. Oldenbourg, Munich and Berlin, 1923, NASA TT F-9277, December 1964, Introduction.

Hermann Oberth was born in Transylvania, but considered himself German. In this publication he was the first person to outline many of the fundamentals of spaceflight and to ground them in mathematics and engineering. He proposed that a rocket could be launched to orbit the Earth and that it could travel through the vacuum of space. He also addressed the subject of various rocket fuels and proposed a large rocket that used alcohol and liquid hydrogen as propellant. Oberth's work served as the inspiration for many later pioneers in Germany, particularly Wernher von Braun.

Oberth later refined his proposals in the book *Wege zur Raumschiffahrt* (*Ways to Space-flight*), which later served as the basis for the spaceship depicted in Fritz Lang's 1929 motion picture *Frau im Mond* (*The Girl in the Moon*). This was the public's first exposure to a realistic spacecraft on the movie screen.

[1]

Section 1. Introduction

1. Given the present state of science and technology, it is possible to build machines which can climb higher than the limits of the atmosphere of the earth.

2. With additional refinement, these machines will be able to attain such velocities that, left to themselves in space, they need not fall back to the earth's surface, and they may even leave the field of gravitation of the earth.

3. These machines can be so constructed that men can be lifted in them, apparently with complete safety.

4. Given certain economical situations, the construction of such machines may even become profitable. Such conditions may prevail within a few decades.

In this work, I intend to prove these four statements. I will first derive some formulas which will give us the necessary theoretical insight into the manner of functioning and the performance capability of these machines. In Part II, I will show that their construction is technically possible, and in Part III I will come to a discussion of the prospects for their invention.

I have strived to be brief. I have been able frequently to simplify the mathematical derivations and formulas by using approximated values, which are easy to use mathematically, for certain quantities. This procedure was used especially when, in the course of a discussion, the facts of a matter could be made more clear. (Incidentally, I have also frequently indicated the actual value of the result, or at least shown how it could be determined from the approximated value, and sometimes I have simply estimated the error.) Technical problems, the solution of which no one doubts, have been covered only briefly. In Part III, I have limited myself to indications, since the subjects treated here still lie rather far off.

It has been my purpose here to cover no more than seemed necessary for an understanding of the invention and for an evaluation of the feasibility, because:

Firstly, it is by no means my intent here to describe a particular model of a machine with all its details, but only to show that machines of this sort are possible. (For example, I need not calculate the exact altitude which a certain rocket might reach if I can show that it is at least possible of meeting the minimum demands placed upon it. Thus I set a constant value c on [2] the exhaust velocity (cf. page 3), even though this value can vary in some cases by as much as 9%, and I discussed the case in which the rocket travels at a velocity of v (cf. page 6), even though the fuel is not consumed most efficiently at this speed. If I estimate the power of the rocket, based upon v and the most unfavorable value of c , and find that the rocket is capable under these circumstances of attaining a required final velocity and altitude, then I have also shown that, in actuality, it can surely attain them.) I believe that the entire picture is clearer if I do not go into too much detail.

Secondly, there are some things which I wish not to reveal (particularly technical solutions which appear favorable), because these are not protected literary property. If my ideas should one day be put into practice, I will naturally want to furnish the exact plans, computations and methods of computation.

Finally, I make no secret of the fact that I consider some of the provisions, in their present form, as by no means being definitive solutions. As I worked out my plans and computations, I naturally had to consider each detail. In so doing, I could at least determine

mine that there were no insurmountable difficulties. At the same time, however, it was clear to me that some individual questions could be solved only after the most basic special studies and experimentation lasting perhaps years, at least if the optimum solution were sought.

Document I-7

Document title: Robert H. Goddard, *A Method of Reaching Extreme Altitudes*, Smithsonian Miscellaneous Collections, Volume 71, Number 2 (Washington, DC: Smithsonian Institution Press, 1919). The plates have been omitted from these documents.

Document I-8

Document title: "Topics of the Times," *New York Times*, January 18, 1920, p. 12.

Even before Robert Goddard retreated to New Mexico and began conducting most of his research in seclusion, he rarely published, mostly because of the skepticism and even outright ridicule reflected in the *New York Times* story printed here. His paper, *A Method of Reaching Extreme Altitudes*, was published as part of the Smithsonian Institution's Miscellaneous Collections series, and was a relatively standard scientific publication that would impress colleagues but few others. The first edition was bound in brown paper and numbered 1,750 copies, of which Goddard received 90 complimentary ones. The publication went unnoticed for eight days before suddenly becoming front-page news in several newspapers, including the *Boston American*, the *New York Times*, the *Milwaukee Sentinel*, and the *San Francisco Examiner*. The stories focused exclusively on the most esoteric part of the study, a proposal for traveling to the Moon, which had been played up in an accompanying press release from the Smithsonian. The furor in response to this proposal angered Goddard, particularly since he felt his concept of a rocket itself was being maligned. The controversy did attract the attention of a misinformed editor of the *New York Times*, who derided Goddard's lack of knowledge about ordinary physics. Contrary to the editor's claims, Goddard's speculation on the operation of a rocket in a vacuum was widely accepted at the time, and proved sound in later application.

Document I-7

Preface

The theoretical work herein presented was developed while the writer was at Princeton University in 1912-1913, the basis of the calculations being the assumption that, if nitrocellulose smokeless powder were employed as propellant in a rocket, under such conditions as are here explained, an efficiency of 50 percent might be expected.

Actual experimental investigations were not undertaken until 1915-1916, at which time the tests concerning ordinary rockets, steel chambers and nozzles, and trials *in vacuo*, were performed at Clark University. The original calculations were then repeated, using the data from these experiments, and both the theoretical and experimental results were submitted, in manuscript, to the Smithsonian Institution, in December 1916. This manuscript is here presented in the original form, save for the notes at the end which are now added.

A grant of \$5000 from the Hodgkins Fund, Smithsonian Institution, under which work is being done at present, was advanced toward the development of a reloading, or multiple-charge rocket, herein explained in principle, and this work was begun at the Worcester Polytechnic Institute in 1917, and was later undertaken as a war proposition. It

was continued, from June 1918 up to very nearly the time of signing of the Armistice, at the Mount Wilson Observatory of the Carnegie Institution of Washington, where most of the experimental results were obtained....

[1]

Outline

A search for methods of raising recording apparatus beyond the range for sounding balloons (about 20 miles) led the writer to develop a theory of rocket action, in general, taking into account air resistance and gravity. The problem was to determine the minimum initial mass of an ideal rocket necessary, in order that on continuous loss of mass, a final mass of one pound would remain, at any desired altitude.

An approximate method was found necessary, in solving this problem, in order to avoid an unsolved problem in the calculus of variations. The solution that was obtained revealed the fact that surprisingly small initial masses would be necessary (Table VII) *provided the gases were ejected from the rocket at a high velocity*, and also provided that *most of the rocket consisted of propellant material*. The reason for this is, very briefly, that the velocity enters *exponentially* in the expression for the initial mass. Thus if the velocity of the ejected gases be increased fivefold, for example, the initial mass necessary to reach a given height will be *reduced to the fifth root* of that required for the lesser velocity. (A simple calculation shows at once the effectiveness of a rocket apparatus of high efficiency.)

It was obviously desirable to perform certain experiments: First, with the object of finding just how inefficient an ordinary rocket is, and second, to determine to what extent the efficiency could be increased in a rocket of new design. The term "efficiency" here means the ratio of the kinetic energy being calculated from the average velocity of ejection, which was obtained indirectly by observations on the *recoil* of the rocket.

It was found that not only does the powder in an ordinary rocket constitute but a small fraction of the total mass ($\frac{1}{4}$ or $\frac{1}{5}$), but that, furthermore, the efficiency is only 2 percent, the average velocity of ejection being about 1000 ft/sec (Table I). This was true [2] even in the case of the Coston ship rocket, which was found to have a range of a quarter of a mile.

Experiments were next performed with the object of increasing the average velocity of ejection of the gases. Charges of dense smokeless powder were fired in strong steel chambers, these chambers being provided with smooth tapered nozzles, the object of which was to obtain the work of expansion of the gases, much as is done in the de Laval steam turbine. The efficiencies and velocities obtained in this way were remarkably high (Table II), the highest efficiency, or rather "duty," being over 64 percent, and the highest average velocity of ejection being slightly under 8000 ft/sec, which exceeds any velocity hitherto attained by matter in appreciable amounts.

These velocities were proved to be real velocities, and not merely effects due to reaction against the air, by firing the same steel chambers *in vacuo*, and observing the recoil. The velocities obtained in this way were not much different from those obtained in air (Table III).

It will be evident that a heavy steel chamber, such as was used in the above-mentioned experiments, could not compete with the ordinary rocket, even with the high velocities which were obtained. If, however, *successive charges* were fired in the *same chamber*, much as in a rapid-fire gun, *most of the mass of the rocket could consist of propellant*, and the superiority over the ordinary rocket could be increased enormously. Such reloading mechanisms, together with what is termed a "primary and secondary" rocket principle, are the subject of certain United States Patents. Inasmuch as these two features are self-evidently operative, it was not considered necessary to perform experiments concerning them, in order to be certain of the practicability of the general method.

Regarding the heights that could be reached by the above method: an application of the theory to cases which the experiments show must be realizable in practice indicates that a mass of one pound could be elevated to altitudes of 35, 72, and 232 miles, by employing initial masses of from 3.6 to 12.6, from 5.1 to 24.3, and from 9.8 to 89.6 lb, respectively

(Table VII). If a device of the Coston ship-rocket type were used instead, the initial masses would be of the order of magnitude of *those above, raised to the 27th power*. It should be understood that if the mass of the recording instruments alone were one pound, the entire final mass would be 3 or 4 pounds.

[3] Regarding the possibility of recovering apparatus upon its return, calculations show that the times of ascent and descent will be short, and that a small parachute should be sufficient to ensure safe landing.

Calculations indicate, further, that with a rocket of high efficiency, consisting chiefly of propellant material, it should be possible to send small masses even to such great distances as to escape the earth's attraction.

In conclusion, it is believed that not only has a new and valuable method of reaching high altitudes been shown to be *operative in theory*, but that the experiments herein described *settle all the points upon which there could be reasonable doubt*.

The following discussion is divided into three parts: Part I, theory; Part II, experiments; Part III, calculations, based upon the theory and the experimental results.

Importance of the Subject

The greatest altitude at which soundings of the atmosphere have been made by balloons, namely, about 20 miles, is but a small fraction of the height to which the atmosphere is supposed to extend. In fact, the most interesting, and in some ways the most important, part of the atmosphere lies in this unexplored region, a means of exploring which has, up to the present, not seriously been suggested.

A few of the more important matters to be investigated in this region are the following: the density, chemical constitution, and temperature of the atmosphere, as well as the height to which it extends. Other problems are the nature of the aurora, and (with apparatus held by gyroscopes in a fixed direction in space) the nature of the α , β , and γ radioactive rays from matter in the sun as well as the ultraviolet spectrum of this body.

Speculations have been made as to the nature of the upper atmosphere—those by Wegener¹ being, perhaps, the most plausible. By estimating the temperature and percentage composition of the gases present in the atmosphere, Wegener calculates the partial pressures of the constituent gases, and concludes that there are four rather distinct regions or spheres of the atmosphere in which certain gases predominate: the troposphere, in which are the clouds; the stratosphere, predominatingly nitrogen; the hydrogen sphere; and the [4] geocoronium sphere. This highest sphere appears to consist essentially of an element, "geocoronium," a gas undiscovered at the surface of the earth, having a spectrum which is the single aurora line, 557 $\mu\mu$, and being 0.4 as heavy as hydrogen. The existence of such a gas is in agreement with Nicholson's theory of the atom, and its investigation would, of course, be a matter of considerable importance to astronomy and physics as well as to meteorology. It is of interest to note that the greatest altitude attained by sounding balloons extends but one-third through the second region, or stratosphere.

No instruments for obtaining data at these high altitudes are herein discussed, but it will be at once evident that their construction is a problem of small difficulty compared with the attainment of the desired altitudes.

[5]

Part I. Theory

Method to Be Employed

It is possible to obtain a suggestion as the method that must be employed from the fundamental principles of mechanics, together with a consideration of the conditions of the problem. We are at once limited to an apparatus which reacts against matter, this matter being carried by the apparatus in question. For the entire system we must have: First,

1 A. Wegener, *Phys. Zeitscher.* 12, pp. 170-178, 214-222, 1911.

action in accordance with Newton's third law of motion; and, second, energy supplied from some source or sources must be used to give kinetic and potential energy to the apparatus that is being raised; kinetic energy to the matter which, by reaction, produces the desired motion of the apparatus; and also sufficient energy to overcome air resistance.

We are at once limited, since subatomic energy is not available, to a means of propulsion in which jets of gas are employed. This will be evident from the following consideration: First, the matter which, by its being ejected furnishes the necessary reaction, must be taken with the apparatus in reasonably small amounts. Second, energy must be taken with the apparatus in as large amounts as possible. Now, inasmuch as the maximum amount of energy associated with the minimum amount of matter occurs with chemical energy, both the matter and the energy for reaction must be supplied by a substance which, on burning or exploding, liberates a large amount of energy, and permits the ejection of the products that are formed. An ideal substance is evidently smokeless powder, which furnishes a large amount of energy, but does not explode with such violence as to be uncontrollable.

The apparatus must obviously be constructed on the principle of the rocket. An ordinary rocket, however, of reasonably small bulk, can rise to but a very limited altitude. This is due to the fact that the part of the rocket that furnishes the energy is but a rather small fraction of the total mass of the rocket; and also to the fact that only a part of this energy is converted into kinetic energy of the mass which is expelled. It will be expected, then, that the ordinary rocket is an inefficient heat engine. Experiments will be described below which show that this is true to a surprising degree.

[6] By the application of several new principles, an efficiency manyfold greater than that of the ordinary rocket is possible; experimental demonstrations of which will also be described below. Inasmuch as these principles are of some value for military purposes, the writer has protected himself, as well as aerological science in America, by certain United States Patents, of which the following have already been issued: Nos. 1,102,653, 1,103,503, 1,191,299, 1,194,496.

The principles concerning efficiency are essentially three in number. The first concerns thermodynamic efficiency, and is the use of a smooth nozzle, of proper length and taper, through which the gaseous products of combustion are discharged. By this means the work of expansion of the gases is obtained as kinetic energy, and also complete combustion is ensured.

The second principle is embodied in a reloading device, whereby a large mass of explosive material is used, a little at time, in a small, strong, combustion chamber. This enables high chamber pressures to be employed, impossible in an ordinary paper rocket, and also permits most of the mass of the rocket to consist of propellant material.

The third principle consists in the employment of a primary and secondary rocket apparatus, the secondary (a copy in miniature of the primary) being fired when the primary has reached the upper limit of its flight. This is most clearly shown, in principle, in U.S. Patent No. 1,102,653.

By this means the large ratio of propellant material to total mass is kept sensibly the same during the entire flight. This last principle is obviously to avoid damage when the discarded casings reach the ground, each should be fitted with a parachute device, as explained in U.S. Patent No. 1,191,299.

Experiments will be described below which show that, by application of the above principles, it is possible to convert the rocket from a very inefficient heat engine into the most efficient heat engine that ever has been devised.

Statement of the Problem

Before describing the experiments that have been performed, it will be well to deduce the theory of rocket action in general, in order [7] to show the tremendous importance of efficiency in the attainment of very high altitudes. A statement of the problem will

therefore be made, which will lead to the differential equation of the motion. An approximate solution of this equation will be made for the initial mass required to raise a mass of one pound to any desired altitude, when said initial mass is a minimum.

A particular form of ideal rocket is chosen for the discussion as being very amenable to theoretical treatment, and at the same time embodying all of the essential points of the practical apparatus. Referring to Fig. 1, a mass H , weighing 1 lb is to be raised as high as possible in a vertical direction¹⁰ by a rocket formed of a cone P , of propellant material, surrounded by a casing K . The material P is expelled downward with a constant velocity c . It is further supposed that the casing K drops away continuously as the propellant material P burns, so that the base of the rocket always remains plane. It will be seen that this approximates to the case of a rocket in which the casing and firing chamber of a primary rocket are discarded after the magazine has been exhausted of cartridges, as well as to the case in which cartridge shells are ejected as fast as the cartridges are fired.

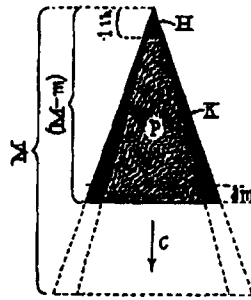

Fig. 1

[8] Let us call

- M = the initial mass of the rocket
- m = the mass that has been ejected up to the time t
- v = the velocity of the rocket, at time t
- c = the velocity of ejection of the mass expelled
- R = the force, in absolute units, due to air resistance
- g = the acceleration of gravity
- dm = the mass expelled during the time dt
- k = the constant fraction of the mass dm that consists of casing K , expelled with zero velocity relative to the remainder of the rocket
- dv = the increment of velocity given the remaining mass of the rocket

The differential equation for this ideal rocket will be the analytical statement of Newton's third law, obtained by equating the momentum at a time t to that at the time $t + dt$, plus the impulse of the forces of air resistance and gravity,

$$(M - m)v = dm(1 - k)(v - c) + vk dm + (M - m - dm)(v + dv) + [R + g(M - m)] dt$$

If we neglect terms of the second order, this equation reduces to

$$c(1 - k) dm = (M - m) dv + [R + g(M - m)] dt \quad (1)$$

A check upon the correctness of this equation may be had from the analytical expression for the conservation of energy, obtained by equating the heat energy evolved by the burning of the mass of propellant, $dm(1 - k)$, to the additional kinetic energy of the system

produced by this mass plus the work done against gravity and air resistance during the time dt . The equation thus derived is found to be identical with Eq. (1).

Reduction of Equation to the Simplest Form

In the most general case, it will be found that R and g are most simply expressed when in terms of v and s . In particular, the [9] quantity R , the air resistance of the rocket at time t , depends not only upon the density of the air and the velocity of the rocket, but also upon the cross section S at the time t . The cross section S should obviously be as small as possible; and this condition will be satisfied *at all times*, provided it is the following function of the mass of the rocket $(M - m)$,

$$S = A(M - m)^{2/3} \tag{2}$$

where A is a constant of proportionality. This condition is evidently satisfied by the ideal rocket, Fig. 1. Equation (2) expresses the fact that the shape of the rocket apparatus is at all times similar to the shape at the start; or, expressed differently, S must vary as the square of the linear dimensions, whereas the mass $(M - m)$ varies as the cube. Provision that this condition may approximately be fulfilled is contained in the principle of primary and secondary rockets.

The resistance R may be taken as independent of the length of the rocket by neglecting "skin friction." For velocities exceeding that of sound this is entirely permissible, provided the cross section is greatest at the head of the apparatus, as shown in U.S. Patent No. 1,102,653.

The quantities R , g , and a are evidently expressible most simply in terms of the altitude s , provided the cross section S is also so expressed, giving, in place of Eq. (1),

$$c(1-k)dm = (M - m)dv + \frac{1}{v(s)}[R(s) + g(s)(M - m)]ds \tag{3}$$

Rigorous Solution for Minimum M at Present Impossible

The success of the method depends entirely upon the possibility of using an initial mass M of explosive material that is not impracticably large. It amounts to the same thing, of course, if we say that the mass ejected up to the time t (i.e. m) must be a minimum, conditions for the existence of a minimum being involved in the integration of the equation of motion.

That a minimum mass m exists when a required mass is to be given an assigned upward velocity at a given altitude is evident intuitively from the following consideration: If, at an intermediate altitude, the velocity of ascent be very great, the air resistance R (depending upon the square of the velocity) will also be great. On the other hand, if the velocity of ascent be very small, force will be required to overcome gravity for a long period of time. In both cases the mass necessary to be expelled will be excessively large.

[10] Evidently, then, the velocity of ascent must have some special value at each point of the ascent. In other words, it is necessary to determine an unknown function $f(s)$, defined by

$$v = f(s)$$

such that m is a minimum.

It is possible to put $f(s)$ and $(df(s)/ds) ds$ in place of v and dv , in Eq. (3), and to obtain m by integration. But in order that m shall be a minimum δm must be put equal to zero, and the function $f(s)$ determined. The procedure necessary for this determination presents a new and unsolved problem in the calculus of variations.

Solution of the Minimum Problem by an Approximate Method

In order to obtain a solution that will be sufficiently exact to show the possibilities of the method, and will at the same time avoid the difficulties involved in the employment of the rigorous method just described, use may be made of the fact that if we divide the altitude into a large number of parts, let us say n , we may consider the quantities R , g , and also the acceleration, to be *constant over each interval*.

If we denote by a the constant acceleration defined by $v = at$ in any interval, we shall have, in place of the equation of motion (3), a linear equation of the first order in m and t , as follows:

$$\frac{dm}{dt} = \frac{(M-m)(a+g)+R}{c(1-k)}$$

the solution of which, on multiplying and dividing the right number of $(a+g)$, is

$$\begin{aligned} m &= e^{\left[-\frac{a+g}{c(1-k)}t\right]} \cdot \frac{M(a+g)+R}{a+g} \left\{ \int e^{\left[\frac{a+g}{c(1-k)}t\right]} \cdot \left[\frac{a+g}{c(1-k)}\right] dt + C \right\} \\ &= e^{\left[-\frac{a+g}{c(1-k)}t\right]} \cdot \frac{M(a+g)+R}{a+g} \left\{ e^{\left[\frac{a+g}{c(1-k)}t\right]} + C \right\} \end{aligned} \quad (4)$$

where C is an arbitrary constant.

This constant is at once determined as -1 from the fact that m must equal zero when $t = 0$.

We then have

$$m = \left(M + \frac{R}{a+g} \right) \left\{ 1 - e^{\left[-\frac{a+g}{c(1-k)}t\right]} \right\} \quad (5)$$

This equation applies, of course, to each interval, R , g , and a , being considered constant. We may make a further simplification if, [11] for each interval, we *determine what initial mass M would be required when the final mass in the interval is one pound*. The initial mass at the beginning of the first interval, or what may be called the "total initial mass," required to propel the apparatus through the n intervals will then be the *product of the n quantities* obtained in this way.

If we thus place the final mass $(M-m)$, in any interval equal to unity, we have $M = m + 1$ and when this relation is used in Eq. (5), we have for the mass at the beginning of the interval in question

$$M = \frac{R}{a+g} \left\{ e^{\left[\frac{a+g}{c(1-k)}t\right]} - 1 \right\} + e^{\frac{a+g}{c(1-k)}t} \quad (6)$$

Now the initial mass that would be required to give the one pound mass the same velocity at the end of the interval, if R and g had both been *zero*, is from (6),

$$M = e^{\frac{at}{c(1-k)}} \quad (7)$$

The ratio of Eq. (6) to Eq. (7) is a measure of the additional mass that is required for overcoming the two resistances R and g , and when this ratio is least, we know that M is a

minimum for the interval in question. The "total initial mass" required to raise one pound to any desired altitude may thus be had as the product of the minimum M 's for each interval obtained in this way.

From Eqs. (6) and (7) we see at once the importance of high efficiency, if the "total initial mass" is to be reduced to a minimum. Consider the exponent of e . The quantities a , g , and t depend upon the particular ascent that is to be made, whereas $c(1 - k)$ depends entirely upon the efficiency of the rocket, c being the velocity of expulsion of the gases, and k the fraction of the entire mass that consists of loading and firing mechanism, and of magazine. In order to see the importance of making $c(1 - k)$ as large as possible, suppose that it were decreased tenfold. Then

$$e^{\frac{a+g}{c(1-k)}t}$$

would be raised to the 10th power; in other words, the mass for each interval would be the original value multiplied by itself ten times.

[12]

Part II. Experiments

Efficiency of Ordinary Rocket

The average velocity of ejection of the gases expelled from two sizes of ordinary rocket were determined by a ballistic pendulum. The smaller rockets C , Fig. 1, averaged 120 gm, with a powder charge of 23 gm; and the larger, S , the well-known Coston ship rocket, weighed 640 gm, with a powder charge of 130 gm. Fig. 2, shows the rockets as compared with a yardstick Y .

The ballistic pendulum, was a massive compound pendulum weighing 70.64 kg (155 lb) with a half period of 4.4 sec; large compared with the duration of discharge of the rockets. The efficiencies were obtained from the average velocity of ejection of the gases, found by the usual ballistic-pendulum method, together with the heat value of the powder of the rockets, obtained by a bomb calorimeter for the writer by a Worcester chemist.

The results of these experiments are given in Table I. It will be seen from the table that the efficiency of the ordinary rocket is close to 2 percent;¹¹ slightly less for the smaller, and slightly more for the larger, rockets, and also that the average velocity of the ejected gases is of the order to 1000 ft/sec. It was found by experiment that a Coston ship rocket, lightened to 510 gm by the removal of the red fire, had a range of a quarter of a mile, the highest point of the trajectory being slightly under 490 ft. A range as large as this is rather remarkable in view of the surprisingly small efficiency of this rocket.

Table I

Type of rocket	Efficiency	Mean efficiency	Velocity corresponding to mean efficiency
Common	2.54%	1.86%	957.6 ft/sec
Common	1.45		
Common	1.40		
Common	1.95		
Coston ship	1.75%	2.21%	1029.25 ft/sec
Coston ship	2.27		
Coston ship	2.62		

[13] *Experiments in Air with Small Steel Chambers*

An apparatus was next constructed, with a view to increasing the efficiency, embodying three radical changes, namely, the use of smokeless powder, of much higher heat value than the black powder employed in ordinary rockets; the use of a strong steel chamber, to permit employment of high pressures; and the use of a tapered nozzle, similar to a steam turbine nozzle, to make available the work of expansion.

Two sizes of chamber were used, one 1/2-in. diameter, and one 1-in. diameter. The inside and outside diameters of the smaller chamber, Fig. 2a, were, respectively, 1.28 cm and 3.63 cm. The nozzle, polished until very smooth, was of 8° taper, and was adapted to permit the use of two extensions of different lengths. The length of the chamber, as the distance *l* in the figure will be called, could be altered by putting in or removing cylindrical tempered-steel plugs of various lengths, held in place by the breechblock....

Two small chambers were used, practically identical in all respects, one of the soft tool steel, and one of best selected nickel-steel gun-barrel stock, treated to give 100,000 lb tensile strength, for which the writer wishes to express his indebtedness to the Winchester Repeating Arms Company.

Table II

<i>Small</i>							
<i>Experiment no.</i>	<i>Chamber</i>	<i>Length of chamber l</i> <i>cm</i>	<i>Total mass M</i> <i>gm</i>	<i>Length of nozzle</i> <i>cm</i>	<i>Kind of powder</i>	<i>Mass of powder</i> <i>gm</i>	<i>Mass of wadding and wire</i> <i>gm</i>
1	Soft steel	0.69	3,540.1	Medium	Du Pont	0.7795	0.0345
2	Soft steel	0.69	3,541.9	Medium	Du Pont	0.7060	0.0385
3	Soft steel	1.01	3,538.8	Medium	Du Pont	1.0025	0.0370
4	Soft steel	0.69	3,541.9	Medium	Infallible	0.8247	0.0395
5	Soft steel	1.01	3,538.8	Medium	Infallible	1.2015	0.0380
6	Soft steel	0.69	3,547.9	Short	Du Pont	0.7074	0.0370
7	Soft steel	0.69	3,540.1	Short	Infallible	0.8533	0.0370
8	Soft steel	0.69	3,540.1	Short	Du Pont	0.6825	0.0355
9	Soft steel	1.01	3,645.8	Long	Infallible	1.2397	0.0370
10	Soft steel	1.01	3,645.8	Long	Du Pont	0.9625	0.0365
11	Soft steel	0.69	3,648.93	Long	Du Pont	0.7361	0.0386
12	Soft steel	0.69	3,533.9	Medium	Infallible	0.8985	0.0391
13	Soft steel	0.69	3,645.8	Long	Infallible	0.9068	0.0396
14	Soft steel	0.69	3,533.9	Medium	Du Pont	0.7465	0.0373
29	Nickel steel	0.69	3,553.5	Medium	Infallible	1.0264	0.0445
44	Nickel steel	1.01	6,273.5	Medium	Infallible	1.2731	0.0420
46	Nickel steel	0.69	6,270.5	Medium	Infallible	1.4849	0.0402
<i>Large</i>							
51	Chrome-nickel steel	2.28	19,324.0	16.29	Du Pont	8.0522	0.3184
52	Chrome-nickel steel	2.28	19,324.0	16.29	Infallible	9.0259	0.3271

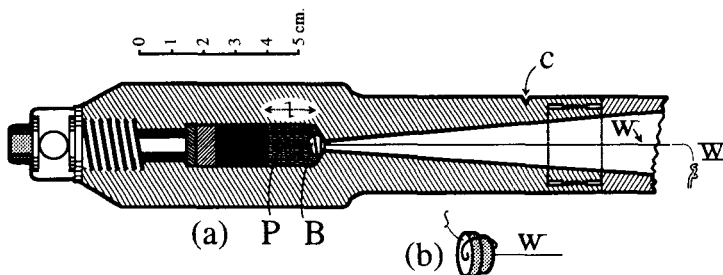

Fig. 2

The charge of powder *P*, Fig. 2, was fired electrically, by a hot wire in the following way: A fine copper wire *w*, 0.12-mm diameter, passed through the wadding, Fig. 2*b*, consisting of two disks of stiff cardboard, and this copper wire joined a short length of platinum or platenoid wire of 0.1-mm diameter *f*, extending across the inner [14] part of the

chamber

Displacement			Length of pendulum	Velocity		Efficiency
d_1	d_2	corrected d		km/sec	ft/sec	
cm	cm	cm	cm			percent
11.55	11.41	11.62	79.15	1.781	5,843	39.01
10.30	10.19	10.35	79.15	1.738	5,703	37.16
15.80	15.70	15.85	79.15	1.907	6,257	44.73
13.60	13.50	13.65	79.15	1.976	6,484	37.13
20.55	20.46	20.59	79.50	2.082	6,832	41.88
9.43	9.38	9.45	79.50	1.585	5,203	30.93
12.59	12.53	12.62	79.50	1.766	5,793	30.12
9.35	9.31	9.37	79.50	1.626	5,336	32.54
20.18	20.10	20.22	79.50	2.045	6,709	40.39
14.20	14.10	14.25	79.50	1.834	6,018	41.38
10.22	10.10	10.28	79.50	1.704	5,592	35.74
13.90	13.83	13.94	79.50	1.850	6,069	33.05
13.85	13.80	13.87	79.50	1.882	6,177	34.24
10.07	10.00	10.10	79.50	1.609	5,279	31.38
17.95	17.85	18.00	79.50	1.969	6,460	37.44
12.58	12.38	12.68	79.50	2.127	6,981	43.73
14.78	14.68	14.93	79.50	2.154	7,064	44.78

chamber

		5.02		2.290	7,515	64.53
		7.08		2.434	7,987	57.25

wadding, in contact with the powder. To the other end of this platinum wire, a short length of the copper wire passed to the side of the wadding, and made electrical contact with the wall of the chamber. A fine steel wire W , 0.24 mm in diameter, served to pull the copper wire w tightly enough to prevent contact of the latter with the nozzle. The wire W was so held that, although it exerted a pull on the wire w , it nevertheless offered no resistance in the direction of motion of the ejected gases.

Two dense smokeless powders were used: Du Pont pistol powder No. 3, a very rapid dense nitrocellulose powder, and Infallible shotgun powder, of the Hercules Powder Company. The heat values in all cases were found by bomb calorimeter.¹ All determinations were made in an atmosphere of carbon dioxide, in order to avoid any heat due to the oxygen of the air. The average heat values were the following:

Powder, in ordinary rocket	545.0 cal/gm
Powder, in Coston ship rocket	528.3
Du Pont Pistol No. 3	972.5
Infallible	1238.5

The ballistic pendulum used in determining the average velocity of ejection, for the small chambers, consisted essentially of a plank B , carrying weights, and supporting the chamber, or gun, C , in a horizontal position. This plank was supported by fine steel wires in such a manner that it remained horizontal during motion. In order to make certain that the plank actually was horizontal in all positions, a test was frequently made by mounting a small vertical mirror on the plank, with its plane perpendicular to the axis of the gun, and observing the image of a horizontal object—as a lead pencil—held several feet away while the pendulum was swinging. Current for firing the charge was led through two drops of mercury to wires on the plank. A record of the displacements was made by a stylus consisting of a steel rod S , pointed and hardened at the lower end. This rod slid freely in a vertical brass sleeve, attached to the under side of the plank, and made a mark upon a smoked-glass strip G . In this way the first backward and forward displacements of the pendulum were recorded, and the elimination of friction was thereby made possible.

The data and results of these experiments are given in Table II, in which d is the displacement corrected for friction.

[15] The velocities and efficiencies were obtained from the usual expression for the velocity in which a ballistic pendulum, with the bob constantly horizontal, is used, namely,

$$[16] \quad v = \frac{M}{m} \sqrt{2gl(1 - \cos \theta)}$$

where M = the total weight of the bob

m = the mass ejected; powder plus wadding

l = the length of the pendulum

θ = the angle through which the pendulum swings

g = the acceleration of gravity

The cosine of θ was corrected for friction by observing the two first displacements d_1 and d_2 and obtaining therefrom

$$d = d_1 \sqrt{\frac{d_1}{d_2}}$$

It will be noticed that the highest velocity was obtained with Infallible powder, and

1. It was found necessary to use a sample exceeding a certain mass, as otherwise the heat value depended upon the mass of the sample.

was over 7000 ft/sec. The corresponding efficiency was close to 50 percent. In view of the fact that this velocity, corresponding to c in the exponents of Eqs. (6) and (7), is sevenfold greater than for an ordinary rocket, it is easily seen that the employment of a chamber and nozzle such as has just been described must make an enormous reduction in initial mass as compared with that necessary for an ordinary rocket....

[17] *Experiments with Large Chamber*

Inasmuch as all the steel chambers employed in the preceding experiments were of the same internal diameter (1.26 cm), it was considered desirable that at least a few experiments should be performed with a larger chamber, first, in order to be certain that a large chamber is operative; and second, to see if such a chamber is not even more efficient than a small chamber. This latter is to be expected for the reason that heat and frictional losses should increase as the *square* of the linear dimensions of the chamber; and hence increase in a less proportion than the mass of powder that can be used with safety, which will vary as the *cube* of the linear dimensions. Evidence in support of this expectation has already been given. Thus, for ordinary rockets, the larger rocket has the higher efficiency, as evident from Table I.

The large chamber was of nickel-alloy steel (Samson No. 3A), of 115,000 lb tensile strength, for which the writer takes opportunity of thanking the Carpenter Steel Company. This chamber had inside diameter, and diameter of throat, both twice as large as those of the chambers previously used; the thickness of wall of the chamber and the taper of the nozzle were, however, the same. The inside of the nozzle was well polished. Figure 3 shows a section of the chamber; the outer boundary being indicated by dotted lines, P being the powder, and W the wadding. It will be noticed that the wadding is just twice the size of that previously used....

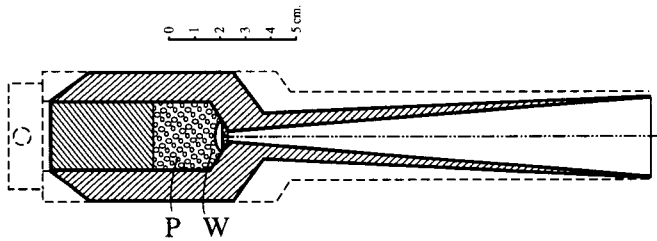

Fig. 3

The chamber was held in the lower end of a [18] 3 1/2-ft length of 2-in. pipe P by setscrews. Within this pipe, above the chamber, was fastened a length of 2-in. steel shafting, to increase the mass of the movable system. This system was supported by 1/2-in. steel pin E .

On firing, the recoil lifted the above system vertically upward against gravity, the extent of this lift, or displacement, being recorded by a thin lead pencil, slidable in a brass sleeve set in the pipe at right angles to the pin E . The point of the pencil was pressed against a vertical cardboard C by the expelled gases will be called the "direct-lift" method; and the theory is given in Appendix A.

Although rebound of the gases from the ground would probably have been negligible, such rebound was eliminated by a short plank D , covered with a piece of heavy sheet iron, and supported at an angle of 45° with the horizontal. This served to deflect the gases to one side.

The results of two experiments, 51 and 52, with this large chamber, are given in Table II. In experiment 51, with Du Pont powder, the powder was packed rather loosely. Any increase in internal diameter was inappreciable, certainly under 0.01 mm. In experiment 52, the Infallible powder was somewhat compressed. After firing, the chamber was found to be slightly bulged for a short distance around the middle of the powder chamber, the

inside diameter being increased from 2.6 cm to 2.7 cm, and the outside diameter from 5.08 cm to 5.14 cm. The efficiency (64.53 percent) in experiment 51 and the velocity (7987 ft/sec) in experiment 52 were, respectively, the highest obtained in any of the experiments.

The conclusions to be drawn from these two experiments are, first, that large chambers can be operated, under proper conditions, [19] without involving undue pressures; and second, that large chambers, even with comparatively short nozzles, are more efficient and give higher velocities than small chambers.

It is obvious that large grains of powder should be used in large chambers if dangerous pressures are to be avoided. The bulging in experiment 52 is to be explained by the grains of powder being too small for a chamber of the size under consideration. It is possible, however, that pressures even as great as that developed in experiment 52 could be employed in practice provided the chamber were of "built-up" construction. A similar result might possibly be had if several shots had been fired, of successively increasing amounts of powder. The result of this would have been a hardening of the wall of the chamber by stretching. Such a phenomenon was observed with the soft-steel chamber already described, which was distended by the first few shots of Infallible powder, but thereafter remained unchanged with loads as great as those first used.¹²

Experiments in Vacuo

Introductory

Having obtained average velocities of ejection up to nearly 8000 ft/sec in air, it remained to determine to what extent these represented reaction against the air in the nozzle, or immediately beyond. Although it might be supposed that the reaction due to the air is small, from the fact that the air in the nozzle and immediately beyond is of small mass, it is by no means self-evident that the reaction is zero. For example, when dynamite, lying on an iron plate, is exploded, the particles which constituted the dynamite are moved very rapidly upward, and the reaction to this motion bends the iron plate downward; but reaction of the said particles against the air as they move upward may also play an important role in bending the iron. The experiments now to be described were undertaken with the view of finding to what extent, if any, the "velocity in air" was a fictitious velocity. The experiments were performed with the smaller soft tool-steel and nickel-steel chambers that have already been described.

Method of Supporting the Chamber in Vacuo

For the sake of convenience, the chamber, or gun, should evidently be mounted in a vertical position, so that the expelled gases are shot downward, and the chamber is moved upward by the reaction, either being lifted bodily, or suspended by a spring and set in vibration.

[20] The whole suspended system was therefore designed to be contained in a 3-in. steel pipe, all the essential parts being fastened to a cap, fitting on the top of this pipe. This was done not only for the sake of convenience in handling the heavy chamber, but also from the fact that the only joint that would have to be made airtight for each shot would be at the 3-in. cap.

The means of supporting the chamber from the cap is shown in Plate 6, Fig. 2, and Plate 7, Fig. 1, the apparatus being shown dismantled in Plate 7, Fig. 2. Two $\frac{3}{8}$ -in. steel rods *R, R* were threaded tightly by taper (pipe) threads into the cap *C*. These rods were joined by a yoke, at their lower ends, which served to keep them always parallel. Two collars, or holders, *H* and *H'*, free to slide along the rods *R, R*, held the chamber or gun, by three screws in each holder. The inner ends of the screws of the lower holder were made conical, and these fitted into conical depressions *c*, Fig 2*a* [page 349], drilled in the side of

the gun, so that the lower holder could thus be rigidly attached to the gun. This was made necessary in order that lead sleeves, fitting the gun and resting upon the lower holder *H'*, could be used to increase the mass of the suspended system. Three such sleeves were used, the two largest being molded around thin steel tubes which closely fitted the gun. The rods *R, R* were lubricated with Vaseline. Two $\frac{1}{8}$ -in. steel pins were driven through the rods *R, R*, just above the yoke *Y*, in order that the latter could not be driven off by the fall of the heavy chamber and weights when direct lift was employed.

In the experiments in which the chamber and lead sleeves were suspended by a spring, the latter was hooked at its upper end to a screw eye fixed in the cap *C*. The lower end of the spring was hooked through a small cylinder of fiber. A record of the displacements of the suspended system was made by a stylus *S*, Plate 6, Fig. 2, in the upper holder *H*. This stylus was kept pressed against a long narrow strip of smoked glass *G* by a spring of fine steel wire. This strip of smoked glass was held between two clamps, fastened to a rod, the upper end of which was secured to the cap *C*, and the lower end to the yoke *Y*. Except for the largest charges used, it was possible to measure the displacements on both sides of the zero position, and thereby to calculate the decrement and eliminate friction.

When the chamber was suspended by a spring, a deflection as large as a centimeter was unavoidably produced merely by placing the cap *C* on the 3-in. pipe or removing it, although, in all cases the [21] system would return to within 1 mm (usually much less than this) of the zero position after being displaced. In order to avoid any such displacement as that just mentioned, an eccentric clamp *K*, Plate 7, Fig. 1, was employed to keep the suspended system rigidly in its zero position during assembling and dismounting the apparatus.

This clamp consisted of an eccentric rod *K*, free to turn in a hold in the cap *C*, the lower end being held in a bearing in the yoke *Y*. Through the upper end of this rod was pinned a small rod *K'*, at right angles to *K*. The surface of the rod *K* was smeared with a mixture of beeswax, resin, and Venice turpentine; and the hole in the cap through which *K* projected was rendered airtight by wax of the same composition.

The suspended system was assembled while the cap *C* was held by a support touching its under side. When the assembling was complete, the wax was heated by a small alcohol blowtorch until it was soft, then a rubber band was slipped around the rod *K'* and the outlet pipe *E*. A trial showed that the cap could now be put in place on the pipe and removed, without the suspended system moving appreciably. After the cap *C* was in position on the pipe, the rubber band was removed, and the wax heated until the rod *K* could be turned out of engagement with the holders *H, H'*. After a shot had been fired, the clamp was again placed in operation until the system had been taken from the 3-in. pipe and the smoked glass removed.

The circuit which carried the electric current to ignite the charge consisted of the insulated wire *W*, Plate 7, Fig. 1, which passed through a tapered plug of shellacked hard fiber, in the cap *C*, thence through a glass tube to the yoke *Y*, to which it was fastened. Below the yoke it was wrapped with insulating tape, except at the lower end where it was shaped to hold the 0.24-mm steel wire, attached to the fine copper wire from the wadding. From the chamber the current passed up the rods *R, R* and out of the cap, around which was wrapped a heavy bare copper wire *V*, which together with *W*, constituted the terminals of the circuit. It should be mentioned, in passing, that a small amount of black powder *B*, Fig. 2*a* [page 349], placed over the platinum fuse wire on the wadding, was found necessary as a primer in order to ignite dense smokeless powders *in vacuo*.

In order to make the joint between the cap and the pipe airtight during a determination, the following device was adopted. The outside of the cap *C* and also a locknut were both turned down to the same diameter. The locknut was made fast to the pipe. These were [22] then painted on the outside with melted wax consisting of equal parts beeswax and resin with a little Venice turpentine.

When a determination was to be made, the cap was screwed into position, a wide rubber band was slipped over the junction between cap and locknut, and the outside of this rubber band was heated with an alcohol blast torch. The result was a joint, for all

practical purposes, absolutely airtight, which could, nevertheless, be dismantled at once after pulling off the rubber band.

Theory of the Experiments in Vacuo

The expressions for the velocity of the expelled gases are easily obtained for the two types of motion of the suspended system that were employed, namely, simple harmonic motion produced by a spring, and direct lift.

Simple harmonic motion. Results obtained with simple harmonic motion (slightly damped, of course) were naturally more accurate than with direct lift, as it was impossible in the latter case to eliminate friction. The theory, for simple harmonic motion, in which account is taken of friction is described in Appendix B. The spring was one made to specifications, particularly as regards the magnitude of the force per-centimeter-increase-in-length by the Morgan Spring Company of Worcester, Massachusetts. Care was taken to make certain that in no experiment was the extension of the spring reduced to such a low value as not to lie upon the rectilinear line part of the calibration curve.

Direct lift. The theory of the motion, in this case, has already been given under Appendix A. In this case it might be assumed that a correction could be made for friction by multiplying the displacement s by some particular decrement $\sqrt{d_1/d_2}$ obtained in the experiments with simple harmonic motion, that might reasonably apply. This, as will be shown below, was found to give results in good agreement for the two types of motion, if the direct lift was about 2 cm; but not if it was much larger. It was found that very little frictional resistance was experienced when the mass M was raised by hand, provided the axis of the gun were kept strictly vertical, but a very considerable resistance was experienced if the axis was inclined to one side so that the holders H, H' rubbed against the rods R, R . This sidewise pressure did not take place when the spring was used. It was also found that the trace upon the smoked glass was always slightly sinuous, with direct lift, and [23] straight with the spring. The simple harmonic motion was, therefore, much the more preferable, but could not be used when the powder charges were large.

Means of Eliminating Gaseous Rebound

It should be remembered that the real object of the vacuum experiments is to ascertain what the reaction experienced by the chamber would be, if a given charge of powder were fired in the chamber many miles above the earth's surface. A container is therefore necessary, which, for the purpose at hand, approaches most nearly a container of unlimited capacity. A length of 3-in. pipe, closed at the ends, is evidently unsuitable, because the gas, fired from one end, is sure to rebound from the other end with considerable velocity, and hence to produce a much larger displacement than ought really to be observed. Moreover, any tank of finite size must necessarily produce a finite amount of rebound, from the fact that the whole action is equivalent to liberating suddenly, in the tank, 1 or 2 liters of gas at atmospheric pressure.

There are two possible methods for reducing the velocity of the gas sufficiently to produce a negligible rebound: a *disintegration method*, whereby the stream is broken up into many small streams, sent in all directions (i.e. virtually reconverted into heat); and second, a *friction method*, whereby the individual stream remains moving in one direction, but is gradually slowed down by friction against a solid surface.

As will be shown below, accurate results were obtained by the first method, in what may be called the "cylindrical" tank; and these results were checked satisfactorily by the second method, in what will be called the "circular" tank.

The cylindrical tank was 10 ft 5 in. high and weighed about 500 lb. It consisted of a 6-ft length T , Fig. 4 and Plate 8, Fig. 1, of 12-in. steel pipe, with threaded caps on the ends. Entering the upper cap at a slight angle was the 3-in. pipe P , 4 $\frac{1}{2}$ ft long, which supported the cap C of Plate 6, Fig. 2, and Plate 7, Fig. 1. The 12-in. pipe was sawn across at the dotted

line T_0 , so that any device could be placed in the interior of this tank, or removed from it, as desired. The upper section of the tank was lifted off as occasion demanded by a block and tackle. The two ends to be joined were first painted with the wax previously described; and after the tank had been assembled, the joint was painted on the outside with the same wax W , and the entire tank thereafter painted with asphalt varnish.

[24]

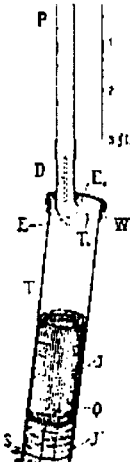

Fig. 4

This tank was used under three conditions:

1. Tank empty, with the elbow E to direct the gas into a swirl such that the gas, while in motion, would not tend to return up the pipe P . In this case some rebound was to be expected from this elbow. This expectation was realized in practice.

2. Tank empty, and elbow cut off along the dotted line E_0 . In this case, more rebound was to be expected than in Case 1, which was borne out in practice.

3. Elbow E cut at E_0 , and tank half filled with $\frac{1}{2}$ -in. square-mesh wire fencing. Two separate devices constructed of this wire fencing were used one above the other. The gas first passed through an Archimedes spiral J , of 2-ft fencing, comprising eight turns, [25] held apart by iron wires bound into the fencing. This construction allowed most of the gas to penetrate the spiral to a considerable distance before being disturbed, and, of course, eliminated regular reflection. This second device J' , placed under the first, consisted of a number of 12-in. circular disks of the same fencing, bound to two $\frac{1}{4}$ -in. iron rods Q by iron wires. These disks were spaced 1 in. apart. The three upper disks were single disks, the next lower two were double, with the strands extending in different directions, the next two were triple, and the lowest disk of all, 2 in. from the bottom of the tank, was composed of six individual disks. This lower device necessarily offered large resistance to the passage of the gas; yet strong rebound from any part of it was prevented by the spiral just described. With this third arrangement, small rebound was to be expected, which also was borne out in practice.

This tank was exhausted by way of a stopcock at its lower end, S ; and air was also admitted through this same stopcock.

The circular tank, Plate 8, Fig. 2, was 10 ft high and weighed about 200 lb. It consisted of a straight length of 3-in. pipe, carefully fitted, and welded autogenously, to a 4-ft. 3-in. U-pipe. The straight pipe entered the U-pipe on the inner side of the latter, and at as sharp an angle as possible. Another similar U-pipe was bolted to the first by flanges, with $\frac{1}{16}$ -in. sheetrubber packing between.

In this tank, the gases were shot down the straight pipe, entered the upper U-pipe at

a small angle, thus avoiding any considerable rebound, and thence passed around the circular part—not returning up the straight pipe until the velocity had been greatly reduced by friction.

In order to make the time, during which the velocity was being reduced, as long as possible, the pipes were carefully cleaned of scale. They were first pickled, and then cleaned by drawing through them, a number of times; first, a scraper of sheet iron; second, a stiff cylindrical bristle brush, and finally a cloth. All but the most firmly adhering scale was thereby removed. Further, care was taken to cut the hole in the rubber washers, between the flanges, so wide that compression by the flanges would not spread the rubber into the pipe and thereby obstruct the flow of gas.

Notwithstanding all these precautions, evidence was had that the gases became stopped very rapidly. This was to be expected inasmuch as there is solid matter, namely, the wadding and wire, that is [26] ejected with the gas, which accumulates with each successive shot. This solid matter must offer considerable frictional resistance to motion along the U-pipe, and, since the mass of gas is only of the order of a gram, must necessarily act to stop the flow in a very short time. This interval of time was great enough, however, so that this second method afforded a satisfactory check upon the first method.

A possible modification of the above two methods would have been to provide some sort of trapdoor arrangement whereby the gases, after having been reduced in speed in a container as just described, would have been prevented from returning upward into the 3-in. pipe *P* by this trap, which would be sprung at the instant of firing. In this way gaseous rebound would be entirely eliminated. It was found, however, that results with the two methods already described could be checked sufficiently to make this modification unnecessary.

The tanks were exhausted by a rotary oil pump, No. 1, of the American Rotary Pump Company, supported by a water jet pump. In this way the pressure in the cylindrical tank could be reduced to 1.5 mm of mercury in 25 minutes and to the same pressure in the circular tank, in 10 minutes. The pressures employed in the experiments ranged from 7.5 mm to 0.5 mm.

Methods of Detecting and Measuring Gaseous Rebound

With the two tanks used in the experiments, it was obviously impossible to eliminate gaseous rebound entirely, from the fact that, even if the velocity of the bases is reduced to zero, there still remains the effect of introducing suddenly a certain quantity of gas into the tank. It became necessary, then, to devise some means of detecting, and, if possible, of measuring, the extent of the rebound.

Three devices were employed, one for detecting a *force* of rebound, and two for measuring the magnitude of the *impulse per unit area* produced by the rebounding gas. These latter devices, from the fact that quantitative measurements were possible with them, will be called "impulse meters."

Tissue-paper Detector

The detector for indicating the force of the rebound consisted of a strip of delicate tissue paper *I*, Plate 6, Fig. 2, and text figure 5*a*, 0.02 mm thick, with its ends glued to an iron wire *W*, as shown in Fig. 5*a*. This iron wire was fastened to the yoke *Y*, Plate 7, Fig. 1, and held the tissue paper, with its plane horizontal, between the chamber and the wall of the 3-in. pipe *P*. In many of [27] the experiments, the paper was cut one-third the way across in two places before being used, as shown by the dotted lines *b* in Fig. 5*a*. Since the tissue paper has very little mass, the tearing depends upon the magnitude of the force that is momentarily applied, and not upon the force times its duration—i.e. the impulse of the force. The tissue paper will tear, then, if the force produced by the first upward rush of gas, past the chamber into the space in the 3-in. pipe above the chamber, exceeds a certain value. This first upward rush of gas will, of course, produce a greater force than any subse-

quent rush, as the gas is continually losing velocity. Even though the magnitude of the force that will just tear the tissue paper be not known, it may safely be assumed that if the first upward rush does not tear the paper, the force due to rebound that acts upon the gun must be small compared with the impulse produced by the explosion of the powder.

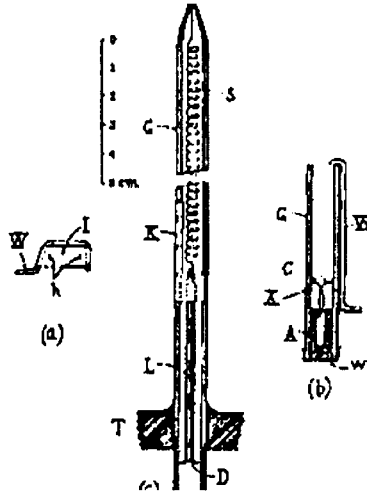

Fig. 5

[28] It should be noted that the tissue paper tells nothing as to whether or not there are a number of successive reflections or rebounds gradually decreasing in magnitude; neither does it give information concerning the *downward* pressure the gases exert upon the chamber tending to decrease the displacement, after they have accumulated in the space between the top of the chamber and the cap C, Plate 6, Fig. 2.

Direct-lift Impulse Meter

A section of the direct-lift impulse meter is shown in Fig. 5*b*. It is also shown in the photograph Plate 6, Fig. 2, at A. A small cylinder A of aluminum of 1.46 gm mass, hollowed at one end for lightness, was turned down to slide easily in a glass tube G. This tube G was fastened by de Khotinsky cement to an iron wire W, which was in turn fastened to the yoke Y, Plate 7, Fig. 1, so that the glass tube G was held in a vertical position, between the chamber and the wall of the 3-in. pipe—similarly to the tissue paper. Two small wires C, C of spring brass were cemented to the top of the aluminum cylinder, the free ends just touching on opposite sides of the glass tube. The inside of the glass tube was smoked with camphor smoke above the point marked X, so that a record was made of any upward displacement of the aluminum cylinder. The cylinder was prevented from dropping out of the glass tube by a fine steel wire w cemented to the tube and extending across the lower end.

The theory of the direct-lift impulse meter is given in Appendix C. From the theory, we may derive an expression for the ratio Q of the momentum given the gun by the gaseous rebound, to the observed momentum of the suspended system.

There are two disadvantages of this form of impulse meter. First, friction acts unavoidably to reduce the displacement. Second, any jar to which the apparatus is subjected on firing will cause the aluminum cylinder to jump, and thus give a spurious displacement. This latter fact rendered the meter useless for experiments in which direct lift of the cham-

ber took place, as there was always much jar when the heavy chamber fell back, after being displaced upward.

This impulse meter, it will be observed, gave a mean measurement of any successive up-and-down rushes of gas.

[29] Spring Impulse Meter

A section of the spring impulse meter is shown in Fig. 5c. The apparatus consisted of an aluminum disk *D*, cemented to a lead rod *L*, of combined mass 5.295 gm, supported by a fine brass spiral spring *S*. The disk *D* was of a size sufficient to slide easily in a glass tube *G*. The upper end of the spring protruded through a small hole in the glass tube, and was fastened at this point by de Khotinsky cement, it thus being easy to make the top of the

[30]

Table III

<i>Experiment no.</i>	<i>Type of motion</i>	<i>Length of chamber l cm</i>	<i>Total mass M + 1/3 m gm</i>	<i>Length of nozzle</i>	<i>Kind of powder</i>	<i>Mass of powder gm</i>	<i>Mass of wadding and wire gm</i>	<i>Mass of black powder gm</i>
15	S.H.M.	0.69	3156.9	Long	Du Pont	0.6747	0.0538	0.007
16	S.H.M.	0.69	3156.9	Long	Du Pont	0.6761	0.0526	0.007
17	S.H.M.	0.69	3156.9	Long	Du Pont	0.6913	0.0508	0.007
18	S.H.M.	0.69	3156.9	Long	Du Pont	0.6929	0.0536	0.007
19	S.H.M.	0.69	3158.9	Long	Du Pont	0.6741	0.0529	0.007
20	S.H.M.	0.69	3156.9	Long	Du Pont	0.7161	0.0516	0.007
21	S.H.M.	0.69	3156.9	Long	Du Pont	0.6495	0.0536	0.007
22	S.H.M.	0.69	3156.9	Long	Du Pont	0.6679	0.0568	0.007
23	S.H.M.	0.69	3156.9	Long	Du Pont	0.6681	0.0537	0.007
24	S.H.M.	0.69	3156.9	Long	Du Pont	0.6693	0.0556	0.007
25	S.H.M.	0.69	2768.1	Medium	Du Pont	0.6998	0.0504	0.007
26	S.H.M.	0.69	2768.1	Medium	Du Pont	0.6715	0.0530	0.007
27	S.H.M.	0.69	2353.8	Short	Du Pont	0.6686	0.0510	0.007
28	S.H.M.	0.69	2353.8	Short	Du Pont	0.6673	0.0510	0.007
30	S.H.M.	0.95	3339.6	Medium	Infallible	0.9186	0.0556	0.010
31	Lift	0.95	2020.7	Medium	Infallible	0.9210	0.0518	0.012
32	Lift	0.95	2020.7	Medium	Infallible	0.9210	0.0601	0.020
33	Lift	0.95	2020.7	Medium	Infallible	0.9210	0.0625	0.020
34	Lift	0.95	2020.7	Medium	Infallible	0.9210	0.0648	0.020
35	S.H.M.	0.95	3339.6	Medium	Infallible	0.9210	0.0614	0.020
36	S.H.M.	0.95	3339.6	Medium	Infallible	0.9210	0.0639	0.020
37	Lift	0.95	2020.7	Medium	Infallible	0.9210	0.0619	0.020
38	Lift	0.95	2135.7	Long	Infallible	0.9210	0.0672	0.020
39	Lift	0.95	2135.7	Long	Infallible	0.9210	0.0608	0.020
40	Lift	0.69	2023.4	Medium	Du Pont	0.6715	0.0576	0.007
41	Lift	0.69	2023.4	Medium	Du Pont	0.6715	0.0599	0.007
42	Lift	0.95	1914.3	Short	Infallible	0.9210	0.0551	0.020
43	Lift	0.95	2020.7	Medium	Infallible	0.9210	0.0641	0.020
45	Lift	1.25	2020.7	Medium	Infallible	1.2581	0.0582	0.020
47	Lift	1.42	3040.5	Medium	Infallible	1.4540	0.0603	0.020
48	Lift	1.42	3040.8	Medium	Infallible	1.3997	0.0607	0.020
49	Lift	1.42	2020.7	Medium	Infallible	1.3997	0.0619	0.020
50	Lift	1.57	3039.0	Medium	Infallible	1.5200	0.0630	0.030

lead rod level with the zero of a paper scale K pasted to the outside of the glass tube. A piece of white paper placed behind the tube G made the motion of the lead rod L very clearly discernible.

This impulse meter was placed in a hole in the upper cap of the 12-in. pipe of the cylindrical tank at D , Fig. 4 and Plate 8, Fig. 1, the same distance from the wall of the 12-in. pipe as the center of the 3-in. pipe. It projected 1 in. through the 12-in. cap which was practically the same as the distance the 3-in. pipe projected. The tube G was kept in position in the cap by being wrapped tightly with insulating tape, the joint being finally painted with the wax already described.

The theory of the spring impulse meter is given in Appendix D, where Q is the ratio already defined in connection with the direct-lift impulse meter. There are two reasons why the ratio Q obtained in the Appendix should be larger than the true percentage at the

Displacement			Tank	Pressure in tank		Paper detector	Rebound impulse to total impulse Q	Velocity		Efficiency
d_1	d_2	Corrected d		Before	After			km/sec	ft/sec	
cm	cm	cm		mm	mm		percent			percent
4.58	4.22	4.97	Cylindrical	5.0	5.5	—	0.000	1.711	5614	36.01
4.78	4.70	4.82	Cylindrical	5.0	10.0	Torn	0.756	1.729	5671	36.75
4.68	4.52	4.70	Cylindrical	4.5	9.0	Torn	0.000	1.671	5481	34.33
4.85	4.55	5.01	Cylindrical	7.0	11.2	Torn	0.000	1.774	5821	38.72
4.66	4.37	4.81	Cylindrical	5.5	10.5	Torn	0.000	1.728	5668	36.71
5.00	4.77	5.12	Cylindrical	7.5	13.0	Not torn	0.000	1.683	5524	34.86
4.73	4.45	4.87	Cylindrical	6.5	10.5	Not torn	0.000	1.780	5840	38.97
4.63	4.34	4.78	Circular	1.5	13.5	Not torn	0.560	1.719	5642	36.37
4.43	4.13	4.59	Cylindrical	1.5	5.5	Not torn	0.000	1.653	5423	33.61
4.68	4.48	4.78	Circular	7.5	22.0	Not torn	0.000	1.719	5642	36.38
4.97	4.31	5.33	Circular	1.5	14.5	Not torn	0.000	1.767	5801	38.46
4.70	3.85	5.19	Cylindrical	1.5	5.0	Not torn	0.000	1.749	5740	37.65
5.05	(#20)	5.17	Circular	1.5	13.0	Not torn	—	1.614	5296	32.05
5.10	(#20)	5.22	Cylindrical	1.5	5.5	Not torn	—	1.630	5347	32.67
7.37	(#20)	7.91	Circular	1.5	21.0	Not torn	—	2.405	7893	55.90
4.60	(#25)	4.94	Cylindrical	1.5	7.5	Torn	—	1.997	6550	39.40
5.87	(#20)	5.90	Circular	1.5	21.0	Torn	—	2.191	7189	46.38
5.30	(#25)	5.69	Circular	4.5	25.5	Torn	—	2.127	6980	43.71
5.50	(#25)	5.90	Cylindrical	2.5	8.0	Not torn	—	2.162	7093	45.15
7.22	(#20)	7.39	Cylindrical	1.5	6.0	Not torn	—	2.336	7665	52.73
7.18	(#20)	7.35	Cylindrical	3.5	9.5	Torn	—	2.319	7610	51.96
5.19	(#25)	5.57	Cylindrical	1.5	7.0	Not torn	—	2.106	6911	42.85
4.83	(#25)	5.18	Cylindrical	1.5	7.0	Not torn	—	2.136	7010	44.09
5.07	(#25)	5.45	Cylindrical	1.5	7.0	Not torn	—	2.202	7227	46.86
2.03	(#25)	2.18	Cylindrical	1.5	4.5	Not torn	—	1.797	5897	39.73
1.95	(#25)	2.09	Cylindrical	0.5	3.0	Not torn	—	1.748	5735	37.93
5.70	(#20)	5.83	Cylindrical	1.5	7.0	Torn	—	2.055	6745	40.82
5.37	(#25)	5.76	Cylindrical	1.0	6.0	Not torn	0.326	2.137	7011	44.14
11.38	(#25)	11.65	Cylindrical	1.5	8.0	Not torn	0.677	2.340	7680	52.93
6.50	(#25)	6.98	Cylindrical	1.5	9.0	Torn	0.690	2.318	7606	51.89
6.03	(#25)	6.47	Cylindrical	1.5	8.5	Not torn	0.730	2.314	7593	51.74
13.00	(#25)	13.96	Cylindrical	1.5	8.5	Not torn	0.735	2.257	7404	49.19
7.28	(#25)	7.82	Cylindrical	1.5	9.5	Not torn	0.790	2.332	7653	52.56

top of the 3-in. pipe. In the first place, friction in the 3-in. pipe will decrease the velocity of the rebounding gas; and, further, the disk D , Fig. 5, is fairly tight-fitting in the glass tube G , whereas there is a considerable space between the gun and the 3-in. pipe, through which the gas may pass and, accumulating above, exert a *downward* pressure on the top of the gun.

One important advantage of the spring impulse meter over that employing direct lift is that the former has very little friction, so that the readings are very reliable. Another advantage is that the displacement of the former will include without any uncertainty the effect of any number of rebounds following one another in rapid succession—i.e. the effect of multiple reflections of the gas, if such reflections are present.

Explanation of Table III

In the vacuum experiments, the soft-steel chamber was used for Du Pont powder, and the nickel-steel chamber for Infallible powder.

The three nozzles called short, medium, and long, were respectively, 9.64, 15.88, and 22.08 cm from the throat to the muzzle.

[31] The length of chamber l , in the third column, is taken as the distance shown in Fig. 2*a*.

In the cases of simple harmonic motion in which d_2 is not given in the table, the displacements were so large that d_2 was prevented from reaching its full extent by the yoke Y , Plate 7, Fig. 1. Correction for friction was made in these cases by choosing the decrement from some other experiment that would be likely to apply. The number of this experiment is written in parentheses, in the table, in place of d_2 . The same procedure is followed in the experiments with direct lift.

Of the experiments in the cylindrical tank, 15 and 16 were performed with the elbow E , Fig. 4, at the lower end of the 3-in. pipe; experiment 17 was performed with this elbow also in place, with the addition of a sheet-iron sleeve in the pipe, to decrease the curvature *at the elbow*; experiments 18 and 19 were performed with the tank empty; and the remaining experiments were performed with the fencing, already described, in position.

The tissue paper was usually torn at one end, and not torn completely off. It was only torn completely off, with small charges, in the experiments with the cylindrical tank *empty* (experiments 18 and 19). The tissue paper was cut one-third across at each end, as already explained, in experiments 15 to 33, inclusive.

The direct-lift impulse meter was used in experiments 15 to 26, inclusive. In cases in which there was impact of the chamber against the yoke, or pins, at the lower ends of the rods R , R , plate 6, Fig. 2, this impulse meter was useless because of the jar. Only in experiments 16 and 22 was there a measurable displacement, the negligible displacements in the other cases being doubtless due to friction. The spring impulse meter was used only in the last six vacuum experiments.

An inspection of Tables II and III will show that the results, under the same conditions, are in sufficiently close agreement to warrant the comparison of results obtained under various circumstances of firing.

Discussion of Results

1. There is a general tendency for the velocities in vacuo to be larger than those in air, for the same length of chamber l and the same mass of powder.

With Du Pont powder, the medium and short nozzles give greater velocities in vacuo. The long nozzle, however, does not show results very much different from those obtained in air.

[32] There is a large difference, however, with Infallible powder, with all three nozzles. For the medium nozzle a comparison of experiments 4 to 12, inclusive, with 35 and 36 shows that the increase amounts to 22 percent of the velocity in air.

2. The medium nozzle gives, in general, greater velocities than the short or the long

nozzle with the name length of chamber l and approximately the same charges of powder. In all cases, the abort nozzle gives less velocity than the medium or the long nozzle, which is to be expected.

3. The results show no appreciable dependence of the velocities upon the pressure in the tank between 7.5mm and 0.5mm, and it is safe to conclude that the velocities are practically the same from atmospheric pressure down to zero pressure, except as regards the slight increase of velocity with decreasing pressure already mentioned.

4. A comparison of the results when the chamber moved under the influence of the spring with those in which the chamber was merely lifted, shows that the agreement of results obtained by the two methods is good, provided the displacement in the direct-lift experiment is small (compare experiments 40 and 41 with 26). If, on the other hand, the displacement in the direct-lift experiment is large, this method gives considerably lesser velocities than 37, and 43 makes it evident that all the velocities obtained by experiments in which the lift exceeded 4 cm are from 300 to 600 ft/sec too small. This is a very important conclusion, for it means that the highest velocities in vacuo, recorded in Table III, are doubtless considerably less than those which were actually attained.

5. A comparison of the results obtained by means of the circular tank with those obtained by means of the cylindrical tank shows that the velocities range about 100 ft/sec higher for the circular tank—a difference that is so small as to be well within the accidental variations of the experiments.

Concerning the behavior of the cylindrical tank under different conditions, a comparison of experiments shows that the velocities are much the same for all cases. Hence it is safe to conclude that the rebound, at least for small charges, is not excessive even if an empty tank is used, providing it is sufficiently large.

A check of some interest, on the effectiveness of the cylindrical tank, with the retarder J, J' in position inside, was the sound of the shot, which resembled a sharp blow of a hammer on the lower [33] cap of the 12-in. pipe. The impart was most clearly discernible when the hand was on the lowest part of the tank. The sound, in the case of the circular tank, did not appear to come from any particular part. When the tank was grasped during firing, a throb of the entire tank was noticed.

6. Concerning the proportion of the measured reaction that is due to gaseous rebound, the tissue-paper detector, as has already been explained, does not give any information. All that this detector really shows is that the force exerted by the initial upward rush of gas past the chamber is not excessive. The fact that the tissue paper is sometimes torn and sometimes not under identical conditions of firing, shows either that this force differs more or less in various parts of the tank (i.e., the upward rush of gas is not perfectly homogeneous) or that the tissue paper is weakened by each successive shot. This last explanation is the more probable; for fine particles of the wadding rush upward with the gas, as is proved by fine markings on the smoked glass, and also from the fact that, after a number of shots, the tissue paper is found to be perforated with very small holes.

The gaseous rebound could not be measured accurately with the direct-lift impulse meter. Thus of all the experiments in which this meter could be used, 15 to 26 inclusive, only two, 16 and 22, gave readable displacements; the failure to obtain readable displacements in the other cases being doubtless due to friction, as already mentioned. It will be noticed that the impulse is under 1 percent.

The spring impulse meter used in the last five experiments gave reliable results because of the very slight friction during operation. This impulse meter shows that, if the momentum of the chamber were to be corrected for gaseous rebound, this correction would be much less than 1 percent of the momentum of the chamber. But as has been stated above, the impulse of the rebound at the chamber must be less than that at the impulse meter, from the fact that gases may pass readily behind the chamber and exert a downward pressure, and also because of friction in the 3-in. pipe. The effect of gaseous rebound is therefore negligible, and no account of it has been taken in calculating the velocities and efficiencies.

It now becomes possible to find, from the experimental results, the highest velocity

in vacuo upon which dependence may be placed. This is evidently the result of experiment 45 and is 2.34 km/sec or 7680 ft/sec. It is well worth noticing, however, that experiment 50 would have given, without doubt, a velocity even higher, had friction properly been taken into account.

[34] *Discussion of Possible Explanations*

1. The fact that the velocities are higher in vacuo than in air seems explicable only by there being conditions of ignition different in vacuo from those in air; although this may also have been due to the air in the nozzle interfering with the streamlines of the gas, thus producing a jet not strictly unidirectional. It should be remarked that the highest velocity in vacuo recorded, experiment 23, may have been due to unusually good circumstances of ignition; but it may also have been due, in part, to being performed in the circular tank.

2. The fact that the medium nozzle gives in general velocities higher than the long nozzle shows that very likely after travelling the distance from the throat equal approximately to the length of the medium nozzle, the gas is moving so rapidly that it fails to expand fast enough to fill the cross section of the nozzle. A discontinuity in flow is produced at the place where the gas leaves the wall of the nozzle, and this produces eddying and a consequent loss of unidirectional velocity. The efficiency could doubtless be increased by constructing the nozzle in the form of a straight portion, corresponding to a cone of 8° taper, for the length of the medium nozzle with the section beyond this point in the form of a curve concave to the axis of the nozzle.

Conclusions from Experiments

1. The experiments in air and in vacuo prove what was suggested by the photographs of the flash in air, namely, that the phenomenon is really a jet of gas having an extremely high velocity and is not merely an effect of reaction against the air.

2. The velocity attainable depends to a certain extent upon the manner of loading, upon the circumstances of ignition, and upon the form of the nozzle. Hence, in practice, care should be taken to design the cartridge and the nozzle for the density of air at which they are to be used, and to test them in an atmosphere of this particular density.

It is with pleasure that the writer acknowledges the use, as honorary fellow in physics, of the laboratory facilities, and especially the rotary pump, at the Physics Laboratory at Clark University where these experiments were performed.

Significance of the Above Experiments as Regards Constructing a Practical Apparatus

It will be well to dwell at some length upon the significance of the above experiments. In the first place, the lifting power of both [35] powders is remarkable. Experiment 51 shows, for example, that 42 lb can be raised 2 in. by the reaction from less than 0.018 lab of powder. One interesting result is the very high efficiency of the apparatus considered as a heat engine. It exceeds, by a wide margin, the highest efficiency for a heat engine so far attained—the “net efficiency” or duty of the Diesel (internal-combustion) engine being about 40 percent, and that for the best reciprocating steam engine but 21 percent. This high efficiency is, of course, the result of three things: the absence of much heat loss due to the suddenness of the explosion; the almost entire absence of friction; and the high temperature of burning. Owing to these features, it is doubtful if even the most perfect turbine or reciprocating engine could compete successfully with the type of heat engine under consideration.

It is, however, the velocity c in Eqs. (6) and (7) which is of the most interest. The highest velocity obtained in the present experiments is 13 ft/sec under 8000 ft/sec, thus exceeding a mile and a half per second (the “parabolic velocity” at the surface of the moon), and also exceeding anything hitherto attained except with minute quantities of matter by means of electrical discharges in vacuum tubes. Inasmuch as the higher veloci-

ties range between seven and eightfold that of the Coston rocket, we should expect a reduction of initial masses to be made possible by employment of the steel chamber, to at least the seventh root of the masses necessary for a chamber like the Coston rocket.

The supposition is, of course, that the mass of propellant material can be made so large in comparison with the mass of the steel chamber, that the latter is comparatively negligible. No attempt was made in the present experiments to reduce the chamber to its minimum weight; in fact, the more massive it was, the more satisfactorily could the ballistic experiments be performed. The minimum weight possible, for the same thickness of wall as in the experiments, was calculated by estimating, first, the volume of a chamber from which all superfluous metal had been removed, as shown by the full lines in Fig. 3, and then calculating the mass of this reduced chamber, from the measured density of the steel. The minimum masses of chamber per gram of powder plus wadding, estimated in this way, were 145, 150, and 120 gm, respectively, for experiments 50, 51, and 52. In the last two cases, a smaller breechblock could doubtless have been used, as evident from Fig. 3; and in the first two cases, the chamber wall, itself, could safely have been reduced in thickness. More important still, a "built-up" construction would much reduce the mass as has already been explained.

[36] It should be mentioned that, for any particular chamber, it will be necessary to determine the maximum possible powder charge to a nicety, from the fact that, as modern rifle practice has demonstrated, one charge of dense smokeless powder may be perfectly safe for any number of shots, whereas a slightly larger amount, or the same amount slightly more compressed (a state in which the powder must exist in the present chamber) will result in very dangerous pressures.

But the whole question of ratio of mass of powder to chamber is without doubt relatively unimportant for the following reason: The photographs of the flash, in experiments 9 and 11, in which the flash was accidentally reflected in the nozzle of the gun, show the nozzle appearing stationary in the photograph, thus demonstrating that the duration of the flash is very small; but this, as already explained, is much longer than the time during which the gases are leaving the nozzle. The time of firing is, therefore, extremely short. This is to be expected, inasmuch as the high pressure in the chamber sets in motion only the small mass of gas and wadding, and hence must exist for a much shorter time than the pressure in a rifle or pistol. For this reason the heat that is developed in the machine gun, due to the hot gases remaining in the barrel for an appreciable time during each shot, as well as that due to the friction of the bullet, will be absent in the type of rapid-fire mechanism under discussion. Hence, a large number of shots, equivalent to a mass of powder greatly exceeding that of the chamber, may be fired in rapid succession without serious heating.¹⁴

[37] **Part III. Calculations Based on Theory and Experiment**

Application of Approximate Method

As already explained this method consists in employing the equations and

$$M = \frac{R}{a+g} \left\{ e \left[\frac{a+g}{c(1-k)} t \right] - 1 \right\} + e \frac{a+g}{c(1-k)} t \tag{6}$$

and

$$M = e \frac{at}{c(1-k)} \tag{7}$$

to obtain a minimum M in each interval, where

M = The initial mass, for the interval, when the final mass is one pound, and

- R = the air resistance in poundals over the cross section S , at the altitude of the rocket. If we call P the air resistance per unit cross section, we shall have for R , $PS(p/p_0)$ where p is the density at the altitude of the rocket, and p_0 is the density at sea level.
- a = the acceleration in feet per second², taken constant throughout the interval,
- g = the acceleration of gravity,
- t = the time of ascent through the interval, and
- $c(1-k)$ = what will be called the "effective velocity," for the reason that the problem would remain unchanged if the rocket were considered to be composed entirely of propellant material, ejected with the velocity $c(1-k)$. It will be remembered that c actually stands for the true velocity of ejection of the propellant, and k for the fraction of the entire mass that consists of material other than propellant. The effective velocity is taken constant throughout any one calculation.

The altitude is divided into intervals short enough to justify the quantities involved in the above equations being taken as constants. The equations are then used to find the minimum value of M for each interval—the mean values of R and g , in the interval being employed—and the "total initial mass required to raise a final mass of one pound to a desired altitude is then obtained as the product of these M 's.

[38] *Values of the Quantities Occurring in the Equations*

The effective velocity $c(1-k)$. The calculation which follows has been carried out with the assumption¹⁵ of a velocity of ejection of 7500 ft/sec and a constant k equal to $1/15$. This velocity is considerably less than those that were actually obtained, both in air and in vacuo. The "effective velocity" will thus be

$$c(1-k) = 7000 \text{ ft/sec}$$

It should be noticed that k could be $1/12$ and yet not necessitate a larger velocity of ejection than 7640 ft/sec, which is also under the highest velocities obtained in the experiments. It is important at this point to remember that the velocities in vacuo would doubtless have been found to be considerably higher than the above value, if friction could have been eliminated in the "direct-lift" method.

The quality R . The mean value of R for any interval is most easily obtained from a graphical representation of P as a function of v , the mean value of P between the beginning and end of the interval being taken. Three curves have been used for this purpose: for velocities ranging from zero to 1000 ft/sec, 1000 to 3000 ft/sec, and from 3000 ft/sec upward. The first curve represented the experimental results of A. Frank³ obtained with prolate ellipsoids. The second curve represented the experimental results of A. Mallock,⁴ whereas the third curve represented an empirical formula by Mallock,⁵ which agrees well with experimental results up to 4500 ft/sec—the highest velocity that has been attained by projectiles—and hence may be used for still higher velocities with a fair degree of safety. Mallock's expression, reduced to the absolute fps system and multiplied by $1/4$, the coefficient for projectiles with pointed heads, becomes

$$P = 0.00006432v^2 \left(\frac{v^1}{a} \right)^{0.375} + 480 \quad (8)$$

3 A. Frank, *Zeitschr. Verein Deutsches Ing.* 55, pp. 593-612, 1906.

4 A. Mallock, *Proc. Roy. Soc.* 79A, pp. 262-273, 1907.

5 A. Mallock, *Proc. Roy. Soc.* 79A, pp. 267, 1907.

where v' = the velocity with which a wave is propagated in the air immediately in front of the projectile; which equals the velocity of the body when that velocity exceeds the velocity of sound in the undisturbed gas
 a = the velocity of sound in the undisturbed gas

The constant, 480 poundals, must be added for velocities over 2400 ft/sec owing to the vacuum in the rear of the projectile.

[39] *The quantity p .* The above expression (8), for the resistance, holds only at atmospheric pressure. At high altitudes the pressure, of course, decreases greatly. If we call p the mean density throughout any interval of altitude, and p_0 the density at sea level, the right member of (8). On being multiplied by S and p/p_0 , will give the air resistance R experienced by the rocket.

A curve representing the relation between density and altitude up to 120,000 ft is shown in Fig. 6. This curve is derived from a table of pressures and temperatures in Arrhenius's *Lebrbuch der kosmischen Physik*. The ordinates of the curve are the numbers p/p_0 .

Beyond 120,000 ft the density is calculated by the empirical rule which assumes the density to become halved at every increase in altitude of 3.5 miles. A comparison was made between two values obtained in this way and those obtained from the very probable pressures deduced by Wegener, in the following way: The mean density between two levels for which Wegener gives pressures was obtained by multiplying the difference in pressure by 13.6, and dividing by the difference in level in centimeters. A comparison showed that the densities used in the present calculations beyond 123,000 ft were from three- to twentyfold larger than those derived from Wegener's data, so that the values used in the present case were doubtless perfectly safe.

Densities beyond 700,000 ft within the geocoronium sphere must be negligible, for not only is the density very small but the resistance to motion is very small—due, according to Wegener, to the properties of geocoroniesio—a conclusion which is supported by the fact that meteors remain, for the most part, invisible above this level.

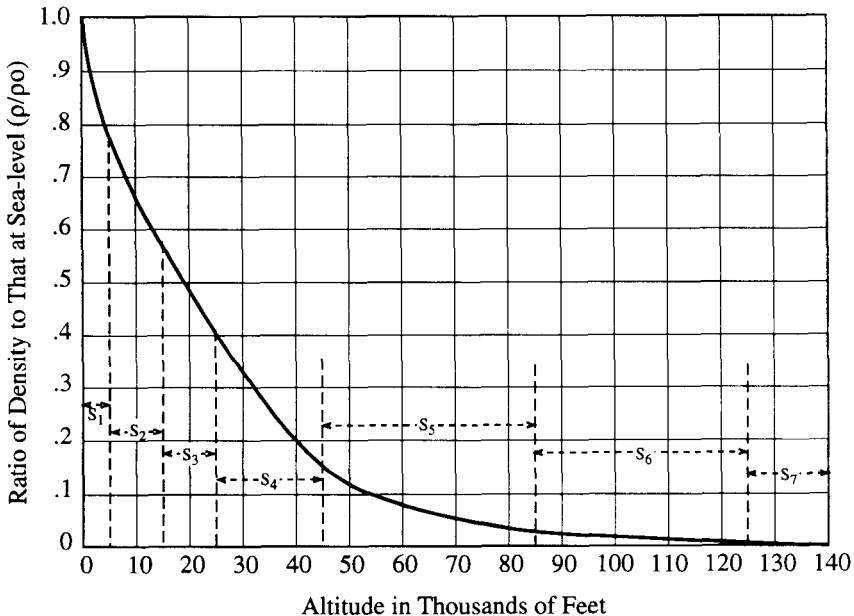

Fig. 6

[40] *Division of the Altitude into Intervals*

In dividing the altitude into intervals the only condition that must be fulfilled is that the densities in any interval shall not differ widely from the mean value in the interval. The least number of intervals which satisfy this condition are given in Table IV. The mean densities in intervals s_1 to s_6 inclusive, were obtained from Fig. 6, on which these intervals are marked. The remaining densities were estimated as already explained.

Table IV

<i>Interval</i>	<i>Length of interval, ft</i>	<i>Height of upper end of interval above sea level, ft</i>	<i>Mean density in terms of ρ_0</i>	<i>Mean gravity chosen, in terms of gravity at sea level</i>
s_1	5,000	5,000	0.928	1
s_2	10,000	15,000	0.730	1
s_3	10,000	25,000	0.520	1
s_4	20,000	45,000	0.278	1
s_5	40,000	85,000	0.080	1
s_6	40,000	125,000	0.015	1
s_7	75,000	200,000	0.0026	1
s_8	300,000	500,000	0.000025	1
s_9 ($a=150$)	3,415,000	3,915,000	—	0.839
s_9 ($a=50$)	8,810,000	9,310,000	—	0.684

Calculation of Minimum Mass for Each Interval

Tables V and VI are calculated for a start, respectively, from sea level and from an altitude of 15,000 ft—i.e., the beginning of s_3 . The procedure in each case is, however, identical.

The process of calculation is as follows: At the beginning of any interval we have the velocity already acquired during the previous intervals, let us say v_0 . This velocity is, of course, zero at the beginning of the first interval. Assume any final velocity at random, v_1 for the interval in question.

[41] The value of at may be had from the equation

$$v_1 = v_0 + at \quad (9)$$

and t is at once obtained from the relation

$$s = v_0 t + \frac{1}{2} at^2$$

i.e.,

$$t = \frac{s}{v_0 + \frac{1}{2} at} \quad (10)$$

whence, of course, a is at once known.

The calculation of

$$\exp \frac{a+g}{c(1-k)} t \quad \text{and} \quad \exp \frac{at}{c(1-k)}$$

calls for no comment; and R is obtained as P , the mean ordinate between v_0 and v_1 , from curves as already explained, multiplied by S and p/p_0 .

The value of M , the initial mass, for the interval, necessary in order that the final mass in the interval shall be one pound, is then obtained from Eq. (7); and finally, the ratio of Eq. (6) to Eq. (7) is calculated, i.e.,

$$\frac{M}{\exp [at/c(1-k)]}$$

This is the ratio of the initial mass necessary, including losses due to both R and g , to the mass necessary to give the one pound the same velocity v_1 , without overcoming R and g ; and the entire calculation must be repeated until a minimum value of this ratio is obtained—when the corresponding mass M will be the minimum mass for the interval in question. Each minimum M is marked in the tables by an asterisk.

This process is carried out for each interval beginning with the first.

It should be noticed that, although P and the density are not really constant in any interval, the result obtained by taking the mean of the quantities must nevertheless give results close to the truth, owing to the fact that P increases during the ascent, whereas the density decreases.

Explanation of Tables V, and VI

It should first be explained why no minimum M has been calculated for the intervals s_7 , and s_8 . Although the minima for the preceding intervals are clearly defined, a trial will show that a minimum M can occur, for s_7 and s_8 , only for extremely high velocities v_1 ; although for s_7 , a secondary minimum occurs for $v_1 = 8000$ ft/sec. Even for $v_1 = 30,000$ ft/sec the minimum has not yet been attained for this interval, although the acceleration required to produce this velocity is 6000 ft/sec². The reason for this state of affairs is evident at once from the fact that the density ratio p/p_0 is very small for s_7 , and also from the fact that a occurs in the denominator of the term containing R in Eq. (6), so that the large acceleration counterbalances the increase in R .

Thus, in order that the initial mass for s_7 shall be a minimum, the acceleration must become very large, with consequent severe strains in the rocket apparatus and instruments carried by the rocket, to say nothing of the difficulty of firing with sufficient rapidity to produce such large accelerations. It thus becomes advisable to choose a moderate acceleration in s_7 , s_8 and not to assign a velocity v_1 , as was done in the preceding intervals. Two accelerations are chosen: 50 ft/sec² and 150 ft/sec², respectively. The interval s_8 , also calculated for assigned accelerations, will be explained in detail below. In all cases, when either one of these accelerations is mentioned in connection with s_8 , and s_9 , this acceleration will be understood as having been taken also in the preceding intervals, beyond s .

In order to see how far the effective velocity $c(1-k)$ may fall short of 7000 ft/sec and still not render the rocket impracticable, a few additional columns for M are calculated.

In the first of the additional columns, M_1 , the effective velocity is taken as 3500 ft/sec, namely, half that of the preceding calculations. This allows considerable inefficiency of the apparatus, in a number of ways. For example, the product

$$c(1-k) = 3500$$

may be given by the same proportionality k as before, but with a velocity of ejection of the gases as low as 3750 ft/sec. On the other hand, the velocity of ejection may be as large as

before (i.e., 7300 ft/sec); and the proportionality k increased to 0.533; meaning, of course, that the rocket now consists more of mechanism than of propellant.

The second additional calculations M_{R1} are carried out under the assumption that a reloading mechanism is used, with k as in the original calculations ($k = 1/15$), but that the velocity of expulsion of the gases is the mean found by experiment for the Coston ship rockets, namely, 1029.25 ft/sec. In this case the effective velocity is

$$c(1-k) = 1029.25 (1 - 1/15) = 960 \text{ ft/sec}$$

The third additional calculations M_{R2} are carried out for the case of a rocket built up of Coston rockets in bundles (shown in Fig. 7), the lowest bundle of which is fired first and

Table V

Interval	v_e , ft/sec	at	t , sec	a	$\frac{at}{c(1-k)}$	$\frac{a+g}{c(1-k)}t$	$\frac{exp}{c(1-k)}at$	$\frac{exp}{c(1-k)}\frac{(a+g)}{c(1-k)}t$	P , poundals per sq in.	R , PS(p/p_0)	$\frac{R}{a+g}$
s_1	500	500	20.0	25	.0716	.1630	1.074	1.176	7.36	6.85	.120
	800	800	12.5	64	.1145	.1720	1.120	1.186	20.0	18.5	.193
	* 1,000	1,000	10.0	100	.143	.1890	1.153	1.207	31.25	29.0	.219
	1,200	1,200	8.34	144	.172	.212	1.185	1.235	61.4	57.0	.323
	1,500	1,500	6.7	226	.215	.2475	1.242	1.276	104.6	98.0	.378
	2,000	2,000	5.0	400	.287	.309	1.332	1.362	202.5	188.0	.436
s_2	1,100	100	9.54	10.47	.0143	.0578	1.014	1.061	153.3	112.1	2.64
	* 1,200	200	9.1	22.0	.0286	.0704	1.034	1.073	166.6	121.6	2.24
	1,400	400	8.33	47.9	.0574	.0954	1.060	1.100	216.0	158.7	1.97
s_3	1,300	100	8.0	12.5	.0143	.0508	1.014	1.052	250.0	130.0	2.925
	* 1,400	200	7.7	25.8	.0286	.0637	1.034	1.066	262.8	136.9	2.37
	1,600	400	7.15	56.4	.0574	.0906	1.06	1.096	294.5	152.6	1.74
s_4	1,500	100	13.8	7.23	.0143	.0775	1.014	1.080	339.0	94.3	2.42
	* 1,600	200	13.33	15.0	.0286	.0898	1.034	1.094	372.0	101.5	2.17
	1,700	300	12.9	23.24	.0429	.1022	1.046	1.107	394.0	109.4	1.975
	1,800	400	12.5	33.25	.0574	.1170	1.060	1.123	424.0	118.0	1.81
s_5	1,700	100	24.25	4.125	.0143	.1258	1.014	1.133	439.0	35.1	.974
	* 1,800	200	23.7	8.45	.0286	.1366	1.034	1.146	480.0	38.4	.951
	2,000	400	22.24	18.0	.0574	.159	1.06	1.173	535.0	42.8	.854
s_6	1,900	100	21.7	4.62	.0143	.1135	1.014	1.12	567.	8.50	.232
	* 2,000	200	21.1	9.50	.0286	.1255	1.034	1.133	603.	9.01	.2175
	2,200	400	20.0	20.0	.0574	.1490	1.06	1.16	669.	10.02	.1923
$s_7(a=150)$ ($a=50$)	5,160	3,160	21.0	150	.4523	.5452	1.572	1.725	1,878.	4.84	.0264
	3,393	1,393	27.8	50	.199	.3276	1.218	1.387	1,122.	3.1	.0355
$s_8(a=150)$ ($a=50$)	10,790	5,630	37.5	150	.804	.976	2.23	2.65	10,600.	0.272	.00146
	6,833	2,840	55.8	50	.399	.652	1.49	1.92	4,000.	0.0994	.00121
$s_9(a=150)$ ($a=50$)	33,790	23,000	153.5	150	3.29	3.89	26.9	48.8			
	30,533	23,700	472.5	50	3.38	4.85	29.13	129.0			

then released; after which the bundle above is fired and then released, and so on. For the Coston ship rocket (having a range of a quarter of a mile, with the charge of red fire removed, as already stated) the ratio of the powder charge to the remaining mass of the rocket is found to be closely $1/4$. Hence the "effective velocity" in this case is only

$$c(1-k) = 1029.25(1-4/5) = 257.3 \text{ ft/sec}$$

The M 's in the last two cases are calculated only for the accelerations that make M minima for the first case (effective velocity, 7500 ft/sec). Hence in these cases, the M 's are not minima, although only in the last two cases is there probably much discrepancy from the actual minima.

[42]

M , <i>lb</i>	$\frac{M}{\text{exp}}$ $\frac{at}{c(1-k)}$	exp $\frac{2(a+g)_t}{c(1-k)}$	M_b , <i>lb</i>	exp $\frac{7.28(a+g)_t}{c(1-k)}$	M_{R1} , <i>lb</i>	exp $\frac{27.2(a+g)_t}{c(1-k)}$	M_{R2} , <i>lb</i>	Time to upper end of interval, sec
1.1972	1.113							
1.2218	1.092							
1.252	1.086	1.458	1.5584	3.94	4.586	167.3	203.90	10.0
1.311	1.106							
1.380	1.112							
1.5195	1.138							
1.222	1.206							
1.237	1.199	1.150	1.4860	1.665	3.155	6.73	20.60	19.1
1.297	1.223							
1.204	1.186							
1.222	1.182	1.137	1.462	1.589	2.974	5.62	16.52	26.8
1.261	1.191							
1.273	1.255							
1.297	1.253	1.198	1.626	1.92	3.91	11.33	33.73	40.13
1.319	1.26							
1.346	1.267							
1.262	1.245							
1.2845	1.242	1.313	1.711	2.694	4.304	40.70	88.45	63.83
1.321	1.246							
1.1478	1.13							
1.162	1.123	1.280	1.3406	2.488	2.810	29.76	36.02	84.93
1.1907	1.124							
1.7442	1.108	2.97	3.022	52.6	53.96	2.63×10^4	2.70×10^4	105.93
1.4007	1.15	1.900	1.9319	10.79	11.13	7.03×10^3	7.28×10^3	112.73
2.6524	1.19	7.02	7.0288	1,192.0	1,193.7	2.88×10^{11}	2.88×10^{11}	143.43
1.9211	1.293	3.680	3.6832	117.4	117.54	4.67×10^7	4.67×10^7	168.53
48.8		2,380.0	2,380.0	$1,906 \times 10^{12}$	$1,906 \times 10^{12}$	5.74×10^{45}	5.74×10^{45}	296.93
129.0		16,700.0	16,700.0	$1,995 \times 10^{15}$	$1,995 \times 10^{15}$	1.25×10^{57}	1.25×10^{57}	641.03

The cross section, *throughout any interval*, is taken as 1 sq in, except for interval s_3 . It will be seen from the table that this is justifiable, as the largest mass in intervals s_1 to s_6 does not differ much from one pound.

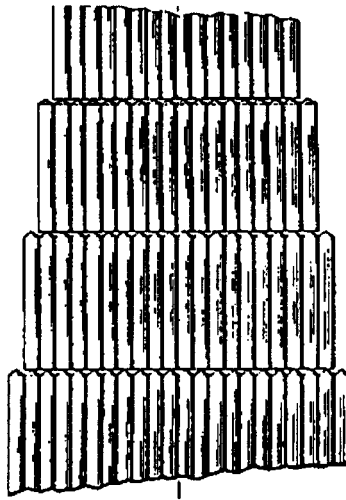

Fig. 7

[44]

Table VI

Interval	v_n ft/sec	at	t sec	a	$\frac{at}{c(1-k)}$	$\frac{a+g}{c(1-k)}t$	exp $\frac{at}{c(1-k)}$	exp $\frac{(a+g)t}{c(1-k)}$
s_3 *	500	500	40.	12.5	0.0715	0.205	1.074	1.29
	800	800	25.	32.0	0.1147	0.2277	1.120	1.256
	1,000	1,000	20.	50.0	0.142	0.235	1.152	1.263
	1,500	1,500	13.4	112.0	0.2145	0.277	1.24	1.318
s_4 *	900	100	23.7	4.23	0.0143	0.1227	1.013	1.132
	1,000	200	22.2	9.00	0.0286	0.1305	1.034	1.137
	1,300	500	19.1	26.2	0.0714	0.1645	1.073	1.177
	1,800	1,000	15.4	65.0	0.1430	0.2136	1.152	1.238
s_5 *	1,100	100	38.1	2.625	0.0124	0.1888	1.013	1.207
	1,200	200	36.5	5.47	0.0286	0.1960	1.03	1.215
	1,300	300	34.75	8.64	0.0430	0.202	1.044	1.223
	1,400	400	33.3	12.0	0.0571	0.210	1.058	1.233
	1,500	500	32.1	15.60	0.0715	0.2192	1.073	1.245
	2,000	1,000	26.1	21.40	0.1147	0.268	1.12	1.308
s_6 *	1,600	300	27.7	10.8	0.0430	0.1690	1.045	1.184
	1,800	500	25.7	19.5	0.0714	0.1890	1.074	1.206
	1,900	600	25.0	24.0	0.0857	0.201	1.091	1.223
	2,000	700	24.2	28.9	0.1002	0.212	1.105	1.234
	2,100	800	23.6	33.8	0.1142	0.224	1.118	1.249
	2,200	900	22.8	40.0	0.1285	0.237	1.124	1.266

Calculation of Minimum Mass to Raise One Pound to Various Altitudes in the Atmosphere

The "total initial masses" required to raise one pound from sea level to the upper end of intervals s_6, s_7, s_8 are given in Table VII. They are obtained by multiplying together the minimum masses (marked by stars in Table V), from s_1 up to and including the interval in question, and represent, as already explained, the mass in pounds of a rocket which, starting at sea level, would become reduced to one pound at the altitude given.

The highest altitude attained by the one pound mass is not, however, the upper end of the interval in question, but is a very considerable distance higher. This, of course, follows from the fact that the one pound reaches the upper end of each interval with a considerable velocity, and will continue to rise after propulsion has ceased until this velocity is reduced to zero, by gravity and air resistance.

If we call v_n the velocity with which the pound mass reaches the upper end of the particular interval where propulsion ceases, b the distance beyond which, the one pound will rise (the cross section still being 1 sq in.), and p the mean air resistance in poundals [47] over the distance b , we have, by the principle of work and energy,

$$h = \frac{v_n^2}{2(g + p)}$$

The values of p are small, owing to small atmospheric density being 1.59 poundals for the b beyond s_6 ; 0.28 beyond s_7 ($a=50$); and 0.465 beyond s_7 ($a=150$). For s_8 the low density makes this quantity negligible.

The altitudes obtained by adding to the interval the corresponding b are called the "greatest altitude attained" in Table VII.

[46]

$P,$ poundals per sq in.	$R,$ $PS(p/p_0)$	$\frac{R}{a+g}$	$M,$ lb	$\frac{M / \exp at}{c(1-k)}$	$\frac{\exp \frac{2(a+g)t}{c(1-k)}}{c(1-k)}$	$M_0,$ lb	$\frac{\exp \frac{7.28(a+g)t}{c(1-k)}}{c(1-k)}$	$M_{811},$ lb
11.53	5.97	0.134	1.329	1.236				
30.7	16.00	0.250	1.300	1.162	1.574	1.718	5.225	6.545
46.7	24.3	0.295	1.341	1.165				
165.0	83.3	0.570	1.499	1.207				
95.7	27.7	0.764	1.232	1.216				
108.8	31.4	0.767	1.242	1.200	1.293	1.518	2.581	3.794
165.0	46.25	0.794	1.318	1.227				
305.0	87.90	0.908	1.455	1.263				
150.1	12.0	0.347	1.278	1.261				
170.0	13.55	0.362	1.293	1.255				
195.0	15.65	0.384	1.306	1.250	1.495	1.685	4.32	5.594
218.0	17.49	0.397	1.325	1.252				
243.5	19.45	0.520	1.372	1.280				
417.0	33.4	0.623	1.501	1.340				
343.0	5.16	0.1203	1.206	1.153				
406.0	6.10	0.1186	1.230	1.147				
430.0	6.43	0.1150	1.248	1.142				
460.0	6.90	0.1134	1.260	1.140	1.522	1.581	4.66	5.075
510.0	7.65	0.1165	1.278	1.142				
534.0	8.02	0.1115	1.295	1.151				

Obviously if the start is made at a high elevation, the "total initial mass" required to reach a given height will be less than for a start at less level, due not only to the fact that the apparatus is not raised through so great a height, but also to the fact that the denser part of the atmosphere is avoided. Table VI gives minimum masses M , calculated for a start with zero velocity from the beginning of interval s_6 (i.e., 15,000 ft), the effective velocity being 7000 ft/sec, as in Table V.

It happens that the velocity v_1 , for minimum M in the interval s_6 of Table VI is the same as the v_1 for the same interval in Table V. The calculations that have been made for the intervals beyond s_6 apply therefore to the present case, and the only difference between the two cases is that the masses required to reach s , will be greater for the start at sea level than for the start at 15,000 ft.

The calculations beginning at 15,000 ft have been carried out in Table VII for all but the lowest "effective velocity;" and it will be observed that the start from a high elevation becomes important only for the lower "effective velocities."

The most striking as well as the most important conclusion to be drawn from Table VII is the small "total initial mass" required to raise one pound to very great altitudes when the "effective velocity" is 7000 ft/sec, the mass for the height of 437 miles (2,510,000 ft), for example, being but 12.33 lb, starting from sea level. Even for an "effective velocity" of 3500 ft/sec, which allows of considerable inefficiency in the rocket apparatus, the mass is sufficiently moderate to render the method perfectly practicable, for in this case an altitude of over 230 miles from sea level, practically the limit of the earth's atmosphere, requires under 90 lb¹⁶, and an altitude of 118 miles, close under the geocoronium sphere, only 38 lb. For a start at 15,000 ft, the masses are, of course, less, namely, 49.3 lb and 20.9 lb, respectively.¹⁷

[48] The enormous difference between the total initial masses required for low efficiency rockets compared with those for high, may at first appear surprising; but they should be expected from the exponential nature of Eqs. (6) and (7). Thus if the "effective velocity" is reduced from 7000 ft/sec to half this value, the minimum masses for each interval, neglecting air resistance, will be those for 7000 ft/sec squared; and including air resistance, still greater. Similarly for an effective velocity of 906 ft/sec which is that for reloading

Table VII

Interval	Altitude of upper end of intervals, ft	Greatest altitude attained, ft	Time to reach greatest altitude from sea level, sec	Total initial masses (in lb)	
				Starting	
				$c(1 - k) = 7,000$	$c(1 - k) = 3,500$
s_6	125,00	184,100	144.13	3.665	12.61
s_7 ($a = 50$) ($a = 150$)	200,000	377,500	217.73	5.14	24.36
	200,000	610,000	265.93	6.40	38.10
s_8 ($a = 50$) ($a = 150$)	500,000	1,228,000	380.53	9.875	89.60
	500,000	2,310,000	475.23	12.33	267.70
s_9 ($a = 50$) ($a = 150$)	9,310,000	∞	∞	1,274.0	1.497×10^6
	3,915,000	∞	∞	602.0	6.37×10^5

rockets having the same velocity of ejection as Conton ship rockets, the minimum masses will be those for 7000 ft/sec raised [49] to the 7.28th power; and for bundles for groups of ship rockets, as shown in Fig. 7, the minimum masses will be those for 7000 ft/sec, raised to the 27.2th power. Even when air resistance is entirely neglected in the calculation for the last case, the masses are of much the same magnitude, as shown in Table VII. The large values of the masses M_{R1} and M_{R2} simply express the impossibility of employing rockets of low efficiency. Attention may be called to the particular case under M_{R2} (the groups of slip rockets indicated in Fig. 7) in which one pound is raised to the altitude of 1,228,000 ft (232 miles); the "total initial mass" in this case, even neglecting air resistance entirely, is 2.89×10^{18} lb, or over sixfold greater than the entire mass of the earth.

These large numbers, to be sure, agree with one's first impression as to the probable initial mass of a rocket designed to reach extreme altitudes; but the comparatively small initial masses, possible with high efficiency, are not intuitively evident until one realizes what an enormous reduction is involved in extracting anything at large as the 27th root of a number.

It should be observed that the apparatus is taken as weighing one pound. Strictly speaking, if the recording instruments have a mass of one pound, the entire final mass of the apparatus must be at least 3 or 4 lb. The mass for the recording instruments may be considered as being very small, yet many valuable researches could, of course, be performed with an apparatus weighing no more than this.¹⁸ The entire final apparatus should, if possible, be designed to weigh not over 3 or 4 lb at most, unless the efficiency of the apparatus is so high that the "effective velocity," $c(a-k)$, is at least in the neighborhood of 7000 ft/sec. An examination of Table VII makes very evident the necessity of securing maximum effectiveness of the apparatus before a rocket for such a purpose as meteorological work, for example, is constructed; in order to make the method as inexpensive as possible. It should be remarked, however, that the "total initial mass" will really not be increased in as large a proportion as the final mass if the latter is made greater than one pound by virtue of Eq. (2).

Before proceeding further it will be well to consider carefully the question of air resistance as dependent upon the cross section of the rocket during flight. It has already been assumed that the cross section, in the calculation of the minimum M for each

for one pound final mass

from sea level			Starting from 15,000 ft		
$c(1-k)$ = 960	$c(1-k)$ = 257.3	$c(1-k)$ = 257.3 <i>R taken = 0</i>	$c(1-k)$ = 7,000	$c(1-k)$ = 3,500	$c(1-k)$ = 960
2,030.0	7.40×10^9	8.63×10^8	2.66	6.95	702.0
2.26×10^4 1.096×10^5	5.46×10^{12} 2.00×10^{15}	6.08×10^{11} 2.28×10^{14}	3.74 4.65	13.38 20.90	7,820 37,800
2.66×10^6 1.318×10^8	2.55×10^{19} 5.77×10^{26}	2.89×10^{18} 6.53×10^{25}	7.19 8.97	49.30 147.30	9.17×10^5 4.51×10^7
5.32×10^{21} 2.49×10^{20}	3.21×10^{76} 3.32×10^{71}	3.63×10^{75} 3.76×10^{70}	926.0 438.0	8.22×10^5 3.51×10^5	1.82×10^{21} 8.59×10^{19}

Interval, was 1 sq in. If we make the apparatus as long, narrow, and compact as possible, the assumption of a cross section of 1 sq [50] in. for an apparatus weighing one pound will not be unreasonable. A glance at Tables V and VI will show that, for "effective velocities" of 7000 ft/sec and 3500 ft/sec, the mass at the beginning of any interval (except s_6) does not greatly exceed one pound—the mass at the end of each interval being one pound—so that the computations are in agreement with this assumption of area of cross section. For the two cases of the adapted Coston rockets, the masses at the beginning of the intervals are much larger; and hence we see that the "total initial masses" in Table VII, large as they are, would have been even larger if a proper value of cross section had been employed.

The important point is, however, that cross-sectional areas of *even less than 1 sq in. should have been used*. The reason for this is obvious when one remembers that in calculating the "total initial masses," when we multiply minimum masses M together, we are also multiplying the cross sections in the same ratio. In other words, we are considering numbers of rockets, each of 1 sq in. cross section, grouped together side by side, into a bundle.

But such an arrangement would have its cross section proportional to its mass and not to the $2/3$ power of its mass, as would be the case if the *shape of the rocket apparatus were at all times similar to the shape at the start* (as in the ideal rocket, Fig. 1). This constant similarity of shape is, as we have seen in Eq. (2), one of the conditions for a minimum initial mass. Hence the "total initial masses" that have been calculated are really larger than the true minima, which would be obtained only by repeating the calculations, assuming a smaller cross section except in the last few intervals, in which the rocket has become so small that the condition of 1 sq in. per pound is approximately satisfied.

Before leaving the subject of air resistance, attention should be called to the fact that the velocities (Table V) do not exceed that for which air resistance has been studied by Mallock until in s_7 , for $a = 150$ ft/sec², and in s_8 , for $a = 50$ ft/sec²; and furthermore, that the velocities do not become much in excess until the densities have become almost negligible.

Check or Approximate Method of Calculation

A simple calculation, involving only the most elementary formulas instead of Eqs. (6) and (7), will show that the "total initial masses" in Table VII cannot be far from the truth.

Consider, for simplicity, a rocket of the form shown in Fig. 1, and suppose that one-third of the mass of the rocket is fired downward, [51] with a velocity of 7000 ft/sec at the first shot; one-third of the remaining mass, at the second shot; and so on, for successive shots. From the principle of the conservation of momentum it will be evident that the mass that remains is given an additional upward velocity of 35000 ft/sec after each shot.

Thus, after the fourth shot, the mass that remains is $16/81$, of practically $1/5$, of the initial mass, and the velocity is 14,000 ft/sec. This velocity is sufficient, if we neglect air resistance, to raise the part of the rocket that remains to an altitude of 580 miles (by the familiar relation $v^2 = 2gh$). Although the range would be much reduced if air resistance were considered, it should nevertheless be remembered that the values in Table VII are calculated for the condition under which air resistance is a minimum.

The above simple case is not realizable in practice because of the large mass of propellant for each shot compared with the total mass—i.e., provision is not made for the mass of the chamber. The result will be the same, however, if smaller charges are fired in rapid succession, as will be evident from a calculation similar to the above, which is carried out in Appendix E, under the assumption of smaller charges for successive shots.

Recovery of Apparatus on Return

A point of considerable practical importance is the question of finding the apparatus on its return, and of following it during flight, both of which depend in a large measure upon the time of flight.

Concerning the times of ascent, Table VII shows that these are remarkably short. For

example, a height of over 250 miles is reached in less than 6 1/2 minutes (s_8 ; $a = 50$). The reason is, of course, that the rocket under present discussion possesses the advantage of the bullet in attaining a high velocity, with the added advantage of starting gradually from rest. In fact, the motion fulfills closely the ideal conditions for extremely rapid transit—namely, starting from rest with the maximum acceleration possible, and reversing this acceleration, in direction, at the middle of the journey.

The short time of ascent and descent is, of course, highly advantageous as regards following the apparatus during ascent, and recovering it on landing. The path can be followed, by day, by the ejection of smoke at intervals, and at night by flashes. Any distinctive feature, as, for example, a long black streamer, could assist in rendering the instruments visible on the return.

[52] Some means will, of course, be necessary to check the velocity of the returning instruments. It might not appear, at first sight, that a parachute would be operative at a velocity of 10,000 ft/sec or more; but it should be remembered that this velocity will occur in air of very small density, so that the pressure, or force per unit area of the parachute, would not be excessive, notwithstanding the high velocity of the apparatus. The magnitudes of the air resistance will, of course, be much larger than would be indicated from the values of R in Tables V and VI, from the fact that, for motion with the parachute, the cross section will be much larger in proportion to the mass of the rocket than for the cases presented in these tables.

If the parachute is so large that the velocity will be decreased greatly when the denser air is reached, the descent will be so slow that finding of the apparatus will not be so easy as would be the case with a more rapid descent. For this reason, part of the parachute device must be lost automatically when the apparatus has fallen into air of a certain density; or else the parachute must be small enough to facilitate a rapid descent, with additional parachute devices rendered operative as the rocket nears the ground. Such devices are not described in the present paper, but can be of simple and light construction.

The effectiveness of a parachute of even moderate size, operating in a region where the density is small, may be demonstrated by the following concrete example. Suppose that an apparatus weighing 1 lb and having a parachute of 1 sq ft area descends from the altitude 1,228,000 ft (over 200 miles), and does not encounter any atmospheric resistance until it is level with the upper limit of s_8 (125,000 ft). This condition will not, of course, be that which would actually obtain in practice, for a continually increasing resistance will be experienced as the apparatus descends; but if a sufficient braking action can be shown to exist in the present example, the parachute device will *a fortiori* be satisfactory in practice.

The velocity acquired by the apparatus in falling freely under the influence of gravity between the two levels is

$$\sqrt{64 \times 1,103,000} = 8400 \text{ ft/sec}$$

Now the air resistance in poundals per square inch of section at atmospheric pressure for this velocity is, from the plot of Mallock's formula, 360×32 poundals per square inch, making the value of R for the area of the parachute

$$R = 1,653,000 \text{ poundals/in.}^2$$

[53] But the actual resistance is R , multiplied by the relative density at 125,000 ft which is approximately 0.01, giving for the resistance

$$F = 16,530 \text{ poundals/in.}^2$$

A retarding acceleration must therefore act upon the apparatus, of amount given by

$$a = \frac{F}{M} = 16,530 \text{ ft/sec}^2$$

Hence it is safe to say that, long before the apparatus had fallen to the 125,000-ft level, the velocity would have been reduced to, and maintained at, a safe value, with the employment of even a small parachute. This case, it should be noticed, is entirely different from that of a falling meteor, in that the apparatus under discussion falls from rest, at the highest point reached; whereas the meteor enters the earth's atmosphere with an enormous initial velocity.

If it is considered desirable, for any reason, to dispense with a sufficiently large parachute, the retarding of the apparatus may be accomplished to any degree by having the rocket consist, at its highest point of flight, not merely of instruments plus parachute, but of instruments together with a chamber, and considerable propellant material. Then, after the rocket has descended to some lower level, let us say, to the upper limit of s_6 , this propellant material can be ejected, so that the velocity is considerably checked before the apparatus reaches as low an altitude as, say, 5000 ft. For the cases in which the effective velocity $c(1-k)$ is as large as 7000 ft/sec there is little inconvenience in increasing the mass in this way. But for the case in which $c(1-k) = 3500$, this method can hardly be as satisfactory as the parachute method; for if the "final" mass to be elevated is made a number of pounds, let us say n , the "total initial mass" (which is large even for one pound final mass) will be n -fold larger, and the apparatus correspondingly more expensive.

Applications to Daily Observations

Before leaving the subject of the attainment of high altitudes within the earth's atmosphere, it will be well to mention briefly another application of the method herein discussed: namely, to the sending daily of small recording instruments to moderate altitudes, such as 5 or 6 miles. As is already understood, simultaneous daily observations of the vertical gradients of pressure, temperature, and wind velocity, at a large number of stations would doubtless be of great value in weather forecasting. The method herein described [54] is evidently well suited for such a purpose, in that the time of rise and fall would be short, so that the apparatus could easily be found on the return. Thus the expense would be slight, being simply that of a fresh magazine of cartridges for each day.

For this work, as well as for that previously described, the head of the rocket should be prevented from rotating, by means of a gyroscope, such as is explained in U.S. Patent No. 1,102,653.

Calculation of Minimum Mass Required to Raise One Pound to an "Infinite" Altitude

From the fact that the preceding calculation leads us to conclude that such an extreme altitude as 2,310,000 ft (over 437 miles) can be reached by the employment of a moderate mass, provided the efficiency is high, it becomes of interest to speculate as to whether or not a velocity as high as the "parabolic" velocity for the earth could be attained by an apparatus of reasonably small initial mass.

Theoretically, a mass projected from the surface of the earth with a velocity of 6.95 miles/sec would, neglecting air resistance, reach an infinite distance, after an infinite time; or, in short, would never return. Such a projection without air resistance, is, of course, impossible. Moreover, the mass would not reach infinity but would come under the gravitational influence of some other heavenly body.

We may, however, consider the following conceivable case: If a rocket apparatus such as has here been discussed were projected to the upper end of interval s_6 , with an acceleration of 50 or 150 ft/sec², and this acceleration were maintained to a sufficient distance beyond s_6 , until the parabolic velocity were attained, the mass finally remaining would certainly never return.

If we designate as the upper end of s_6 the height at which the velocity of ascent becomes the "parabolic" velocity, it will be evident that this height will be different for the two accelerations chosen, inasmuch as the "parabolic" velocity decreases with increasing distance from the center of the earth.

If we call n = the "parabolic" velocity at a distance H above the surface of the earth
 v_1 = the velocity acquired at the upper end of interval s_8 ,
 s_8 = the height of the upper end of s_8 above sea level

we have, taking the radius of the earth as 20,900,000 ft,

$$u = v_1 + at \quad (11)$$

$$H = s_8 + v_1 t + \frac{1}{2} at^2 \quad (12)$$

[55] and also the equation relating "parabolic" velocity to distance from the center of the earth

$$\frac{36,700}{u} = \sqrt{\frac{20,900,000 + H}{20,900,000}} \quad (13)$$

On putting the values of u and H , from (11) and (12), in (13), we have

$$\sqrt{20,900,000} \times 36,700 = (v_1 + at) \sqrt{21,400,000 + v_1 t + \frac{1}{2} at^2} \quad (14)$$

Equation (14) is a biquadratic in t , from which t may easily be obtained (by trial and error). The values of t , for the two accelerations chosen, given in Table V, enable u and the initial masses for s_8 to be at once obtained.

The effect of air resistance in s_8 is negligible, if we accept Wegener's conclusions, above mentioned, concerning the properties of geocoronium. But even if we use the empirical rule of a fall of density to one-half for every 3.5 miles, we shall find the reduction of velocity very small on passing from the upper end of s_8 (500,000 ft) to 1,000,000 ft (beyond which the density is negligible). This is shown in Appendix F.

The "total initial masses," to raise one pound to an "infinite" altitude for the two accelerations chosen, are given in Table VII. It will be observed that they are astonishingly small, provided the efficiency is high. Thus with an "effective velocity" of 7000 ft/sec, and an acceleration of 150 ft/sec², the "total initial mass," starting at sea level, is 602 lb, and starting from 15,000 ft is 438 lb.¹⁹ The mass required increases enormously with decreasing efficiency, for, with but half of the former "effective velocity" (3500 ft/sec), the "total initial mass," even for a start from 15,000 ft, is 351,000 lb. The masses would obviously be slightly less if the acceleration exceeded 150 ft/sec².

It is of interest to speculate upon the possibility of proving that such extreme altitudes had been reached even if they actually were attained. In general, the proving would be a difficult matter. Thus, even if a mass of flash powder, arranged to be ignited automatically after a long interval of time, were projected vertically upward, the light would at best be very faint, and it would be difficult to foretell, even approximately, the direction in which it would be most likely to appear.

The only reliable procedure would be to send the smallest mass of flash powder possible to the dark surface of the moon when in conjunction (i.e., the "new" moon), in such a way that it would be [56] ignited on impact. The light would then be visible in a powerful telescope. Further, the larger the aperture of the telescope, the greater would be the ease of seeing the flash, from the fact that a telescope enhances the brightness of point sources, and dims a faint background.

An experiment was performed to find the minimum mass of flash powder that should be visible at any particular distance. In order to reproduce, approximately, the conditions that would obtain at the surface of the moon, the flash powder was placed in small capsules C, Plate 9, Fig. 1, held in glass tubes 7; closed by rubber stoppers. The tubes were

exhausted to a pressure of from 3 to 10 cm of mercury, and sealed, the stoppers being painted with wax, to preserve the vacuum. Two shellacked wires, passing to the powder, permitted firing of the powder by an automobile spark coil.

It was found that Victor flash powder was slightly superior to a mixture of powdered magnesium and sodium nitrate, in atomic proportions, and much superior to a mixture of powdered magnesium and potassium chlorate, also in atomic proportions.

In the actual test, six samples of Victor flash powder, varying weight from 0.05 gm to 0.0029 gm, were placed in tubes as shown in Plate 9, Fig. 1, and these tubes were fastened in blackened compartments of a box, Plate 9, Fig. 2, and Plate 10, Fig. 1. The ignition system was placed in the back of the same box, as shown in Plate 10, Fig. 2. This system comprised a spark coil, operated by three triple cells of Eveready battery, placed two by two in parallel. The charge was fired on closing the primary switch at the left. The six-point switch at the right served to connect the tubes, in order, to the high-tension side of the coil.

The flashes were observed at a distance of 2.24 miles on a fairly clear night; and it was found that a mass of 0.0029 gm of Victor flash powder was visible, and that 0.015 gm was strikingly visible, all the observations being made with the unaided eye. The minimum mass of flash powder visible at this distance is thus surprisingly small.

From these experiments it is seen that if this flash powder were exploded on the surface of the moon, distant 220,000 miles, and a telescope of 1-ft aperture were used—the exit pupil being not greater than the pupil of the eye (e.g., 2mm)—we should need a mass of flash powder of

2.67 lb to be just visible
13.82 lb or less to be strikingly visible

[57] If we consider the final mass of the last “secondary” rocket plus the mass of the flash powder and its container, to be four times the mass of the flash powder alone, we should have, for the final mass of the rocket, four times the above masses. These final masses correspond to the “one pound final mass” which has been mentioned throughout the calculations.

The “total initial masses,” or the masses necessary for the start at the earth, are at once obtained from the data given in Table VII. Thus if the start is made from sea level, and the “effective velocity of ejection” is 7000 ft/sec, we need 602 lb for every pound that is to be sent to “infinity.”¹

We arrive, then, at the conclusion that the “total initial masses” necessary would be

6,436 lb or 3.21 tons; flash just visible
33,278 lb or 16.63 tons (or less); flash strikingly visible

A “total initial mass” of 8 or 10 tons would, without doubt, raise sufficient flash powder for clear visibility.²¹

These masses could, of course, be much reduced by the employment of a larger telescope. For example, with an aperture of 2 ft, the masses would be reduced to one-fourth of those just given. The use of such a large telescope would, however, limit considerably the possible number of observers. In all cases, the magnification should be so low that the entire lunar disk is in the field of the telescope.

It should be added that the probability of collision of a small object with meteors of the visible type is negligible, so is indicated in Appendix G.

This plan of sending a mass of flash powder to the surface of the moon, although a matter of much general interest, is not of obvious scientific importance. There are, however, developments of the general method under discussion, which involve a number of

1. A simple calculation²⁰ will show that the total initial mass required to send one pound to the surface of the moon is but slightly less than that required to send the mass to “infinity.”

important features not herein mentioned, which could lead to results of much scientific interest. These developments involve many experimental difficulties, to be sure; but they depend upon nothing that is really impossible.

[58]

Summary

1. An important part of the atmosphere, that extends for many miles beyond the reach of sounding balloons, has up to the present time been considered inaccessible. Data of great value in meteorology and in solar physics could be obtained by recording instruments sent into this region.

2. The rocket, in principle, is ideally suited for reaching high altitudes, in that it carries apparatus without jar, and does not depend upon the presence of air for propulsion. A new form of rocket apparatus, which embodies a number of improvements over the common form, is described in the present paper.

3. A theoretical treatment of the rocket principle shows that, if the velocity of expulsion of the gases were considerably increased and the ratio of propellant material to the entire rocket were also increased, a tremendous increase in range would result, from the fact that these two quantities enter exponentially in the expression for the initial mass of the rocket necessary to raise given mass to a given height.

4. Experiments with ordinary rockets show that the efficiency of such rockets is of the order of 2 percent, and the velocity of ejection of the gases, 1000 ft/sec. For small rockets the values are slightly less.

With a special type of steel chamber and nozzle, an efficiency has been obtained with smokeless powder of over 64 percent (higher than that of any heat engine ever before tested); and a velocity of nearly 8000 ft/sec, which is the highest velocity so far obtained in any way except in electrical discharge work.

5. Experiments were repeated with the same chambers in vacuo, which demonstrated that the high velocity of the ejected gases was a real velocity and not merely an effect of reaction against the air. In fact, experiments performed at pressures such as probably exist at an altitude of 30 miles gave velocities even higher than those obtained in air at atmospheric pressure, the increase in velocity probably being due to a difference in ignition. Results of the experiments indicate also that this velocity could be exceeded, with a modified form of apparatus.

[59] 6. Experiments with a large chamber demonstrated not only that large chambers are operative, but that the velocities and efficiencies are higher than for small chambers.

7. A calculation based upon the theory, involving data that is in part that obtained by experiments, and in part what is considered as realizable in practice, indicates that the initial mass required to raise recording instruments of the order of one pound, even to the extreme upper atmosphere, is moderate. The initial mass necessary is likewise not excessive, even if the effective velocity is reduced by half. Calculations show, however, that any apparatus in which ordinary rockets are used would be impracticable owing to the very large initial masses that would be required.

8. The recovery of the apparatus on its return, need not be a difficult matter, from the fact that the time of ascent even to great altitudes in the atmosphere will be comparatively short, owing to the high speed of the rocket throughout the greater part of its course. The time of descent will also be short; but free fall can be satisfactorily prevented by a suitable parachute. A parachute will be operative for the reason that high velocities and small atmospheric densities are essentially the same as low velocities and ordinary density.

9. Even if a mass of the order of a pound were propelled by the apparatus under consideration until it possessed sufficient velocity to escape the earth's attraction, the initial mass need not be unreasonably large, for an effective velocity of ejection which is without doubt attainable. A method is suggested whereby the passage of a body to such an extreme altitude could be demonstrated.

Conclusion

Although the present paper is not the description of a working mode, it is believed, nevertheless, that the theory and experiments, herein described, together settle all points that could seriously be questioned, and that it remains only to perform certain necessary preliminary experiments before an apparatus can be constructed that will carry recording instruments to any desired altitude.²²

[60]

Appendix A

Theory of the Motion with Direct Lift

Let M = the mass of the suspended system, comprising the chamber together with any parts rigidly attached thereto

m_0 = the mass of the expelled charge, comprising wadding and the attached copper wire, the smokeless powder charge (and also, in the experiments in vacuo, the black powder priming charge)

V = the initial upward velocity of the mass M

v = the average downward velocity of the mass M_0

s = the upward displacement of the mass M

We have at once for the initial velocity of the mass M

$$V^2 = 2gs$$

and employing the conservation of momentum, we have for the kinetic energy per gram of mass m_0 , expelled,

$$\frac{v^2}{2} = \frac{M^2}{m_0^2} gs$$

Appendix B

Theory of Displacements for Simple Harmonic Motion

In addition to the notation given under Appendix A, the following additional notation must be employed:

Let m_s = the mass of the spring

F_1 = the force in dynes which produces unit extension of the spring

M_1 = the mass in dynes which produces unit extension of the spring

s = the upward displacement of M , resulting from the firing, that would be had if there were no friction

Then, allowing for the mass of the spring, we have, from the theory of simple harmonic motion:

$$Fx = \left(M + \frac{m_s}{3} \right) \left(\frac{2\pi}{P} \right)^2 x$$

where x is any displacement and p is the period of the motion,

[61] But V is the maximum velocity during the motion and hence $V = \omega s$, where s is the maximum displacement and ω is a constant, having the usual significance; also

$$P = \frac{2\pi}{\omega}$$

Hence

$$m_1 g = \left(M + \frac{m_3}{3} \right) \frac{V^2}{s^2}$$

But by the conservation of linear momentum,

$$\left(M + \frac{m_3}{3} \right) V = m_0 v$$

Hence

$$m_1 g = \left(M + \frac{m_3}{3} \right) \left(\frac{m_0 v}{M + m_3/3} \right)^2 \frac{1}{s^2}$$

giving, for the kinetic energy per gram of mass expelled,

$$\frac{v^2}{2} = \frac{(M + m_3/3)(m_1 g)}{2m_0^2} s^2$$

From this it is possible to obtain the efficiency, by dividing by the heat value of the powder, in ergs; and also the velocity in kilometers per second by multiplying by 2, extracting the square root, and dividing by 10^5 .

Correction of the Displacement s for Friction

The displacement s in the preceding calculation is assumed to be the corrected displacement. This is obtained from the upward displacement s_1 and the downward displacement s_2 , as

$$s = s_1 \sqrt{\frac{s_1}{s_2}}$$

Appendix C

Theory of Direct-lift Impulse Meter

The theory of the direct-lift impulse-meter is as follows:

Calling I the momentum of the gas that strikes the end of the aluminum cylinder,

m_c = the mass of the aluminum cylinder

V_c = the initial upward velocity of the cylinder

A_c = the area of cross section of the cylinder

A_g = the area of cross section of the suspended system comprising the gun, lead weight, and holders

s = the displacement of the aluminum cylinder, as obtained [62] from the trace on the smoked-glass tube

Thus we have, by the principle of the conservation of linear momentum, for the momentum per unit area produced by the gaseous rebound,

$$\frac{I}{A_c} = \frac{m_c V_c}{A_c} = \frac{m_c \sqrt{2gs}}{A_c}$$

Hence the momentum communicated to the suspended system by the gaseous rebound is

$$\frac{m_c A_g \sqrt{2gs}}{A_c}$$

and calling Q the ratio of the momentum given the gun by gaseous rebound to the observed momentum of the suspended system, we have

$$Q = \frac{m_c A_g \sqrt{2gs}}{m_0 A_c v}$$

Appendix D

Theory of Spring Impulse Meter

The theory of the spring impulse meter is as follows: If we use the same notation as in the preceding case, calling, in addition, the mass of the spring m , and the mass required for unit extension of the spring m_3 , we have, by the same theory as that for the gun suspended by a spring,

$$V_c = \frac{\sqrt{m_1 g}}{\sqrt{m_c + 1/3 m_3}}$$

Hence the momentum per unit area, communicated to the upper cap of the 12-in. pipe, when the chamber is fired, is

$$\frac{I}{A_c} = \frac{(m_c + 1/3 m_3) V_c}{A_c} = \frac{\sqrt{m_c + 1/3 m_3} \sqrt{m_1 g s}}{A_c}$$

Hence the momentum that would be communicated to the suspended system by the gaseous rebound, provided the system were at the top of the 12-in. pipe, would be

$$\frac{A_g \sqrt{m_c + 1/3 m_3} \sqrt{m_1 g s}}{A_c}$$

and the percentage Q of the momentum communicated by the gaseous rebound to the observed momentum of the suspended system is

$$Q = \frac{A_g \sqrt{m_c + 1/3 m_3} \sqrt{m_1 g s}}{A_c m_0 v}$$

[63]

Appendix E

Check on Approximate Method of Calculation for Small Charges Fired in Rapid Succession

Consider a rocket weighing 10 lb, having 2 lb of propelling material, fired 2 oz at a time, eight times per second, with a velocity of 6000 ft/sec—much less than the highest velocity attained in the experiments, either in air or in vacuo.

Let us suppose that, for simplicity, the rocket is directed upward and that each shot takes place instantly (a supposition not far from the truth); the velocity remaining constant between successive shots.

After the first shot, the mass, $9\frac{7}{8}$ lb, has an upward velocity v_0 is at once found by the conservation of momentum. But it is decreased by gravity until, at the end of $\frac{1}{8}$ sec, it is reduced to

$$v_0' = v_0 - gt$$

the space passed over during this time being

$$s = v_0t - \frac{1}{2}gt^2$$

We have then, $v_0' = 71.8$ ft/sec, and $s = 9.23$ ft.

At the beginning of the second interval of $\frac{1}{8}$ sec, and additional velocity is given the remaining mass, of 76.8 ft/sec, and the final velocity' and space passed over may be found in the same way. By completing the calculations for the remaining intervals we shall have for time just under $\frac{1}{2}$ sec,

$$v' = 293.1 \text{ ft/sec} \quad s = 91.93 \text{ ft}$$

for time just under 1 sec,

$$v_0' = 603.8 \text{ ft/sec} \quad s = 335.48 \text{ ft and}$$

for time just under 2 sec,

$$v_0' = 1284.1 \text{ ft/sec} \quad s = 1315.68 \text{ ft/sec}$$

These figures compare well with those in Table V, for s_1 . In the present check, air resistance would doubtless be unimportant until the velocity had reached 1000 ft/sec or so; but the velocity would, even if decreased somewhat by air resistance, compare favorably with that of a projectile fired from a gun.

No more elaborate calculation is necessary to demonstrate the importance of the device, even for military purposes alone; for it combines portability and cheapness (no gun is required for firing it) with a range which compares favorably with the best artillery. Further, all difficulties of the nature of erosion are, of course, avoided.

[64]

Appendix F

Proof that the Retardation between 500,000 Feet and 1,000,000 Feet is Negligible

The falling off of velocity w , due to air resistance, is given by

$$P \frac{p}{p_0} sh = \frac{1}{2} M_0 w_1^2$$

where P = the mean air resistance in poundals per square inch between the altitudes 500,000 and 1,000,000 ft from the previously mentioned velocity curves, the pressure being considered at atmospheric

P = the mean density over this distance

S = the mean area of cross section of the apparatus throughout the distance, taken as 25 sq in, in view of the the average mass M_0 throughout the interval

h = the distance traversed: 500,000 ft

It is thus found that the loss of velocity w is less than 10 ft/sec (for $a = 150$ ft/sec) even when p/p_0 is taken as constant throughout the distance and equal to that at 500,000 ft (i.e., 2.73×10^{-9}).

Appendix G

Probability of Collision with Meteors

The probability of collision with meteors of "visible" size is negligible. This can be shown by deriving an expression for the probability of collision of a sphere with particles moving in directions at random, all having constant velocity, the expression being obtained on the assumption that the speed of the sphere is small compared with the speed of the particles.

If we accept Newton's estimate⁷ of the average distance apart of meteors as being 250 miles, we have by considering collision between very small meteors of velocity 30 miles/sec, and a sphere 1 ft in diameter of velocity 1 mile/sec, moving over a distance of 220,000 miles, the probability 23 as 1.23×10^{-8} ; which is, of course, practically negligible. The value would be slightly greater if the meteors were considered as having a diameter of several centimeters, rather than being particles⁸; the probability would be less, however, if meteor swarms were avoided.

[65]

Notes

10. A step-by-step method of solution similar to that herein employed can evidently be used for oblique projection—other conditions remaining the same.

11. If the efficiency is estimated by the kinetic energy of the rocket itself (from the velocity the average mass of the rocket would acquire, by virtue of the recoil of the gases ejected with the "average velocity" measured), the efficiencies will, of course, be less than the two values given in Table 1, being, respectively, 0.39 and 0.50 percent.

12. Since this manuscript was written, rockets with a single charge, constructed along the general lines here explained, have been considerably further developed.

13. Chambers of considerably reduced weight have since been made and tested for velocities comparable to those here mentioned. For two particular types of loading device, the ratios of weight of chamber to weight of charge (here, 120) were, respectively 63 (also 30 for this case, but at a sacrifice of velocity) and 22; the ratio, for the nozzles, being reducible to comparatively small values. In neither of these cases was any special attempt made to reduce the weight of the chambers.

14. Later experiments support this prediction, and also demonstrate that firing of the charges can take place in rapid succession.

15. The values of c and $(1-k)$, here assigned, were chosen as being the largest that could reasonably be expected. Later experiments have shown that lower values are more easily realizable, but it should at the same time be understood that *no special attempt has been made to obtain experimentally the highest values of these quantities*. The numbers chosen may, then, be considered as at least possible limiting values.

It is well to mention, in this connection, that the developments with the multiple-charge rocket have, so far, exceeded original expectations. This is in accord with the fact that the experimental results have, from the start, been more favorable than were expected. Thus an efficiency of 50 percent was at first considered the limit of what could be attained, and 4000 to 5000 ft/sec, the highest possible velocity. Further it was naturally not expected that the velocities obtained in vacuo would actually exceed those in air; nor were chambers as light as those at present used considered producible without considerable experimental difficulty.

16. *Distribution of mass among the secondary rockets for cases of large total initial mass*. For very great altitudes, secondary rockets will be necessary, as already explained, in order to keep the proportion of propellant to total weight sensibly constant. The most extreme cases will require groups of secondary rockets, which groups are discharged in succession.

There are, under any circumstances, two possibilities: either the secondaries may be small, so that each time a secondary rocket, or group of secondaries, is discarded, the total mass is not appreciably changed, as indicated schematically at (a), Fig. 8; or a series of as large secondaries as possible may be used (b), Fig. 8, in which case the empty casings constitute a considerable fraction of the entire weight at the time the discarding takes place.

[66] Insofar as avoiding difficulties of construction is concerned, the use of a smaller number of larger secondaries is preferable, but they should be long and narrow, as otherwise the air resistance on the nearly empty casings will be greater for the same weight of propellant than would be the case (a), were used, in as compact an arrangement as possible. It should be explained, also, that if very small secondaries were employed, the metal of the magazines and casings would become a considerable fraction of the entire weight, as the amount of surface enclosing the propellant would then be a maximum.

7. Newton, *Encyc. Brit.*, 9 ed., v. 16.

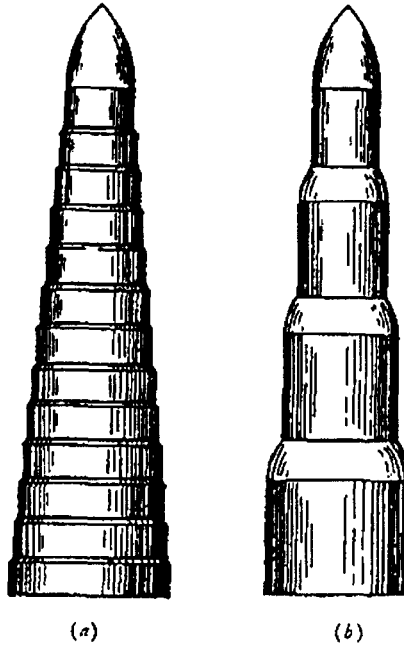

Fig. 8

Possibility of employing case (b). A rough calculation shows at once the possibility of using a comparatively small number of large secondaries [67] (or groups), provided, as is, of course, to be expected from dimensional considerations, that the larger any individual rocket, the less, in proportion, need be the ratio of weight of metal to weight of propellant.

Such a calculation can be made by finding the number of secondary rockets, for case (b), that would be required for the same total initial mass, other conditions being the same, as for continuous loss of mass with zero relative velocity, which is practically case (a).

For the latter, Eq. (7), in which R and g are neglected, is evidently sufficient for the purpose, for the reason that the form of the expression, so far as $(1-k)$ is concerned, is the same whether or not R and g are included.

Let us now find what conditions must hold for case (b), in order that the total initial mass shall equal that for case (a). Assume, first, that the casings are discarded successively at the end of n equal intervals of time, no mass being discarded except at these times; the velocity of gas ejection being c , as before. The total initial mass is obtained as the product of the initial masses for each interval, from Eq (7) with $k = 0$, assuming the final mass for each interval is, as before 1 lb, after first multiplying the initial masses by a greater factor than unity, the excess over unit being the weight h of the casings which are discarded at the end of the intervals.

If, in case (a), we divide the time into n equal intervals in the same way, we shall have, as the condition that the total initial masses are the same in the two cases,

$$M = \exp \frac{a(t/n)n}{c(1-k)} = (1+h)^n \exp \frac{a(t/n)n}{c} \tag{15}$$

We obtain, then, on combining (15) with (7),

$$M^k = (1+h)^n$$

from which

$$n = k \frac{\log M}{\log (1+h)} \tag{16}$$

Let us assume, for case (a) (many small secondary rockets), as well as for case (b) (large secondary rockets), that the ratio of mass of metal to mass of propellant is the minimum reasonable amount that can be expected, which may be put tentatively, at least, as 1:14 and 1:18, respectively.

Two cases will suffice for purpose of illustration: one in which the ratio of initial to final mass is moderately large, e.g., 40, and the other in which the ratio is extreme, e.g., 600.

The number of secondaries (or separate groups) for (b), for these two cases, are, from (16), 5 and 9 respectively, n being necessarily an integer.

It is to be understood that the numbers could be made even smaller, although this would necessitate larger total initial masses.

17. If the start were made at a greater elevation than 15,000 ft, for example, at 20,000 or 25,000 ft, the reduction of the "total initial mass" would, of course, be considerably greater. Further, if the rocket were of comparatively small mass, it could be raised to an even greater initial height by balloons.

18. Actually, 300 gm would be sufficient, for many researches.

19. Attention is called to the fact that hydrogen and oxygen, combining in atomic proportions, afford the greatest heat per unit mass of all chemical transformations. For this reason, if the calculations are made under the [68] assumption that hydrogen and oxygen are used (in the liquid or solid state, to avoid weight of the container), giving the same efficiency as that for which Infallible smokeless powder produces respective velocities of, for example, 5500 ft/sec and 7500 ft/sec, the velocities (deducting 218.47 cal/gm as the latent heat plus specific heat, from boiling point to ordinary temperature) would be 9400 ft/sec and 11,900 ft/sec; and the total initial masses for a start from 15,000 ft, respectively, 199 lb and 43.5 lb.

Incidentally, except for difficulties of application, the use of hydrogen and oxygen would have several other evident advantages.

20. This calculation is made under the assumption of stationary centers for the earth and moon.

21. The time of transit for the case under discussion would, of course, be comparatively large. If, however, the final velocity were to exceed by 1000 or 2000 ft/sec the velocity calculated, the time would be reduced to a day or two.

The time can be calculated from solution, by Plana (Memorie della Reale Accademia della Scienze di Torino, Ser. 2, vol. 20, 1863, pp. 1-86), of the analogous problem of the determination of the initial velocity and time of transit of a body, such as a volcanic rock, projected from the moon toward the earth.

22. At the time of signing of the Armistice, the net result of the development of a reloading mechanism had been the demonstration of an operative apparatus that was simple and travelled straight, with the essential parts sufficiently strong and light, using a few cartridges of simple form.

The work remaining, upon which progress has since been made, has been the adaptation of the device for a large proportionate weight of propellant.

23. The probable number of collisions here calculated is the sum of the probable numbers obtained by taking of velocity of the spherical body, and of the meteors, separately equal to zero.

Let v = velocity of the spherical body

V = velocity of the meteors

n = the number of meteors per unit volume, which number is, of course, a fraction
(mutual collisions between meteors being neglected)

S = the area of cross section of the spherical body

For $v = 0$, the meteors, if any, which strike the sphere during the time t to $t + dt$ will have come from a spherical shell of radii Vt and $V(t + dt)$, neglecting the diameter of the spherical body in comparison with that of the spherical shell. Further, the probable number in any small volume, in this shell, which are so directed as to strike the body, is

$$\frac{S}{4\pi V^2 t^2}$$

being the ratio of the solid angle subtended at the element, by the spherical body, to the whole solid angle 4π . Hence the probable number of collisions N , from all directions, between the time t_1 and t_2 is, evidently,

$$N = nSV(t_2 - t_1)$$

For $v \neq 0$, and expression of the same form is obtained for the probable number of meteors within the space swept out by the spherical body.

[68] The sum of these separate probable numbers is the number 1.23×10^{-8} in Appendix G.

In general, for any values of v and V , the meteors reaching the spherical body at successive instants come from a spherical surface of increasing radius Vt , with moving center distant vt in front of the initial position of the spherical body.

It should be explained that when v differs but little from V , the relative velocity of the body and meteors is small enough to be neglected, for meteors on this expanding spherical surface lying outside a certain cone, the vertex of which coincides with the moving center of the spherical body.

Also if v exceeds V , the only part of the expanding spherical surface which is to be considered is that lying outside the contact circle of the tangent cone, the vertex of which also coincides with the moving center of the spherical body.

Attention is called to the fact that, even if meteor swarms were not avoided, the probable number of collisions would be reduced if the direction of motion were substantially that of the swarm.

24. No difference in the calculation would be necessary if the radius of the sphere were to be increased by the diameter of the meteors, these being then considered as particles.