

# **NASA HISTORICAL DATA BOOK**

## **Volume III**

Programs and Projects 1969-1978

Linda Neuman Ezell

**The NASA Historical Series**



**Library of Congress Cataloging-in-Publication Data  
(Revised for vols. 2 and 3)**

Van Nimmen, Jane, 1937-

NASA historical data book, 1958-1968.

(The NASA historical series) (NASA SP ; 4012)

Includes bibliographical references and indexes.

Vols. 2 and 3 by Linda Neuman Ezell.

Contents: v. 1. NASA resources -- v. 2. Programs and projects, 1958-1968 -- v. 3. Programs and projects, 1969-1978.

I. United States. National Aeronautics and Space Administration. I. Bruno, Leonard C., joint author.

II. Ezell, Linda Neuman. III. Title. IV. Series.

V. Series: The NASA historical series.

TL521.312.V36

629.4'0973

74-600126

# PREFACE

The NASA Historical Data Book Series provides a statistical summary of the first 20 years of the National Aeronautics and Space Administration. NASA finances, personnel, and installations, 1958–1968, are covered in the first volume; while the second and third volumes provide information on the agency's major programs and projects for 1958–1968 and 1969–1978, respectively.

Congress established the civilian space agency in July 1958, when it passed the National Aeronautics and Space Act. NASA opened its doors the following October. The new organization was charged not only with expanding man's knowledge of the universe, but also with such monumental tasks as sending man to the moon. The story of NASA's first decade is one of enthusiasm, competition, growth, and success. Congress, the White House, and the public largely supported the young agency fiscally and morally. But after *Apollo 11's* exciting lunar landing and Neil Armstrong's first steps onto the moon in 1969, the attention of many of NASA's supporters turned elsewhere. The space agency would survive its second decade, but not with big budgets and large-scale programs.

President Richard M. Nixon urged NASA to build on the knowledge and experience of its first 10 years to develop programs that would lead to the solution of practical problems on earth. There would be no space spectaculars during the 1970s. Personnel cuts, minimal budgets, and more sober objectives would flavor the decade.

Like Volume II, this book covers NASA's six major program areas: launch vehicles, manned spaceflight, space science, space applications, tracking, and aeronautics and space research. Chapter 1 examines the expendable launch vehicle technology inherited from the first decade and looks at plans for the reusable Space Transportation System. The manned spaceflight story, chapter 2, starts with the successful Apollo lunar program and its follow-on projects, Skylab and Apollo-Soyuz, and likewise takes a look at the future of the Shuttle, whose approach and landing tests ended the decade. In chapter 3, the researcher will be guided through the many physics and astronomy and planetary projects of the 1970s that left investigators with a wealth of data on our near-earth environment and that of more distant worlds. Weather satellites, communications systems, and earth resources programs are outlined in chapter 4. The story of the resurgence of aeronautics at NASA is told in chapter 5. Tracking and data acquisition — its evolution on the ground and subsequent transformation into a satellite system — is the subject of chapter 6.

Each of the six chapters is divided into three sections. A narrative introduction, which includes information on the management of the program, is followed by

budget tables. These tables provide a fiscal history. The bulk of each chapter is devoted to describing the programs and flight projects. Major programs are subdivided into projects; for each flight a data sheet provides a physical description of the spacecraft and information on scientific experiments, participants, and contractors.

The authors of the series have made no attempt to interpret the events; instead they have provided only facts and figures. We do not expect you to read the entire series or even an entire volume, but we do hope that students, managers, and other users will find this series to be a quick reference to the first two decades of NASA activities, and that it will help them answer their specific questions.

Volumes II and III were prepared under contract, sponsored by the NASA History Office. The author is indebted to the staff of that office for their assistance, patience, and criticism.

Linda Neuman Ezell  
Fall 1985

# CONTENTS

Preface .....	iii
Chapter One: Launch Vehicles .....	1
Chapter Two: Manned Spaceflight .....	51
Chapter Three: Space Science .....	125
Chapter Four: Space Applications .....	233
Chapter Five: Aeronautics and Space Research .....	347
Chapter Six: Tracking and Data Acquisition .....	383
Notes .....	429
Appendix A: Organization Charts .....	435
Appendix B: Sounding Rocket Flights (1969-1978) .....	443
Notes on Sources .....	465
Index .....	469
About the Author .....	485



Lined writing area consisting of 25 horizontal lines.

---

CHAPTER ONE  
**LAUNCH VEHICLES**







## CHAPTER ONE

# LAUNCH VEHICLES

### INTRODUCTION

The stable of launch vehicles assembled by the National Aeronautics and Space Administration during its first decade, 1958–1968, was necessarily a mixture of military boosters, which were readily available when the agency was established in October 1958; and custom-designed vehicles developed by NASA and by private industry for NASA during the 1960s. The space agency used 22 different launch vehicles during its first 10 years of operations, but only 9 during the second 10 years.\* The early days of experimenting were over, and NASA settled down with a small number of reliable configurations (figs. 1-1 and 1-2). Advanced planners had hoped to pare that number even further with the introduction of a reusable spacecraft-launch vehicle system during the late 1970s. However, a declining national interest in the civilian space program as well as a declining economy forced a delay in the development of NASA's reusable Space Transportation System and a continued dependence on "expendable" launch vehicles.

Through 1975, NASA's manned space program continued to depend on the Saturn family of vehicles (Saturn IB and Saturn V), developed during the 1960s to support the Apollo lunar exploration venture. The three Apollo astronauts who participated in the joint U.S.–USSR Apollo–Soyuz Test Project in 1975 were the last Americans scheduled to ride conventional "rockets" into space. The next generation would wait for the reusable Shuttle. The agency's unmanned satellites and interplanetary probes relied on three proven vehicles—Atlas–Centaur, Scout, and Thor–Delta—and one new hybrid, Titan IIIE–Centaur.\*\*

But many of the payloads sent to orbit by NASA's launchers were not sponsored by the agency. During the 1970s, other government agencies, private firms, and foreign countries came to depend increasingly on NASA as a launching service. During 1969–1978, NASA successfully orbited 96 payloads for other organizations: 61

---

\* These numbers do not include the several variations of Thor boosters and Delta upper stages with which NASA experimented during this time.

\*\* The three other vehicles used were Atlas F (one time in 1978), Thorad-Agena D (four times in 1969–1970), and Titan IIIC (one time in 1973).

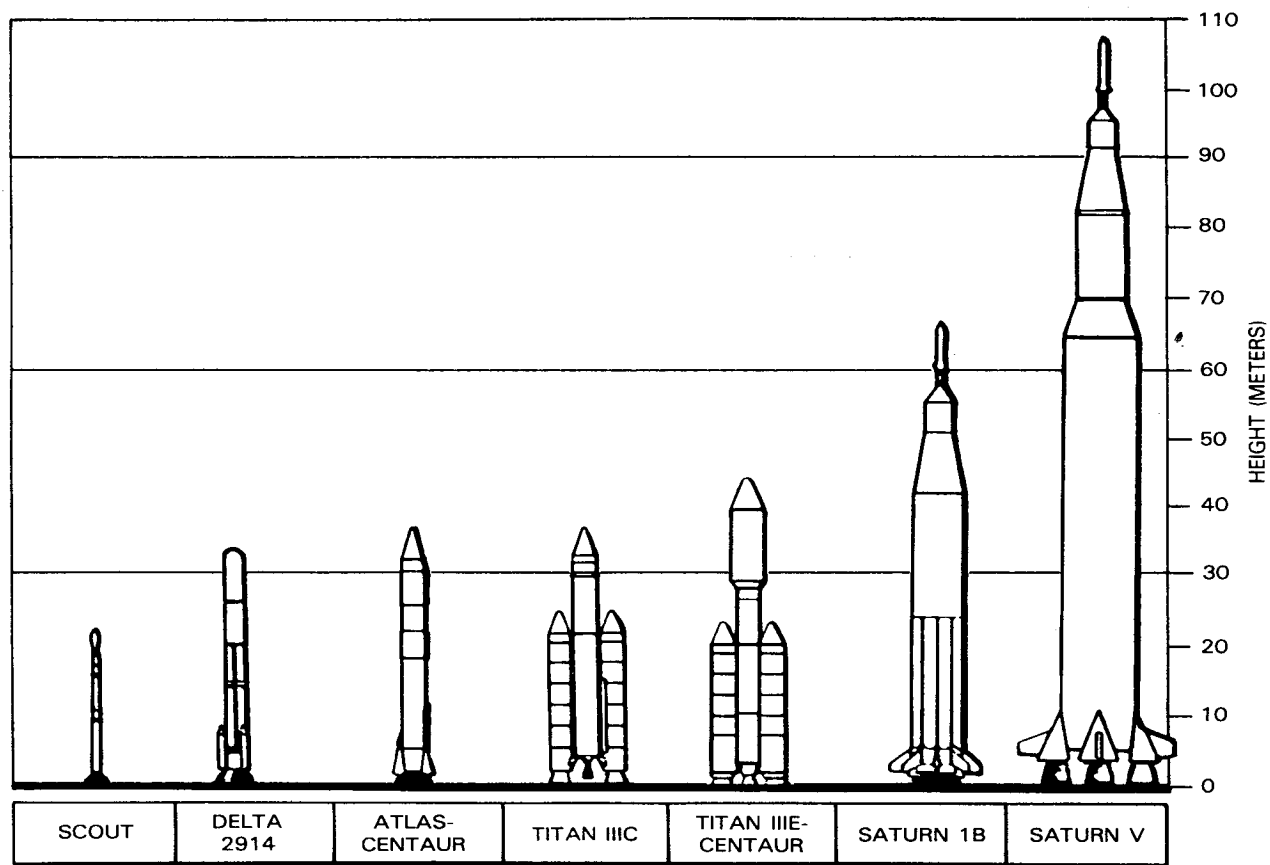

Figure 1-1. Expendable Launch Vehicles, 1974

Source: NASA Headquarters, SV75-15217, Nov. 13, 1974.

with Thor-Delta (68.5% of the spacecraft successfully launched by that vehicle); 17 with Scout (63%); 16 with Atlas-Centaur (57%); and 2 with Titan IIIE-Centaur (28.6%). The users included the U.S. Navy, the U.S. Air Force, the National Oceanic and Atmospheric Administration (NOAA), Western Union, RCA, France, Japan, Indonesia, Italy, the United Kingdom, the Netherlands, West Germany, Spain, the European Space Agency (ESA), and Intelsat. The most common payloads were communications and weather satellites. NASA provided launching services on a reimbursable basis, the other organizations being responsible for all "reasonable costs and charges related to launch vehicles and other equipment, materials, and services."\*<sup>1</sup>

This chapter will provide the researcher with information on the management of NASA's launch vehicle program, the agency's launch vehicle budget (including a general introduction to the budget process), and the characteristics of each launch vehicle family used by NASA during 1969-1978. For data on those vehicles used before 1969, consult Linda Neuman Ezell, *NASA Historical Data Book, 1958-1968, Vol. 2, Programs and Projects*, NASA SP-4013 (Washington, D.C., 1986), chapter 1.

\* Consult chapters 3 and 4 for more information on space science and applications payloads.

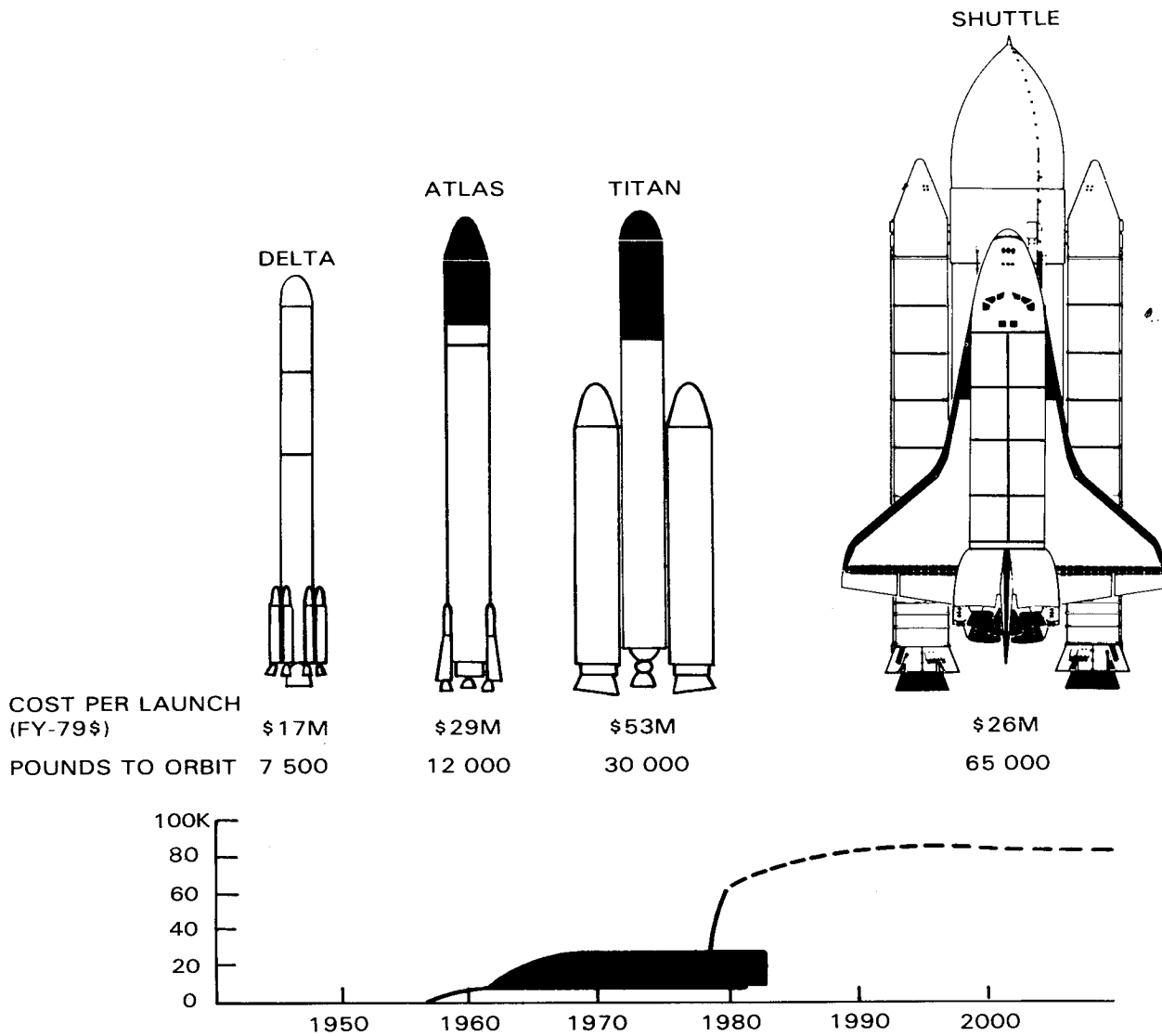

Figure 1-2. NASA Space Transportation Systems, 1978. At the end of NASA's second decade, the agency was looking at these four vehicles to provide most of the civilian launches during the 1980s. Advanced planners were predicting that the reusable Shuttle would eventually make conventional expendable boosters obsolete.

### Managing the Launch Vehicle Program

Launch vehicle management during NASA's second decade was led by Joseph B. Mahon, who became director of the launch vehicle and propulsion program in the Office of Space Science and Applications in 1967. Until 1976, Mahon had authority for only those vehicles used to launch unmanned payloads (table 1-1, Phase I). Saturn came under the purview of the Office of Manned Space Flight, but NASA's largest launchers were not assigned a single manager at Headquarters. Instead, authority for the Apollo program was divided five ways: program control, systems engineering, testing, flight operations, and reliability and quality. For example, the director for testing was concerned with all components of the spacecraft and

Table 1-1. Three Phases of Launch  
Vehicle Management, NASA Headquarters\*

Phase I

January 1969–September 27, 1975

Administrator/Deputy Administrator

Associate Administrator, Office of Space Science and Applications (John E. Naugle; Noel W. Hinners, June 1974)

Director, Launch Vehicle and Propulsion Program (Joseph B. Mahon)

Chief, Program Review and Resource Management (Edward J. Kunec)

Technical Assistant (Jay A. Salmanson); added 1972

Manager, Medium Launch Vehicles Program (Theodrick B. Norris; vacant, mid-1974–1975)

Manager, Improved Centaur (William L. Lovejoy; vacant, fall–winter 1973); added 1970; dropped early 1974

Manager, Atlas–Centaur (Norris, acting, 1969; F. Robert Schmidt, 1970)

Manager, Titan III (Norris, acting, 1970–1973; Roger Mattson, 1974; vacant, mid-1975); added 1970

Manager, Small Launch Vehicles and International Program (Robert W. Manville; Isaac T. Gillam, IV, June 1973)

Manager, Agena (Lovejoy; Manville, acting, 1970–1973); dropped fall 1973

Manager, Delta (Gillam; Peter Eaton, June 1973)

Manager, Scout (Paul E. Goozh)

Manager, Advanced Program and Technology Program (Joseph E. McGolrick)

Manager, Advanced Planning (B. C. Lam); added 1971

Manager, Supporting Research and Technology (Joseph W. Haughey); added 1971

Phase II

September 28, 1975–Fall 1976

Administrator/Deputy Administrator

Associate Administrator, Office of Space Flight (John F. Yardley)

Director, Expendable Launch Vehicles Program (Mahon)

Chief, Program Review and Resource Management (Kunec)

Technical Assistant (Salmanson)

Manager, Interim Upper Stage (Jack W. Wild); added early 1976

Manager, Medium Launch Vehicle Program (Mahon, acting)

Manager, Atlas–Centaur (Schmidt)

Manager, Titan III (vacant, 1975; Lam, early 1976)

Manager, Small Launch Vehicles and International Program (Gillam; Mahon, acting, early 1976)

Manager, Delta (Eaton)

Manager, Scout (Goozh)

Manager, Atlas F (Salmanson); added early 1976

Manager, Advanced Program and Technology Program (McGolrick)

Manager, Advanced Planning (Lam); dropped early 1976

Manager, Supporting Research and Technology (Haughey); dropped early 1976

Director, Advanced Studies (Wild); added mid-1976

Table 1-1. Three Phases of Launch  
Vehicle Management, NASA Headquarters (Continued)

Phase III  
Fall 1976–December 1978

Administrator/Deputy Administrator

Associate Administrator, Office of Space Flight; changed to Office of Space Transportation Systems, November 1977 (Yardley)

Director, Expendable Launch Vehicles Program (Mahon)

Deputy Director, Expendable Launch Vehicles Program (Robert O. Aller); added 1978

Chief, Program Review and Resource Management (Kunec)

Director, Small and Medium Launch Vehicles Program (McGolrick)

Manager, Atlas-Centaur (Schmidt)

Manager, Titan III (Lam)

Manager, Delta (Eaton)

Manager, Scout (Goozh)

Manager, Atlas F (Salmanson)

Director, Upper Stages (Wild)

Chief, Space Transportation Systems Support Projects (Aller, acting, mid-1978; William D. Goldsby, winter 1978); added mid-1978

---

\* See also table 2-1 for details on Apollo, Skylab, and Shuttle management; and table 5-1 for details on the management of advanced propulsion programs (chemical and nuclear).

launch vehicle that required testing. Since the early 1960s, the Office of Advanced Research and Technology (OART) had been charged with managing advanced chemical propulsion research, but this responsibility was dropped from OART's mission in late 1970. During the 1970s, NASA managers began making the distinction between "expendable" boosters (traditional vehicles designed for one-time use) and reusable space transportation systems (a shuttle orbiter and some reusable booster vehicle). This trend toward reusability at the end of the Apollo era prompted a reorganization of the launch vehicle program.

In late September 1975, Mahon and his launch vehicle managers were moved from the Office of Space Science and Applications, where they had been since 1961, to the newly formed Office of Space Flight, which was under the direction of Associate Administrator John F. Yardley (table 1-1, Phase II). Mahon had several vehicle managers to help him oversee NASA's expendable launch vehicle program: F. Robert Schmidt (Atlas-Centaur), B. C. Lam (Titan III), Peter Eaton (Delta), Paul E. Goozh (Scout), and Jay A. Salmanson (Atlas F). In 1976, Jack W. Wild was given responsibility for managing studies and proposals for Shuttle interim upper stages. Also assisting Mahon during the 1970s were Edward J. Kunec (program review and resource management) and Joseph E. McGolrick (advanced programs, 1969-1976). In the fall of 1976, the management of the expendable launch vehicle program was tightened (table 1-1, Phase III). McGolrick became director of small and medium boosters, with the five vehicle managers reporting to him. In 1978, Mahon was assigned a deputy director, Robert O. Aller, and a chief for space transportation systems support projects, William D. Goldsby. The Office of Space Flight was renamed the Office of Space Transportation Systems in November 1977, but the change did not affect the launch vehicle directorate.

## NASA'S BUDGET: AN INTRODUCTION

Congress reacted generously to President John F. Kennedy's declaration in 1961 that the U.S. would land a manned spacecraft on the moon before the end of the decade. For six consecutive years, the legislators approved budgets for NASA that surpassed the previous year's funding level (table 1-2). In 1966, however, the trend reversed. With major Apollo research and development tasks completed and with much of the hardware needed for the lunar missions already procured, Congress started chipping away at the space agency's annual budget requests. One journalist predicted in 1968 that NASA's "seven fat years" were behind it; "seven lean years" loomed ahead.<sup>2</sup>

Unfortunately for the supporters of an aggressive program of space exploration and exploitation, NASA had to make do with meager appropriations throughout its second decade. Funds for the civilian space program dropped steadily from 1966 to 1972, increased slightly in 1973, fell again in 1974, and then began slowly building in 1975. By the end of the second 10 years, NASA's budget had risen to the point where it was equivalent to 77 percent of its fattest year's budget (1965). But deflated 1978 dollars did not buy an equal percentage of goods and services for the agency.

Minimal funding necessarily led to austere programs. The number of Apollo flights to the moon was reduced; plans for manned missions to Mars were scrapped; the schedule for an advanced reusable launch vehicle and spacecraft was stretched. None of the presidents who occupied the White House during the 1970s was committed to an ambitious space policy. And on Capitol Hill, some lawmakers became critical of the Apollo "moondoggle" once it became clear that there was no race to the moon against the USSR. Tax dollars, they reasoned, could be more wisely spent on war materiel going to southeast Asia, on rebuilding cities left battered by riots, on healing wounds left by racial unrest and poverty. In their budget messages to Congress, Presidents Lyndon B. Johnson (FY 1969-70), Richard M. Nixon (FY 1971-74), and Gerald R. Ford (FY 1975-78)\* expressed the need for a continued strong defense program (through 1972 the war in Vietnam was the biggest single drain on the defense budget), for a renewed emphasis on human resources programs (health, education, and welfare), and for a stable economy.

Science and technology projects were not ranked highly on any of the chief executives' priority lists.<sup>3</sup> Until the FY 1976 budget message was issued, however, space research and technology at least stood alone as an item on the Office of Management and Budget's (OMB) "outlays-by-function" list. In FY 1976, it was included in a new budget category: general science, space, and technology. In addition to NASA's programs, the National Science Foundation and the Energy Research and Development Administration (ERDA)/Department of Energy's (DOE) budget requests were included under this new rubric. During the 1970s, the U.S. spent on the average \$90.35 billion each year on national defense, \$174.13 billion on human resources\*\*, and \$4.51 billion on general science, space, and technology (table 1-3).<sup>4</sup>

---

\* The president's budget request for a fiscal year was usually delivered to Congress at least a full calendar year in advance. Therefore, it was not uncommon for a new chief executive to inherit a budget from his predecessor.

\*\* Included in this category were community and regional development; education, training, employment, and social services; health; income security; and veteran's benefits and services.

Table 1-2. Summary of NASA Authorizations and Appropriations, FY 1959-1979  
(in thousands of dollars)

Fiscal Year	Budget Request	Authorization	Appropriation
1959	426 674	405 807	369 406
1960	508 300	490 300	485 075
1961	967 337	972 731	966 731
1962	1 940 300	1 855 300	1 825 250
1963	3 787 276	3 744 115	3 674 115
1964	5 712 000	5 350 820	5 100 000
1965	5 445 000	5 227 506	5 250 000
1966	5 260 000	5 190 396	5 175 000
1967	5 012 000	5 000 419	4 968 000
1968	5 100 000	4 865 751	4 588 900
1969	4 370 400	4 013 073	3 995 273
1970	3 771 877	3 768 110	3 749 216
1971	3 376 944	3 454 822	3 312 619
1972	3 312 722	3 396 322	3 310 122
1973	3 407 650	3 444 150	3 407 650
1974	3 053 786	3 102 100	3 039 700
1975	3 267 104	3 286 904	3 231 145
1976	3 558 986	3 579 110	3 551 822
Transition Quarter	966 017	932 267	932 145
1977	3 728 777	3 821 745	3 819 090
1978	4 080 989	4 095 190	4 063 701
1979	<u>4 371 600</u>	<u>4 401 600</u>	<u>4 350 200</u>
Total	75 425 739	74 398 538	73 165 160

Source: NASA Comptroller, "Chronological History, Fiscal Year 1959-1979 Budget Submissions," n.d.

Because of the complexity of the budget process, federal agencies were obliged to make their fiscal plans as much as two years in advance. In any one year, NASA's resource management personnel were working with three fiscal year budgets—the current operating budget; the ensuing year's budget, which was somewhere in the Bureau of the Budget/Office of Management and Budget-presidential-congressional approval cycle; and the preliminary budget for the next year, which was being drawn up at NASA Headquarters based on requests for programs and projects submitted by the agency's several field centers. Because of the fierce competition for a shrinking number of dollars, NASA managers at all levels worked hard to justify their requests—internally and externally. For some NASA managers, fighting to preserve minimum funding and keeping members of Congress informed and sympathetic to the agency's needs was a full-time job (table 1-4).

NASA's budget was divided into three accounts: research and development (R&D), research and program management\* (called administrative operations in FY

\* Research and program management (RPM) funds were used for necessary expenses of research in laboratories, management of programs and other activities not otherwise provided for, including uniforms or allowances, minor construction, awards, hire, maintenance, and operation of administrative aircraft, purchase and hire of passenger motor vehicles, and maintenance, repair, and alteration of real and personal property. The construction of facilities account provided for advance planning, design, and construction of facilities and for the acquisition or condemnation of real property.

1969), and construction of facilities. R&D and construction of facilities were funded on a no-year basis; that is, the funds were made available over an undefined multiyear period until they were expended. Research and program management could not exceed 5 percent of the total appropriation. NASA was permitted to reprogram internally among the three accounts, with transfer authority limited to 0.5% of the total R&D authorization. This volume will consider R&D funds only. For budget purposes, R&D was defined to include "research, development, operations, services, minor construction, . . . maintenance, repair, and alteration of real and personal property; and purchase, hire, maintenance, and operation of other than administrative aircraft necessary for the conduct and support of aeronautical and space research and development activities. . . ."<sup>5</sup>

The Bureau of the Budget/Office of Management and Budget (the Bureau of

Table 1-3. U.S. Government Budget Outlays by Function, FY 1969-1979  
(in billions of dollars)

Outlays by Function	1969	1970	1971	1972	1973	1974	1975	1976	1977	1978	1979
National defense	\$79.4	\$78.6	\$75.8	\$76.6	\$74.5	\$77.8	\$85.6	\$89.4	\$22.3	\$97.5	\$105.2
International affairs	4.6	4.3	4.1	4.7	4.1	5.7	6.9	5.6	2.2	4.8	5.9
General science, space and technology	5.0	4.5	4.2	4.2	4.0	4.0	4.0	4.4	1.2	4.7	4.7
Energy	1.0	1.0	1.0	1.3	1.2	0.8	2.2	3.1	0.8	4.2	5.9
Natural resources and environment	2.8	3.0	3.9	4.2	4.8	5.7	7.3	8.1	2.5	10.0	10.9
Agriculture	5.8	5.2	4.3	5.3	4.9	2.2	1.7	2.5	0.6	5.5	7.7
Commerce and housing credit	0.5	2.1	2.4	2.2	0.9	3.9	5.6	3.8	1.4	*	3.3
Transportation	6.5	7.0	8.1	8.4	9.1	9.2	10.4	13.4	3.3	14.6	15.4
Community and regional development	1.5	2.4	2.9	3.4	4.6	4.1	3.7	4.8	1.3	6.3	11.0
Education, training, employment, and social services	7.5	8.6	9.8	12.5	12.7	12.3	15.9	18.7	5.2	21.0	26.5
Health	11.8	13.1	14.7	17.5	18.8	22.1	27.6	33.4	8.7	38.8	43.7
Income security	37.3	43.1	55.4	63.9	73.0	84.4	108.6	127.4	32.8	137.9	146.2
Veteran's benefits and services	7.6	8.7	9.8	10.7	12.0	13.4	16.6	18.4	4.0	18.0	19.0
Administration of justice	0.8	1.0	1.3	1.6	2.1	2.5	2.9	3.3	0.9	3.6	3.8
General government	1.6	1.9	2.0	2.4	2.6	3.2	3.1	2.9	0.9	3.3	3.7
General purpose fiscal assistance	0.4	0.5	0.5	0.7	7.4	6.9	7.2	7.2	2.1	9.5	9.6
Interest	15.8	18.3	19.6	20.6	22.8	28.0	30.9	34.5	7.2	38.0	44.0
Undistributed offsetting receipts	-5.5	-6.6	-8.4	-8.1	-12.3	-16.7	-14.1	-14.7	-2.6	-15.1	-15.8
Total budget outlays	184.5	196.6	211.4	232.0	247.1	269.6	326.2	366.4	94.7	402.7	450.8

\* \$50 million or less.

Source: Executive Off. of the President, Off. of Management and Budget, *The United States Budget in Brief, Fiscal Year 1979*, Washington, 1978), pp. 74-75; and Executive Off. of the President, Off. of Management and Budget, *The United States Budget in Brief, Fiscal Year 1981* (Washington, 1980), p. 71.



Table 1-4. Simplified Steps of the NASA Budget Process\*

1. Program Operating Plans submitted quarterly to NASA Headquarters program offices by field installation project-program offices.
2. First draft of preliminary budget prepared by NASA Headquarters.
3. First internal NASA semiannual budget review (March).
4. Preliminary budget review by Bureau of the Budget/Office of Management and Budget (BoB/OMB), which led to NASA-BoB/OMB negotiations and BoB/OMB targets (summer).
5. Second internal NASA semiannual budget review (fall).
6. Formal submission of requests to BoB/OMB (September 30).
7. Formal submission of the President's budget to Congress; requests readied and justified for review by congressional authorization and appropriation committees (January).
8. Initial hearing before House and Senate authorization committees, including testimony by NASA officials, followed by reporting out of an authorization bill.
9. Similar review by House and Senate appropriations subcommittees.
10. Debate on floor of House and Senate, followed by passage of NASA authorization and appropriation acts.
11. Act signed into law by President.

\* The Congressional Budget Act of 1974 established October 1 as the start of the fiscal year, as of FY 1977. Prior to FY 1977, the fiscal calendar began with the month of July. The shift gave the lawmakers time to implement the expanded budget-making procedures called for by the Act. To meet budgetary obligations for the period between the end of FY 1976 and the beginning of FY 1977, the Act called for a three-month transition quarter. The new congressional schedule did not greatly disrupt NASA's internal budget preparation schedule for FY 1977-1978.

the Budget was renamed the Office of Management and Budget in 1971) was responsible for most of the cuts suffered by NASA budgets months before Congress acted on the requests.<sup>6</sup> In the tables that follow, the "request" column represents the amounts agreed to by NASA and BoB/OMB, not necessarily the initial request NASA made to the president's budget officer. Data on submissions (requests) for this volume are taken from the yearly budget estimates prepared by NASA's Office of Administration, Budget Operations Division, and from chronological histories prepared for each fiscal year by that same office. In Congress, the authorization committees and their several subcommittees intensely examined NASA's requests and the programs for which the funds would be spent.\* The authorization committees, which had the authority to increase or decrease budget requests, set a maximum for appropriation of funds; they imposed limitations or preconditions on how funds could be spent; and they determined how the agency could reprogram or transfer its monies among accounts. The "authorization" column in the following tables is the ceiling set by the authorization committees. Authorizations were not always listed for individual projects in the chronological histories. To determine the total amount authorized for the general category or program for a specific project, consult the chronological histories.

\* Along with many other agency and office requests, NASA's budget submissions were considered by Congress under the title: Independent Offices and Department of Housing and Urban Development. Examples of other "independent offices" include the National Science Foundation, the General Services Administration, the Federal Home Loan Bank Board, and the Federal Trade Commission.

The appropriations committees had the power to make further adjustments to budget requests. Generally, however, the appropriations committees did not scrutinize NASA's budgets as closely as did the authorization subcommittees and made few substantive changes to the amounts authorized. There are no appropriations columns in the project and program budget tables in this volume. However, table 1-5 provides a summary of appropriations for the three general NASA accounts. Data on authorizations and appropriations for this volume are taken from the annual chronological histories mentioned above. The last column in the project-program budget tables, "programmed," represents the funds spent during the fiscal year as reported in the NASA budget estimates. (For example, funds programmed in FY 1974 were reported as "actual" figures in the FY 1976 estimate volume). To account for every dollar expended for a NASA research and development project, one would also have to consider special facilities built to support a particular project, support activities, and the like.<sup>7</sup>

Table 1-5. NASA Appropriations, 1969-1978  
(in thousands of dollars)

Fiscal Year	Research & Development	Construction of Facilities	Research & Program Management <sup>a</sup>
1969	3 370 300	21 800	603 173
1970	3 006 000	53 233	637 400
1971	2 565 000	24 950	678 725
1972	2 522 700	52 700	722 635
1973	2 600 900	77 300	729 450
1974	2 194 000	101 100	707 000
1975	2 326 580	140 155	759 975
1976	2 677 380	82 130	792 312
1977	2 761 425	118 090	813 000
1978	3 013 000	160 940	889 761

<sup>a</sup> Called administrative operations in FY 1969.

Table 1-6. NASA Research and Development Funds, 1969-1978  
(in thousands of dollars)

Fiscal Year	Request	Authorization	Appropriation	Programmed
1969	3 677 200	3 370 300	3 370 300	3 068 782
1970	3 051 427	3 019 927	3 006 000	3 090 772
1971	2 606 100	2 693 100	2 565 000	2 542 362
1972	2 517 700	2 603 200	2 522 700	2 508 386
1973	2 600 900	2 637 400	2 600 900	2 488 475
1974	2 197 000	2 245 500	2 194 000	2 310 882
1975	2 346 015	2 372 815	2 326 580	2 323 563
1976	2 678 380	2 687 180	2 677 380	2 677 380
1977	2 758 925	2 761 425	2 761 425	2 883 425
1978	3 026 000	3 041 500	3 013 000	2 754 100

## Money for Launch Vehicles

Following a pattern set during the 1960s, NASA purchased the launch vehicles (Saturn IB and Saturn V) it needed for manned missions (Apollo and Skylab) with manned spaceflight funds. All others were obtained through the Office of Space Science and Applications' (or Office of Space Science's) Launch Vehicle Procurement Office through FY 1976.

In FY 1973, funds for Shuttle came from the Office of Manned Space Flight's (OMSF) spaceflight operations budget. Because of the growing importance of Shuttle, in FY 1974 a separate OMSF Shuttle account (distinct from spaceflight operations) was adopted. In FY 1977, the Office of Space Flight replaced OMSF. This new office assumed the management of expendable launch vehicles as well as the Space Transportation System (Shuttle).

Table 1-7 summarizes the programmed costs of the launch vehicles NASA used during its second decade of operations, followed by tables detailing the budget history of each vehicle and of supporting research and technology/advanced studies. Only the engine-booster components (main engine, solid rocket booster, and external tank) have been included in the Space Shuttle table (table 1-16); for more on the Space Transportation System see chapter 2. Refer to the footnotes for each table before drawing conclusions about totals for any one vehicle or one year.

Table 1-7. Programmed Costs by Launch Vehicle  
(in thousands of dollars)

Vehicle	1969	1970	1971	1972	1973	1974	1975	1976	1977	1978
Agena	11 300	5 000	---	---	---	---	---	---	---	---
Atlas F	---	---	---	---	---	---	---	3 400	11 800	6 300
Centaur	44 200	46 019	66 000	82 200	120 700	106 000	75 400	134 500 <sup>a</sup>	84 000	41 458
Delta	24 300	32 400	37 500	41 000	76 000	60 200	51 800	51 100 <sup>b</sup>	44 900	70 400
Saturn IB	42 276 <sup>c</sup>	---	25,659 <sup>e</sup>	39 582 <sup>e</sup>	---	13 000 <sup>g</sup>	---	---	---	---
Saturn V	535 710 <sup>i</sup>	486 691 <sup>i</sup>	189 059 <sup>j</sup>	162 096 <sup>j</sup>	---	---	---	---	---	---
Scout	12 600	13 700	13 200	15 100	15 700	7 800	12 300	14 000 <sup>m</sup>	10 700	16 342
Space Shuttle engine/ booster components	---	---	20 900 <sup>n</sup>	58 900 <sup>o</sup>	40 543 <sup>p</sup>	108 974 <sup>q</sup>	150 443 <sup>r</sup>	373 040 <sup>s</sup>	371 600 <sup>t</sup>	402 988 <sup>u</sup>
Titan IID	3 100	6 700	4 100	9 000	5 500	---	---	---	---	---
Supporting research and technology/advanced studies	4 400	4 000	4 100	4 000	3 100	4 000	---	---	---	---

<sup>a</sup>Includes \$24 400 000 from the transition quarter.

<sup>b</sup>Includes \$9 300 000 from the transition quarter.

<sup>c</sup>From the Apollo budget. \$52 645 000 was programmed for Apollo applications space vehicles, including Saturn IB; the FY 1971 budget estimate does not indicate the exact amount programmed for launch vehicles.

<sup>d</sup>\$63 330 000 was programmed for Skylab space vehicles, including Saturn IB; the FY 1972 budget estimate does not indicate the exact amount programmed for launch vehicles.

<sup>e</sup>From the Skylab budget.

<sup>f</sup>The FY 1975 budget estimate does not indicate how Skylab funds were programmed in FY 1973. It was estimated in the FY 1974 budget estimate that \$65 300 000 would be programmed in FY 1973 for Saturn IB.

<sup>g</sup>From the ASTP budget. The FY 1975 and 1976 budget estimates do not indicate how Skylab funds were programmed in FY 1974.

<sup>h</sup>The FY 1977 budget estimate does not indicate how ASTP funds were programmed in FY 1975; the FY 1976 budget estimate predicts that \$32 500 000 would be programmed for Saturn IB in FY 1975.

<sup>i</sup>From the Apollo budget.

<sup>j</sup>Includes \$157 996 000 from the Apollo budget and \$4 100 000 from Skylab.

<sup>k</sup>The FY 1975 budget estimate does not indicate how Apollo and Skylab funds were programmed in FY 1973; the FY 1974 budget estimate predicts that \$26 300 000 would be programmed for Saturn V from the Apollo budget and \$56 600 000 from the Skylab budget.

<sup>l</sup>The FY 1975 and 1976 budget requests do not indicate how Skylab funds were programmed in FY 1974.

<sup>m</sup>Includes \$3 400 000 from the transition quarter.

<sup>n</sup>For engine definition.

<sup>o</sup>Includes \$45 100 000 for main engine development and \$13 800 000 for definition studies.

<sup>p</sup>For main engine development.

<sup>q</sup>Includes \$82 307 000 for main engine development; \$8 567 000 for solid rocket booster development; and \$18 100 000 for external tank development.

<sup>r</sup>Includes \$95 300 000 for main engine development; \$21 143 000 for solid rocket booster development; and \$34 000 000 for external tank development.

<sup>s</sup>Includes \$140 800 000 (plus \$37 900 000 from the transition quarter) for main engine development; \$82 240 000 (plus \$26 000 000) for external tank development; and \$65 700 000 (plus \$20 400 000) for solid rocket booster development.

<sup>t</sup>Includes \$182 200 000 for main engine development; \$84 000 000 for external tank development; \$100 400 000 for solid rocket booster development; and \$5 000 000 for main engine production.

<sup>u</sup>Includes \$197 400 000 for main engine development; \$88 030 000 for external tank development; \$104 998 000 for solid rocket booster development; and \$12 560 000 for main engine production.

<sup>v</sup>Supporting research and technology/advanced studies was dropped as a line item in the FY 1977 budget estimate; in the FY 1976 budget estimate it was predicted that \$4 000 000 would be programmed in FY 1975. Tasks formerly funded by supporting research and technology/advanced studies monies were assumed by the spaceflight operations program.

<sup>w</sup>Supporting research and technology/advanced studies was dropped as a line item in the FY 1977 budget estimate. Tasks formerly funded by supporting research and technology/advanced studies monies were assumed by the spaceflight operations program.

Table 1-8. Launch Vehicle Supporting Research and Technology/Advanced Studies  
Funding History  
(in thousands of dollars)

Year	Request	Authorization	Programmed
1969	4 000	---- <sup>a</sup>	4,400
1970	4 000	4 000	4 000
1971	3 000	3 000	4 100
1972	4 000	4 000	4 000
1973	4 000	4 000	3 100
1974	4 000	4 000	4 000
1975	4 000	4 000	---- <sup>b</sup>
1976	1 000	1 000	---- <sup>c</sup>

<sup>a</sup>Of the \$128 300 000 request for launch vehicle procurement (excluding Saturn), \$115 700 000 was authorized; the chronological history does not indicate from which line item(s) the \$12 600 000 was deducted.

<sup>b</sup>Supporting research and technology/advanced studies was dropped as a line item in the FY 1977 budget estimate; in the FY 1976 budget estimate it was predicted that \$4 000 000 would be programmed in FY 1975. Tasks formerly funded by supporting research and technology/advanced studies monies were assumed by the spaceflight operations program.

<sup>c</sup>Supporting research and technology/advanced studies was dropped as a line item in the FY 1977 budget estimate; tasks formerly funded by supporting research and technology/advanced studies monies were assumed by the spaceflight operations program.

Table 1-9. Agena Funding History  
(in thousands of dollars)

Year	Request	Authorization	Programmed
1969	14 000 <sup>a</sup>	---- <sup>b</sup>	11 300
1970	6 300 <sup>c</sup>	6 300	5 000

<sup>a</sup>\$4 400 000 of which was requested for Thor boosters.

<sup>b</sup>Of the \$128 300 000 request for launch vehicle procurement (excluding Saturn), \$115 700 000 was authorized; the chronological history does not indicate from which line item(s) the \$12 600 000 was deducted.

<sup>c</sup>NASA's initial budget request for Agena was \$7 300 000.

Table 1-10. Atlas F Funding History  
(in thousands of dollars)

Year	Request	Authorization	Programmed
1976	3 400	3 400	3 400
1977	6 200	6 200	11 800
1978	9 300	9 300	6 300

Table 1-11. Centaur Funding History  
(in thousands of dollars)

Year	Request	Authorization	Programmed
1969	63 000 <sup>a</sup>	--- <sup>b</sup>	44 200
1970	52 600 <sup>c</sup>	52 600	46 019
1971	68 100	68 100	66 000
1972	75 900	75 900	82 200
1973	106 500	106 500	120 700
1974	115 000	115 000	106 000 <sup>d</sup>
1975	75 000	75 000	75 400
1976	140 200 <sup>e</sup>	140 200	134 500 <sup>f</sup>
1977	90 700	90 700	84 000
1978	55 900	55 900	41 458

<sup>a</sup>\$7 000 000 of which was requested for Atlas boosters.

<sup>b</sup>Of the \$128 300 000 request for launch vehicle procurement (excluding Saturn), \$115 700 000 was authorized; the chronological history does not indicate from which line item(s) the \$12 600 000 was deducted.

<sup>c</sup>NASA's initial request for Centaur was \$57 600 000.

<sup>d</sup>As of the FY 1976 estimate, the Centaur program provided for the procurement of Atlas and Titan III E booster stages.

<sup>e</sup>Includes \$26 400 000 for the transition quarter.

<sup>f</sup>Includes \$24 400 000 from the transition quarter.

Table 1-12. Delta Funding History  
(in thousands of dollars)

Year	Request	Authorization	Programmed
1969	30 800 <sup>a</sup>	--- <sup>b</sup>	24 300
1970	32 100 <sup>c</sup>	32 100	32 400
1971	34 000	34 000	37 500
1972	37 200	37 200	41 000
1973	41 900	41 900	76 000
1974	46 000	47 000	60 200
1975	47 700	50 700	51 800
1976	46 900 <sup>d</sup>	46 900	51 100 <sup>e</sup>
1977	43 800	43 800	44 900
1978	55 300	55 300	70 400

<sup>a</sup>\$9 500 000 of which was requested for Thor boosters.

<sup>b</sup>Of the \$128 300 000 request for launch vehicle procurement (excluding Saturn), \$115 700 000 was authorized; the chronological history does not indicate from which line item(s) the \$12 600 000 was deducted. However, the House committee recommended a \$6 600 000 deduction from the Delta request on March 19, 1968. It was also recommended that Delta's budget be cut further by an unspecified reduction in sustaining engineering and maintenance.

<sup>c</sup>NASA's initial budget request for Delta was \$33 700 000.

<sup>d</sup>Includes \$10 300 000 for the transition quarter.

<sup>e</sup>Includes \$9 300 000 from the transition quarter.

Table 1-13. Saturn IB Funding History  
(in thousands of dollars)

Year	Request	Authorization	Programmed
1969	104 500 <sup>a</sup>	--- <sup>b</sup>	42 276 <sup>c</sup>
1970	--- <sup>d</sup>	---	--- <sup>e</sup>
1971	--- <sup>f</sup>	---	25 659 <sup>g</sup>
1972	--- <sup>h</sup>	---	39 582 <sup>g</sup>
1973	65 900 <sup>g</sup>	65 900	--- <sup>i</sup>
1974	74 000 <sup>j</sup>	74 000 <sup>j</sup>	13 000 <sup>k</sup>
1975	32 500 <sup>l</sup>	--- <sup>m</sup>	--- <sup>n</sup>

<sup>a</sup>Includes \$69 100 000 from the Apollo request and \$35 400 000 from Apollo applications.

<sup>b</sup>Of the \$2 038 800 000 Apollo request, \$2 025 000 000 was authorized; the chronological history does not indicate from which Apollo line item(s) the \$13 800 000 was deducted. Of the \$439 600 000 request for Apollo applications, \$253 200 000 was authorized; the chronological history does not indicate from which Apollo applications line item(s) the \$186 400 000 was deducted.

<sup>c</sup>From the Apollo budget. \$52 645 000 was programmed for Apollo applications space vehicles, including Saturn IB; the FY 1971 budget estimate does not indicate the exact amount programmed for launch vehicles.

<sup>d</sup>\$138 400 000 was requested for Apollo application space vehicles, including Saturn IB; the FY 1970 budget estimate does not indicate the exact amount requested for launch vehicles.

<sup>e</sup>\$63 330 000 was programmed for Skylab space vehicles, including Saturn IB; the FY 1972 budget estimate does not indicate the exact amount programmed for launch vehicles.

<sup>f</sup>\$89 600 000 was requested for Skylab space vehicles, including Saturn IB; the FY 1971 budget estimate does not indicate the exact amount requested for launch vehicles.

<sup>g</sup>From the Skylab budget/request.

<sup>h</sup>\$194 000 000 was requested for Skylab space vehicles, including Saturn IB; the FY 1972 budget estimate does not indicate the exact amount requested for launch vehicles.

<sup>i</sup>The FY 1975 budget estimate does not indicate how Skylab funds were programmed in FY 1973; it was estimated in the FY 1974 budget estimate that \$65 300 000 would be programmed in FY 1973 for Saturn IB.

<sup>j</sup>Includes \$64 500 000 for Skylab and \$9 500 000 for ASTP.

<sup>k</sup>From the ASTP budget. The FY 1975 and 1976 budget estimates do not indicate how Skylab funds were programmed in FY 1974.

<sup>l</sup>From the ASTP request.

<sup>m</sup>Of the \$114 600 000 request for ASTP, \$109 600 000 was authorized; the chronological history does not indicate how the \$5 000 000 was deducted.

<sup>n</sup>The FY 1977 budget estimate does not indicate how ASTP funds were programmed in FY 1975; the FY 1976 budget estimate predicts that \$32 500 000 would be programmed for Saturn IB in FY 1975.

Table 1-14. Saturn V Funding History  
(in thousands of dollars)

Year	Request	Authorization	Programmed
1969	879 500 <sup>a</sup>	--- <sup>b</sup>	535 710 <sup>c</sup>
1970	542 700 <sup>d</sup>	542 700 <sup>d</sup>	486 691 <sup>c</sup>
1971	231 000 <sup>c</sup>	231 000 <sup>c</sup>	189 059 <sup>c</sup>
1972	186 003 <sup>c</sup>	186 003 <sup>c</sup>	162 096 <sup>e</sup>
1973	124 300 <sup>f</sup>	124 300 <sup>f</sup>	--- <sup>g</sup>
1974	29 700 <sup>h</sup>	29 700 <sup>h</sup>	--- <sup>i</sup>

<sup>a</sup>Includes \$818 200 000 from the Apollo request and \$61 300 000 from Apollo applications.

<sup>b</sup>Of the \$2 038 800 000 Apollo request, \$2 025 000 000 was authorized; the chronological history does not indicate from which Apollo line item(s) the \$13 800 000 was deducted. Of the \$439 600 000 request for Apollo applications, \$253 200 000 was authorized; the chronological history does not indicate from which Apollo applications line item(s) the \$186 400 000 was deducted.

<sup>c</sup>From the Apollo budget/request.

<sup>d</sup>Includes \$496 700 000 from the Apollo request and \$46 000 000 for Saturn V production; the production request was included in NASA's amended budget submission.

<sup>e</sup>Includes \$157 996 000 from the Apollo budget and \$4 100 000 from Skylab.

<sup>f</sup>Includes \$49 200 000 from the Apollo request and \$75 100 000 from Skylab.

<sup>g</sup>The FY 1975 budget estimate does not indicate how Apollo and Skylab funds were programmed in FY 1973; the FY 1974 budget estimate predicts that \$26 300 000 would be programmed for Saturn V from the Apollo budget and \$56 600 000 from the Skylab budget.

<sup>h</sup>From the Skylab request.

<sup>i</sup>The FY 1975 and 1976 budget requests do not indicate how Skylab funds were programmed in FY 1974.

Table 1-15. Scout Funding History  
(in thousands of dollars)

Year	Request	Authorization	Programmed
1969	16 500	--- <sup>a</sup>	12 600
1970	11 700 <sup>b</sup>	11 700	13 700
1971	15 100	15 100	13 200
1972	16 500	16 500	15 100
1973	21 000	21 000	15 700
1974	12 000	12 000	7 800
1975	13 800	13 800	12 300
1976	15 500 <sup>c</sup>	15 500	14 000 <sup>c</sup>
1977	10 700	10 700	10 700
1978	16 000	16 000	16 342

<sup>a</sup>Of the \$128 300 000 requested for launch vehicle procurement (excluding Saturn), \$115 700 000 was authorized; the chronological history does not indicate from which line item(s) the \$12 600 000 was deducted.

<sup>b</sup>NASA's initial budget request for Scout was \$15 700 000.

<sup>c</sup>Includes \$3 400 000 for the transition quarter.



Table 1-16. Space Transportation System Main Engine and Solid Rocket Boosters  
Funding History  
(in thousands of dollars)

Year	Request	Authorization	Programmed
1971	---	---	20 900 <sup>a</sup>
1972	---	---	58 900 <sup>b</sup>
1973	90 000 <sup>c</sup>	90 000	40 543 <sup>d</sup>
1974	97 900 <sup>e</sup>	97 900	108 974 <sup>f</sup>
1975	140 900 <sup>g</sup>	145 900 <sup>h</sup>	150 443 <sup>i</sup>
1976	346 900 <sup>j</sup>	346 900	373 040 <sup>k</sup>
1977	340 400 <sup>l</sup>	340 400	371 600 <sup>m</sup>
1978	383 500 <sup>n</sup>	383 500	402 988 <sup>o</sup>

<sup>a</sup>For engine definition.

<sup>b</sup>Includes \$45 100 000 for main engine development and \$13 800 000 for definition studies.

<sup>c</sup>Includes \$50 000 000 for engine design and development and \$40 000 000 for booster design and development.

<sup>d</sup>For main engine development.

<sup>e</sup>Includes \$55 500 000 for main engine development; \$18 100 000 for solid rocket booster development; and \$24 300 000 for external tank development.

<sup>f</sup>Includes \$82 307 000 for main engine development; \$8 567 000 for solid rocket booster development; and \$18 100 000 for external tank development.

<sup>g</sup>Includes \$92 300 000 for main engine development; \$22 600 000 for solid rocket booster development; and \$26 000 000 for external tank development.

<sup>h</sup>An additional \$5 000 000 was authorized for main engine development.

<sup>i</sup>Includes \$95 300 000 for main engine development; \$21 143 000 for solid rocket booster development; and \$34 000 000 for external tank development.

<sup>j</sup>Includes \$135 500 000 (plus \$36 000 000 from the transition quarter) for main engine development; \$76 200 000 (plus \$18 000 000) for solid rocket booster development; and \$66 100 000 (plus \$15 100 000) for external tank development.

<sup>k</sup>Includes \$140 800 000 (plus \$37 900 000 from the transition quarter) for main engine development; \$82 240 000 (plus \$26 000 000) for external tank development; and \$65 700 000 (plus \$20 400 000) for solid rocket booster development.

<sup>l</sup>Includes \$193 800 000 for main engine development; \$82 600 000 for solid rocket booster development; and \$64 000 000 for external tank development.

<sup>m</sup>Includes \$182 200 000 for main engine development; \$84 000 000 for external tank development; \$100 400 000 for solid rocket booster development; and \$5 000 000 for main engine production.

<sup>n</sup>Includes \$219 900 000 for main engine development; \$80 000 000 for external tank development; and \$83 600 000 for solid rocket booster development. An additional \$141 700 000 was requested for the production of the space transportation system.

<sup>o</sup>Includes \$197 400 000 for main engine development; \$88 030 000 for external tank development; \$104 998 000 for solid rocket booster development; and \$12 560 000 for main engine production.

Table 1-17. Titan IIIC Funding History  
(in thousands of dollars)

Year	Request	Authorization	Programmed
1969	---	---	3 100
1970	5 900	5 900	6 700
1971	4 700	4 700	4 100
1972	12 500	12 500	9 000
1973	18 200	18 200	5 500

## CHARACTERISTICS

The launch vehicles used by NASA during the agency's second 10 years are described in the tables that follow. Every launch vehicle NASA put on the pad during the decade was either in use or under development in the 1960s. Atlas, which had been employed in several configurations for manned and unmanned missions during the early years of the space age, was paired with the high-power Centaur upper stage in 1969-1978 to launch payloads destined for earth orbit or interplanetary space. In 1978, a new model, Atlas F, was tested by NASA for the first time. The agency continued to rely on Thor-Delta, in a variety of models, and the small but ever-improving Scout to launch most of its applications and scientific satellites, as well as the payloads of other government agencies and foreign governments. Saturn V continued its role in the Apollo program, delivering crews to the moon. The Skylab orbiting workshop, built from spare Saturn hardware, was launched by a Saturn V, and visiting astronaut-scientists were escorted to the laboratory by Saturn IBs. Titan III, greatly enhanced over the Titan of Project Gemini by strap-on motors and powerful upper stages, was capable of boosting large payloads to the planets. By the end of the decade, however, a launch system was being readied that promised to make these expendable vehicles obsolete. The Space Transportation System—Shuttle orbiter with external tank and two reusable solid rocket boosters—was being tested in the late 1970s. NASA officials hoped this new system would be more flexible and more economical than the traditional boosters they had relied on for 20 years.

In some cases, finding the “official” figures for the height, weight, or thrust of a launch vehicle was difficult. It was not uncommon to find NASA, contractor, and media sources with conflicting data. Measurements, therefore, may be approximate. Height may be measured several different ways, and there was some disagreement in the source materials over where an upper stage begins and ends for measuring purposes. The height of a launch vehicle stack does not always include the payload (spacecraft); weight, however, does. Weight of the individual stages includes propellant (wet weight). Diameter does not take into consideration the addition of fins or strap-on engines to the base of the booster stage.

Engine number changes may not always be noted if only minor modifications were made to the engines. The following abbreviations for propellants were used throughout the tables: LH<sub>2</sub> = liquid hydrogen, LOX = liquid oxygen, N<sub>2</sub>H<sub>4</sub> = hydrazine, N<sub>2</sub>O<sub>4</sub> = nitrogen tetroxide, RP-1 = kerosene, and UDMH = unsymmetrical dimethylhydrazine. Thrust was expressed in newtons thrust (pounds of thrust × 4.448 = newtons). Payload capacity was measured by the number of kilograms that could be delivered to a certain orbit (measured in nautical miles converted to kilometers).

When available, a listing by launch vehicle number (serial number or production number) was provided with information on how the vehicles were used. Consult table 1-18 and figure 1-3 for a summary of the success rates of NASA's launch vehicles during the 1970s.

A chronology of each vehicle's development and operation also has been included. Consult volume two for pre-1969 events. Launch dates and times were based on local time at the launch site.

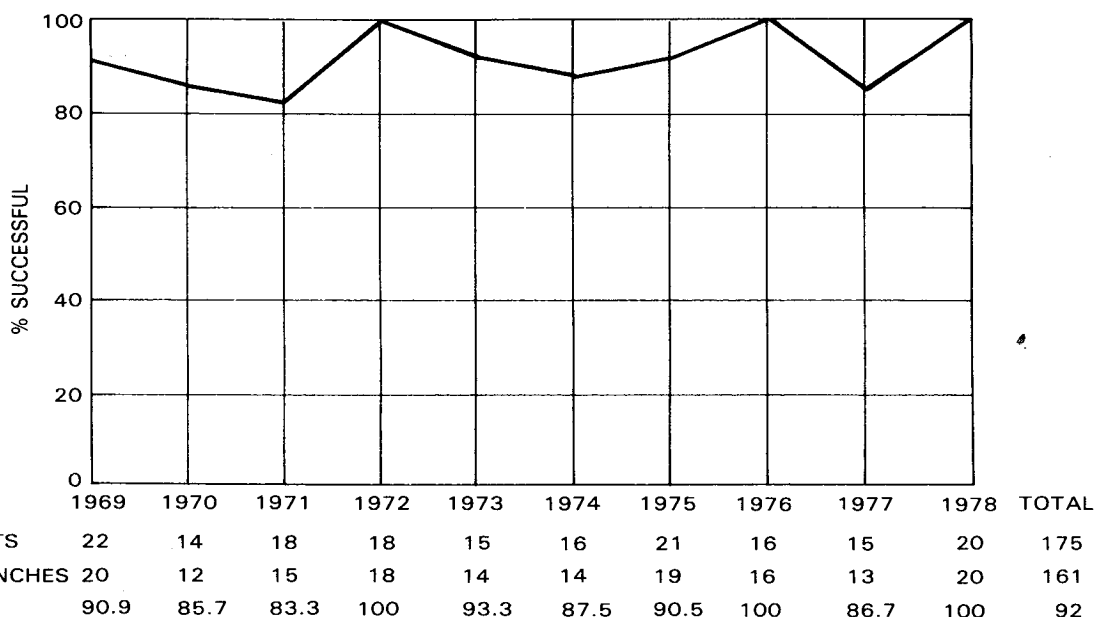

Figure 1-3. Launch Vehicle Success

Table 1-18. Launch Vehicle Summary (successes/attempts)

Vehicle	1969	1970	1971	1972	1973	1974	1975	1976	1977	1978	Total	% of Vehicle Success*
Atlas F	----	----	----	----	----	----	----	----	----	1/1	1/1	100.00
Atlas-Centaur	3/3	0/1	3/4	4/4	3/3	1/1	2/3	3/3	2/3	7/7	28/32	87.50
Saturn IB	----	----	----	----	3/3	----	1/1	----	----	----	4/4	100.00
Saturn V	4/4	1/1	2/2	2/2	1/1	----	----	----	----	----	10/10	100.00
Scout	2/2	3/3	7/7	5/5	1/1	5/6	2/3	3/3	1/1	1/1	30/32	93.75
Thorad-Agena D	2/2	2/2	----	----	----	----	----	----	----	----	4/4	100.00
Thor-Delta	9/11	6/7	3/5	7/7	5/6	7/7	12/12	9/9	8/9	11/11	77/84	91.60
Titan IIC	----	----	----	----	1/1	----	----	----	----	----	1/1	100.00
Titan IIIE-Centaur	----	----	----	----	----	1/2	2/2	1/1	2/2	----	6/7	85.70

\*Complete success of all stages.

## The Atlas Family

The Air Force Atlas booster, designed as an intercontinental ballistic missile by Consolidated Vultee Aircraft Corporation (later the Convair Division of General Dynamics) in the 1950s, was used by NASA in several configurations in the agency's early years. Alone, the stage-and-a-half rocket served as one of the manned Mercury spacecraft launch vehicles in 1960-1963. To boost science and applications payloads, it was paired with Able, Agena B and D, Antares, and Centaur upper stages. During NASA's second decade, Atlas-Centaur was the only combination to survive.

Atlas and Centaur, a high-energy, liquid-propellant stage developed for NASA by General Dynamics, were both updated over the years to provide even more

boosting power. The Atlas SLV-3C, first used in a research and development test launch of Centaur in 1966, was replaced by the SLV-3D model in 1973. An Atlas F vehicle, which was paired with an apogee kick motor manufactured by Thiokol Corporation, showed promise in late 1978 as a NASA satellite launcher. Centaur's engines in the improved D-1A model (and the D-1T version used with Titan) could burn longer and be restarted after a longer interval of shutdown time, making it especially suitable for launching interplanetary spacecraft. The improved Atlas-Centaur was also supplemented by a third-stage solid rocket motor during four missions. During the 1970s, Atlas-Centaur was put on the launch pad at the Eastern Test Range 32 times to boost intermediate-weight payloads to earth orbit and to the planets; the vehicle suffered only 4 failures.

NASA planners hoped that the reusable Shuttle would be ready for operations in the late 1970s, rendering expendable vehicles such as Atlas-Centaur obsolete. When budget cuts forced the agency to stretch out the Shuttle research and development schedule, Atlas-Centaur was assured several more years of frequent use. In addition, propulsion experts at the Lewis Research Center, General Dynamics, and elsewhere were proposing that Centaur be given a new role for the 1980s: as a Shuttle interim upper stage in the Space Transportation System.

Table 1-19. Atlas F Characteristics

	Atlas Stage	Apogee Kick Motor	Total
Height (m):	21.26	(with payload)	29.3
Diameter (m):	3.05	(fairing: 2.1)	
Launch weight (kg):	120 849	714	121 563
Propulsion system:	MA-3		
Powerplant:	(2) LR89-NA-5 (1) LR105-NA-5 (2) LR101-NA-7	TE 364-15	
Thrust (newtons):	1 722 000	650 800	2 372 800
Burn time (sec.):	770	44	
Propellant:	LOX/RP-1	solid	
Payload capacity:	2091 kg to 185 km earth orbit 1500 kg to circular sun orbit		
Origin:	U.S. Air Force missile system		
Contractor:	Rocketdyne Div., Thiokol Corp. Rockwell Corp.: propulsion system Convair Div., General Dynamics: prime		
How utilized:	<i>Tiros N</i> (Atlas 29F), Oct. 13, 1978		
Remarks:	The Atlas stage (often referred to as 1½ stages) contained two booster engines, one sustainer engine, and two vernier engines. The apogee kick motor was used to put the payload into a precise orbit 10 minutes after lift-off.		

Table 1-20. Atlas-Centaur Characteristics

	1st Stage Atlas SLV-3D	2d Stage Centaur D-1A	Optional 3d Stage TE-M-364-4	Total
Height (m):	22.9	14.6 (with payload fairing)	(included with payload)	39.8
Diameter (m):	3.05	3.05		
Launch weight (kg):	128 736	17 674		146 914
Propulsion system:	MA-5			
Powerplant:	2 booster engines 1 sustainer engine 2 vernier engines	Pratt & Whitney (2) RL-10A-3-3	Thiokol TE-M-364-4	
Thrust (newtons):	1 919 300	131 200	65 866	2 050 500 (2 116 366 with third stage)
Burn time (sec.):	230	450 (max.)	44	
Propellant:	LOX/RP-1	LOX/LH <sub>2</sub>	solid	
Payload capacity:	4500 kg to earth orbit/1800 to synchronous orbit 900 kg to Venus or Mars			
Origin:	Air Force missile system	NASA-General Dynamics design	NASA-Thiokol design	
Contractors:	Rocketdyne Div., Rockwell Corp.: propulsion system Convair Div., General Dynamics: prime	Pratt & Whitney: engines Convair Div., General Dynamics: prime	Thiokol Corp.: engine McDonnell Douglas Astronautics Co. airframe	
Program manager:	F. Robert Schmidt, NASA Hq.			
Project managers:	Daniel J. Schramo, Henry O. Slone, Lawrence J. Ross, Lewis Research Center			
How utilized:	Mariner, Pioneer, Intelsat, Pioneer Venus, ATS, OAO, Com- star, HEAO, Fltsatcom			
Remarks:	The Atlas and the Centaur stages were both upgraded during NASA's second 10 years. The Atlas SLV-3D model was in- troduced in 1973, as was the Centaur D-1A. The optional third stage motor was used with the Atlas-Centaur combination four times: <i>Pioneer 10</i> , <i>Pioneer 11</i> , <i>Intelsat IV F-7</i> , and <i>Mariner 10</i> . It was attached to the aft of the spacecraft.			
See also:	Volume 2.			

Table 1-21. Listing of Atlas-Centaur Vehicles

Atlas-Centaur Vehicle Serial #	Date	Mission	Atlas-Centaur* Successful
5403C/AC-20	Feb. 24, 1969	Mariner 6	Yes
5105C/AC-19	Mar. 27, 1969	Mariner 7	Yes
5402C/AC-18	Aug. 12, 1969	ATS 5	Yes
5003C/AC-21	Nov. 30, 1970	OAO B	No; nose fairing failed to separate from vehicle, preventing the Centaur stage from reaching orbital velocity
5005C/AC-25	Jan. 25, 1971	Intelsat IV F-2	Yes
5405C/AC-24	May 8, 1971	Mariner 8	No; Centaur's main engine failed to start properly
5404C/AC-23	May 30, 1971	Mariner 9	Yes
5006C/AC-26	Dec. 19, 1971	Intelsat IV F-3	Yes
5008C/AC-28	Jan. 22, 1972	Intelsat IV F-4	Yes
5007C/AC-27	Mar. 2, 1972	Pioneer 10	Yes
5009C/AC-29	June 13, 1972	Intelsat IV F-5	Yes
5004C/AC-22	Aug. 21, 1972	OAO 3	Yes
5011D/AC-30	Apr. 5, 1973	Pioneer 11	Yes
5010D/AC-31	Aug. 23, 1973	Intelsat IV F-7	Yes
5014D/AC-34	Nov. 3, 1973	Mariner 10	Yes
5012D/AC-32	Nov. 21, 1974	Intelsat IV F-8	Yes
5015D/AC-33	Feb. 20, 1975	Intelsat IV F-6	No; several malfunctions including an electrical problem caused the range officer to destroy the vehicle 415 sec. after liftoff
5018D/AC-35	May 22, 1975	Intelsat IV F-1	Yes
5016D/AC-36	Sept. 26, 1975	Intelsat IVA F-1	Yes
5017D/AC-37	Jan. 29, 1976	Intelsat IVA F-2	Yes
5020D/AC-38	May 13, 1976	Comstar 1	Yes
5022D/AC-40	July 22, 1976	Comstar 2	Yes
5019D/AC-39	May 26, 1977	Intelsat IVA F-4	Yes
5025D/AC-45	Aug. 12, 1977	HEAO 1	Yes
5701D/AC-43	Sept. 29, 1977	Intelsat IVA F-5	No; Atlas booster high-pressure gas generator system malfunctioned
5026D/AC-46	Jan. 7, 1978	Intelsat IVA F-3	Yes
5024D/AC-44	Feb. 9, 1978	Fltsatcom 1	Yes
5028D/AC-48	Mar. 31, 1978	Intelsat IVA F-6	Yes
5030D/AC-50	May 20, 1978	Pioneer Venus 1	Yes
5021D/AC-41	June 29, 1978	Comstar 3	Yes
5031D/AC-51	Aug. 8, 1978	Pioneer Venus 2	Yes
5032D/AC-52	Nov. 13, 1978	HEAO 2	Yes

\* 4 failures out of 32 attempts (87.5% successful).

Table 1-22. Chronology of Atlas-Centaur Development and Operations

Date	Event
Feb. 24, 1969	Atlas-Centaur successfully launched <i>Mariner 6</i> to Mars.
March 27, 1969	Atlas-Centaur successfully launched <i>Mariner 7</i> to Mars.
June 26, 1969	NASA's Marshall Space Flight Center issued a request for proposals for an eight-month study of six launch vehicle configurations that would utilize a Centaur upper stage on a Saturn S-IVB stage. McDonnell Douglas was awarded the contract.
Aug. 12, 1969	Atlas-Centaur successfully launched <i>ATS 5</i> to earth orbit.
Sept. 29, 1969	NASA executed a contract with General Dynamics for the development of an improved Centaur (D-1) stage.
Oct. 15, 1969	NASA's Lewis Research Center awarded General Dynamics a contract for the manufacture of six Atlas stages to be used with Centaur.
Nov. 10, 1969	Pratt & Whitney and NASA officials signed a letter contract calling for 18 RL-10 engines for Centaur; a definitive contract was executed on April 10, 1970. An additional 12 engines were requested in May.
June 26, 1970	Lewis announced that Lockheed Missiles & Space Co. had been awarded a contract to develop an improved Centaur shroud.
Nov. 30, 1970	Atlas-Centaur failed to launch OAO B into earth orbit because the nose fairing failed to separate from the vehicle.
Jan. 25, 1971	Atlas-Centaur launched <i>Intelsat IV F-2</i> to earth orbit for ComSat Corp.
May 8, 1971	Atlas-Centaur failed to launch <i>Mariner 8</i> to Mars because the Centaur's engines malfunctioned.
May 30, 1971	Atlas-Centaur successfully launched <i>Mariner 9</i> to Mars.
Dec. 19, 1971	Atlas-Centaur launched <i>Intelsat IV F-3</i> to earth orbit for ComSat Corp.
Jan. 22, 1972	Atlas-Centaur launched <i>Intelsat IV F-4</i> to earth orbit for ComSat Corp.
March 2, 1972	Atlas-Centaur successfully launched <i>Pioneer 10</i> . The probe was scheduled to journey through the Asteroid Belt, past the planet Jupiter, and eventually out of the solar system. A third-stage motor, the TE-M-364-4, was added to the Atlas-Centaur configuration for the first time.
June 13, 1972	Atlas-Centaur launched <i>Intelsat IV F-5</i> to earth orbit for ComSat Corp.
Aug. 21, 1972	Atlas-Centaur successfully launched <i>OAO 3</i> to earth orbit.
April 5, 1973	Atlas-Centaur successfully launched <i>Pioneer 11</i> on its way to Jupiter. This was the first use of the upgraded Atlas-Centaur configuration (Atlas SLV-3D-Centaur D-1A).
July 17, 1973	Marshall awarded General Dynamics a contract to study a reusable Centaur stage, which would also have potential as an interim space tug.
Aug. 3, 1973	General Dynamics officials briefed NASA Headquarters personnel on the results of their Centaur-Shuttle integration study.
Aug. 23, 1973	Atlas-Centaur launched <i>Intelsat IV F-7</i> to earth orbit for ComSat Corp.
Sept. 24, 1973	It was announced that NASA awarded a contract to General Dynamics for the production of nine Centaur stages.
Nov. 3, 1973	Atlas-Centaur successfully launched <i>Mariner 10</i> on its way to Venus and Mercury.
Nov. 21, 1974	Atlas-Centaur launched <i>Intelsat IV F-8</i> to earth orbit for ComSat Corp.
Feb. 20, 1975	Atlas-Centaur failed to launch <i>Intelsat IV F-6</i> to earth orbit for ComSat Corp. because of several vehicle malfunctions.
May 22, 1975	Atlas-Centaur launched <i>Intelsat IV F-1</i> to earth orbit for ComSat Corp.
Spring 1975	NASA officials were conducting in-house studies of the possibility of using Centaur as a Shuttle interim upper stage (IUS). These studies and debate among NASA, Congress, and the Air Force over which vehicle, if any, would serve as the best IUS, would continue through the early 1980s.
Sept. 26, 1975	Atlas-Centaur launched <i>Intelsat IVA F-1</i> to earth orbit for ComSat Corp.

Table 1-22. Chronology of Atlas-Centaur Development and Operations (Continued)

Date	Event
Jan. 29, 1976	Atlas-Centaur launched <i>Intelsat IVA F-2</i> to earth orbit for ComSat Corp.
May 13, 1976	Atlas-Centaur launched <i>ComStar 1</i> to earth orbit for ComSat Corp. and American Telephone and Telegraph Co.
July 22, 1976	Atlas-Centaur launched <i>ComStar 2</i> to earth orbit for ComSat Corp. and American Telephone and Telegraph Co.
Sept. 8, 1976	Lewis awarded General Dynamics a contract to produce eight Atlas-Centaur vehicles.
May 26, 1977	Atlas-Centaur launched <i>Intelsat IVA F-4</i> to earth orbit for ComSat Corp.
Aug. 12, 1977	Atlas-Centaur successfully launched <i>HEAO 1</i> to earth orbit.
Sept. 29, 1977	Atlas-Centaur failed to launch <i>Intelsat IVA F-5</i> into orbit for ComSat Corp. because the high-pressure gas generator system on the Atlas booster failed.
Jan. 7, 1978	Atlas-Centaur launched <i>Intelsat IVA F-3</i> to earth orbit for ComSat Corp.
Feb. 9, 1978	NASA's Atlas-Centaur launched <i>Fltsatcom 1</i> to earth orbit for the Navy and the Department of Defense.
March 31, 1978	Atlas-Centaur launched <i>Intelsat IVA F-6</i> to earth orbit for ComSat Corp.
May 20, 1978	Atlas-Centaur successfully launched <i>Pioneer Venus 1</i> onto its interplanetary trajectory.
June 29, 1978	Atlas-Centaur launched <i>Comstar 3</i> to earth orbit for ComSat Corp. and AT&T.
Aug. 8, 1978	Atlas-Centaur successfully launched <i>Pioneer Venus 2</i> to the planets.
Nov. 13, 1978	Atlas-Centaur successfully launched <i>HEAO 2</i> to earth orbit.

### The Saturn Family

The clustered-engine Saturn launch vehicles were developed during the 1960s under the direction of Wernher von Braun at the Marshall Space Flight Center, Huntsville, Alabama. Their primary role was to support NASA's program of manned expeditions to the moon. Saturn I and Saturn IB helped qualify the Apollo spacecraft in earth-orbital maneuvers (1963-1968). The task of boosting a crew of three astronauts and their command and service module and lunar module to the moon fell to the three-stage Saturn V. The first manned landing (*Apollo 11*) took place in 1969, preceded by two lunar-orbital missions (*Apollo 8* and *10*), and one earth-orbital mission (*Apollo 9*) also launched by Saturn Vs.

The powerful Saturn V sent six crews to the lunar surface (a seventh, *Apollo 13*, was forced to return because of a spacecraft malfunction) in 1969-1972. Powered by five Rocketdyne F-1 and six Rocketdyne J-2 engines. Saturn V's total thrust was 39.4 million newtons, enough power to lift 45 000 kilograms to an escape trajectory or 129 000 kilograms to earth orbit. It stood 111 meters tall and weighed 2.6 million kilograms. North American Rockwell Corporation, the Boeing Company, and Douglas Aircraft Company served as the primary contractors.

The budget cuts of the late 1960s and early 1970s left NASA with Apollo and Saturn hardware, but no lunar missions for which to use it. Congress had forced the agency to scrap its last Apollo flights to the moon. To make use of the spacecraft and launch vehicles already procured, NASA's manned spaceflight officials sought approval for an Apollo applications program. Skylab was the flight project that evolved from this attempt to utilize Apollo surplus. In May 1973, NASA's last Saturn V launched the Skylab Orbital Workshop to earth orbit. Three three-man crews were sent to visit the laboratory by Saturn IB vehicles later that year.

Saturn IB was used one more time by the space agency. In July 1975, it launched



an Apollo crew to earth orbit, where they met and docked with a Soviet Soyuz spacecraft. The Apollo-Soyuz Test Project marked the last use of Apollo hardware (see table 1-25 for a listing of Saturn flights).

Table 1-23. Saturn IB Characteristics

	1st Stage (S-IB)	2d Stage (S-IVB)	Instrument Unit	Total with Spacecraft and Tower
Height (m):	24.5	17.8	0.9	68.3
Diameter (m):	6.5	6.6	6.6	
Launch weight (kg):	401 348	103 852	1859	589 550
Propulsion system				
Powerplant:	8	1		
	Rocketdyne	Rocketdyne		
	H-1s	J-2		
Thrust (newtons):	7 116 800	1 000 800		8 117 600
Propellant:	LOX/RP-1	LOX-LH <sub>2</sub>		
Payload capacity:	16 598 kg to 195 km earth orbit			
Origin:	Uprated Saturn I			
Contractors:	North American Rockwell Corp.: 1st- and 2d-stage propulsion Chrysler Corp.: 1st stage Douglas Aircraft Co.: 2d stage			
Program managers:	Richard G. Smith, Ellery B. May, Marshall Space Flight Center			
How utilized:	Skylab, Apollo-Soyuz Test Project			
Remarks:	Called Uprated Saturn I from May 1966 through 1967; development completed during the 1960s as part of the Apollo program; used to qualify the Apollo spacecraft in 1966-68.			
See also:	Volume 2.			

Table 1-24. Saturn V Characteristics

	1st Stage (S-IC)	2d Stage (S-II)	3d Stage (S-IVB)	Instrument Unit	Total with Spacecraft and Tower
Height (m):	42.1	24.9	17.9	0.9	111
Diameter (m):	10.1	10.1	6.6	6.6	
Launch weight (kg):	2 076 123	437 628	105 212	2041	2 621 004
Propulsion system					
Powerplant:	5	5	1		
	Rocketdyne	Rocketdyne	Rocketdyne		
	F-1s	J-2s	J-2		
Thrust (newtons):	33 360 000	5 004 000	1 023 040		39 387 040
Propellant:	LOX/RP-1	LOX-LH <sub>2</sub>	LOX-LH <sub>2</sub>		
Payload capacity:	129 248 kg to 195 km earth orbit 45 350 kg to escape trajectory				
Origin:	Uprated Saturn IB				
Contractors:	North American Rockwell Corp.: 1st-, 2d-, and 3d-stage propulsion, 2d stage Boeing Co.: 1st stage Douglas Aircraft Co.: 3d stage				
Program manager:	Richard C. Smith, Ellery B. May, Marshall Space Flight Center				
How utilized:	Apollo lunar missions.				
Remarks:	Called Saturn C-5 in 1961-62; development completed during the 1960s as part of the Apollo program.				
See also:	Volume 2.				

Table 1-25. Listing of Saturn IB/Saturn V Vehicles

Vehicle Serial #	Date	Mission	Saturn Vehicle Successful <sup>a</sup>
SA-504	March 3, 1969	<i>Apollo 9</i> , earth orbit (SV)	Yes
SA-505	May 18, 1969	<i>Apollo 10</i> , lunar orbit (SV)	Yes
SA-506	July 16, 1969	<i>Apollo 11</i> , lunar orbit (SV)	Yes
SA-507	Nov. 14, 1969	<i>Apollo 12</i> , lunar landing(SV)	Yes
SA-508	April 11, 1970	<i>Apollo 13</i> , lunar landing(SV)	Yes
SA-509	Jan. 31, 1971	<i>Apollo 14</i> , lunar landing(SV)	Yes
SA-510	July 26, 1971	<i>Apollo 15</i> , lunar landing(SV)	Yes
SA-511	April 16, 1972	<i>Apollo 16</i> , lunar landing(SV)	Yes
SA-512	Dec. 7, 1972	<i>Apollo 17</i> , lunar landing(SV)	Yes
SA-513	May 14, 1973	<i>Skylab 1</i> , earth orbit (SV)	Yes <sup>b</sup>
SA-206	May 25, 1973	<i>Skylab 2</i> , earth orbit (SIB)	Yes
SA-207	July 28, 1973	<i>Skylab 3</i> , earth orbit (SIB)	Yes
SA-208	Nov. 16, 1973	<i>Skylab 4</i> , earth orbit (SIB)	Yes
SA-210	July 15, 1975	Apollo-Soyuz Test Project, earth orbit (SIB)	Yes

<sup>a</sup> Saturn IB: 0 failures out of 4 attempts (100% successful)

Saturn V: 0 failures out of 10 attempts (100% successful)

<sup>b</sup>At 63 seconds after liftoff, the meteoroid shield protecting Skylab was torn off by vibrations suffered by the launch vehicle, damaging the laboratory's solar array system. Subsequent analyses revealed that the shield separation straps had failed. The workshop was positioned in the correct orbit and the damage repaired by the first crew to visit it.

## Scout

The four-stage solid propellant Scout served as NASA's small-payload launch vehicle for both the first and second decades of the space agency's existence. NASA inherited specifications for the rocket from the National Advisory Committee for Aeronautics (NACA) and awarded contracts for its development in 1959. The first successful research and development launch took place the next year. From 1960 through 1978, NASA used the Scout vehicle 71 times to launch Explorer-class satellites and a variety of international payloads.

Under the direction of the Langley Research Center and the Ling Temco Vought Corporation (later Vought Corporation), the prime contractor, the Scout configuration evolved. The rocket motors of all four stages were either upgraded or replaced by a new model at least three times (see table 1-27; and volume 2, table 1-70). With each major improvement, Scout's payload capacity increased—from 59 to 193 kilograms (to a 555-kilometer orbit). The Air Force also employed a Scout configuration in its satellite program. Scout vehicles were launched from Wallops Island, Vandenberg Air Force Base, and the San Marco mobile platforms off the Kenya coast.

Table 1-26. Scout Characteristics (as of 1978)

	1st Stage Algol IIIA	2d Stage Castor IIA	3d Stage Antares IIB	4th stage Altair IIIA	Total
Height (m):	9.1	6.2	2.9	1.5	21.9
Diameter (m):	1.14	0.8	0.76	0.5	
Weight (kg):	14 195	4429	1270	300	20 194
Propulsion system					
Powerplant:	UTC	Thiokol TX 354	ABL X-259	UTC FW-4S	
Thrust (newtons):	481 700	271 328	93 050	25 798	871 876
Burn time (sec.):	82	41	37	35	
Propellant:	solid	solid	solid	solid	
Payload capacity:	193 kg to 555 km earth orbit				
Origin:	Pilotless Aircraft Research Div., Langley Memorial Aeronautical Laboratory, National Advisory Committee for Aeronautics				
Contractors:	Vought Corp.: prime United Technology Center: 1st- and 4th-stage propulsion Thiokol Chemical Corp.: 2d-stage propulsion Alleghany Ballistics Laboratory, Hercules Powder Co.: 3d-stage propulsion				
Program manager:	Paul E. Goozh, NASA Hq.				
Project manager:	Roland D. English, Langley Research Center				
How utilized:	To launch small scientific and applications payloads, including a number of international and U.S. Navy satellites.				
Remarks:	A larger diameter payload shroud (increased from 0.86 to 1.07 meters) was introduced in 1972, providing a payload volume of 1.01m <sup>3</sup> (roughly doubling the capacity). As indicated in table 1-27, the Scout vehicle was upgraded periodically. The models in use in 1978 were the D-1 and F-1.				
See also:	Volume 2.				

Table 1-27. Scout Stage Development, 1969-1978

	1969	1970	1971	1972	1973	1974	1975	1976	1977	1978
Stage 1st	Algol IIB (Aerojet-General)	→		Algol IIIA (UTC)	→					
2d	Castor IIA (Thiokol TX-354 3)	→								
3d	Antares IIA (ABL X-259)	→				Antares IIB (ABL X-259)	→			
4th	Altair IIIA (UTC FW-4S)	→								
Total weight (kg):	16 780			21 545		20 194				
Payload capacity (kg to 555 km earth orbit):	142			186		193				
Model designation:*	B-1			D-1		F-1				

\* An additional model, the Scout E, was used in 1974 to launch *Explorer 52*. This special five-stage Scout had an additional Alcylene 1A motor.

Table 1-28. Listing of Scout Vehicles

Vehicle Serial #	Date	Mission	Successful*
S-172C	Oct. 1, 1969	<i>ESRO 1B</i>	Yes
S-169C	Nov. 7, 1969	<i>Azur (GRS-1)</i>	Yes
S-171C	Sept. 30, 1970	RAM C-3	Yes
S-174C	Nov. 9, 1970	<i>Orbiting Frog Otolith-Radiation Meteoroid Satellite</i>	Yes
S-175C	Dec. 12, 1970	<i>Explorer 42</i>	Yes
S-173C	April 24, 1971	<i>San Marco 3</i>	Yes
S-144CR	June 20, 1971	Planetary Atmosphere Experiments Test	Yes
S-177C	July 8, 1971	<i>Explorer 43</i>	Yes
S-180C	Aug. 16, 1971	<i>Eole</i>	Yes
S-166CR	Sept. 20, 1971	Barium-ion cloud probe	Yes
S-163CR	Nov. 15, 1971	<i>Explorer 45</i>	Yes
S-183C	Dec. 11, 1971	<i>Ariel 4</i>	Yes
S-184C	Aug. 13, 1972	<i>Explorer 46</i>	Yes
S-182C	Sept. 2, 1972	<i>Triad 0I-1X</i>	Yes
S-170CR	Nov. 15, 1972	<i>Explorer 48</i>	Yes
S-185C	Nov. 21, 1972	<i>ESRO 4</i>	Yes
S-181C	Dec. 16, 1972	<i>Aeros 1</i>	Yes
S-178C	Oct. 29, 1973	<i>Nnss 0-20</i>	Yes
S-190C	Feb 18, 1974	<i>San Marco 4</i>	Yes
S-188C	March 8, 1974	<i>Miranda</i>	Yes
S-191C	June 3, 1974	<i>Explorer 52</i>	Yes
S-186C	July 16, 1974	<i>Aeros 2</i>	Yes
S-189C	Aug. 30, 1974	<i>Ans 1</i>	Partial; due to 1st-stage guidance system malfunction, payload was not inserted into planned orbit
S-187C	Oct. 15, 1974	<i>Ariel 5</i>	Yes
S-194C	May 7, 1975	<i>Explorer 53</i>	Yes
S-195C	Oct. 12, 1975	<i>Triad 2</i>	Yes
S-196C	Dec. 5, 1975	Dual Air Density Satellite	No; due to 3d-stage malfunction
S-179CR	May 22, 1976	<i>P76-5 Wideband</i>	Yes
S-193C	June 18, 1976	Gravity Probe 1	Yes
S-197C	Sept. 1, 1976	<i>Triad 3</i>	Yes
S-200C	Oct. 28, 1977	TRANSIT	Yes
S-201C	April 26, 1978	<i>Heat Capacity Mapping Mission</i>	Yes

\*2 failures-partial failures out of 32 attempts (93.7% successful).

Table 1-29. Chronology of Scout Development and Operations

Date	Event
Aug. 26, 1969	NASA's Langley Research Center awarded Ling Temco Vought Aerospace Corporation (later Vought Corp.) an 18-month contract to develop a larger first-stage (Algol IIIA) motor for Scout.
Oct. 13, 1969	It was announced that United Technology Center would develop and qualify the Algol IIIA stage for Vought, the prime contractor for the Scout vehicle.
March 1972	Vought, under the direction of NASA's Lewis Research Center, initiated a Scout-Shuttle integration study.
May 31, 1972	Langley ordered 15 Scouts from Vought (10 of which were to be the new D model with the Algol IIIA first stage).
Aug. 13, 1972	The model D scout with a new first-stage motor was used for the first time to launch <i>Explorer 46</i> .
Oct. 26, 1973	NASA awarded a three-year contract to Vought for Scout systems management.
June 3, 1974	A five-stage Model E Scout launched <i>Explorer 52</i> from the Western Test Range. This experimental Scout configuration had an additional Alcione 1A motor and a fifth-stage transition section.
Spring 1976	Langley proposed that an improved third stage (Antares IIIA) be developed for Scout; NASA Headquarters concurred that fall.
Feb. 11, 1977	Langley awarded Vought a two-year contract to design, develop, and qualify a new guidance system for Scout.
July 14, 1978	Looking forward to the operational use of Shuttle, NASA Administrator Robert A. Frosch advised the space transportation system directorate that the use of Scout vehicles should be terminated in 1981.

### Thor Family

During NASA's first 10 years, the Thor booster, an intermediate range ballistic missile developed for the Air Force by the Douglas Aircraft Company (later McDonnell Douglas Corporation), was used alone for suborbital communications satellite tests and with Able, Agena B and D, and Delta upper stages to orbit medium-weight payloads. Thor's power was increased during the 1960s by lengthening its tank and by adding strap-on solid rocket motors to its base. The 1970s saw Thor grow even taller and adopt a new booster propulsion system. Delta, a two-part upper stage (actually two stages) also manufactured by McDonnell Douglas, and Lockheed's Agena were the only stages paired with Thor during the 1970s. Like Thor, Delta was uprated to provide more power and more sophisticated guidance capabilities. The Thor-Agena D configuration, used only four times in the second decade, retained its original characteristics (see table 1-30).

NASA put eight different Thor-Delta combinations on the launch pad in 1969-1978. The "Standard Delta" C model's MB-3 block II engine was uprated to a block III in 1965; and RS-27 (H-1) engine powered the booster in the 2000 series, which was first used in 1974. Thor's tank was extended further in the 1000 series (1972). Solid motors to augment the booster stage were first strapped to Thor in the 1960s, growing in number from three to nine by 1972. The Castor I strap-on was replaced by Castor II on the Thor-Delta L, M, and N models (1968), and the much larger Castor IV made its debut on the 3914 model in 1975. Delta's engine was uprated with the introduction of the E model (1965) and again with the 904 (1972). An entirely new engine, the TR 201, was incorporated into the second stage of the 2000 series in 1974. During the 1970s, Thiokol Corporation's TE 364-3 or 364-4

solid-propellant motors were used in the small but powerful Delta third stage to position a payload into precise orbit. See table 1-31 and figure 1-4 for more information on Thor-Delta models.

Thor-Delta 3914 was the most powerful of the five models introduced in 1969-1978. It differed from the much-used 2000 series only in its substitution of the larger Castor IV strap-ons. Delivering 4.69 million newtons thrust, model 3914 stood over 35 meters tall. It could send 900 kilograms to a synchronous transfer orbit. The 2000 series routinely put 1800-kilogram payloads into 370-kilometer orbits and 700 kilograms into synchronous transfer orbits.

Thor-Delta was NASA's most popular launcher. It was rolled out to the launch site 84 times in 1969-1978 (Scout was the second most used vehicle with 32 launches). But NASA was not its most frequent user. Instead, the agency put Thor-Delta to work launching satellites for other government agencies and foreign governments on a cost reimbursable basis. NASA attempted to launch 63 satellites provided by other parties, the bulk of these being communications satellites (see table 1-32 for a listing of Thor-Delta launches).\* Agency-sponsored payloads in-

\*Seven of these payloads were launched with only three launch vehicles; two others were launched with NASA payloads, for a total of 55 launches that were completely sponsored by organizations other than NASA. Five of these launch attempts experienced some degree of vehicle failure.

Table 1-30. Long-Tank Thrust-Augmented Thor-Agena D (Thorad-Agena D) Characteristics

	1st Stage Thor	Strap-on Solid Rocket Motors	2d Stage Agena D	Total with Spacecraft Fairing
Height (m):	21.6	6.1	6.2	35.5
Diameter (m):	2.4	0.79	1.5	
Launch weight (kg):	70 000	12 653	7250	90 000
Propulsion system:				
Powerplant:	MB-3 Block III	(3) TX-354-5 Castor II	XLR-81-Ba-11	
Thrust (newtons):	868 561	695 623	71 168	1 635 352
Burn time (sec.):	218	37	237	
Propellant:	RP-1/LOX	solid	UDMH/N <sub>2</sub> O <sub>4</sub>	
Payload capacity:	1400 kg to 185 km earth orbit			
Origin:	Air Force IRBM		Air Force- Lockheed design	
Program manager:	Robert W. Manville, NASA Hq.			
Project manager:	William R. Schindler, Goddard Space Flight Center			
Contractors:	McDonnell	Thiokol Corp.	Lockheed Missiles and Space Co.: prime	
	Douglas: prime		Bell Aerospace, Textron:	
	Rocketdyne Div.,		propulsion	
	Rockwell Corp.:			
	propulsion			
How utilized:	<i>Nimbus 3 and 4, OGO 6, SERT 2</i>			
Remarks:	The booster engine and strap-ons were improved over the original configuration.			
See also:	Volume 2.			

cluded the Orbiting Solar Observatory, Explorer, Biosatellite, Landsat, and Nimbus.

A special Package Attitude Control (Pac) system was carried piggyback on a Delta second stage during the August 9, 1969, launch of the *OSO 6* satellite. Pac was inserted into orbit (547 × 483 km) to flight test a long-life, low-power, three-axis, earth-stabilized control system for the Delta second stage and to demonstrate the feasibility of using this stage as a platform for experimental payloads.

Table 1-31. Thor-Delta 3914 Characteristics

	1st Stage Thor	Strap-on Solid Rocket Motors	2d Stage Delta	3d Stage	Total with Spacecraft
Height (m):	21.3	11.3	6.4	1.4	35.4
Diameter (m):	2.4	1.02	1.5	1.0	
Launch weight (kg):	93 200		6180	1160	190 630
Propulsion system					
Powerplant:	RS-27	(9) TX-526 Castor IV	TR 201	TE 364-4	
Thrust (newtons):	920 736	3 633 000 (total)	42 923	61 858	4 688 517
Burn time (sec.):	209	58.2	335	44	
Propellant:	RP-1/LOX	solid	Aerozene 50/N <sub>2</sub> O <sub>4</sub>	solid	
Payload capacity:	907 kg to synchronous transfer orbit				
Origin:	Air Force IRBM		NASA-McDonnell Douglas design		
Program manager:	Isaac Gillam, IV, Peter T. Eaton, NASA Hq.				
Project manager:	William Schindler, Goddard Space Flight Center				
Contractors:	McDonnell Thiokol Corp.		McDonnell Thiokol Corp.	McDonnell Thiokol Corp.	
	Douglas: prime Rocketdyne Div., Rockwell Corp.:		Douglas: prime TRW: propulsion		
How utilized:	medium-weight payloads, primarily commercial communications satellites				
Remarks:	From a continuing effort to increase the launch capacity of the Thor-Delta configuration, the 3914 model emerged as the most powerful Thor-Delta of the 1970s. As shown in fig. 1-4, the only major alteration to the 2000 Series that was made to produce the 3914 was the substitution of the larger Castor IV strap-ons for the long-used Castor IIIs. NASA was using the Delta 1000, 2000, and 3000 models simultaneously during the late 1970s. The RS-27 booster propulsion system was made of one main engine and two vernier engines. Five of the nine strap-ons ignited at liftoff, the remaining four at 64 seconds after liftoff.				
See also:	Volume 2.				

MODEL DESIGNATION:	C ("STANDARD DELTA")	E ("THRUST-AUGMENTED IMPROVED DELTA," OR TAID)*	L, M, N ("LONG-TANK DELTA")	M, N-6	904	1000 SERIES**	2000 SERIES ("STRAIGHT 8")	3914
STAGES								
1ST (THOR):	MB-3 BLOCK II	MB-3 BLOCK III					RS-27 (H-1)	
STRAP-ON SOLID ROCKET MOTORS:	N/A	(3) TX 33-52 CASTOR I	(3) TX 354-5 CASTOR II	(6) TX 354-5 CASTOR II	(9) TX 354-5 CASTOR II	EXTENDED LONG TANK		(9) TX-526 CASTOR IV
2d (DELTA):	AJ-10-118D LONG-TANK	AJ-10-118E LARGE-DIAMETER			AJ-10-118 F			TR 201
3d:	X-258	FW-4			TE 364-4			TE 364-4
L=FW-4D M=TE 364-3 N=NO 3d STAGE								
PAYLOAD CAPACITY (kg)								
370 km EARTH ORBIT:	408	735	998	1293	1683	1837	1887	—
SYNCHRONOUS TRANSFER ORBIT:	82	204	356	454	635	680	703	907
YEARS IN USE:	1963-69	1965-71	1968-72	1970-71	1972-73	1972-	1974-	1975-

\* Two other models that built on the Delta E configuration were the Delta G (two stages only) and the Delta J (TE 364-3 third stage). The Delta E model was the most popular of the 12 Delta configurations.

\*\* The 1904 Delta had a 1.65-meter fairing; the 1914 Delta a 2.44-meter fairing.

Figure 1-4. Thor-Delta Development, 1969-1978

Source: NASA News Release 75-151, May 16, 1975, p. 5.



Table 1-32. Listing of Thor-Delta Vehicles

Date	Mission	Thor-Delta Successful*
1969		
1-22	OSO 5	Yes
1-20	Isis 1	Yes
2-5	Intelsat III F-3	Yes
2-26	ESSA 9	Yes
5-21	Intelsat III F-4	Yes
6-21	Explorer 41	Yes
6-28	Biosatellite 3	Yes
7-25	Intelsat III F-5	No; 3d stage malfunctioned (motor case ruptured or nozzle failed)
8-9	OSO 6/Pac	Yes
8-27	Pioneer E/TETR C	No; 3d stage malfunctioned (vibrating relief valve caused hydraulic oil leak)
11-21	Skynet 1	Yes
1970		
1-14	Intelsat III F-6	Yes
1-23	Itos 1/Oscar 5	Yes
3-20	NATO 1	Yes
4-22	Intelsat III F-7	Partial; booster underperformed but spacecraft thrusters helped put payload into proper orbit
7-23	Intelsat III F-8	Yes
8-19	Skynet 2	Yes
12-11	NOAA 1/Cepe	Yes
1971		
2-2	NATO 2	Yes
3-13	Explorer 43	Yes
3-31	Isis 2	Yes
9-29	OSO 7/TETR 3	Partial; 2d stage anomaly led to spacecraft separation at wrong pitch angle
10-21	Itos B	No; 2d stage malfunctioned (oxidizer system leak)
1972		
1-31	HEOS 2	Yes
3-11	TD-1A	Yes
7-23	ERTS 1	Yes
9-22	Explorer 47	Yes
10-15	NOAA2/Oscar 6	Yes
11-9	Anik 1	Yes
12-10	Nimbus 5	Yes
1973		
4-20	Anik 2	Yes
6-10	Explorer 49	Yes
7-16	Itos E	No; 2d stage malfunctioned (hydraulic pump failure)
10-25	Explorer 50	Yes
11-6	NOAA 3	Yes
12-15	Explorer 51	Yes

Table 1-32. Listing of Thor-Delta Vehicles (Continued)

Date	Mission	Thor-Delta Successful*
1974		
1-18	Skynet II A	Yes
4-13	Westar 1	Yes
5-17	SMS 1	Yes
10-10	Westar 2	Yes
11-15	NOAA 4/Intesat/ Amsat Oscar 7	Yes
11-22	Skynet II B	Yes
12-18	Symphonie 1	Yes
1975		
1-22	Landsat 2	Yes
2-6	SMS 2	Yes
4-9	GEOS 3	Yes
5-7	Anik 3	Yes
6-12	Nimbus 6	Yes
8-8	COS B	Yes
8-27	Symphonie 2	Yes
10-6	Explorer 54	Yes
10-16	GOES 1	Yes
11-20	Explorer 55	Yes
12-13	Satcom 1	Yes
1976		
1-17	CTS 1	Yes
2-19	Marisat 1	Yes
3-26	Satcom 2	Yes
4-22	NATO III A	Yes
5-4	Lageos	Yes
6-10	Marisat 2	Yes
7-8	Palapa 1	Yes
7-29	NOAA 5	Yes
10-14	Marisat 3	Yes
1977		
1-28	NATO III B	Yes
3-10	Palapa 2	Yes
4-20	GEOS	No; 3d stage malfunctioned; spacecraft apogee motor placed spacecraft into alternate orbit after 3d stage failed to put payload into transfer orbit
6-16	GOES 2	Yes
7-14	GMS	Yes
8-25	Sirio	Yes
10-22	ISEE 1/ISEE 2	Yes
11-23	Meteosat	Yes
12-15	CS (Sakura)	Yes

Table 1-32. Listing of Thor-Delta Vehicles (Continued)

Date	Mission	Thor-Delta Successful*
1978		
1-26	IUE	Yes
3-5	Landsat 3/Oscar 8	Yes
4-7	BSE	Yes
5-11	OTS 2	Yes
6-16	GOES 3	Yes
7-14	GEOS 2	Yes
8-12	ISEE 3	Yes
10-24	Nimbus 7/Cameo	Yes
11-13	HEAO 2	Yes
11-19	NATO III C	Yes
12-16	Anik 4	Yes

\* 7 failures-partial failures out of 84 attempts (91.6% successful).

Table 1-33. Chronology of Thor-Delta Development and Operations

Date	Event
June 26, 1970	NASA awarded McDonnell Douglas a contract to incorporate the new Delta inertial guidance system into the Thor-Delta vehicle.
Oct. 13, 1971	Details of the improved 2000 series Thor-Delta were discussed with representatives of potential user organizations.
March 11, 1972	The first Thor-Delta with a Universal Boat Tail was launched ( <i>TD-1A</i> ); the boat tail allowed the addition of up to nine strap-on solid rocket motors.
July 23, 1972	The launch of <i>Landsat 1</i> marked the first use of nine strap-ons and the new updated second-stage engine (AJ 10-118F). This Thor-Delta model was designated the 904.
Sept. 22, 1972	With the launch of <i>Explorer 47</i> , the first 1000 series Thor-Delta was proven successful.
Nov. 15, 1974	For the first time, a Thor-Delta launched three satellites simultaneously ( <i>NOAA 4</i> , <i>Intesat</i> , and <i>Amsat Oscar 7</i> ).
May 7, 1975	The launch of <i>Anik 3</i> marked the 100th successful Delta liftoff.
Spring 1976	NASA officials studied the possibility of using a Delta-class (TE 364) stage instead of the Air Force-sponsored Interim Upper Stage for use with Shuttle payloads.
May 1976	The U.S. Aeronautics and Astronautics Control Board, made up of NASA and Department of Defense personnel, approved the Delta 3914 model for government use.
Nov. 23, 1976	NASA Headquarters plans called for Delta to be phased out at the Kennedy Space Center during 1980 in anticipation of the Space Transportation System becoming operational.

## The Titan III Family

The Titan III concept, which dates from the early 1960s, was the product of the Space and Missile Systems Organization (SAMSO) of the Air Force Systems Command. From three classes of components (liquid rocket cores, solid rocket motors, and upper stages, a variety of launch vehicles could be assembled. Martin Marietta (formerly the Martin Company), the manufacturer, offered the Air Force and NASA a standard and a stretched core (the two Titan stages), five- and seven-segment strap-on solid motors, as well as the small Algol strap-ons, and six upper stages (the Transtage and Centaur being the most commonly used). The Air Force conducted its first test flight (Titan IIIA) in September 1964 and by the spring of the following year was trying to sell the idea of the versatile Titan to NASA.

NASA's long-range planners of the mid-1960s did not foresee the agency's adoption of the Titan III. Atlas-Centaur would serve their needs until a reusable launch vehicle was ready. What the NASA officials failed to predict were the severe budget reductions Congress would impose on the civilian space program, reductions that forced the scrapping of a nuclear-powered upper stage and stretching of the schedule for the development of a reusable Shuttle. NASA needed a vehicle more powerful than Atlas-Centaur to launch interplanetary payloads (Viking and Voyager) it had planned for the 1970s. In 1967, NASA began to study seriously the possibility of adapting to its needs the Titan III paired with the Centaur upper stage. By early 1968, the space agency had decided to add the Air Force launch vehicle to its table. Lewis Research Center managed NASA's participation in the Titan III program (see table 1-37 for a more detailed chronology of events).

NASA used the Titan IIIC (with the Transtage) only once (table 1-34). In May 1973, it launched *ATS 6* into earth orbit. It was the Titan IIID-Centaur combination that most attracted the agency's attention (table 1-35). As modified and improved to suit NASA's payloads, the vehicle was renamed Titan IIIE-Centaur D-1T. NASA's first test of this powerful duo (13.55 million newtons thrust) on February 1974 ended in failure because of the malfunction of a proven Centaur component, but the first satellite launch 10 months later (*Helios 1*) was an unqualified success. The bulbous launch vehicle with its two strap-on booster rockets performed equally well in 1975-1977 for *Viking 1* and *2*, *Helios 2* and *Voyager 1* and *2* (table 1-36).

Table 1-34. Titan IIC Characteristics

	Stage 0 Solid Rocket Motors (2)	1st Stage Titan	2d Stage Titan	3d Stage Transtage	Total
Height (m):	25.9	22.2	7.1	9.4	38.7
Diameter (m):	3.05	3.05	3.05	3.05	
Launch weight (kg):	226 800 each	123 830	33 112	16 500	400 242
Propulsion system					
Powerplant:	United Technology 1205	Aerojet YLR87- AJ-11	Aerojet YLR91- AJ-11	Aerojet AJ-10-118F	
Thrust (newtons):	10.45 mill (combined)	2.16 mill	456 570	35 600	13.1 mill
Burn time (sec.):	110	150	108	420	
Propellant:	powdered aluminum/ ammonium perchlorate	N <sub>2</sub> H <sub>4</sub> - UDMH/ N <sub>2</sub> O <sub>4</sub>	N <sub>2</sub> H <sub>4</sub> - UDMH/ N <sub>2</sub> O <sub>4</sub>	N <sub>2</sub> H <sub>4</sub> - UDMH/ N <sub>2</sub> O <sub>4</sub>	
Payload capacity:	10 443 kg to earth orbit 1202 kg to Mars				
Origin:	Air Force Titan missile				
Contractors:	Chemical      Martin Marietta Corp. Systems Div., United Technologies				
Program manager:	Theodrick B. Norris, NASA Hq.				
Project manager:	Andrew J. Stofan, Lewis Research Center				
How utilized:	ATS				
Remarks:	NASA and the Air Force signed a memorandum of understanding allowing NASA to use this Air Force vehicle for the ATS project on Feb. 6-7, 1970. The second ATS mission (ATS G) was cancelled in Jan. 1973. <i>ATS 6</i> was launched successfully on May 30, 1973.				

Table 1-35. Titan IIIE-Centaur Characteristics

	Stage O Solid Rocket Motors (2)	1st Stage Titan	2d Stage Titan	3d Stage Centaur D-IT	Centaur Standard Shroud	Total
Height (m):	25.9	22.2	7.1	9.7	(17.7)	48.8
Diameter (m):	3.05	3.05	3.05	3.05	4.3	
Launch weight (kg):	226 800 each	123 830	33 112	17 700	3092	631 334
Propulsion system						
Powerplant:	United Technology 1205	Aerojet YLR87-AJ-11	Aerojet YLR91-AJ-11	Pratt & Whitney (2) RL-10A-3-		
Thrust (newtons):	10.68 mill (combined)	2.31 mill	449 248	133 440		13.55 mill
Burn time (sec.):	110	150	208	450		918
Propellant:	powdered aluminum/ ammonium perchlorate	N <sub>2</sub> H <sub>4</sub> -UDHM/ N <sub>2</sub> O <sub>4</sub>	N <sub>2</sub> H <sub>4</sub> -UDHM/ N <sub>2</sub> O <sub>4</sub>	LH <sub>2</sub> /LOX		
Payload capacity:	15 000 kg to earth orbit 3000 kg to synchronous orbit 3402 kg to Mars					
Origin:	Air Force Titan IIID modified to NASA's requirements			NASA design		
Contractors:	Chemical Martin Marietta Corp. Systems Div., United Technologies			General Dynamics/ Convair		
Program manager:	R.A. Mattson, NASA Hq.					
Project manager:	Andrew J. Stofan, Lewis Research Center					
How utilized:	Viking, Voyager					
Remarks:	<p>In this configuration, the Centaur upper stage replaced the standard Titan third stage, called the transtage; Centaur was capable of restarting its two engines, a desirable characteristic for planetary missions. During Centaur's coast phase, attitude control was accomplished by 14 small hydrogen peroxide thrusters.</p> <p>When the two five-segment solid rocket motors, together known as "stage O," were jettisoned, the Titan first stage ignited. These strap-on motors provided more than four times the thrust of the Atlas booster at liftoff. For two missions (<i>Helios 1</i> and <i>Helios 2</i>), a fourth-stage solid-propellant motor (Thiokol TE-M-364-4) added to the spacecraft package.</p>					

Table 1-36. Listing of Titan IIIC/Titan IIIE-Centaur Vehicles

Vehicle #	Date	Mission	Titan Stage Successful	Centaur Stage Successful*
-----	May 30, 1973	<i>ATS 6 (IIIC)</i>	Yes	N/A
TC-1	Feb. 11, 1974	<i>TC-1</i> proof test (IIIE)	Yes	No (liquid oxygen boost pump failure)
TC-2	Dec. 10, 1974	<i>Helios 1 (IIIE)</i>	Yes	Yes
TC-4	Aug. 20, 1975	<i>Viking 1 (IIIE)</i>	Yes	Yes
TC-3	Sept. 9, 1975	<i>Viking 2 (IIIE)</i>	Yes	Yes
TC-5	Jan. 15, 1976	<i>Helios 2 (IIIE)</i>	Yes	Yes
TC-7	Aug. 20, 1977	<i>Voyager 2 (IIIE)</i>	Yes	Yes
TC-6	Sept. 5, 1977	<i>Voyager 1 (IIIE)</i>	Yes	Yes

\* Titan IIIC: 0 failures out of 1 attempt (100% successful).

Titan IIIE-Centaur: 1 failure out of 7 attempts (85.7% successful).

Table 1-37. Chronology of Titan III Family Development and Operations

Date	Event
Sept. 15, 1961	The Department of Defense (DoD) Research and Engineering Office requested the preliminary study of a standardized space booster.
Dec. 1961	The Air Force was given permission by the administration to proceed with the development of a powerful booster to be built on the technology of the Titan II vehicle (Program 624A).
May 1962	The Air Force completed its Titan III preliminary design effort and submitted a plan to DoD.
Aug. 11, 1962	The development of Titan III was authorized by DoD; the Air Force awarded Martin Marietta a systems integration contract for the new vehicle.
Feb. 25, 1963	The Air Force awarded Martin Marietta a contract to develop and manufacture the Titan III.
June 30, 1964	The Air Force accepted the first Titan IIIA from the manufacturer.
Sept. 1, 1964	The launch of the first Titan IIIA was not successful due to a third-stage malfunction.
Nov. 1964	It was revealed by an Air Force official that studies conducted by the Jet Propulsion Laboratory (JPL) and General Electric (GE) indicated that the Titan IIIC vehicle would enhance Surveyor, Mariner, and Voyager Mars landing missions.
Dec. 10, 1964	The first completely successful launch of the Titan IIIA took place.
Feb. 1965	The Air Force announced its plans to pair the Titan IIIC with the Centaur upper stage.
April 1965	DoD announced that it had awarded Martin Marietta a contract for a "Titan III-X" series vehicle. The standard Titan III would be redesigned to accept a variety of upper stages.
April-May 1965	The Air Force and the House of Representatives, Committee on Science and Astronautics, requested NASA to consider using the Titan IIIC as a backup for its Surveyor project, but NASA officials replied that current plans did not include the Air Force vehicle.
June 18, 1965	The first launch of a Titan IIIC took place at the Eastern Test Range.
Sept. 1965	Air Force officials considered a Titan IIID concept for the first time.
June 16, 1966	A Titan IIIC launched eight Air Force satellites successfully.
July 29, 1966	The first launch of a Titan IIIB, paired with an Agena D upper stage, took place.
Aug. 29, 1966	The Air Force awarded a study contract for a Titan IIID to Martin Marietta.
June 26, 1967	NASA awarded a study contract to Martin Marietta to determine the feasibility of

Table 1-37. Chronology of Titan III Family Development and Operations (Continued)

Date	Event
Nov. 1967	using a Titan-Centaur combination vehicle for agency missions. DoD announced that it would begin procuring Titan IIID vehicles from Martin Marietta.
Jan. 26, 1968	Air Force and contractor officials briefed high-ranking NASA officials on the Titan III family.
Feb. 1968	Because of budget cuts that precluded the development of a more powerful generation of vehicles or the speedy development of a reusable launch vehicle, NASA officials decided to use the Titan IIIC for sending probes to the near planets.
June 11, 1968	NASA's Lewis Research Center awarded Martin Marietta a contract for a Titan-Centaur integration study.
Nov. 20, 1968	NASA awarded Martin Marietta a follow-on (nine-month) Titan-Centaur study contract.
March 1969	Management of NASA's Titan IIIC and Titan-Centaur projects was assigned to Lewis.
March 6, 1969	A project approval document (PAD) was signed for the procurement of Titan IIIC for the Applications Technology Satellite (ATS) project.
May 23, 1969	The last (17th) research and development launch of the Titan III took place.
Sept. 1969	Lewis contracted with Martin Marietta for a systems definition study for Titan-Centaur.
Oct. 30, 1969	Lewis awarded General Dynamics/Convair a contract to design and build an improved Centaur stage.
Feb. 6-7, 1970	A memorandum of understanding was signed by NASA and the Air Force regarding NASA's use of the Titan IIIC vehicle for ATS F and G.
July 10, 1970	A contract was awarded to General Dynamics/Convair by NASA for the reconfiguration of the D-1 Centaur so that it would be compatible with the Titan IIIE, NASA's version of the IIID.
June 15, 1971	The first launch of the Titan IIID took place at Vandenberg Air Force Base.
Nov. 30, 1971	A follow-on Centaur management and support contract was awarded to General Dynamics/Convair to provide engineering support to mate Centaur with Titan IIIE.
May 30, 1973	NASA used Titan IIIC to launch <i>ATS 6</i> . The Space & Missile Systems Organization (SAMSO) of the Air Force Systems Command served as the launch agency for the mission. ( <i>ATS G</i> , the other mission scheduled to use the Titan IIIC, was cancelled on Jan. 5, 1973 because of budgetary restraints placed on the agency.)
Sept. 24, 1973	Titan IIIE-Centaur was rolled out on the pad at the Kennedy Space Center for the first time. The initial test flight was scheduled for Jan. 24, 1974, but that date was later changed.
Feb. 11, 1974	The first test launch of Titan IIIE-Centaur ( <i>TC-1</i> ) was a partial failure due to the malfunction of a liquid oxygen boost pump on the Centaur stage. The upper stage was destroyed less than 13 minutes after liftoff. Other objectives associated with the integration of the two vehicles were accomplished. A dynamic model of the Viking spacecraft and a Space Plasma High Voltage Interaction Experiment were carried as payload during the test. It was determined that a second proof flight was not required.
Dec. 10, 1974	The successful launch of <i>Helios 1</i> by Titan IIIE-Centaur took place.
Aug. 20, 1975	The successful launch of <i>Viking 1</i> by Titan IIIE-Centaur took place.
Sept. 9, 1975	The successful launch of <i>Viking 2</i> by Titan IIIE-Centaur took place.
Jan. 15, 1976	The successful launch of <i>Helios 2</i> by Titan IIIE-Centaur took place.
Aug. 20, 1977	The successful launch of <i>Voyager 2</i> by Titan IIIE-Centaur took place.
Sept. 5, 1977	The successful launch of <i>Voyager 1</i> by Titan IIIE-Centaur took place.



## Space Transportation System Solid Rocket Boosters

When NASA officials were asked in 1969 by President Richard M. Nixon's Space Task Group what goals the agency had for the future, a reusable spacecraft was high on their "want list." NASA planned to develop a new system for operations in earth orbit "with emphasis upon the critical factors of: (1) commonality, (2) reusability, and (3) economy." Space station modules large enough to accommodate a crew of 6 to 12 each, and an earth-to-orbit Shuttle that could support the orbiting stations were two major components of this new system. A Space Transportation System would "carry passengers, supplies, rocket fuel, other spacecraft, equipment, or additional rocket stages to and from orbit on a routine aircraft-like basis."<sup>8</sup>

In their attempt to reduce the number of throwaway elements in any mission, NASA engineers sought to design an orbital spacecraft that could be boosted by reusable launch vehicle and returned like an airplane, ready to be used again with some refurbishing. For reasons of economy, early drawings of a delta-wing craft perched on a much larger winged launch vehicle capable of flying back to the launch site were replaced by visions of a more modest Shuttle craft sent to orbit by expendable or partly expendable vehicles. Titan and Saturn were the two most popular candidates for the interim expendable booster role in the early 1970s. An alternative to an enhanced Titan or Saturn, which were liquid-propellant vehicles, was a large solid-propellant booster that could work with the Shuttle's main engine to launch the spacecraft. In the fall of 1971, NASA directed its contractors to determine the feasibility of recovering and reusing traditional ballistic boosters.\* Satisfied that an interim launch system could be at least partly reusable, the agency set four companies to work in January 1972 studying the practicality of using 3- and 4-meter (120- and 156-inch) solid motors as part of the booster package.\*\* In mid-March, NASA Headquarters announced its decision: the Shuttle orbiter (75 000 kilograms), which would be mounted to the side of a large external fuel tank (719 000 kilograms), would be launched by its own liquid-propellant main engine and two solid rocket boosters (SRBs). It would be more economical and faster to produce a satisfactory solid booster than to develop a new or to substantially rework an existing liquid-fueled system. Keeping the total price of the Space Transportation System to a minimum had become a pervasive concern when the President approved the program on January 5, 1972.

NASA selected Thiokol Chemical Company to develop the Shuttle solid rocket boosters in November 1973. Designed to produce more than 12.5 million newtons thrust each, the new motors were static fired for the first time in 1977. The SRBs, made of 11 individual segments, were 45.4 meters tall and weighed 569 000 kilograms. The largest solid stages ever built, they were designed as the Space Transportation Systems' "primary propulsive element providing impulse and thrust

---

\*Shuttle studies were conducted by North American Rockwell Corporation with General Dynamics Corporation, by McDonnell Douglas Astronautics Company with Martin Marietta Corporation, by Grumman Aerospace Corporation with Boeing Company, and by Lockheed Missiles and Space Company.

\*\*Under the direction of the Marshall Space Flight Center, Aerojet-General Corporation, Lockheed Propulsion Company, Thiokol Chemical Company, and United Technology Center conducted the solid motor studies.

vector control . . . from ignition to SRB staging.”<sup>9</sup> The two boosters would be strapped to either side of the external tank (figure 1-5). At approximately two minutes after launch, their fuel supply expended, the SRBs would be jettisoned, their fall to the Atlantic Ocean (and later the Pacific Ocean) being checked by a trio of parachutes. From the ocean, they would be retrieved, refurbished, and reused—up to 20 times. NASA’s Marshall Space Flight Center, Huntsville, Alabama, was charged with monitoring the contractors working on the new boosters.

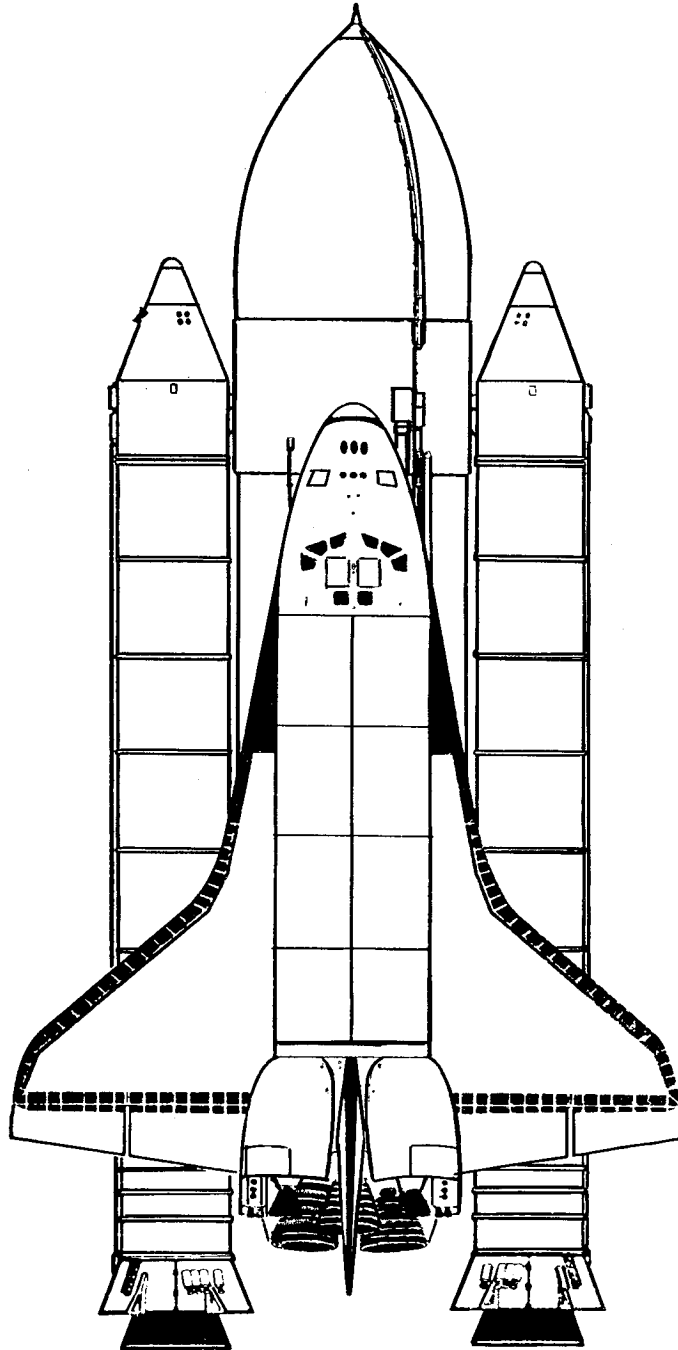

*Figure 1-5. The Shuttle orbiter was designed to be attached to the large external tank, which supplied liquid propellant to the orbiter’s engines. The two SRBs fired in parallel along with the Shuttle main engine at liftoff.*

ORIGINAL DRAWING IS  
OF POOR QUALITY

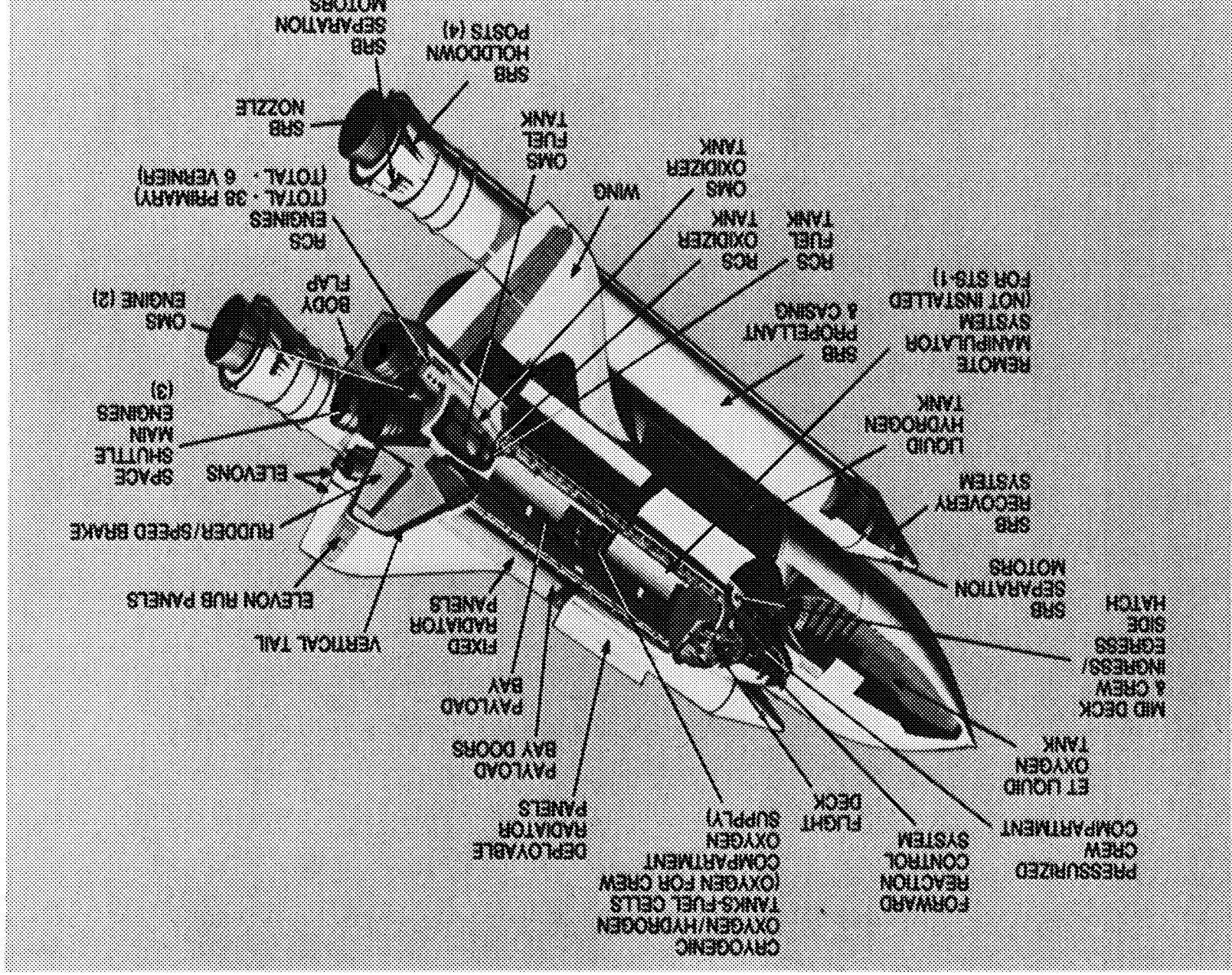
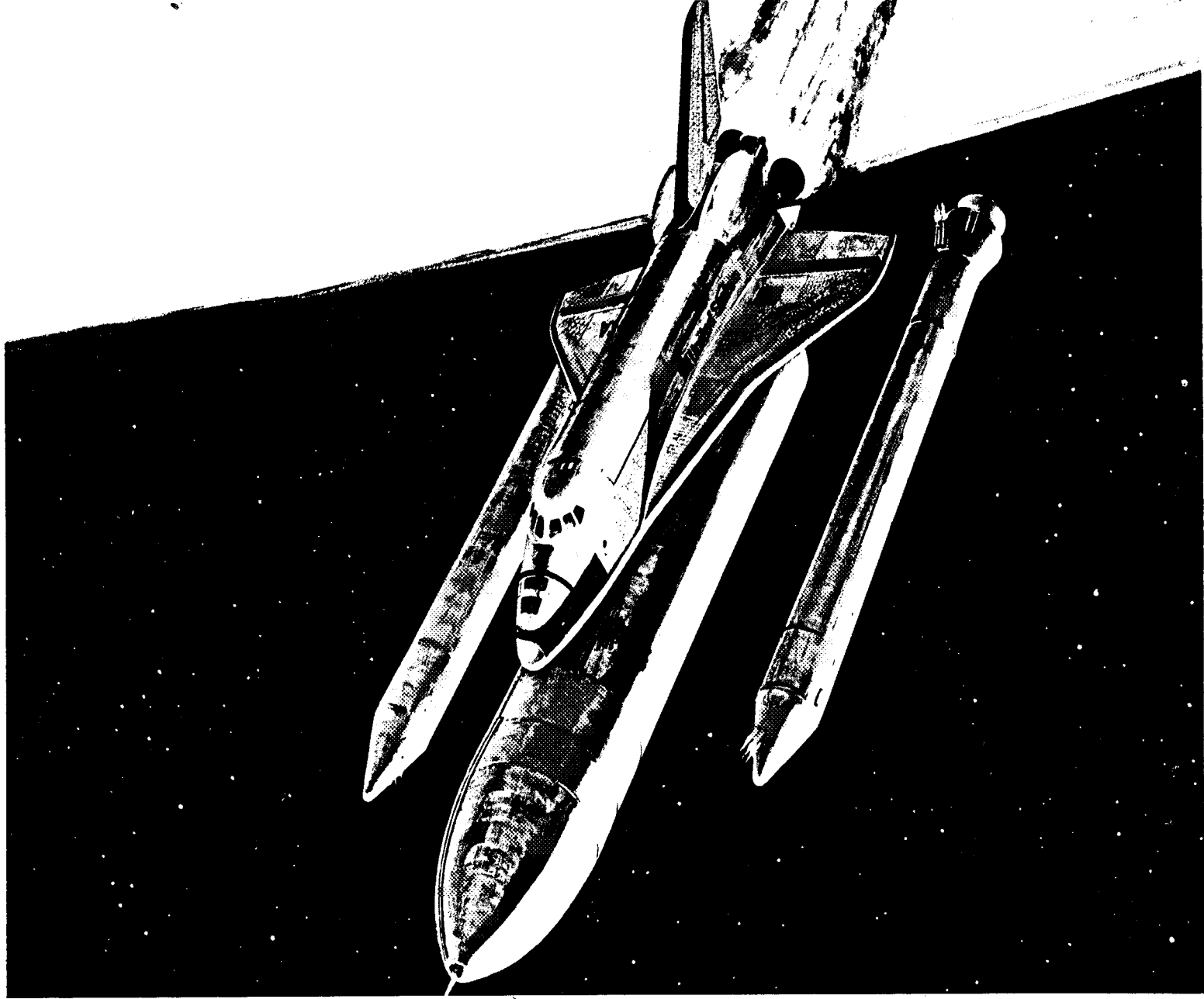

Figure I-6. The SRB structural subsystem provided structural support for the vehicle on the pad, transferred thrust loads to the external tank-orbiter combination, and provided housing, structural support, and bracketry necessary for the recovery system, electrical components, separation motors, and thrust vector control system.



*Figure 1-7. At 2 minutes, 12 seconds, into the mission, the SRBs are designed to separate from the external tank-orbiter combination at an altitude of 46 kilometers. Five minutes later, the spent boosters would land in the ocean.*

ORIGINAL PAGE IS  
OF POOR QUALITY

Table 1-38. Shuttle Solid Rocket Booster Characteristics

---

Height (m):	45.4 (38.2, motor only)
Diameter (m)	3.65
Launch weight (kg):	569 282.6 each
Inert weight (kg):	79 406 each
Number used:	2 fired in parallel
Thrust (newtons):	12 596 736 each
Burn time (sec.):	122.4
Propellant:	Composite made of polybutadiene acrylic acid acrylonitrile terpolymer binder, ammonium perchlorate, and aluminum powder (TP-H1148)
Recovery system:	1 drogue chute (16.5 m diam.; 430 kg) 3 main chutes (35 m diam.; 2159.6 kg total)
Contractors:	Thiokol Chemical Corp.: prime McDonnell Douglas Corp.: structures United Space Booster, Inc.: assembly, recovery Denver Div., Martin Marietta Corp.: decelerator subsystem United Technology Corp.: booster separation motors
How utilized:	The SRBs were designed to work in concert with the Shuttle main engine to boost the 75 000 kilogram reusable Shuttle orbiter plus 719 000 kilograms of liquid hydrogen and liquid oxygen stored in the external tank. At an altitude of 1.24 kilometers after the SRBs had expended their fuel, the boosters would be jettisoned. Their fall to the ocean some 250 kilometers from the launch site would be checked by a parachute system (deceleration 26 meters per second at impact). Thiokol designed the boosters to be recovered, refurbished, and reused (up to 20 times). The solid rocket motor was static fired successfully three times in 1977-78. The first Shuttle launch was scheduled for the early 1980s.
See also:	Chapter 2.

---

Table 1-39. Chronology of Shuttle Solid Rocket Booster Development

Date	Event
Jan. 31, 1969	NASA awarded integral launch and reentry vehicle (ILRV) study contract to Lockheed Missile & Space Company (clustered or modular reusable flyback stages), North American Rockwell Corporation (expendable tank configurations), General Dynamics Corporation (expendable tank concept and modularized solid propulsion stages), and McDonnell Douglas Astronautics Company ("triamese" configurations and reusable flyback stages). Studies were to be concluded in September. In June, however, these "phase A" studies were extended and redirected at NASA's request toward a more fully reusable system.
Nov. 1969	NASA received phase A ILRV studies from its four contractors and an in-house-funded report from Martin Marietta Corporation.
Dec. 10, 1969	A joint NASA-Department of Defense Space Shuttle Task Group submitted a "Summary Report of Recoverable versus Expendable Booster Space Shuttle Studies," in which the group recommended a fully reusable system.
Feb. 18, 1970	NASA issued a request for proposals for phase B definition studies of a fully reusable Shuttle system (proposals due March 30).
May 9, 1970	NASA awarded a North American Rockwell-General Dynamics team an 11-month contract (phase B) to define more fully their Shuttle concept. NASA also selected McDonnell Douglas-Martin Marietta to produce a competitive design.
June 15, 1970	NASA chose four firms to conduct 11-month feasibility studies on alternative Shuttle designs: Grumman Aerospace Corp.-Boeing Company (stage-and-a-half Shuttle with expendable propulsion tanks, reusable orbiter with expendable booster, reusable booster with solid propulsion auxiliary boosters), Lockheed (expendable tank orbiter), and Chrysler Corp. (single-stage reusable orbiter).
Aug. 26, 1970	NASA announced that Convair Div., General Dynamics, would conduct an eight-month design study for a high-energy upper stage that could be used as an expendable upper stage with Shuttle.
Sept. 28, 1970	NASA's Marshall Space Flight Center chose McDonnell Douglas to conduct a study of an expendable second stage for a reusable Shuttle booster.
Nov. 19, 1970	Marshall awarded a one-year modification to its Shuttle study contract with McDonnell Douglas; the contractor would also be responsible for testing the structural components of its proposed Shuttle booster.
June 10, 1971	Marshall was officially assigned the role of manager of the Shuttle main engine and booster.
June 16, 1971	NASA Administrator James C. Fletcher indicated that the agency may take a "phased approach" to Shuttle development. Hardware for the orbiter would be developed first, which could be used with an expendable booster. Development of a reusable booster would follow.
July 1, 1971	Phase B definition contracts with North American Rockwell-General Dynamics and McDonnell Douglas-Martin Marietta, and study contracts with Grumman-Boeing and Lockheed were extended through October to consider the phased approach to Shuttle design and the use of existing liquid or solid propulsion boosters as interim Shuttle launch vehicles.
Summer 1971	Martin Marietta engineers concluded that the Titan launch vehicle could be used as an interim expendable booster for Shuttle.
Sept. 1971	Grumman-Boeing officials suggested that Saturn IC could serve as an interim Shuttle booster and that a winged Saturn reusable booster was feasible.
Oct. 7, 1971	Studies being conducted by North American Rockwell-General Dynamics, McDonnell Douglas-Martin Marietta, Grumman-Boeing, and Lockheed were extended again to examine ballistic recoverable boosters.
Dec. 6, 1971	NASA awarded contracts for feasibility studies of pressure-fed engines for a water-recoverable Shuttle booster to TRW, Inc., and Aerojet-General Corporation.
Jan. 27, 1972	Marshall chose Aerojet-General, Lockheed Propulsion Company, Thiokol Chemical Company, and United Technology Center to study the use of 120-inch and 156-inch solid motors as part of the Shuttle booster package.

Table 1-39. Chronology of Shuttle Solid Rocket Booster Development (Continued)

Date	Event
March 15, 1972	For economic reasons, NASA Headquarters officials chose the solid booster configuration for Shuttle over the development of a new liquid fueled system. Two 156-inch-diameter, 140-foot-tall solid rocket boosters (SRBs) paired with the orbiter's liquid fueled main engines would boost the Shuttle to orbit. At an altitude of 1.24 kilometers, the boosters would be jettisoned, and their descent to the Atlantic slowed by parachutes. The two boosters would be recovered from the ocean and refurbished for another mission. The two solid boosters would be mounted on either side of a larger external propulsion tank that would feed the orbiter's main engines. The orbiter would be mounted to the tank (see fig. 1-5).
June 21, 1972	Six firms submitted proposals to Marshall for a parachute system for the Shuttle solid boosters.
Sept. 7-8, 1972	NASA held a review at Marshall to advise industry on its plans for Shuttle's external propulsion tank and solid rocket boosters.
Dec. 12-13, 1972	A second review session was held at Marshall for 350 industry and government representatives interested in the external tank and SRB. A similar meeting took place on March 6, 1973.
Feb. 10- March 10, 1973 July 16, 1973	Water impact and towing tests of a Shuttle SRB-type motor were conducted by the U.S. Navy at Long Beach, California, for Marshall. Marshall issued a request for proposals for Shuttle solid rocket motor development to Aerojet-General Solid Propulsion Company, Lockheed, Thiokol, and United Technology Center (proposals due Aug. 27.).
Nov. 1973	Marshall conducted drop tests of a solid rocket motor scale model and a three-parachute recovery system.
Nov. 20, 1973	NASA selected Thiokol to design, develop, and test the Shuttle SRB. This six-year contract was scheduled to run through September 1979.
Jan. 1974	Lockheed protested to the General Accounting Office (GAO) NASA's selection of Thiokol as designer of the SRB. Because of the protest, NASA issued Thiokol a 90-day study contract on February 13 so the firm could continue its work while GAO studied the situation. The study contract was extended again on May 20 for 45 days.
June 1974	United Technology Center submitted an unsolicited proposal to be a backup contractor to Thiokol in the solid rocket motor program.
June 26, 1974	A letter contract was awarded to Thiokol by Marshall for the development of the SRB. GAO had completed its investigation of the agency's procedures in evaluating the SRB proposals and on June 24 recommended that NASA decide whether or not the selection of Thiokol should be reconsidered.
May 15, 1975	NASA issued Thiokol a contract for solid rocket motor design, development, testing, and engineering for the period July 26, 1974 through June 30, 1980.
August 7, 1975	Marshall chose the Chemical Systems Division, United Technology Corporation, to supply the SRB separation motors. Each booster would require eight separation motors.
Aug. 22, 1975	Marshall chose McDonnell Douglas to procure SRB structures (aft skirts, rings, struts, frustrums, nose caps).
Nov. 1975	NASA officials decided to use the vehicle assembly building at launch complex 39 at the Kennedy Space Center to assemble the SRBs.
Jan. 8, 1976	Marshall issued a request for proposals for an SRB decelerator (parachute) subsystem. The 36.5-meter-diameter chutes would be tested at Marshall and at NASA's Dryden Flight Research Center.
May 28, 1976	Martin Marietta was chosen by Marshall to produce the SRB decelerator subsystem. Pioneer Parachute Company would serve as a subcontractor to Martin Marietta.
Sept.-Oct. 1976	Engineers at Marshall tested the thrust vector control system for the SRB.
Dec. 21, 1976	Marshall selected United Space Boosters, Incorporated, as the assembly contractor for the SRB.

Table 1-39. Chronology of Shuttle Solid Rocket Booster Development (Continued)

Date	Event
June 1977	The SRB recovery system was tested at the National Paracnute Test Range, El Centro, California. One drogue and three main chutes made up the system.
July 18, 1977	The Shuttle solid rocket motor was test fired for the first time (DM-1). In two minutes, the motor produced more than 12 million newtons thrust.
Jan. 19, 1978	The Shuttle booster solid rocket motor was fired successfully a second time (DM-2).
April 1978	The first full-design-limit tests of the SRB recovery system were conducted at the National Parachute Test Range. Further tests were held in July.
Sept. 12, 1978	The Shuttle SRB parachute drop test program was completed.
Oct. 19, 1978	The Shuttle solid rocket motor was successfully fired a third time (DM-3).



Lined writing area for notes.

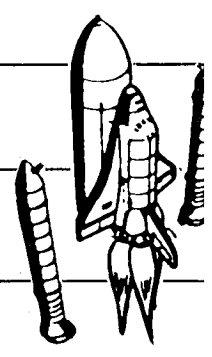

---

CHAPTER TWO

---

**MANNED SPACEFLIGHT**

---

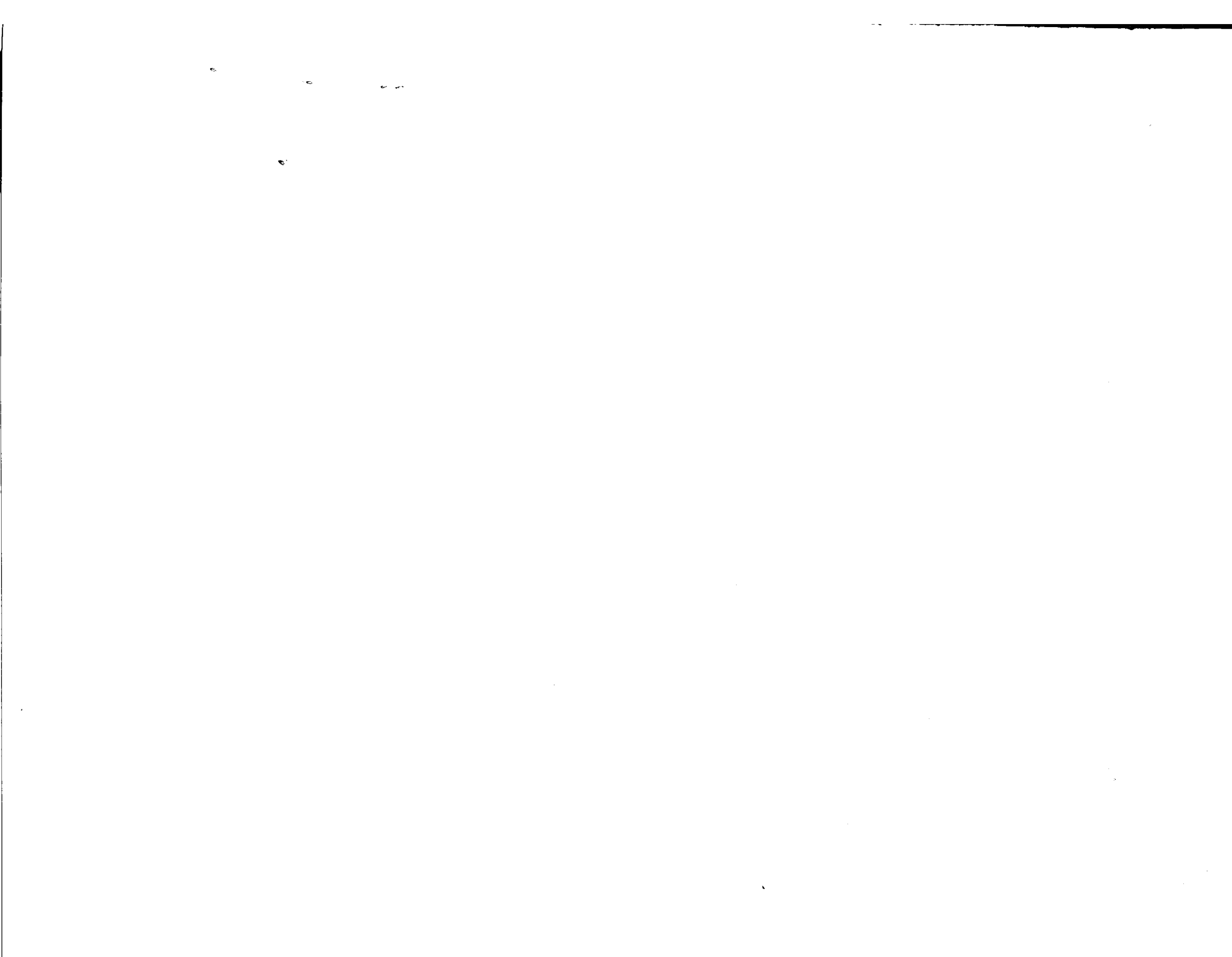

## CHAPTER TWO

# MANNED SPACEFLIGHT

### INTRODUCTION

#### The First Decade Reviewed

When the National Aeronautics and Space Administration was established in October 1958, its managers and engineers were still three years away from putting man into space. Despite the early enthusiasm for lunar colonies and large orbiting space stations, Americans did not explore the moon until 1969. Furthermore, Congress did not approve the funds NASA required for an orbiting laboratory larger than the three-man Skylab, which was launched in 1973. The evolution of spaceflight hardware was necessarily slow and incremental, each spacecraft and mission building on the experiences of its predecessors.

Project Mercury (1961–1963) proved that one man could orbit the earth and return safely in a blunt-shaped vehicle. John J. Glenn, Jr., became the first American to be placed in orbit on February 20, 1962. The next step in NASA's manned space program was Project Gemini (1965–1966). Large enough to accommodate a crew of two, Gemini spacecraft were used to perfect the rendezvous and docking maneuvers that would be required for a mission to the moon. A manned lunar landing by the end of the decade was the ambitious goal given the young agency in 1961 by President John F. Kennedy. It was a feat designed to exhibit the technical prowess of the United States at a time when the USSR was capturing all the "space firsts." The Apollo program (1968–1972) was NASA's largest, most expensive venture—and a highly successful one. An Apollo crew first circled the moon in 1968; the first landing would follow the next year.

#### Manned Spaceflight, 1969–1978

NASA's second decade began with the successful landing of the first Apollo crew on the moon. The *Eagle* touched down on the surface on July 20, 1969, with Neil A. Armstrong and Edwin E. Aldrin, Jr., on board. *Apollo 11* crewman Michael Collins remained in the orbiting command and service module (CSM) while his two mates completed their cursory exploration of the Sea of Tranquility. After 21.5 hours, Armstrong and Aldrin rejoined Collins for the three-day voyage back to

earth. *Apollo 9* (March 1969) and *Apollo 10* (May 1969) had helped pave the way for this historic mission, and six more crews would prepare for flights to the moon.

The crew of the second landing mission, *Apollo 12* (November 1969), spent 31.5 hours on the surface in the vicinity of the Ocean of Storms near the *Surveyor 3* spacecraft. The men devoted more than seven hours to excursions on foot, collecting rock and soil samples, setting up scientific experiments, and photographing this new domain. *Apollo 13* (April 1970) never made it to the moon. An onboard power failure led to mission's failure. On each of the next four flights, *Apollo 14* (January 1971), *Apollo 15* (July 1971), *Apollo 16* (April 1972), and *Apollo 17* (December 1972), the astronauts spent more time on the surface, collected additional samples, explored new regions of the moon, and extended their mobility by means of lunar roving vehicles. Enthusiasm and excitement in Washington over lunar exploration gave way to increased concern over the agency's budget. Even the general public, if not quite bored with it all, was taking "moon shots" in stride. The program ended prematurely in the eyes of some NASA managers and scientists in 1972.

Taking advantage of hardware developed during the Apollo program, the agency's advanced planners in the mid-1960s suggested that an orbiting laboratory could be assembled using components of the Saturn launch vehicle and visited by crews in Apollo spacecraft. The result was Skylab, an orbital workshop constructed from a Saturn IVB stage. It was launched in May 1973 and visited by three crews over the next nine months. The Skylab missions not only contributed to life scientists' understanding of man's ability to adapt to the space environment, but also gave scientists in other disciplines the opportunity to send experiments aloft for extended periods of time.

Another flight project that profitted from Apollo hardware development was the Apollo-Soyuz Test Project (ASTP), the joint U.S.-USSR mission flown in July 1975. After many months of preparation and training, a three-man Apollo crew met two Soviet cosmonauts in orbit above the earth. Apollo and Soyuz spent 44 hours joined in space. Although this project was a technical success, political realities did not allow the engineers, technicians, crews, and managers of the two countries to continue working together.

NASA's post-Apollo plans called for a radical change for manned spaceflight — from small, expendable, cone-shaped spacecraft launched on top of expendable rockets to larger, sleeker, reusable vehicles designed to be launched by their own main engines and reusable solid rocket boosters. The new space Shuttle, part of what NASA labeled the Space Transportation System, would perform a variety of tasks in earth orbit, including delivering, retrieving, and repairing satellites, taking scientific laboratories and experiments to a specific orbit, and ferrying crews and supplies to space stations. Approval to proceed with the development of a shuttle came from the White House in August 1972. Four years later, Rockwell International personnel rolled the first orbiter, *Enterprise*, out the factory doors. Perched atop a modified Boeing 747, *Enterprise* took to the air for the first time in February 1977. These approach and landing tests were completed in July. Rockwell would manufacture the next orbiter as an actual flight vehicle, which would be used in the orbital flight test program scheduled to begin in 1981.

For supporters of manned flight in space, the decade may have been a disappointing one. The promise and excitement of the early Apollo years was replaced by the sober realization that there would be no big-budget high-priority manned program for the remainder of the 1970s. Shuttle had been approved, but its develop-

ment would be slow and methodical. Plans for manned expeditions to Mars and beyond were cast aside in favor of the unmanned exploration of the solar system. Money, not the state of the art or the need to exhibit technical superiority, paced NASA's activities during the second 10 years.

### **Managing the Manned Spaceflight Program**

The Office of Manned Space Flight (OMSF) was first organized in 1961. Along with the Office of Space Science and Applications, the Office of Tracking and Data Acquisition, and the Office of Advanced Research and Technology, OMSF was under the direct control of the NASA administrator. George E. Mueller, associate administrator for manned spaceflight from September 1963 through 1969, and his three deputies built the complex management structure NASA Headquarters required to conduct the Apollo program. In addition to Apollo, OMSF established directorates for advanced missions, Skylab (formerly Apollo applications), a Space Station Task Force (added in May 1969), and a Space Shuttle Task Force (see table 2-1, Phase I). Mueller's team carried the manned program through the first year of the agency's second decade.

Taking over from Mueller in January 1970, Dale D. Myers kept his predecessor's organization intact until 1971, when several changes were made (see table 2-1, Phase II). With the completion of the lunar exploration program, the Apollo program office, under the leadership of Rocco A. Petrone, was dropped in early 1973. The Apollo-Soyuz Test Project was assigned to Chester M. Lee. Advanced missions remained under Phillip E. Culbertson until 1974, when John H. Disher was assigned the task. Skylab operations were overseen by William C. Schneider until July 1974, when Thomas E. Hanes became director. Director Douglas R. Lord saw the Space Station Task Force renamed the Sortie Lab Task Force in 1972 and then the Spacelab Program in 1973. Myron S. Malkin became the first director of the Space Shuttle Program in April 1973. These management changes and those that would follow reflected the transition from experimental to more routine operations in space. Commenting on this subject in 1972, Myers said:

It is important to recognize that we no longer fly space missions just to get men into orbit. In the future, man's role in space will be to perform those tasks that can be done more efficiently manned than automated. He will be there to provide judgment and flexibility to deal with unexpected events. . . . Looking at orbital operations this way, you lose the manned/unmanned distinction and can better concentrate on how to do a total space program in a less expensive manner.<sup>1</sup>

Myers returned to the Rockwell International Corporation in March 1974, and John F. Yardley took OMSF's reins two months later. Yardley would see the program through the remainder of the second decade.

The Office of Manned Space Flight became the Office of Space Flight in February 1976 (see table 2-1, Phase III). Yardley's group was charged with providing the transportation and related services necessary to conduct both manned and unmanned operations in space. Manned activities, however, would be restricted to Shuttle hardware development and tests; Americans faced a six-year hiatus in

manned spaceflight after the Apollo-Soyuz Test Project crew returned from the sortie with the Soviets in 1975. Also coming to the associate administrator's desk from private industry, Yardley recognized the importance of Shuttle:

The whole thrust of our total space program is to take advantage of everything that we have learned, and then take the next step and make space really and truly operational. We have to lower the cost of space activity and join the manned and unmanned efforts. The space Shuttle is the key to this.<sup>2</sup>

Reemphasizing Shuttle's planned role for manned and unmanned spaceflight, NASA renamed Yardley's operation the Office of Space Transportation Systems in 1977.

John Disher continued to oversee advanced programs under Yardley, just as Doug Lord and Myron Malkin stayed on as directors of the Spacelab and Shuttle programs. The Skylab and Apollo-Soyuz Test Project offices were closed after the successful completion of those projects. Chet Lee became the director for Space Transportation Systems operations, an office added in 1975. The major addition to Yardley's organization was the Expendable Launch Vehicle Program, transferred to the Office of Space Transportation Systems in September 1975. Under the direction of Joseph B. Mahon, the traditional launch vehicle program had been managed by the Office of Space Science and Applications since 1961.

The following table (table 2-1) traces the organization of manned spaceflight management at NASA Headquarters during the years 1969-1978. Only the major offices are included and only major changes noted. The three phases represented in the table are composites for each time period. Refer to appendix A and other NASA historical publications for complete organization charts. The reader may also wish to consult volume 2 of the Data Book series, table 2-2, for information on OMSF's organization during NASA's first 10 years.

In addition to overseeing the paperwork in Washington, Mueller, Myers, and Yardley also had management authority over related activities at the Johnson Space Center (formerly the Manned Spacecraft Center), the Marshall Space Flight Center, and the Kennedy Space Center. The Johnson Space Center in Houston was responsible for the Apollo lunar exploration program and the study of the program's returns, astronaut training, mission control, development of the Shuttle orbiter, and other activities related to man's use of space. At the Marshall Space Flight Center in Huntsville, Alabama, the production of the Saturn family of launch vehicles was directed, and the propulsion components that would support Shuttle were being developed and tested. Launches took place from the Kennedy Space Center in Florida.

Table 2-1. Three Phases of Manned Spaceflight Management, NASA Headquarters

Phase I  
1969-1970

Administrator/Deputy Administrator

Associate Administrator, Manned Space Flight (George E. Mueller; Dale D. Myers, Jan. 1970)

Deputy Associate Administrator, Manned Space Flight (Charles W. Mathews)

Executive Secretary, Manned Space Flight Experiments Board (William O. Armstrong; Douglas R. Lord, mid-1969; Abram S. Bass, early 1970)

Director, Manned Space Flight Safety (Jerome F. Lederer); moved to Office of Organization and Management, March 1970

Deputy Associate Administrator, Manned Space Flight (Management) (Frank A. Bogart; Harry H. Gorman, June 1970)

Director, Manned Space Flight Program Control (Jerald R. Kubat; Bogart, acting, June 1969; Charles E. Koenig, Nov. 1969); moved to Office of Institutional Operations, early 1970 (see below)

Director, Manned Space Flight Field Center Development (Robert F. Freitag)

Director, Manned Space Flight Management Operations/Manned Space Flight Institutional Operations (Maynard E. White; Bogart, acting, fall 1969; Gorman, acting, early 1970)

Deputy Associate Administrator, Manned Space Flight (Technical) (Charles J. Donlan)

Director, Space Medicine (James W. Humphreys, Jr.)

Director, NASA Life Sciences (Humphreys); added Dec. 1970

Director, Mission Operations (John D. Stevenson)

Director, Technical and Management Support (James Costantino, acting); added fall 1969

Director, Advanced Manned Missions Program (Donlan, acting; Philip E. Culbertson, Feb. 1970)

Deputy Director, Advanced Manned Missions Program (Lord); dropped early 1970

Director, Program Control (Merle G. Waugh); dropped early 1970

Director, Manned Spacecraft (Robert L. Lohman, acting); dropped early 1970

Director, Systems Engineering (Brian T. Howard; J. W. Timco, late 1970)

Director, Mission Planning and Operations/Program Studies (Jack W. Wild)

Director, Payloads (Armstrong)

Director, Transportation Systems (Daniel Schnyer); dropped early 1970

Director, Supporting Development/Advanced Development (Eldon W. Hall)

Director, Apollo Applications/Skylab Program (William C. Schneider)

Deputy Director, Apollo Applications/Skylab Program (John H. Disher)

Director, Project Integration (Culbertson; Thomas E. Harris, Feb. 1970)

Director, Program Control (J. Pemble Field, Jr.)

Director, Test (Melvyn Savage)

Director, Reliability, Quality, and Safety (Haggai Cohen)

Director, Systems Engineering (Donald R. Hagner)

Director, Operations (John E. Edwards; Wyendell B. Evans, July 1969)

Director, Apollo Program (Samuel C. Phillips; Rocco A. Petrone, Aug. 1969)

Deputy Director, Apollo Program (George H. Hage); dropped Aug. 1969

Director, Engineering (William E. Stoney)

Director, Management (Thomas E. Jenkins; John S. Potate, late 1969)

Director, Missions (Hage; Chester M. Lee, Aug. 1969)

Director, Program Control (James B. Skaggs; Potate, May 1970)

Director, Test (LeRoy E. Day; Charles H. King, Jr., April 1970)

Director, Operations (John K. Holcomb)

Director, Quality and Reliability (George C. White, Jr.)

Table 2-1. Three Phases of Manned Spaceflight Management, NASA Headquarters  
(Continued)

---

Director, Systems Engineering (Robert L. Wagner)  
 Director, Apollo Lunar Exploration (Lee R. Scherer)  
   Deputy Director, Apollo Lunar Exploration (Donald U. Wise); added mid-1969  
   Assistant Director, Automated Spacecraft (Benjamin Milwitky)  
   Assistant Director, Flight Systems Development (William T. O'Bryant)  
   Assistant Director, Lunar Science (R. J. Allenby)  
   Assistant Director, Lunar Sample Program (Verl R. Wilmarth; John Pomeroy, early 1970)  
 Director, Space Station Task Force (Mathews, acting); added May 1969  
   Deputy Director, Space Station Task Force (Lord)  
   Leader, Technical Integration Group (Lohman)  
   Leader, Operations Group (Robert O. Aller)  
   Leader, Experiment Payloads Group (Rodney W. Johnson)  
 Director, Space Shuttle Task Force (Mathews, acting; Donlan, acting, Nov. 1970).  
   Deputy Director, Space Shuttle Task Force (Day)  
   Director, Vehicle Development (William A. Summerfelt)  
   Director, Systems Engineering (Clarence C. Gay, Jr.)  
   Director, Program Development (Joseph M. Clemente, acting; Richard J. Allen, late 1970)

Phase II  
1971-mid-1975

Administrator/Deputy Administrator

Associate Administrator, Manned Space Flight (Myers; Schneider, acting, March 1974; John F. Yardley, May 1974)  
 Deputy Associate Administrator, Manned Space Flight (Mathews; position temporarily dropped, Dec. 1971; Schneider, July 1974)  
   Executive Secretary, Manned Space Flight Experiments Board (Bass); moved to Office of Mission and Payload Integration, late 1973  
 Deputy Associate Administrator, Manned Space Flight (Management) (Gorman); dropped Sept. 1974  
   Director, Resources Management/Administration (James L. Vance)  
   Director, Administration (M. Keith Wible); moved to Office of Resources Management, mid-1975 (see above)  
   Director, Budget and Program Analyses (Gorman, acting, early 1971; Schneider, acting, late 1974)  
 Deputy Associate Administrator, Manned Space Flight (Technical) (Donlan)  
   Director, Engineering and Operations (Robert N. Lindley); dropped late 1972  
   Director, Mission and Payload Integration (Culbertson); added April 1973  
   Director, NASA Life Sciences (Humphreys; Charles A. Berry, Sept. 1971; David Winter, May 1974)  
 Director, Advanced Missions Programs (Culbertson; Disher, March 1974)  
   Deputy Director, Advanced Missions Programs (Freitag); added April 1973  
   Director, Advanced Development (Hall; Freitag, acting, fall 1973; Savage, early 1974)  
   Director, Special Projects (Lester K. Fero); added mid-1973  
   Director, Payload Planning (Armstrong); dropped late 1972  
   Director, Program Studies/Advanced Studies (Wild)  
   Director, Systems Engineering (Timco); dropped late 1972  
 Director, Skylab Program (Schneider; Hanes, July 1974)  
   Deputy Director, Skylab Program (Disher); dropped early 1974  
   Director, Program Budget and Control (Field); dropped early 1974



Table 2-1. Three Phases of Manned Spaceflight Management, NASA Headquarters  
(Continued)

Director, Project Integration (Hanes); dropped early 1974  
 Director, Engineering (Savage); dropped early 1974  
 Director, Operations (Evans; Aller, 1973); dropped early 1974  
 Director, Systems Engineering (Hagner; George M. Anderson); dropped early 1974  
 Director, Apollo Program (Petrone); combined with Apollo-Soyuz Test Project late 1972; dropped early 1973  
 Director, Apollo-Soyuz Test Project (Lee); independent office, Jan. 1973  
 Deputy Director, ASTP (Aller); added March 1974  
 Director, Apollo Missions (Lee); dropped Jan. 1973  
 Director, Apollo/ASTP Program Budget and Control (Potate; John J. Kelly, 1972); moved to Office of Resources Management, mid-1975 (see above)  
 Director, Apollo/ASTP Engineering (Stoney; King, Jan. 1973)  
 Director, Apollo/ASTP Operations (Holcomb)  
 Director, Apollo Lunar Exploration (Scherer; O'Bryant, acting, late 1971); dropped 1973  
 Assistant Director, Flight Systems Development (O'Bryant); dropped 1973  
 Assistant Director, Lunar Science (Allenby); dropped 1973  
 Assistant Director, Lunar Sample Program (Pomeroy); dropped 1973  
 Director, Apollo Systems Engineering (Wagner); dropped 1972  
 Director, Space Station Task Force/Sortie Lab Task Force (Nov. 1972)/Spacelab Program (Oct. 1973) (Lord)  
 Director, Program Integration/Engineering and Operations (Lohman)  
 Director, Program Budget and Control (William J. Hamon; Lord, acting, April 1973; Anthony L. Liccardi, mid-1973); moved to Office of Resources Management, mid-1975 (see above)  
 Leader, Operations Group (Aller); dropped late 1971  
 Leader, Experiment Payloads Group (Johnson); dropped late 1971  
 Director, Concept Verification Test (William E. Miller, Jr.); added 1973  
 Director, Experiment Accommodations (Johnson); added 1973  
 Director, Space Shuttle Program (Donlan, acting; Myron S. Malkin, April 1973)  
 Deputy Director, Space Shuttle Program (Day)  
 Director, Program Budget and Control (Allen); moved to Office of Resources Management, mid-1975 (see above)  
 Director, Vehicle Development/Engineering (Summerfelt; R. L. Wetherington, acting, mid-1974; James T. Rose, fall 1974)  
 Director, Systems Operations (Gay; Day, acting, late 1971; Edward P. Andrews, April 1972)  
 Director, Environmental Effects (James King); added July 1974  
 Director, Payloads (Day, acting); added mid-1971; dropped mid-1973

Phase III  
Fall 1975-1978

Administrator/Deputy Administrator

Associate Administrator, Manned Space Flight/Space Flight (Feb. 1976)/Space Transportation Systems (Nov. 1977) (Yardley)

Deputy Associate Administrator, Manned Space Flight/Space Flight/Space Transportation Systems (Schneider; Glynn S. Lunney, Nov. 1976; Schneider, Aug. 1977; Richard G. Smith, Aug. 1978)

Director, Resources Administration (Vance; C. Ronald Hovell, Jan. 1978)

Deputy Associate Administrator, Manned Space Flight/Space Flight/Space Transportation Systems (Technical) (Donlan; position temporarily dropped, June 1976; Culbertson, Nov. 1977)

Director, Mission and Payload Integration (Culbertson); moved to Office of Planning and Program Integration, Jan. 1976

Table 2-1. Three Phases of Manned Spaceflight Management, NASA Headquarters  
(Continued)

---

Director, Life Sciences (Winter); moved to Office of Space Science, Oct. 1975
Director, Reliability, Quality, and Safety (Cohen)
Deputy Associate Administrator, Manned Space Flight/Space Flight (Operations) (Gerald D. Griffin); dropped May 1976
Director, Advanced Programs (Disher)
Deputy Director, Advanced Programs (Freitag)
Director, Advanced Development (Savage)
Director, Advanced Studies (Wild; Freitag, acting, early 1976); Johnson, late 1976)
Director, Advanced Concepts (Ivan Bekey); added Nov. 1978
Director, Spacelab Program (Lord)
Deputy Director, Spacelab Program (James C. Harrington); added 1976
Director, Experiment Accommodations (Johnson); dropped 1976
Director, Engineering and Operations (Lohman)
Director, Integration and Test (Alfred L. Ryan); added 1976
Director, Space Shuttle Program (Malkin)
Deputy Director, Space Shuttle Program (Day)
Director, Engineering (Rose; L. K. Edwards, 1976; Malkin, acting, early 1978; Sidney C. Jones, Jr., mid-1978)
Director, Systems Operations (E. W. Land)
Director, Space Transportation System Operations (Lee)
Deputy Director, Space Transportation Systems Operations (Aller; Andrews, Sept. 1977)
Director, Mission Analysis and Integration (Armstrong); added Jan. 1976
Director, Systems Engineering and Logistics (C. H. King); added early 1976
Director, Planning and Requirements/Pricing, Launch Agreements, and Customer Service (Jon M. Smith); added early 1976
Director, Flight Operations (Aller, acting); added early 1976; combined with Ground Operations to form Integrated Operations, early 1977 (see below)
Director, Integrated Operations (Edgar L. Harkleroad; added early 1977)
Director, Expendable Launch Vehicles Program (Joseph B. Mahon)
Deputy Director, Expendable Launch Vehicles Program (Aller)
Chief, Program Review and Resource Management (Edward J. Kunec)
Director, Small and Medium Launch Vehicles Program (Joseph E. McGolrick)
Manager, Atlas-Centaur (F. R. Schmidt)
Manager, Titan III (B. C. Lam)
Manager, Delta (Peter Eaton)
Manager, Scout (Paul E. Goozh)
Manager, Atlas F (Jay A. Salmanson)
Director, Interim Upper Stage/Upper Stages (Wild)
Chief, Space Transportation Systems Support Projects (Aller, acting; William D. Goldsby, winter 1978); added mid-1978

---

## BUDGET

For a general introduction to the NASA budget process and to the budget tables in this volume, consult chapter 1. Other data that may assist the researcher interested in the cost of NASA's manned spaceflight program include budget tables in chapter 1 for Saturn IB, Saturn V, and the Space Transportation System solid rocket boosters. Chapter 6 provides budget data on the manned flight tracking network. For a more detailed breakdown on the flight project budgets, see the NASA annual budget estimates referred to in chapter 1. Review the bottom notes of all tables carefully before making conclusions about totals for any particular project or year.

### Money for Manned Spaceflight

As did NASA's overall budget, the manned spaceflight budget declined almost yearly from FY 1969 through FY 1974, when it dropped below \$1 billion for the first time since FY 1962 (see table 2-2). Apollo, NASA's largest budget item for many years, saw funding for the last time in FY 1973.

Totals for any one program are hard to define, but NASA issued the following figures for its major manned ventures: Mercury, \$392.6 million; Gemini, \$1.283 billion; and Apollo, \$25 billion (\$21.35 billion through the first lunar landing in July 1969). The grand total for the "expendable-generation" manned spaceflight program came to \$29.5 billion, with \$2.6 billion for Skylab and \$250 million for the Apollo-Soyuz Test Project.<sup>3</sup> These totals include expenditures for facilities, salaries, research and development, operations, and hardware (spacecraft and launch vehicles). The following tables are concerned with only research and development monies: spacecraft, launch vehicle costs, operations, and supporting development.

In addition to Apollo, Skylab, and the Apollo-Soyuz Test Project, the space Shuttle program was a major item in the manned spaceflight budget. Funds for Shuttle studies were first programmed in FY 1970. After presidential approval of the reusable Space Transportation System was granted in 1972, the budget requests for Shuttle increased steadily, almost doubling the previous year's request each year, FY 1973 through 1976. Funds for hardware production for the orbiter and the main engine were first programmed in FY 1977-1978.

When the Office of Manned Space Flight was renamed the Office of Space Flight in the fall of 1975, the newly organized office assumed management of "expendable launch vehicles," a budget category associated with the Office of Space Science and Applications since 1961. Table 2-35 summarizes the expendable launch vehicle funding history from the FY 1977 request only; for data on FY 1969-1976 consult chapter 1.

Table 2-2. Total Manned Spaceflight Funding History  
(in thousands of dollars)<sup>a</sup>

Year	Request	Authorization	Programmed
1969	2 483 400	2 280 700	2 177 500
1970	1 919 227 <sup>b</sup>	1 919 227	2 029 967
1971	1 474 200	1 561 200	1 422 469
1972	1 286 475	1 320 475	1 285 475
1973	1 224 400	1 224 400	1 135 775
1974	1 032 000 <sup>c</sup>	1 032 000	999 900
1975	1 124 800	1 119 800	1 235 800 <sup>d</sup>
1976	1 791 200 <sup>e</sup>	1 411 100 <sup>f</sup>	1 560 574
1977	1 644 700 <sup>d</sup>	1 642 200	1 763 700
1978	1 753 500	1 756 500	1 751 500

<sup>a</sup>The Office of Manned Space Flight was renamed the Office of Space Flight during FY 1977 and the Office of Space Transportation Systems during FY 1979.

<sup>b</sup>\$117 473 000 of the request was reserved from apportionment pursuant to the Expenditure Control Act of 1968; the original request was for \$1 890 227 000.

<sup>c</sup>The original request was for \$1 057 000 000; final budget submission was reduced to \$1 032 000 000; the remaining \$25 000 000 was supplied by FY 1973 funds.

<sup>d</sup>Includes funds for expendable launch vehicles, an item previously funded by the Office of Space Science and Applications.

<sup>e</sup>Includes \$376 600 000 for the transition quarter.

<sup>f</sup>Authorization figures do not include transition quarter funds.

Table 2-3. Programmed Costs of Manned Spaceflight Programs  
(in thousands of dollars)

Program	1969	1970	1971	1972	1973	1974	1975	1976	1977	1978
Spaceflight operations	150 000	343 100	507 300	582 775	879 000	523 400	298 800	188 674	199 200	267 800
Space transportation system	-----	-----	-----	100 000	198 575	475 000	797 500	1 206 000	1 412 100	1 349 200
Apollo lunar exploration	2 025 000	1 684 367	913 669	601 200	56 700	-----	-----	-----	-----	-----
Advanced missions	2500	2500	1500	1500	1500	1500	16 000	12 074	12 000	10 000
Expendable launch vehicles	-----	-----	-----	-----	-----	-----	139 500	165 900	151 400	134 500

Table 2-4. Spaceflight Operations Funding History  
(in thousands of dollars)

Year	Request	Authorization	Programmed
1969	439 600 <sup>a</sup>	253 200 <sup>a</sup>	150 000
1970	225 627 <sup>b</sup>	225 627 <sup>b</sup>	343 100
1971	515 200 <sup>c</sup>	565 200 <sup>c</sup>	507 300
1972	672 775 <sup>d</sup>	702 775 <sup>d</sup>	582 775
1973	1 094 200 <sup>d</sup>	1 094 200 <sup>d</sup>	879 000
1974	555 500 <sup>e</sup>	555 500 <sup>e</sup>	523 400
1975	323 300	313 300	298 800
1976	262 200 <sup>f</sup>	203 100 <sup>g</sup>	188 674
1977	205 200	202 700	199 200
1978	267 800	267 800	267 800

<sup>a</sup>For Apollo applications (Skylab); the spaceflight operations category was established in FY 1970.

<sup>b</sup>The original request was for \$236 627 000; an additional \$117 473 000 from FY 1969 funds were applied to the request and authorization. See table 2-24 for spaceflight operations—space station. \$46 000 000 was added to the amended budget submission and authorization for Saturn V production.

<sup>c</sup>See table 2-24 for spaceflight operations—Space Shuttle and station.

<sup>d</sup>See table 2-23 for spaceflight operations—Space Shuttle.

<sup>e</sup>The original request was for \$580 500 000; an additional \$25 000 000 from FY 1973 funds were applied to the request and authorization.

<sup>f</sup>Includes \$55 100 000 for the transition quarter.

<sup>g</sup>Authorization figures do not include transition quarter funds.

Table 2-5. Spaceflight Operations—Skylab Funding History  
(in thousands of dollars)

Year	Request	Authorization	Programmed
1969	439 600 <sup>a</sup>	253 200 <sup>a</sup>	150 000
1970	251 800 <sup>b</sup>	251 800	324 600
1971	364 300	364 300	405 200
1972	535 400	550 400	538 500
1973	540 500	540 500	502 000
1974	233 800	233 800	176 700

<sup>a</sup>For Apollo applications.

<sup>b</sup>The original request for Apollo applications was \$308 800 000.

Table 2-6. Spaceflight Operations—Skylab—Experiments Funding History  
(in thousands of dollars)

Year	Request	Authorization	Programmed
1969	190 300 <sup>a</sup>	--- <sup>b</sup>	97 355
1970	141 400	---	243 120
1971	306 900	---	58 565
1972	---	---	49 742
1973	23 400	--- <sup>b</sup>	--- <sup>c</sup>
1974	18 400	--- <sup>b</sup>	--- <sup>d</sup>

<sup>a</sup>For Apollo applications.

<sup>b</sup>Authorization figures were not broken down to include this category.

<sup>c</sup>It was estimated in the FY 1974 budget estimate that \$35 800 000 would be programmed in FY 1973.

<sup>d</sup>The Skylab budget was not broken down by categories in the FY 1975 budget estimate; the total programmed was \$176 700 000.

Table 2-7. Spaceflight Operations—Skylab—Mission and Program Support  
Funding History  
(in thousands of dollars)

Year	Request	Authorization	Programmed
1969	48 000 <sup>a</sup>	--- <sup>b</sup>	---
1970	---	---	---
1971	---	---	15 050
1972	---	---	31 823
1973	31 000	--- <sup>b</sup>	--- <sup>c</sup>
1974	13 400	--- <sup>b</sup>	--- <sup>d</sup>

<sup>a</sup>For Apollo applications.

<sup>b</sup>Authorization figures were not broken down to include this category.

<sup>c</sup>It was estimated in the FY 1974 budget estimate that \$39 300 000 would be programmed in FY 1973.

<sup>d</sup>The Skylab budget was not broken down by categories in the FY 1975 budget estimate; the total programmed was \$176 700 000.

Table 2-8. Spaceflight Operations—Skylab—Space Vehicles Funding History  
(in thousands of dollars)

Year	Request	Authorization	Programmed
1969	201 300 <sup>a</sup>	--- <sup>b</sup>	52 645
1970	110 400	---	63 330
1971	89 600	---	67 699
1972	194 000	---	136 388
1973	309 100	--- <sup>b</sup>	--- <sup>c</sup>
1974	146 300	--- <sup>b</sup>	--- <sup>d</sup>

<sup>a</sup>For Apollo applications.

<sup>b</sup>Authorization figures were not broken down to include this category.

<sup>c</sup>It was estimated in the FY 1974 budget estimate that \$228 800 000 would be programmed in FY 1973.

<sup>d</sup>The Skylab budget was not broken by categories in the FY 1975 budget estimate; the total programmed was \$176 700 000.

Table 2-9. Spaceflight Operations—Skylab—Workshop Cluster Funding History  
(in thousands of dollars)

Year	Request	Authorization	Programmed
1971	---	---	223 566
1972	---	---	278 401
1973	154 200	--- <sup>b</sup>	--- <sup>b</sup>
1974	45 700	--- <sup>a</sup>	--- <sup>c</sup>

<sup>a</sup>Authorization figures were not broken down to include this category.

<sup>b</sup>It was estimated in the FY 1974 budget estimate that \$174 600 000 would be programmed in FY 1973.

<sup>c</sup>The Skylab budget was not broken down by categories in the FY 1975 budget estimate; the total programmed was \$176 700 000.

Table 2-10. Spaceflight Operations—Skylab—Payload Integration Funding History  
(in thousands of dollars)

Year	Request	Authorization	Programmed
1971	---	---	27 803
1972	---	---	32 591
1973	22 800	--- <sup>a</sup>	--- <sup>b</sup>
1974	10 000	--- <sup>a</sup>	--- <sup>c</sup>

<sup>a</sup>Authorization figures were not broken down to include this category.

<sup>b</sup>It was estimated in the FY 1974 budget estimate that \$23 500 000 would be programmed in FY 1973.

<sup>c</sup>The Skylab budget was not broken down by categories in the FY 1975 budget estimate; the total programmed was \$176 700 000.

Table 2-11. Spaceflight Operations—Skylab—Operations Funding History  
(in thousands of dollars)

Year	Request	Authorization	Programmed
1970	---	---	18 150
1971	---	---	12 517
1972	34 500	---	9 555
1973	--- <sup>a</sup>	---	---

<sup>a</sup>As of FY 1973, Skylab operations were included in spaceflight operations—operations; see table 2-18.

Table 2-12. Spaceflight Operations—Apollo Soyuz Test Project Funding History  
(in thousands of dollars)

Year	Request	Authorization	Programmed
1972	---	---	6 900
1973	---	---	38 500
1974	90 000	90 000	90 000
1975	114 600	109 600	109 600

Table 2-13. Spaceflight Operations—Apollo Soyuz Test Project—  
Command and Service Module Funding History  
(in thousands of dollars)

Year	Request	Authorization	Programmed
1972	---	---	2900
1973	---	---	12 600
1974	28 300	--- <sup>a</sup>	18 300
1975	8 000	--- <sup>a</sup>	--- <sup>b</sup>

<sup>a</sup>Authorization figures were not broken down to include this category.

<sup>b</sup>It was estimated in the FY 1976 budget estimate that \$6 000 000 would be programmed in FY 1975.

Table 2-14. Spaceflight Operations—Apollo Soyuz Test Project—Docking Module and Docking System Funding History  
(in thousands of dollars)

Year	Request	Authorization	Programmed
1972	---	---	3800
1973	---	---	21 000
1974	25 700	--- <sup>a</sup>	16 000
1975	3400	--- <sup>a</sup>	--- <sup>b</sup>

<sup>a</sup>Authorization figures were not broken down to include this category.

<sup>b</sup>It was estimated in the FY 1976 budget estimate that \$4 400 000 would be programmed in FY 1975.

Table 2-15. Spaceflight Operations—Apollo Soyuz Test Project—Operations and Flight Support Funding History  
(in thousands of dollars)

Year	Request	Authorization	Programmed
1972	---	---	200
1973	---	---	4900
1974	21 900	--- <sup>a</sup>	30 700
1975	65 700	--- <sup>a</sup>	--- <sup>b</sup>
1976			
1977			
1978			

<sup>a</sup>Authorization figures were not broken down to include this category.

<sup>b</sup>It was estimated in the FY 1976 budget estimate that \$62 700 000 would be programmed in FY 1975.

Table 2-16. Spaceflight Operations—Apollo Soyuz Test Project—Experiments Funding History  
(in thousands of dollars)

Year	Request	Authorization	Programmed
1974	4600	--- <sup>a</sup>	12 000
1975	5000	--- <sup>a</sup>	--- <sup>b</sup>

<sup>a</sup>Authorization figures were not broken down to include this category.

<sup>b</sup>It was estimated in the FY 1976 budget estimate that \$4 000 000 would be programmed in FY 1975.



Table 2-17. Spaceflight Operations—Apollo Soyuz Test Project—  
Launch Vehicle Funding History  
(in thousands of dollars)

Year	Request	Authorization	Programmed
1974	9500	--- <sup>a</sup>	13 000
1975	32 500	--- <sup>a</sup>	--- <sup>b</sup>

<sup>a</sup>Authorization figures were not broken down to include this category.

<sup>b</sup>It was estimated in the FY 1976 budget estimate that \$32 500 000 would be programmed in FY 1975.

Table 2-18. Spaceflight Operations—Development, Test, and  
Mission Operations Funding History  
(in thousands of dollars)

Year	Request	Authorization	Programmed
1970	36 300 <sup>a</sup>	36 300 <sup>a</sup>	--- <sup>b</sup>
1971	40 900 <sup>a</sup>	40 900 <sup>a</sup>	--- <sup>c</sup>
1972	--- <sup>c</sup>	--- <sup>c</sup>	--- <sup>c</sup>
1973	305 200 <sup>d</sup>	305 200	294 000
1974	220 200	220 200	220 200
1975	175 200	170 200	170 200
1976	209 300 <sup>e</sup>	161 100 <sup>f</sup>	161 100
1977	169 900	--- <sup>g</sup>	166 900
1978	173 000	173 000	171 900

<sup>a</sup>For spaceflight operations—operations.

<sup>b</sup>It was estimated in the FY 1971 budget estimate that \$24 548 000 would be programmed for FY 1970.

<sup>c</sup>Funded in FY 1971–1972 by the Apollo program; see table 2-31.

<sup>d</sup>Development, test, and mission operations funds were distributed among the following categories: research and test operations, crew and flight operations, operations support, launch systems operations, and data systems. For budget data, consult the yearly budget estimates.

<sup>e</sup>Includes \$43 200 000 for the transition quarter.

<sup>f</sup>Authorization figures do not include transition quarter funds.

<sup>g</sup>A total of \$2 500 000 was subtracted from the authorization for development, test, and mission operations and space transportation system operations capability development.

Table 2-19. Spaceflight Operations—Mission Systems and Integration Funding History  
(in thousands of dollars)

Year	Request	Authorization	Programmed
1970	---	---	6000 <sup>a</sup>
1971	---	---	23 600 <sup>a</sup>
1972	37 375 <sup>a</sup>	37 375 <sup>a</sup>	17 600 <sup>b</sup>
1973	23 000 <sup>a</sup>	23 000 <sup>a</sup>	21 000 <sup>c</sup>
1974	15 500 <sup>d</sup>	15 500 <sup>d</sup>	15 500 <sup>d</sup>
1975	15 500 <sup>c</sup>	15 500 <sup>c</sup>	3000 <sup>f</sup>
1976	28 400 <sup>g</sup>	23 000 <sup>h</sup>	11 300 <sup>i</sup>
1977	17 300 <sup>j</sup>	--- <sup>k</sup>	16 800 <sup>l</sup>
1978	63 000 <sup>m</sup>	61 000	65 400 <sup>n</sup>

<sup>a</sup>For spaceflight operations—orbital systems and experiments/payloads.

<sup>b</sup>Includes \$7 100 000 for space station studies.

<sup>c</sup>Includes \$6 000 000 for spacelab concept verification testing.

<sup>d</sup>Includes \$2 500 000 for spacelab concept verification testing.

<sup>e</sup>Includes \$2 500 000 for spacelab concept verification testing, and \$1 500 000 for space tug studies.

<sup>f</sup>In FY 1977, this category was renamed spaceflight operations—space transportation system operations capability development. The total programmed for FY 1975 included \$2 000 000 for spacelab studies and \$1 000 000 for Shuttle interim upper stage studies.

<sup>g</sup>Includes \$6 400 000 for the transition quarter; the total includes \$6 100 000 (plus \$1 900 000 for the transition quarter) for spacelab concept verification testing and \$3 400 000 (plus \$700 000 for the transition quarter) for Shuttle interim upper stage/space tug studies.

<sup>h</sup>Authorization figures do not include transition quarter funds.

<sup>i</sup>Includes \$6 100 000 for spacelab studies and \$2 625 000 for space transportation system upper stage studies.

<sup>j</sup>Includes \$10 500 000 for spacelab studies and \$3 800 000 for space transportation system upper stage studies.

<sup>k</sup>A total of \$2 500 000 was subtracted from the authorization for space transportation system operations capability development, and development, test, and mission operations.

<sup>l</sup>Includes \$8 600 000 for spacelab studies and \$1 800 000 for space transportation system upper stage studies.

<sup>m</sup>Includes \$24 500 000 for spacelab studies and \$13 500 000 for space transportation system upper stage studies.

<sup>n</sup>Includes \$21 600 000 for spacelab studies and \$8 400 000 for space transportation system upper stage studies.

Table 2-20. Spaceflight Operations—Space Life Sciences Funding History  
(in thousands of dollars)<sup>a</sup>

Year	Request	Authorization	Programmed
1972	---	---	19 775
1973	25 500	25 500	23 500
1974	21 000	21 000	21 000
1975	18 000	18 000	---
1976	24 500 <sup>b</sup>	19 000 <sup>c</sup>	---

<sup>a</sup>In FY 1972, most of the life sciences activities of the agency were transferred from the Office of Space Science to the Office of Manned Space Flight. In FY 1977, the life sciences program was moved back to OSS. See tables 3-35 through 3-43 for further data on funding.

<sup>b</sup>Includes \$5 500 000 for the transition quarter.

<sup>c</sup>Authorization figures do not include transition quarter funds.

Table 2-21. Spaceflight Operations—Planning and Program Integration Funding History  
(in thousands of dollars)

Year	Request	Authorization	Programmed
1976	---	---	4200
1977	---	---	3500
1978	4000	4000	4000

Table 2-22. Spaceflight Operations—Space Transportation System Operations  
Funding History  
(in thousands of dollars)

Year	Request	Authorization	Programmed
1978	17 800	17 800	16 500

Table 2-23. Space Shuttle Funding History  
(in thousands of dollars)<sup>a</sup>

Year	Request	Authorization	Programmed
1970	9000 <sup>b</sup>	9000 <sup>b</sup>	12 500
1971	110 000 <sup>c</sup>	160 000	78 500
1972	100 000	115 000	100 000
1973	200 000	200 000	198 575
1974	475 000	475 000	475 000
1975	800 000	805 000	797 500
1976	1 527 000	1 206 000	1 206 000
1977	1 288 100	1 288 100	1 413 100
1978	1 349 200	1 354 200	1 349 200

<sup>a</sup>Shuttle was funded as part of the spaceflight operations program through FY 1973.

<sup>b</sup>For a space station only.

<sup>c</sup>For Shuttle and station; \$6 000 000 requested for station definition.

Table 2-24. Space Shuttle—Orbiter Design and Development Funding History  
(in thousands of dollars)

Year	Request	Authorization	Programmed
1970	---	---	8300
1971	22 500 <sup>a</sup>	---	--- <sup>b</sup>
1972	42 000 <sup>c</sup>	---	15 000
1973	90 000	--- <sup>d</sup>	139 480
1974	377 100	377 100	363 125
1975	647 500	647 500	634 757
1976	1 108 200 <sup>e</sup>	877 300 <sup>f</sup>	867 335
1977	842 500	842 500	899 400 <sup>g</sup>
1978	690 500	695 500	813 060 <sup>g</sup>

<sup>a</sup>For airframe development.

<sup>b</sup>\$47 000 000 was programmed for vehicle definition.

<sup>c</sup>For vehicle definition.

<sup>d</sup>Authorization figures were not broken down to include this category.

<sup>e</sup>Includes \$230 900 000 for the transition quarter.

<sup>f</sup>Authorization figures do not include transition quarter funds.

<sup>g</sup>See also table 2-29 for orbiter production.

Table 2-25. Space Shuttle—Main Engine Design and Development Funding History  
(in thousands of dollars)

Year	Request	Authorization	Programmed
1970	---	---	4200
1971	48 500	---	--- <sup>a</sup>
1972	58 000	---	45 100
1973	50 000	--- <sup>b</sup>	40 543
1974	55 500	55 500	82 307
1975	92 300	97 300	95 300
1976	171 500 <sup>c</sup>	135 500 <sup>d</sup>	140 800
1977	193 800	193 800	182 200 <sup>e</sup>
1978	219 900	219 900	197 400 <sup>e</sup>

<sup>a</sup>\$20 900 000 was programmed for engine definition.

<sup>b</sup>Authorization figures were not broken down to include this category.

<sup>c</sup>Includes \$36 000 000 for the transition quarter.

<sup>d</sup>Authorization figures do not include transition quarter funds.

<sup>e</sup>See also table 2-29 for main engine production.

Table 2-26. Space Shuttle—Solid Rocket Booster Design and Development Funding History  
(in thousands of dollars)

Year	Request	Authorization	Programmed
1973	40 000 <sup>a</sup>	--- <sup>b</sup>	--- <sup>c</sup>
1974	18 100	18 100	8567
1975	22 600	22 600	21 143
1976	94 200 <sup>d</sup>	76 200	82 240
1977	82 600	82 600	100 400
1978	80 000	83 600	104 998

<sup>a</sup>For definition studies and configuration selection, initiation of detailed design, and start of booster engine or rocket motor development.

<sup>b</sup>Authorization figures were not broken down to include this category.

<sup>c</sup>It was estimated in the FY 1973 budget estimate that \$1 700 000 would be programmed in FY 1972; see also note a above.

<sup>d</sup>Includes \$18 000 000 for the transition quarter.

<sup>e</sup>Authorization figures do not include transition quarter funds.

Table 2-27. Space Shuttle—External Tank Design and Development Funding History  
(in thousands of dollars)

Year	Request	Authorization	Programmed
1974	24 300	24 300	18 100
1975	26 000	26 000	34 000
1976	81 200 <sup>a</sup>	66 100 <sup>b</sup>	65 700
1977	64 000	64 000	84 000
1978	83 600	80 000	88 030

<sup>a</sup>Includes \$15 100 000 for the transition quarter.

<sup>b</sup>Authorization figures do not include transition quarter funds.

Table 2-28. Space Shuttle—Launch and Landing Funding History  
(in thousands of dollars)

Year	Request	Authorization	Programmed
1974	---	---	2901
1975	11 600	11 600	12 300
1976	71 900 <sup>a</sup>	50 900 <sup>b</sup>	49 925
1977	105 200	105 200	77 100
1978	133 500	133 500	104 012

<sup>a</sup>Includes \$21 000 000 for the transition quarter.

<sup>b</sup>Authorization figures do not include transition quarter funds.

Table 2-29. Space Shuttle—Other Categories Funding History  
(in thousands of dollars)

Year	Request	Authorization	Programmed
1971	33 000 <sup>a</sup>	---	78 500 <sup>b</sup>
1972	---	---	39 900 <sup>c</sup>
1973	20 000 <sup>d</sup>	--- <sup>e</sup>	18 552 <sup>d</sup>
1974	---	---	---
1975	---	---	---
1976	---	---	---
1977	---	---	70 000 <sup>f</sup>
1978	141 700 <sup>g</sup>	141 700 <sup>g</sup>	41 700 <sup>h</sup>

<sup>a</sup>Includes \$12 000 000 for experiments definition and \$21 000 000 for Shuttle-station preliminary design verification.

<sup>b</sup>Includes \$10 600 000 for technology and related development; \$20 900 000 for engine definition; and \$47 000 000 for vehicle definition.

<sup>c</sup>Includes \$26 100 000 for technology and related development; and \$13 800 000 for vehicle and engine definition.

<sup>d</sup>For technology and related development.

<sup>e</sup>Authorization figures were not broken down to include this category.

<sup>f</sup>For production: \$65 000 000 for the orbiter; and \$5 000 000 for the main engine.

<sup>g</sup>For production.

<sup>h</sup>For production: \$29 140 000 for the orbiter; and \$12 560 000 for the main engine.

Table 2-30. Apollo Funding History  
(in thousands of dollars)

Year	Request	Authorization	Programmed
1969	2 038 800	2 025 000	2 025 000
1970	1 691 100 <sup>a</sup>	1 691 100	1 684 367
1971	956 500	994 500	913 669
1972	612 200	612 200	601 200
1973	128 700	128 700	56 700

<sup>a</sup>The initial request was for \$1 651 100 000.

Table 2-31. Apollo—Spacecraft Funding History  
(in thousands of dollars)

Year	Request	Authorization	Programmed
1969	820 100 <sup>a</sup>	---- <sup>b</sup>	913 127 <sup>c</sup>
1970	653 800 <sup>d</sup>	653 800	775 608 <sup>e</sup>
1971	402 500 <sup>f</sup>	440 500	398 147
1972	164 152	164 152	120 006
1973	79 500	79 500	---- <sup>g</sup>

<sup>a</sup>Includes \$340 200 000 for the command and service module (CSM) and \$278 200 000 for the lunar module (LM).

<sup>b</sup>Authorization figures were not broken down to include this category.

<sup>c</sup>Includes \$356 902 000 for the CSM and \$299 240 000 for the LM.

<sup>d</sup>Includes \$217 900 000 for the CSM and \$270 900 000 for the LM.

<sup>e</sup>It was estimated in the FY 1971 budget estimate that \$282 821 000 would be programmed for the CSM and \$231 433 000 for the LM in FY 1970.

<sup>f</sup>Includes \$95 500 000 for the CSM and \$102 900 000 for the LM. The FY 1972-1973 budget estimates do not break down the spacecraft category.

<sup>g</sup>It was estimated in the FY 1974 budget estimate that \$50 400 000 would be programmed in FY 1973.

Table 2-32. Apollo—Saturn Launch Vehicles Funding History  
(in thousands of dollars)

Year	Request	Authorization	Programmed
1969	887 300	---- <sup>b</sup>	577 986
1970	496 700	496 700	486 691
1971	231 000	231 000	189 059
1972	186 003	186 003	157 996
1973	49 200	49 200	---- <sup>c</sup>

<sup>a</sup>For more data on Saturn launch vehicle budgets, see tables 1-13 through 1-14.

<sup>b</sup>Authorization figures were not broken down to include this category.

<sup>c</sup>It was estimated in the FY 1974 budget estimate that \$26 300 000 would be programmed in FY 1973.

Table 2-33. Apollo—Mission Support/Operations Funding History  
(in thousands of dollars)

Year	Request	Authorization	Programmed
1969	331 400	---- <sup>a</sup>	533 887
1970	540 600 <sup>b</sup>	540 600 <sup>c</sup>	422 068
1971	323 000	323 000	326 463 <sup>d</sup>
1972	262 045	262 045	323 198 <sup>e</sup>
1973	---- <sup>f</sup>	---	---

<sup>a</sup>Authorization figures were not broken down to include this category.

<sup>b</sup>Includes \$90 000 000 for lunar exploration; the original request was for \$11 000 000.

<sup>c</sup>Includes \$90 000 000 for lunar exploration.

<sup>d</sup>Includes \$11 500 000 for advanced development.

<sup>e</sup>Includes \$12 872 000 for advanced development.

<sup>f</sup>Funded under space flight operations.

Table 2-34. Advanced Missions/Programs Funding History  
(in thousands of dollars)

Year	Request	Authorization	Programmed
1969	5000	2500	2500
1970	2500	2500	2500
1971	2500	1500	1500
1972	1500	5500	1500
1973	1500	1500	1500
1974	1500	1500	1500
1975	1500	1500	16 000 <sup>a</sup>
1976	2000 <sup>b</sup>	2000 <sup>c</sup>	12 074
1977	18 000 <sup>d</sup>	18 500	12 000
1978	10 000	12 000	10 000

<sup>a</sup>In FY 1977, this category became part of space flight operations; the total programmed includes \$11 000 000 for advanced systems and \$5 000 000 for payload integration and mission analysis.

<sup>b</sup>Includes \$500 000 for the transition quarter.

<sup>c</sup>Authorization figures do not include transition quarter funds; the original request for \$1 500 000 was increased to \$2 000 000 by the conference committee on June 4, 1975.

<sup>d</sup>Includes \$13 000 000 for advanced systems and \$5 000 000 for payload integration and mission analysis.

Table 2-35. Expendable Launch Vehicles Funding History  
(in thousands of dollars)<sup>a</sup>

Year	Request	Authorization	Programmed
1975	---	---	139 500
1976	---	---	165 900
1977	151 400	151 400	151 400
1978	136 500	134 500	134 500

<sup>a</sup>See chapter 1 for funding data for FY 1969-1977. Expendable launch vehicles were procured with Office of Space Science and Applications funds prior to FY 1977.

## MISSION CHARACTERISTICS

This section of the chapter is divided into four parts, each addressing a major manned spaceflight program for which there were missions flown or major hardware developed: Apollo, Skylab, the Apollo-Soyuz Test Project, and the Space Transportation System.

### Apollo Spacecraft and Lunar Exploration

The close of NASA's first decade is associated by many with photographs taken by *Apollo 8* (December 1968) astronauts of the blue earth rising over the moon's horizon. For the first time, man saw earth from the vicinity of its natural satellite.

Seven months later, two members of an Apollo crew began to explore the lunar surface on foot.

The Apollo lunar expeditions built upon the hardware and mission experiences of Mercury, Gemini, and Apollo earth-orbital flights. From one astronaut to two, to three; from suborbital, to orbital, to cislunar, NASA engineers, scientists, and crews gained confidence in and expertise with hardware and mission operations (see table 2-36 for a chronology of development and operations, 1969-1973).

*Apollo 9* (March 1969), launched by Saturn V, which would send crews to the moon, demonstrated in earth orbit the feasibility of lunar orbit rendezvous and command and service module-lunar module (CSM-LM) docking in a 10-day mission (see table 2-37). *Apollo 10* (May 1969) was the last rehearsal before the actual lunar landing, during which the lunar module's performance was evaluated in cislunar and lunar environments. It was found satisfactory during the 8-day flight (see table 2-38). All systems were ready for the first manned lunar landing.

*Apollo 11*, with Commander Neil A. Armstrong, Command Module Pilot Michael Collins, and Lunar Module Pilot Edwin E. Aldrin aboard, was launched from the Kennedy Space Center's Launch Complex 39A the morning of July 16, 1969. After 1.5 orbits, the spacecraft was sent into a lunar trajectory by the launch vehicle's S-IVB stage, with CSM-LM docking taking place shortly thereafter. After a three-day cruise, the crew reached the vicinity of the moon on the 19th and went into lunar orbit (see figs. 2-3 and 2-4). The commander and the lunar module pilot made their way safely to the moon's surface on board *Eagle*, the name they had given their lunar module, on the afternoon of the 20th. Neil Armstrong took the first step on the lunar surface at 9:56 p.m., July 20. The mission's primary objective, of course, was the landing, but the crew also came prepared to conduct a series of scientific experiments, including the gathering of soil and rock samples (see table 2-46 for a complete list of lunar mission experiments) and to photograph the extraterrestrial scenery. This first crew of lunar explorers spent only 21.5 hours on the moon, all the time the mission planners had scheduled for this first cursory look at earth's satellite. The ascent stage of the lunar module lifted off the surface on the 21st and mated with the orbiting command and service module. After jettisoning the LM, *Apollo 11* began its journey back home, splashing down in the Pacific Ocean on July 24 (see table 2-39).

The *Apollo 11* astronauts left behind them a plaque on the leg of the LM's descent module that read: "Here Man from the planet Earth first set foot upon the Moon, July 1969 A.D. We came in peace for all mankind." The crew brought back to earth 21 kilograms of lunar surface material for analysis, still and television images of this new world, data on the moon's composition and activity, and a decided sense of accomplishment.

There were five more Apollo lunar landing missions, each lasting longer than the previous mission, each carrying increasingly complex scientific experiments. In November 1969, *Apollo 12*'s lunar module, *Intrepid*, landed near *Surveyor 3*, an unmanned lunar lander launched by NASA in 1967. The crew performed a selenological inspection, survey and sampling and deployed the first Apollo Lunar Surface Experiments Package (ALSEP), a portable unit containing the hardware for six experiments (see fig. 2-5 and table 2-40).\*

---

\* The number and type of experiments varied with each mission.



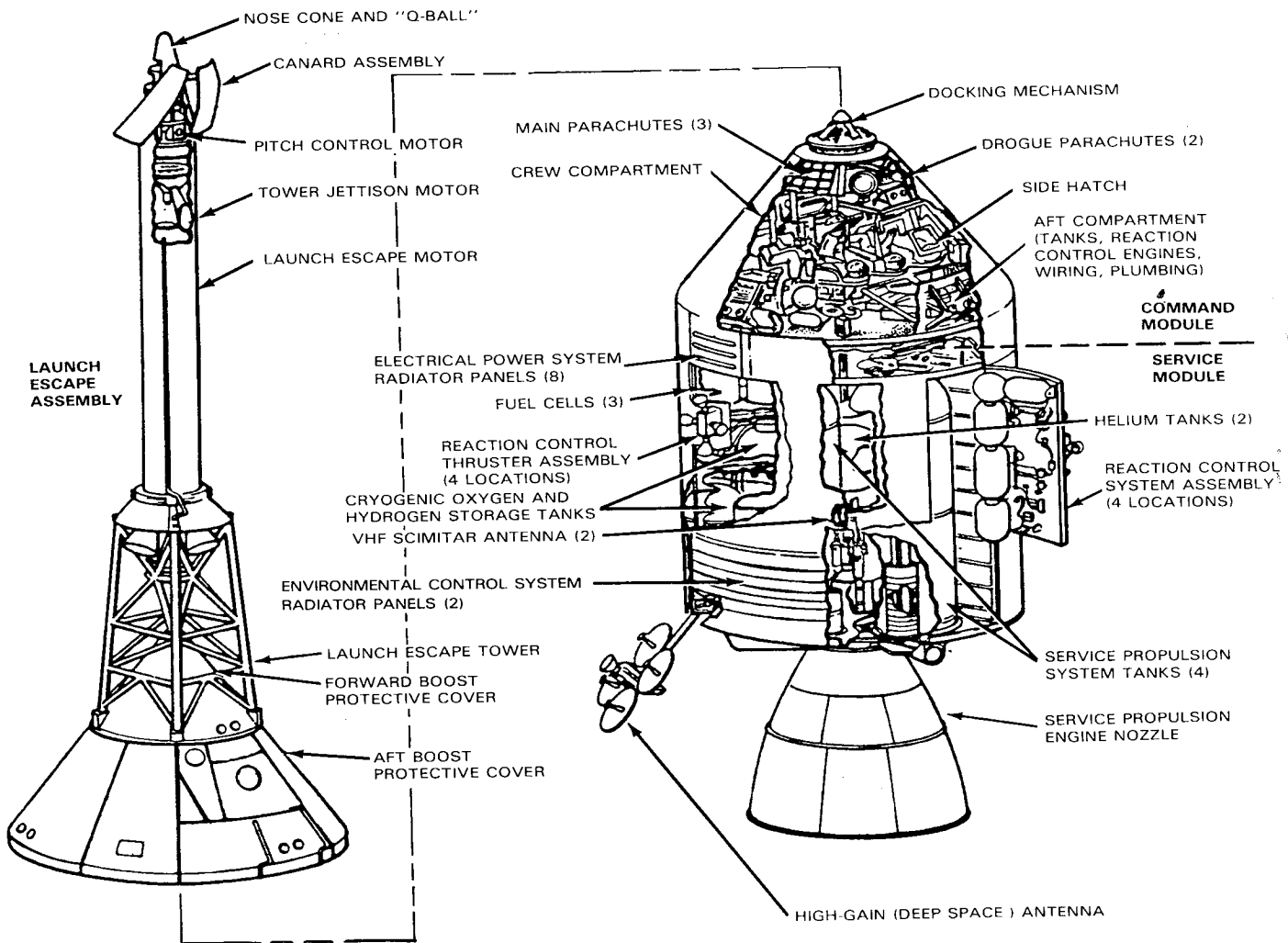

Figure 2-1. Apollo Spacecraft. The launch escape system (left), which consisted of three solid-propellant motors, was designed to propel the command module to safety in the event of an aborted launch. If it were not required, the 10.06-meter-tall LES was jettisoned shortly after launch. The joined command and service modules are shown on the left. The command module (3.63 meters long), equipped with couches, served as the crew compartment and control center, and could accommodate all three astronauts. A forward docking ring and hatch allowed the spacecraft to dock with the lunar module, which was stowed in the spacecraft LM adapter during launch aft of the service module. The command module was capable of attitude control about three axes by using its 10 reaction control engines and some lateral lift translation in the atmosphere. Made from aluminum by Rockwell International, the Apollo spacecraft prime contractor, the command module had two hatches and five windows. Thermal protection during reentry was provided by ablative shields of varying thicknesses. The service module (6.88 meters long) provided the primary propulsion and maneuvering capability of the spacecraft. Most of the consumables (oxygen, hydrogen, propellant) were also stored in this module. Prior to reentry, the crew jettisoned the service module. (See volume 2, tables 2-54 and 2-55, for information on major spacecraft subsystems and spacecraft characteristics.)

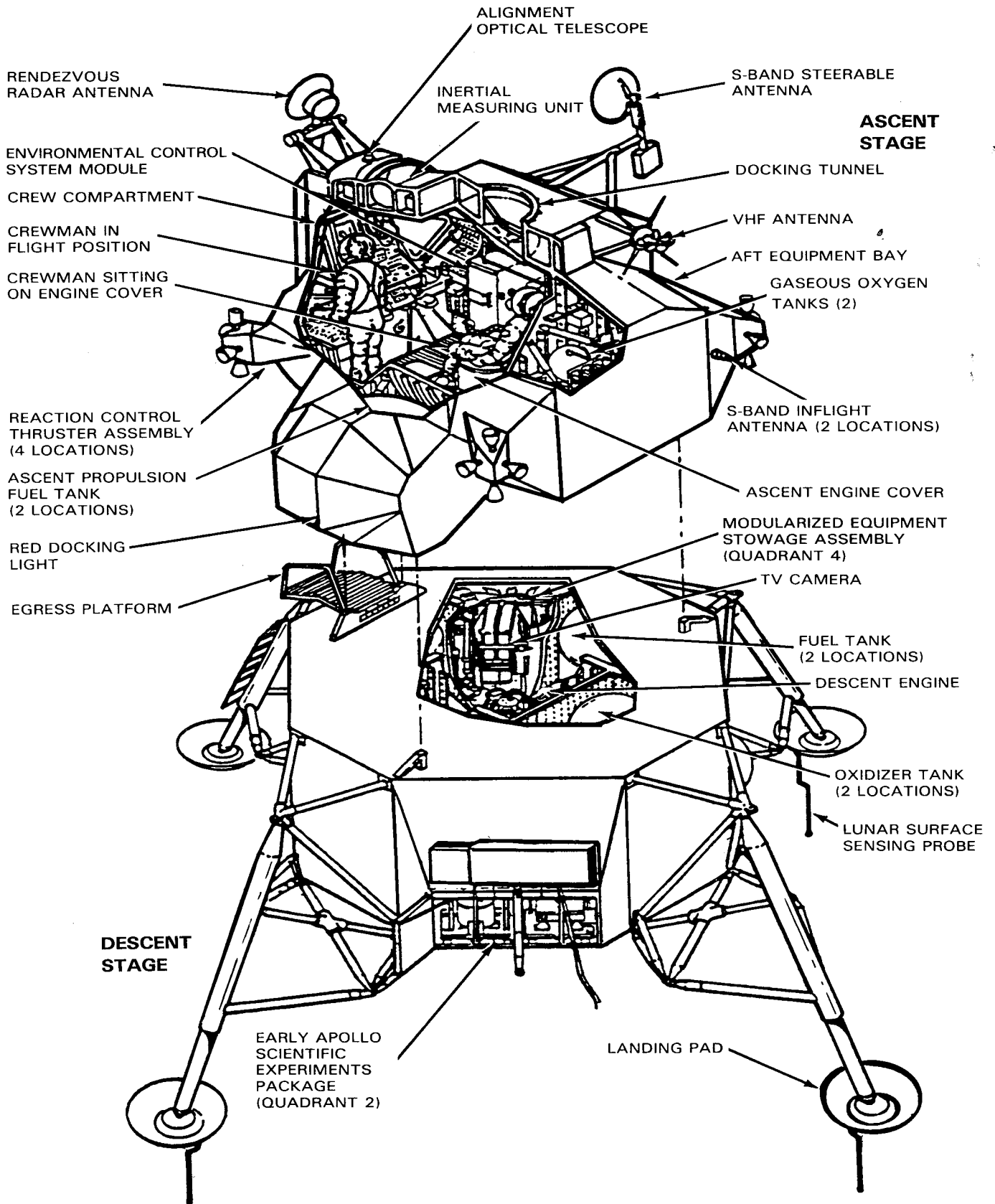

Figure 2-2. Apollo Lunar Module. The designers of the Apollo lunar module (LM) could ignore the requirements for aerodynamic streamlining demanded by vehicles that flew in or returned through

Source: JSC, "Apollo Program Summary Report," JSC-09423, Apr. 1975, p. 4-58.

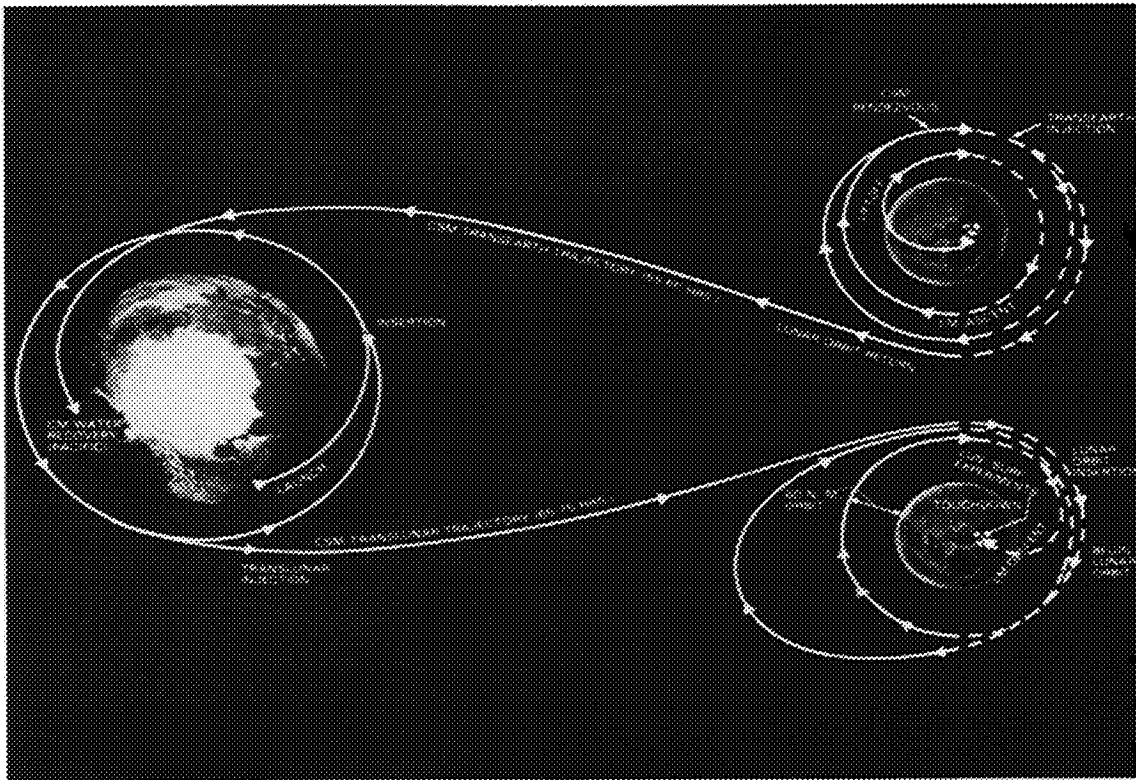
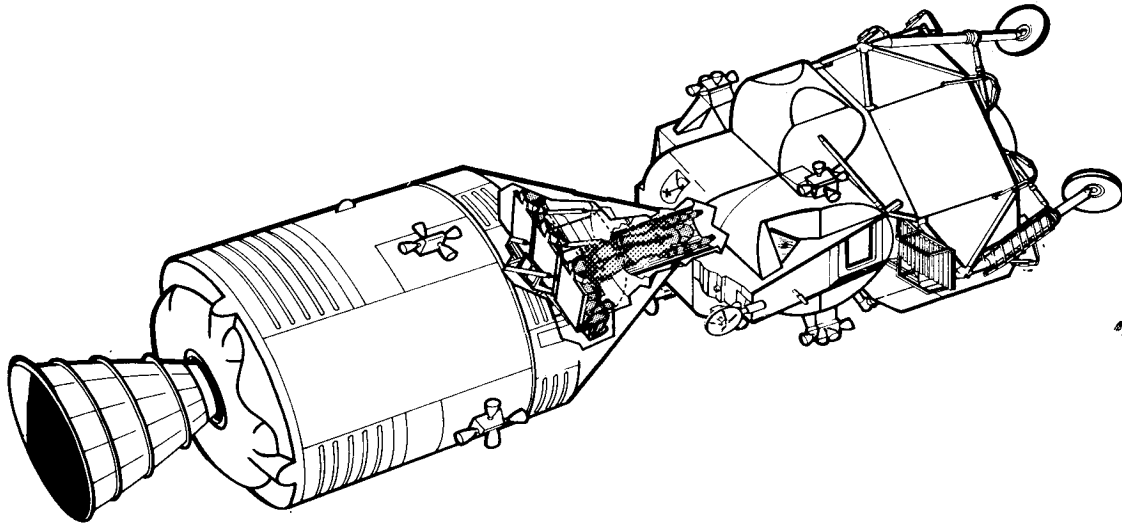

Figure 2-3. Typical Apollo Lunar Landing Flight Profile

earth's atmosphere. This ungainly looking vehicle operated only in space. The two-stage spacecraft, carried to the vicinity of the moon docked to the Apollo command module, was designed to land two Apollo astronauts on the moon's surface. From lunar orbit, where it was released by the Apollo command and service module (CSM), the LM's descent and ascent stages functioned as one spacecraft. During their time on the surface, the crew lived in the LM's ascent stage. When it was time to return to the waiting CSM, the descent stage provided a launch platform for the ascent half of the lunar module.

It took more than two years to design the LM, with its makers, led by Grumman Aircraft Engineering Corporation, fighting weight gain long after a configuration was approved. The most troublesome, critical, and heavy of the LM's components were its 18 engines—descent propulsion (43 900 newtons); ascent propulsion (15 500 newtons); and 16 small attitude control engines clustered in quads around the ascent stage. Propellant for these engines accounted for more than 70 percent of the spacecraft's total weight of 1500 kilograms.

The ascent stage was basically cylindrical (4.29-meter diameter, 3.75-meter height), but with angular faces. Its aluminum skin was encased by a mylar thermal-micrometeorite shield. The cruciform structure of the descent stage supported the descent engine and its 4 fuel tanks. Four legs (maximum diameter 9.45 meters), the struts of which were filled with crushable aluminum honeycomb for absorbing the shock of landing, were capped by footpads. The descent stage (3.23 meters high) was also constructed of aluminum alloy. A ladder attached to one of the legs gave the crew access to the surface. A docking tunnel (0.81-meter diameter) was provided for crew transfer between the command module and the LM ascent stage. After the surface operations were completed and the crew returned via the ascent stage to the CSM, the LM was jettisoned. A LM was included on a manned Apollo mission for the first time in March 1969 (Apollo 9). For more information on spacecraft systems, see volume 2, table 2-55.



*Figure 2-4. After the S-IVB stage had placed the Apollo spacecraft on its proper trajectory to the moon, the Apollo command and service module-lunar module adapter panels blossomed outward. The CSM separated from the launch vehicle stage, puled away, turned around, docked with the lunar module, and then pulled the LM away from the S-IVB. In this docked configuration, the spacecraft made its way to the moon.*

Source: Rockwell International, "The Apollo Program," 1968, p. 121.

The next Apollo mission, in April 1970, was the only one that failed to reach its objective. After only 56 hours, *Apollo 13's* mission was aborted when the crew was forced to leave the CSM and depend on the LM for emergency life support. A short was indicated in the current from one of the fuel cells on the service module, which was supplying power to cryogenic oxygen tank fans. Within seconds, there were two other electrical shorts on the spacecraft. The shorts ignited the wire insulation, which caused temperature and pressure increases within the oxygen tank; a tank line in the vacuum jacket burst and caused the blow-out plug on the vacuum jacket to burst. The pressure in the service module bay rose rapidly. The crew reported their problem to mission control in Houston and began to power down the CSM. Using the LM descent engine, the Apollo astronauts placed their spacecraft on a free-return trajectory to earth and spent the remainder of the return journey in the modified LM. When the service module was jettisoned a few hours before splashdown, the crew observed that the outer skin on the affected bay was badly damaged and that a large portion was missing. An hour before reentry into the earth's atmosphere, the lunar module life boat was abandoned, and the crew settled into the command module for the final stage of the flight. While *Apollo 13* failed to land on the moon or accomplish any of its scientific tasks, the mission proved that the crew and support teams at mission control could work together to solve unanticipated problems (see table 2-41).

*Apollo 14* through *17* were accomplished without critical anomalies. *Apollo 14*, with redesigned cryogenic oxygen tanks in the service module, made its way to the moon in January 1971 for a lunar surface stay of 33 hours (see table 2-42). The crew had a Mobile Equipment Transporter (MET), a two-wheeled cart, to help them

carry their gear on the lunar surface. In July 1971, *Apollo 15's* crew took its turn, extending the stay to nearly 67 hours. Astronauts David R. Scott and James B. Irwin also extended the range of lunar area explored by using a Lunar Roving Vehicle (LRV), a four-wheeled, battery-powered buggy that could accommodate two astronauts and 127 kilograms of equipment. To further enhance the scientific capabilities of *Apollo 15*, a Scientific Instrument Module (SIM) with a door that

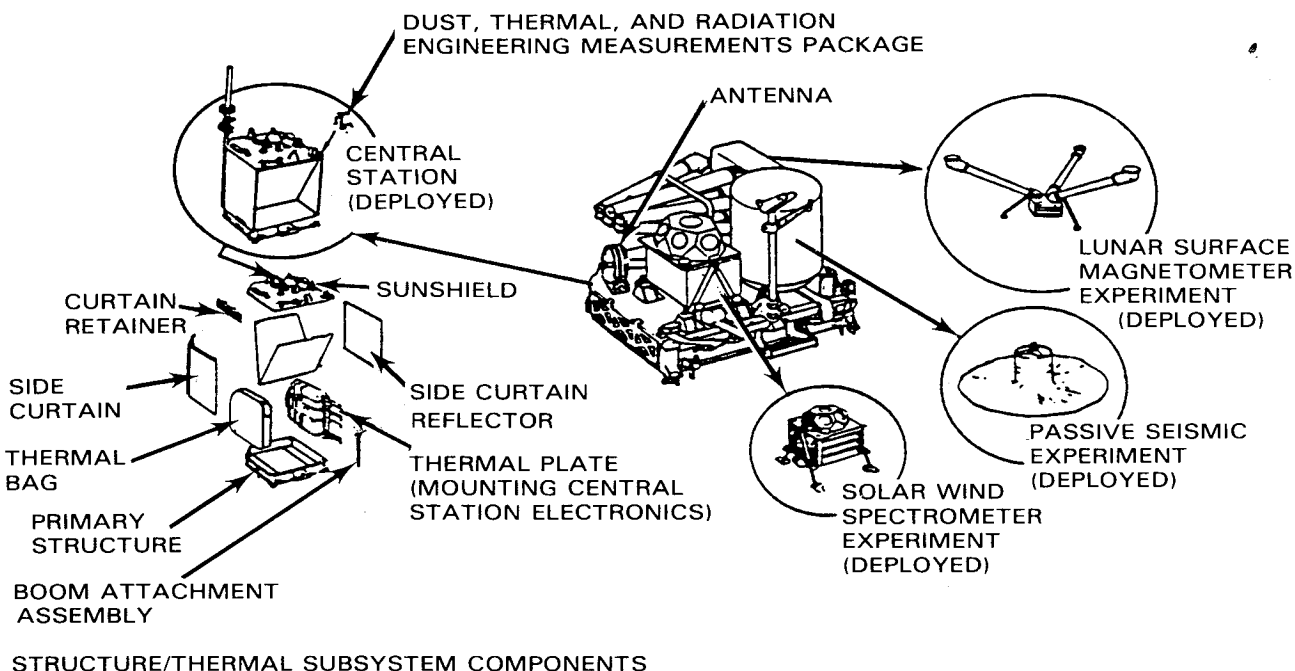

(A) SUBPACKAGE 1

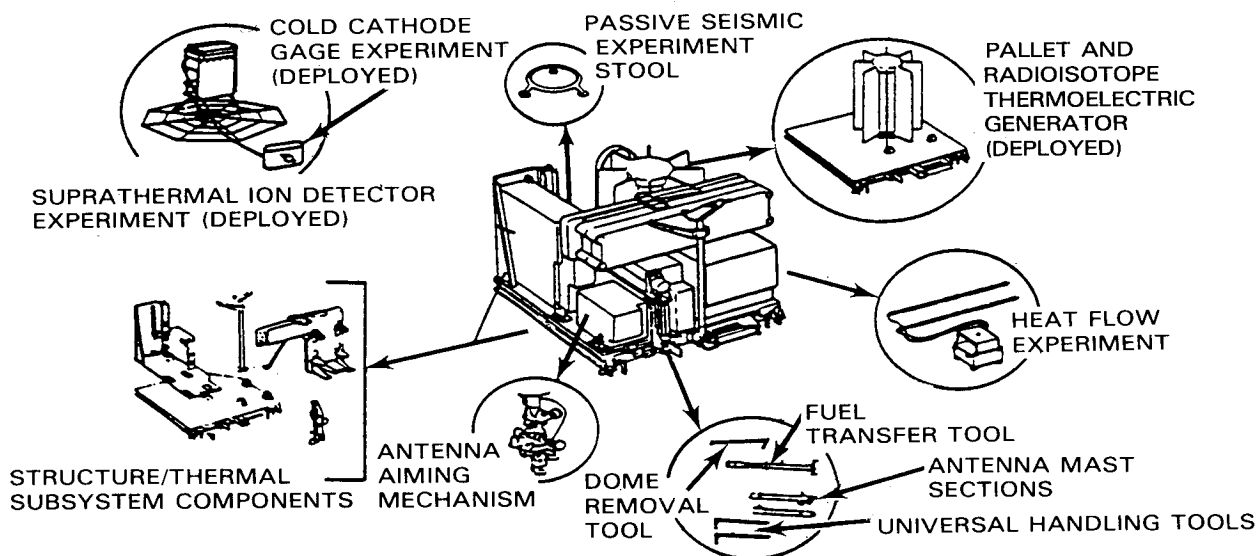

(B) SUBPACKAGE 2

Figure 2-5. Apollo 15 Lunar Surface Experiments Package

Source: JSC, "Apollo Program Summary Report," JSC-09423, Apr. 1975, p. 3-39.

could be jettisoned was added to the service module. Housed in the SIM bay were several cameras, spectrometers, and a particles and field subsatellite, which was launched into lunar orbit before the spacecraft left the vicinity of the moon (see table 2-43). *Apollo 16's* commander and LM pilot reached the moon in April 1972. As had two crews before them, they drilled into the lunar core to retrieve samples and conducted a variety of tasks associated with scientific investigations. With the assistance of their LRV, the astronauts gathered 95 kilograms of samples in a 27-kilometer tour. A subsatellite carried in the Apollo SIM bay was not inserted into the correct orbit and impacted on the surface the next month (see table 2-44). The crew of *Apollo 17*, the last of the Apollo explorers, reached the moon in December 1972 with scientist-astronaut Harrison H. Schmitt and commander Eugene A. Cernan taking to the surface. On this last mission, the crew stayed longer, gathered more samples, performed more experiments, and traversed the greatest distance on the surface than any of the other Apollo crews (see table 2-45).

These seven lunar missions, of which six were successful, represented the final phase of the Apollo program. There were a total of 33 Apollo missions, 11 of which were manned. The unmanned flights qualified the launch vehicle and the two spacecraft—the CMS and the LM—for manned flight. Four of the manned flights conducted before *Apollo 11* man-rated the vehicle for lunar exploration. During Apollo there were no major launch vehicle failures of the Saturn IB or Saturn V and only one spacecraft failure that prevented the completion of a proposed mission.<sup>4</sup> The tables that follow describe in detail the seven Apollo lunar missions.

**Astronauts.** All of the Apollo astronauts who flew missions during NASA's second decade were selected during the agency's first 10 years. Six major astronaut groups were chosen, starting with the original seven Mercury astronauts and ending with two groups of scientist-astronauts, many of whom were civilians (see volume 2 for more information on the astronauts chosen in 1958-1967). A seventh group was transferred to NASA from the Department of Defense when the military's Manned Orbiting Laboratory (MOL) program was cancelled in 1969.\* Until 1978, only these 73 men had been allowed to join the astronaut corps. But in 1978, 35 more astronaut candidates were approved to expand the ranks for the coming Shuttle flights.\*\*

The selection criteria by which NASA chose its astronauts changed constantly. For the newest group of astronauts picked in 1978, the criteria differed for two categories: mission specialists and pilots. Mission specialists were required only to have a bachelor's degree in engineering, physical or biological science, or

---

\* The astronauts transferred from the MOL program were Maj. Karol J. Bobko, USAF; Lt. Comdr. Robert L. Crippen, USN; Maj. Charles G. Fullerton, USAF; Maj. Henry W. Hartsfield, USAF; Maj. Robert F. Overmyer, USMC; Maj. Donald H. Peterson, USAF; and Lt. Comdr. Richard H. Truly, USN.

\*\* The 35 candidates chosen in 1978 were Maj. Guion S. Bluford, USAF; Lt. Comdr. Daniel C. Brandenstein, USN; Capt. James F. Buchli, USMC; Lt. Comdr. Michael L. Coats, USN; Maj. Richard O. Covey, USAF; Lt. Comdr. John O. Creighton, USN; Maj. John M. Fabian, USAF; Anna L. Fisher; Lt. Dale A. Gardner, USN; Lt. Robert L. Gibson, USN; Maj. Frederick D. Gregory, USAF; Stanley D. Griggs; Terry J. Hart; Comdr. Frederick H. Hauck, USN; Steven A. Hawley; Jeffrey A. Hoffman; Shannon W. Lucid; Lt. Comdr. Jon A. McBride, USN; Ronald E. McNair; Capt. Richard M. Mullane, USAF; Capt. Steven R. Nagel, USAF; George D. Nelson; Capt. Ellison S. Onizuka, USAF; Judith A. Resnik; Sally K. Ride; Maj. Francis R. Scobee, USAF; Margaret R. Seddon; Capt. Brewster H. Shaw, Jr., USAF; Capt. Loren J. Shriver, USAF; Maj. Robert L. Stewart, USA; Kathryn D. Sullivan; Norman E. Thagard; James D. A. van Hoften; Lt. Comdr. David M. Walker, USN; and Lt. Comdr. Donald E. Williams, USN.

mathematics and to meet physical standards that were more relaxed than those required of pilot-astronauts. Pilots were required to have a bachelor's degree in engineering, physical science, or mathematics and 1000 hours of first-pilot time and they had to pass a Class I physical. In this first group of Shuttle astronaut candidates were the first female and minority personnel to be admitted to the corps. Ten of the candidates were never in the military, and 25 of them held graduate degrees.

Of special interest is the career of astronaut Donald "Deke" K. Slayton, who was one of the original seven Mercury astronauts chosen in 1958. He was assigned to pilot Mercury-Atlas 7 but removed from the active list because a flight surgeon detected a heart murmur during one of Slayton's routine physical examinations. He resigned his Air Force commission in 1963 but continued as an active member of the astronaut team as director of flight crew operations. In 1972, Slayton was returned to flight status and took the role of docking module pilot during the Apollo-Soyuz Test Project in 1975.<sup>5</sup>

Table 2-36. Chronology of Apollo Development and Operations, 1969-1973\*

Date	Event
Jan. 19-22, 1969	The Apollo 9 flight readiness test was completed successfully.
Feb. 3, 1969	In a published schedule of proposed launches, NASA Headquarters announced that there would be five Apollo flights in 1969: one manned earth-orbital, one manned lunar-orbital, and three manned lunar landings.
Mar. 3-13, 1969	<i>Apollo 9</i> was launched successfully at 11:00 a.m. (all times EST) on Mar. 3. Four days later in earth orbit, the crew performed command and service module-lunar module (CSM-LM) separation maneuvers. On the 13th, the command module (CM) splashed down in the Atlantic Ocean at 12:01 p.m. James A. McDivitt, David R. Scott, and Russell L. Schweikart made up the crew.
Mar. 24, 1969	It was announced that the Apollo 10 crew would take the LM from lunar orbit to within 15 240 meters of the surface to test the LM further in preparation for the first manned landing.
Mar. 25, 1969	The first flight model of the Apollo Lunar Science Experiments Package (ALSEP) arrived at the Kennedy Space Center (KSC).
Apr. 7, 1969	A Lunar Roving Vehicle Task Team was established at the Marshall Space Flight Center (MSFC) to coordinate that center's lunar rover development activities; the team's name was changed to Lunar Mobility Task Team on Aug. 18.
Apr. 7-11, 1969	The Apollo 10 flight readiness test was completed successfully.
May 18-26, 1969	<i>Apollo 10</i> was launched successfully at 12:49 p.m. (all times EDT) on May 18 and was placed in a lunar trajectory. On the 21st, the spacecraft was inserted into lunar orbit. The next day the crew performed the required LM low-level descent exercises, the CSM and the LM being separated for eight hours. Splashdown in the Pacific occurred at 12:52 p.m. on the 26th. Thomas P. Stafford, John W. Young, and Eugene A. Cernan made up the crew.
May 27, 1969	MSFC was authorized to proceed with the development of a lunar roving vehicle.
June 11, 1969	It was stated by Samuel C. Phillips, director of the Apollo Program at NASA Headquarters, that missions had been approved through Apollo 20.
July 16-24, 1969	<i>Apollo 11</i> was launched successfully at 9:22 a.m. (all times EDT) on July 16. Three days later the spacecraft entered lunar orbit. On the 20th, Astronauts Neil A. Armstrong and Edwin E. Aldrin, Jr., took the LM to the surface, leaving Michael Collins in the CSM. Armstrong became the first man to set foot on the moon at 10:56 p.m. After 21 + hours on the surface, the LM ascent stage returned to the orbiting CSM. Splashdown took place in the Pacific on the 24th at 12:15 p.m.

Table 2-36. Chronology of Apollo Development and Operations, 1969-1973\* (Continued)

Date	Event
Oct. 28, 1969	NASA awarded a contract to the Boeing Co. for the development and production of a lunar roving vehicle. MSFC would manage the project.
Nov. 14-24, 1969	<i>Apollo 12</i> was launched on Nov. 14 at 11:22 a.m. (all times EST). Lightning struck the vehicle twice within a minute of liftoff without inflicting damage. On the 17th, the crew inserted their spacecraft into lunar orbit. Two days later, Astronauts Charles Conrad and Alan L. Bean took the LM to the surface for a 31 + -hour visit. They returned to the waiting CSM piloted by Richard F. Gordon on the 20th. Splashdown took place on the 24th in the Pacific at 3:58 p.m.
Jan. 4, 1970	Because of budget cuts, NASA cancelled its plans for an Apollo 20 mission and stretched out the scheduling for the remaining 7 missions to 6-month intervals.
Feb. 6, 1970	NASA Headquarters and the field centers reached an agreement concerning the requirements for a lunar roving vehicle.
Apr. 11-17, 1970	<i>Apollo 13</i> was launched successfully on Apr. 11 at 2:13 p.m. (all times EST). On the 13th during their translunar coast, the crew reported that they were experiencing loss of oxygen and primary power in the service module, which demanded that the mission be aborted. Astronauts James A. Lovell, Jr., John L. Swigert, Jr., and Fred W. Haise, Jr., adapted the LM to serve as their living quarters for the return trip to earth. On Apr. 17 at 1:07 p.m., the CM splashed down in the Pacific. That same day an Apollo 13 Review Board was established to investigate the hardware failures.
June 15, 1970	The Apollo 13 Review Board delivered its final report.
Sept. 2, 1970	NASA officials announced that budget cuts had forced them to cancel the original Apollo 15 and 19 missions; the remaining flights were designated Apollo 14 through 17.
Jan. 31-Feb. 9, 1971	Astronauts Alan B. Shepard, Jr., Stuart A. Roosa, and Edgar D. Mitchell aboard <i>Apollo 14</i> were launched successfully on their way to the moon on Jan. 31 at 4:03 p.m. (all times EST). On Feb. 4, the spacecraft was put into lunar orbit, from which Shepard and Mitchell left in the LM on the 5th for the surface. They returned to the CSM on the 6th. The crew splashed down in the Pacific three days later at 4:05 p.m.
Apr. 1, 1971	The first lunar roving vehicle, to be included on Apollo 15, was delivered to KSC.
July 26-Aug. 7, 1971	<i>Apollo 15</i> was launched with David R. Scott, Alfred M. Worden, and James B. Irwin aboard on July 26 at 9:34 a.m. (all times EDT). Lunar orbit was achieved on the 29th, with Scott and Irwin reaching the surface the next day. On Aug. 2, the crew returned to the CSM. Splashdown in the Pacific was on Aug. 7 at 4:47 p.m.
Apr. 16-27, 1972	Astronauts John W. Young, Thomas K. Mattingly II, and Charles M. Duke, Jr., were launched on their way to the moon on <i>Apollo 16</i> on Apr. 16 at 12:54 p.m. EST. Three days later the crew attained lunar orbit, with landing taking place on the 20th. Young and Duke left the surface on April 23. Splashdown in the Pacific was at 2:44 p.m. on the 27th.
Dec. 7-19, 1972	<i>Apollo 17</i> , the last Apollo manned lunar mission, was launched at 12:33 a.m. (all times EST) on Dec. 7. Astronauts Eugene A. Cernan, Ronald E. Evans, and Harrison H. Schmitt reached lunar orbit on the 10th. The next day Cernan and Schmitt landed on the moon's surface for three days of activities. Splashdown in the Pacific was at 2:25 p.m. on the 19th.
Mar. 15, 1973	At NASA Headquarters within the Office of Space Science, a Lunar Programs Office was established, under which the Lunar Data Analysis and Synthesis Program would be conducted.

\*For a chronology of pre-1969 events, see table 2-50, vol. 2.



Table 2-37. *Apollo 9* Characteristics

---

Date of launch (ETR launch complex #): March 3, 1969 (39A)  
 Official mission designation: AS-504  
 Spacecraft designation (name): SM-104  
     CM-104 (Gumdrop)  
     LM-3 (Spider)  
 Launch vehicle designation (class): SA-504 (Saturn V)  
 Spacecraft weight (kg): 43 196  
 Spacecraft shape, dimensions (m): Command module: truncated cone  
     length, 3.63  
     diameter of base, 3.9  
     Service module: cylindrical with extended engine nozzle  
     length, 6.88  
     diameter, 3.9  
     Lunar module, ascent stage: roughly cylindrical with angular faces  
     height, 3.75  
     diameter, 4.29  
     Lunar module, descent stage: cruciform platform supported by 4 legs  
     height, 3.23  
     width from opposite legs, 9.45

Crew: James A. McDivitt, Commander; David R. Scott, CM pilot; Russell L. Schweikart, LM pilot  
 Backup crew: Charles Conrad, Jr, Commander; Alan L. Bean, CM pilot; Richard F. Gordon, LM pilot  
 Apogee/perigee at insertion (km): 189.5 × 192.4  
 No. of earth orbits: 151  
 Period: approx. 90 min.  
 Length of mission: 241:00:54 (10 + days)  
 Mission events (date, time, ground elapsed time):

launch	March 3	11:00:00 a.m. EST	00:00:00
S-IC engine cutoff		11:02:43	00:02:43
S-II engine cutoff		11:08:56	00:08:56
earth orbit insertion		11:11:15	00:11:15
CSM/LM docking		2:01:59 p.m.	03:01:59
CSM-S-IVB separation		3:08:06	04:08:06
LM descent propulsion system burn	March 5	12:41:35 p.m.	49:41:35
CSM-LM separation	March 7	8:02:54 a.m.	93:02:54
LM ascent propulsion system burn		11:58:15	96:58:15
CSM-LM docking		2:02:26 p.m.	99:02:26
CM-SM separation	March 13	11:36:04 a.m.	240:36:04
splashdown		12:00:54 p.m.	241:00:54

EVA time: 00:37:00 (Schweickart)  
 Earth landing coordinates: 67°56'W, 23°15'N (Atlantic O.)  
 Recovery ship: *USS Guadalcanal* (crew onboard in 49 min.)  
 Mission objectives: Demonstrate crew-space vehicle-mission support facilities performance during a manned Saturn V mission with the CSM and LM in earth orbit; demonstrate LM-crew performance; demonstrate performance of nominal and selected backup lunar orbit rendezvous mission activities; CSM-LM consumables assessment.  
 Results: All objectives were achieved; first active docking of the LM and CSM. The LM's ascent and descent propulsion systems checked out satisfactorily. Launch was originally set for Feb. 28, but all crew members were suffering from a mild virus respiratory illness, and the mission was rescheduled.

---

Reference: NASA Hq., "Apollo 9 Post-launch Mission Operation Report," M-932, 69-09, May 6, 1969.

Table 2-38. *Apollo 10* Characteristics

---

Date of launch (ETR launch complex #): May 18, 1969 (39B)

Official mission designation: AS-505

Spacecraft designation (Name): SM-106

CM-106 (Charlie Brown)

LM-4 (Snoopy)

Launch vehicle designation (class): SA-505 (Saturn V)

Spacecraft weight (kg): 44 576

Spacecraft shape, dimensions (m): see table 2-37

Crew: Thomas P. Stafford, Commander; John W. Young, CM pilot; Eugene A. Cernan, LM pilot

Backup crew: L. Gordon Cooper, Commander; Donn F. Eisele, CM pilot; Edgar D. Mitchell, LM pilot

Apogee/perigee at insertion (km): 190 × 184.5

No. of earth orbits: 1.5

Period: approx. 90 min.

Lunar orbit parameters (km): 111.1 × 316.7 at insertion; 111.1 × 111.1, circularized

No. of lunar orbits: 31

Length of mission: 192:03:23 (8+ days)

Mission events (date, time, ground elapsed time):

launch	May 18	11:49:00 a.m. EST	00:00:00
S-IC engine cutoff		11:51:42	00:02:42
S-II engine cutoff		11:58:13	00:09:13
earth orbit insertion		12:00:54 p.m.	00:11:54
translunar injection		2:28:21	02:39:21
CSM-S-IVB separation		2:51:42	03:02:42
CSM-LM docking		3:06:37	03:17:37
lunar orbit insertion	May 21	3:44:54 p.m.	75:55:54
separation maneuver	May 22	2:36:17 p.m.	98:47:17
transearth injection	May 24	5:25:29 a.m.	137:36:29
CM-SM separation	May 26	11:22:26 a.m.	191:33:26
splashdown		11:52:23	192:03:23

EVA time: N/A

Earth landing coordinates: 15°2'S, 164°39'W (Pacific O.)

Recovery ship: *USS Princeton* (crew onboard in 39 min.)

Mission objectives: Demonstrate crew-vehicle support facilities performance during a manned lunar orbit mission; evaluate LM performance in cislunar-lunar environments.

Results: All objectives were achieved, confirming all aspects of a lunar landing mission except for the actual descent. In a low altitude pass, the LM came within 14 000 meters of the moon.

---

Reference: MSC, "*Apollo 10* Mission Report," MSC-00126, Aug. 1969.

Table 2-39. *Apollo 11* Characteristics

---

Date of launch (ETR launch complex #): July 16, 1969 (39A)  
 Official mission designation: AS-506  
 Spacecraft designation (name): SM-107  
   CM-107 (Columbia)  
   LM-5 (Eagle)

Launch vehicle designation (class): SA-506 (Saturn V)  
 Spacecraft weight (kg): 45 702  
 Spacecraft shape, dimensions (m): see table 2-37  
 Crew: Neil A. Armstrong, Commander; Michael Collins, CM pilot; Edward E. Aldrin, Jr., LM pilot  
 Backup crew: James A. Lovell, Commander; William A. Anders, CM pilot; Fred W. Haise, LM pilot  
 Apogee/perigee at insertion (km): 190.6 × 192.1  
 No. of earth orbits: 1.5  
 Period: approx. 90 min.  
 Lunar orbit parameters (km): 312.1 × 113.4 at insertion; 121.7 × 99.6, circularized  
 No. of lunar orbits: 30  
 Lunar landing coordinates: 0°39'N, 23°30'E (Sea of Tranquility)  
 Time on surface: 21:36:21  
 Lunar EVA time (# of excursions): 02:31:40 (1)  
 Length of mission: 195:18:35 (8+ days)  
 Mission events (date, time, ground elapsed time):

launch	July 16	8:32:00 a.m. EST	00:00:00
S-IC engine cutoff		8:34:42	00:02:42
S-II engine cutoff		8:41:08	00:09:08
earth orbit insertion		8:43:50	00:11:50
translunar injection		11:16:16	02:44:16
CSM-S-IVB separation		11:49:05	03:17:05
CSM-LM docking		11:56:03	03:24:03
lunar orbit insertion	July 19	12:21:50 p.m.	75:49:50
CSM-LM separation	July 20	1:11:53 p.m.	100:39:53
lunar landing		3:17:40	102:45:40
begin EVA		9:39:33	109:07:33
first step on surface		9:56:15	109:24:15
end EVA	July 21	12:11:13 a.m.	111:39:13
lunar liftoff		12:54:01 p.m.	124:22:01
LM-CSM docking		4:34:00	128:03:00
LM jettison		7:01:01	130:30:01
transearth injection		11:54:42	135:23:42
CM-SM separation	July 24	11:21:13 a.m.	194:49:13
splashdown		11:50:35	195:18:35

Earth landing coordinates: 13°19'N, 169°09'W (Pacific O.)  
 Recovery ship: *USS Hornet* (crew onboard in 63 min.)  
 Mission objectives: Perform a manned lunar landing and return; conduct scientific experiments; collect soil and rock samples for return to earth.  
 Results: All mission objectives were achieved. Armstrong became the first man to set foot on the moon on July 20, followed by Aldrin; Collins remained in the orbiting CSM. The crew collected 21 kg of lunar surface material to be returned for analysis and conducted other scientific and photographic tasks on the surface during their 2-hour EVA period.

---

Reference: MSC, "*Apollo 11* Mission Report," MSC-00171, Nov. 1969.

Table 2-40. *Apollo 12* Characteristics

---

Date of launch (ETR launch complex #): Nov. 14, 1969 (39A)  
 Official mission designation: AS-507  
 Spacecraft designation (name): SM-108  
   CM-108 (Yankee Clipper)  
   LM-6 (Intrepid)

Launch vehicle designation (class): SA-507 (Saturn V)  
 Spacecraft weight (kg): 45 870  
 Spacecraft shape, dimensions (m): see table 2-37  
 Crew: Charles Conrad, Jr., Commander; Richard F. Gordon, Jr., CM Pilot; Alan L. Bean, LM Pilot  
 Backup crew: David R. Scott, Commander; Alfred M. Worden, CM Pilot; James B. Irwin, LM Pilot  
 Apogee/perigee at insertion (km): 189.8 × 185  
 No. of earth orbits: 1.5  
 Period: approx. 90 min.  
 Lunar orbit parameters (km): 257.1 × 115.9 at insertion; 122.4 × 100.6 circularized  
 No. of lunar orbits: 45  
 Lunar landing coordinates: 3°12'S, 23°24'W (Ocean of Storms)  
 Time on surface: 31:31:12  
 Lunar EVA time (# of excursions): 7:45:18 (2)  
 Length of mission: 244:36:24 (10+ days)  
 Mission events (date, time, ground elapsed time):

launch	Nov. 14	11:22:00 a.m. EDT	00:00:00
S-IC engine cutoff		11:24:42	00:02:42
S-II engine cutoff		11:31:12	00:11:44
earth orbit insertion		11:33:44	00:11:44
translunar injection		2:15:14 p.m.	02:53:14
CSM-S-IVB separation		2:40:19	03:18:19
CSM-LM docking		2:48:53	03:26:53
lunar orbit insertion	Nov. 17	10:47:23 p.m.	83:25:23
CSM-LM separation	Nov. 18	11:16:03 p.m.	107:54:03
lunar landing	Nov. 19	1:54:35 a.m.	110:32:35
begin 1st EVA		6:32:35	115:10:35
end 1st EVA		10:28:38	119:06:38
begin 2d EVA		10:54:45 p.m.	131:32:45
end 2d EVA	Nov. 20	2:44:00 a.m.	135:22:00
lunar liftoff		9:25:47	142:03:47
LM-CSM docking		12:58:22 p.m.	145:30:22
LM jettison	Nov. 20	3:21:30 p.m.	147:59:30
transearth injection	Nov. 21	3:49:16 p.m.	172:27:16
CM-SM separation	Nov. 24	3:29:21 p.m.	244:07:21
splashdown		3:58:24	244:36:24

Earth landing coordinates: 15°47'S, 165°9'W (Pacific O.)  
 Recovery ship: *USS Hornet* (crew onboard in 50 min.)  
 Mission objectives: Lunar landing mission to perform selenological inspection, survey, and sampling of a mare area; deploy an ALSEP; develop techniques for point landing capability; develop capability to work in the lunar environment; photograph candidate exploration sites.  
 Results: All objectives were achieved. The crew brought back 34 kg of lunar samples collected during two EVA periods. The LM touched down just 182 meters from the *Surveyor 3* spacecraft from which the *Apollo 12* crew removed the soil scoop.

---

Reference: MSC, "Apollo 12 Mission Report," MSC-01855, March 1970; and NASA Hq., "Apollo 12 Mission Post-launch Mission Operation Report #1," M-932-69-12, Nov. 25, 1969.

Table 2-41. *Apollo 13* Characteristics

---

Date of launch (ETR launch complex #): April 11, 1970 (39A)  
 Official mission designation: AS-508  
 Spacecraft designation (name): SM-109  
   CM-109 (Odyssey)  
   LM-7 (Aquarius)

Launch vehicle designation (class): SA-508 (Saturn V)  
 Spacecraft weight (kg): 45 931  
 Spacecraft shape, dimensions (m): see table 2-37  
 Crew: James A. Lovell, Jr., Commander; John L. Swigert, Jr., CM Pilot; Fred W. Haise, LM Pilot  
 Backup crew: John W. Young, Commander; John L. Swigert, Jr., CM Pilot; Charles M. Duke, Jr., LM Pilot

Apogee/perigee at insertion (km): 185.6 × 181.5  
 No. of earth orbits: 1.5  
 Period: approx. 90 min.  
 Lunar orbit parameters (km): N/A  
 No. of lunar orbits: N/A  
 Lunar landing coordinates: N/A (Fra Mauro intended region)  
 Time on surface: N/A  
 Lunar EVA time (# of excursions): N/A  
 Length of mission: 142:54:41 (5 + days)  
 Mission events (date, time, ground elapsed time):

launch	Apr. 11	2:13:00 p.m. EST	00:00:00
S-IC engine cutoff		2:15:44	00:02:44
S-II engine cutoff		2:22:53	00:09:53
earth orbit insertion		2:25:40	00:12:40
translunar injection		4:54:47	02:41:47
CSM-S-IVB separation		5:19:39	03:06:39
CSM-LM docking		5:32:09	03:19:09
LO <sub>2</sub> tank anomaly	Apr. 13	10:07:53 p.m.	55:54:53
pericynthion maneuver	Apr. 14	9:40:39 p.m.	79:27:39
SM jettison	Apr. 17	8:15:06 a.m.	138:02:06
LM jettison		11:43:02	141:30:02
splashdown		1:07:41 p.m.	142:54:41

Earth landing coordinates: 21°38'S, 165°22'W (Pacific 0.)  
 Recovery ship: *USS Iwo Jima* (crew onboard in 46 min.)  
 Mission objectives: Lunar landing mission to conduct selenological inspection, survey, and sampling of the Imbrium basin; deploy an ALSEP; further develop man's capability to work in the lunar environment; photograph candidate exploration sites.  
 Results: None of the mission objectives was accomplished. The mission was aborted after nearly 56 hours of flight due to loss of service module cryogenic oxygen and consequent loss of capability to generate electrical power to provide oxygen and to produce water in the CSM. The command module was powered down at 58:40:00 into the flight and the lunar module configured to supply the necessary power and other consumables for the trip back to earth.

---

Reference: MSC, "Apollo 13 Mission Report," MSC-02680, Sept. 1970; and NASA Hq., "Apollo 13 Mission Pre-launch Mission Operation Report, M-932-70-13, March 13, 1970.

Table 2-42. *Apollo 14* Characteristics

Date of launch (ETR launch complex #): Jan. 31, 1971 (39A)

Official mission designation: AS-509

Spacecraft designation (name): SM-110

SM-110 (Kitty Hawk)

LM-8 (Antares)

Launch vehicle designation (class): SA-509 (Saturn V)

Spacecraft weight (kg): 45 305

Spacecraft shape, dimensions (m): see table 2-37

Crew: Alan B. Shepard, Jr., Commander; Stuart A. Roosa, CM Pilot; Edgar D. Mitchell, LM<sup>4</sup> Pilot

Backup crew: Eugene A. Cernan, Commander; Ronald E. Evans, CM Pilot; Joe H. Engle, LM Pilot

Apogee/perigee at insertion (km): 183.2 × 189.9

No. of earth orbits: 1.5

Period: approx. 90 min.

Lunar orbit parameters (km): 314.1 × 108.2 at insertion; 118.3 × 103.7 circularized

No. of lunar orbits: 34

Lunar landing coordinates: 3°40'S, 17°29'W (Fra Mauro)

Time on surface: 33:30:31

Lunar EVA time (# of excursions): 9:22:31 (2)

Length of mission: 216:01:58 (9+ days)

Mission events (date, time, ground elapsed time):\*

launch	Jan. 31	4:03:02 p.m. EST	00:00:00
S-IC engine cutoff		4:05:45	00:02:43
S-II engine cutoff		4:12:20	00:09:18
earth orbit insertion		4:14:51	00:11:49
translunar injection		6:37:34	02:34:32
CSM-S-IVB separation		7:05:31	03:02:29
CSM-LM docking		9:00:02	04:56:56
lunar orbit insertion	Feb. 4	1:59:43 a.m.	81:56:41
CSM-LM separation		11:50:44 p.m.	103:47:42
lunar landing	Feb. 5	4:18:11 a.m.	108:15:09
begin 1st EVA		9:42:13	113:39:11
end 1st EVA		2:30:03 p.m.	118:27:01
begin 2d EVA	Feb. 6	3:11:15 p.m.	131:08:13
end 2d EVA		7:45:56	135:42:54
lunar liftoff	Feb. 7	1:48:42 a.m.	141:45:40
LM-CSM docking		3:35:53	143:32:51
LM jettison		5:48:00	145:44:58
transearth injection		8:39:04	148:36:02
CM-SM separation	Feb. 9	3:35:44 p.m.	215:32:42
splashdown		4:05:00	216:01:58

Earth landing coordinates: 27°1'S, 172°39'W (Pacific O.)

Recovery ship: *USS New Orleans* (crew onboard in 48 min.)

Mission objectives: Lunar landing mission to perform selenological inspection, survey, and sampling of the Fra Mauro region; deploy an ALSEP; further develop man's capability to work in the lunar environment; photograph candidate exploration sites.

Results: All objectives were achieved. The crew brought 43 kg of lunar samples to earth with them.

\*There is a discrepancy of approximately 40 minutes in the sequence-of-events tables presented in the mission operation report and the mission report; the latter was used as the source for this table.  
Reference: MSC, "Apollo 14 Mission Report," MSC-04112, May 1971; and NASA Hq., "Apollo 14 Post-launch Mission Operation Report #1, M-933-71-14, Feb. 22, 1971.



Table 2-43. *Apollo 15* Characteristics (Continued)

Results: All objectives were achieved. The lunar roving vehicle (LRV-1) increased the range and scientific return of lunar surface operations; during the three EVA periods the LRV traversed 27.9 km at speeds of up to 12-13 kph. The vehicle's controllability and climbing capability were demonstrated. The crew collected 76.7 kg of lunar material. A satellite was released from the CSM on Aug. 4, which was used for scientific experiments; its lunar orbit was  $141.3 \times 102$  km.

Reference: MSC, "*Apollo 15* Mission Report," MSC-05161, Dec. 1971; and NASA Hq., "*Apollo 15* Mission Post-launch Mission Operation Report #1, M-933-71-15, Aug. 16, 1971.

Table 2-44. *Apollo 16* Characteristics

Date of launch (ETR launch complex #): April 16, 1972 (39A)

Official mission designation: AS-511

Spacecraft designation (name): SM-113

CM-113 (Casper)

LM-11 (Orion)

Launch vehicle designation (class): SA-511 (Saturn V)

Spacecraft weight (kg): 48 606

Spacecraft shape, dimensions (m): see table 2-37

Crew: John W. Young, Commander; Thomas K. Mattingly II, CM Pilot; Charles M. Duke, Jr., LM Pilot

Backup crew: Fred W. Haise, Jr., Commander; Stuart A. Roosa, CM Pilot; Edgar D. Mitchell, LM Pilot

Apogee/perigee at insertion (km):  $176 \times 166.7$

No. of earth orbits: 1.5

Period: approx. 90 min.

Lunar orbit parameters (km):  $315.4 \times 107.6$  at insertion;  $125.9 \times 98.3$  circularized

No. of lunar orbits: 64

Lunar landing coordinates:  $9^{\circ}\text{S}$ ,  $15^{\circ}31'\text{E}$  (Descartes)

Time on lunar surface: 71:02:13

Lunar EVA time (# of excursions): 20:14:14 (3)

Length of mission: 265:51:05 (11+ days)

Mission events (date, time, ground elapsed time):

launch	Apr. 16	12:54:00 p.m. EST	00:00:00
S-IC engine cutoff		12:56:41	00:02:41
S-II engine cutoff		1:03:19	00:09:19
earth orbit insertion		1:05:56	00:11:56
translunar injection		3:27:37	02:33:37
CSM-S-IVB separation		3:58:59	03:04:59
CSM-LM docking		4:15:53	03:21:53
lunar orbit insertion	Apr. 19	3:22:28 p.m.	74:28:28
CSM-LM separation	Apr. 20	1:08:00 p.m.	96:14:00
lunar landing		9:23:35	104:29:35
begin 1st EVA	Apr. 21	11:47:38 a.m.	118:53:38
end 1st EVA		6:58:40 p.m.	126:04:40
begin 2d EVA	Apr. 22	11:33:35 a.m.	142:39:35
end 2d EVA		6:56:44 p.m.	150:02:44
begin 3d EVA	Apr. 23	10:25:28 a.m.	165:31:28
end 3d EVA		4:05:31 p.m.	171:11:31
lunar liftoff	Apr. 23	8:25:48 p.m.	175:31:48



Table 2-44. *Apollo 16* Characteristics (Continued)

LM-CSM docking		10:35:18	177:41:18
LM jettison	Apr. 24	3:54:12 p.m.	195:00:12
subsattellite launch		4:56:09	196:02:09
transearth injection		9:15:33	200:21:33
CM-SM separation	Apr. 27	2:16:33 p.m.	265:22:33
splashdown		2:45:05	265:51:05

Earth landing coordinates: 0°43'S, 156°13'W (Pacific O.)

Recovery ship: *USS Ticonderoga* (crew onboard in 37 min.)

Mission objectives: Lunar landing mission to perform selenological inspection, survey, and sampling of the Descartes region; deploy an ALSEP; photograph selected areas.

Results: All objectives were achieved. The crew traveled 27 km in LRV-2, collecting 95 kg of soil and rock samples. Because of a problem with the CSM's secondary yaw actuator servo loop, the mission was shortened by one day. The subsattellite, launched on the 24th, was not inserted into the planned orbit (subsattellite impacted on May 29 during revolution 425).

Reference: MSC, "*Apollo 16* Mission Report," MSC-07230, Aug. 1972.

Table 2-45. *Apollo 17* Characteristics

Date of launch (ETR launch complex #): Dec. 7, 1972			
Official mission designation: AS-512			
Spacecraft designation (name): SM-114			
CM-114 (America)			
LM-12 (Challenger)			
Launch vehicle designation (Class): SA-512 (Saturn V)			
Spacecraft weight (kg): 48 622			
Spacecraft shape, dimensions (m): see table 2-37			
Crew: Eugene A. Cernan, Commander; Ronald E. Evans, CM Pilot; Harrison H. Schmitt, LM Pilot			
Backup crew: John W. Young, Commander; Stuart A. Roosa, CM Pilot; Charles M. Duke, Jr., LM Pilot			
Apogee/perigee at insertion (km): 171.3 × 168.9			
No. of earth orbits: 2			
Period: approx. 90 min.			
Lunar orbit parameters (km): 314.8 × 97.4 at insertion; 129.6 × 100 circularized			
No. of lunar orbits: 75			
Lunar landing coordinates: 20°13'N, 30°45'E (Taurus-Littrow)			
Time on lunar surface: 74:59:40			
Lunar EVA time (# of excursions): 22:03:57 (3)			
Length of mission: 301:51:59 (12+ days)			
Mission events (date, time, ground elapsed time):			
launch	Dec. 7	12:33:00 a.m. EST	00:00:00
S-IC engine cutoff		12:35:41	00:02:41
S-II engine cutoff		12:42:19	00:09:19
earth orbit insertion		12:44:53	00:11:53
translunar injection		3:45:37	03:12:37
CSM-S-IVB separation		4:15:29	03:42:29
CSM-LM docking		4:39:45	03:56:45
lunar orbit insertion	Dec. 10	2:47:23 p.m.	86:14:23
CSM-LM separation	Dec. 11	12:20:56 p.m.	107:47:56

Table 2-45. *Apollo 17* Characteristics (Continued)

lunar landing		2:54:57	110:21:57
begin 1st EVA		6:54:49	114:21:49
end 1st EVA	Dec. 12	2:06:42 a.m.	121:33:42
begin 2d EVA		6:28:06 p.m.	137:55:06
end 2d EVA	Dec. 13	2:05:02 a.m.	145:32:02
begin 3d EVA		5:25:48 p.m.	160:52:48
end 3d EVA	Dec. 14	12:40:56 a.m.	168:07:56
lunar liftoff	Dec. 14	5:54:37 p.m.	185:21:37
LM-CSM docking		8:10:15	187:37:15
LM jettison		11:51:31	191:18:31
transearth injection	Dec. 16	6:35:09 p.m.	234:02:09
CM-SM separation	Dec. 19	1:56:49 p.m.	301:23:49
splashdown		2:24:59	301:51:59

Earth landing coordinates: 17°53'S, 166°7'W (Pacific O.)

Recovery ship: *USS Ticonderoga* (crew onboard in 52 min.)

Mission objectives: Lunar landing mission to perform selenological inspection, survey, and sampling of the Taurus-Littrow region with a special emphasis on geological tasks; deploy an ALSEP; conduct in-flight experiments and photography.

Results: All objectives were achieved. The crew traveled 35 km in LRV-3 and collected 117 kg of lunar samples.

Reference: JSC, "*Apollo 17* Mission Report," JSC-07904, March 1973.

Table 2-46. Apollo Lunar Mission Experiments

No.	Experiment	Apollo Mission							
		11	12	13	14	15	16	17	
M 78	Bone Mineral Measurement				X				
M515	Lunar Dust Detector (ALSEP)		X	N	X	X			
S 31	Passive Seismic (EASEP, ALSEP)	X	X	N	X	X	X		
S 33	Lunar Active Seismology (ALSEP)				X		X		
S 34	Lunar Surface Magnetometer (ALSEP)		X			X	X		
S 35	Solar Wind Spectrometer (ALSEP)		X			X			
S 36	Suprathermal Ion Detector (ALSEP)		X		X	X			
S 37	Lunar Heat Flow (ALSEP)			N		X	N	X	
S 38	Charged Particle Lunar Environment (ALSEP)			N	X				
S 58	Cold Cathode Ion Gauge (ALSEP)		X	N	X	X			
S 59	Lunar Field Geology	P	X	N	X	X	X	X	
S 78	Laser Ranging Retro-reflector (EASEP)	X			X	X			
S 80	Solar Wind Composition	X	X	N	X	X	X		
S151	Cosmic Ray Detector	X							
S152	Cosmic Ray Detector (Sheets)						X	X	
S158	Lunar Multispectral Photography		X						
S164	CSM/LM S-band Transponder			N	X				
S170	Downlink Bistatic Radar			N	X				
S176	Apollo Window Meteoroid				X				
S178	Gegenschein from Lunar Orbit			N	X				
S184	Lunar Surface Closeup Photography			N					
S198	Portable Magnetometer				X		X		
S199	Traverse Gravimeter								X
S200	Soil Mechanics				X	X	X		
S201	Far UV Camera/Spectroscope						X		
S202	Lunar Ejecta and Meteorites (ALSEP)								X
S203	Lunar Seismic Profiling (ALSEP)								X
S204	Surface Electrical Properties								X
S205	Lunar Atmospheric Composition (ALSEP)								X
S207	Lunar Surface Gravimeter (ALSEP)								P
T 29	Pilot Describing Function	X	X						

EASEP = part of the Apollo 11 Early Apollo Scientific Experiments Package

ALSEP = part of the Apollo Lunar Surface Experiment Package

X = experiment performed successfully

P = experiment performed partially

N = experiment not performed successfully

## Skylab

An orbital space station, from which man could launch spacecraft to the moon and the planets or at which scientists could perform a variety of investigations and observations for long periods of time, has been a goal of would-be spacefarers since long before NASA was established in 1958. NASA's first serious study of a permanent manned orbiting laboratory took place in the spring of 1959.

NASA's advanced planners identified five basic methods for establishing a station in earth orbit: erect an inflatable structure, which could be launched in a folded configuration and deployed once in orbit; launch matching modules into orbit and assemble them there, using a space ferry for manpower and supplies; convert a

launch vehicle stage to a habitable environment once its fuel supply had been expended (the "wet" workshop); or outfit a launch vehicle stage as a station and launch it into orbit by another vehicle (the "dry" workshop). The ideal station, of course, would be permanent and large enough for many crewmen; the adoption of a launch vehicle as a laboratory would serve as a worthy precursor to a larger, more elaborate station.

As early as 1963, personnel at the Manned Spacecraft Center (MSC) were suggesting that Apollo program hardware could be used to build a space station for 18 men. NASA Headquarters established a Saturn/Apollo Applications Office in August 1965 within the Office of Manned Space Flight to investigate the many plans that had been offered by its research centers and industry to modify Apollo era hardware to form orbiting laboratories and to evaluate possible follow-on Apollo missions.

At NASA's Marshall Space Flight Center in 1965, designers began investigating the conversion of a spent Saturn IVB stage into an orbital workshop by an Apollo crew—the wet workshop concept. Headquarters supported the idea and directed personnel at MSC and the Kennedy Space Center to cooperate with Marshall. By the next year, the Apollo Applications Office was planning three S-IVB wet workshops, three Saturn V dry orbital laboratories, and four Apollo Telescope Mounts for use on the workshops (in late 1967 the estimate was down to two workshops, one Saturn V lab, and three ATMs; in 1968 the goal was one workshop and one backup, one Saturn V lab, and one ATM).

The Saturn IVB workshop would be placed in orbit and converted to a suitable environment by visiting Apollo crews. The astronauts would enter the laboratory through a special airlock module, a contract for which was let to McDonnell Douglas in August 1966. Power would be provided by large solar panels that would unfold from the workshop.

In the spring of 1969, Wernher von Braun, who had had considerable input on NASA's original ideas for space stations in the 1950s and whose design the Saturn launch vehicle family was, proposed, as director of Marshall, that the agency consider substituting the "dry" workshop for the "wet" workshop configuration. The change was already being investigated at NASA Headquarters, where acting administrator Tom Paine was getting little support from Congress and the President for big-budget items. The evolution from Saturn IVB wet workshops to Saturn V-launched dry orbital laboratories was not seen as a great technological step, but it would be an expensive one. If a Saturn V vehicle could be earmarked for use in an Apollo applications mission, it would be better for the agency's shrinking budget if the intermediate step was skipped. Paine signed a project approval document for the change on July 18, 1969.<sup>6</sup> The project now called for one dry workshop sporting an Apollo Telescope Mount to be launched by a Saturn V, with three visits by Apollo crews placed into orbit by Saturn IBs (see fig. 2-8). In March 1970, this program was named Skylab, with the launch of the orbiting laboratory scheduled for November 1972; in April 1971 the schedule was pushed back to April 1973. The three crews were announced in the early winter of 1972.\*

---

\* The members of the three Skylab prime crews announced in January 1972 were Charles Conrad, Jr., Joseph P. Kerwin, and Paul J. Weitz on *Skylab 2*; Alan L. Bean, Owen K. Garriott, and Jack R. Lousma on *Skylab 3*; and Gerald P. Carr, Edward G. Gibson, and William R. Pogue on *Skylab 4*.

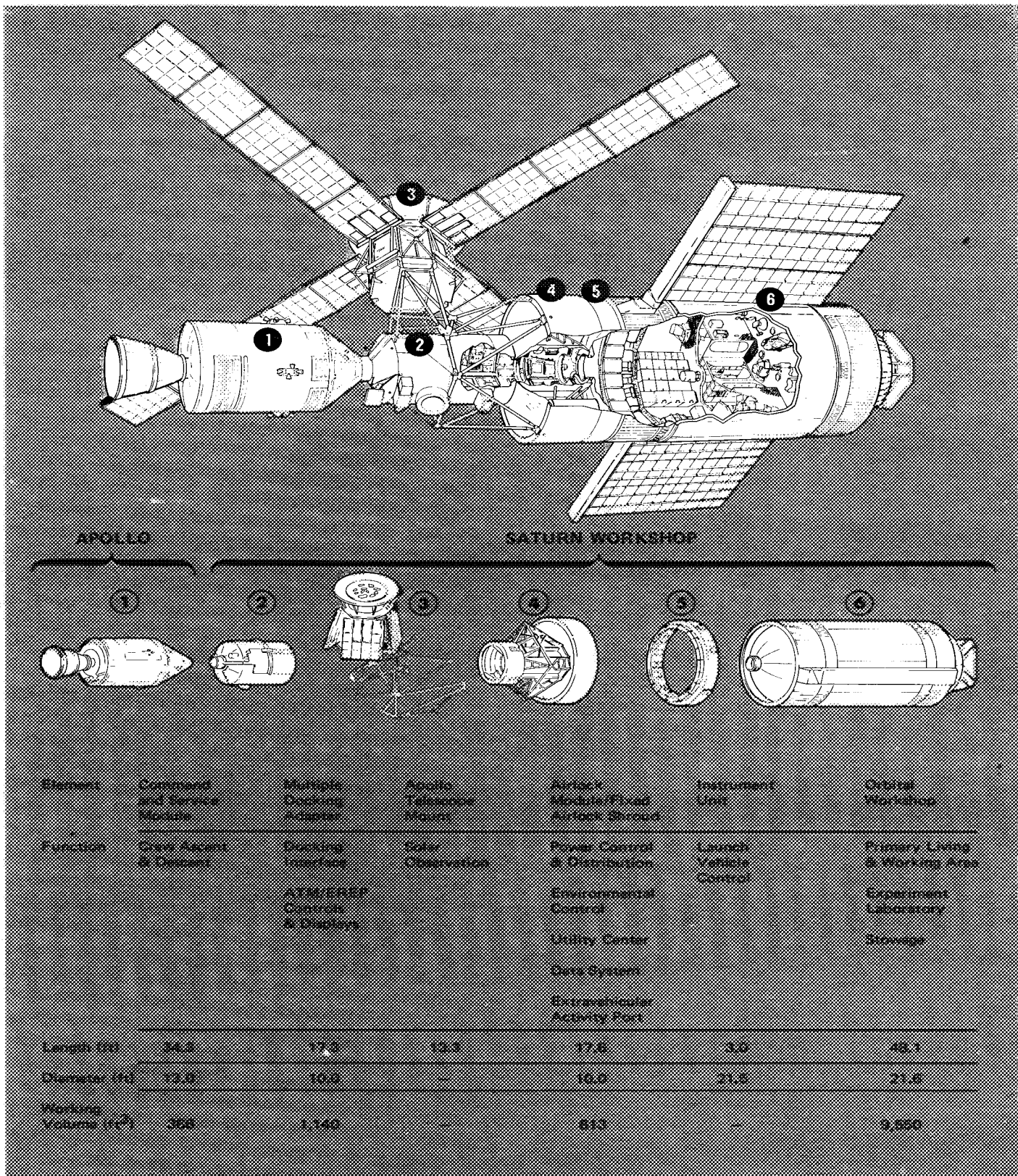

Figure 2-6. Components of Skylab

Source: MSFC, "MSFC Skylab Mission Report—Saturn Workshop," TMX-64814, Oct. 1974, p. 2-3.

ORIGINAL PAGE IS  
OF POOR QUALITY

The launch of *Skylab 1*, the orbital workshop, took place on May 14, 1973, with one major anomaly. The meteoroid shield failed to deploy properly, jamming one of the two solar panels and tearing off the second. Skylab reached the desired near-circular orbit, but without the necessary panels the internal temperature was too high for the crews that were to follow. The launch of *Skylab 2*, scheduled for the next day, was postponed while engineers designed a "parasol" of aluminized Mylar-nylon laminate to protect the workshop from the sun. The first Skylab crew, parasol stowed onboard, arrived at the basking workshop six hours after launch on May 25 and docked. The parasol was deployed in less than three hours, and the temperature started decreasing immediately. Another major task was to free the undeployed solar array, which the crew did on June 7 (see tables 2-49 through 2-51 for details on the three crew visits to Skylab).

One of Skylab's primary objectives was to study the long-term effects of weightlessness on man. The first Skylab crew lived and worked in the orbiting lab for 28 days, the second for 59 days, and the third for 84 days. The crews evaluated exercise techniques, performed scientific investigations (solar astronomy, life sciences, earth resources, astrophysics, engineering and technology, observing Comet Kohoutek, and materials processing), and learned to relax, eat, sleep, and keep house in space day after day (see table 2-52 for a list of Skylab experiments).<sup>7</sup>

Most of the experiment data that were returned during the missions were medical, allowing the flight physicians to continually monitor the health of the crewmen. The other scientific investigators had to wait for much of the results from the flown experiments, but for most the wait was worth it. Astronomers alone received 103 000 photographs and spectra for their evaluation; earth resources specialists were treated to thousands of images, many of which were multispectral. The Apollo Telescope Mount proved to be revolutionary for the field of solar physics. It was clear that "it was feasible to live for extended periods in orbit without becoming disoriented or encountering major problems with the lack of a gravity field. It was simply another work environment."<sup>8</sup> A future space station crew would not suffer from long stays and could obviously be kept busy with scientific, engineering, and materials processing tasks. Skylab had proven that.

Table 2-47. Chronology of Skylab Development and Operations

Date	Event
Feb. 20, 1959	NASA Deputy Administrator Hugh L. Dryden told the Senate Committee on Aeronautical and Space Sciences that one of the agency's long-range goals was a permanent manned orbiting laboratory. During the following spring, several groups within NASA studied the concept of an orbiting laboratory as one project that might follow Project Mercury. (In its 1960 budget, NASA requested \$2 million to study methods of constructing a manned laboratory or converting the Mercury spacecraft into a two-man laboratory.)
June 8, 1959	In a report prepared for the Army Ballistic Missile Agency, Wernher von Braun suggested that a space station could be designed around a spent booster stage (a concept that was later called the "wet workshop").
July 10, 1959	A conference at Langley Research Center (LRC) considered the problems associated with developing the technology to build, launch, and operate a manned space station.
Apr. 20-22, 1960	The Institute of the Aeronautical Sciences, NASA and RAND Corp. sponsored a Manned Space Stations Symposium.
Oct. 1961	Emanuel Schnitzer of LRC suggested using Apollo hardware to build a space laboratory. The "Apollo X" vehicle would consist of a standard command and service module (CSM) with an added inflatable spheroid structure and transfer tunnel. This suggestion led others within NASA to think about adapting Apollo-developed hardware to laboratories and stations.
Apr. 1962	Manned Spacecraft Center (MSC) personnel prepared a preliminary document that outlined areas of investigation for a space station study program.
May 10, 1962	John C. Fischer, Jr., of Lewis Research Center suggested a two-phase approach to a space station program: first, a manned station that would operate for four to six years, being resupplied and remanned by ferry craft, followed by an inflatable station with artificial gravity.
July 31-Aug. 1 1962	LRC hosted a forum for NASA researchers interested in space station work.
Sept. 28, 1962	At a meeting at NASA Headquarters, personnel from the Office of Manned Space Flight (OMSF), the Office of Advanced Research and Technology (OART), MSC, Marshall Space Flight Center (MSFC), and LRC agreed that the concept of a space station was an important one for the future and that advanced technological work should proceed at the centers.
Mar. 1, 1963	MSC proposed constructing an 18-man station from hardware under development for Apollo.
Mar. 28, 1963	Abraham Hyatt of NASA Headquarters organized a task team to study the concept of a manned earth-orbiting laboratory.
Apr. 11, 1963	The leaders of MSC's Flight Operations Division met with LRC personnel to discuss the Virginia center's proposed four-man Manned Orbital Research Laboratory. On June 24, LRC announced that The Boeing Co. and Douglas Aircraft Co., Inc., had been selected to study the concept.
Aug. 17-Sept. 14, 1963	NASA and the Department of Defense (DoD) signed a joint agreement to coordinate their studies of advanced space exploration, including any manned space station concepts.
Dec. 10, 1963	DoD announced that funds that had been set aside for the X-20 Dyna Soar project, which had been cancelled, would be rechanneled to the Air Force's Manned Orbiting Laboratory (MOL) project. NASA would provide technical support to this exclusively military project.
Mar. 1964	The Lockheed-California Co. delivered the results of its study of a rotating manned orbital research laboratory. The laboratory, which would be launched by a Saturn V, would accommodate a crew of 24 and be operational for 1 to 5 years.
Aug. 17, 1964	In a revival of the "Apollo X" concept, MSC's Spacecraft Integration Branch offered its proposal for an orbiting laboratory. The 2-man laboratory would be launched by a Saturn IB for a 14- to 45-day mission. Other configurations included a

Table 2-47. Chronology of Skylab Development and Operations (Continued)

Date	Event
Dec. 11, 1964	3-man, 45-day mission; a 3-man, 45-day mission in a double-laboratory module; and a 3-man, 120-day mission in an independent systems module. LRC awarded Boeing a 10-month contract to study the feasibility of designing and launching a manned orbital telescope.
June 18, 1965	LRC awarded Douglas a follow-on study contract for the Manned Orbital Research Laboratory, which would emphasize the Apollo Extension System effort (use of Apollo-era technology).
July 30, 1965	Lockheed-California delivered its report to MSC on a modular multipurpose space station. Configurations included: 45-day, 3-man, 1-compartment lab; 1-year, 6-man, 2-compartment lab; 90-day, 3- to 6-man, 2-compartment lab; 1- to 5-year, 6-to 9-man, 6-compartment station; and 5- to 10-year, 24- to 36-man, Y-configuration station.
Aug. 6-10, 1965	NASA Headquarters established the Saturn/Apollo Applications Office within OMSF. The new office would be responsible for the Apollo Extension System effort, among other projects. David M. Jones was acting director, John H. Disher deputy director.
Aug. 20, 1965	Designers at MSFC began seriously to investigate the concept of a Saturn IVB-stage orbital workshop—the in-orbit conversion of a spent S-IVB stage to an orbital laboratory by an Apollo crew launched separately. MSFC asked for the assistance of MSC and Douglas, the manufacturer of the stage, in this four-month design study.
Aug. 25, 1965	President Lyndon B. Johnson approved DoD's development of the MOL.
Sept. 10, 1965	The Apollo Extension System effort was renamed the Apollo Applications Program. NASA Headquarters assigned MSC responsibility for spacecraft development, crew activities, mission control and flight operations, and payload integration; MSFC responsibility for launch vehicle development; and the Kennedy Space Center (KSC) responsibility for pre-launch and launch activities. William B. Taylor, director of the Apollo Applications Program, named Joseph G. Lundholm manager of Apollo applications experiments.
Oct. 20, 1965	Officials from MSC and MSFC held their first orbital workshop coordination meeting. In December, the orbital workshop (OWS) became a separate project at MSFC, with the support of OMSF.
Nov. 1965	North American Aviation, Inc., delivered to MSC its technical proposal for the Apollo applications-era CSM.
Jan. 1966	Douglas submitted its summary report on the Manned Orbital Research Laboratory to LRC. The study demonstrated the feasibility of launching, operating, and maintaining an orbital laboratory and examined how such a laboratory could be used.
Feb. 11, 1966	MSFC submitted to NASA Headquarters a project management proposal for an Apollo telescope mount (ATM) to be used with an Apollo-derived orbital laboratory or an Apollo spacecraft (lunar module). The ATM was based on an engineering and definition study completed by Ball Brothers Research Corp. (Sept. 1965–Apr. 1966).
Mar. 21, 1966	The Military Operations Subcommittee of the House Committee on Government Operations recommended combining NASA's Apollo Applications Program with the Air Force's MOL. NASA and DoD created a Manned Space Flight Experiments Board to coordinate their experiment programs.
Mar. 23, 1966	In their first schedule, personnel in the Apollo Applications Program planned 26 Saturn IB and 19 Saturn V launches, including 3 S-IVB wet workshops, 3 S-V orbital laboratories, and 4 ATMs.
Apr. 18, 1966	MSC granted study contracts to Douglas, Grumman Aircraft Engineering Corp., and McDonnell Douglas Corp. for definition studies on the OWS experiment support module (by Aug. called the airlock module).
May 20-21, 1966	Representatives from NASA and the Air Force met to discuss proposed medical experiments for the Apollo Applications Program and MOL.
June 1, 1966	NASA Headquarters selected Martin Marietta Corp. and Lockheed to perform final definition studies for the payload integration aspect of Apollo application missions.



Table 2-47. Chronology of Skylab Development and Operations (Continued)

Date	Event
July 6, 1966	George M. Low became acting manager of MSC's new Apollo Applications Program Office, Robert F. Thompson the assistant manager; Leland F. Belew became MSFC's Apollo applications manager. An Experiments Office was also established at MSFC.
July 13, 1966	A Saturn/Apollo Applications Mission Planning Task Force led by William D. Green, Jr., was created to oversee and coordinate the mission definition process for proposed Apollo applications missions.
July 13, 1966	Program management for the ATM was assigned to MSFC.
July 14, 1966	NASA and DoD established a Joint Manned Space Flight Policy Committee to coordinate their manned spaceflight activities.
July 18, 1966	David Jones assumed management responsibility at NASA Headquarters for the development of the OWS and the experiment support module.
July 26, 1966	It was formally announced at NASA Headquarters that OMSF had full responsibility for Apollo and Apollo applications missions; the Office of Space Science and Applications would select experiments to be flown aboard these missions and analyze the results; OART would be responsible for choosing technical experiments; the Office of Tracking and Data Acquisition would satisfy the communications requirements for the experiments.
Aug. 19, 1966	NASA selected McDonnell Douglas to manufacture an airlock module (formerly called the spent stage experiment support module) for the Apollo Applications Program by which astronauts would enter the empty hydrogen tank of a spent S-IVB stage (OWS). A contract was approved on Dec. 6
Oct. 25, 1966	MSFC distributed its research and development plan for the OWS.
Nov. 8, 1966	NASA Headquarters announced plans for the first 4 Apollo applications missions: SAA-209—28-day manned test flight of the block II CSM; SAA-210—launch of an unmanned OWS with airlock module and multiple docking adapter; SAA-211—56-day visit to the OWS by an Apollo crew; and SAA-212—unmanned lunar module-ATM flight.
Nov. 30, 1966	Charles W. Mathews became director of Saturn/Apollo applications at NASA Headquarters.
Apr. 18-19, 1967	Personnel from MSC and MSFC met to review the S-IVB stage for acceptability as a habitable vehicle. This was followed in May by a preliminary design review to evaluate the basic design approach the team was taking toward the spent-stage OWS.
July 26, 1967	NASA selected Martin Marietta to perform payload (experiments and experiments support equipment) integration tasks. This contract was definitized on Jan. 30, 1969. On the same day, the agency awarded Boeing a contract for long-lead-time materials for two additional Saturn Vs.
Oct. 3, 1967	In a revised schedule (see Mar. 23, 1966) that reflected budget cutbacks, NASA Headquarters announced that it was planning 4 Apollo applications lunar-activity missions, 17 Saturn IB launches, 7 Saturn V launches, 2 OWSs, 1 Saturn V workshop, and 3 ATMs.
Nov. 18-19, 1967	At meetings held at NASA Headquarters and at MSFC, representatives from MSC proposed a dry workshop (also called the Saturn V workshop) as a better choice for an Apollo applications laboratory; the adoption of the dry workshop concept would solve the habitability problems they had been having with the spent-stage concept.
Dec. 4, 1967	Thompson became manager of MSC's Apollo Applications Program Office.
Jan. 9, 1968	Additional budget cuts required another change to the Apollo applications mission schedule (see Oct. 3, 1967): 3 Saturn IB launches, 3 Saturn V launches, 1 OWS, 1 Saturn V workshop, 1 ATM to be flown with a workshop and 2 lunar missions. The first OWS launch was scheduled for Apr. 1970.
Jan. 9, 1968	MSFC awarded Parker-Elmer Corp. a contract to develop the telescopes for the ATM.

Table 2-47. Chronology of Skylab Development and Operations (Continued)

Date	Event
Jan. 16-17, 1968	A preliminary design review of the multiple docking adapter for the OWS was held at MSFC.
Jan. 23, 1968	The airlock module was given the additional task of housing the electrical power conditioning, storage, and distribution system.
Apr. 3-15, 1968	In response to increased budget cuts, NASA managers concluded that the most practical near-term Apollo applications mission was a simplified Saturn IB-launched workshop.
June 4, 1968	In another schedule revision (see Jan. 9, 1968), NASA announced that Apollo applications missions planning now called for 11 Saturn IB launches, 1 Saturn V launch, 1 OWS, 1 backup OWS, 1 Saturn V workshop and 1 ATM. The first OWS launch was scheduled for Nov. 1970.
Sept. 23-26, 1968	A preliminary design review of the ATM was held at MSFC.
Dec. 1, 1968	Technical management of the airlock module was transferred from MSC to MSFC.
Dec. 18, 1968	William C. Schneider became director of the Apollo Applications Program.
Jan. 8, 1969	An Apollo Applications Program baseline configuration review was held at NASA Headquarters; a second review took place on May 22.
Feb. 26, 1969	NASA announced it would negotiate with North American Rockwell for modifications to four Apollo spacecraft for Apollo applications missions.
May 21, 1969	At a meeting at MSC, NASA personnel from Headquarters and the centers discussed what options the Apollo Applications Program could recommend. Most of the discussions concerned using a dry rather than a wet workshop. On the 23rd, MSFC Director von Braun voted for a Saturn V-launched dry workshop. On the 26th, MSC Director Robert R. Gilruth also cast his center's lot with the dry concept.
May 10-23, 1969	DoD cancelled its MOL program. NASA requested that the MOL food and diet contract with Whirlpool Corp. and the spacesuit development contract with Hamilton Standard Div., United Aircraft Corp., be transferred to it.
July 18, 1969	Based on information presented on July 8-9, NASA Administrator Thomas O. Paine approved the shift from a wet to a dry OWS. The latest mission schedule (see also June 4, 1968) left only four launches, the first of which would take place in July 1972. The change to the dry concept was announced to the public on the 22nd.
Aug. 4, 1969	Seven MOL astronaut-trainees were transferred from the Air Force to NASA.
Aug. 8, 1969	MSFC definitized its contract with McDonnell Douglas for two OWSs; the second workshop would serve as a backup.
Feb. 13, 1970	Kenneth S. Kleinknecht became manager of MSC's Apollo Applications Program.
Feb. 17, 1970	The Apollo Applications Program was renamed the Skylab Program.
Mar. 7, 1970	In stating his proposed space goals for the 1970s, President Richard M. Nixon included an experimental space station as one of his six objectives.
May 26, 1970	The ATM critical design review was completed at MSFC; this review gave formal approval to the ATM design.
Aug. 10-14, 1970	The airlock module critical design review was held at McDonnell Douglas.
Aug. 24-27, 1970	The multiple docking adapter critical design review was held at Martin Marietta.
Aug. 28, 1970	MSFC modified its contract with McDonnell Douglas to reflect the switch from the wet to the dry workshop.
Aug. 31, 1970	NASA's latest launch schedule (see July 18, 1969) called for the launch of Skylab 1 on Nov. 1, 1972.
Sept. 14-18, 1970	An OWS critical design review was conducted at McDonnell Douglas.
Jan. 19-21, 1971	A solar array system critical design was held at TRW, Inc.
Apr. 13, 1971	The most recent published launch schedule (see also Aug. 31, 1970) listed Apr. 30, 1973, as the date of the first Skylab launch.
May 9, 1971	A flight hardware meteoroid shield development test was performed on the OWS flight article. Although the shield did not deploy fully and took longer than expected to deploy, it was concluded that development would have been successful if performed in orbit.

Table 2-47. Chronology of Skylab Development and Operations (Continued)

Sept. 24, 1971	McDonnell Douglas delivered the Skylab payload shroud, the first major piece of hardware to be completed, to KSC.
Nov. 15, 1971	NASA Headquarters formed a Manned Space Flight Team to conduct a mid-term review of Skylab; the team's report, delivered in Jan. 1972, expressed confidence that the Apr. 30, 1973, launch date could be met.
Jan. 1972	The prime crews for the Skylab missions were announced: Skylab 2—Charles Conrad, Jr., Joseph P. Kerwin, and Paul J. Weitz; Skylab 3—Alan L. Bean, Owen K. Garriott, and Jack R. Lousma; and Skylab 4—Gerald P. Carr, Edward G. Gibson, and William R. Pogue (the launch of the workshop would be termed Skylab 1).
Apr. 6, 1972	NASA and the National Science Teachers Association announced the 25 finalists in the Skylab Student project who had proposed feasible flight experiments for Skylab.
June 7-8, 1972	A launch vehicle design certification review was held at MSCF; launch vehicles for Skylab 1 and 2 were found acceptable.
June 21, 1972	A CSM design certification review was held at MSC; the CSM was found acceptable.
July 18-19, 1972	The first CSM for Skylab was delivered to KSC.
Sept. 15, 1972	A mission operations design certification review was held at MSC; preparations for all mission operations requirements were found to be satisfactory.
Sept. 22, 1972	The ATM arrived at KSC.
Sept. 23, 1972	The Skylab 1 OWS was moved inside the vehicle assembly building at KSC.
Oct. 2-3, 1972	A modules and experiments design certification review was held at MSFC.
Oct. 3-29, 1972	During tests of the meteoroid shield at KSC, problems were encountered with it deploying properly. It was successfully deployed on the 22d and judged acceptable for flight.
Jan. 29-30, 1973	Checkout of the airlock module, multiple docking adapter, and ATM flight units was completed at KSC, and the units were mated to the OWS and the OWS to its Saturn V launch vehicle.
Feb. 19, 1973	Robert A. R. Parker was named Skylab program scientist.
Feb. 27, 1973	Mated Apollo spacecraft and Saturn IB launch vehicle (Skylab 2) were transferred from the vehicle assembly building to Launch Complex 39B.
Apr. 5, 1973	The flight readiness test for Skylab 2 was completed.
May 14, 1973	During the launch of the Skylab OWS ( <i>Skylab 1</i> ), the meteoroid shield failed to deploy properly; as a result one of the solar panels was torn off and the second one became jammed. The laboratory was placed in the desired near-circular orbit, but its internal temperature increased beyond acceptable limits for habitability. The launch of Skylab 2, scheduled for the 15th, was postponed.
May 22, 1973	A board of investigation was established to assess the anomalies that occurred during the launch of <i>Skylab 1</i> .
May 23-24, 1973	A design certification review was held for the revised Skylab 2 mission, during which the crew would erect a "parasol" of ultraviolet-resistant material (aluminized Mylar/nylon laminate) to protect the workshop from the heat of the sun. The parasol was conceived, developed, and constructed in seven days at the Johnson Space Center (JSC, formerly MSC).
May 25, 1973	<i>Skylab 2</i> was launched successfully at 9:00 a.m. (all times EDT). Six hours later the Apollo spacecraft was in position to rendezvous with Skylab; the crew soft-docked at 5:56 p.m.
May 26, 1973	The <i>Skylab 2</i> crew entered the OWS, finding a hot but habitable environment that allowed them to work for 10- to 15-minute intervals. The parasol was deployed in 2½ hours, leading to an immediate temperature decrease in the workshop.
June 7, 1973	The <i>Skylab 2</i> crew freed the undeployed solar array.
June 11, 1973	The mated Skylab 3 spacecraft and launch vehicle were moved to Launch Complex 39B.

Table 2-47. Chronology of Skylab Development and Operations (Continued)

Date	Event
June 22, 1973	<i>Skylab 2</i> splashed down in the Pacific Ocean at 9:49 a.m. after a mission lasting more than 28 days. The crew was found to be in good health.
June 29, 1973	The <i>Skylab 3</i> flight readiness test was completed.
July 28, 1973	<i>Skylab 3</i> was launched successfully at 7:11 a.m. The crew docked with the laboratory 8½ hours later.
Aug. 6, 1973	A more refined thermal parasol developed at MSFC was erected over the original one, lowering the cabin temperature even more.
Aug. 13, 1973	NASA Headquarters officials moved to delete the backup <i>Skylab</i> workshop from the program schedule.
Aug. 14, 1973	The mated <i>Skylab 4</i> spacecraft and launch vehicle were moved to Launch Complex 39B.
Sept. 5, 1973	The <i>Skylab 4</i> flight readiness test was completed.
Sept. 25, 1973	<i>Skylab 3</i> splashed down in the Pacific Ocean at 6:20 p.m. after a mission lasting more than 59 days. The crew exhibited no adverse reactions to the lengthy visit.
Nov. 6, 1973	Because hairline cracks were discovered in the fins of the S-IB launch vehicle, the launch was postponed from 10 to 16 Nov. while the fins were replaced.
Nov. 16, 1973	<i>Skylab 4</i> was launched successfully at 10:01 a.m. Docking with the workshop took place 8 hours later.
Dec. 25-29, 1973	The <i>Skylab 4</i> crew photographed the Comet Kohoutek prior to and after perihelion. This photography assignment was added to the original experiments agenda when the comet was discovered in March 1973.
Feb. 8, 1974	<i>Skylab 4</i> splashed down in the Pacific Ocean at 11:17 a.m. after a mission lasting more than 84 days. The crew returned in good health. This mission concluded the program.
Mar. 5, 1974	Skylab program offices were closed down at NASA Headquarters and at the field centers.
1978	Although program officials had predicted that <i>Skylab's</i> orbit would not start to decay until 1983 when Shuttle would be available to assist it during reentry, data examined by NASA and the North American Air Defense Command (NORAD) indicated that decay and reentry would take place much sooner. Active ground control of <i>Skylab</i> in a low-drag attitude was initiated to extend the decay date.
Jan. 1979	NASA officials decided to attempt a form of drag modulation (the drag of the vehicle and its flight duration would be altered by ground control) to control <i>Skylab's</i> orbital decay and reentry position.
June 1979	The vehicle, becoming difficult to control, was placed in a more suitable attitude. Preparations for <i>Skylab's</i> reentry were coordinated among NASA, the Department of State, the Federal Preparedness Agency, DoD, and the Federal Aviation Administration. Studies were made of population distribution between 50° north and 50° south latitude and the predicted reentry footprints. It was determined that the ground controllers would lose their command of the spacecraft at an altitude of 130-139 kilometers, after which it would tumble and change its drag; to combat this the controllers would intentionally tumble <i>Skylab</i> at 139 kilometers. By so doing, the pieces of the vehicle left after reentry would have a better chance of landing in the ocean and not impacting a continent. In late June, NORAD predicted the reentry date as July 11. Impact could possibly take place near such major cities as Caracas, Lagos, Montreal, Rio de Janeiro, Tokyo, or Washington. But the trend in predictions was generally that the last revolution would be over the lowest population area of all.

Table 2-47. Chronology of Skylab Development and Operations (Continued)

Date	Event
July 11, 1979	Because predictions made at NORAD and MSFC at 12 hours before reentry put the impact point just off the east coast of North America, NASA delayed the reentry by 30 minutes by tumbling the spacecraft at 148 kilometers, which moved the target area to a long stretch over the Atlantic and Indian Oceans. Skylab overshot the target area, with pieces of debris falling into the Indian Ocean and Western Australia. The reentry footprint was a narrow band (approximately 4° wide), beginning at about 48° south, 87° east and ending at about 12° south, 144° east. No injuries or property damage was reported.

Table 2-48. *Skylab 1* Characteristics

Date of launch (ETR launch complex): May 14, 1973 (39A)		
Spacecraft/mission designation: Skylab 1		
Launch vehicle designation (class): SA-513 (Saturn V)		
Spacecraft weight (kg):	Apollo Telescope Mount	= 11 181
	Airlock Module	= 22 226
	Multiple Docking Adapter	= 6260
	Orbital Workshop	= 35 380
	Instrument Unit	= 2041
	Total	77 088
Spacecraft shape, dimensions (m):	Orbital Workshop:	cylindrical with 2 rectangular solar panels diameter, 6.58 length, 14.6 habitable volume, 295.26 cu m
	Airlock Module:	cylindrical diameter, 6.55 length, 5.36
	Multiple Docking Adapter:	cylindrical diameter, 3.05 length, 5.27 habitable volume, 32.33 cu m
	Apollo Telescope Mount:	octagonal with 4 solar arrays diameter, 3.35 height, 4.44
	Instrument Unit:	cylindrical diameter, 6.6 height, .914
Apogee/perigee at insertion (km): 431.5 × 433.7		
No. of orbits: 34 981		
Period: approx. 93 min.		
Reentry: July 11, 1979		
Length of mission: actively used 8 mos., 24 days (until Feb. 8, 1974) in orbit 6 yrs., 1 mo., 27 days (until July 11, 1979)		
Mission calendar (date, time):		
launch of Skylab workshop	May 14, 1973	1:30 p.m. EDT
launch of Skylab 2 crew	May 25, 1973	9:00 a.m. EDT
return of Skylab 2 crew	June 22, 1973	9:49:48 a.m. EDT
launch of Skylab 3 crew	July 28, 1973	7:10:50 a.m. EDT
return of Skylab 3 crew	Sept. 25, 1973	6:19:54 p.m. EDT
launch of Skylab 4 crew	Nov. 16, 1973	9:01:23 a.m. EST
return of Skylab 4 crew	Feb. 8, 1974	10:16:54 a.m. EST
reentry of Skylab workshop	July 11, 1979	11:37 a.m. EST

Table 2-48. *Skylab 1* Characteristics (Continued)

---

Distance traveled: 1.5 bill km

Earth reentry footprint: a narrow band (approx. 4° wide) beginning at about 48°S, 87°E and ending at about 12°S, 144°E, over the Indian O. and Western Australia (debris found between Esperance and Rawlinna, 31-34°S, 122-126°E)

Mission objectives: To place in earth orbit a laboratory to be visited by three Apollo crews. The program was established to determine man's ability to live and work in space for extended periods, to determine and evaluate man's physiological responses and aptitudes in a space environment and his post-flight adaption to the terrestrial environment, to extend the science of solar astronomy beyond the limits of earth-based observations, to develop improved techniques for surveying earth resources from space, and to expand knowledge in a variety of other scientific and technological regimes.

Results: The laboratory was placed in the desired orbit, but during launch the meteoroid shield was torn off, which led to one of the workshop solar panels being torn off and the second one becoming jammed. The result was an increased heat load inside the workshop. The first crew to visit Skylab erected a parasol to protect the workshop's exposed areas from direct sunlight. Three crews (nine astronauts) visited Skylab over the next nine months, staying from 28 to 84 days and conducting a wide range of scientific experiments. The crewmen did not suffer physically or psychologically from their long visits. See also tables 2-49 through 2-51).

---

Table 2-49. *Skylab 2* Characteristics

---

Date of launch (ETR launch complex): May 25, 1973 (39B)

Mission designation: Skylab 2

Spacecraft designation: SM-116  
CM-116

Launch vehicle designation (class): SA-206 (Saturn IB)

Spacecraft weight (kg): 19 982 (docked configuration, 88 054)

Spacecraft shape, dimensions (m): see tables 2-37 and 2-48 and fig. 2-6

Crew: Charles Conrad, Jr., Commander; Joseph P. Kerwin, Science Pilot; Paul J. Weitz, Pilot

Backup crew: Russell L. Schweikart, Commander; Story Musgrave, Science Pilot; Bruce McCandless, Pilot

Apogee/perigee at insertion (km): 357 × 156

No. of orbits: 404

Period: approx. 93 min.

Length of mission: 28 days, 49 min., 49 sec. (splashdown: June 22, 1973, 9:49 a.m.)

Distance traveled: 18.5 mill km

EVA time: 5 hr., 41 min.

Earth landing coordinates: 24°45'N, 127°2'W (Pacific O.)

Recovery ship: *USS Ticonderoga* (crew onboard in 40 min.)

Objectives and results: see table 2-48.

---

Table 2-50. *Skylab 3* Characteristics

---

Date of launch (ETR launch complex): July 28, 1973 (39B)  
 Mission designation: Skylab 3  
 Spacecraft designation: SM-117  
                                   CM-117  
 Launch vehicle designation (class): SA-207 (Saturn IB)  
 Spacecraft weight (kg): 20 124 (docked configuration, 87 597)  
 Spacecraft shape, dimensions (m): see tables 2-37 and 2-48 and fig. 2-6  
 Crew: Alan L. Bean, Commander; Owen K. Garriott, Science Pilot; Jack R. Lousma, Pilot  
 Backup crew: Vance D. Brand, Commander; William E. Lenoir, Science Pilot; Don L. Lind, Pilot  
 Apogee/perigee at insertion (km): 231.3 × 154.7  
 No. of orbits: 858  
 Period: approx. 93 min.  
 Length of mission: 59 days, 11 hrs., 9 min., 4 sec. (splashdown: Sept. 25, 1973, 6:20 p.m.)  
 Distance traveled: 39.4 mill km  
 EVA time: 13 hr., 44 min.  
 Earth landing coordinates: 30°47'N, 120°29'W (Pacific O.)  
 Recovery ship: *USS New Orleans* (crew onboard in 42 min.)  
 Objectives and results: see table 2-48.

---

Table 2-51. *Skylab 4* Characteristics

---

Date of launch (ETR launch complex): Nov. 16, 1973 (39B)  
 Mission designation: Skylab 4  
 Spacecraft designation: SM-118  
                                   CM-118  
 Launch vehicle designation (class): SA-208 (Saturn IB)  
 Spacecraft weight (kg): 20 850 (docked configuration, 87 126)  
 Spacecraft shape, dimensions (m): see tables 2-37 and 2-48 and fig. 2-6  
 Crew: Gerald P. Carr, Commander; Edward G. Gibson, Science Pilot; William R. Pogue, Pilot  
 Backup crew: Vance D. Brand, Commander; William E. Lenoir, Science Pilot; Don L. Land, Pilot  
 Apogee/perigee at insertion (km): 150.1 × 227.08  
 No. of orbits: 1214  
 Period: approx. 93 min.  
 Length of mission: 84 days, 1 hr., 16 min., (splashdown: Feb. 8, 1974, 11:17 a.m.)  
 Distance traveled: 55.5 mill km  
 EVA time: 22 hr., 21 min.  
 Earth landing coordinates: 31°18'N, 119°48'W (Pacific O.)  
 Recovery ship: *USS New Orleans* (crew onboard in 40 min.)  
 Objectives and results: see table 2-48.

---

Table 2-52. Skylab Experiments

No.	Experiment	Successful	Class	Skylab		
				1/2	3	4
D 008	Radiation in Spacecraft	X	Technology/Materials Processing	x	x	x
D 024	Thermal Control Coatings (Airlock Module)	X	Technology/Materials processing	x	x	x
ED 011	Atmospheric Absorption of Heat	X	Student	x		
ED 012	Volcanic Study	X	Student	x		
ED 021	Libration Clouds	X	Student			x
ED 022	Objects within Mercury's Orbit	X	Student	x		
ED 023	Ultraviolet from Quasars	X	Student	x		
ED 024	X-Ray Stellar Classes	X	Student			x
ED 025	X-Rays from Jupiter	N	Student		x	
ED 026	Ultraviolet from Pulsars	X	Student	x		
ED 031	Bacteria and Spores	X	Student	x		
ED 032	In-vitro Immunology	X	Student		x	
ED 041	Motor-Sensory Performance	X	Student			x
ED 052	Web Formation	X	Student		x	
ED 061	Plant Growth	X	Student			x
ED 062	Plant Phototropism	X	Student			x
ED 063	Cytoplasmic Streaming	N	Student		x	
ED 072	Capillary Study	P	Student			x
ED 074	Mass Measurement	X	Student		x	
ED 076	Neutron Analysis	X	Student	x	x	x
ED 078	Liquid Motion in Zero-g	N	Student			
M 071	Mineral Balance	X	Medical	x	x	x
M 073	Bio-Assay of Body Fluids	X	Medical	x	x	x
M 074	Specimen Mass Measurement	X	Medical	x	x	x
M 078	Bone Mineral Measurement	X	Medical	x	x	x
M 092	Lower Body Negative Pressure	X	Medical	x	x	x
M 093	Vectorcardiogram	X	Medical	x	x	x
M 111	Cytogenetic Studies of Blood	X	Medical	x	x	x
M 112	Man's Immunity In-vitro Aspects	X	Medical	x	x	x
M 113	Blood Volume and Red Cell Life Span	X	Medical	x	x	x
M 114	Red Blood Cell Metabolism	X	Medical	x	x	x
M 115	Special Hematologic Effects	X	Medical	x	x	x
M 131	Human Vestibular Function	X	Medical	x	x	
M 133	Sleep Monitoring Function	X	Medical	x	x	x
M 151	Time and Motion Study	X	Medical	x	x	x
M 171	Metabolic Activity	X	Medical	x	x	x
M 172	Body Mass Measurement	X	Medical	x	x	x
M 415	Thermal Control Coatings (Instrument Unit)	X	Technology/Materials Processing	x		
M 479	Zero-g Flammability	X	Technology/Materials Processing			x
M 487	Habitability/Crew Quarters	X	Crew Operations	x	x	x
M 509	Astronaut Maneuvering Equipment	X	Crew Operations	x	x	x
M 512	Materials Processing Facility	X	Technology/Materials Processing	x	x	x
M 516	Crew Activities/Maintenance Study	X	Crew Operations	x	x	x
M 518	Multipurpose Furnace System	X	Technology/Materials Processing			x
M 551	Metals Melting	X	Technology/Materials Processing	x		



Table 2-52. Skylab Experiments (Continued)

No.	Experiment	Successful	Class	Skylab		
				1/2	3	4
M 552	Exothermic Brazing	X	Technology/Materials Processing	x		
M 553	Sphere Forming	P	Technology/Materials Processing	x		
M 555	Gallium Arsenide Crystal Growth	X	Technology/Materials Processing	x		
M 556	Vapor Growth of II-VI Compounds	X	Technology/Materials Processing		x	x
M 557	Immiscible Alloy Composition	X	Technology/Materials Processing		x	x
M 558	Radioactive Tracer Diffusion	X	Technology/Materials Processing		x	
M 559	Microsegregation in Germanium	X	Technology/Materials Processing		x	
M 560	Growth of Spherical Crystals	X	Technology/Materials Processing		x	x
M 561	Whisker-Reinforced Composites	X	Technology/Materials Processing		x	x
M 562	Indium Antimonide Crystals	X	Technology/Materials Processing		x	x
M 563	Mixed III-V Crystal Growth	X	Technology/Materials Processing		x	x
M 564	Metal and Halide Eutectics	X	Technology/Materials Processing		x	
M 565	Silver Grids Melted in Space	X	Technology/Materials Processing		x	
M 566	Copper-Aluminum Eutectic	X	Technology/Materials Processing		x	x
S 009	Nuclear Emulsion	X	Scientific	x		
S 015	Zero-g Single Human Cells	X	Biology		x	
S 019	Ultraviolet Stellar Astronomy	X	Scientific	x		
S 020	Ultraviolet X-Ray Photography	X	Solar Physics	x	x	x
S 052	White Light Coronagraph	X	ATM Solar	x	x	x
S 054	X-Ray Spectrographic Telescope	X	ATM Solar	x	x	x
S 055	Ultraviolet Spectrometer	X	ATM Solar	x	x	x
S 056	Dual X-Ray Telescope	X	ATM Solar	x	x	x
S 063	Ultraviolet Airglow Horizon Photography	X	Solar Physics	x	x	x
S 071	Circadian Rhythm - Pocket Mice	N	Biology		x	
S 072	Circadian Rhythm - Vinegar Gnat	N	Biology		x	
S 082	Ultraviolet Spectrograph/Heliograph	X	ATM Solar	x	x	x
S 149	Particle Collection	X	Solar Physics	x	x	x
S 150	Galactic X-Ray Mapping	P	Solar Physics			x
S 183	Ultraviolet Panorama	X	Solar Physics	x		
S 190A	Multispectral Photographic Facility	X	Earth resources	x	x	x
S 190B	Earth Terrain Camera	X	Earth Resources	x	x	x
S 191	Infrared Spectrometer	X	Earth Resources	x	x	x
S 192	Multispectral Scanner	X	Earth Resources	x	x	x
S 193	Microwave Radiometer/Scatterometer, Altimeter	X	Earth Resources	x	x	x
S 194	L-Band Radiometer	X	Earth Resources	x		

Table 2-52. Skylab Experiments (Continued)

No.	Experiment	Successful	Class	Skylab		
				1/2	3	4
S 228	Trans-Uranic Cosmic Rays	X	Solar Physics	x		x
S 230	Magnetospheric Particle Composition	X	Solar Physics		x	x
T 003	Inflight Aerosol Analysis	X	Technology/Materials Processing	x	x	x
T 013	Crew/Vehicle Disturbance	X	Crew Operations		x	x
T 020	Foot-Controlled Maneuvering Unit	X	Crew Operations		x	x
T 025	Coronagraph Contamination Measurement	X	Technology/Materials Processing	x	x	x
T 027	ATM Contamination Measurement	X	Technology/Materials Processing	x		

### Apollo-Soyuz Test Project

Competition between the U.S. and the USSR served as a catalyst for NASA's early spaceflight program. Explorer followed Sputnik; Mercury followed Vostok; Glenn followed Gagarin. So it went through the first decade of the space age. But in 1968, three Apollo astronauts orbited the moon, and they were neither preceded nor followed by Soviet cosmonauts. Observers still argue over the existence of a genuine race to the moon, but *Apollo 11's* landing in 1969 captured the lunar "prize" for the U.S.

On their way to meet the *Apollo 11* astronauts after their return from the moon, NASA Administrator Thomas O. Paine urged President Nixon to consider the desirability of a new era of technical cooperation with the Soviet Union, marked by a joint U.S.-USSR space venture. Paine believed that the "time had come for NASA to stop waving the Russian flag and to begin to justify our programs on a more fundamental basis than competition with the Soviets."<sup>9</sup> Cooperation with the Soviets was an intriguing alternative, according to the NASA administrator. Nixon encouraged Paine to pursue the idea.

Paine's formal contacts with the USSR were made through Mstislav V. Keldysh, president of the Soviet Academy of Sciences, who responded cautiously but favorably. Official correspondence begun in April 1969 between Paine and Keldysh led to meetings on a technical level between American and Soviet engineers in Moscow in October 1970. These early discussions explored the possibility of a joint earth-orbital mission, with emphasis on spacecraft docking systems, and identified areas of concern that would be addressed by technical working groups during compatibility talks planned for the near future. During their third round of joint meetings in November 1971, the two sides declared that a "test mission appears technically feasible and desirable" in 1975, using Apollo and Salyut (later changed to Soyuz) spacecraft. Official agreement between the two countries came on May 24, 1972, when President Nixon and Premier Aleksey N. Kosygin signed a five-year "Agreement Concerning Cooperation in the Exploration and Use of Outer Space for Peaceful Purposes."<sup>10</sup>

Five years of technical cooperation among engineers working in six formal

working groups (see table 2-53) in Houston and Moscow led to the development of a unique piece of hardware—an international docking module—and agreement on mission operations, flight control, means for life support, communications and tracking, safety, and crew procedures.<sup>11</sup> Astronauts and cosmonauts trained together in preparation for two days of joint activities on their docked spacecraft, each group becoming familiar with the other's spacecraft, flight procedures, and language. The docking module, which would be carried aloft with the Apollo command and service module, would serve as the transfer tunnel for the two crews (see figs. 2-7 and 2-8).

*Soyuz 19*, with Alexei A. Leonov and Valeriy N. Kubasov aboard, left its launch pad at Baykonur on schedule on July 15, 1975. Hours later Thomas P. Stafford, Vance D. Brand, and Donald K. Slayton in Apollo CSM 111 were launched to meet them by a Saturn IB from the Eastern Test Range in Florida. Two days later, the two crews began their joint exercises, with the first of two dockings taking place on the morning (EDT) of July 17. At 2:17 p.m., Commanders Stafford and Leonov met face to face in the docking module joining their ships. After a little less than two days of joint activities, Apollo and Soyuz separated, with Soyuz landing on July 21 and Apollo on July 24 (see table 2-54).

Unofficially, the participants of the Apollo-Soyuz Test Project had hoped they were taking a first step in designing a truly international docking adapter and that other joint activities would follow the joint mission. Increasingly cool relations between the two countries, however, prevented further close cooperation among the technicians, engineers, and crews that had learned to work together. Despite criticism that labeled ASTP a political sideshow and a technology give-away, the project demonstrated that the two superpowers could work together and that two unlike technological products—Apollo and Soyuz—could be made compatible.

Table 2-53. ASTP Joint Working Groups

---

Working Group O—Technical Project Directors
Glynn S. Lunney, U.S.
Konstantin D. Bushuyev, USSR
Working Group 1—Rendezvous Methods and Compatibility
M. Pete Frank, U.S.
Valentin N. Bobkov, USSR
Working Group 2, Guidance and Control
H. E. Smith, U.S.
Viktor P. Legostayev, USSR
Working Group 3, Docking Module
Robert D. White, U.S.
Vladimir S. Syromyatnikov, USSR
Working Group 4, Communications and Tracking
R. H. Dietz, U.S.
Boris V. Nikitin, USSR
Working Group 5, Environmental Control and Crew Systems
R. E. Smylie, U.S.
Ilya V. Lavrov, USSR
Astronaut-Cosmonaut Training
Robert F. Overmeyer, U.S.
Vladimir A. Shatalov, USSR

---

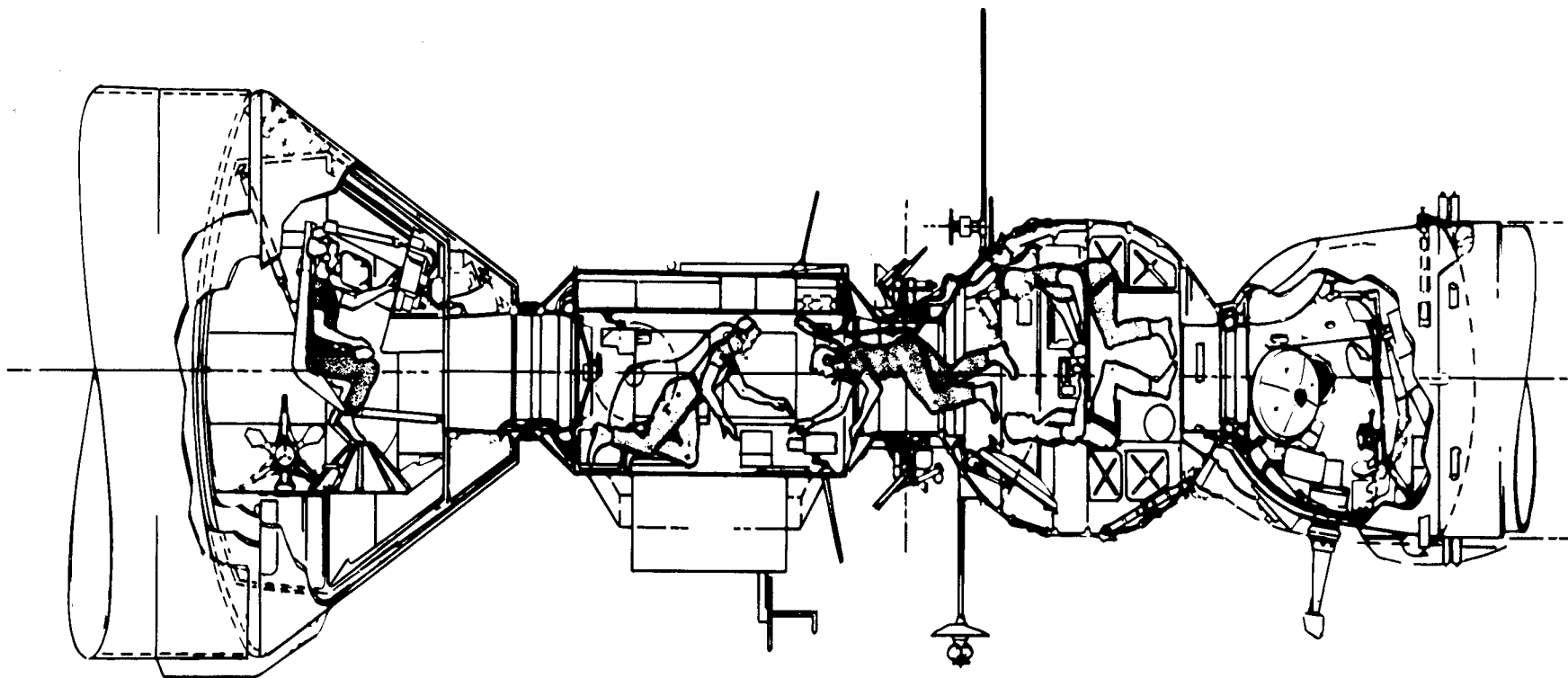

Figure 2-7. ASTP Crew Transfer (Apollo on the left, Soyuz on the right)

Source: JSC, "Apollo Soyuz Mission Evaluation Report," JSC-10607, Dec. 1975, p. A-16.

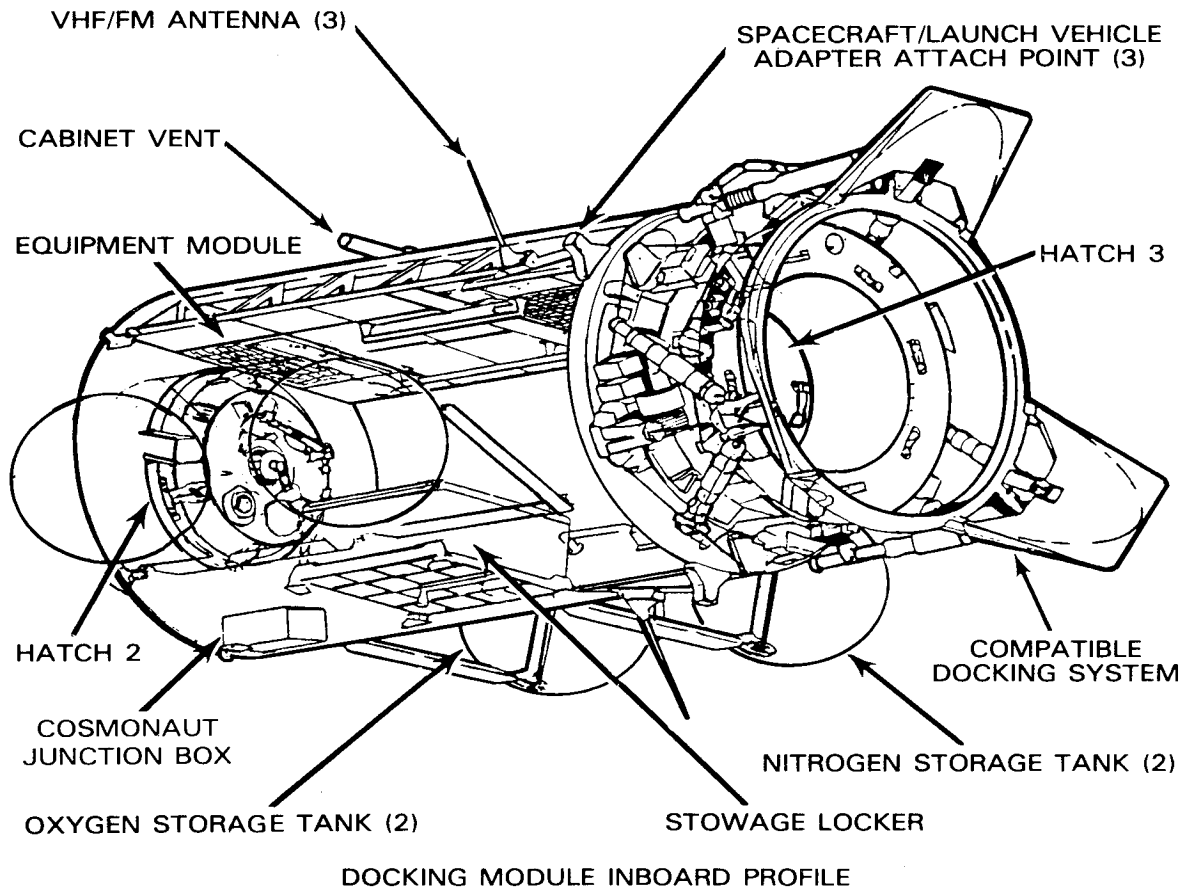

Figure 2-8. ASTP Docking Module, a unique piece of hardware designed by a joint team of American and Soviet engineers

Source: JSC, "Apollo Soyuz Mission Evaluation Report," JSC-10607, Dec. 1975, p. A-7.

Table 2-54. Apollo-Soyuz Test Project  
(Apollo) Characteristics

---

Date of launch (ETR launch complex #1):	July 15, 1975 (39B)
Official mission designation:	Apollo Soyuz Test Project (ASTP)
Spacecraft designation:	SM-111 CM-111
Launch vehicle designation (class):	SA-210 (Saturn 1B)
Spacecraft weight (kg):	CSM, 12 904 DM, 2006 Apollo-Soyuz docked, 20 977
Spacecraft shape, dimensions (m):	see table 2-37 for CSM DM: cylindrical length, 3.15 max. diameter, 1.4
Crew:	Thomas P. Stafford, Commander; Donald K. Slayton, DM Pilot; Vance D. Brand, CM Pilot
Backup crew:	Alan L. Bean, Commander; Ronald E. Evans, CM Pilot; Jack R. Lousma, CM Pilot
Apogee/perigee at insertion (km):	186.3 × 221.9
No. of orbits:	138
Period:	89 min.
Length of Apollo flight:	217:28:23 (9 + days)

Table 2-54. Apollo-Soyuz Test Project (Apollo) Characteristics (Continued)

Length of Soyuz flight: 142:30:54 (5 + days)

Length of joint mission: 224:58:24 (9 + days)

Time docked: 44:24:30; time spent by Soyuz crew inside Apollo: Leonov, 5:43, Kubasov, 4:59; time spent by Apollo crew inside Soyuz: Stafford, 7:10, Brand, 6:30, Slayton, 1:35

Mission events (date, time, Apollo ground elapsed time):

Soyuz launch	July 15 8:20:00 a.m. EDT	-07:30:01
Apollo launch	3:50:01 p.m.	00:00:00
earth orbit insertion	3:59:56	00:09:55
begin joint flight exercises	July 17 11:34:23 a.m.	43:44:22
1st docking	July 17 12:09:09 p.m.	44:19:08
1st undocking	July 19 8:03:20 a.m.	88:13:19
2d docking	8:33:39	88:43:38
final undocking	11:26:12	91:36:11
Apollo separation from Soyuz	2:42:27 p.m.	94:52:26
Soyuz landing	July 21 6:50:54 a.m.	135:00:53
DM jettison	July 23 3:47:00 p.m.	191:56:59
deorbit maneuver	July 24 4:37:47 p.m.	216:47:46
reentry	4:57:47	217:30:46
splashdown	5:18:24	217:28:23

Earth landing coordinates (Apollo): 163°W, 22°N (Pacific O.)

Recovery ship: *USS New Orleans* (crew onboard in 41 min.)

Mission objectives: To accomplish spacecraft rendezvous, docking, and undocking of spacecraft from two countries; demonstrate a jointly designed (American-Soviet) androgynous docking system; demonstrate crew transfer and interaction of crews and control centers.

Results: All joint activities and unilateral scientific experiments were accomplished as planned. During descent and landing, the Apollo crew inhaled nitrogen tetroxide fumes, which caused coughing and eye irritation. The crew failed to activate two earth landing system switches at the proper time (9000 m); when the manual switches were hit (7000 m) the cabin was flooded with noxious gas from the CM's reaction control system thrusters, which were working vigorously to counteract the swaying motion caused by the manual deployment of the drogue chutes. CM Pilot Brand was unconscious for a brief time. The crew recovered once they began breathing pure oxygen; however, they were hospitalized in Honolulu for treatment and observation for two weeks.

Reference: NASA Hq., "Apollo/Soyuz Test Project Post Mission Operation Report," M-966,75-01, Aug. 15, 1975; and JSC, "Request for Homologation of World Records for Group Flight," submitted to National Aeronautics Association Federation Aeronautique Internationale, n.d.

Table 2-55. Apollo Soyuz Test Project Experiments

No.	Experiment	Joint	Space Science	Earth Environment	Life Science	Applications
AR 002	Microbial exchange	x			x	
MA 007	Stratospheric aerosol measurement			x		
MA 010	Multipurpose electric furnace					x
MA 011	Electrophoresis technical experiment system	x			x	
MA 014	Electrophoresis				x	
MA 028	Crystal growth					x
MA 031	Cellular immune response				x	
MA 032	Polymorphonuclear leukocyte response				x	
MA 041	Surface-tension-induced convection					x
MA 044	Monotectic and syntectic alloys					x
MA 048	Soft x-ray		x			
MA 059	Ultraviolet absorption	x		x		
MA 060	Interface marking in crystals					x
MA 070	Processing of magnets					x
MA 083	Extreme ultraviolet survey		x			
MA 085	Crystal growth from the vapor phase					x
MA 088	Helium glow detector		x			
MA 089	Doppler tracking			x		
MA 106	Light flash				x	
MA 107	Biostack				x	
MA 128	Geodynamics			x		
MA 131	Holide eutectics					x
MA 136	Earth observations and photography			x		
MA 147	Zone-forming fungi	x			x	
MA 148	Artificial solar eclipse	x	x			
MA 150	USSR multiple material melting	x				x
MA 151	Crystal activation		x			
MA 161	Killifish hatching and orientation				x	

### Space Transportation System Shuttle Orbiter

When President Richard M. Nixon's Space Task Group asked the space agency to enumerate its goals for the future, NASA officials placed a reusable spacecraft high on its list. Engineers at NASA's field centers and at private companies had long been studying the feasibility of a vehicle that could be boosted into orbit by a reusable launch vehicle and return to earth like an airplane, ready to be used again with only limited refurbishing. NASA hoped to develop a system for orbital operations "with emphasis upon the critical factors of: (1) commonality, (2) reusability, and (3) economy." Space station modules and an earth-to-orbit shuttle that could ferry crews and supplies to orbiting stations were the two major components of this system. According to the Space Task Group report to Nixon, a Space Transporta-

tion System would "carry passengers, supplies, rocket fuel, other spacecraft, equipment, or additional rocket stages to and from orbit on a routine aircraft-like basis."<sup>12</sup> Limited budgets, however, would not allow NASA to proceed with the entire Space Transportation System. President Nixon approved the development of the space Shuttle half of the plan on January 5, 1972, largely because the new program promised to be "economically sustainable." Shuttle vehicles would be designed to fly at least 100 missions, a decided advantage over the expendable Apollo generation. The development of a large space station was not approved. Shuttle crews would have to perform more modest tasks in the beginning.

For reasons of economy, the Space Shuttle Task Force led by Charles J. Donlan (1970–1972) had rejected early ideas for a delta-wing craft perched on a much larger winged launch vehicle, which would itself be capable of flying back to the launch site. NASA limited its vision to smaller shuttle craft sent to orbit by a combination of its own main engines and expendable or partly expendable boosters. Fully reusable launch systems were put on hold (see figs. 2–9 through 2–11). Five aerospace companies had been conducting studies for NASA since 1969 to determine the most practical approach to shuttle design: Lockheed Missiles & Space Company, North American Rockwell Corporation, General Dynamics Corporation, Martin Marietta Corporation, and McDonnell Douglas Astronautics Company.\* In May 1970, NASA awarded North American Rockwell and General Dynamics, working together as a spacecraft-launch vehicle team, an 11-month contract to define more fully their shuttle concept. McDonnell Douglas and Martin Marietta were chosen to submit a competitive design.\*\* NASA's contactors spent the next 18 months refining their designs and adjusting their ideas to more realistic budgets and flight schedules. Shortly after receiving Nixon's imprimatur, the agency was ready with a request for proposals for the development and fabrication of a Shuttle orbiter. Four companies responded to the March 1972 request; Rockwell, McDonnell Douglas, Grumman Aerospace Corporation, and Lockheed delivered their proposals to the Manned Spacecraft Center in Houston on May 12.

NASA had already awarded Rocketdyne, a division of General Dynamics, a letter contract for the orbiter's main engine and had announced the selection of contractors for many Shuttle subsystems before it named the prime contractor. On July 25, 1972, it was announced that North American Rockwell (later named Rockwell International) would be responsible for the design, development, and production of the orbiter. The value of the contract, which was awarded on August 9, was estimated at \$2.6 billion over the next six years. NASA managers expected the first manned orbital flight of Shuttle to take place in 1978 and looked forward to a total of 445 flights during the first 11 years of operations.† The first orbiter, to be used for horizontal flight testing, was due in mid-1976.

Rockwell International began the structural assembly of Orbiter 101 in mid-1974 and Orbiter 102 in late 1975. Rockwell's work was overseen by the Shuttle Program Office at NASA Headquarters, directed by Myron S. Malkin (1973–1978),

---

\* Martin Marietta's initial work was conducted in-house, not funded by NASA.

\*\* Also chosen to conduct feasibility studies of alternate shuttle designs were Grumman Aerospace Corporation-Boeing Company, Lockheed, and Chrysler Corporation.

† The flight schedule released on April 2, 1973, by NASA Headquarters predicted 6 flights in 1978, 15 in 1979, 24 in 1980, 32 in 1981, 40 in 1982, 60 annually from 1983 through 1987, and 28 in 1988.



and by the Johnson Space Center (formerly the Manned Spacecraft Center). The first orbiter, named *Enterprise*, was rolled out of Rockwell's Palmdale, California, factory bay doors on September 17, 1976. *Enterprise* was not built for space operations; it was a test article only, designed for use during a critical series of approach

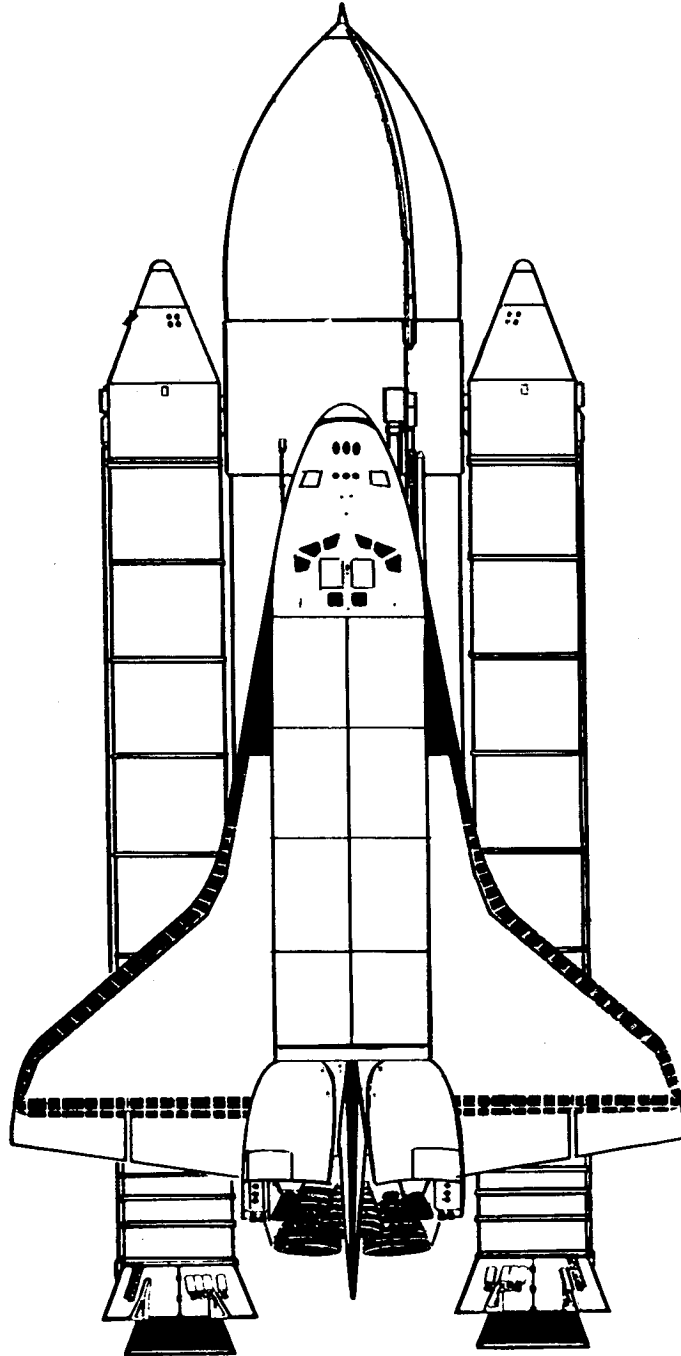
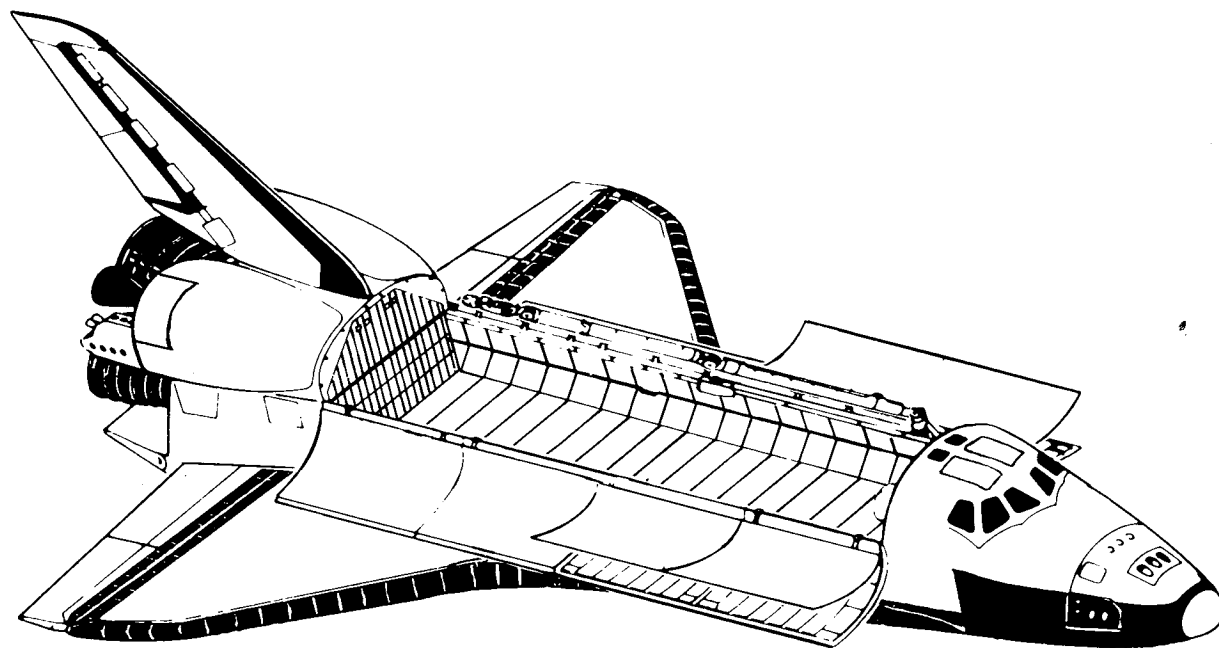

Figure 2-9. The final design chosen for Shuttle included the orbiter, two reusable solid rocket boosters, and an external tank that would supply fuel to the orbiter's main engines. The 68 000-kilogram (dry weight) orbiter measured 23.79 meters at wingspan, was 37.2 meters in length, and 17.27 meters tall (vertical tail to landing gear). At launch, the orbiter would be strapped to the large (47 meters tall) external tank. For more information on the solid rocket boosters, see chapter 1. The orbiter's three engines were designed to deliver a total thrust of 5 004 000 newtons.



*Figure 2-10. The orbiter's most practical feature for the prospective user was its cargo bay, designed to deliver payloads up to 29 484 kilograms to near-earth orbit. The bay measured 4.57 meters in diameter and 18 meters in length. On return trips, Shuttle could accommodate cargo weighing 14 515 kilograms. The most popular payloads planned for Shuttle were satellites and Spacelab, a manned scientific laboratory being built under the direction of the European Space Agency (formerly the European Space Research Organization).*

and landing tests. The main engines and the orbital maneuvering system and reaction control system propulsion units were simulated. Other subsystems not needed for atmospheric tests, such as the waste management system and the thermal protection system, were also not included on Orbiter 101.<sup>13</sup> *Enterprise* would be strapped to the back of a modified Boeing 747 (called the Shuttle Carrier Aircraft) and flown about, first in a captive mode to verify performance of the two vehicles in mated flights, crew procedures, and systems operations. The first of five inert captive flight tests were performed on February 18, 1977; the first of three manned captive active tests took place on June 18. With the captive tests successfully completed, crewmen Fred W. Haise, Jr., Charles G. Fullerton, Joe H. Engle, and Richard H. Truly prepared for the free-flight tests.

*Enterprise* would be released from the 747 at an altitude of approximately 5000 meters above Edwards Air Force Base (see figure 2-12). The two-man crew would land the ship on the Rogers Dry Lake bed. Approach and landing tests, the first of which was flown on August 12, 1977, allowed the crew to test the craft's aerodynamic qualities, build operational confidence, and confirm the orbiter's capability to approach safely and land in several weight and center-of-gravity configurations, manually and automatically. Five two-minute flights were conducted, all successfully. During the last test on October 26, *Enterprise* landed on a hard-surface runway for the first time, simulating the conditions crews returning from space could expect. NASA and Rockwell were satisfied with the results and sent Orbiter 101 to the Marshall Space Flight Center for a year-long series of ground vibra-

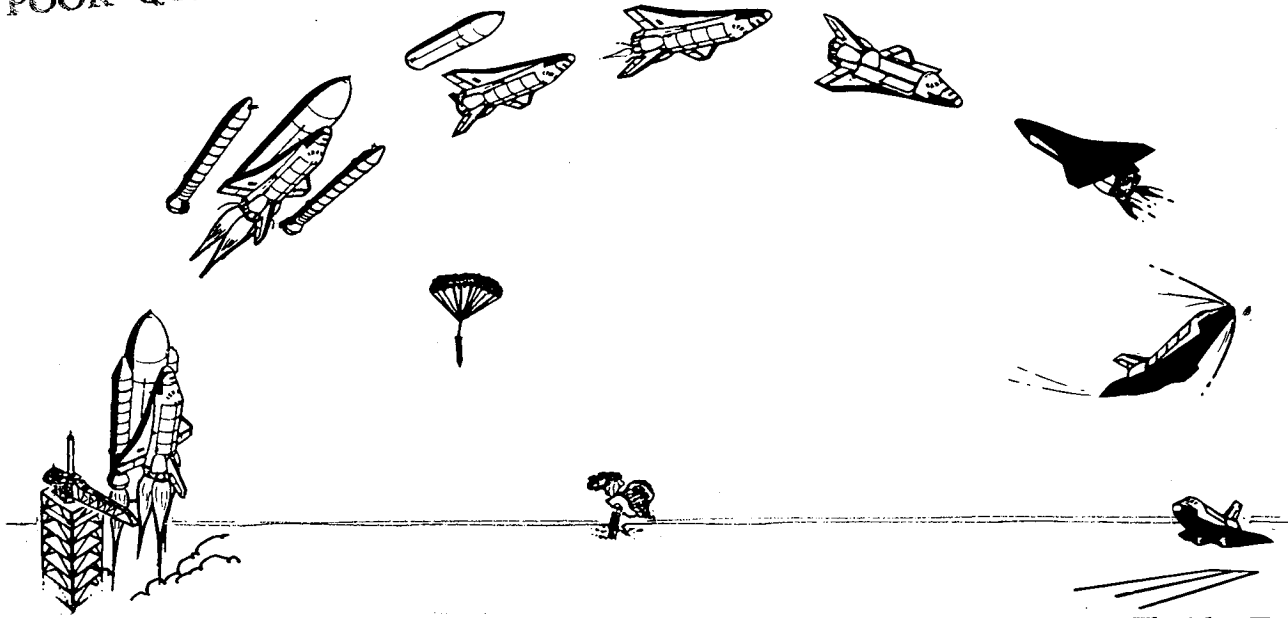

Figure 2-11. Shuttle's primary launch site would be the Kennedy Space Center in Florida. Two minutes after launch at an altitude of 44 kilometers, the spent solid rocket boosters would be separated from the orbiter. Eight minutes later at 109 kilometers, the external tank would be ejected. In orbit, the shuttle crew would perform their typical seven-day mission in a shirtsleeves environment, delivering satellites into the desired orbit, inspecting and repairing others, retrieving others for shipment back to earth. At reentry, the unpowered orbiter would glide to earth and land on a runway like an airplane at speeds of 343 to 363 kilometers per hour. The primary touchdown site would be the Edwards Air Force Base in the California desert.

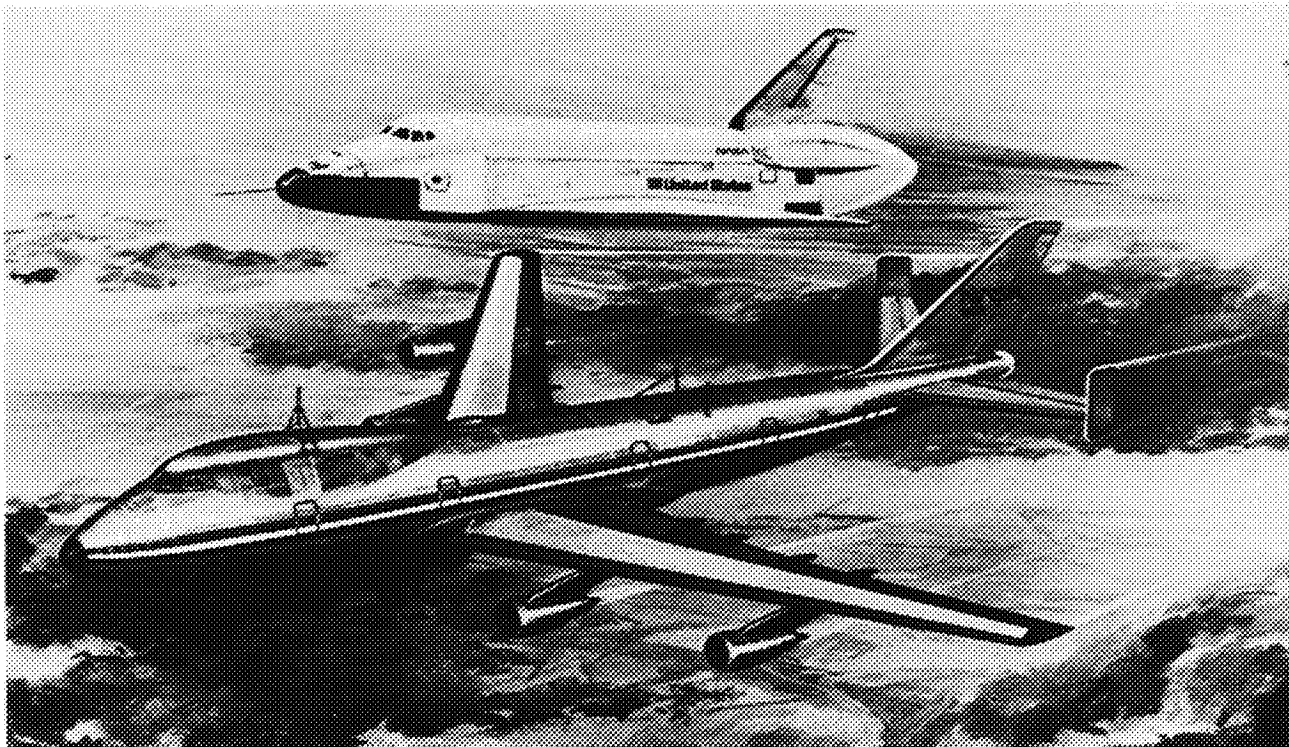

Figure 2-12. Enterprise separates from its carrier aircraft during approach and landing tests.

tion tests (see table 2-56 for a list of Shuttle Orbiter 101 flight tests).\* At Palmdale, work continued on Orbiter 102.

As late as the winter of 1978, NASA was still hopeful that the second orbiter would be ready for orbital flight in 1979 (see figures 2-13 and 2-14). Unfortunately, *Columbia* and her crew would not be placed in service until April 1981. Qualifying the vehicle for spaceflight proved to be a more time-consuming process than the experts at NASA and its contractors had predicted. In 1979, the first flight was rescheduled for late 1980. In 1980, the date was set back to the spring of 1981 (see table 2-57 for a chronology of Shuttle orbiter development and operations).

\* Marshall was also assigned management authority for the orbiter main engines, the solid rocket boosters, and the external tank.

Table 2-56. Shuttle Orbiter 101 Flight Tests, 1977

Date	Test	Crew	Duration*	Max. Speed (kph)	Max. Altitude (m)†
Feb. 15	Taxi tests (3)				NA
Feb. 18	Inert captive		2:05:00	462	4877
Feb. 22	Inert captive		3:13:00	528	6888
Feb. 25	Inert captive		2:28:00	684	8108
Feb. 28	Inert captive		2:11:00	684	8707
March 2	Inert captive		1:39:00	763	9144
June 18	Manned active captive	Haise Fullerton	0:55:46	335	4562
June 28	Manned active captive	Engle Truly	1:02:00	499	6714
July 26	Manned active captive	Haise Fullerton	0:59:53	502	8532
Aug. 12	Free flight approach & landing (tail cone on)	Haise Fullerton	0:05:22	500	8534
Sept. 13	Free flight approach & landing (tail cone on)	Engle Truly	0:05:31	556	7315
Sept. 23	Free flight approach & landing (tail cone on)	Haise Fullerton	0:05:34	463	6523
Oct. 12	Free flight approach & landing (simulated engines)	Engle Truly	0:02:34	445	6259
Oct. 26	Free flight approach & landing (simulated engines)	Haise Fullerton	0:02:02	454	6066

\* For free flight approach and landing tests, duration is time of actual free flight, from separation to main touchdown.

† For free flight approach and landing tests, maximum altitude is considered to be the altitude at separation; the combined vehicles reached a higher altitude.

# Space Shuttle Development Plan

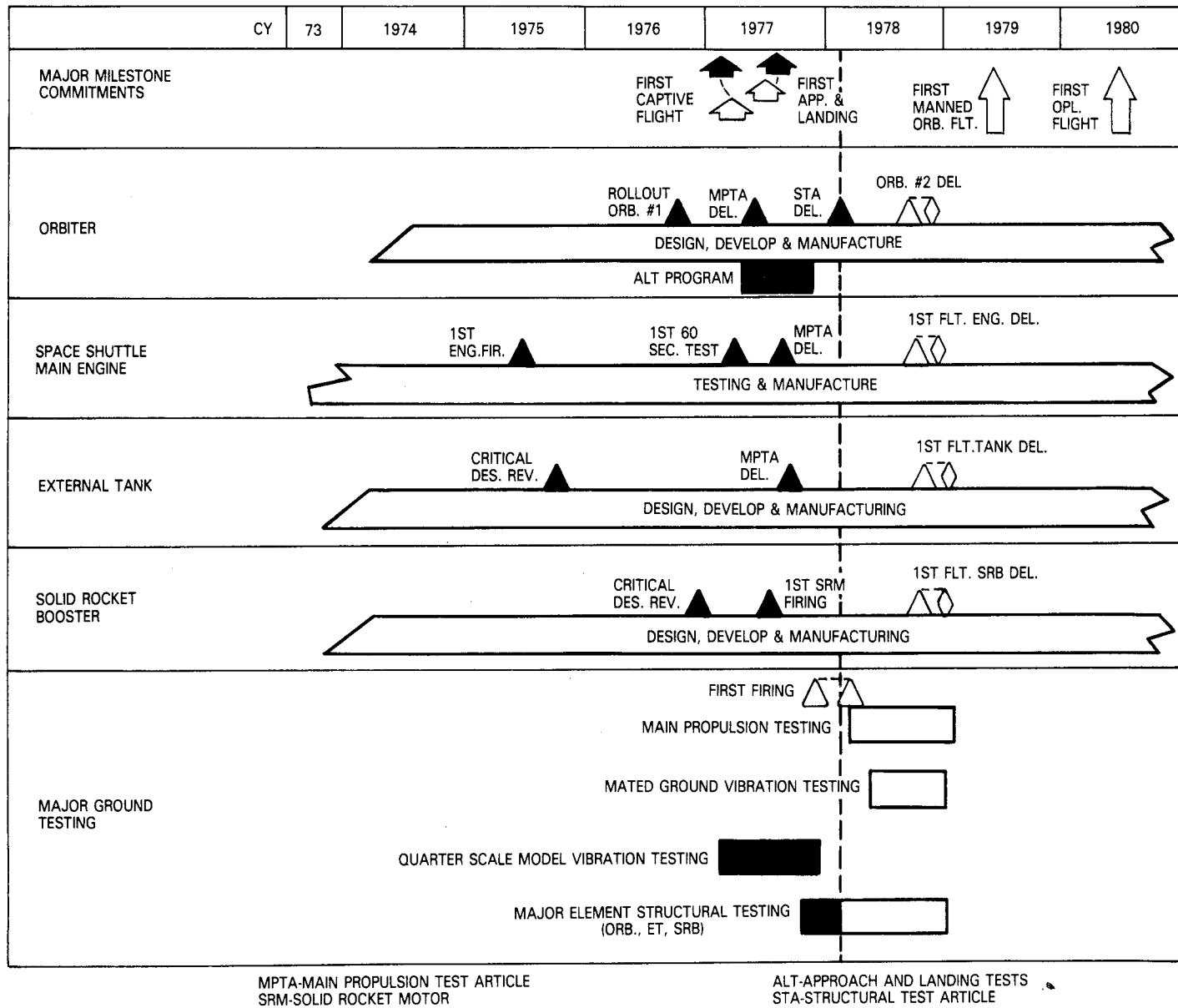

MANNED SPACEFLIGHT

Figure 2-13. NASA managers in 1978 were planning for Shuttle's first orbital flight to take place in 1979.

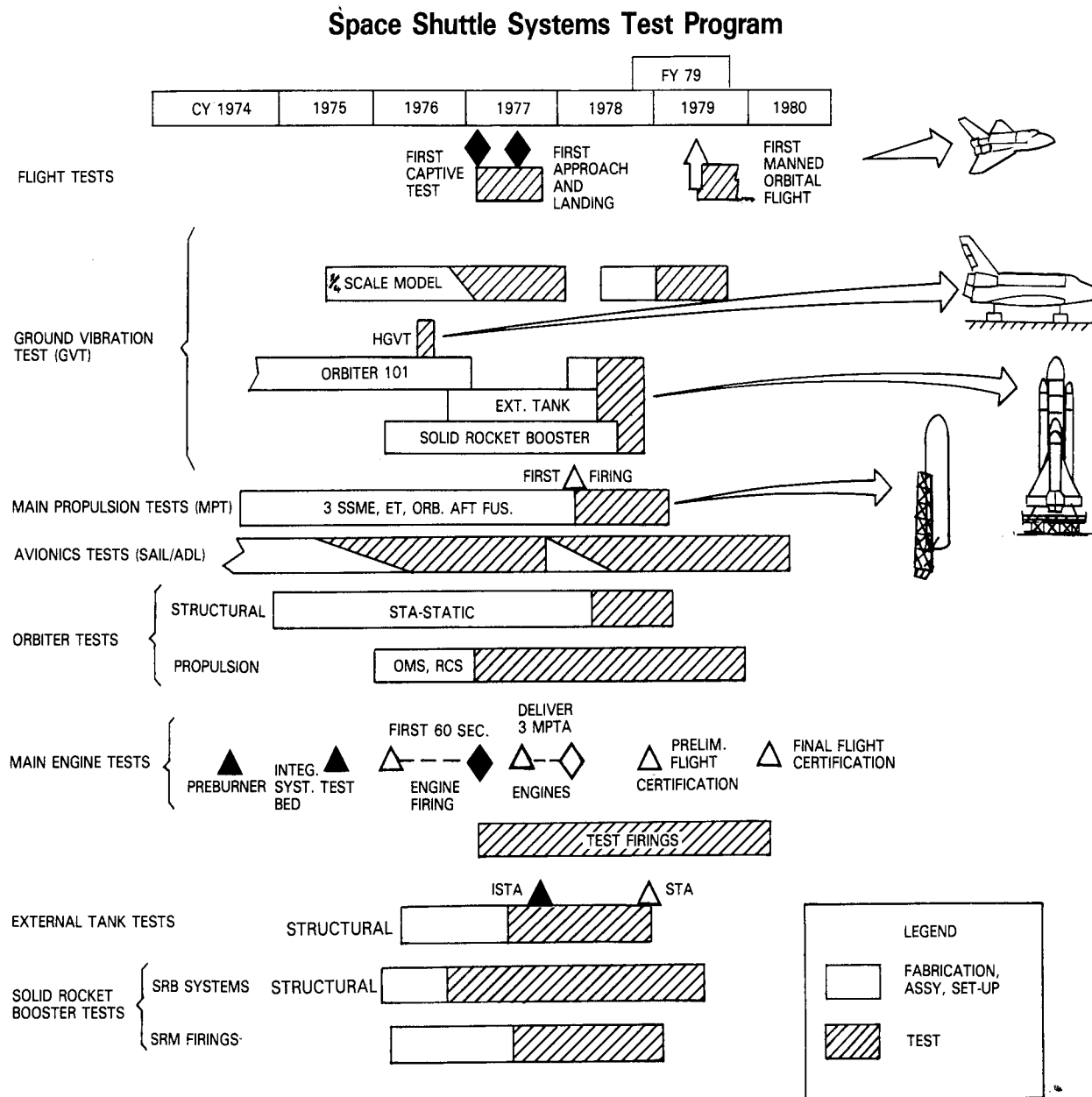

Figure 2-14. This schedule shows how managers were planning in 1978 for Shuttle's first orbital flight.

Table 2-57. Chronology of Shuttle Orbiter Development and Operations\*

1962-1963	NASA sponsored three studies of reusable spacecraft: North American Aviation (NAA) and Boeing studied the feasibility of reusable launcher vehicles capable of carrying 90 000 kg to earth orbit; Lockheed Missiles & Space studied recoverable 10-passenger orbital transporters.
1965	Lockheed and General Dynamics (GD) submitted a joint study to NASA of reusable orbital shuttles.
1966	Martin Marietta concluded a study for NASA on a reusable spacecraft design.
1966-1968	NASA conducted its own study of a fully reusable two-stage transporter.
Feb. 1968	NASA officials told members of Congress of their interest in a reusable spacecraft-launch vehicle system.
Jan. 1969	NASA awarded four nine-month contracts (phase A) for studies of an Integral Launch and Reentry Vehicle (ILRV): Lockheed, General Dynamics (GD), McDonnell Douglas, and North American Rockwell (NR). Reports were received in November.
Feb. 1969	The Manned Spacecraft Center (MSC) began an in-house study of a straight-wing, two-stage, fully reusable shuttle.
Apr. 1969	NASA and the Department of Defense (DoD) began a three-month joint study of how an earth orbital shuttle would serve the needs of both agencies. In June, the two organizations endorsed the idea of sharing the same design. In February 1970, a joint NASA-USAF committee was established.
Apr. 5, 1969	NASA Hq. established a Space Shuttle Task Group in the Office of Manned Space Flight (OMSF).
Sept. 1, 1969	President Nixon's Space Task Group, which was established to advise the President on space program goals for the next decade, recommended funding for a reusable shuttle craft to be operational by 1975-1977. Funding for a space station, the other half of an ambitious Space Transportation System that NASA wanted to implement during the next 10 years, was not approved.
Feb. 18, 1970	NASA issued a request for proposals (RFP) for phase B Shuttle definition studies, due in March. NR teamed with American Airlines and McDonnell Douglas with TRW to conduct their 11-month studies under phase B funding.
March 1970	NASA Hq. established a Shuttle Program Office within OMSF.
June 1970	NASA announced that it would also be funding 11-month studies on alternate Shuttle designs. Contractors chosen were Grumman with Boeing; Lockheed; and Chrysler. TRW received a contract for an auxiliary propulsion system definition study.
July 1970	The Langley Research Center (LRC) awarded a contract to McDonnell Douglas for the study of the cost of a Shuttle reentry thermal protection system, and the Marshall Space Flight Center (MSFC) and MSC chose the same contractor to study high and low pressure auxiliary propulsion systems.
Dec. 11, 1970	NASA held a mid-term review to assess the studies being conducted by NR and McDonnell Douglas.
Jan. 5, 1971	President Nixon officially endorsed the development of Shuttle.
Jan. 19-20, 1971	Of the designs under study, NASA officials determined the desirability of a delta-wing designed to accommodate 29 000 kg.
Feb. 1971	Boeing proposed an externally mounted H <sub>2</sub> tank for the Shuttle orbiter. This feature was incorporated into the phase B and phase A alternate studies under way.
March 1, 1971	NASA's Mississippi Test Facility was named as the test site for testing the Shuttle main engines; Saturn facilities would be modified for the Shuttle tests. NASA issued RFP's to Aerojet Liquid Rocket Company, Pratt & Whitney, and Rocketdyne for Shuttle main engine development.
May 17, 1971	MSC issued an RFP for a Shuttle thermal protection system.
June 10, 1971	It was announced that MSC had overall responsibility for the Shuttle program; MSFC was assigned the booster stages and the main engine; KSC was responsible for designing the launch and recovery facilities.

Table 2-57. Chronology of Shuttle Orbiter Development and Operations\* (Continued)

June 16, 1971	Primarily for budget reasons, NASA announced that it would adopt a phased approach to Shuttle development. A fly-back booster for the orbiter would be postponed in favor of an interim conventional booster system. The phase B and alternate studies were extended to take this phased approach into consideration.
July 12, 1971	MSFC announced that Rocketdyne had been selected as designer and fabricator of 35 Shuttle main engines.
July 14, 1971	McDonnell Douglas, General Electric, and Lockheed received contracts for the development and testing of a ceramic insulator for Shuttle thermal protection. NR was awarded a feasibility study contract to examine a low-cost, reusable chemical stage for the Shuttle booster.
Aug. 1971	NASA adopted the external tank configuration for the orbiter, with reentry protection to be provided by an ablative thermal protection system.
Aug. 3, 1971	Pratt & Whitney requested an investigation by the General Accounting Office (GAO) of NASA's selection of Rocketdyne as builder of the Shuttle main engine. NASA's definitive contract to Rocketdyne was held pending the investigation; an interim 4-month contract was signed in September, with extensions granted in February and March 1972.
Sept. 1971	Phase B contractors presented their mid-term study results: Boeing—reusable Saturn V first stage with added tail, wings, and crew compartment with attached Grumman orbiter (44 m long, 27-m wingspan) with external tank; Boeing—Saturn IC stage expendable booster that supported orbiter with external tank, plus a solid propellant booster.
Oct. 7, 1971	Phase B contractors were given another extension to study the feasibility of using ballistic recoverable boosters.
Jan. 28, 1972	MSC issued an RFP for the development of low-density ablative materials.
Feb. 1, 1972	MSC called for a design study of an orbital maneuvering system.
Feb. 22, 1972	NASA began evaluations of phase B configurations that reflected the addition of solid propellant boosters.
Mar. 7, 1972	MSC issued an RFP for the study and development of containerized payload systems.
Mar. 17, 1972	NASA issued an RFP for the development of a Shuttle, with design due in May.
Mar. 31, 1972	The GAO determined that NASA had fairly chosen Rocketdyne as contractor for the Shuttle main engine and gave NASA permission to proceed with the contract. The definitive contract was processed on August 16, 1972.
Apr. 14, 1972	It was announced that the Kennedy Space Center (KSC) and Vandenberg Air Force Base, CA, would be the two Shuttle launching sites.
May 12, 1972	Four companies answered the RFP for a Shuttle design: NR, McDonnell Douglas, Grumman, and Lockheed.
May 24, 1972	MSC issued an RFP for the development of a thermal protection system capable of withstanding temperatures of 1922 kelvins.
Jul. 20, 1972	McDonnell Douglas was awarded a 12-month contract for a definition study of the orbital maneuvering system.
Jul. 25, 1972	NASA selected NR as the prime contractor for the Shuttle (other contenders, in the order of how their proposals were judged were Grumman, McDonnell Douglas, and Lockheed). NR subcontracted with Grumman and McDonnell Douglas for engineering support services. NASA's definitive contract with NR was signed on April 16, 1973, superceding a letter contract that was issued on August 9, 1972.
Aug. 9, 1972	NASA was given the authorization to proceed with a space Shuttle orbiter contract.
Oct. 1972	NR announced that their baseline design was an orbiter 38.3 m long with a wing span of 25.5 m, weighing 108 000 kg at launch. Two solid boosters would assist the Shuttle main engine; the propellant tank would be mounted externally.
Nov. 13, 1972	In a program requirements review, NASA Hq., MSC, and NR personnel made some changes to the baseline configuration, increasing the total weight and thrust by a small amount.



Table 2-57. Chronology of Shuttle Orbiter Development and Operations\* (Continued)

Mar. 29, 1973	Rockwell International (formerly NR), let four major subcontracts: vertical tail unit to Fairchild Republic Division of Fairchild Industries, Inc.; double delta wings to Grumman; mid-fuselage to Convair Aerospace Division of GD; orbital maneuvering system to McDonnell Douglas.
Apr. 2, 1973	NASA issued an RFP to McDonnell Douglas, Boeing, and Martin Marietta for the external tank. Chrysler also replied to the RFP.
June 26, 1973	Pratt & Whitney TF33-P-7 engines were chosen for use on Shuttle during its approach and landing tests.
Aug. 16, 1973	NASA chose Martin Marietta as the manufacturer of the external tank for the orbiter.
May 17, 1974	The Johnson Space Center (JSC, formerly MSC) awarded IBM a contract to provide ground-based computing and data processing system software design for Shuttle support.
Oct. 18, 1974	NASA announced that the Flight Research Center at Edwards AFB, California, would be used as the landing area for the first several Shuttle missions before attempting to use facilities at KSC.
Jan. 1975	Program officials announced that a modified Boeing 747 would be used in drop flight tests of the orbiter.
Feb. 1975	A Shuttle Preliminary Design Review was held.
Mar. 13, 1975	Rocketdyne completed the first Shuttle main engine.
Apr. 9, 1975	JSC awarded a contract to Martin Marietta for the development of a manned maneuvering unit for Shuttle EVA.
May 6, 1975	NASA announced that Canada would finance the development and manufacture of a remote manipulator system for Shuttle.
June 11, 1975	First in a series of Shuttle main engine tests was conducted successfully.
Aug. 1975	At Rockwell's Downey, California, factory, the final assembly and mating of Orbiter 101 was begun.
Sept. 24, 1975	JSC announced that a new Shuttle Payload Integration and Development Program Office would manage all orbiter payloads.
Sept. 29, 1975	A supplementary agreement between NASA and Rockwell called for an additional \$1.8 million for the completion of orbiters 101 and 102, bringing the total Rockwell contract value to \$2700 million.
Dec. 16, 1975	NASA announced that the Shuttle Approach and Landing Tests would begin in April 1977 at the Flight Research Center, Edwards AFB.
Dec. 20, 1975	The shuttle main engine completed its first 60-second duration test.
Mar. 12, 1976	Orbiter 101 assembly was completed.
Sept. 17, 1976	Orbiter 101, named <i>Enterprise</i> , was rolled out of the Rockwell factory doors for inspection.
Nov. 4, 1976	Modifications were completed to the Boeing 747 that would be used in the Approach and Landing Tests.
Jan. 14, 1977	The modified Boeing 747 was delivered to the Dryden Flight Research Center (DFRC), Edwards AFB.
Jan. 31, 1977	Orbiter 101 was transported to DFRC.
Feb. 8, 1977	Orbiter 101 and its carrier aircraft were mated.
Feb. 18, 1977	The first inert captive flight (2 hr., 5 min.) of Shuttle orbiter 101 was conducted.
Feb. 22, 1977	Second inert captive flight (3 hr., 13 min.).
Feb. 25, 1977	Third inert captive flight (2 hr., 28 min.).
Feb. 28, 1977	Fourth inert captive flight (2 hr., 11 min.).
Mar. 2, 1977	Fifth inert captive flight (1 hr., 39 min.).
June 18, 1977	First manned captive active flight (55 min.).
June 23, 1977	The first main engine was delivered to the testing site in Mississippi.
June 28, 1977	Second manned captive active flight (1 hr., 2 min.).
July 8, 1977	The second main engine was delivered to the testing site.

Table 2-57. Chronology of Shuttle Orbiter Development and Operations\* (Continued)

---

July 26, 1977	Third manned captive active flight (59 min.).
Aug. 12, 1977	First free flight approach and landing (5 min.).
Sept. 13, 1977	Second free flight approach and landing (5 min.).
Sept. 23, 1977	Third free flight approach and landing (5 min.).
Oct. 12, 1977	Fourth free flight approach and landing (2 min.).
Oct. 26, 1977	Fifth and last free flight approach and landing (2 min.).
Jan. 1978	NASA completed its flight test program with Orbiter 101.
Mar. 3, 1978	Rockwell completed the assembly of Orbiter 102.
Mar. 31, 1978	Orbiter 102's external tank was delivered to MSFC for vertical ground vibration tests.
Mar.-Dec. 1978	Vertical ground vibration tests were conducted on Orbiter 101.
July 1978	Orbiter 102, named <i>Columbia</i> , was rolled out of Rockwell's factory for inspection.
Aug. 1978	<i>Columbia</i> was delivered to KSC.

---

\*For additional information, see table 1-39, and the series of annual chronologies published by NASA: *Astronautics and Aeronautics: Chronology of Science, Technology, and Policy* for the years 1969-1978 (Washington, 1970-1984).

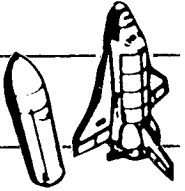

---

CHAPTER THREE

---

**SPACE SCIENCE**

---

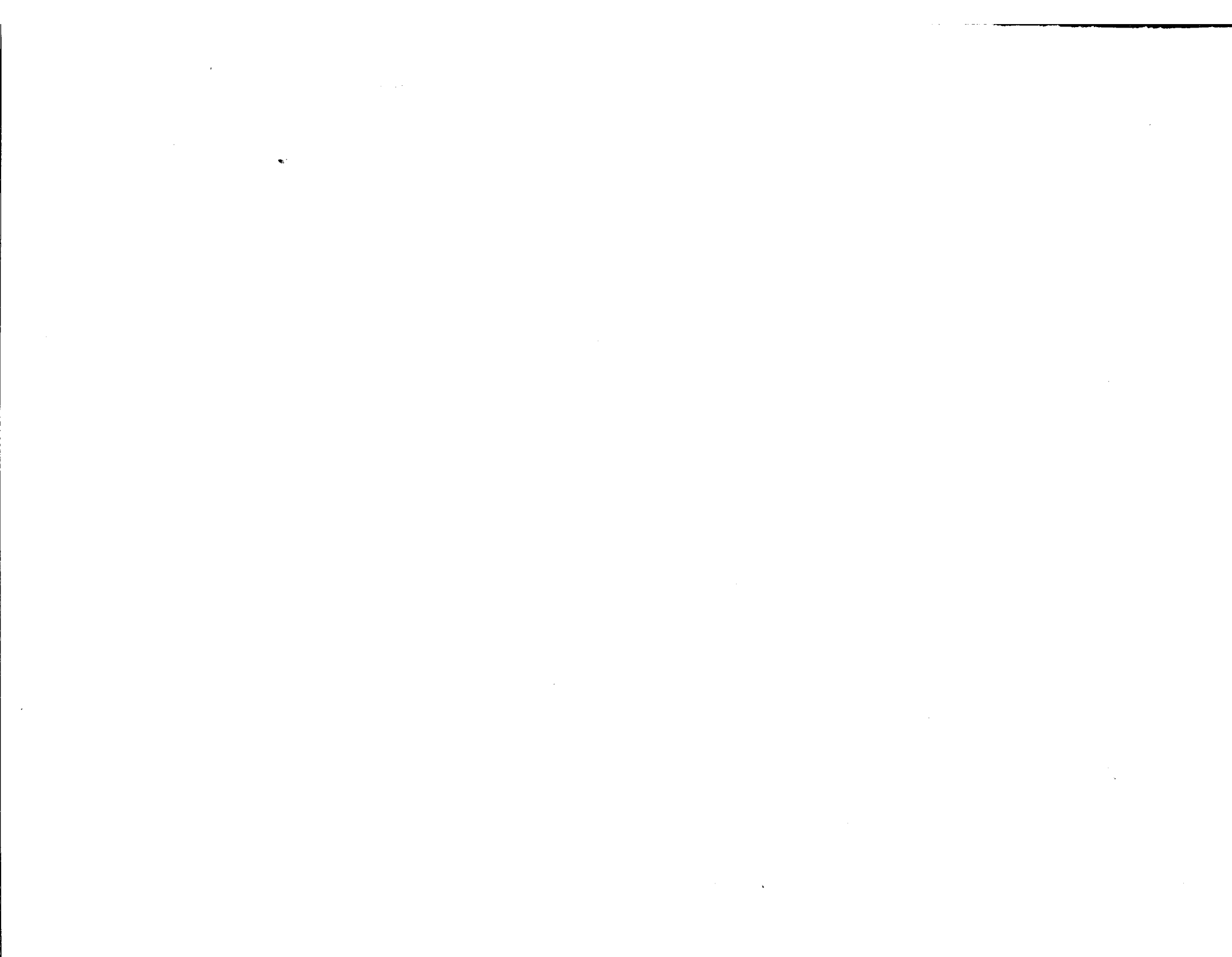

# CHAPTER THREE

## SPACE SCIENCE

### INTRODUCTION

The second decade of space exploration by the U.S. began and ended with a presidential reaffirmation of interest in the space program. But space science was not high on Presidents Richard M. Nixon's and Jimmy Carter's list of space objectives. President Nixon established a Space Task Group in 1969 to provide him with near-future recommendations "on the direction the U.S. space program should take in the post-Apollo period."\* The task group's final proposal emphasized space applications and national defense. There would be no expensive "space spectacles" during the 1970s equivalent to the Apollo manned lunar landings. NASA was urged to build on the knowledge and experience of its first 10 years to develop a stronger program of practical applications satellites that would deliver a speedy return on the taxpayers' space dollars and "improve the quality of life on Earth." Task group members recommended that NASA pursue the development of remote sensing, communications, and meteorology satellites. It was left to the Department of Defense to use space "non-provocatively" to enhance national security.<sup>1</sup>

Nixon's advisers did not ignore space science. They directed the civilian agency to expand man's understanding of the universe with a "strong program of lunar and planetary exploration, astronomy, physics, the earth and life sciences." However, this healthy program had to be accomplished on a bare-bones budget. NASA's scientists had hoped for more fiscal support from Congress and the White House during the 1970s; nevertheless, the agency succeeded in bringing to fruition a respectable program of scientific exploration. Long-time leader of NASA's space science program Homer E. Newell wrote that space science during the second decade "returned a considerable momentum, with the prospect of challenging and important problems to work on for the foreseeable future."<sup>2</sup> While Carter's space policy statements in 1978 highlighted the development and use of the Space Shuttle and space applications projects, the president also wished to "emphasize space science and exploration in a manner that retains the challenge and excitement and permits the nation to retain the vitality of its space technology base"—as long as it could be done at a

---

\*Members of the Space Task Group included Spiro T. Agnew, chairman, Robert C. Seamans, Thomas O. Paine, and Lee A. Dubridge; U. Alexis Johnson, Glenn T. Seaborg, and Robert P. Mayo were observers.

reasonable cost.<sup>3</sup> NASA built on its experiences of the 1960s with earth orbital satellites and interplanetary probes to accomplish even more sophisticated scientific tasks near earth and on other planets during the 1970s, an accomplishment that NASA's managers hoped would renew the nation's interest in space science for the 1980s.

### **The First Decade Reviewed**

The National Aeronautics and Space Act of July 1958, which established NASA, directed the new agency to expand the body "of human knowledge of phenomena in the atmosphere and space." NASA accomplished this directive by embracing a disparate group of scientists, managers, and propulsion experts from several organizations, namely one branch of the Naval Research Laboratory, the California Institute of Technology's Jet Propulsion Laboratory, which was engaged in work for the Army, and the National Advisory Committee for Aeronautics (NACA). These three groups of individuals became the nucleus of three NASA centers of research—the Goddard Space Flight Center, the Jet Propulsion Laboratory, and the Langley Research Center—retaining their uniqueness and individuality but working as a team to explore the new frontier offered them by rocket propulsion.

Managers at NASA Headquarters organized space science into several disciplines, the major ones being physics and astronomy, lunar and planetary exploration, and life sciences. These three broad programs included the fields of geodesy, atmospheric and ionospheric physics, magnetospheric research, lunar and planetary science, solar studies, galactic astronomy, and bioscience. To this list were added comparative planetology, exobiology, and high-energy astronomy during the 1970s.

By necessity, NASA's first scientific satellites were small instrumented packages. Vanguard and Explorer satellites were sent to sample the near-earth environment. As launch vehicles became more accurate and powerful, scientists were able to increase the size and weight of their experiments and send them to higher orbits and to the vicinity of the moon and the near planets. The Explorer, Orbiting Solar Observatory, Orbiting Astronomical Observatory, Orbiting Geophysical Observatory, and Biosatellite programs returned valuable data from earth orbit, while Pioneer, Ranger, Lunar Orbiter, Surveyor, and Mariner gave investigators their first in situ measurements of the world beyond. The U.S. shared its expertise and its launch vehicles with other countries in its attempt to explore and understand the regions beyond earth's obscuring atmosphere. The next decade would see a continuation of these successful programs.

### **Space Science, 1969–1978**

The physics and astronomy program sponsored 17 Explorer satellites, 3 High Energy Astronomy Observatories, 2 Orbiting Astronomical Observatories, 1 Orbiting Geophysical Observatory, and 4 Orbiting Solar Observatories (see table 3-1).

As presented in the tables in this chapter, these satellites were designed to achieve a wide variety of scientific goals. A typical Explorer, of which there were 8 distinct classes, was sent to earth orbit to obtain measurements of the meteoroid penetration rate, or to collect particles and field data, or to pursue any number of related experiments. Studying x-rays and gamma rays was the assignment given the High Energy Astronomy Observatories. The Orbiting Solar Observatories sent back high-resolution data from the sun.

The bioscience program supported only one satellite, *Biosatellite 3*, but a large portion of the experiments accomplished on board the Skylab orbital workshop by nine astronauts was designed by NASA's life scientists. Exobiologists searching for life forms on other planets and looking for clues to the genesis of life on earth sent their first experiments to another planet in 1976 aboard two Mars-bound Viking spacecraft.

Mariner and Viking's spectacular images of the Red Planet were not the only significant "pictures" received from elsewhere in the solar system. Pioneer and Voyager returned great quantities of new information from the vicinity of Venus, Jupiter, and Saturn.

### Managing the Space Science Program at NASA

From November 1963 until December 1971, space science and space applications were managed as one program at NASA Headquarters. The two were divided in an agency-wide reorganization by Administrator James C. Fletcher. John E. Naugle assumed the reins of the space science program from Homer Newell in later 1967 and continued to lead the program until 1974, when Noel W. Hinners was named associate administrator.

Planetary investigations were led by three men during the decade: Donald P. Heath (1969-1971), Robert S. Kraemer (1972-1976), and A. Thomas Young (1977-1978). Physics and astronomy programs were supervised by Jesse Mitchell (1969-1973), Alois W. Schardt (1974-1976), and T. B. Norris (1977-1978). Bioscience was under the direction of Orr E. Reynolds until 1971, when the program was reorganized under the Office of Manned Space Flight. David Winter was directing the effort when the discipline was moved back to the Office of Space Science in 1976. The vehicles used to launch space science payloads were managed at headquarters by Joseph B. Mahon until 1976, when they became the responsibility of the

Table 3-1. Scientific Satellites, 1969-1978

Mission Class	Successful	Partially Successful	Unsuccessful	Total
Physics and astronomy*	44	6	3	53
Lunar and planetary	13	1	1	15
Bioscience		1		1
Total	57	8	4	69

\*Includes 20 satellites jointly sponsored by NASA and another country or U.S. government agency.

new Office of Space Flight. For more details on the management of NASA's Office of Space, see table 3-2.

The lead centers involved in the space science program included the Jet Propulsion Laboratory, Ames Research Center, Goddard Space Flight Center, and Langley Research Center.

Table 3-2. Two Phases of Space Science Management, NASA Headquarters

Phase I  
January 1969–November 1971

Administrator/Deputy Administrator

Associate Administrator, Office of Space Science and Applications (John E. Naugle)

Deputy Associate Administrator, Office of Space Science and Applications (Oran W. Nicks)

Deputy Associate Administrator (Science), Office of Space Science and Applications (Henry J. Smith)

Deputy Associate Administrator (Engineering), Office of Space Science and Applications (Vincent L. Johnson)

Deputy Associate Administrator (Applications), Office of Space Science and Applications (Leonard Jaffe; added 1970)

Director, Advanced Programs (Pitt Thome; Robert G. Wilson, 1970)

Director, Program Review and Resources Management (Eldon D. Taylor; Richard L. Daniels, 1971)

Director, Bioscience Programs (Orr E. Reynolds; Benny B. Hall, acting, late 1970; office reorganized as part of OMSF in early 1971)

Deputy Director, Bioscience Programs (B. Hall)

Assistant Director (Science), Bioscience Programs (D. Jenkins)

Program Chief, Advanced Programs and Technology (Loyal G. Goff)

Program Manager, Biosatellite (T. Dallow)

Program Chief, Exobiology (S. Young)

Program Chief, Environmental Biology (J. Saunders)

Program Chief, Physical Biology (G. Jacobs)

Program Chief, Planetary Quarantine (L. Hall)

Director, Space Applications Program (Leonard Jaffe; dropped as a program office in 1970; Jaffe became Deputy Assoc. Admin. for Applications; reorganized as two program offices—Communications and Earth Observations)\*

Director, Communications Programs (R. B. Marsten; added 1970; see also above)

Director, Earth Observations Program (John M. DeNoyer; added 1970; see also above)

Director, Launch Vehicle and Propulsion Programs (Joseph B. Mahon)\*\*

Director, Planetary Programs (Hearth; Robert S. Kraemer, 1971)

Assistant Director, Planetary Programs (Donald G. Rea)

Program Manager, Advanced Programs and Technology (Robert Kraemer)

Program Manager, Surface Lab. Science (Milton A. Mitz)

Program Manager, Lunar Orbiter (Lee Scherer)

Program Manager, Mariner V (Glenn Reiff)

Program Manager, Mariner 69 (N. Cunningham)

Program Manager, Mariner Mars 71 (Carl W. Glahn)

Program Manager, Pioneer Program (Reiff)

Program Chief, Planetary Astronomy (W. Brunk)

Program Chief, Planetary Atmospheres (R. Fellows)

Program Chief, Planetology (E. Dwornik)



Table 3-2. Two Phases of Space Science Management, NASA Headquarters (Continued)

Phase II  
December 1971-1978

Administrator/Deputy Administrator

- Associate Administrator, Office of Space Science (Naugle; Noel Hinners, June 1974)
- Deputy Associate Administrator, Office of Space Science (V. Johnson; vacant, fall of 1974; John M. Thole, late 1974; Anthony J. Calio, fall 1975; Andrew J. Stofan, 1977)
- Deputy Associate Administrator (Science), Office of Space Science (H. Smith; Ichtiague Rasool, fall 1975)
- Deputy Associate Administrator (Engineering), Office of Space Science (Milton W. Rosen; added spring 1973; dropped fall 1975; dropped 1977)
- Director, Advanced Programs (Wilson; dropped 1974)
- Director, Program Review and Resource Management/Program Analysis (Daniels; Charles E. Wash, 1976)
- Director, Launch Vehicle and Propulsion Programs (Mahon; office reorganized as part of OMSF in spring 1976 and renamed Office of Expendable Launch Vehicles)\*\*
- Director, Planetary Programs (Kraemer; A. Thomas Young, 1976)
- Director, Physics and Astronomy/Astrophysics (Mitchell; Alois W. Schardt, fall 1973; T. B. Norris, 1976)
- Director, Lunar Programs (William T. O'Bryant; added spring 1973; Noel W. Hinners, acting, late 1974; Edward A. Flinn; early 1975; dropped 1976)
- Director, Life Sciences Programs (Winter; moved from OMSF early 1976; Gerald A. Soffen, acting, late 1978)
- Director, Solar Terrestrial Programs (Harold Glaser; added early 1976)
- Director, Physics and Astronomy Programs (Jesse Mitchell)
- Deputy Director, Physics and Astronomy Programs (Mitchell, acting)
  - Program Chief, Advanced Programs and Technology (Marcel J. Ancremanne, acting)
  - Program Manager, Astronomical Observatories (C. Ashworth)
  - Program Manager, Explorers and Sounding Rockets (J. Holtz)
  - Program Manager, Geophysical Observatories (T. Fischetti)
  - Chief, Astronomy (Nancy Roman)
  - Chief, Interplanetary Dust and Cometary Physics (M. Dubin)
  - Chief, Ionospheric Physics (E. Schmerling)
  - Chief, Particles and Fields (Alois W. Schardt)
  - Chief, Solar Physics (N. Glaser)
- Director, Upper Atmospheric Research (James King, Jr.; added early 1976; Lawrence R. Greenwood, fall 1976; dropped 1977)

\*See chapter 4 for a discussion of the management of space applications programs.

\*\*See chapter 2 for a discussion of the management of launch vehicle programs.

## BUDGET

For a general introduction to the NASA budget process and to the budget tables in this volume, consult chapter 1. Other data that may assist the researcher interested in the cost of NASA's space science program include budget tables in chapter 1 for the various launch vehicles used by the Office of Space Science in 1976-1978. Chapter 6 provides budget data on the tracking network that supported the agency's space science flight projects. For a more detailed breakdown of the flight project budgets, see the NASA annual budget estimates referred to in chapter 1. Review the bottom notes of all tables carefully before making conclusions about totals for any particular project or year.

### Money for Space Science

NASA's overall budget declined almost yearly during the agency's second decade (6 out of 10 years, with appropriations ranging from \$4.1 billion in 1978 to \$3 billion in 1974), and the civilian agency never regained during its second 10 years the generous \$5+ billion budgets it enjoyed during the mid-1960s. The number of dollars for space science, however, increased during the post-Apollo years. The average annual budget for space science in the 1960s was \$384.9 million; during the 1970s it was \$550.5 million. But the increase was offset by inflation and rising costs. The average annual space science budget was a slightly smaller percentage of the total NASA budget during the second 10 years. The average percentage of the total NASA appropriation allotted for space science in 1959-1968 was 17.6%; it was 17% in 1969-1978.

Table 3-3 summarizes the space science funding history, and table 3-4 breaks

Table 3-3. Total Space Science Funding History  
(in thousands of dollars)

Year	Request	Authorization	Programmed	Total NASA Budget Request, R&D
1969	426 000	377 900	354 573	3 677 200
1970	423 000	389 400	391 225	3 006 427
1971	398 700	398 700	398 654	2 606 100
1972	567 900	560 400	552 900	2 517 700
1973	669 400	669 400	679 169	2 600 900
1974	584 000 <sup>a</sup>	552 000	664 482	2 197 000
1975	547 015	550 015	417 315	2 346 015
1976	742 900 <sup>b</sup>	589 600 <sup>c</sup>	434 126	2 678 380
1977	379 025	380 525	380 325	2 758 925
1978	405 700 <sup>d</sup>	414 700	404 700	3 026 000

<sup>a</sup>\$31 000 000 from FY 1973 funds were applied to FY 1974 programs; \$553 000 000 was actually requested.

<sup>b</sup>Includes \$160 300 000 for the transition quarter.

<sup>c</sup>Authorization figures do not include the transition quarter.

<sup>d</sup>NASA's final budget submission for FY 1978 was increased by \$10 000 000; the extra request was targeted for the lunar and planetary program (see table 3-20).

down costs per program. The remaining budget tables give the researcher totals by discipline and flight project.

Table 3-4. Programmed Costs of Space Science Programs  
(in thousands of dollars)

Program	1969	1970	1971	1972	1973	1974	1975	1976	1977	1978
Physics and astronomy										
Explorer	19 431	18 295	25 837	22 600	33 158	32 787	33 945	29 922	30 238	35 000
OSO	13 812	14 515	16 931	18 600	20 420	12 763	4305	3600	1000	1300
OA0	36 392	33 283	23 210	13 400	5700	2326	2216	2300	2600	1956
OGO	13 072	---	---	---	---	---	---	---	---	---
HEAO	---	---	---	13 400	21 815	4850	42 900	59 218	39 362	25 150
Spacelab science	---	---	---	---	---	500	3330	1100	6000	27 061
Solar Maximum Mission	---	---	---	---	---	---	---	---	21 300	29 600
Space Telescope	---	---	---	---	---	---	---	---	---	36 000
Sounding rockets	19 234	18 500	18 900	18 000	20 000	18 113	19 976	20 000	20 700	19 899
Airborne research	1000	1600	4965	2690	4100	4000	3858	3800	3800	3800
Balloon support	---	1000	1000	1000	1000	1000	1000	1000	1500	1500
Supporting research	22 497	16 718	17 235	15 402	15 127	12 780	18 385	27 478	30 800	34 507
Data analysis	3412	8940	7878	5008	4880	4881	6400	10 882	9000	8427
Lunar and planetary										
Mariner	46 188	63 871	41 840	61 600	37 683	11 135	5324	---	---	---
Pioneer/Helios	4700	22 570	41 675	15 264	11 573	7005	33 642	61 700	46 300	21 806
Viking	12 427	40 000	35 000	176 200	232 249	290 437	89 016	39 500	25 400	20 000
Outer planets missions	---	---	---	9165	6064	27 390	69 761	82 400	---	---
Voyager	---	---	---	---	---	---	---	---	50 300	16 025
Galileo	---	---	---	---	---	---	---	---	---	20 950
Planetary flight support	---	---	---	---	15 000	21 170	24 725	29 200	27 840	24 428
Planetary astronomy	3700	3800	4800	4800	4800	3800	4200	---	---	---
Planetary quarantine	1300	2540	2000	2200	2200	1500	1500	---	---	---
Lunar research and analysis	---	---	---	---	---	17 450	21 904	11 076	10 908	---
Supporting research	18 571	18 080	18 005	19 218	19 364	11 195	11 000	21 054	20 952	43 991
Data analysis	2337	2579	3580	3053	3036	1400	1628	9320	10 200	---
Bioscience/Life sciences										
Biosatellite	27 700	5970	332	---	---	---	---	---	---	---
Flight experiments	---	---	---	---	---	---	---	---	1500	9000
Space life sciences	---	---	---	---	---	---	15 000	---	---	---
Planetary biology	---	---	---	---	---	---	3300	---	---	---
Vestibular functions research	---	---	---	---	---	---	---	---	900	1500
Supporting research	1300	11 145	10 566	---	---	---	---	19 576	19 725	22 800
Research equipment	---	---	---	---	---	---	---	1000	---	---
Launch vehicle procurement										
Agna	11 300	5000	---	---	---	---	---	---	---	---
Centaur	44 200	46 019	66 000	82 200	120 700	106 000	---	---	---	---
Delta	24 300	32 400	37 500	41 000	76 000	60 200	---	---	---	---
Scout	12 600	13 700	13 200	15 100	15 700	7800	---	---	---	---
Titan IIIC	3100	6700	4100	9000	5500	---	---	---	---	---
Supporting research	4400	4000	4100	4000	3100	4000	---	---	---	---
Totals	325 108	391 225	398 654	552 900	679 169	664 482	417 315	434 126	380 325	404 700

Table 3-5. Total Physics and Astronomy Program Funding History  
(in thousands of dollars)

Year	Request	Authorization	Programmed
1969	141 900	136 900	128 850
1970	119 600	117 600	112 851
1971	116 000	116 000	115 956
1972	110 300	112 800	110 110
1973	156 600	156 600	126 200
1974	95 000 <sup>a</sup>	63 600 <sup>b</sup>	94 000
1975	140 515	140 515	136 315
1976	202 400 <sup>c</sup>	162 800 <sup>d</sup>	159 300
1977	165 800	166 300	166 300
1978	224 200	228 200	224 200

<sup>a</sup>\$30 400 000 from FY 1973 funds were applied to the FY 1974 program; \$64 600 000 was actually requested.

<sup>b</sup>The reduction was not directed at any specific project within the program.

<sup>c</sup>Includes \$46 600 000 for the transition quarter.

<sup>d</sup>Authorization figures do not include the transition quarter.

Table 3-6. Physics and Astronomy—Explorer Funding History  
(in thousands of dollars)

Year	Request	Authorization	Programmed
1969	23 200	---	19 431
1970	26 000	24 000	18 295
1971	25 600	25 600	25 837
1972	24 500	24 500	22 600
1973	32 000	32 000	33 158
1974	33 100	--- <sup>a</sup>	32 787
1975	33 000	33 000	33 945
1976	44 000 <sup>b</sup>	33 000 <sup>c</sup>	29 922
1977	33 000	33 000	30 238 <sup>d</sup>
1978	35 000	35 000	35 000 <sup>e</sup>

<sup>a</sup>The total physics and astronomy program authorization was reduced by \$1 000 000.

<sup>b</sup>Includes \$11 000 000 for the transition quarter.

<sup>c</sup>Authorization figures do not include the transition quarter.

<sup>d</sup>Includes \$23 441 000 for development and \$6 797 000 for mission operations.

<sup>e</sup>Includes \$24 297 000 for development and \$10 703 000 for mission operations.

Table 3-7. Physics and Astronomy—  
Orbiting Solar Observatory (OSO) Funding History  
(in thousands of dollars)

Year	Request	Authorization	Programmed
1969	12 000	---	13 812
1970	14 800	14 800	14 515
1971	16 100	16 100	16 931
1972	19 000	--- <sup>a</sup>	18 600
1973	14 500	14 500	20 420
1974	10 000	--- <sup>b</sup>	12 763
1975	7630	7630	4305
1976	3100 <sup>c</sup>	--- <sup>d</sup>	3600
1977	1000	1000	1000
1978	1270	1270	1300

<sup>a</sup>\$43 400 000 was authorized for large observatories, which included OSO, OAO, and HEAO.

<sup>b</sup>The total physics and astronomy authorization was reduced by \$1 000 000.

<sup>c</sup>Includes \$500 000 for the transition quarter.

<sup>d</sup>\$62 000 000 was authorized for large observatories, which included OSO, OAO, and HEAO; authorization figures do not include the transition quarter.

Table 3-8. Physics and Astronomy—  
Orbiting Astronomical Observatory (OAO) Funding History  
(in thousands of dollars)

Year	Request	Authorization	Programmed
1969	35 200	---	36 392
1970	28 600	28 600	33 283
1971	27 100	27 100	23 210
1972	11 000	--- <sup>a</sup>	13 400
1973	5600	5600	5700
1974	3100	--- <sup>b</sup>	2326
1975	2380	2380	2216
1976	3470 <sup>c</sup>	--- <sup>d</sup>	2300
1977	2600	2600	2600
1978	1980	1980	1956

<sup>a</sup>\$43 400 000 was authorized for large observatories, which included OSO, OAO, and HEAO.

<sup>b</sup>The total physics and astronomy authorization was reduced by \$1 000 000.

<sup>c</sup>Includes \$1 100 000 for the transition quarter.

<sup>d</sup>\$62 000 000 was authorized for large observatories, which included OSO, OAO, and HEAO; authorization figures do not include the transition quarter.

Table 3-9. Physics and Astronomy—  
Orbiting Geophysical Observatory (OGO) Funding History  
(in thousands of dollars)

Year	Request	Authorization	Programmed
1969	13 200	---	13 072
1970	6800	6800	---
1971	5200	5200	---

Table 3-10. Physics and Astronomy—  
High Energy Astronomy Observatory (HEAO) Funding History  
(in thousands of dollars)

Year	Request	Authorization	Programmed
1972	13 400	--- <sup>a</sup>	13 400
1973	59 600	59 600	21 815
1974	5 000	--- <sup>b</sup>	4 850
1975	40 400	40 400	42 900
1976	68 600 <sup>c</sup>	--- <sup>d</sup>	59 218
1977	36 600	36 600	39 362
1978	22 450	22 450	25 150 <sup>e</sup>

<sup>a</sup>\$43 400 000 was authorized for large observatories, which included OSO, OAO, and HEAO.

<sup>b</sup>The total physics and astronomy authorization was reduced by \$1 000 000.

<sup>c</sup>Includes \$12 000 000 for the transition quarter.

<sup>d</sup>\$62 000 000 was authorized for large observatories, which included OSO, OAO, and HEAO; authorization figures do not include the transition quarter.

<sup>e</sup>Includes \$19 811 000 for development and \$5 339 000 for mission operations.

Table 3-11. Physics and Astronomy—  
Spacelab Science Program Funding History  
(in thousands of dollars)

Year	Request	Authorization	Programmed
1974	---	---	500
1975	---	---	3330
1976	8100 <sup>a</sup>	4600 <sup>b</sup>	1100
1977	10 000	10 000	6000
1978	28 900	28 900	27 061

<sup>a</sup>Includes \$3 500 000 for the transition quarter; see also table 3-18.

<sup>b</sup>Authorization figures do not include the transition quarter.

Table 3-12. Physics and Astronomy—Solar Maximum Mission Funding History  
(in thousands of dollars)

Year	Request	Authorization	Programmed
1977	21 300 <sup>a</sup>	21 300	21 300
1978	30 600	30 600	29 600

<sup>a</sup>See also table 3-18.

Table 3-13. Physics and Astronomy—Space Telescope Funding History  
(in thousands of dollars)

Year	Request	Authorization	Programmed
1978	36 000 <sup>a</sup>	36 000	36 000

<sup>a</sup>See also table 3-18.

Table 3-14. Physics and Astronomy—Pioneer Funding History  
(in thousands of dollars)

Year	Request	Authorization	Programmed
1969	6000 <sup>a</sup>	---	---

<sup>a</sup>See also table 3-22.

Table 3-15. Physics and Astronomy—  
Sounding Rockets Funding History  
(in thousands of dollars)

Year	Request	Authorization	Programmed
1969	22 000	---	19 234
1970	20 100	20 100	18 500
1971	18 500	18 500	18 900
1972	18 000	--- <sup>a</sup>	18 000
1973	20 000	--- <sup>b</sup>	20 000
1974	20 000	--- <sup>c</sup>	18 113
1975	20 000	20 000	19 976
1976	26 200 <sup>d</sup>	--- <sup>e</sup>	20 000
1977	20 700	20 700	20 700
1978	20 700	20 700	19 899

<sup>a</sup>\$24 000 000 was authorized for suborbital programs, which included sounding rockets, airborne research, and balloon support.

<sup>b</sup>\$25 000 000 was authorized for suborbital programs, which included sounding rockets, airborne research, and balloon support.

<sup>c</sup>The total physics and astronomy authorization was reduced by \$1 000 000.

<sup>d</sup>Includes \$6 200 000 for the transition quarter.

<sup>e</sup>\$31 800 000 was authorized for suborbital programs, which included sounding rockets, airborne research, and balloon support; authorization figures do not include the transition quarter. Congress authorized \$7 000 000 beyond NASA's request for physics and astronomy programs to study the possible depletion of the protective ozone layer in the upper atmosphere (Upper Atmospheric Research, Technology, and Monitoring Program); this program was assumed under physics and astronomy supporting activities in FY 1977.

Table 3-16. Physics and Astronomy—Airborne Research Funding History  
(in thousands of dollars)

Year	Request	Authorization	Programmed
1969	---	---	1000
1970	---	---	1600
1971	3000	3000	4965
1972	2500	---- <sup>a</sup>	2690
1973	4000	---- <sup>b</sup>	4100
1974	4000	---- <sup>c</sup>	4000
1975	4000	4000	3858
1976	4800 <sup>d</sup>	---- <sup>e</sup>	3800
1977	3800	3800	3800
1978	3800	3800	3800

<sup>a</sup>\$24 000 000 was authorized for suborbital programs, which included sounding rockets, airborne research, and balloon support.

<sup>b</sup>\$25 000 000 was authorized for suborbital programs, which included sounding rockets, airborne research, and balloon support.

<sup>c</sup>The total physics and astronomy authorization was reduced by \$1 000 000.

<sup>d</sup>Includes \$1 000 000 for the transition quarter.

<sup>e</sup>\$31 800 000 was authorized for suborbital programs, which included sounding rockets, airborne research, and balloon support; authorization figures do not include the transition quarter. Congress authorized \$7 000 000 beyond NASA's request for physics and astronomy programs to study the possible depletion of the protective ozone layer in the upper atmosphere (Upper Atmospheric Research, Technology, and Monitoring Program); this program was assumed under physics and astronomy supporting activities in FY 1977.

Table 3-17. Physics and Astronomy—Balloon Support Funding History  
(in thousands of dollars)

Year	Request	Authorization	Programmed
1970	---	---	1000
1971	---	---	1000
1972	1000	---- <sup>a</sup>	1000
1973	1000	---- <sup>b</sup>	1000
1974	1000	---- <sup>c</sup>	1000
1975	1000	1000	1000
1976	1300 <sup>d</sup>	---- <sup>e</sup>	1000
1977	1500	1500	1500
1978	1500	1500	1500

<sup>a</sup>\$24 000 000 was authorized for suborbital programs, which included sounding rockets, airborne research, and balloon support.

<sup>b</sup>\$25 000 000 was authorized for suborbital programs, which included sounding rockets, airborne research, and balloon support.

<sup>c</sup>The total physics and astronomy authorization was reduced by \$1 000 000.

<sup>d</sup>Includes \$300 000 for the transition quarter.

<sup>e</sup>\$31 800 000 was authorized for suborbital programs, which included sounding rockets, airborne research, and balloon support; authorization figures do not include the transition quarter. Congress authorized \$7 000 000 beyond NASA's request for physics and astronomy programs to study the possible depletion of the protective ozone layer in the upper atmosphere (Upper Atmospheric Research, Technology, and Monitoring Program); this program was assumed under physics and astronomy supporting activities in FY 1977.



Table 3-18. Physics and Astronomy—  
Supporting Research and Technology Funding History  
(in thousands of dollars)

Year	Request	Authorization	Programmed
1969	25 300	---	22 497
1970	19 600	19 600	16 718
1971	17 500	17 500	17 235
1972	15 900 <sup>a</sup>	15 900 <sup>a</sup>	15 402
1973	14 900	14 900	15 127 <sup>b</sup>
1974	13 800 <sup>c</sup>	---	12 780
1975	25 605 <sup>e</sup>	25 605 <sup>e</sup>	18 385 <sup>f</sup>
1976	28 700 <sup>g</sup>	28 700 <sup>g</sup>	27 478 <sup>h</sup>
1977	26 300 <sup>i</sup>	---	30 800 <sup>k</sup>
1978	33 400 <sup>l</sup>	37 400	34 507 <sup>m</sup>

<sup>a</sup>Includes \$500 000 for large space telescope studies. The name of the program was changed to Supporting Activities in FY 1972.

<sup>b</sup>Includes \$308 000 for Spacelab studies and experiment definition.

<sup>c</sup>Includes \$500 000 for payload definition.

<sup>d</sup>The total physics and astronomy authorization was reduced by \$1 000 000.

<sup>e</sup>Includes \$3 500 000 for Spacelab studies and experiment definition.

<sup>f</sup>Includes \$3 000 000 for Space Telescope advanced technology development and \$1 515 000 for Solar Maximum Mission advanced technology development.

<sup>g</sup>Includes \$14 400 000 for supporting research and technology (plus \$4 000 000 for the transition quarter); \$5 000 000 for large space telescope advanced technology development (plus \$3 000 000 for the transition quarter); and \$1 000 000 for Solar Maximum Mission advanced technology development (plus \$1 300 000 for the transition quarter).

<sup>h</sup>Includes \$3 500 000 for upper atmospheric research, \$3 500 000 for Spacelab science payload definition, \$5 000 000 for Space Telescope advanced technology development, and \$1 000 000 for Solar Maximum Mission advanced technology development.

<sup>i</sup>Includes \$11 600 000 for upper atmospheric research.

<sup>j</sup>\$500 000 was added to the authorization for supporting activities; the conference committee further directed NASA to fund Space Telescope at \$1 500 000 during FY 1977 (no funds had been requested); there is no indication from which supporting activity program(s) the \$1 000 000 was transferred. A total of \$35 800 000 was authorized for supporting activities, which included data analysis.

<sup>k</sup>Includes \$11 600 000 for upper atmospheric research, \$4 000 000 for Spacelab science payload definition and \$1 000 000 for out-of-the-ecliptic advanced technology development. The name of the program was changed to Research and Analysis in FY 1979.

<sup>l</sup>Includes \$11 600 000 for upper atmospheric research, \$4 000 000 for Spacelab science payload definition, and \$1 000 000 for out-of-the-ecliptic advanced technology development.

<sup>m</sup>Includes \$11 600 000 for upper atmospheric research and \$4 000 000 for Spacelab science payload definition.

Table 3-19. Physics and Astronomy—Data Analysis Funding History  
(in thousands of dollars)

Year	Request	Authorization	Programmed
1969	5000	---	3412
1970	3700	3700	8940
1971	3000	3000	7878
1972	5000	5000	5008
1973	5000	5000	4880
1974	5000	--- <sup>a</sup>	4881
1975	6500 <sup>b</sup>	6500 <sup>b</sup>	6400 <sup>c</sup>
1976	13 800 <sup>d</sup>	13 800 <sup>d</sup>	10 882
1977	9000 <sup>e</sup>	--- <sup>f</sup>	9000
1978	8600	8600	8427

<sup>a</sup>The total physics and astronomy authorization was reduced by \$1 000 000.

<sup>b</sup>Includes \$1 500 000 for Skylab data analysis.

<sup>c</sup>Includes \$1 400 000 for Skylab data analysis.

<sup>d</sup>Includes \$5 000 000 for data analysis (plus \$1 300 000 for the transition quarter) and \$6 000 000 for Skylab data analysis (plus \$1 500 000 for the transition quarter).

<sup>e</sup>Includes \$4 000 000 for Skylab data analysis.

<sup>f</sup>\$35 800 000 was authorized for supporting activities, which included data analysis.

Table 3-20. Total Lunar and Planetary Program Funding History  
(in thousands of dollars)

Year	Request	Authorization	Programmed
1969	107 300	92 300	87 923
1970	146 800	138 800	150 900
1971	144 900	144 900	144 900
1972	311 500	301 500	291 500
1973	321 200	321 200	331 969
1974	312 000	311 000 <sup>a</sup>	392 482
1975	266 000	266 000	261 200
1976	333 200 <sup>b</sup>	259 900 <sup>c</sup>	254 250
1977	191 100	192 100	191 900
1978	148 200 <sup>d</sup>	153 200	147 200

<sup>a</sup>The reduction was not directed at any specific project within the program.

<sup>b</sup>Includes \$73 300 000 for the transition quarter.

<sup>c</sup>Authorization figures do not include the transition quarter.

<sup>d</sup>NASA's final budget submission for FY 1978 was increased by \$10 000 000; the extra request was targeted for lunar and planetary supporting research and technology (see table 3-32).

Table 3-21. Lunar and Planetary—Mariner Funding History  
(in thousands of dollars)

Year	Request	Authorization	Programmed
1969	68 000 <sup>a</sup>	---	46 188 <sup>b</sup>
1970	53 300 <sup>c</sup>	53 300 <sup>c</sup>	63 871
1971	50 900 <sup>d</sup>	50 900 <sup>d</sup>	41 840
1972	52 800	52 800	61 600
1973	43 000	43 000	37 683
1974	8900	--- <sup>e</sup>	11 135 <sup>e</sup>
1975	4119	4119	5324

<sup>a</sup>Includes \$30 000 000 for Mariner Mars 1969, \$18 000 000 for Mariner Mars 1971, and \$20 000 000 for Titan Mars 1973.

<sup>b</sup>Includes \$26 130 000 for Mariner Mars 1969 and \$20 058 000 for Mariner Mars 1971.

<sup>c</sup>Includes \$4 900 000 for Mariner Mars 1969, \$45 400 000 for Mariner Mars 1971, and \$3 000 000 for Titan Mars 1973.

<sup>d</sup>Includes \$200 000 for Mariner Mars 1969, \$29 600 000 for Mariner Mars 1971, and \$21 100 000 for Titan Mars 1973.

<sup>e</sup>The total lunar and planetary authorization was reduced by \$1 000 000.

Table 3-22. Lunar and Planetary—Pioneer/Helios Funding History  
(in thousands of dollars)

Year	Request	Authorization	Programmed
1969	--- <sup>a</sup>	---	4700 <sup>a</sup>
1970	18 200	18 200	22 570
1971	32 900	32 900	41 675
1972	20 100	20 100	15 264
1973	12 500	12 500	11 573
1974	7700	--- <sup>b</sup>	7005
1975	33 500	33 500	33 642
1976	78 900 <sup>c</sup>	62 600 <sup>d</sup>	61 700 <sup>e</sup>
1977	47 400	47 400	46 300 <sup>f</sup>
1978	23 300 <sup>g</sup>	23 300 <sup>g</sup>	21 806 <sup>h</sup>

<sup>a</sup>See also table 3-14.

<sup>b</sup>The total lunar and planetary authorization was reduced by \$1 000 000.

<sup>c</sup>Includes \$16 300 000 for the transition quarter.

<sup>d</sup>Authorization figures do not include the transition quarter.

<sup>e</sup>Includes \$56 600 000 for Pioneer Venus, \$3 900 000 for Pioneer 6-11, and \$1 200 000 for Helios.

<sup>f</sup>Includes \$42 800 000 for Pioneer Venus, \$2 600 000 for Pioneer 6-11 extended mission, and \$900 000 for Helios extended mission.

<sup>g</sup>Includes \$19 000 000 for Pioneer Venus, \$3 600 000 for Pioneer 6-11, and \$1 200 000 for Helios.

<sup>h</sup>Includes \$17 900 000 for Pioneer Venus, \$1 100 000 for Pioneer Venus extended mission, \$2 106 000 for Pioneer 6-11 extended mission, and \$700 000 for Helios extended mission.

Table 3-23. Lunar and Planetary – Viking Funding History  
(in thousands of dollars)

Year	Request	Authorization	Programmed
1969	---	---	12 427
1970	40 000	40 000	40 000
1971	35 000	35 000	35 000
1972	180 400	180 400	176 200
1973	229 500	229 500	232 249
1974	201 200	--- <sup>a</sup>	290 437
1975	89 016	89 016	89 016
1976	53 500 <sup>b</sup>	39 500 <sup>c</sup>	39 500
1977	24 200	24 200	25 400
1978	20 000	20 000	20 000

<sup>a</sup>The total lunar and planetary authorization was reduced by \$1 000 000.

<sup>b</sup>Includes \$14 000 000 for the transition quarter.

<sup>c</sup>Authorization figures do not include the transition quarter.

Table 3-24. Lunar and Planetary – Outer Planets Missions Funding History  
(in thousands of dollars)

Year	Request	Authorization	Programmed
1972	30 000	20 000	9165
1973	7000	7000	6064
1974	32 200	--- <sup>a</sup>	27 390
1975	69 761	69 761	69 761
1976	105 000 <sup>b</sup>	82 400 <sup>c</sup>	82 400 <sup>d</sup>
1977	50 300	50 300	--- <sup>e</sup>
1978	35 000 <sup>f</sup>	35 000 <sup>f</sup>	--- <sup>g</sup>

<sup>a</sup>The total lunar and planetary authorization was reduced by \$1 000 000.

<sup>b</sup>Includes \$22 600 000 for the transition quarter.

<sup>c</sup>Authorization figures do not include the transition quarter.

<sup>d</sup>For Mariner Jupiter/Saturn 1977.

<sup>e</sup>See table 3-25.

<sup>f</sup>Includes \$14 300 000 for Mariner Jupiter/Saturn 1977 and \$20 700 000 for Jupiter orbiter/probe mission.

<sup>g</sup>See tables 3-25 and 3-26.

Table 3-25. Lunar and Planetary – Voyager Funding History  
(in thousands of dollars)

Year	Request	Authorization	Programmed
1977	---	---	50 300 <sup>a</sup>
1978	---	---	16 025

<sup>a</sup>See also table 3-24.

Table 3-26. Lunar and Planetary—Galileo Funding History  
(in thousands of dollars)

Year	Request	Authorization	Programmed
1978	---	---	20 950 <sup>a</sup>

<sup>a</sup>See also table 3-24.

Table 3-27. Lunar and Planetary—Planetary Flight Support Funding History  
(in thousands of dollars)

Year	Request	Authorization	Programmed
1973	---	---	15 000
1974	22 000	---- <sup>a</sup>	21 170
1975	25 500	25 500	24 725
1976	38 100 <sup>b</sup>	29 300 <sup>c</sup>	29 200
1977	27 900	27 900	27 840
1978	25 000	25 000	24 428

<sup>a</sup>The total lunar and planetary authorization was reduced by \$1 000 000.

<sup>b</sup>Includes \$8 800 000 for the transition quarter.

<sup>c</sup>Authorization figures do not include the transition quarter.

Table 3-28. Lunar and Planetary—Planetary Explorers Funding History  
(in thousands of dollars)

Year	Request	Authorization	Programmed
1970	8000	---	---

Table 3-29. Lunar and Planetary—Planetary Astronomy Funding History  
(in thousands of dollars)

Year	Request	Authorization	Programmed
1969	---	---	3700
1970	---	---	3800
1971	4800	4800	4800
1972	4800	4800	4800
1973	4800	4800	4800
1974	3700	---- <sup>a</sup>	3800
1975	4200	4200	4200
1976	5300 <sup>b</sup>	4200 <sup>c</sup>	---
1977	4800	4800	---

<sup>a</sup>The total lunar and planetary authorization was reduced by \$1 000 000.

<sup>b</sup>Includes \$1 100 000 for the transition quarter.

<sup>c</sup>Authorization figures do not include the transition quarter.

Table 3-30. Lunar and Planetary—Planetary Quarantine Funding History  
(in thousands of dollars)

Year	Request	Authorization	Programmed
1970	--- <sup>a</sup>	---	---
1971	---	---	---
1972	2200	2200	2200
1973	2200	2200	2200
1974	1500	--- <sup>b</sup>	1500
1975	1500	1500	1500 <sup>a</sup>
1976	1900 <sup>c</sup>	1500 <sup>d</sup>	---

<sup>a</sup>See also table 3-39.

<sup>b</sup>The total lunar and planetary authorization was reduced by \$1 000 000.

<sup>c</sup>Includes \$400 000 for the transition quarter.

<sup>d</sup>Authorization figures do not include the transition quarter.

Table 3-31. Lunar and Planetary—Lunar Research and Analysis Funding History  
(in thousands of dollars)

Year	Request	Authorization	Programmed
1974	8600 <sup>a</sup>	--- <sup>b</sup>	17 450
1975	10 131 <sup>d</sup>	10 131 <sup>d</sup>	21 904 <sup>c</sup>
1976	30 800 <sup>c</sup>	24 700 <sup>f</sup>	11 076 <sup>g</sup>
1977	22 400 <sup>c</sup>	22 400 <sup>c</sup>	10 908 <sup>h</sup>
1978	8300 <sup>i</sup>	8300 <sup>i</sup>	---

<sup>a</sup>Includes \$4 600 000 for lunar sample analysis and \$4 000 000 for lunar science operations.

<sup>b</sup>The lunar and planetary authorization was reduced by \$1 000 000.

<sup>c</sup>For lunar research program.

<sup>d</sup>Includes \$5 798 000 for lunar sample analysis and \$4 333 000 for lunar science operations.

<sup>e</sup>For lunar research program; includes \$6 100 000 for the transition quarter.

<sup>f</sup>Authorization figures do not include the transition quarter.

<sup>g</sup>Includes \$5 950 000 for lunar sample analysis and \$5 126 000 for lunar science operations.

<sup>h</sup>Includes \$5 943 000 for lunar sample analysis and \$4 965 000 for lunar science operations.

<sup>i</sup>Includes \$3 800 000 for lunar sample analysis and \$3 800 000 for lunar science operations.

Table 3-32. Lunar and Planetary—  
Supporting Research and Technology Funding History  
(in thousands of dollars)

Year	Request	Authorization	Programmed
1969	30 000	---	18 571
1970	24 600	24 600	18 080
1971	17 400	17 400	18 005
1972	18 800	18 800	19 218
1973	18 700	18 700	19 364
1974	16 500	--- <sup>a</sup>	11 195
1975	17 800	17 800	11 000
1976	17 900 <sup>b</sup>	14 300 <sup>c</sup>	21 054
1977	11 600	12 600	20 952 <sup>d</sup>
1978	24 400 <sup>c</sup>	29 400	43 991

<sup>a</sup>The total lunar and planetary authorization was reduced by \$1 000 000.

<sup>b</sup>Includes \$3 600 000 for the transition quarter.

<sup>c</sup>Authorization figures do not include the transition quarter.

<sup>d</sup>The program was renamed research and analysis in FY 1979.

<sup>e</sup>Includes \$5 000 000 for Mars follow-on mission definition; an additional \$10 000 000 was included in the final budget submission for Mars follow-on mission definition.

Table 3-33. Lunar and Planetary—Data Analysis Funding History  
(in thousands of dollars)

Year	Request	Authorization	Programmed
1969	2600	---	2337
1970	2700	2700	2579
1971	3900	3900	3580
1972	2400	2400	3053
1973	3500	3500	3036
1974	9700	--- <sup>a</sup>	1400
1975	10 473	10 473	1628
1976	1800 <sup>b</sup>	1400 <sup>c</sup>	9320
1977	2500	2500	10 200
1978	12 200	12 200	--- <sup>d</sup>

<sup>a</sup>The total lunar and planetary authorization was reduced by \$1 000 000.

<sup>b</sup>Includes \$400 000 for the transition quarter.

<sup>c</sup>Authorization figures do not include the transition quarter.

<sup>d</sup>Included as part of the research and analysis program (see table 3-31).

Table 3-34. Lunar and Planetary—  
Advanced Planetary Mission Technology Funding History  
(in thousands of dollars)

Year	Request	Authorization	Programmed
1969	6700	---	---

Table 3-35. Total Bioscience/Life Sciences Program Funding History  
(in thousands of dollars)

Year	Request	Authorization	Programmed
1969	48 500	33 000	30 300
1970	32 400	20 400	19 655
1971	12 900	12 900	12 898
1972	--- <sup>a</sup>	---	---
1973	---	---	---
1974	---	---	---
1975	---	---	19 <sup>4</sup> 800
1976	---	---	20 576
1977	22 125	22 125	22 125
1978	33 300	33 300	33 300

<sup>a</sup>Life sciences program was transferred to the Office of Manned Space Flight for FY 1972-1975; consult chapter 2.

Table 3-36. Bioscience—Biosatellite Funding History  
(in thousands of dollars)

Year	Request	Authorization	Programmed
1969	32 500	---	27 700
1970	18 000	6000	5970
1971	1500	1500	332

Table 3-37. Life Sciences—  
Integrated Life Sciences Shuttle/Spacelab Experiments Funding History  
(in thousands of dollars)

Year	Request	Authorization	Programmed
1977	---	---	1500
1978	1000	1000	9000

Table 3-38. Life Sciences—Space Life Sciences Funding History  
(in thousands of dollars)

Year	Request	Authorization	Programmed
1975	---	---	15 000
1976	---	---	---
1977	17 325	17 325	---



Table 3-39. Bioscience—Planetary Quarantine Funding History  
(in thousands of dollars)

Year	Request	Authorization	Programmed
1970	3000	3000	---
1971	---	---	2000
1972	--- <sup>a</sup>	---	---
1973	---	---	---
1974	---	---	---
1975	---	---	1500
1976	---	---	---
1977	1500	1500	---

<sup>a</sup>See also table 3-30.

Table 3-40. Life Sciences—Planetary Biology Funding History  
(in thousands of dollars)

Year	Request	Authorization	Programmed
1975	---	---	3300
1976	---	---	---
1977	3300	3300	---

Table 3-41. Life Sciences—Vestibular Function Research History  
(in thousands of dollars)

Year	Request	Authorization	Programmed
1977	---	---	900
1978	1500	1500	1500

Table 3-42. Bioscience/Life Sciences —  
Supporting Research and Technology Funding History  
(in thousands of dollars)

Year	Request	Authorization	Programmed
1969	16 000	---	---
1970	11 400	11 400	---
1971	---	---	10 566
1972	---	---	---
1973	---	---	---
1974	---	---	---
1975	---	---	---
1976	---	---	19 576
1977	---	---	19,725 <sup>a</sup>
1978	22 800	22 800	22 800

<sup>a</sup>Program renamed research and analysis in FY 1979.

Table 3-43. Life Sciences — Common Operating Research Equipment Funding History  
(in thousands of dollars)

Year	Request	Authorization	Programmed
1976	---	---	1000
1977	---	---	---
1978	8000	8000	---

Table 3-44. Total Launch Vehicle Procurement Funding History  
(in thousands of dollars)

Year	Request	Authorization	Programmed
1969	128 300	115 700	99 900
1970	124 200	112 600	107 819
1971	124 900	124 900	124 900
1972	146 100	146 100	151 300
1973	191 600	191 600	221 000
1974	177 000 <sup>a</sup>	177 400	178 000
1975	140 500	143 500	--- <sup>b</sup>
1976	207 300 <sup>c</sup>	166 900 <sup>d</sup>	---

<sup>a</sup>\$600 000 from FY 1973 funds was applied to the FY 1974 program; \$176 400 000 was actually requested.

<sup>b</sup>See also chap. 1, tables 1-10 through 1-13 and chap. 2, table 2-35.

<sup>c</sup>Includes \$40 400 000 for the transition quarter.

<sup>d</sup>Authorization figures do not include the transition quarter.

Table 3-45. Launch Vehicle Procurement—Agena Funding History  
(in thousands of dollars)

Year	Request	Authorization	Programmed
1969	---	---	11 300
1970	7300	6300	5000

Table 3-46. Launch Vehicle Procurement—Atlas F Funding History  
(in thousands of dollars)

Year	Request	Authorization	Programmed
1976	3400	3400	--- <sup>a</sup>

<sup>a</sup>See also table 1-10.

Table 3-47. Launch Vehicle Procurement—Centaur Funding History  
(in thousands of dollars)

Year	Request	Authorization	Programmed
1969	---	---	44 200
1970	57 600	52 600	46 019
1971	68 100	68 100	66 000
1972	75 900	75 900	82 200
1973	106 500	106 500	120 700
1974	115 000	115 000	106 000
1975	75 000	75 000	--- <sup>a</sup>
1976	140 200 <sup>b</sup>	113 800 <sup>c</sup>	---

<sup>a</sup>See also table 1-11.

<sup>b</sup>Includes \$26 400 000 for the transition quarter.

<sup>c</sup>Authorization figures do not include the transition quarter.

Table 3-48. Launch Vehicle Procurement—Delta Funding History  
(in thousands of dollars)

Year	Request	Authorization	Programmed
1969	30 800	---	24 300
1970	33 700	32 100	32 400
1971	34 000	34 000	37 500
1972	37 200	37 200	41 000
1973	41 900	41 900	76 000
1974	46 000	47 000	60 200
1975	47 700	50 700	--- <sup>a</sup>
1976	46 900 <sup>b</sup>	36 600 <sup>c</sup>	---

<sup>a</sup>See also table 1-12.

<sup>b</sup>Includes \$10 300 000 for the transition quarter.

<sup>c</sup>Authorization figures do not include the transition quarter.

Table 3-49. Launch Vehicle Procurement—Scout Funding History  
(in thousands of dollars)

Year	Request	Authorization	Programmed
1969	16 500	---	12 600
1970	15 700	11 700	13 700
1971	15 100	15 100	13 200
1972	16 500	16 500	15 100
1973	21 000	21 000	15 700
1974	12 000	12 000	7800
1975	13 800	13 800	---- <sup>a</sup>
1976	15 500 <sup>b</sup>	12 100 <sup>c</sup>	---

<sup>a</sup>See also table 1-15.

<sup>b</sup>Includes \$3 400 000 for the transition quarter.

<sup>c</sup>Authorization figures do not include the transition quarter.

Table 3-50. Launch Vehicle Procurement—Titan IIIC Funding History  
(in thousands of dollars)

Year	Request	Authorization	Programmed
1969	---	---	3100
1970	5900	5900	6700
1971	4700	4700	4100
1972	12 500	12 500	9000
1973	18 200	18 200	5500

Table 3-51. Launch Vehicle Procurement—  
Supporting Research and Technology Funding History  
(in thousands of dollars)

Year	Request	Authorization	Programmed
1969	4000	---	4400
1970	4000	4000	4000
1971	3000	3000	4100
1972	4000	4000	4000
1973	4000	4000	3100
1974	4000	4000	4000
1975	4000	4000	---- <sup>a</sup>
1976	1300 <sup>b</sup>	1000 <sup>c</sup>	---

<sup>a</sup>See also table 1-8.

<sup>b</sup>Includes \$300 000 for the transition quarter.

<sup>c</sup>Authorization figures do not include the transition quarter.

Table 3-52. Launch Vehicle Procurement—Structures and Materials Funding History  
(in thousands of dollars)

Year	Request	Authorization	Programmed
1969	600	---	---

Table 3-53. Launch Vehicle Procurement—Vehicle Engineering Funding History  
(in thousands of dollars)

Year	Request	Authorization	Programmed
1969	200	---	---

## MISSION CHARACTERISTICS

Space science projects during the 1970s fell into one of three broad programs: physics and astronomy, lunar and planetary science, or life sciences. Each program is discussed in the following pages. Individual flight projects are highlighted within the appropriate program.

### DESCRIPTION—PHYSICS AND ASTRONOMY PROGRAM

NASA's space science efforts were largely divided between two categories: physics and astronomy or lunar and planetary. The agency launched 53 payloads that were dedicated to the physics and astronomy program during NASA's second decade of operations. Specialists working in such fields as astronomy, solar physics, particles and fields, and ionospheric physics contributed to man's knowledge of earth, the near-earth environment, and earth's relationship with its sun. They did so by sending their instruments above earth's obscuring atmosphere on board a variety of satellites.<sup>4</sup>

Explorer and Explorer-class satellites provided investigators with 42 opportunities for investigations. For the several kinds of Explorers, scientists designed experiments that could record data on gamma rays, x-rays, energetic particles, the solar wind, meteoroids, radio signals from celestial sources, solar ultraviolet radiation, and other phenomena. Many of the Explorer-class missions were joint endeavors conducted by NASA and other countries, part of the agency's international program.

Four observatory-class spacecraft provided flexible orbiting platforms for scientific experiments. The last of the Orbiting Geophysical Observatories (*OGO 6*), NASA's first multiuse "streetcar" satellite design that could accommodate a variety of instruments, performed its mission in 1969. *OGO* participants studied data gathered on atmospheric composition.

One Orbiting Astronomical Observatory (*OAO 3*) sent eight years' worth of information on the composition, density, and physical state of matter in interstellar space.

High-quality data on x-ray, gamma ray, and cosmic ray sources were the rewards returned by three High Energy Astronomy Observatories. HEAO was NASA's most expensive physics and astronomy project of the 1970s and one of its most productive.

The Orbiting Solar Observatory series, begun in the 1960s, took on a new look with *OSO 8*. After the launch of three more OSO spacecraft of the original design, NASA orbited a much larger satellite created to investigate the sun's lower corona, the chromosphere, and their interface in the ultraviolet spectral region.

The following sections describe these four programs and provide mission details for each mission.

Jesse Mitchell, who became director for the physics and astronomy program in 1966, stayed in this post until 1973, when Alois W. Schardt succeeded him. In 1976, T. B. Norris took over the post and saw the program through the rest of the agency's second decade. At NASA Headquarters, program managers for each of the major flight programs reported to the director, as did chiefs for such disciplines as solar physics, magnetospheric physics, and astronomy. The major centers contributing to physics and astronomy projects were the Goddard Space Flight Center and Marshall Space Flight Center.

## Explorer

"Explorer," as the name of a scientific satellite, had many meanings. The original Explorer program predated NASA, with the launch of the Army Ballistic Missile Agency's small torpedo-shaped *Explorer 1* taking place on January 31, 1958. The civilian space agency inherited the Army's Explorer program and adopted the name to refer to its several series of simple, small, and relatively inexpensive satellites used to further physics and astronomy investigations. During its first decade, NASA successfully launched 35 satellites bearing the Explorer name to perform a variety of data-gathering tasks. Additionally, the U.S. assisted other countries with the building and launching of other Explorer-class spacecraft with designations like Alouette, San Marco, and ESRO.

NASA's space scientists involved in solar-terrestrial and astrophysics research continued to use the Explorer program during the 1970s. Table 3-54 summarizes the various Explorer missions; tables 55-70 provide details on each specific flight.

Three atmospheric Explorers (*Explorer 51*, *54*, and *55*) sought temperature, composition, density, and pressure data to permit the study of the physics of the atmosphere on a global basis. Researchers were particularly interested in studying the relationship of solar ultraviolet activity to atmospheric composition in the lower thermosphere. Experiments were devised by investigators at more than a dozen institutions for this RCA Astro-Electronics-manufactured satellite. The Goddard Space Flight Center managed the project.

The earth's magnetosphere was the object of study for a large number of Explorer missions, of which there were several distinct types. *Explorer 45*, made in-house at Goddard, was launched to study the dynamic processes that occur in the inner magnetosphere at distances from two to five earth radii. *Explorer 52*, the last

of the University of Iowa Hawkeye/Injun series, was put into solar orbit to collect data on the interaction of the solar wind with the geomagnetosphere over the polar caps. The last 4 of a series of 10 interplanetary monitoring platform (IMP) Explorers began their work during the second decade of NASA's operations, assisting with the study of interplanetary radiation and magnetic fields within and beyond earth's magnetosphere. Instruments from many scientific institutions were included on the payloads of Goddard's *Explorer 41, 43, 47, and 50*.

NASA's Wallops Station and the Naval Research Laboratory worked together to instrument and launch *Explorer 44*, a solar physics investigation. The spacecraft was designed to monitor the solar flux in a number of wavelength bands, with special emphasis on the ultraviolet region of the spectrum.

Johns Hopkins Applied Physics Laboratory joined with Goddard to develop two x-ray astronomy Explorers. *Explorer 42 and 53* carried instruments to earth orbit to study celestial x-ray sources. *Explorer 48*, a Goddard-built spacecraft, sought galactic and extragalactic gamma ray point sources. A Delta launch vehicle placed *Explorer 49* in orbit about the moon so that it could measure the intensity of radio signals from celestial sources. Radio astronomers at Goddard were rewarded by data on cosmic background noises, solar radio burst phenomena, and radio emissions from earth.

For international satellite projects of the Explorer class, see this chapter under "Other Physics and Astronomy Projects."

Table 3-54. Explorer Satellites, 1969-1978

Explorer Mission	Launch Date	Class
41/IMP-G	June 21, 1969	Interplanetary monitoring platform (IMP)
42/Uhuru/SAS-A	Dec. 12, 1970	X-ray astronomy
43/IMP-I	Mar. 13, 1971	IMP
44/Solrad 10	July 8, 1971	Solar physics
45	Nov. 15, 1971	Magnetospheric
46	July 13, 1972	Meteoroid technology
47/IMP-H	Sept. 22, 1972	IMP
48/SAS-B	Nov. 16, 1972	Gamma ray astronomy
49/RAE-B	June 10, 1973	Radio astronomy
50/IMP-J	Oct. 25, 1973	IMP
51	Dec. 15, 1973	Atmospheric
52/Hawkeye 1/Injun F	June 3, 1974	Magnetospheric
53/SAS-C	May 7, 1975	X-ray astronomy
54	Oct. 6, 1975	Atmospheric
55	Nov. 20, 1975	Atmospheric

Table 3-55. *Explorer 41* Characteristics

---

Also called: Interplanetary Monitoring Platform G (IMP-G)  
 Date of launch (range): June 21, 1969 (WTR)  
 Launch vehicle: Delta E  
 Shape: octagonal with 4 solar paddles  
 Weight (kg): 78.7  
 Dimensions (m): 0.71, diameter  
                   0.25, height  
 Power source: solar arrays plus AgCd battery  
 Prime contractor: in-house  
 Date of reentry: Dec. 23, 1972  
 Responsible NASA center: GSFC  
 Project manager: Paul Butler  
 Project scientist: Frank B. McDonald  
 Objectives: To obtain measurements from the plasma and energetic particle experiments to allow continuation and extension of studies of the environment within and beyond earth's magnetosphere (7th in series).  
 Experiments (responsible organization):  
   Low-energy telescope (Bell Telephone Laboratories, Inc.)  
   Ion chamber (Univ. of California, Berkeley)  
   Low-energy solar flare electron detector (Univ. of CA, Berkeley)  
   Composition of cosmic rays (Univ. of Chicago)  
   Low-energy proton and electron differential energy analyzer (Univ. of Iowa)  
   Low-energy proton differential energy analyzer (Univ. of IA)  
   Cosmic ray anisotropy (Southwest Center for Advanced Studies)  
   Solar proton detector (GSFC and Applied Physics Laboratory, Johns Hopkins)  
   Plasma composition and ion energy distribution (GSFC and Univ. of Maryland)  
   Low-energy proton and alpha detector (GSFC)  
   Energy vs energy loss (GSFC)  
   Magnetic fields (GSFC)  
 Results: Successful; also used in July-Aug. 1972 to observe solar flare activity.

---

Reference: MOR S-861-69-07, June 13, 1969; and NASA Hq. Release 69-89, "IMP-G," June 15, 1969.

Table 3-56. *Explorer 42* Characteristics

---

Also called: Uhuru or Small Astronomy Satellite--A Explorer (SAS-A)  
 Date of launch (range): Dec. 12, 1970 (San Marco)  
 Launch vehicle: Scout  
 Shape: cylindrical  
 Weight (kg): 81.6  
 Dimensions (m): 0.56, diameter  
                   0.51, height  
 Power source: solar array plus NiCd battery  
 Prime Contractor: American Science & Engineering and Applied Physics Laboratory, Johns Hopkins  
 Date of reentry: Apr. 5, 1979  
 Responsible NASA center: GSFC  
 Project manager: Margorie R. Townsend, Carl E. Fichtel  
 Project experiments manager: D. P. Wrublik  
 Objectives: To develop a catalog of celestial x-ray sources by systematic scanning of the celestial sphere in the energy range 2-20 keV.  
 Experiments (responsible organization):  
   Advanced x-ray (American Science & Engineering)  
 Results: Successful; returned useful data through 1974; the satellite was turned off in 1975 and reactivated in 1977.

---

Reference: MOR S-878-70-01, Dec. 7, 1970.



Table 3-57. *Explorer 43* Characteristics

---

Also called:	Interplanetary Monitoring Platform I (IMP-I)
Date of launch (range):	March 13, 1971 (ETR)
Launch vehicle:	Delta E
Shape:	16-sided (drum-shaped)
Weight (kg):	288
Dimensions (m):	1.3, diameter 1.8, overall height
Power source:	Solar arrays plus AgCd battery
Prime contractor:	in-house
Date of reentry:	Oct. 2, 1974
Responsible NASA center:	GSFC
Project manager:	Butler
Project scientist:	McDonald
Objectives:	To obtain adequate particle and fields data to allow continuation and extension of studies of the cislunar environment during a period of decreasing solar activity.
Experiments (responsible organization):	cosmic ray, 2 (GSFC; University of Chicago) low-energy particles (University of Iowa) medium-energy particles (University of California) solar protons (Applied Physics Laboratory, Johns Hopkins, and GSFC) solar electrons (University of Denver and GSFC) plasma, 2 (GSFC; Atomic Energy Commission) DC electric fields (GSFC) AC electric fields (University of Iowa) electric and magnetic fields (Univ. of Minnesota) magnetic fields (GSFC) Impedance probe and radiometer (Univ. of Maryland and GSFC) Radiometer (Univ. of Michigan) SDP-3 computer (GSFC)
Results:	Successful.

---

Reference: MOR S-861-71-08, March 1, 1971.

Table 3-58. *Explorer 44* Characteristics

---

Also called:	<i>Solrad 10</i> or Solar Radiation C Explorer
Date of launch (range):	July 8, 1971 (Wallops)
Launch vehicle:	Scout
Shape:	cylindrical (12-sided)
Weight (kg):	115
Dimensions (m):	0.76, diameter 0.58, height
Power source:	solar panels plus NiCd battery
Prime contractor:	in-house, Naval Research Laboratory
Date of reentry:	Dec. 15, 1979
Responsible NASA center:	Wallops Station, responsible for launch vehicle, technical support, and tracking and data acquisition.
Project coordinator:	W. H. Lee
Objectives:	To monitor the solar flux in a number of wavelength bands of interest to solar and aeronomy research; a joint project with the Naval Research Laboratory, with NRL providing the spacecraft and experiments.
Experiments:	<ul style="list-style-type: none"> <li>solar x-ray monitor, 2</li> <li>solar electron temperature</li> <li>solar Lyman Alpha monitor</li> <li>solar ultraviolet monitor</li> <li>solar ultraviolet continuum flash</li> <li>background x-ray level</li> <li>solar hard x-ray continuum</li> <li>solar Lyman Alpha bursts</li> <li>solar hard x-ray monitor</li> <li>solar excitation of F-layer</li> <li>skin anti-solar temperature</li> <li>stellar x-ray variations</li> </ul>
Results:	Successful.

---

Reference: MOR S-858-71-03, June 21, 1971.

Table 3-59. *Explorer 45* Characteristics

---

Also called: Small Scientific Satellite A  
 Date of launch (range): Nov. 15, 1971 (San Marco)  
 Launch vehicle: Scout  
 Shape: polyhedron (26-sided)  
 Weight (kg): 50  
 Dimensions (m): 0.64, diameter  
 Power source: solar array plus AgCd battery  
 Prime contractor: in-house  
 Date of reentry: N/A  
 Responsible NASA center: GSFC  
 Project manager: Gerald W. Longanecker  
 Project scientist: Robert Hoffman  
 Objectives: To study the dynamic processes that occur in the inner magnetosphere from 2-5 earth radii  
 Experiments (responsible organization):  
   Charged particle detectors:  
     Channeltrons (GSFC and National Oceanic and Atmospheric Administration)  
     Solid-state proton detectors (NOAA and MSFC)  
     Solid-state electron detectors (NOAA)  
     Spin-stabilized channeltrons (GSFC and NOAA)  
   Magnetic field detectors:  
     Fluxgate magnetometer (Univ. of Minnesota)  
     Search-coil magnetometer (Univ. of MN)  
   Electric field sensors:  
     AC (Univ. of Iowa)  
     DC (GSFC)

Results: Successful; in operation through Sept. 1974.

---

Reference: MOR S-857-71-01, Nov. 3, 1971.

Table 3-60. *Explorer 46* Characteristics

---

Also called: *Meteoroid Technology Satellite*  
 Date of launch (range): July 13, 1972 (Wallops)  
 Launch vehicle: Scout  
 Shape: cylindrical with 12 experiment panels  
 Weight (kg): 167.8  
 Dimensions (m): 3.2, height  
                   7.1, bumper tip to tip  
 Power source: solar array plus AgCd battery  
 Prime contractor: in-house  
 Date of reentry: Nov. 2, 1979  
 Responsible NASA center: LaRC  
 Project manager: Charles V. Woerner  
 Project scientist: William H. Kinard  
 Objectives: To provide measurements of the meteoroid penetration rates in a bumper-protected target and of meteoroid impact velocity.  
 Experiments (responsible organization):  
   bumper cell detectors (LaRC)  
   meteoroid velocity detectors (LaRC)  
   impact flux detectors (LaRC)

Results: Partially successful; a wing deployment malfunction prevented full data return; however, the primary experiment operated for two years.

---

Reference: MOR R-713-72-05, Aug. 1, 1972.

Table 3-61. *Explorer 47* Characteristics

---

Also Called: Interplanetary Monitoring Platform H (IMP-H)  
 Date of launch (range): Sept. 22, 1972 (ETR)  
 Launch vehicle: Delta E  
 Shape: 16 sided (drum-shaped)  
 Weight (kg): 375.9  
 Dimensions (m): 1.36, diameter  
                   1.58, height  
 Power source: solar panels plus AgCd battery  
 Prime contractor: in-house  
 Date of reentry: N/A  
 Responsible NASA center: GSFC  
 Project manager: Butler  
 Project scientist: N. F. Ness  
 Objectives: To obtain particle and field data to allow continuation and extension of studies of the cislunar environment during a period of decreasing solar activity.  
 Experiments (responsible organization):  
   Magnetic fields (GSFC)  
   Plasma wave (TRW)  
   Cosmic ray, 2 (GSFC; Univ. of Chicago)  
   Energetic particles (National Oceanic and Atmospheric Administration)  
   Charged particles (Applied Physics Laboratory, Johns Hopkins)  
   Electrons and isotopes (California Institute of Technology)  
   Ions and electrons (Univ. of Maryland)  
   Solar electrons (GSFC)  
   Ion composition (GSFC)  
   Low-energy particles (Univ. of Iowa)  
   Plasma (Los Alamos Scientific Laboratory and Massachusetts Institute of Technology)  
 Results: Successful.

---

Reference: MOR S-861-72-09, Aug. 31, 1972.

Table 3-62. *Explorer 48* Characteristics

---

Also called: Small Astronomy Satellite B (SAS-B) or Gamma Ray Explorer  
 Date of launch (range): Nov. 16, 1972 (San Marcos)  
 Launch vehicle: Scout  
 Shape: cylindrical with 4 solar paddles  
 Weight (kg): 92  
 Dimensions (m): 0.59, diameter  
                   0.51, height  
 Power source: solar array plus NiCd battery  
 Prime contractor: GSFC  
 Date of reentry: Aug. 20, 1980  
 Responsible NASA center: GSFC  
 Project manager: Townsend  
 Project scientist: Fichtel  
 Objectives: To measure the spatial and energy distribution of primary galactic and extragalactic gamma radiation.  
 Experiments (responsible organization):  
   gamma ray, digitized spark chamber (GSFC)  
 Results: Successful.

---

Reference: MOR S-878-72-02, Nov. 13, 1972.

Table 3-63. *Explorer 49* Characteristics

---

Also called:	Radio Astronomy Explorer B (RAE-B)
Date of launch (range):	June 10, 1973 (ETR)
Launch vehicle:	Delta 1913
Shape:	truncated cylinder with 4 solar paddles
Weight (kg):	330.2
Dimensions (m):	0.92, diameter; 1.83 with cameras and solar arrays 0.79, height; 1.47, with cameras and solar arrays 1.60, length with cameras and solar arrays
Power source:	solar array plus NiCd battery
Prime contractor:	in-house
Date of reentry:	N/A
Responsible NASA center:	GSFC
Project manager:	John T. Shea
Project scientist:	Robert G. Stone
Objectives:	To measure from lunar orbit the intensity of radio signals from celestial sources as a function of frequency, direction, and time in the frequency range below 20 MHz.
Experiments (responsible organization):	Galactic studies (GSFC) Sporadic low-frequency solar radio bursts (GSFC) Observations of sporadic Jovian bursts (GSFC) Radio emission from the terrestrial magnetosphere (GSFC) Observations of cosmic sources (GSFC)
Results:	Successful; in addition to data from the experiments, lunar gravity analysis data were also obtained.

---

Reference: MOR S-877-73-02, June 6, 1973.

Table 3-64. *Explorer 50* Characteristics

---

Also called: Interplanetary Monitoring Platform J (IMP-J)  
Date of launch (range): Oct. 25, 1973 (ETR)  
Launch vehicle: Delta 1604  
Shape: 16-sided (drum-shaped)  
Weight (kg): 397.2  
Dimensions (m): 1.26, diameter  
                  1.58, height  
Power source: solar arrays plus AgCd battery  
Date of reentry: N/A  
Prime contractor: in-house  
Responsible NASA center: GSFC  
Project manager: William R. Limberis  
Project scientist: Norman F. Hess  
Objectives: To perform detailed and near-continuous studies of the interplanetary environment for orbital periods comparable to several rotations of active solar region and study particle and field interactions in the distant magnetotail.  
Experiments (responsible organization):  
    Magnetic fields (GSFC)  
    Cosmic ray, 2 (GSFC; Univ. of Chicago)  
    Energetic particles (National Oceanic and Atmospheric Administration)  
    Charged particles (Applied Physics Laboratory, Johns Hopkins)  
    Electrons and isotopes (California Institute of Technology)  
    Ions and electrons (Univ. of Maryland)  
    DC electric fields (GSFC)  
    AC electric and magnetic fields (Univ. of Iowa)  
    Low-energy particles (Univ. of Iowa)  
    Plasma, 2 (Los Alamos Scientific Laboratory; Massachusetts Institute of Technology)  
Results: Successful; last in a series of 10 IMPs.

---

Reference: MOR S-861-73-10, Oct. 12, 1973.

Table 3-65. *Explorer 51* Characteristics

---

Also called:	Atmosphere Explorer C
Date of launch (range):	Dec. 15, 1973 (WTR)
Launch Vehicle:	Delta 1900
Shape:	polyhedron (16-sided)
Weight (kg):	668
Dimensions (m):	1.35, diameter 1.15, height
Power source:	solar cells plus NiCd batteries
Prime contractor:	RCA Astro-Electronics Div.
Date of reentry:	Dec. 12, 1978
Responsible NASA center:	GSFC
Project Manager:	R. Stephens
Project scientist:	Nelson W. Spencer
Objectives:	To obtain data relating solar ultraviolet activity to atmospheric composition in the lower thermosphere.
Experiments (responsible organization):	Ultraviolet (nitric oxide) photometer (Univ. of Colorado) Cylindrical electrostatic probe (GSFC and Harvard College Observatory) Bennett (positive) ion mass spectrometer (GSFC) Atmosphere density accelerometer (Air Force Cambridge Research Laboratories) Photoelectron spectrometer (Applied Physics Laboratory, Johns Hopkins) Retarding potential analyzer (Univ. of Texas at Dallas) Visual airglow photometer (Univ. of Michigan, Yale University, and Univ. of Toronto) Solar EUV filter photometer (GSFC) Solar EUV spectrophotometer (AFCRL) Magnetic ion mass spectrometer (Univ. of TX at Dallas and National Oceanic and Atmospheric Administration) Low-energy electron spectrometer (GSFC and NOAA) Open source neutral mass spectrometer (Univ. of Minnesota) Closed source neutral mass spectrometer (GSFC and Univ. of MN) Neutral atmosphere temperature spectrometer (Smithsonian Astrophysical Observatory, Harvard, and Yale)
Results:	Successful; 2d-generation Atmosphere Explorer; data received by an aeronomy team of 17 scientists from 9 installations.

---

Reference: MOR S-852-73-03, Dec. 7, 1973.

Table 3-66. *Explorer 52* Characteristics

---

Also called: *Hawkeye 1* or Injun F  
 Date of launch (range): June 3, 1974 (WTR)  
 Launch vehicle: Scout  
 Shape: truncated cone  
 Weight (kg): 26.6  
 Dimensions (m): 0.75 base diameter  
                   0.25, top diameter  
                   0.75, height  
 Power source: solar arrays plus AgCd battery  
 Prime contractor: University of Iowa  
 Reentry date: Apr. 28, 1978  
 Responsible NASA center: LaRC  
 Project manager: C. W. Coffee  
 Objectives: To study the interaction of the solar wind with the geomagnetosphere at large radial distances over earth's polar caps.  
 Experiments (responsible organization):  
     Magnetometer (LaRC and Univ. of Iowa)  
     Low-energy proton-electron differential energy analyzer (LaRC and Univ. of Iowa)  
 Results: Successful; continuation of Univ. of Iowa's Injun series.

---

Reference: MOR S-863-74-04, May 13, 1974.

Table 3-67. *Explorer 53* Characteristics

---

Also called: Small Astronomy Satellite C (SAS-C)  
 Date of launch (range): May 7, 1975 (San Marco)  
 Launch Vehicle: Scout  
 Shape: cylindrical with 4 solar paddles  
 Weight (kg): 196.7  
 Dimensions (m): 1.45, diameter  
                   4.70, tip to tip  
 Power source: solar array plus NiCd battery  
 Prime Contractor: Center for Space Research, Massachusetts Institute of Technology, and Applied Physics Laboratory, Johns Hopkins  
 Date of reentry: Apr. 9, 1979  
 Responsible NASA center: GSFC  
 Project Manager: Townsend  
 Project scientist: Fichtel  
 Objectives: To investigate celestial sources radiating in the x-ray, gamma ray, ultraviolet, visible, and infrared spectral regions of the electromagnetic spectrum, specifically to measure the x-ray emission of discrete extragalactic sources.  
 Experiments (responsible organization):  
     Extragalactic monitor (GSFC)  
     Galactic monitor (GSFC)  
     Scorpio monitor (GSFC)  
     Galactic absorption (GSFC)  
 Results: Successful; returned data for 4 years; launched with *Anik 3*, a Canadian communications satellite.

---

Reference: MOR S-878-75-03, May 6, 1975.



Table 3-68. *Explorer 54* Characteristics

---

Also called: Atmospheric Explorer D  
 Date of launch (range): Oct. 6, 1975 (WTR)  
 Launch vehicle: Delta 2910  
 Shape: polyhedron (16-sided)  
 Weight (kg): 675  
 Dimensions (m): 0.14, diameter  
                   0.12, height  
 Power source: solar cells plus NiCd battery  
 Prime contractor: RCA, Astro-Electronics Div.  
 Date of reentry: March 12, 1976  
 Responsible NASA center: GSFC  
 Project director: David W. Grimes  
 Project scientist: Nelson W. Spencer  
 Objectives: To obtain data relating solar ultraviolet activity to atmospheric composition in the lower atmosphere.  
 Experiments (responsible organization): same as for *Explorer 51*  
 Results: Partially successful; returned data for only 3½ months because of a power supply system failure; the satellite had been designed for a one-year lifetime.

---

Reference: MOR S-852-75-04, Sept. 26, 1975.

Table 3-69. *Explorer 55* Characteristics

---

Also called: Atmospheric Explorer E  
 Date of launch (range): Nov. 20, 1975 (ETR)  
 Launch vehicle: Delta 2910  
 Shape: polyhedron (16-sided)  
 Weight (kg): 675  
 Dimensions (m): 0.14, diameter  
                   0.12, height  
 Power source: solar cells plus NiCd battery  
 Prime contractor: same as for *Explorer 54*  
 Date of reentry: June 10, 1981  
 Responsible NASA center: GSFC  
 Project director: Grimes  
 Project scientist: Spencer  
 Objectives: To investigate the chemical processes and energy transfer mechanisms that control the structure and behavior of earth's atmosphere and ionosphere through the region of high solar energy absorption.  
 Experiments (responsible organization):  
     backscatter ultraviolet spectrometer  
 Results: Successful; returned data for 5½ years.

---

Reference: MOR S-852-75-05, Nov. 13, 1975.

Table 3-70. Dual Air Density Explorers Characteristics

---

Also called: If successful would have been Explorer 56 and 57.  
 Date of launch (range): Dec. 6, 1975 (WTR)  
 Launch vehicle: Scout  
 Shape:  
   DAD-A: spherical (rigid)  
   DAD-B: spherical (erectable)  
 Weight (kg):  
   DAD-A: 35.3  
   DAD-B: 35.8  
 Dimensions (m):  
   DAD-A: 0.76, diameter  
   DAD-B: 3.66, diameter  
 Power source: solar cells plus NiCd battery, DAD-A  
 Prime contractor: in-house  
 Date of reentry: N/A  
 Responsible NASA center: LaRC  
 Project manager: J. E. Canady, Jr.  
 Project scientist: E. J. Prior  
 Objectives: To determine the vertical structure of the upper atmosphere and lower exosphere as a function of latitude, season, and local solar time.  
 Experiments (responsible organization):  
   Magnetic mass spectrometer with a Mattauch-Herzog geometry (Univ. of Minnesota)  
 Results: Unsuccessful due to launch vehicle failure (3d and 4th stage malfunctions).

---

Reference: MOR S-863-75-05, Dec. 2, 1975.

### High Energy Astronomy Observatory

The primary objective of the High Energy Astronomy Observatory (HEAO) program was to obtain high-quality, high-resolution data on x-ray, gamma ray, and cosmic ray sources. Experiments were designed to provide data on the structure, spectra, polarization, synoptic variations, and location of these sources. HEAO was NASA's primary physics and astronomy project planned for the 1970s.

NASA had begun its search for information on celestial energy sources during its first decade, using Explorer satellites to gather data on cosmic radiation. *Explorer 11* (1961) was the first astronomical satellite designed to detect high-energy gamma rays. The Small Astronomy Satellite series (*Explorer 42*, *48*, and *53*) was launched during the 1970s to return data on x-ray, gamma ray, and ultraviolet sources. *Explorer 42*, also called *Uhuru*, was the first satellite completely dedicated to x-ray astronomy. In the late 1960s during early discussions of a large satellite project dedicated to high-energy astronomy observations, some participants labeled it a "Super Explorer."<sup>5</sup>

As originally conceived, HEAO was a much larger satellite than any of the Explorers. The two cylindrical HEAO satellites would weigh 9700 kilograms (the heaviest Explorer of the 1970s was 675 kilograms) and measure  $11.5 \times 3$  meters. With 13 000 kilograms of experiments aboard, HEAO would be launched by a Titan IIIC, D, or E. Additionally, advanced planners were working on two follow-on mis-

sions. In 1969, NASA Headquarters assigned the management of HEAO to the Marshall Space Flight Center in Huntsville, Alabama.\*

With the initial design studies completed in-house, MSFC issued its first request for proposals (RFP) for a preliminary design study of HEAO in February 1970 and held a briefing for scientists and instrument builders in April. MSFC announced in May that Grumman Aerospace Corporation and TRW, Inc., would work under separate contracts to define the observatory further. While the two contractors performed their tasks, NASA scientists reviewed the 55 proposals they had received for HEAO experiments, choosing 7 experiments for HEAO-A and 5 with 1 reserve for HEAO-B in late 1970. In April 1971, TRW and Grumman had completed their studies and were preparing their bids for the final development and fabrication contract, which was won by TRW late in the year. The contract called for system engineering of the payload, design and development of the spacecraft, procurement and integration of the orbit adjust stage and shroud, experiments integration, design, development, and delivery of one set of ground support equipment, launch operations support, and mission operations support for up to two years after launch. With the endorsement of the National Academy of Sciences, NASA and its contractors were proceeding toward their first 1975 launch deadline when a budget cut by Congress in January 1973 forced them to halt their plans for at least a year while Headquarters officials looked for ways to reduce its science program by at least \$95 million.

HEAO was redefined. The two large observers were replaced by three smaller satellites able to carry 3000 kilograms of experiments (see fig. 3-1). The agency was forced to drop some of the original experiment proposals, but directed the investigators to resize their hardware where possible. New requirements for modular experiment packages rather than a single integrated experiment system would also save money. NASA retained TRW as its prime spacecraft contractor, who reported that approximately 80% of the systems planned for HEAO had been flown on previous satellites, which would translate into additional money saved. Atlas-Centaur replaced Titan as the launch vehicle for the missions, which were postponed until 1977-1979.

HEAO-A was dedicated to scanning x-ray experiments; HEAO-B, which would require additional attitude positioning equipment, would carry a pointing x-ray telescope; and HEAO-C would scan for gamma and cosmic rays. The objective of the x-ray studies was a survey of the sky for x-ray sources down to about  $10^{-6}$  times the intensity of the brightest known source and to investigate the shape and structure of x-ray sources with high-resolution instruments. Gamma ray observations would concentrate on a broad survey of the sky and on high-resolution studies of individual sources. Primary cosmic rays investigations would require large detector areas and long observing times so that a survey of cosmic ray particulates with statistically meaningful numbers could be obtained.

---

\*Headquarters had also considered the Goddard Space Flight Center, manager of most of the related Explorer satellites, as manager of HEAO. Because MSFC had already begun work on the Apollo Telescope Mount, a large-scale astronomy project, for Skylab and had been reorganized in January 1969 in part to strengthen the role of science at the center, the Office of Space Science and Applications awarded HEAO to MSFC. In addition, HEAO as originally planned was not the class of satellite that GSFC was accustomed to managing.

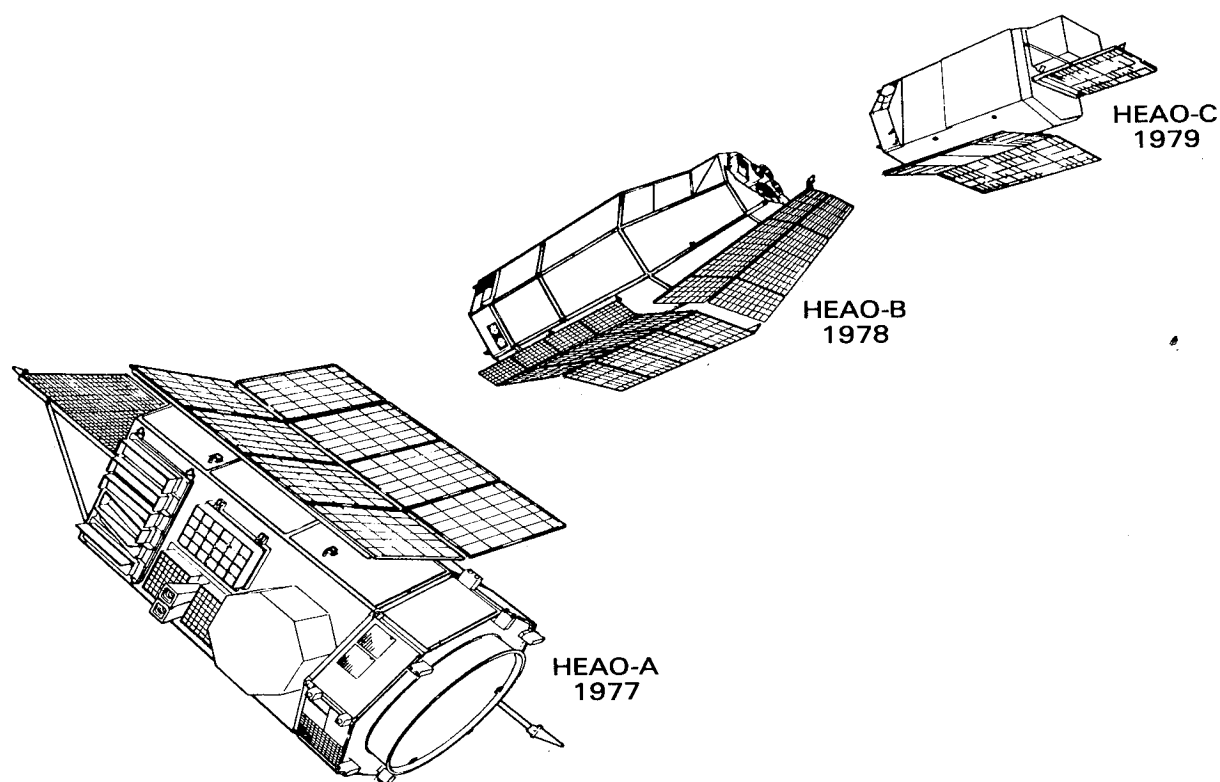

Figure 3-1. HEAO High Energy Astronomy Observatory

Tables 3-72, 73, and 74 list the individual experiments conducted by the three observatories (four for *HEAO 1*, five for *HEAO 2*, and three for *HEAO 3*) and the organizations that served as contractors. The California Institute of Technology, Washington University, the University of Minnesota, MIT, the University of California at San Diego, the Naval Research Laboratory, Columbia University, and the Goddard Space Flight Center were among the original experiment proposers.

Atlas-Centaur vehicles launched all three HEAO satellites successfully into low-earth orbits. Scheduled for six months of operations, *HEAO 1*, launched in August 1977, exhausted its supply of control gas in January 1979. Placed in orbit in November 1978, *HEAO 2*—an orbiting pointing x-ray telescope—operated with a high rate of success for 30 months. *HEAO 3*, launched in September 1979, returned data for 20 months.

F. A. Speer was project manager at Marshall, with R. E. Halpern serving as program manager at NASA Headquarters. The Goddard Space Flight Center served as the mission operations center for HEAO. Table 3-71 provides a chronology of HEAO's development and operations.

Table 3-71. Chronology of High Energy Astronomy Observatory Development and Operations

Date	Event
Spring 1969	NASA Headquarters assigned the management of a high-energy astronomy satellite project to the Marshall Space Flight Center (MSFC), Huntsville, AL. MSFC began a preliminary definition study (phase A) for a High Energy Astronomy Observatory (HEAO).
Sept. 1969	NASA recommended to the president's Space Task Group (STG) that high-energy astronomy capability was a high-priority scientific goal. The STG echoed that recommendation in its report to President Richard M. Nixon.
Feb. 26, 1970	MSFC issued a request for proposals (RFP) to 20 firms for a phase B preliminary design study for HEAO. Plans called for two large 9700-kilogram satellites.
Mar. 1970	MSFC established an HEAO Task team led by Rodney D. Stewart.
Mar. 19, 1970	A Grumman Aerospace Corp.-Bendix Corp.-Hughes Aircraft Co. team was the first to announce its intentions to bid for the HEAO contract.
Apr. 1, 1970	MSFC held a preproposal briefing for 155 scientists and industry representatives interested in participating in HEAO.
Apr. 14, 1970	General Electric's Space Systems Organization, teamed with American Science and Engineering, Inc., and the Radiation Systems Division of Harris-Intertype, announced that it would also be bidding for the HEAO contract.
May 22, 1970	MSFC announced that Grumman and TRW, Inc., had been chosen for HEAO phase B contracts.
July 7, 1970	John E. Naugle, associate administrator for space science and applications, and other managers from NASA Headquarters met with the MSFC HEAO team to discuss the project.
Nov. 8, 1970	NASA announced that it had chosen seven proposals for experiments for HEAO-A and five with one backup for HEAO-B from a total of 55 proposals.
Dec. 1-2, 1970	The principal investigators of the proposed HEAO experiments met at MSFC for a briefing.
Mar. 9, 1971	In <i>Priorities for Space Research</i> , the National Academy of Sciences-National Research Council Space Science Board recommended that NASA assign high priority funding to its HEAO program.
Mar. 29, 1971	MSFC announced that it had let 10 seven-month phase B definition contracts for HEAO experiments.
Apr. 1971	TRW and Grumman completed their phase B studies.
Apr. 21, 1971	The MSFC director named F. A. Speer manager of the HEAO Task Team; the team was redesignated the HEAO Program Office in August.
July 7, 1971	MSFC issued an RFP for the development, manufacture, and testing of two HEAO satellites.
Aug. 27, 1971	Grumman and TRW submitted contract bids for HEAO.
Oct. 28, 1971	NASA announced that Lockheed was building an Orbit Adjust Stage for use with the Titan III-D, proposed launcher for HEAO, to circularize HEAO's orbit (Lockheed began this work under a study contract in March).
Nov. 23, 1971	NASA announced that it would be contracting with TRW for HEAO.
Feb. 1972	NASA identified a follow-on HEAO as a potential payload for 1 of the first 10 Shuttle flights.
Feb. 1972	HEAO-A experimenters met at MSFC for two days of briefings.
Apr. 1972	NASA's Goddard Space Flight Center contracted with Grumman and Stanford University for phase B studies of the energetic gamma ray telescope proposed for HEAO-B.
June 30, 1972	NASA awarded a contract worth \$83.65 million to TRW for two HEAO satellites, with a first launch scheduled for 1975 on a Titan IIIE. A total of 13 experiments would be carried on the two observatories.
July 1972	MSFC awarded contracts for the design and fabrication of seven experiments for HEAO-A.

Table 3-71. Chronology of High Energy Astronomy Observatory Development and Operations (Continued)

Date	Event
Aug. 1972	The Physics Survey Committee of the National Academy of Sciences gave HEAO a high-priority rating in the field of physics-related projects being conducted in the U.S.
Oct. 11, 1972	NASA awarded Ball Brothers a contract to design and build a high-spectral resolution gamma ray spectrometer for HEAO-B.
Jan. 5, 1973	Because of budget cuts, NASA was forced to suspend HEAO for one year while its managers restructured the observatory program and looked for ways to cut costs. During the year, the program was redefined; it would include three smaller satellites weighing less than 3000 kilograms with smaller, modular experiment packages. The new HEAO would be launched by Atlas-Centaur.
Apr. 5, 1974	NASA approved four experiments for HEAO-A and let contracts totaling \$23.35 million.
Apr. 10, 1974	MSFC announced that it would negotiate with TRW as contractor for the redefined HEAO Block I satellites.
Aug.-Oct. 1974	HEAO scientists conducted a series of balloon flights as part of the instrument development program. The balloons carried development models of HEAO instruments.
Aug. 28, 1974	MSFC completed negotiations with TRW for the HEAO contract, with the first launch scheduled for 1977. The NASA center also let contracts for five experiments for HEAO-B.
Oct. 1974	TRW began studies to determine how HEAO satellites could be deployed and retrieved by Shuttle.
Jan. 1975	MSFC announced that an x-ray telescope test facility would be built at the center for HEAO by Inscho's Mechanical Contractors. The contractor would complete construction by April 1976.
Jan. 1975	TRW chose Control Data Corp. to provide altitude control computers for HEAO.
Jan. 1975	In <i>Opportunities and Choices in Space Science, 1974</i> , the Space Science Board strongly endorsed NASA's HEAO program.
Summer 1975	MSFC began a phase A feasibility study of HEAO Block II observatories.
May 1976	Contractors began delivery of the HEAO experiment hardware to TRW, with integration of four of the experiments completed by September.
Sept. 8, 1976	NASA's Lewis Research Center announced that it had let a contract to General Dynamics Corporation's Convair Division for eight Atlas-Centaur launch vehicles, including those required for HEAO.
Sept. 14, 1976	NASA reported to Congress that it had reprogrammed \$2.76 million from the Explorer program to HEAO and dropped two requirements (retrievability by Shuttle and compatibility with the Tracking and Data Relay Satellite System) for HEAO-C. It also was noted that the complexity of the HEAO-B telescope was greater than anticipated.
Nov. 16, 1976	MSFC announced that three experiments would be carried aboard HEAO-C.
Aug. 12, 1977	NASA successfully launched <i>HEAO 1</i> from the Eastern Test Range. The satellite returned data until its official termination in September 1979.
Nov. 13, 1978	NASA successfully launched <i>HEAO 2</i> . NASA operated the second observatory for 2.5 years.
Sept. 20, 1979	NASA successfully launched <i>HEAO 3</i> . This last of the series returned data for 20 months.

Table 3-72. *High Energy Astronomy Observatory 1 (HEAO 1) Characteristics*

---

Date of launch (range): Aug. 12, 1977 (ETR)  
 Launch vehicle: Atlas-Centaur  
 Shape: cylindrical with solar panels (2 modules: experiment and equipment)  
 Weight (kg): 2721.55  
 Dimensions (m): 2.35, diameter  
                   6.10, length  
 Power source: solar arrays plus NiCd batteries  
 Prime contractor: TRW  
 Date of reentry: March 15, 1979  
 Responsible NASA center: MSFC  
 Project manager: F. A. Speer  
 Project scientist: McDonald (GSFC)  
 Objectives: To map the x-ray and gamma ray sky over the range 150-10 mill. electron volts, measure size and obtain precise location data on x-ray sources in the range 1-15 thousand electron volts, and determine the contribution of discrete sources to the x-ray background.  
 Experiments (responsible organization):  
   Large area x-ray survey (Naval Research Laboratory)  
   Cosmic x-ray (GSFC and California Institute of Technology)  
   Scanning modulation collimator (Smithsonian Astrophysical Observatory and Massachusetts Institute of Technology)  
   Hard x-ray and low-energy gamma ray (Univ. of California, San Diego, and MIT)  
 Results: Highly successful; officially terminated in Sept. 1979.

---

Reference: MOR S-832-77-01, July 29, 1977.

Table 3-73. *High Energy Astronomy Observatory 2 (HEAO 2) Characteristics*

---

Also called: Einstein Observatory  
 Date of launch (range): Nov. 13, 1978 (ETR)  
 Launch vehicle: Atlas-Centaur  
 Shape: same as for *HEAO 1*  
 Weight (kg): 2948.35  
 Dimensions (m): 2.35, diameter  
                   6.71, length  
 Power source: same as for *HEAO 1*  
 Prime contractor: TRW  
 Date of reentry: March 25, 1982  
 Responsible NASA center: MSFC  
 Project manager: F. Speer  
 Project scientist: S. Holt (GSFC)  
 Objectives: To obtain images and spectra from astronomical sources emitting in the energy range 0.2-4.0 keV for a detailed analysis of the location, structure, and physical character of the sources.  
 Experiments (responsible institution):  
   Monitor proportional counter (Smithsonian Astrophysical Observatory)  
   High-resolution imager (SAO)  
   Focal plane crystal spectrometer (Massachusetts Institute of Technology)  
   Imaging proportional counter (MIT)  
   Solid state spectrometer (GSFC)  
 Results: Highly successful; operated 2½ years.

---

Reference: MOR S-832-78-02, Oct. 30, 1978.

Table 3-74. *High Energy Astronomy Observatory 3 (HEAO 3) Characteristics*

---

Date of launch (range):	Sept. 20, 1979 (ETR)
Launch vehicle:	Atlas-Centaur
Shape:	same as for <i>HEAO 1</i>
Weight (kg):	2721.55
Dimensions (m):	2.35, diameter 5.49, length
Power source:	same as for <i>HEAO 1</i>
Prime contractor:	TRW
Date of reentry:	Dec. 7, 1981
Responsible NASA center:	MSFC
Project manager:	F. Speer
Project scientist:	T. Parel
Objectives:	To study gamma ray emissions with high sensitivity and resolution over the energy range 0.06-10 MeV, measure the isotopic composition of cosmic rays, and measure composition of cosmic rays heavier than iron.
Experiments (responsible institution):	High-spectral resolution gamma ray spectrometer (JPL) Isotopic composition of primary cosmic rays (Center for Nuclear Studies, France, and Danish Space Research Institute) Heavy nuclei (Washington Univ., California Institute of Technology, and Univ. of Minnesota)
Results:	Highly successful; returned data for 20 months.

---

Reference: MOR S-832-79-03, n.d.

### Orbiting Astronomical Observatory

The Orbiting Astronomical Observatory (OAO), part of the physics and astronomy program, was established at NASA in 1959 (see vol. 2, table 3-110 for a chronology of development and operations). Astronomers required stable orbiting platforms with telescopes to make observations in the infrared, optical, ultraviolet, and x-ray regions of the spectrum beyond earth's obscuring atmosphere. The Grumman-manufactured OAO spacecraft, basically a hollow cylindrical tube in which experiments were housed, could be precisely pointed with an accuracy of 1 minute of arc.

Two of the four planned OAO missions were launched in 1966 and 1968 with mixed results. *OAO 1* suffered a battery malfunction and failed 1.5 hours into the mission. *OAO 2* performed better than its designers had expected, returning useful data on the celestial sphere until February 1973. The third mission (*OAO-B*) failed when the protective nose cone failed to jettison during a launch attempt in 1970. The satellite never reached orbit. *OAO 3*, also called *Copernicus*, was highly successful, returning data from 1972 until 1980.

The experiments gathered for the unsuccessful *OAO-B* were called the Goddard Experiments Package, after rocket pioneer Robert Goddard. The investigators had planned to gather high-resolution spectral data from pointed and extended sources in the ultraviolet region of the spectrum. There were seven detectors in the Goddard



package: six for ultraviolet and one for visible light (see table 3-75). OAO-B's spectrophotometer was a 38-inch Cassegrain telescope with a Wright-Smith spectrometer; its spectral range was 1100-4267 Angstrom, with a resolution of 2A-8A-64A and a pointing accuracy requirement of 1 arc second.<sup>6</sup>

The highly successful *OAO 3* returned data for eight years on the birth, death, and life cycles of stars. Its 450-kilogram Princeton Experiments Package contained a 32-inch telescope and spectrometer with a spectral range of 80-3000 Angstrom, a resolution of 0.1-0.5 A, and a pointing accuracy requirement of 0.1 arc second. *OAO 3* could view stars to the sixth magnitude. An x-ray experiment sponsored by University College of London studied stellar x-ray sources and x-ray absorption in interstellar space with three small telescopes (see table 3-76).<sup>7</sup>

The Orbiting Astronomical Observatory program was managed at NASA Headquarters by C. Dixon Ashworth. The Goddard Space Flight Center directed the project under the leadership of J. Purcell, OAO project manager, and J. R. Kupperian, Jr., OAO project scientist.

Table 3-75. Orbiting Astronomical Observatory B Characteristics

---

Also called: If successful would have been OAO 3.

Date of launch (range): Nov. 30, 1970 (ETR)

Launch vehicle: Atlas-Centaur

Shape: octagonal cylinder with 2 solar panels

Weight (kg): 2106

Dimensions (m): 3.0, length  
2.13, width; 6.4 with solar panels extended

Power source: Solar arrays plus NiCd batteries

Prime contractor: Grumman Aerospace Corp.

Reentry date: N/A

Responsible NASA center: GSFC

Project manager: J. Purcell

Project scientist: J. R. Kupperian, Jr.

Objectives: To obtain medium-resolution spectrophotometric data.

Experiments (responsible organization):

Goddard Experiment package—38-inch telescope designed to gather moderate-resolution data (Goddard Space Flight Center)

Results: Failure: protective nose cone failed to jettison and satellite did not achieve orbit.

---

Reference: NASA Hq., Press Release 70-174, "OAO-B," Oct. 29, 1970

Table 3-76. *Orbiting Astronomical Observatory 3 (OAO 3) Characteristics*

---

Also called:	Copernicus
Date of launch (range):	Aug. 21, 1972 (ETR)
Launch vehicle:	Atlas-Centaur
Shape:	octagonal cylinder with 2 solar panels
Weight (kg):	2200
Dimensions (m):	3.0, length 2.13, width; 6.4 with solar panels extended
Power source:	solar array plus NiCd batteries
Prime contractor:	Grumman
Reentry date:	In orbit 1985
Responsible NASA center:	GSFC
Project manager:	Purcell
Project scientist:	Kupperian
Objectives:	To obtain high-resolution spectra of a number of stars in the ultraviolet range between 1000 and 3000 Å to investigate the composition, density, and physical state of matter in interstellar space and stellar sources
Experiments:	(responsible organization): Princeton Experiment Package: 80-cm Cassegrainian telescope and photoelectric spectrometer (Princeton Univ.) X-ray (University College, London)
Results:	Successful; ceased functioning in 1980.

---

Reference: MOR S-831-70-03, Oct. 14, 1970; and NASA Hq. Release 70-174, "OAO-B Press Kit," Oct. 29, 1970.

### Orbiting Geophysical Observatories

The Goddard Space Flight Center initiated the Orbiting Geophysical Observatory (OGO) program in 1960. The six TRW-made satellites were designed to carry a large number of measuring instruments to gather data on atmospheric composition, solar emissions, radio astronomy, and other phenomena. OGO was the first scientific satellite designed to perform a variety of roles; instead of being a tailor-made one-instrument package it was a truly automated orbiting laboratory.

Five of the six OGOS were launched during 1964-1968, with *OGO 6* being orbited in 1969. Despite attitude control problems, the first five spacecraft in the series sent back over a million hours of data to scientists studying earth-sun relationships (see vol. 2). *OGO 6* scientists from over a dozen institutions studied atmospheric phenomena during a period of maximum solar activity (see table 3-77).<sup>8</sup>

### Orbiting Solar Observatories

In 1959, NASA scientists at Goddard Space Flight Center and Headquarters began planning for a series of spacecraft with pointing controls that could be used to take measurements of the sun. Less than three years later, the agency launched the first Orbiting Solar Observatory (OSO), a two-section spacecraft manufactured by Ball Brothers that could accommodate a variety of scientific instruments. The lower

Table 3-77. *Orbiting Geophysical Observatory 6 (OGO 6) Characteristics*

---

Date of launch (range):	June 5, 1969 (WTR)
Launch vehicle:	Thrust-augmented Thor-Agena D
Shape:	rectangular parallelepiped with 2 6.7-m booms and 4 1.2-m booms
Weight (kg):	544.3
Dimensions (m):	1.7, length 0.8, width 1.2, depth
Power source:	Solar cells plus AgCd batteries
Prime contractor:	TRW
Date of reentry:	Oct. 12, 1979
Responsible NASA center:	GSFC
Project manager:	Wilfred E. Scull
Project scientist:	N. W. Spencer
Objectives:	To conduct correlative studies of latitude dependent atmospheric phenomena during a period of maximum solar activity.
Experiments (responsible organization):	<ul style="list-style-type: none"> <li>Electron temperature and density (Univ. of Michigan and GSFC)</li> <li>Ionospheric ducting (Southwest Center for Advanced Studies)</li> <li>Neutral ion concentration and mass (GSFC)</li> <li>Ion mass spectrometer (SW Ctr. for Adv. Stud.)</li> <li>Energy transfer probe (Faraday Laboratories)</li> <li>Solar x-ray emissions (Naval Research Laboratory)</li> <li>Solar ultraviolet emissions (Air Force Cambridge Research Laboratory)</li> <li>Solar ultraviolet survey (Univ. of New Mexico)</li> <li>Airglow and auroral emissions (Univ. of Paris)</li> <li>Celestial Lyman-Alpha (Aerospace Corporation)</li> <li>Ultraviolet photometer (Univ. of Colorado and Packard Bell)</li> <li>Low-energy auroral particles (GSFC)</li> <li>Trapped and precipitated electrons (Univ. of California at Los Angeles; GSFC)</li> <li>Neutron monitor (Univ. of New Hampshire)</li> <li>Low-energy solar cosmic rays (McDonnell Douglas Astronautics Company)</li> <li>Solar and galactic cosmic rays (California Institute of Technology)</li> <li>Magnetic field measurements (JPL and UCLA)</li> <li>Electric field measurements (GSFC)</li> <li>VLF polarization and wave normal direction (Stanford Univ.)</li> <li>Whistler and low frequency electric fields (Dartmouth College)</li> <li>Sodium airglow (Univ. of Pittsburgh and Univ. of Paris)</li> </ul>
Results:	Successful; last of a series of 6 OGOs.

---

Reference: MOR S-841-69-06, June 3, 1969.

wheel-like compartment of OSO was divided into nine compartments, five of which could house instruments, and a sail-shaped upper section for the solar array and instruments that required a fixed solar orientation. During NASA's first decade, the Eastern Test Range saw four successful OSO launches (see vol. 2).

*OSO 5* and *6*, configured very much like the first four of the series, took their place in orbit in 1969, returning high-spectral resolution data for several years (see tables 3-79 and 80). *OSO 7*, launched in September 1971, represented an improved design. All the OSO spacecraft were three-gimballed bodies; their wheels spun to provide gyroscopic stabilization and to accommodate the scanning scientific instruments. The earlier OSOs depended on deployable ballast arms; *OSO 7* sported a

mechanically simplified fixed-ballast system and was twice as heavy as its predecessors—and carried twice as much experiment payload weight. Ball Brothers enlarged the wheel and increased the solar array so that it provided more power (an increase from 30 to 97 watts). Controllers could point *OSO 7* at regions of special interest by feeding offset point commands and scan patterns into its biaxial pointing servos (see table 3-81 and figure 3-2).

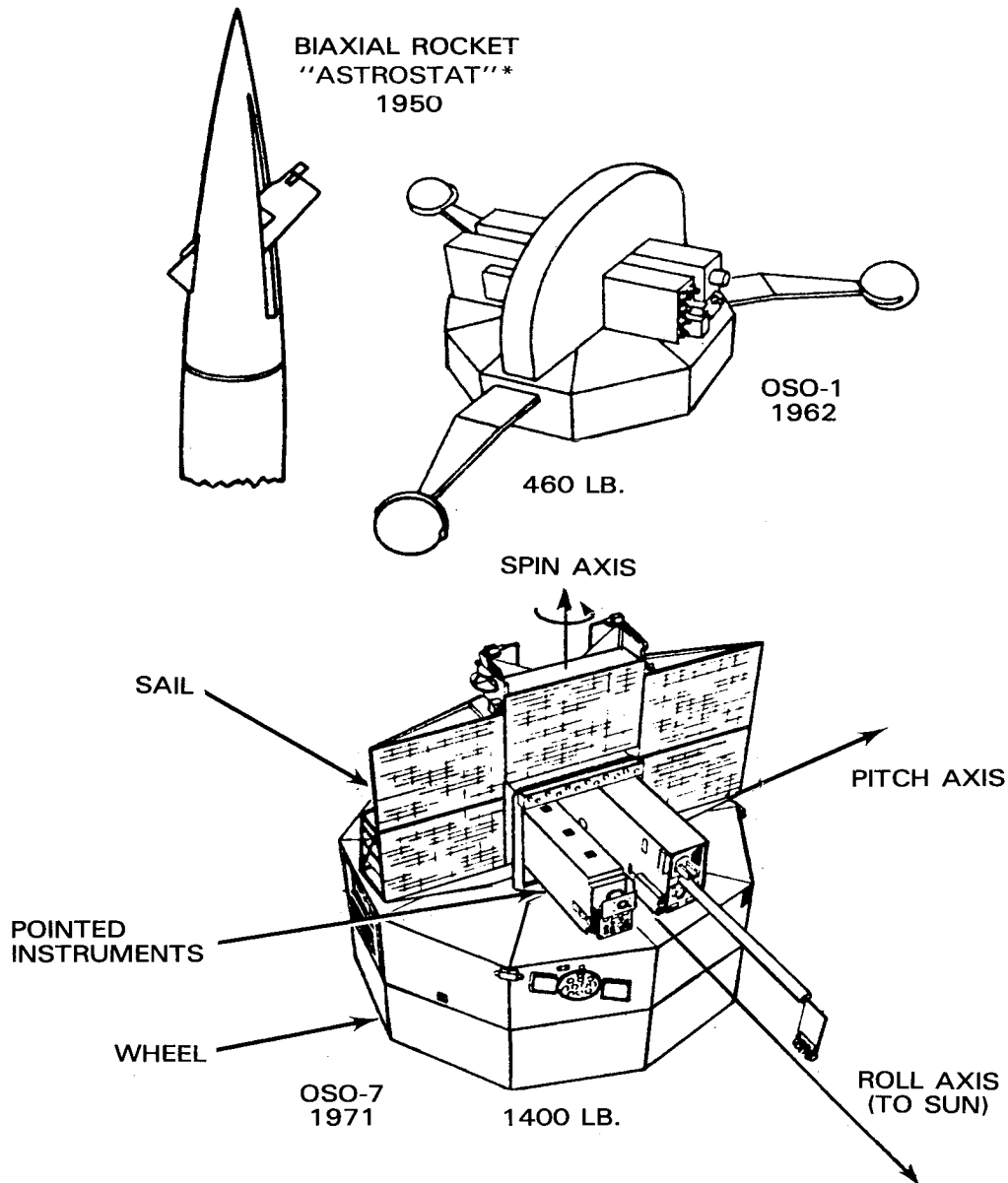

\* Rod-shaped spacecraft are now often called "gyrostats."

Figure 3-2. OSO Design Evolution

Source: W. H. Follett, L. T. Ostwald, J. O. Simpson, et al., "A Decade of Improvements to Orbiting Solar Observatories," n.d., p. 1, NASA (Hq.) History Office.

Even before the second OSO mission was completed, investigators began urging NASA to consider an advanced OSO that would allow them to make long-duration measurements of ultraviolet spectral line profiles and obtain pressure and density data in the solar atmosphere. In January 1969, NASA Headquarters approved three follow-on OSO missions if it could get funding from Congress. According to proposals, the new spacecraft would be triple the weight of the original OSO, with 2.5 times the power, increased data rates, and improved pointing accuracy. They would provide scientists an opportunity to study the sun during its quiet period. Congress authorized FY 1970 funds for OSO I, J, and K.

OSO-I would study energy transfer from the photosphere to the higher levels of the solar atmosphere under quiet sun conditions. OSO J would return data on solar-terrestrial relationships. OSO K would allow the study of heat and particle radiation flow.

In the spring of 1970, NASA's Goddard Space Flight Center issued a request for proposals to industry for a contractor for the new OSO. In addition to Ball Brothers, who made the original solar observatory series, Hughes Aircraft and TRW submitted proposals for this new class of spacecraft. Goddard called for a larger main body with a three-part sail. The 1052-kilogram OSO-I would require a Delta launcher with strap-on boosters. NASA finalized an OSO contract with Hughes in May 1971. Seven experiment teams were already at work on the payload for the first new observatory.

*OSO 8*, which was launched in June 1975 after several delays for budget reasons, carried an international experiment package. To provide significant advances in spatial and spectral resolution, two teams provided high-resolution ultraviolet spectrometers: Centre National de la Recherche Scientifique of France and the University of Colorado. The two ultraviolet instruments and six other experiments performed successfully until September 1978 when the satellite was turned off (see table 3-82). OSO-J and -K fell victim to budget cuts that began in 1972 (see table 3-78 for details). *OSO 8* was the last of a productive series.<sup>9</sup>

C. Dixon Ashworth managed the Orbiting Solar Observatory program at NASA Headquarters. At Goddard, J. M. Thole served as project manager for *OSO 5*, *6*, and *7*, while Robert H. Pickard took over for *OSO 8*.

Table 3-78. Chronology of Orbiting Solar Observatory (OSO)  
Development and Operations, 1969-75

Date	Event
Jan. 22, 1969	NASA launched <i>OSO 5</i> successfully. NASA Acting Administrator Thomas O. Paine approved follow-on OSO missions I, J, and K with a first launch scheduled for early 1973.
Mar. 1969	Goddard Space Flight Center announced the opportunity to participate with experiment proposals in solar physics for an improved OSO.
Aug. 4-15, 1969	The Joint Institute for Laboratory Astrophysics hosted an OSO workshop to put OSO data into the context of the whole spectral range of solar data.
Aug. 9, 1969	NASA launched <i>OSO 6</i> successfully.
Feb. 1970	NASA chose seven experiments for OSO-I from 30 proposals.
Apr. 1, 1970	Goddard issued a request for proposals (RFP) for the OSO-I-K spacecraft (1 prototype and 3 flight-ready spacecraft).
June 1, 1970	Ball Brothers Research Corp., Hughes Aircraft, and TRW, Inc., responded to the OSO RFP.
Aug. 8, 1970	Goddard modified its RFP to read one protoflight and two flight-ready spacecraft.
Sept. 14, 1970	The three interested companies resubmitted their proposals.
Nov. 1970	Thirty-six scientists submitted proposals for OSO-J investigations.
Dec. 1970	NASA announced that it had chosen Hughes Aircraft as the prime contractor for the follow-on OSO contract.
Feb.-Mar. 1971	NASA scientists study the OSO-J proposals.
May 14, 1971	NASA awarded Hughes the OSO contract.
June 1971	NASA Headquarters announced its recommendations for OSO-J experiments.
Sept. 29, 1971	NASA successfully launched <i>OSO-7</i> .
Late 1971	Because of expected budget cuts by Congress, NASA Headquarters managers identified the follow-on OSO missions as a possible candidate for termination or postponement.
Mar. 1972	NASA Headquarters managers decided to defer any activity on OSO-J and K until the budget situation had been better defined but to continue with OSO-I.
Late Mar. 1972	Hughes informed NASA of a project cost overrun with OSO-I.
June 9, 1972	NASA changed the launch readiness date for OSO-I from November 1973 to June 1974, primarily for fiscal reasons.
Sept. 26, 1972	NASA announced that OSO-J and K would not be funded in FY 1973.
Feb. 1974	Because of FY 1975 budget cuts, NASA postponed the launch of OSO-I.
June 21, 1975	NASA successfully launched <i>OSO 8</i> , the last of the OSO series.

Table 3-79. *Orbiting Solar Observatory 5 (OSO 5) Characteristics*

---

Date of launch (range): Jan. 22, 1969 (ETR)  
 Launch vehicle: Delta C (with FW-4 3d stage)  
 Shape: fan-shaped sail atop a lower wheel-like structure composed of 9 wedges with 3 stabilization arms  
 Weight (kg): 288.5  
 Dimensions (m): 0.95, height  
                   1.10, diameter  
 Power source: solar cells with NiCd batteries  
 Prime contractor: Ball Brothers Research Corp.  
 Date of reentry: April 2, 1984  
 Responsible NASA center: GSFC  
 Project manager: J. M. Thole  
 Project scientist: W. E. Behring  
 Objectives: To obtain high-spectral resolution data from the pointed experiments within the range 1-250 ° during a solar rotation, including faster scans of the solar disc in selected wavelengths.  
 Experiments (responsible organization):  
   X-ray spectrometer (GSFC)  
   Extreme ultraviolet spectroheliograph (Naval Research Laboratory)  
   Solar x-ray spectroheliograph (Univ. College, London)  
   Zodiacal light telescope (Univ. of Minnesota)  
   X-ray monitor (NRL)  
   Solar far-ultraviolet radiation monitor (Univ. of Colorado)  
   Low-energy gamma ray scintillation detector (GSFC)  
 Results: Successful; returned data for several years.

---

Reference: MOR S-821-68-06, Nov. 19, 1968.

Table 3-80. *Orbiting Solar Observatory 6 (OSO 6) Characteristics*

---

Date of launch (range): Aug. 9, 1969 (ETR)  
 Launch vehicle: Delta N  
 Shape: same as for *OSO 5*  
 Weight (kg): 288  
 Dimensions (m): same as for *OSO 5*  
 Power source: same as for *OSO 5*  
 Prime contractor: same as for *OSO 5*  
 Date of reentry: March 7, 1981  
 Responsible NASA center: GSFC  
 Project manager: J. M. Thole  
 Project scientist: Stephen P. Maran  
 Objectives: To obtain high-spectral resolution data from the pointed experiments within the range 10-20 keV and 1-1300 ° during a solar rotation, including faster scans of the solar disc in selected wavelengths.  
 Experiments (responsible organization):  
   Ultraviolet scanning spectrometer (Harvard College Observatory)  
   Solar x-ray spectral, burst, and mapping spectrometer (Naval Research Laboratory)  
   Zodiacal light polarimeter (Rutgers Univ.)  
   Solar x-ray emission line spectrometers (Los Alamos Scientific Laboratory)  
   20-200 keV x-ray telescope (Univ. of Bologna)  
   Solar ultraviolet polychromator (Univ. College, London)  
   High-energy neutron telescope (Univ. of New Mexico)  
 Results: Successful.

---

Reference: MOR S-821-69-07, July 28, 1969.

Table 3-81. *Orbiting Solar Observatory 7 (OSO 7) Characteristics*

---

Date of launch (range): Sept. 29, 1971 (ETR)  
 Launch vehicle: Delta N  
 Shape: same as for *OSO 5*  
 Weight (kg): 637  
 Dimensions (m): 2.0, height  
                   1.4, diameter  
 Power source: same as for *OSO 5*  
 Prime contractor: same as for *OSO 5*  
 Date of reentry: July 9, 1974  
 Responsible NASA center: GSFC  
 Project manager: J. M. Thole  
 Project scientist: S. P. Maran  
 Objectives: To obtain high-resolution data from the solar corona in particular spectral bands in the xuv and in the visible regions during one solar rotation.  
 Experiments (responsible organization):  
     White light and xuv coronagraphs (Naval Research Laboratory)  
     X-ray polarimeter (GSFC)  
     X-ray and xuv spectroheliograph (GSFC)  
     Celestial x-ray telescope (Massachusetts Institute of Technology)  
     Gamma-ray spectrometer (Univ. of New Hampshire)  
     Cosmic x-ray telescope (Univ. of California at San Diego)  
     Solar x-ray telescope (Univ. of CA, SD)  
 Results: Successful.

---

Reference: S-821-71-08, Sept. 13, 1971.

Table 3-82. *Orbiting Solar Observatory 8 (OSO 8) Characteristics*

---

Date of launch (range): June 21, 1975 (ETR)  
 Launch vehicle: Delta 1910  
 Shape: rectangular-shaped sail atop a lower wheel-like structure composed of 9 wedges with 3 stabilization arms  
 Weight (kg): 1052  
 Dimensions (m): 3.25, height  
                   2.10, sail diameter  
                   1.52, wheel diameter  
 Power source: solar cells plus NiCd batteries  
 Prime contractor: Hughes Aircraft Company  
 Date of reentry: In orbit 1984  
 Responsible NASA center: GSFC  
 Project manager: Robert H. Pickard  
 Project scientist: S. P. Maran  
 Objectives: To investigate the sun's lower corona, the chromosphere, and their interface in the uv spectral region to better understand the transport of energy from the photosphere into the corona.  
 Experiments (responsible organization):  
     High-resolution ultraviolet spectrometer (Univ. of Colorado)  
     Chromosphere study (Centre National de la Recherche Scientifique)  
     High-sensitivity crystal spectrometer and polarimeter (Columbia)  
     Mapping x-ray heliometer (Lockheed Missiles & Space Co.)



Table 3-82. *Orbiting Solar Observatory 8 (OSO 8) Characteristics (Continued)*

---

	Soft x-ray background radiation (Univ. of Wisconsin)
	Cosmic x-ray spectroscopy (GSFC)
	High-energy celestial x-ray (GSFC)
	xuv radiation (Naval Research Laboratory)
Results:	Successful; satellite turned off in Sept. 1978.

---

Reference: MOR S-821-75-09, June 4, 1975.

### Other Physics and Astronomy Projects

In addition to its own Explorer program and the several orbiting observatory programs discussed above, NASA participated in other Explorer-class physics and astronomy projects, often with foreign countries. NASA's role varied from launch vehicle provider to scientific partner.

From 1969 through 1978, NASA played a role in 28 small scientific satellite launchings, 24 of which were cosponsored by other countries or by the European Space Agency (formerly the European Space and Research Organization). These satellites contributed to our understanding of solar-terrestrial relationships. Seven were designed to study ionospheric physics; six magnetospheric physics, five solar physics, four astronomy, two atmospheric physics, two aeronomy, one thermal dynamics, and one new spacecraft technology (see table 3-83).

*Aeros 1* and *2* and *San Marcos 3* and *5* collected temperature, composition, density, and pressure data that allowed scientists to study the earth's atmosphere. Information collected by the principal investigators for *Ariel 4*, *ESRO 4*, and *ISIS 1* and *2* increased our store of knowledge about ionization in the vicinity of earth. Solar physics data were the goals of *Azur*, *Helios 1* and *2*, and *Solrad 11A* and *11B*. *Solrad* was a Naval Research Laboratory managed project for which the Goddard Space Flight Center provided tracking and data acquisition support. *ANS* and *Ariel 5* were dedicated to x-ray astronomy.

The International Ultraviolet Explorer (IUE) project was a joint enterprise, with participants from NASA and its contractors, the European Space Agency, and the British Science Research Council. *IUE 1*, launched into geosynchronous orbit in January 1978, allowed hundreds of users at two locations to conduct spectral studies of celestial ultraviolet sources. It was the first satellite totally dedicated to ultraviolet astronomy (table 3-104).

NASA provided the IUE spacecraft, optical and mechanical components of the scientific instruments, the U.S. ground observatory, and the spacecraft control software. ESA contributed the solar arrays *IUE 1* needed as a power source and the European ground observatory in Spain. The British Science Research Council oversaw the development of the spectrograph television cameras and, with the U.S., the image processing software.

The objects of IUE's studies were many: faint stars, hot stars, quasars, comets, gas streams, extragalactic objects, and the interstellar medium. The primary instrument for these studies was a 45-centimeter Ritchey Chretien telescope. Geosynchronous orbit permitted continuous observations and real-time data access by the

many observers who worked at the two ground observatories. With the increased observing time, many "visiting observers" could take advantage of the ultraviolet astronomy satellite (fig. 3-3). NASA's Goddard Space Flight Center controlled the spacecraft 16 hours of each day, while the European observatory near Madrid controlled it for 8 hours.

The International Sun-Earth Explorer (ISEE) program was a joint NASA-European Space Agency endeavor. Originally called International Magnetosphere Explorers, ISEE was a follow-on to the successful Interplanetary Monitoring Platform (IMP) series of Explorer satellites. Three ISEE spacecraft were designed to study solar-terrestrial relationships, monitor the solar wind, and investigate cosmic and gamma ray bursts (see tables 3-99, 100, and 101).

NASA's Goddard Space Flight Center provided *ISEE 1* and *3*, while Dornier Systems, working under contract for ESA, built *ISEE 2*. The first two spacecraft were orbited together by a Thor-Delta 2914 in October 1977 and worked together to provide measurements from the furthest boundaries of the magnetosphere and to

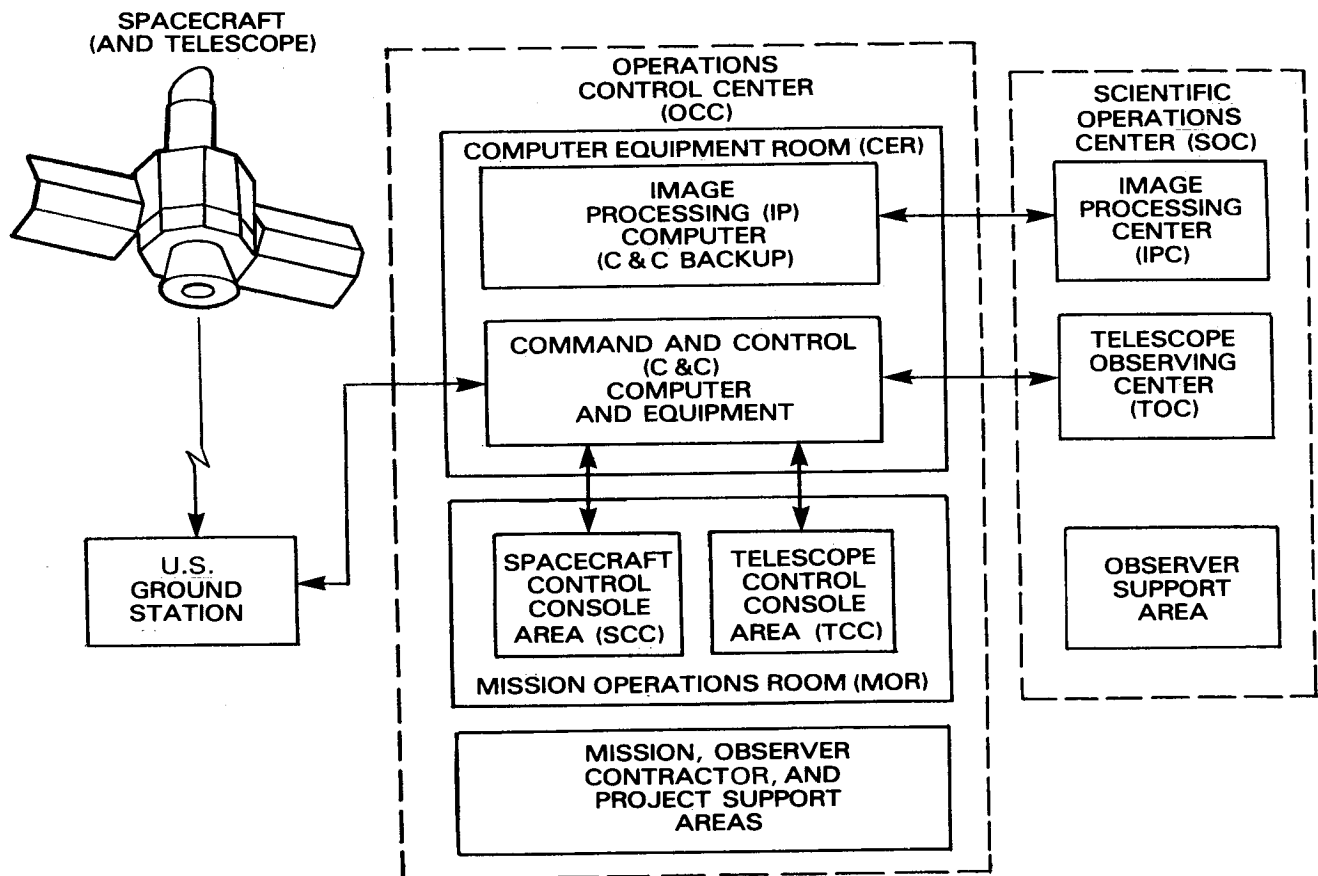

Figure 3-3. Two IUE ground observatories, located near Washington, D.C., and Madrid, Spain, were designed to resemble and function as typical ground astronomy observatories. With a minimum of training, guest observers could take an active part in the real-time control of the spacecraft and the offline processing of image data. The U.S. Ground Observatory at the Goddard Space Flight Center consisted of the ground station, the Scientific Operations Center, and the Operations Control Center.

study the solar wind. *ISEE 3*, launched in August 1978, was placed at a libration point 1.6 million kilometers from earth, where it returned detailed information on the solar wind and its fluctuations, in addition to data on cosmic rays and gamma ray bursts. All three spacecraft were still performing satisfactorily in the early 1980s, and NASA hoped to use *ISEE 3* for comet observations in 1985.

The following tables provide details on these Explorer-class spacecraft, their objectives, and their payloads.

Table 3-83. Other Explorer-Class Satellites

Satellite	Launch Date	Cooperative Project With	Class
Aeros 1	Dec. 16, 1972	West Germany	Aeronomy
Aeros 2	July 16, 1974	West Germany	Aeronomy
ANS 1	Aug. 30, 1974	Netherlands	Astronomy
Ariel 4	Dec. 11, 1971	United Kingdom	Ionospheric physics
Ariel 5	Oct. 15, 1974	United Kingdom	X-ray astronomy
Azur	Nov. 7, 1969	West Germany	Solar physics
Boreas	Oct. 1, 1969	European Space Research Org.	Ionospheric physics
Cameo	Oct. 24, 1978	N/A	Ionospheric physics
ESRO 4	Nov. 21, 1972	ESRO	Ionospheric physics
GEOS 1	Apr. 20, 1977	European Space Agency	Magnetospheric physics
GEOS 2	July 14, 1978	ESA	Magnetospheric physics
HCMM	Apr. 26, 1978	N/A	Thermal dynamics
Helios 1	Dec. 10, 1974	West Germany	Solar physics
Helios 2	Jan. 15, 1976	West Germany	Solar physics
HEOS 2	Jan. 31, 1972	ESRO	Magnetospheric physics
INTASAT	Nov. 15, 1974	Spain	Ionospheric physics
ISEE 1	Oct. 22, 1977	ESA	Magnetospheric physics
ISEE 2	Oct. 22, 1977	ESA	Magnetospheric physics
ISEE 3	Aug. 12, 1978	ESA	Magnetospheric physics
ISIS 1	Jan. 30, 1969	Canada	Ionospheric physics
ISIS 2	Mar. 31, 1971	Canada	Ionospheric physics
IUE 1	Jan. 26, 1978	ESA and United Kingdom	Ultraviolet astronomy
Miranda	Mar. 8, 1974	United Kingdom	Technology
San Marco 3	Apr. 24, 1971	Italy	Atmospheric physics
San Marco 4	Feb. 18, 1974	Italy	Atmospheric physics
Solrad 11A	Mar. 15, 1976	Naval Research Laboratory	Solar physics
Solrad 11B	Mar. 15, 1976	NRL	Solar physics
TD-1A	Mar. 11, 1972	ESRO	Ultraviolet astronomy

Table 3-84. *Aeros 1* Characteristics

---

Also called: Aeronomy Satellite or German A-2  
 Memorandum of Understanding (MOU) between NASA and: Bundesministerium für Bildung und Wissenschaft (BMBW), Federal Republic of Germany, June 10, 1969  
 Date of launch (range): Dec. 16, 1972 (WTR)  
 Launch vehicle: Scout  
 Shape: cylindrical  
 Weight (kg): 126  
 Dimensions (m): 0.914, diam.  
                     0.71, height  
 Power source: solar array plus AgZn and NiCd batteries  
 Prime contractor: Dornier  
 Date of reentry: Aug. 22, 1973  
 NASA's role: launch vehicle and technical support; participation in experiment program  
 Responsible NASA center: GSFC  
 Project manager: Carl L. Wagner, Jr.  
 Project scientist: Siegfried J. Bauer  
 Objectives: To measure the main aeronomic parameters of the upper atmosphere and the solar ultraviolet radiation in the wavelength band of main absorption.  
 Experiments (responsible country or organization):  
     mass spectrometer (BMBW)  
     retarding potential analyzer (BMBW)  
     impedance probe (BMBW)  
     extreme ultraviolet spectrometer (BMBW)  
     neutral atmosphere temperature (GSFC)  
 Results: 4 of the 5 experiments performed satisfactorily; on May 28, 1973, the apogee/perigee was changed from  $497 \times 200$  km to  $653 \times 200$  km to extend mission lifetime.

---

Reference: MOR S-874-72-02, Nov. 30, 1972.

Table 3-85. *Aeros 2* Characteristics

---

Also called: Aeronomy Satellite or German A-3  
 Memorandum of Understanding: same as for *Aeros 1* (table 3-84)  
 Date of launch (range): July 16, 1974 (WTR)  
 Launch vehicle: Scout  
 Shape: cylindrical  
 Weight (kg): 127  
 Dimensions (m): 0.914, diam.  
                     0.71, height  
 Power source: same as for *Aeros 1*  
 Prime contractor: Dornier  
 Date of reentry: Sept. 25, 1975  
 NASA's role: same as for *Aeros 1*  
 Responsible NASA center: GSFC  
 Project manager: C. Wagner  
 Project scientist: S. Bauer  
 Objectives: same as for *Aeros 1*  
 Experiments: same as for *Aeros 1*  
 Results: Basically a successful mission, but a tape recorder failure forced operations to be conducted in real time only (loss of 20-30% data).

---

Reference: MOR S-490-302-74-01, July 8, 1974.

Table 3-86. *ANS I* Characteristics

---

Also called: Netherlands Astronomical Satellite  
Memorandum of Understanding (MOU) between NASA and: Netherlands Satellite Program Authority  
June 5, 1970  
Date of launch (range): Aug. 30, 1974 (WTR)  
Launch vehicle: Scout  
Shape: rectangular  
Weight (kg): 130  
Dimensions (m): 0.73, depth  
1.23, height  
0.61, width (1.44 with solar panels extended)  
Power source: solar panels plus NiCd battery  
Prime contractor: ICANS  
Date of reentry: June 14, 1977  
NASA's role: launch vehicle and technical support; participation in experiment program  
Responsible NASA center: GSFC  
Project manager: Emil Hymowitz  
Project scientist: Joseph Stecher  
Objectives: to increase scientific knowledge of stellar ultraviolet and x-ray sources.  
Experiments (responsible country or organization):  
ultraviolet telescope (Netherlands)  
soft x-ray (Netherlands)  
hard x-ray (GSFC)  
Results: Although the spacecraft was put in an elliptical (1176 × 266 km) rather than a near-circular (560 × 510 km) orbit because of a launch vehicle first-stage malfunction, the experiments returned useful data; some observation time was lost, however, during the 20 months of operational lifetime.

---

Reference: MOR S-875-74-01, Aug. 21, 1974 and July 18, 1978.

Table 3-87. *Ariel 4* Characteristics

---

Also called: UK-4

Memorandum of Understanding (MOU) between NASA and: U.K. Science Research Council, Feb. 14, 1969.

Date of launch (range): Dec. 11, 1971 (WTR)

Launch vehicle: Scout

Shape: cylindrical with a conical top section

Weight (kg): 99

Dimensions (m): 0.76, diam. (3.35 with extendable booms)  
0.91, length

Power source: solar array plus NiCd battery

Prime contractor: British Aircraft Corp.

Date of reentry: Dec. 12, 1978

NASA's role: launch vehicle, technical support, and tracking and data acquisition; participation in experiment program

Responsible NASA center: GSFC

Project manager: Herbert L. Eaker

Project scientist: George F. Pieper

Objectives: To investigate the interaction between electromagnetic waves, plasmas, and energetic particles in the upper ionosphere.

Experiments (responsible country or organization):

electron temperature and density (Univ. of Birmingham)

HF noise (Jodrell Bank and Radio and Space Research Station)

ELF and VLF noise (Sheffield Univ.)

ELF and VLF impulse (Sheffield Univ.)

charged particle detector (Univ. of Iowa and GSFC)

Results: Successful, supplying data through Mar. 1973; reactivated in late 1973 to supply data in support of a sounding rocket study of the Northern Lights conducted by Norway.

---

Reference: MOR S-870-71-04, Dec. 1, 1971.

Table 3-88. *Ariel 5* Characteristics

---

Also called:	UK-5
Memorandum or Understanding:	same as for <i>Ariel 5</i>
Date of launch (range):	Oct. 15, 1974 (San Marco)
Launch vehicle:	Scout
Shape:	cylindrical
Weight (kg):	130.3
Dimensions (m):	0.958, diam. 0.864, height
Power source:	solar array plus NiCd battery
Prime contractor:	British Aircraft Corp.
Date of reentry:	Mar. 14, 1980
NASA's role:	same as for <i>Ariel 4</i>
Responsible NASA center:	GSFC
Project manager:	H. L. Eaker
Project scientist:	Stephen S. Holt
Objectives:	To increase scientific knowledge of galactic and extragalactic x-rays.
Experiments (responsible country or organization):	measurements of source positions and sky survey (Mullard Space Science Lab., University College, London) sky survey (Univ. of Leicester) study of the spectra of individual sources, pointed (MSSL, Univ. College) x-ray polarimeter/spectrometer (Univ. of Leicester) all-sky x-ray monitor (GSFC) study of high-energy x-rays, pointed (Imperial College)
Results:	Successful; during the first year the scientists discovered many new transient x-ray sources; the majority of the observations were devoted to the study of steady x-ray sources; the switch to the San Marco launching range, which is Italian owned and operated, enhanced the scientific data return.

---

Reference: MOR S-870-74-05, Oct. 11, 1974 and Mar. 15, 1978.

Table 3-89. *Azur* Characteristics

---

Also called: German Research Satellite (GRS-A)  
Memorandum of Understanding (MOU) between NASA and: Bundesministerium für wissenschaftliche Forschung, Federal Republic of Germany, July 17, 1965

Date of launch (range): Nov. 7, 1969 (WTR)  
Launch vehicle: Scout  
Shape: cylindrical with a conical top  
Weight (kg): 72  
Dimensions (m): 0.76, diam.  
1.13, length (1.95 with extendable boom)  
Power source: solar cells plus AgCd battery  
Prime contractor: Gesellschaft für Weltraumforschung mbH  
Date of reentry: Still in orbit 1984  
NASA's role: launch vehicle, technical support, and tracking and data acquisition  
Responsible NASA center: GSFC  
Project manager: Allen L. Franta  
Project scientist: George F. Pieper

Objectives: To obtain data on the inner Van Allen belt, the auroral zones of the northern hemisphere, and the spectral variations of solar particles versus time during solar flares.

Experiments (responsible country or organization):  
magnetometer (Institute für Geophysik and Meteorologie der Technischen Hochschule)  
proton telescope (Max-Planck-Institut and Institut für reine und angewandte Kernphysik der Universität Kiel)  
proton-electron detector (MPI)  
electron counter (MPI)  
charged particle counter (MPI)  
photometer (Institut für Physik der Atmosphäre)

Results: Successful results obtained even though the spacecraft tape recorder failed in Dec. 1969; only real-time data were obtained.

---

Reference: MOR S-874-69-01, Nov. 9, 1969.



Table 3-90. *Boreas* Characteristics

---

Also called: ESRO I-B  
 Memorandum of Understanding (MOU) between NASA and: European Space Research Organization,  
 July 8, 1964  
 Date of launch (range): Oct. 1, 1969 (WTR)  
 Launch vehicle: Scout  
 Shape: cylindrical with truncated cones at each end  
 Weight (kg): 85.8  
 Dimensions (m): 0.76, diam.  
                   1.52, length  
                   2.43, tip to tip with booms extended  
 Power source: solar cells plus battery  
 Prime contractor: Laboratoire Central de Telecommunications  
 Date of reentry: Nov. 23, 1969  
 NASA's role: launch vehicle (reimbursable)  
 Responsible NASA center: GSFC  
 Project manager: Herbert L. Eaker  
 Project scientist: Leslie H. Meredith  
 Objectives: To perform an integrated study of the high-latitude ionosphere.  
 Experiments (responsible country or organization):  
   scintillator and pulse height analyzer (Radio and Space Research Station, U.K.)  
   electrostatic analyzer (Kiruna Geophysical Observatory, Sweden)  
   solid state detectors (Technical Univ. of Denmark and Univ. of Bergen, Norway)  
   George-Muller counters (Tech. Univ. of Denmark and Norwegian Space Committee)  
   plastic scintillator-low energy proton (RSRS)  
   photometer (Norwegian Institute of Cosmic Physics)  
   electron temperature and density probe (Univ. College, London)  
   positive ion composition and temperature probe (Univ. College)  
 Results: Spacecraft was placed in a lower orbit than planned ( $382 \times 291$  km instead of  $435 \times 400$  km)  
 because of a launch vehicle fourth-stage malfunction; as a result the mission lasted only 52  
 days instead of the planned 4 months; all experiments returned data successfully during the  
 spacecraft's operating lifetime.

---

Reference: MOR S-871-69-05, Sept. 23, 1969.

Table 3-91. *Cameo* Characteristics

---

Also called: Chemically Active Material Ejection in Orbit  
 Date of launch (range): Oct. 24, 1978 (WTR)  
 Launch vehicle: Delta 2910, launched with *Nimbus 7*  
 Responsible NASA Center: GSFC  
 Project manager: Ronald K. Browning  
 Project scientist: James P. Heppner  
 Objectives: Trace the complexities of the flow of ionized particles in and above earth's ionosphere by  
 observing the flow of released barium.  
 Results: The contents of four canisters of barium, attached to the second stage of the Delta 2910  
 launch vehicle, were ejected 950 km above Alaska on Oct. 29, 1978. The contents of one  
 canister of lithium were ejected over Scandanavia on Nov. 6 (in both cases the canisters  
 stayed attached to the Delta stage). The resulting clouds were successfully observed, pro-  
 viding the investigators with information on the movements of electrified natural particles.

---

Reference: NASA Hq., Press Release 78-136, "Nimbus-G." Sept. 8, 1978; NASA Hq., Press Release  
 78-142, "Lithium Clouds Will be Visible over Northern Europe," Sept. 19, 1978; and NASA  
 Hq., Press Release 78-169, "NASA to Release Orbital Clouds," Oct. 30, 1978.

Table 3-92. *ESRO 4* Characteristics

---

Memorandum of Understanding (MOU) between NASA and: European Space Research Organization,  
Dec. 1966

Date of launch (range): Nov. 21, 1972 (WTR)

Launch vehicle: Scout

Shape: cylindrical

Weight (kg): 130

Dimensions (m): 0.76, diam.  
1.38, height

Power source: solar cells plus battery

Prime contractor: Hawker-Siddeley Dynamics, U.K.

Date of reentry: Apr. 15, 1974

NASA's role: launch vehicle (reimbursable)

Responsible NASA center: LaRC

Project coordinator: Joseph Talbot

Objectives: To investigate and measure several phenomena in the polar ionosphere.

Experiments (responsible country or organization):

positive ions in ionosphere (U.K.)

composition and total mass density of natural gas in the upper thermosphere and exosphere  
(Federal Rep. of Germany)

low-energy particle precipitation in auroral zones (Sweden)

polar cap absorption (Netherlands)

solar flare measurements and trapped particles in lower radiation belt (Germany)

flight qualification of infrared horizon sensor (Netherlands)

Results: Successful.

---

Reference: MOR S-871-72-07, Nov. 13, 1972; and NASA Hq. News Release 72-214, "NASA to Launch European Spacecraft," Nov. 17, 1972.

Table 3-93. *GEOS 1* Characteristics

---

Also called: Geostationary Satellite  
 Memorandum of Understanding (MOU) between NASA and: European Space Agency (formerly European Space Research Organization), Mar. 5, 1975  
 Date of launch (range): Apr. 20, 1977 (ETR)  
 Launch vehicle: Delta 2914  
 Shape: cylindrical  
 Weight (kg): 574 (includes 335 kg apogee motor and propellant)  
 Dimensions (m): 1.65, diam.  
                   1.10, length, (extendable booms varied in length from 1.5 to 20 m)  
 Power source: solar cells plus Ag-Cd battery  
 Prime contractor: British Aircraft Corp.  
 Date of reentry: N/A  
 NASA's role: launch vehicle (reimbursable)  
 Responsible NASA center: GSFC  
 Vehicle-spacecraft coordinator: Jan King  
 Objectives: To investigate waves and particles in the magnetosphere from geostationary orbit.  
 Experiments (responsible country or organization):  
   wavefield (France, Denmark, Netherlands)  
   electrostatic analysis (U.K.)  
   mass spectrometer (Switzerland, Federal Rep. of Germany)  
   electron/proton spectrometer study of acceleration and precipitation process (Germany)  
   electron/proton spectrometer measurement of energy spectrum of electrons and protons (Sweden)  
   electric field (Germany)  
   magnetometer (Italy)  
 Results: Because of a launch vehicle third-stage malfunction the satellite was not placed in the planned geostationary orbit (36 000 × 36 000 km); by using the spacecraft apogee boost motor controllers put *GEOS 1* in an elliptical orbit (38 498 × 2131 km); satellite operated successfully, fulfilling a portion of its original scientific objectives.

---

Reference: M-492-302-77-01, Apr. 13, 1977.

Table 3-94. *GEOS 2* Characteristics

---

Also called: Geostationary Satellite  
 Memorandum of Understanding: same as for *GEOS 1*  
 Date of launch (range): July 14, 1978 (ETR)  
 Launch vehicle: Delta 2914  
 Shape: cylindrical  
 Weight (kg): 575 (includes 335 kg apogee motor and propellant)  
 Dimensions (m): same as for *GEOS 1*  
 Power source: same as for *GEOS 1*  
 Prime contractor: same as for *GEOS 1*  
 Date of reentry: N/A  
 NASA's role: same as for *GEOS 1*; because of the *GEOS 1* launch vehicle anomaly NASA agreed to provide support for a replacement spacecraft on a reimbursable basis  
 Responsible NASA center: GSFC  
 Vehicle-spacecraft coordinator: Frank Lawrence  
 Objectives: same as for *GEOS 1*  
 Experiments: same as for *GEOS 1*  
 Results: Largely successful, although a short circuit involving a series of solar cells disrupted signal transmission from three experiments; the satellite played a role in the International Magnetospheric Study Program.

---

Reference: MOR M-492-302-78-02, July 11, 1978.

Table 3-95. *Helios 1* Characteristics

---

Memorandum of Understanding (MOU) between NASA and: Bundesminister für Wissenschaftliche Forschung (Federal Rep. of Germany), June 10, 1969
Date of launch (range): Dec. 10, 1974 (ETR)
Launch vehicle: Titan-Centaur
Shape: 16-sided cylindrical central body with conical solar arrays attached at both ends
Weight (kg): 370
Dimensions (m): 1.75, diam. central compartment 0.55, height (2.12 with solar arrays; 4.2 with antenna mast) 2.77, largest diam. of solar arrays
Power source: solar arrays plus Ag-Zn battery
Prime contractor: Messerschmitt-Bolkow-Blohm
Date of reentry: N/A
NASA's role: launch vehicle and technical support; participation in experiment program
Responsible NASA center: GSFC
Project manager: Gilbert W. Ousley
Project scientist: James H. Trainor
Objectives: To investigate the fundamental solar processes and solar terrestrial relationships by the study of phenomena such as solar wind, magnetic and electric fields, cosmic rays, and cosmic dust in the region between earth's orbit and about 0.3 AU from the sun.
Experiments (responsible country or organization): plasma detection (Max-Planck-Institut) flux gate magnetometer (Institut für Geophysik und Meteorologie, TU Braunschweig) search-coil magnetometer (Institut für Nachrichtentechnik, TU Braunschweig and Institute für Geophysik und Meteorologie, TU Braunschweig) flux gate magnetometer (GSFC) plasma and radio wave (Univ. of Iowa) cosmic ray (Institut für Reine und Angewandte Kernphysik, Universität Kiel) cosmic ray (GSFC) electron detector (MPI) zodiacal light photometer (Landessternwarte Heidelberg) micrometeoroid analyzer (MPI) celestial mechanics (Institut für Theoretische Physik, Universität Hamburg)
Results: Successful; first perihelion (0.309 AU) was reached on Mar. 15, 1975; some data still being received in late 1982.

---

Reference: MOR S-823-74-01, Dec. 6, 1974.

Table 3-96. *Helios 2* Characteristics

---

Memorandum of Understanding: same as for *Helios 1*  
 Date of launch (range): Jan. 15, 1976 (ETR)  
 Launch vehicle: Titan-Centaur  
 Shape: same as for *Helios 1*  
 Weight (kg): 370  
 Dimensions (m): same as for *Helios 1*  
 Power source: same as for *Helios 1*  
 Prime contractor: same as for *Helios 1*  
 Date of reentry: N/A  
 NASA's role: same as for *Helios 1*  
 Responsible NASA center: GSFC  
 Project manager: G. Ousley  
 Project scientist: J. Trainor  
 Objectives: same as for *Helios 1*  
 Experiments (responsible country or organization): same as for *Helios 1* plus  
     Faraday rotation (JPL)  
     occultation (Deutsche Forschungs und Versuchsanstalt fuer Luft und Raumfahrt)  
 Results: Successful; first perihelion (0.29 AU) was reached on Apr. 17, 1976.

---

Reference: MOR S-823-76-02, Jan. 7, 1976; and Benjamin M. Elson, "Helios Mission Provides New Solar Data," *Aviation Week & Space Technology* (Feb. 14, 1977): 46-49.

Table 3-97. *HEOS 2* Characteristics

---

Also called: Highly Eccentric Orbiting Satellite  
 Memorandum of Understanding (MOU) between NASA and: European Space Research Organization,  
     June 16, 1970  
 Date of launch (range): Jan. 31, 1972 (WTR)  
 Launch vehicle: Thor-Delta L  
 Shape: 16-sided polyhedron  
 Weight (kg): 117  
 Dimensions (m): 1.3, diam.  
     0.4, length (2.39, overall length including adapter and boom)  
 Power source: solar cells plus battery  
 Prime contractor: Messerschmitt Bolkow Blohn  
 Date of reentry: Aug. 2, 1974  
 NASA's role: launch vehicle and technical support (reimbursable)  
 Responsible NASA center: GSFC  
 Project manager: Robert J. Goss  
 Objectives: To investigate interplanetary space and high-latitude magnetosphere and its boundary in  
     the region around the northern neutral point.  
 Experiments (responsible country or organization):  
     vector measurement of magnetic field (U.K.)  
     measurement of electrons and protons (Italy)  
     measurement of electromagnetic sun radiation (Denmark)  
     measurement of particles (Netherlands)  
     measurement of flux and energy spectrum of primary electrons (Italy and France)  
     measurement of solar wind and low-energetic particles (Federal Rep. of Germany)  
     measurement of flux of micrometeoroids (Germany)  
 Results: Successful.

---

Reference: MOR S-871-06, Jan. 6, 1972.

Table 3-98. *INTASAT* Characteristics

---

Also called: Instituto Nacional de Technica Aeroespacial Satellite  
Memorandum of Understanding: (MOU) between NASA and: Comision Nacional de Investigacion del Espacio (Spain), May 1972  
Date of launch (range): Nov. 15, 1974 (WTR)  
Launch vehicle: Thor-Delta 2310  
Shape: 12-sided polyhedron  
Weight (kg): 20  
Dimensions (m): 0.46, diam.  
0.45, height  
Power source: solar array plus NiCd battery  
Mission responsibility: Instituto Nacional de Technica Aeroespacial (INTA)  
Date of reentry: N/A  
NASA's role: launch vehicle, technical support, and tracking and data acquisition support for the spacecraft interferometer  
Responsible NASA center: GSFC  
Project manager: William Witt  
Objectives: To measure the ionospheric total electronic content, ionospheric irregularities, and ionospheric scintillations.  
Experiments (responsible country or organization):  
ionospheric beacon transmitter (INTA)  
Results: Successful; launched piggyback with *NOAA 4* and *AMSAT Oscar 7*.

---

Reference: NASA Hq., Off. of Space Science, report E-601-74-16, app. B, Sept. 20, 1974.

Table 3-99. *ISEE 1* Characteristics

---

Also called:	International Sun-Earth Explorer
Memorandum of Understanding (MOU) between NASA and:	European Space Agency, Mar. 1975
Date of launch (range):	Oct. 22, 1977 (ETR)
Launch vehicle:	Thor-Delta 2914
Shape:	cylindrical (16-sided)
Weight (kg):	328.95
Dimensions (m):	1.73, diam. 1.61, height
Power source:	solar arrays plus AgCd battery
Prime contractor:	N/A
Date of reentry:	N/A
NASA's role:	spacecraft, launch vehicle, and tracking and data acquisition
Responsible NASA center:	GSFC
Project manager:	Jeremiah J. Madden
Project scientist:	Keith W. Ogilvie
Objectives:	to increase our knowledge of solar-terrestrial relationships by making detailed measurements of the boundary regions that occur as a result of the solar wind impinging on earth's magnetic field environment, and to investigate the variations in these boundaries with solar wind fluctuations (for use with <i>ISSE 2</i> ).
Experiments (responsible country or organization):	fast plasma (Los Alamos Scientific Laboratories) low-energy protons and electrons (Univ. of Iowa) fluxgate magnetometer (Univ. of California, Los Angeles) plasma waves (Univ. of Iowa) plasma density (Paris Observatory) energetic electrons and protons (National Oceanic and Atmospheric Administration) electrons and protons (Univ. of California) fast electrons (GSFC) low energy cosmic ray (Max Planck Institut) quasistatic electronic field (Univ. of California) DC electric field (GSFC) ion composition (Lockheed Missiles and Space Co.) VLF wave propagation (Stanford Univ.)
Results:	Results from all experiments were obtained; data contributed to the International Magnetospheric Study; a third <i>ISEE</i> satellite was launched in 1978; <i>ISEE 1</i> and 2 were launched on a single Thor-Delta vehicle.

---

Reference: MOR S-862-77-01/02, Oct. 11, 1977.

Table 3-100. *ISEE 2* Characteristics

---

Also called: International Sun-Earth Explorer  
Memorandum of Understanding: same as for *ISEE 1*  
Date of launch (range): same as for *ISEE 1*  
Launch vehicle: same as for *ISEE 1*  
Shape: cylindrical  
Weight (kg): 157.72  
Dimensions (m): 1.27, diam.  
1.14, height  
Power source: same as for *ISEE 1*  
Prime contractor: Dornier Systems  
Date of reentry: N/A  
NASA's role: launch vehicle and tracking and data acquisition  
Responsible NASA center: GSFC  
Project manager: J. Madden  
Project scientist: K. Ogilvie  
Objectives: same as for *ISEE 1*  
Experiments (responsible country or organization):  
fast plasma (Max Planck Institut)  
low-energy protons and electrons (Univ. of Iowa)  
fluxgate magnetometer (Univ. of California, Los Angeles)  
plasma waves (Univ. of Iowa)  
plasma density (Paris Observatory)  
energetic electrons and protons (MPI)  
electrons and protons (Univ. of California)  
solar wind ions (Laboratorio Plasma Spazio)

Results: same as for *ISEE 1*

---

Reference: same as for *ISEE 1*



Table 3-101. *ISEE 3* Characteristics

---

Also called:	International Sun-Earth Explorer
Memorandum of Understanding:	same as for <i>ISEE 1</i> and <i>2</i>
Date of launch (range):	Aug. 12, 1978 (ETR)
Launch vehicle:	Thor-Delta 2914
Shape:	same as for <i>ISEE 1</i>
Weight (kg):	479
Dimensions (m):	same as for <i>ISEE 1</i>
Power source:	same as for <i>ISEE 1</i>
Prime contractor:	N/A
Date of reentry:	N/A
NASA's role:	same as for <i>ISEE 1</i>
Responsible NASA center:	GSFC
Project manager:	J. Madden
Project scientist:	Tycho von Rosenving
Objectives:	To obtain detailed measurements of the solar wind and its fluctuations at a libration point (a point where gravitational equilibrium exists among the sun, earth, and the moon).
Experiments (responsible country or organization):	<ul style="list-style-type: none"> <li>solar wind plasma (Los Alamos Scientific Laboratories)</li> <li>magnetometer (Jet Propulsion Laboratory)</li> <li>low energy cosmic ray (Max Planck Institut)</li> <li>medium energy cosmic ray (GSFC)</li> <li>high energy cosmic ray (Univ. of California)</li> <li>plasma waves (TRW Systems Group)</li> <li>protons (Imperial College, London)</li> <li>cosmic ray electrons (Univ. of Chicago)</li> <li>x-rays and electrons (Univ. of California)</li> <li>radio mapping (Paris Observatory)</li> <li>plasma composition (GSFC)</li> <li>high energy cosmic rays (California Institute of Technology)</li> <li>ground based solar studies (Stanford Univ.)</li> </ul>
Results:	Successfully joined with <i>ISEE 1</i> and <i>2</i> in returning data for use in the International Meteorological Study. In 1983 plans were being made to use <i>ISEE 3</i> to observe the Giacobini-Zinner and Halley's comets in 1985.
Reference:	MOR S-862-78-03, July 31, 1978.

---

Table 3-102. *ISIS 1* Characteristics

---

Also called: International Satellite for Ionospheric Studies  
 Memorandum of Understanding (MOU) between NASA and the Canadian Defense Research Board and the Canadian Dept. of Communications, 1963

Date of launch (range): Jan 30, 1969 (WTR)  
 Launch vehicle: Delta Standard Vehicle 3E  
 Shape: oblate spheroid (8-sided)  
 Weight (kg): 236  
 Dimensions (m): 1.27, diam.  
                   1.07, height

Power source: solar cells plus 3 NiCd batteries  
 Prime contractor: CA Victor Co., Montreal  
 Date of reentry: N/A  
 NASA's role: launch vehicle, technical support, tracking and data acquisition; participation in experimental program

Responsible NASA center: GSFC  
 Project manager: Evert D. Nelson  
 Project scientist: John E. Jackson

Objectives: To continue to extend a joint U.S.-Canadian program of ionospheric studies by combining sounder data with correlative direct measurements for a time sufficient to cover latitudinal and diurnal variations during a period of high solar activity.

Experiments (responsible country or organization):  
 swept frequency sounder (Defense Research Telecommunications Establishment)  
 fixed frequency sounder (DRTE)  
 VLF receiver/exciter (DRTE)  
 radio beacon (Univ. of Western Ontario)  
 cosmic radio noise (DRTE)  
 energetic particle detector (National Research Council, Canada)  
 ion mass spectrometer (Air Force Cambridge Research Laboratories, U.S.)  
 cylindrical electrostatic probe (GSFC)  
 spherical electrostatic analyzer (AFCRL)

Results: Successful; *ISIS 1* gave experimenters an opportunity to combine on one satellite direct and indirect measurements of important ionospheric parameters. Data were obtained until Oct. 1979; *ISIS 1* was the third in a series of 5 joint experiments with Canada.

---

Reference: MOR S-850-69-02, Jan. 27, 1969.



Table 3-104. *IUE 1* Characteristics (Continued)

---

Objectives: To conduct spectral distribution studies of celestial ultraviolet sources (see below); ground observatories were established at GSFC and at Vallofranca del Castillo.

Experiments: satellite functioned as an observatory for hundreds of users (45-cm Ritchey chretien telescope); scientific goals included:

- to obtain high resolution spectra of stars
- to study gas streams
- to observe faint stars, galaxies, and quasars
- to observe the spectra of planets and comets
- to make repeated observations which show variable spectra
- to define more precisely the modifications of starlight caused by interstellar dust and gas

Results: Highly successful; still in use in 1982.

---

Reference: MOR S-868-78-01, Jan. 18, 1978.

Table 3-105. *Miranda* Characteristics

---

Also called: UK-X4

Memorandum of Understanding: (MOU) between NASA and: U.K. Dept. of Trade and Industry, Dec. 1972

Date of launch (range): Mar. 8, 1974 (WTR)

Launch vehicle: Scout

Shape: rectangular

Weight (kg): 93.4

Dimensions (m): 0.84, height  
0.67, width (2.50 with solar arrays)

Power source: solar arrays

Prime contractor: Hawker Siddeley Dynamics, Ltd.

Date of reentry: N/A

NASA's role: launch vehicle (reimbursable)

Responsible NASA center: LaRC

Project manager: N/A

Project scientist: N/A

Objectives: To demonstrate the technology involved in the design and manufacture of a new type of experiment platform for use on small spacecraft.

Experiments (responsible country or organization):

attitude control system (U.K.)

infrared horizon sensor (U.K.)

single axis star sensor (U.K.)

albedo horizon sensor (U.K.)

silicon solar cells (U.K.)

Results: Successful; the experiment was designed for an operational lifetime of only six months.

---

Reference: MOR S-490-301-74-01, Feb. 22, 1974; and NASA Hq. Press Release 74-36, "NASA to Launch British Satellite," Feb. 24, 1974.

Table 3-106. *San Marco 3* Characteristics

---

Also called: San Marco 3 Explorer  
 Memorandum of Understanding (MOU) between NASA and: Commissione per le Ricerche Spaziale,  
 Italy, Nov. 18, 1967  
 Date of launch (range): Apr. 24, 1971 (San Marco)  
 Launch vehicle: Scout  
 Shape: spherical  
 Weight (kg): 171.5  
 Dimensions (m): 0.71, diam.  
 Power source: solar cells plus 2 NiCd batteries  
 Prime contractor:  
 Date of reentry: Nov. 29, 1971  
 NASA's role: launch vehicle; participation in experiment program  
 Responsible NASA center: GSFC  
 Project manager: Anthony J. Caporale  
 Project scientist: George P. Newton  
 Objectives: To investigate earth's equatorial atmosphere in terms of neutral density, composition, and  
 temperature, and its response to diurnal or sporadic changes in atmospheric heat input.  
 Experiments (responsible country or organization):  
 drag balance (Centro Ricerche Aerospaziali)  
 O megatron (GSFC; Univ. of Michigan)  
 neutral mass spectrometer (GSFC)  
 Results: Successful.

---

Reference: MOR S-984-71-03, Apr. 9, 1971.

Table 3-107. *San Marco 4* Characteristics

---

Also called: San Marco 4 Explorer  
 Memorandum of Understanding: same as for *San Marco 3*, Aug. 6, 1974  
 Date of launch (range): Feb. 18, 1974 (San Marco)  
 Launch vehicle: Scout  
 Shape: spherical  
 Weight (kg): 170  
 Dimensions (m): 0.70, diam.  
 Power source: same as for *San Marco 3*  
 Prime contractor:  
 Date of reentry: May 4, 1976  
 NASA's role: same as for *San Marco 3*  
 Responsible NASA center: GSFC  
 Project manager: A. Caporale  
 Project scientist: G. Newton  
 Objectives: To obtain measurements of the diurnal variations of the equatorial neutral atmosphere den-  
 sity, composition, and temperature.  
 Experiments: same as for *San Marco 3*  
 Results: Successful.

---

Reference: S-894-74-04, Feb. 15, 1974.

Table 3-108. *Solrad 11A* Characteristics

---

Also called: Solar Radiation Monitoring Satellite System or Solrad Hi  
 Memorandum of Understanding (MOU) between NASA and: Naval Research Laboratory Naval Electronics Systems Command

Date of launch (range): Mar. 15, 1976 (ETR)  
 Launch vehicle: Titan IIIC  
 Shape: donut-shaped  
 Weight (kg): 182  
 Dimensions (m): 1.4, diam.  
                   0.4, height

Power source: solar panels  
 Prime contractor: NRL in-house  
 Date of reentry: N/A  
 NASA's role: tracking and data acquisition support  
 Responsible NASA center: GSFC  
 Project manager: N/A  
 Project scientist: N/A

Objectives: One of a pair of spacecraft to provide real-time, continuous monitoring of solar x-ray, ultraviolet, and energetic particle emissions.

Experiments (responsible country or organization):  
 25 experiments that made use of the following hardware:  
   broadband ion chamber  
   proportional counters and scintillators  
   EUV detector  
   variable resolution Ebert-Fostic spectrometer  
   solar wind monitor  
   solar proton, electron, and alpha particle monitors  
   x-ray polarimeters  
   Bragg spectrometer  
   large-area auroral x-ray detector  
   passively-cooled solid-state x-ray detector  
   cosmic-ray burst detector

experiments sponsored by the following organizations:  
   NRL  
   Johns Hopkins  
   MIT  
   U.S. Air Force Geophysics Laboratory  
   Los Alamos Scientific Laboratory  
   Aerospace Corp.

Results: Successful; NASA support terminated in Nov. 1979. For information on *Solrad 10*, see *Explorer 44* (table 3-58); payload launched with *Solrad 11B* and *LES-8* and *LES-9*, two experimental Air Force communications satellites.

---

Reference: NRL Press Release 9-1-76B, "Solrad Hi Is Up!" Mar. 14, 1976; and NRL, Cape Canaveral Air Force Station, Eastern Test Range, "Launch of the Solrad 11A/B Satellites (Solrad Hi)," 1976.

Table 3-109. *Solrad 11B* Characteristics

---

Also called: same as for *Solrad 11A*  
 Memorandum of Understanding: same as for *Solrad 11A*  
 Date of launch (range): Mar. 15, 1976 (ETR)  
 Launch vehicle: Titan IIIC  
 Shape: donut-shaped  
 Weight (kg): 182  
 Dimensions (m): 1.4, diam.  
                   0.4, height  
 Power source: solar panels  
 Prime contractor: NRL in-house  
 Date of reentry: N/A  
 NASA's role: same as for *Solrad 11A*  
 Responsible NASA center: GSFC  
 Project manager: N/A  
 Project scientist: N/A  
 Objectives: same as for *Solrad 11A*  
 Experiments: same as for *Solrad 11A*  
 Results: Successful; see also *Solrad 11A* and *Explorer 44*.

---

Reference: same as for *Solrad 11A*.

Table 3-110. *TD-1A* Characteristics

---

Also called: Thor-Delta 1  
 Memorandum of Understanding (MOU) between NASA and: European Space Research Organization,  
                   Dec. 1966  
 Date of launch (range): Mar. 11, 1972 (WTR)  
 Launch vehicle: Delta N  
 Shape: box-like  
 Weight (kg): 472  
 Dimensions (m): 0.98, diam.  
                   2.16, height  
 Power source: solar panels plus NiCd battery  
 Prime contractor: Engines Matra, France  
 Date of reentry: Jan. 9, 1980  
 NASA's role: launch vehicle, technical support (reimbursable)  
 Responsible NASA center: GSFC  
 Project manager: Robert J. Goss  
 Project scientist: N/A  
 Objectives: To make ultraviolet spectrometer measurements of the celestial sphere on an approximately  
                   180-day cycle.  
 Experiments (responsible country or organization):  
   ultraviolet spectral telescope (Univ. of Liege; U.K. Science Research Council)  
   ultraviolet stellar spectrometer (Laboratorium Voor Ruumteonderzoek)  
   spectral study of cosmic rays (Centre d'Etudes Nucleaires)  
   spectral study of extraterrestrial x-rays (CEN)  
   solar gamma ray detection (Univ. of Milan)  
   spectral study of solar x-rays (LVR)  
   stellar gamma ray detection (Max-Planck-Institut; Univ. of Milan; CEN)  
 Results: Successful.

---

Reference: MOR S-492-72-03, Mar. 1, 1972.

## DESCRIPTION – PLANETARY PROGRAM

NASA's Office of Planetary Programs of the 1970s inherited an ongoing effort to explore the near planets with Pioneer and Mariner probes. With successful manned exploration of the moon, unmanned lunar spacecraft were not needed, and scientists turned their full attention to planetary exploration. They continued the use of probes to the near planets and added orbiters, a Mars lander, and probes to the outer planets to the program.

NASA conducted three Mariner projects during the 1970s, all of which were proposed during NASA's first decade. Mariner Mars 69 spacecraft flew by Mars; Mariner Mars 71 orbited the Red Planet; and Mariner Mercury-Venus probed those two planets.

Although its large Voyager lander project was cancelled in reply to demands from Congress that NASA trim its budget, the agency proposed an alternative—a Viking orbiter-lander mission to Mars. Viking became the first spacecraft to soft-land and conducted extended mission operations on another planet when they touched down on Mars in 1976.<sup>10</sup>

With Pioneer, the space agency extended its search for information to the outer planets of the solar system. Pioneer-Jupiter and Pioneer-Saturn began their long journeys in the early 1970s, reaching Jupiter in 1973 and Saturn in 1979. Data received by the scientific investigators only whetted their appetites for more. Pioneer became the first spacecraft to pass beyond the known planets in 1983. Pioneer Venus spacecraft in 1978 took a close look at this nearby planet with both an orbiter and several impact probes.

NASA sent two Voyager spacecraft to the far planets in 1977. Although a substitute for the more ambitious Grand Tour of the outer planets NASA had hoped to conduct, Voyager results have been impressive. Voyager has returned high-resolution images of the two planets, their moons, and rings and are on their way to Uranus and beyond the solar system.

The NASA Office of Planetary Programs was led by Donald P. Heath until 1971, when Robert S. Kraemer took that position. A. Thomas Young became director of the office in 1976. In addition to program managers for the several flight projects, the director could count on the expertise of program chiefs for planetary astronomy, planetary atmospheres, planetology, planetary quarantine, and exobiology. Centers involved in planetary exploration projects included the Jet Propulsion Laboratory, Langley Research Center, and Ames Research Center.

### Mariner

NASA initiated the Mariner program in the early 1960s as its key to investigating the nearby planets. These small (200–260-kilogram) spacecraft were designed to fly by our closest neighbors, Mars or Venus, and collect scientific data on the planets' atmosphere and surface. *Mariner 2* became the first spacecraft to scan another planet in December 1962, when it passed within 34 762 kilometers of Venus. *Mariner 4* provided investigators with the first closeup images of Mars in July 1965. Venus was again the subject of observation when *Mariner 5* collected data



from 4000 kilometers away in 1967. Proposals for more sophisticated Mariner orbiters and landers were never pursued during the 1960s because of several budget cuts and unforeseen delays with the development of more powerful launch vehicles (see vol. 2).

The three distinct Mariner projects carried out during the 1970s all had been proposed during NASA's first decade. Two of these projects, Mariner Mars 69 and Mariner Mars 71, proved to be critical steps for the Office of Space Science's Viking orbiter-lander mission to the Red Planet (1975–76). *Mariner 6* and *7* (Mariner Mars 69) flew by Mars at 3218 kilometers to study the atmosphere and the planet's surface, establishing a basis for future experiments that would search for extraterrestrial life. The two spacecraft also demonstrated engineering concepts and techniques required for long-duration flight away from the sun. *Mariner 9* (Mariner Mars 71) was in orbit around Mars for 90 days, providing more than 5000 television images of the surface and data about the planet's composition and atmosphere. *Mariner 10* (Mariner Mercury-Venus), another flyby mission, used the gravity of the first planet it encountered, Venus, to assist it on its way to the second, Mercury (see table 3-111).

NASA Headquarters authorized Mariner Mars 69 in late 1965 and assigned the project to the Jet Propulsion Laboratory (JPL). As it had with the earlier Mariner spacecraft, JPL continued its practice of serving as the prime contractor, designing and assembling the two probes in its Spacecraft Assembly Facility in Pasadena, California. Subcontractors contributed various hardware components and subsystems to JPL, and scientists from four institutions provided onboard experiments (see fig. 3-4). *Mariner 6* and *7* lifted off from their launch pads successfully in February and March 1969 and each passed by Mars some five months later. Telescopes, infrared radiometers, infrared spectrometers, and ultraviolet spectrometers all performed as planned, with additional data being provided by celestial mechanics and S-band occultation experiments. Together, the two spacecraft returned 200 television pictures of Mars, which revealed a stark, lunar-like world. Craters ranged in size from 500 meters to 500 kilometers in diameter.

Nothing in Mariner 69's data encouraged those scientists who hoped to discover life on Mars, but neither did it exclude the possibility. NASA engineers and scientists who were already at work on Mariner 71 and Viking learned that they should remain flexible and adaptable as they designed these more sophisticated spacecraft (see tables 3-112, -115, and -116).

With two Mariner 71 orbiters, investigators hoped to map the entire surface of Mars. The 90-day orbits would also allow scientists to observe seasonal changes. NASA assigned four broad goals to Mariner 71: search for an environment that could support exobiological activity; gather information about the origin and evolution of the planet; collect basic data related to planetary physics, geology, planetology, and cosmology; and provide data that would help Viking planners choose touch-down sites for two landers. Orbiter cameras would provide the imagery; ultraviolet spectrometers, and infrared radiometers and spectrometers would provide other clues.

JPL again played the role of spacecraft contractor during Mariner Mars 71, relying on subcontractors to provide it with major components and instruments. These orbiters grew in size, weight, and complexity over their Mariner predecessors, as they were given their new orbital assignment (see fig. 3-5).

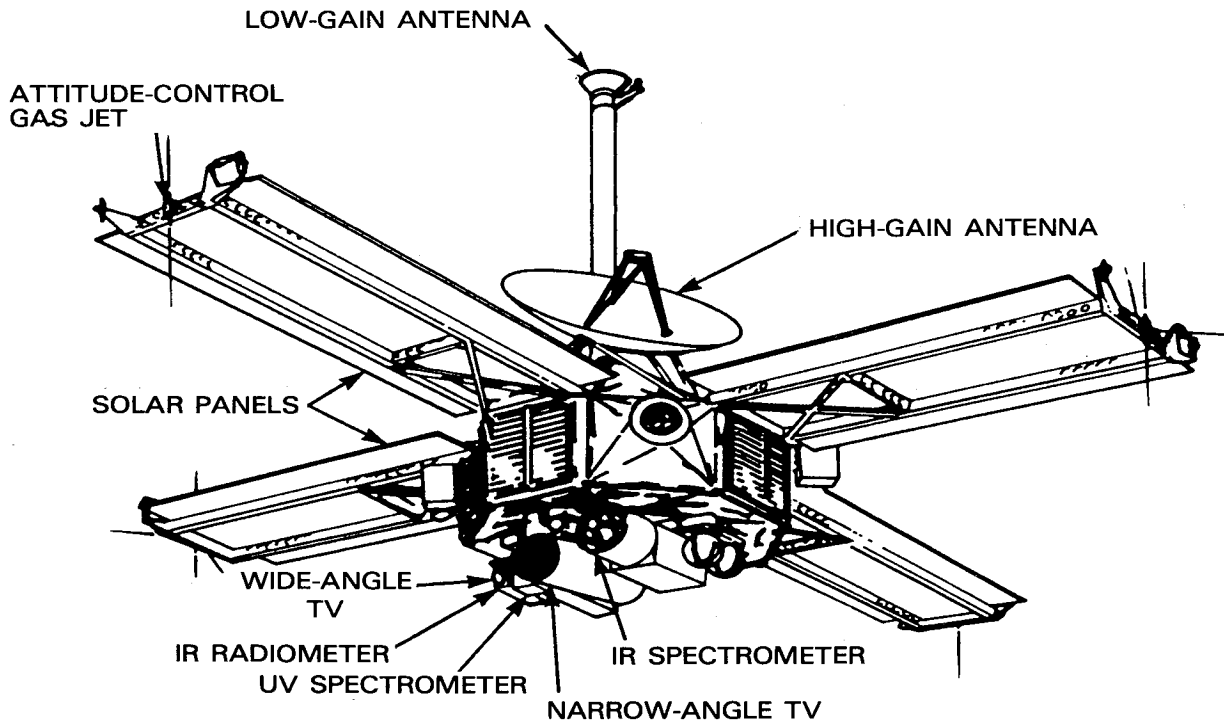
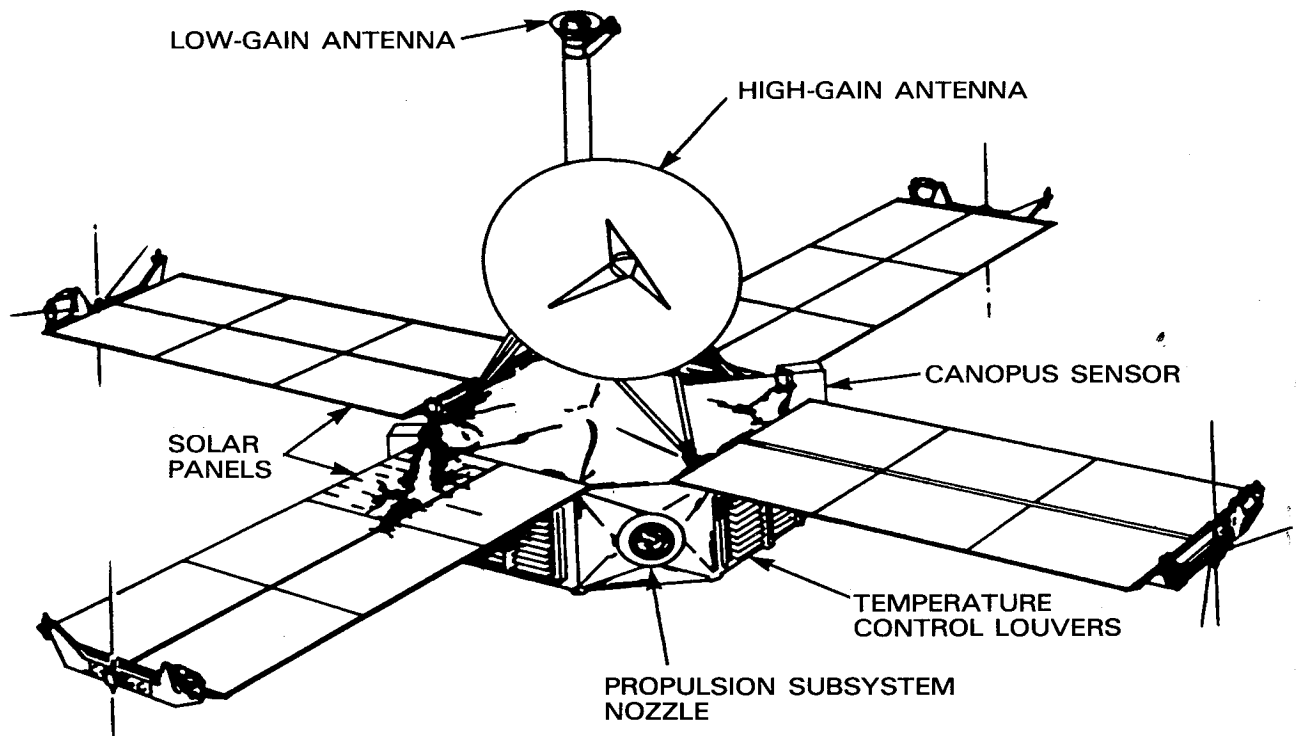

SCAN PLATFORM THERMAL BLANKET DELETED

Figure 3-4. Mariner Mars 1969

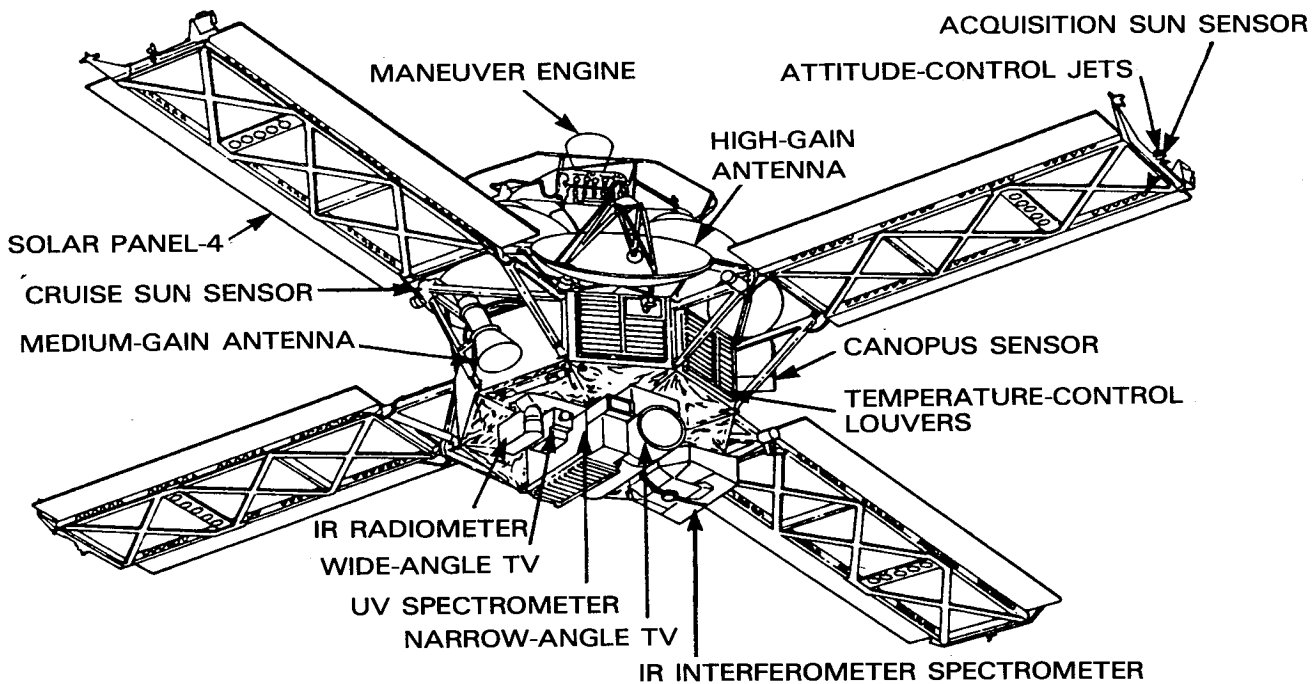
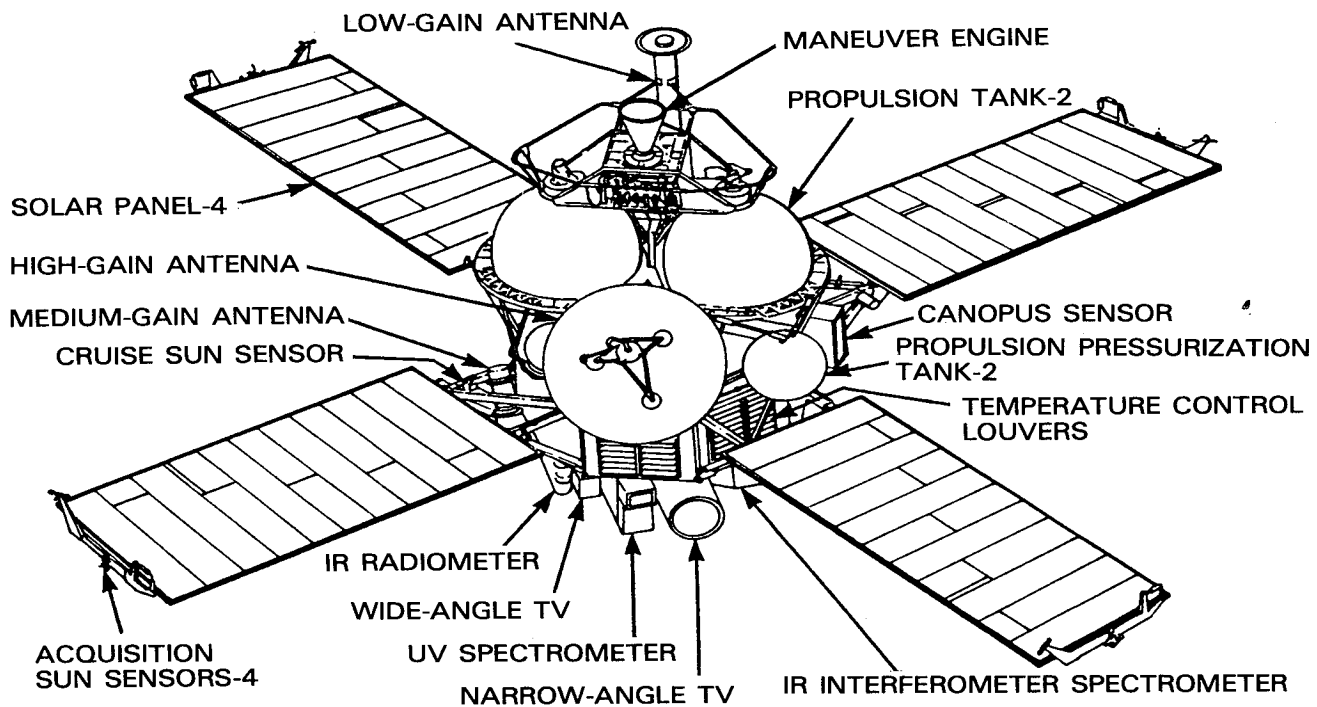

PROPULSION MODULE AND SCAN PLATFORM INSULATION BLANKETS NOT SHOWN

Figure 3-5. Mariner Mars 1971

The Mariner Mars 71 team did not get the chance to perform its two complementary missions. During the launch of Mariner H, the Centaur upper stage malfunctioned, and it and the spacecraft fell into the ocean. *Mariner 9* fared better, and it began its orbits around Mars on November 13, 1971, becoming the first spacecraft to orbit another planet. Mars, however, did not cooperate. The worst Martian dust storm ever recorded was just beginning as *Mariner 9* made its approach; the dust clouds did not clear until late February 1972. When *Mariner 9*'s high-resolution cameras began recording the features of Mars, the waiting specialists were treated to views of a Mars that were different from those returned by the earlier flyby missions. The crisper images revealed that Mars was a younger, more dynamic planet than was previously believed.

*Mariner 9* provided scientists and Viking mission planners with images of 100% of the planet at a resolution of 1 kilometer taken during 349 days in orbit. It also photographed Deimos and Phobos, moons of Mars. Data were also produced on the planet's surface and composition, atmospheric constituents, temperature, pressure, and water content, and surface temperature (see tables 3-113, -117, -118).<sup>11</sup>

The exploration of Mercury was the primary goal of *Mariner 10*. Placed into a launch trajectory in November 1973 that took it first by Venus (within 5800 kilometers), the spacecraft used the gravitational force of that planet to reach Mercury. During its 16-month lifetime, *Mariner 10* flew by Mercury three times; its closest approach was 327 kilometers. It returned the first television images of this planet closest to the sun, enabling specialists to map 45% of it, as well as information on the atmospheres and surface of Venus and Mercury. Scientists received their first evidence of the rotating clouds of Venus and the thin helium atmosphere and weak magnetic field of Mercury (see tables 3-114 and -119).

*Mariner 10*, built by the Boeing Company under contract to JPL, was the first spacecraft to use the gravity of one planet to reach another. The 430-kilogram craft carried six scientific experiments in addition to its television (see fig. 3-6).<sup>12</sup>

NASA's Office of Space Science and Exploration managed the Mariner program. Donald P. Heath served as director of the planetary program until 1971, when Robert S. Kraemer assumed the title. A. Thomas Young finished out the decade, becoming director in 1976. N. William Cunningham had the program manager's job for Mariner Mars 69 and Mariner Mercury-Venus 73. Carl W. Glahn

Table 3-111. Mariner Satellites, 1969-1973

Mission	Also Called	Launched	Results
Mariner 6	Mariner Mars 69	Feb. 24, 1969	Flew by Mars in July 1969 and sent data on topography and atmosphere (equatorial region).
Mariner 7	Mariner Mars 69	Mar. 27, 1969	Flew by Mars in Aug. 1969 and sent similar data as above (polar regions).
Mariner H	Mariner Mars 71	May 8, 1971	Launch unsuccessful.
Mariner 9	Mariner Mars 71	May 30, 1971	Inserted into Martian orbit in Nov. 1971; mapped 85% of planet.
Mariner 10	Mariner Venus Mercury 73	Nov. 3, 1973	Flew by Venus in Feb. 1974, Mercury in Mar. and Sept. 1974 and Mar. 1975; sent data on atmosphere, surface, and physical characteristics of two planets.

held that position for Mariner Mars 71. Project directors at JPL for these projects reported to the Headquarters program managers. All launches took place at the Kennedy Space Center. The Deep Space Network was employed to support these missions.

Table 3-112. Chronology of Mariner Mars 69 Development and Operations

Date	Event
Dec. 22, 1965	NASA Headquarters authorized a 1969 Martian flyby project for two Mariner spacecraft to be managed by the Jet Propulsion Laboratory (JPL).
Feb. 11, 1966	The Mariner Mars 69 spacecraft system design team held its first meeting.
Feb. 28, 1966	NASA Hq. approved the Mariner Mars 69 project approval document.
Apr. 7, 1966	NASA limited the experiment candidates to Mars-oriented investigations.
May–Nov. 1966	NASA issued Phase 1 requests for proposals (RFP).
May 26, 1966	NASA selected experiments for the two spacecraft.
July 31, 1966	Program officials completed a first draft of mission requirements.
Sept. 1966	Program officials completed a final draft of the project development plan.
Nov. 15, 1966	JPL completed a spacecraft configuration mockup.
Jan. 10, 1967	The mission operations design team held its first meeting.
Jan.–Mar. 1967	JPL conducted a subsystem preliminary design review.
July–Nov. 1967	JPL conducted spacecraft subsystem detail design reviews.
July 15, 1967	Program officials made concessions to meet FY 1968 budget cuts (they delete the approach system guidance subsystem in Sept. for the same reason).
Nov. 1967	The subcontractor delivered the Centaur launch vehicle engines for AC-19.
Nov. 28, 1967	Officials conducted a launch vehicle system design review.
Dec. 8, 1967	The subcontractor delivered the first spacecraft octagon structure to JPL.
Jan. 22, 1968	Program officials declared that the spacecraft preliminary design phase had been completed.
Mar. 1968	The subcontractor delivered the Centaur engines for AC-20.
Apr. 1968	Contractors completed the assembly of AC-19.
May 22, 1968	Team members delivered the first flight spacecraft structure to the spacecraft assembly facility.
June 5, 1968	NASA approved AC-19.
June 15, 1968	Contractors completed the assembly of AC-20.
June 18, 1968	Team members delivered the second flight spacecraft structure to the spacecraft assembly facility.
July 20, 1968	NASA approved AC-20.
Sept. 1968	Contractors delivered AC-19 to the Kennedy Space Center.
Sept. 26, 1968	NASA held a project science review.
Nov.–Dec. 1968	Contractors delivered AC-20 to KSC.
Dec. 1968–	JPL delivered three Mariner 69 spacecraft to KSC.
Jan. 1969	
Jan. 21, 1969	NASA conducted joint flight acceptance tests with AC-19 and Mariner F.
Jan. 24, 1969	NASA conducted joint flight acceptance tests with AC-20 and Mariner G.
Feb. 1969	NASA conducted launch readiness reviews at KSC, NASA Hq., and JPL.
Feb. 1969	While mating AC-19 and Mariner F, technicians accidentally depressurized the Atlas stage; officials reassigned AC-20 to Mariner F.
Feb. 18, 1969	Technicians mated Mariner F and AC-20.
Feb. 20, 1969	Contractors delivered a new Atlas stage for AC-19.
Feb. 22, 1969	NASA verified Mariner F ready for launch.
Feb. 25, 1969	NASA launched <i>Mariner 6</i> successfully.
Mar. 20, 1969	NASA verified Mariner G ready for launch.
Mar. 27, 1969	NASA launched <i>Mariner 7</i> successfully.
July 31, 1969	<i>Mariner 6</i> flew by Mars, the closest distance to the planet being 3200 kilometers.
Aug. 5, 1969	<i>Mariner 7</i> flew by Mars.

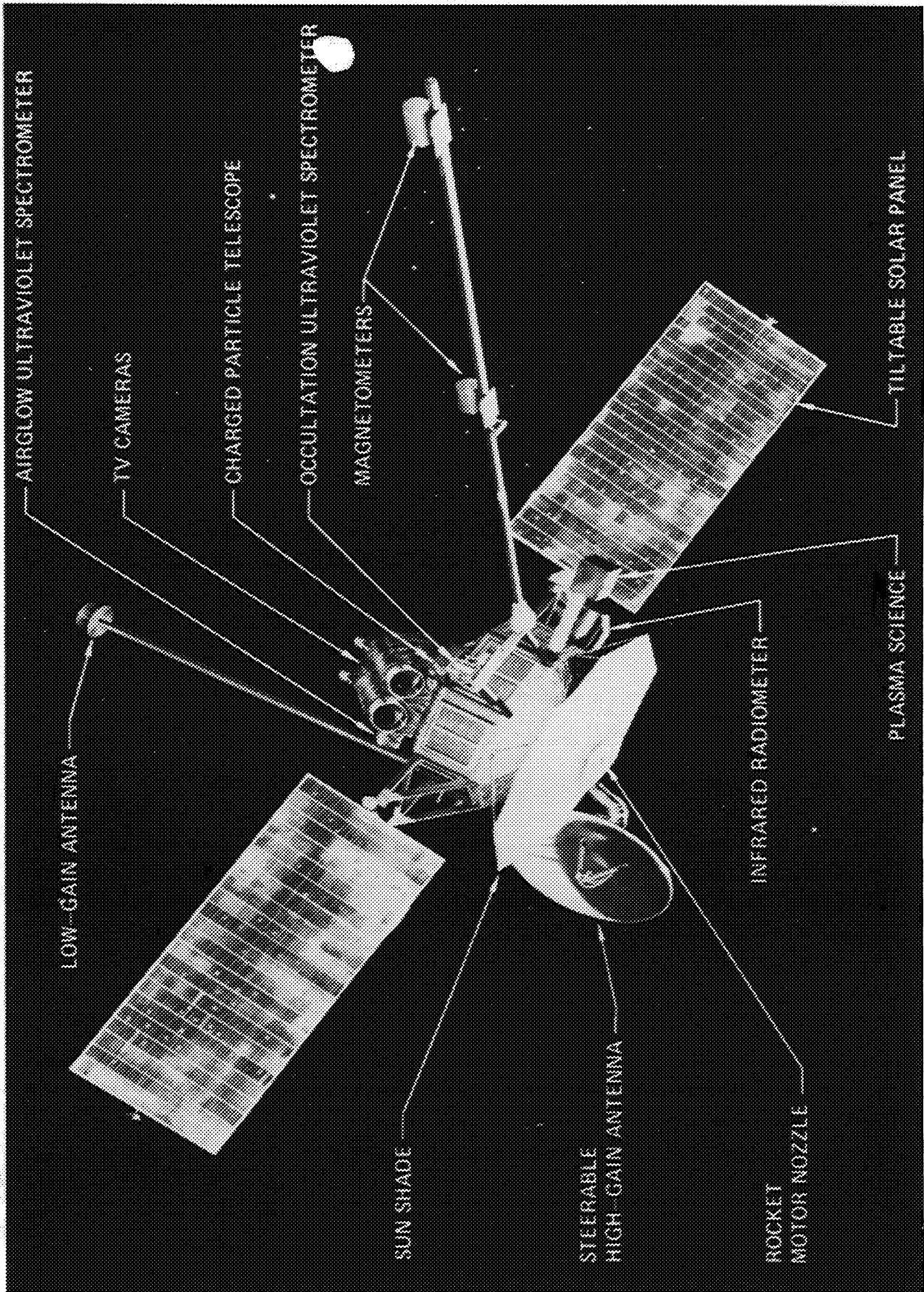

Figure 3-6. Mariner Venus/Mercury 1973

ORIGINAL PAGE IS  
OF POOR QUALITY

Table 3-113. Chronology of Mariner Mars 71 Development and Operations

Date	Event
Nov. 1967	NASA officials recommended a two-spacecraft Mariner Mars 71 orbital project after the Voyager orbiter-lander mission was cancelled.
Aug. 23, 1968	NASA Headquarters approved a Mariner Mars 71 project approval document.
Nov. 14, 1968	NASA Hq. authorized JPL to begin work on Mariner spacecraft H and I.
May 8, 1971	NASA attempted to launch Mariner H; because of a Centaur stage failure the range safety officer destroyed the spacecraft shortly after launch.
May 30, 1971	NASA launched <i>Mariner 9</i> successfully.
Nov. 13, 1971	<i>Mariner 9</i> began orbiting Mars.
Oct. 27, 1972	NASA terminated the <i>Mariner 9</i> mission because the supply of attitude control fuel had been depleted.

Table 3-114. Chronology of Mariner 10 Development and Operations

Date	Event
June 1968	The Space Science Board recommended that NASA conduct a Mariner flyby mission of the planets Venus and Mercury.
Dec. 30, 1969	NASA Headquarters assigned the Mariner Venus-Mercury project to JPL.
May 1969	Congress reduced the funds available for the Venus-Mercury mission.
July 28, 1970	NASA selected seven experiments for the Mariner Venus-Mercury spacecraft.
April 29, 1971	NASA announced that Boeing Company would be the prime contractor for the Mariner Venus-Mercury spacecraft.
Nov. 3, 1973	NASA launched <i>Mariner 10</i> successfully.
Feb. 5, 1974	<i>Mariner 10</i> encountered Venus, coming within 5800 kilometers.
Mar. 29, 1974	<i>Mariner 10</i> encountered Mercury for the first time, coming within 704 kilometers.
Sept. 21, 1974	<i>Mariner 10</i> encountered Mercury for the second time, coming within 48 069 kilometers.
Mar. 16, 1975	<i>Mariner 10</i> encountered Mercury for the last time, coming within 327 kilometers.
Mar. 24, 1975	NASA terminated the mission when the attitude control fuel supply was depleted.

Table 3-115. *Mariner 6* Characteristics

---

Also called: Mariner Mars 69  
 Date of launch (range): Feb. 24, 1969 (ETR)  
 Launch vehicle: Atlas-Centaur  
 Shape: octagonal with 4 solar panels  
 Weight (kg): 381  
 Dimensions (m): 1.37, width; 5.79 with panels extended  
                   0.46, height; 3.35 with panels extended  
 Power source: solar panels plus AgZn battery  
 Prime contractor: in-house  
 Date of reentry: N/A Heliocentric orbit  
 Responsible NASA center: JPL  
 Project manager: H. M. Schurmeier  
 Project scientist: J. A. Stallkamp  
 Objectives: To conduct flyby missions in order to make exploratory investigations of Mars. Information sought regarding Martian topography and atmosphere in the equatorial region (*Mariner 7* twin mission).  
 Experiments (responsible organization):  
   television (California Institute of Technology)  
   infrared spectrometer (Univ. of California at Berkeley)  
   ultraviolet spectrometer (Univ. of Colorado)  
   infrared radiometer (CIT)  
   celestial mechanics (JPL)  
   S-band occultation (JPL)  
 Results: Successful; passed by Mars on July 31, 1969, within 3200 kilometers. Together *Mariner 6* and *7* returned a total of 200 television pictures of the planet; the probes were used in 1970 in an experiment to verify the theory of relativity.

---

Reference: MOR S-816-69-01/02, Feb. 18, 1969; and NASA Hq., "Mission Report, Mariners Six and Seven," Oct. 29, 1969.

Table 3-116. *Mariner 7* Characteristics

---

Also called: Mariner Mars 69  
 Date of launch (range): Mar. 27, 1969 (ETR)  
 Launch vehicle: Atlas-Centaur  
 Shape: same as *Mariner 6*  
 Weight (kg): 381  
 Dimensions (m): same as *Mariner 6*  
 Power source: same as *Mariner 6*  
 Prime contractor: in-house  
 Date of reentry: N/A Heliocentric orbit  
 Responsible NASA center: JPL  
 Project manager: Schurmeier  
 Project scientist: Stallkamp  
 Objectives: To conduct flyby missions in order to make exploratory investigations of Mars. Information sought regarding Martian topography and atmosphere in the southern hemisphere and polar regions (*Mariner 6* twin mission).  
 Experiments (responsible organization): same as for *Mariner 6*  
 Results: Successful; passed by Mars on Aug. 5, 1969, within 3200 kilometers; together *Mariner 6* and *7* returned a total of 200 television pictures of the planet. The spacecraft were used in 1970 in an experiment to verify the theory of relativity.

---

Reference: MOR S-816-69-01/02, Feb. 18, 1969; and NASA Hq., "Mission Report, Mariners Six and Seven," Oct. 29, 1969; and NASA Hq. Release 69-26A, "Mariner Mars '69 Approach and Near Encounter Sequence of Events," July 19, 1969.



Table 3-117. Mariner H Characteristics

---

Also called: would have been Mariner 8 if successful; Mariner-Mars 71  
 Date of launch (range): May. 8, 1971 (ETR)  
 Launch vehicle: Atlas-Centaur  
 Shape: octagonal with 4 solar panels  
 Weight (kg): 997.9  
 Dimensions (m): 1.38, width; 6.9 with solar panels extended  
                   2.44, height  
 Power source: solar panels plus NiCd battery  
 Prime contractor: in-house  
 Date of reentry: N/A  
 Responsible NASA center: JPL  
 Project manager: D. Schneiderman  
 Project scientist: R. H. Steinbacher  
 Objectives: To study the physical and dynamic characteristics of Mars from orbit for a minimum of 90 days. Information to be obtained on composition, density, pressure, and thermal properties of the atmosphere and the characteristics, temperature, and topography of the surface (twin mission *Mariner 9*).

Experiments (responsible organization):  
 television (U.S. Geological Survey)  
 ultraviolet spectroscopy (Univ. of Colorado)  
 infrared spectroscopy (GSFC)  
 infrared radiometer (California Institute of Technology)  
 S-band occultation (JPL)  
 celestial mechanics (JPL)

Results: Unsuccessful; the Centaur upper stage of the launch vehicle malfunctioned shortly after liftoff and the spacecraft was destroyed.

---

Reference: MOR S-819-71-01/02, Apr. 12, 1971.

Table 3-118. *Mariner 9* Characteristics

---

Also called: Mariner-Mars 71  
 Date of launch (range): May 30, 1971 (ETR)  
 Launch vehicle: Atlas-Centaur  
 Shape: same as Mariner H  
 Weight (kg): 997.9  
 Dimensions (m): same as Mariner H  
 Power source: same as Mariner H  
 Prime contractor: in-house  
 Date of reentry: N/A Aerocentric orbit  
 Responsible NASA center: JPL  
 Project manager: Schneiderman  
 Project scientist: Steinbacher  
 Objectives: To study the physical and dynamic characteristics of Mars from orbit for a minimum of 90 days. Information to be obtained on composition, density, pressure, and thermal properties of the atmosphere and the characteristics, temperature, and topography of the surface (twin mission Mariner H, which was unsuccessful).

Experiments (responsible organization): same as for Mariner H

Results: Successful; mapped 85% of the planet, took first photos of the moons Deimos and Phobos. *Mariner 9* was inserted into orbit on Nov. 13, 1971; the mission was terminated on Oct. 27, 1972, when the supply of attitude control gas was depleted.

---

Reference: MOR S-819, 71-01/02, Apr. 12, 1971.

Table 3-119. *Mariner 10* Characteristics

Also called: Mariner Venus Mercury 73

Date of launch (range): Nov. 3, 1973 (ETR)

Launch vehicle: Atlas-Centaur

Shape: octagonal with 2 solar panels

Weight (kg): 528

Dimensions (m): 1.39, diameter; 6.8 with panels extended  
0.46, height

Power source: solar panels plus NiCd battery

Prime contractor: in-house

Date of reentry: N/A Heliocentric orbit

Responsible NASA center: JPL

Project manager: Walker E. Giberson

Objectives: On a flyby mission obtain data on the atmosphere, surface, and physical characteristics of Mercury and Venus, using the gravity of Venus to assist the spacecraft on its journey to Mercury.

Experiments (responsible organization):

television (California Institute of Technology)

plasma science (Massachusetts Institute of Technology)

ultraviolet spectroscopy (Kitt Peak Observatory)

infrared radiometer (Santa Barbara Research Center)

charged particles (Univ. of Chicago)

radio science (Stanford Univ.)

magnetic fields (GSCF)

Results: Successful; the spacecraft passed within 5800 kilometers of Venus on Feb. 5, 1974. Its first encounter with Mercury took place on March 29, 1974 (704 km); second on Sept. 21, 1974 (48 069 km); and third on March 16, 1975 (327 km); the spacecraft was shut down on March 24, 1975, when its attitude control gas supply was depleted.

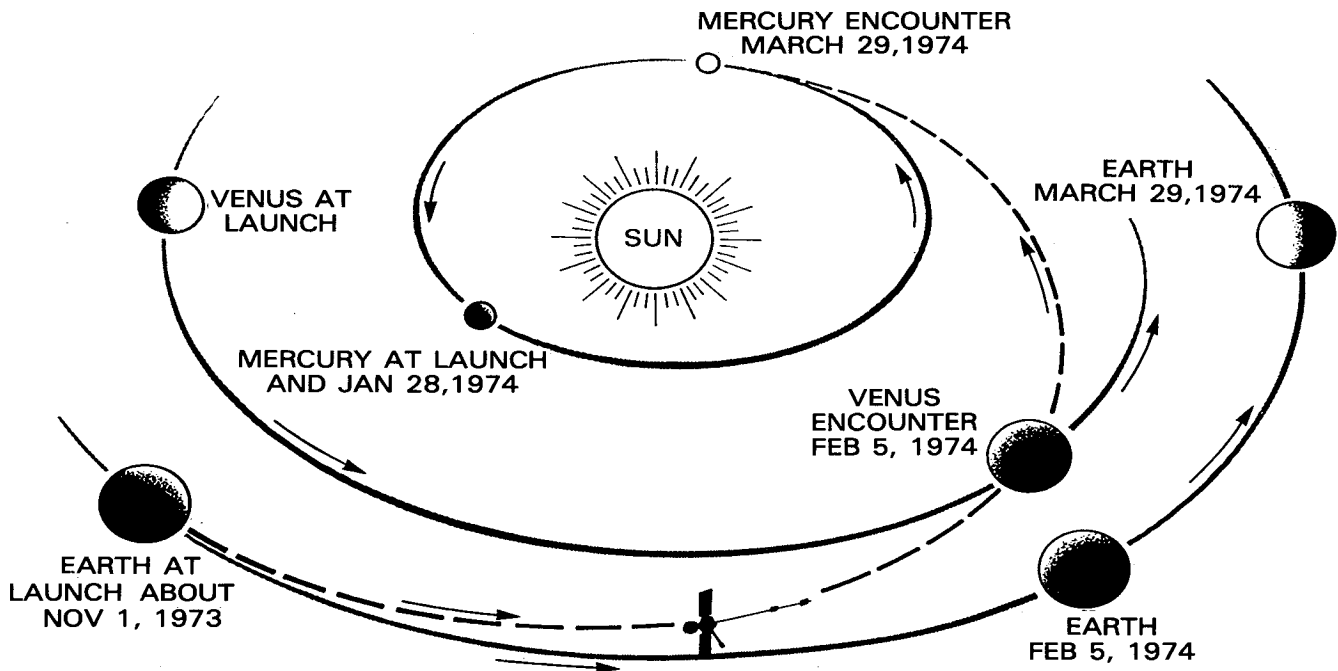

Figure 3-7. *Mariner Venus - Mercury Flight Path*

## Viking

Planetary landers had been part of NASA's advanced planning since the early 1960s. In 1962, NASA managers approved a large-weight class spacecraft called Voyager that would be designed to visit both Venus and Mars and release landers. Because of budget constraints in the mid-1960s, the Jet Propulsion Laboratory (JPL) was forced to postpone a redefined Voyager Mars 1969 mission, first to 1971 and then to 1973. In August 1967 when Congress reduced NASA's budget once again, NASA terminated all Voyager efforts. When JPL's Voyager Project Office was closed, the project was well defined and in-house and contractor teams were in place to deliver the soft-lander to Mars. To fill the gap left by the cancellation of Voyager, supporters of planetary exploration at the Langley Research Center (LaRC) and JPL suggested several more modest alternatives.

In late 1967, NASA proposed to Congress two orbiter-probe missions (Titan Mars 1973) to the Red Planet in 1973, to be followed by a more ambitious soft-lander in 1975. President Lyndon B. Johnson approved the idea early in the new year, and together Langley and JPL set to work to define their new projects, until the fall when new budget cuts forced the team to review the Mars missions once again.

NASA Administrator Thomas O. Paine and his space science advisors devised a plan for two combined orbiter-lander missions—called Viking—to replace the two projects already under way. Langley would serve as overall project leader and manager of the lander; JPL would manage the orbiter. One year later, in December 1969, Administrator Paine had to respond to demands from Congress once again. To save money in the years immediately ahead, NASA agreed to postpone the 1973 Mars missions to 1975. (See table 3-120 for a chronology.)

The Viking orbiter, built at JPL, borrowed heavily from Mariner design and technology. Martin Marietta Corporation, under contract to Langley, served as prime contractor for the Viking lander (see fig. 3-8). The two spacecraft were heavily equipped with television cameras and scientific equipment that would allow investigators to examine first-hand the surface of Mars and to search for life forms. Ten separate science teams worked with the designers and engineers at the two NASA centers; the teams included active biology, lander imagery, molecular analysis, entry science, meteorology, radio science, seismology, physical properties, magnetic properties, and inorganic chemistry.

Launched by Titan-Centaur vehicles in the late summer of 1975, *Viking 1* and 2 reached Mars in June and August 1976. The orbiters' high-resolution cameras found a younger, more dynamic planet than earlier Mariners has revealed, and the landing site certification team was forced to look for new safer sites for the two Viking landers. *Viking 1* touched down on the Chryse Plains on July 20, 1976; *Viking 2* landed on the Utopia Plains on September 3. The two landers immediately began sending a wealth of imagery and scientific data from the surface (see fig. 3-9), but they did not answer definitively the question of the existence of life on Mars. Biology experiments provided information on the chemical makeup of the samples taken and sensors gave scientists a look at the Martian environment, but the investigations were inconclusive. Scientists could not say that life did not or did exist at the end of the primary mission in November. The orbiters confirmed the presence

of water ice on the poles, and lander sensors detected argon and nitrogen in the atmosphere. Instruments sent back a steady stream of weather information, and meteorologists were able to study Martian weather systems through several seasons. NASA conducted an extended Viking mission through April 1978 and continued to monitor signals from the second lander until it was shut down in April 1980. Lander 1 was still active.

At NASA Headquarters, Walter Jakobowski was Viking program manager in the Office of Space Science. James S. Martin directed Viking as project manager at the Langley Research Center. At JPL, Henry W. Norris served as Viking orbiter manager. The Kennedy Space Center provided launch support; the Deep Space Network, managed by JPL, made communications with the Martian spacecraft possible.<sup>13</sup>

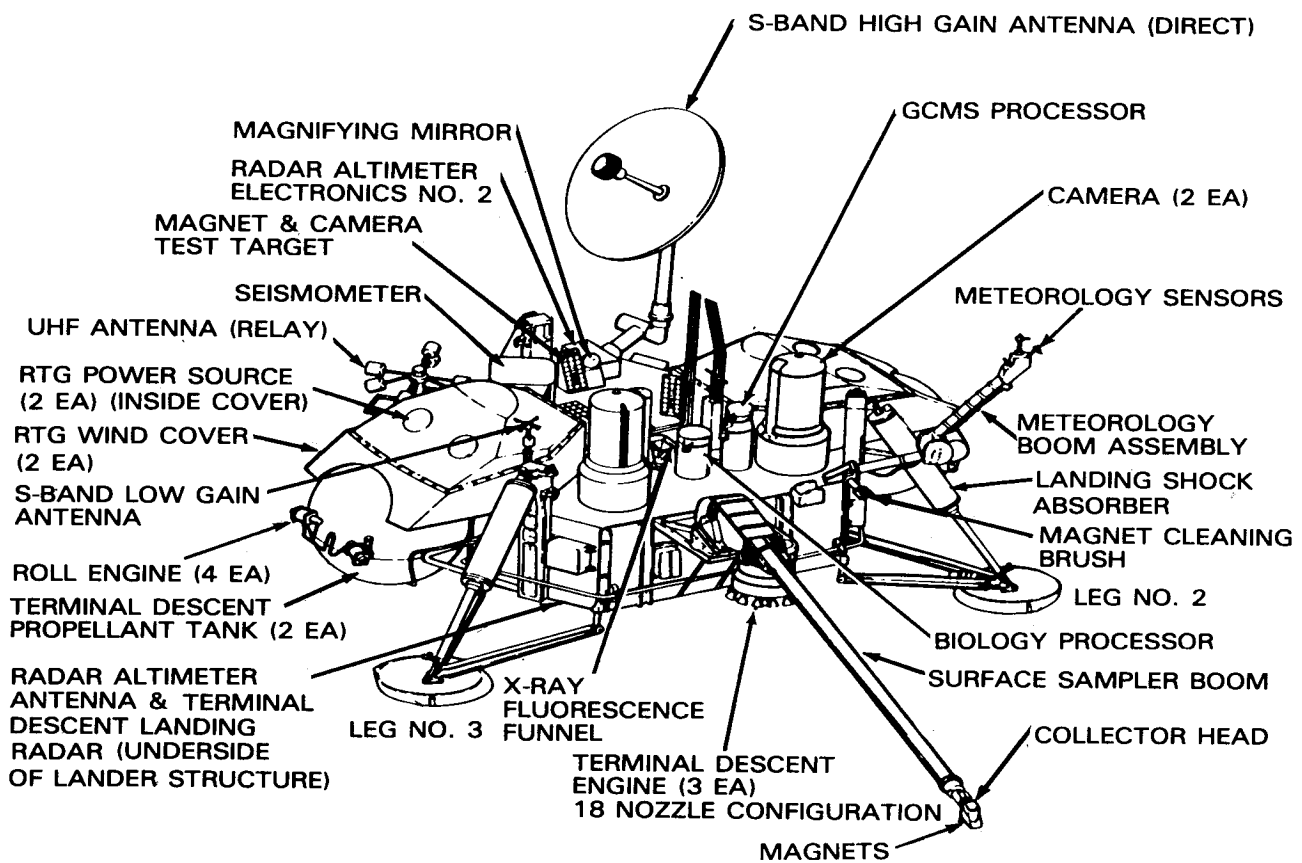
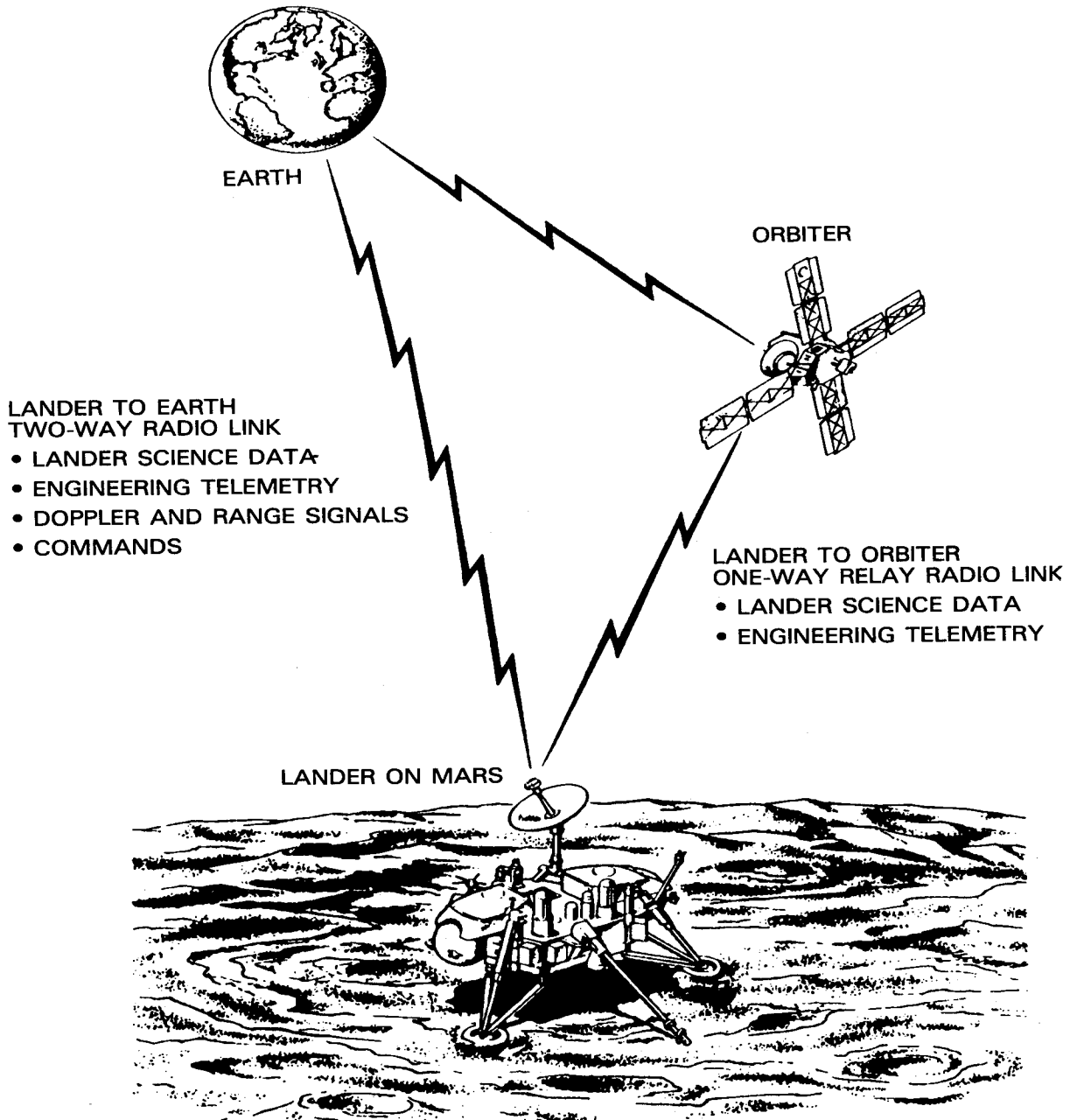

Figure 3-8. Viking Lander



*Figure 3-9. Viking Orbiter and Lander During Mission Operations*

Table 3-120. Chronology of Viking Development and Operations

Date	Event
Aug. 29, 1967	NASA Hq. cancelled the proposed Voyager unmanned Mars landing mission because of budget cutbacks by Congress.
Sept. 6, 1967	NASA's Langley Research Center's (LaRC) Planetary Missions Technology Steering Committee held a planning meeting to determine a follow-on proposal to Voyager.
Oct. 9, 1967	Office of Space Science and Applications officials outlined for Administrator James E. Webb five options for planetary exploration in the 1970s.
Nov. 1967	NASA proposed to Congress an alternative to Voyager: two orbiter-soft probe missions to Mars in 1973 and a more ambitious soft-lander mission in 1975. NASA Hq. assigned the former, called Titan Mars 1973 Orbiter and Lander, to LaRC.
Jan. 29, 1968	President Lyndon B. Johnson included approval of the 1973 orbiter-lander Mars mission in his budget address to Congress.
Feb. 9, 1968	OSSA directed LaRC and the Jet Propulsion Laboratory (JPL) to conduct baseline mission studies for the 1973 project. JPL would share in the mission by managing the development of the orbiter; LaRC would have overall management authority and responsibility for the lander.
Winter-Fall 1968	General Electric, McDonnell Douglas, and Martin Marietta conducted mission mode studies for NASA.
May 1968	In response to further budget cuts by Congress, NASA pared down its plans for the 1973 Mars missions.
Aug. 1968	JPL established a Titan-Mars orbiter design team.
Sept. 1968	Gerald Soffen became project scientist.
Sept. 28, 1968	NASA issued a request for solicitation for participation in the development of scientific investigations for the lander.
Oct. 28- Nov. 14, 1968	LaRC, JPL, and NASA Hq. personnel held a series of meetings at LaRC to define alternative Mars missions for 1973. The group chose a soft-lander mission with extended life and a flyby support module and labeled the proposal Viking.
Nov. 1968- Feb. 1969	JPL produced a baseline orbiter conceptual design.
Dec. 4, 1968	NASA Administrator Thomas O. Paine approved a more ambitious scheme for an orbiter-lander Viking. The 1973 mission would be launched by a Titan IIID-Centaur.
Dec. 6, 1968	LaRC established an interim Viking Project Office, with James S. Martin, Jr., as project manager.
Feb. 8, 1969	Paine signed the project approval document.
Feb. 11, 1969	NASA invited 38 scientists to participate in the planning for lander experiments.
Feb. 25, 1969	NASA announced the members of the eight Viking science teams.
Feb. 28, 1969	NASA issued a request for proposals (RFP) for the Viking lander. Boeing, McDonnell Douglas, and Martin Marietta responded.
Apr. 17, 1969	JPL established a Viking Orbiter Office, to be managed by Henry W. Norris.
May 29, 1969	NASA chose Martin Marietta Corp. as the prime contractor for the lander.
July 15, 1969	NASA Hq. managers issued an invitation to scientists to work on one of the orbiter or lander science teams or propose alternatives of proposals or additional experiments. NASA received 150 proposals by Oct. 20.
Aug. 11, 1969	The Viking team released an updated project definition document.
Dec. 31, 1969	Administrator Paine determined that the 1973 Viking missions would have to be delayed until 1975 to respond to a budget cut by Congress.
Oct. 19-20, 1971	The Viking team held the orbiter preliminary design review.
Jan.-July 1973	JPL held critical design reviews of the orbiter subsystems.
Apr. 3, 1973	The Viking site selection team made the final decision on landing sites for the two landers.
July 9-10, 1973	NASA conducted the orbiter critical design review.
Jan. 1974	JPL began conducting tests with the proof-test orbiter.

Table 3-120. Chronology of Viking Development and Operations (Continued)

Date	Event
Sept. 27, 1974	Because of budget cuts, JPL could not continue its testing of a third orbiter. The team redesignated the proof-test orbiter Viking Orbiter 1 and put the third craft in storage. NASA also cancelled the third lander.
Jan. 4, 1975	Martin Marietta delivered the first lander to the Kennedy Space Center, and verification test teams began their work.
Jan. 31, 1975	JPL completed orbiter qualification tests.
Feb. 11, 1975	JPL delivered the first orbiter flight hardware to KSC, where verification tests were begun.
Mar. 8, 1975	NASA engineers mated a Viking lander and orbiter for the first time. They enclosed the pair in the Centaur launch shroud on the 27th.
June 1975	Technicians sterilized the two landers.
Aug. 11, 1975	KSC officials were forced to cancel the countdown for the first Viking mission because of a corroded thrust-vector-control valve. After the postponement, technicians discovered that the orbiter's batteries had been discharged and had to be replaced. The entire spacecraft was removed from the stack, and the second spacecraft was prepared for launch.
Aug. 20, 1975	NASA successfully launched <i>Viking 1</i> .
Sept. 9, 1975	<i>Viking 2</i> joined the first Mars-bound spacecraft after a successful launch.
Dec. 1975- June 1976	Viking teams simulated lander and orbiter operations in preparation for actual mission events.
June 21, 1976	<i>Viking 1</i> was inserted into its precise orbit of Mars. The first pictures returned by the orbiter indicated that the landing sites chosen for the spacecraft would have to be rejected.
June 27, 1976	Viking managers decided to postpone the July 4 landing while they looked for safer sites.
July 20, 1976	<i>Viking 1</i> landed safely on Mars.
Aug. 7, 1976	<i>Viking 2</i> began its Martian orbits, and the site certification team continued its search for a second landing site.
Sept. 3, 1976	<i>Viking 2</i> touched down on the Martian surface.
Nov. 15, 1976	NASA terminated the Viking primary mission.
Dec. 1976	Spacecraft controllers reactivated the landers and began an extended mission.
Apr. 1, 1978	NASA terminated the Viking extended mission.
July 25, 1978	Orbiter 2 ceased functioning.
Apr. 12, 1980	NASA shut down Lander 2.
Aug. 7, 1980	Controllers silenced Orbiter 1, but Lander 1 continued to send signals to earth.

Table 3-121. *Viking 1* Characteristics

---

Date of launch (location):	Aug. 20, 1975 (ETR)
Launch vehicle:	Titan IIIE-Centaur
Weight (kg):	
Orbiter:	2320
Lander:	1190 at launch 600 at landing
Shape:	Orbiter—octagonal ring with four solar panels Lander—six sided with three landing legs
Dimensions (m):	
Orbiter:	9.70 diameter with panels extended 3.29 height
Lander:	3.02 diameter at widest point 2.13 height
Power source:	
Orbiter:	solar panels and 2 NiCd batteries
Lander:	4 NiCd batteries and 2 RTGs
Date of landing:	July 20, 1976
Responsible NASA center:	Langley Research Center, overall management and lander Jet Propulsion Center, orbiter
Project manager:	James S. Martin
Objectives:	To make observations of Mars from orbit and direct measurements in the atmosphere and on the surface with emphasis on biological, chemical, and environmental data relevant to the existence of life on the planet. NASA had originally scheduled mission A for an equatorial region and mission B for the mid latitudes.
Science teams:	Active biology Lander imagery Molecular analysis Entry science Meterology Radio science Seismology Physical properties Magnetic properties Inorganic chemistry
Results:	Successful; landing was delayed from July 4 to July 20, 1976, while specialists sought safe and scientifically interesting landing sites. Viking provided no definitive answers to the exobiologists' questions about the existence of life on Mars. NASA completed the primary mission on Nov. 15, 1976, but conducted an extended mission through Aug. 7, 1980, to obtain data on seasonal variations and long-duration sampling.
Reference:	Edward C. and Linda Neuman Ezell, <i>On Mars; Exploration of the Red Planet, 1958-1978</i> , NASA SP-4212 (Washington, 1984).

---



Table 3-122. *Viking 2* Characteristics

---

Date of launch (location):	Sept. 9, 1975 (ETR)
Launch vehicle:	Same as for <i>Viking 1</i>
Weight (kg):	Same as for <i>Viking 1</i>
Shape:	Same as for <i>Viking 1</i>
Dimensions (m):	Same as for <i>Viking 1</i>
Power source:	Same as for <i>Viking 1</i>
Date of landing:	Sept. 3, 1976
Responsible NASA center:	Same as for <i>Viking 1</i>
Project manager:	Same as for <i>Viking 1</i>
Objectives:	Same as for <i>Viking 1</i>
Science teams:	Same as for <i>Viking 1</i>
Results:	Successful; same as for <i>Viking 1</i>

---

Reference: Same as for *Viking 1*.

## Pioneer

During NASA's early years the agency was responsible for two separate Pioneer programs: a lunar probe series inherited from the Army and Air Force, and a planetary probe program initiated in 1960. Military teams launched the first four Pioneers (1958-1959), none of which met its mission objectives of lunar reconnaissance. Carrying an experiment package built by the Goddard Space Flight Center, *Pioneer 5*, launched into orbit around the sun between earth and Venus in 1960, provided investigators with excellent data on interplanetary space. Four more Pioneers of a new design followed (1965-1968), all successfully probing the environment beyond earth. NASA's Ames Research Center at Moffett Field, California, managed this new-generation interplanetary explorer, and TRW served as spacecraft fabricator.

Ames Research Center continued its management of a third-generation interplanetary Pioneer during the 1970s. Pioneer-Jupiter and Pioneer-Saturn would explore these two large planets and then continue their journey outside the solar system. An Atlas-Centaur launched the 258-kilogram TRW-made *Pioneer 10* in early 1972 (see fig. 3-10). Charged with 13 experiments designed to capture data on Jupiter and beyond, the spacecraft performed very well. It traveled through the asteroid belt in 1972-1973 unharmed and encountered Jupiter in December 1973. Of special interest to experimenters were the intense magnetic fields surrounding Jupiter and their associated radiation belts, observations of the temperature and structure of the atmosphere, and the color images returned of the planet (see table 3-123). *Pioneer 10* became the first spacecraft to pass beyond the known planets in June 1983.

*Pioneer 11*, of the same design as *Pioneer 10*, began its voyage toward Jupiter in 1973. Fourteen experiment teams would investigate the interplanetary medium beyond the orbit of Mars, the asteroid belt, and near Jupiter and Saturn. The spacecraft reached the vicinity of Jupiter in 1974 and Saturn in 1979 (see table 3-124).

*Pioneer 10* and *11* carried a pictorial plaque designed to inform any scientifically

educated beings they might encounter about the planet and people who launched them (see fig. 3-11). The radiating lines on the left side of the diagram represent the position of 14 pulsars, cosmic sources of radio energy, arranged to indicate our sun as the home star of the launching civilization. The man's hand is raised in a gesture of goodwill.

In 1978, NASA launched two Pioneer probes to Venus. *Pioneer Venus 1* went into orbit around Venus in late 1978 and completed its primary mission in August

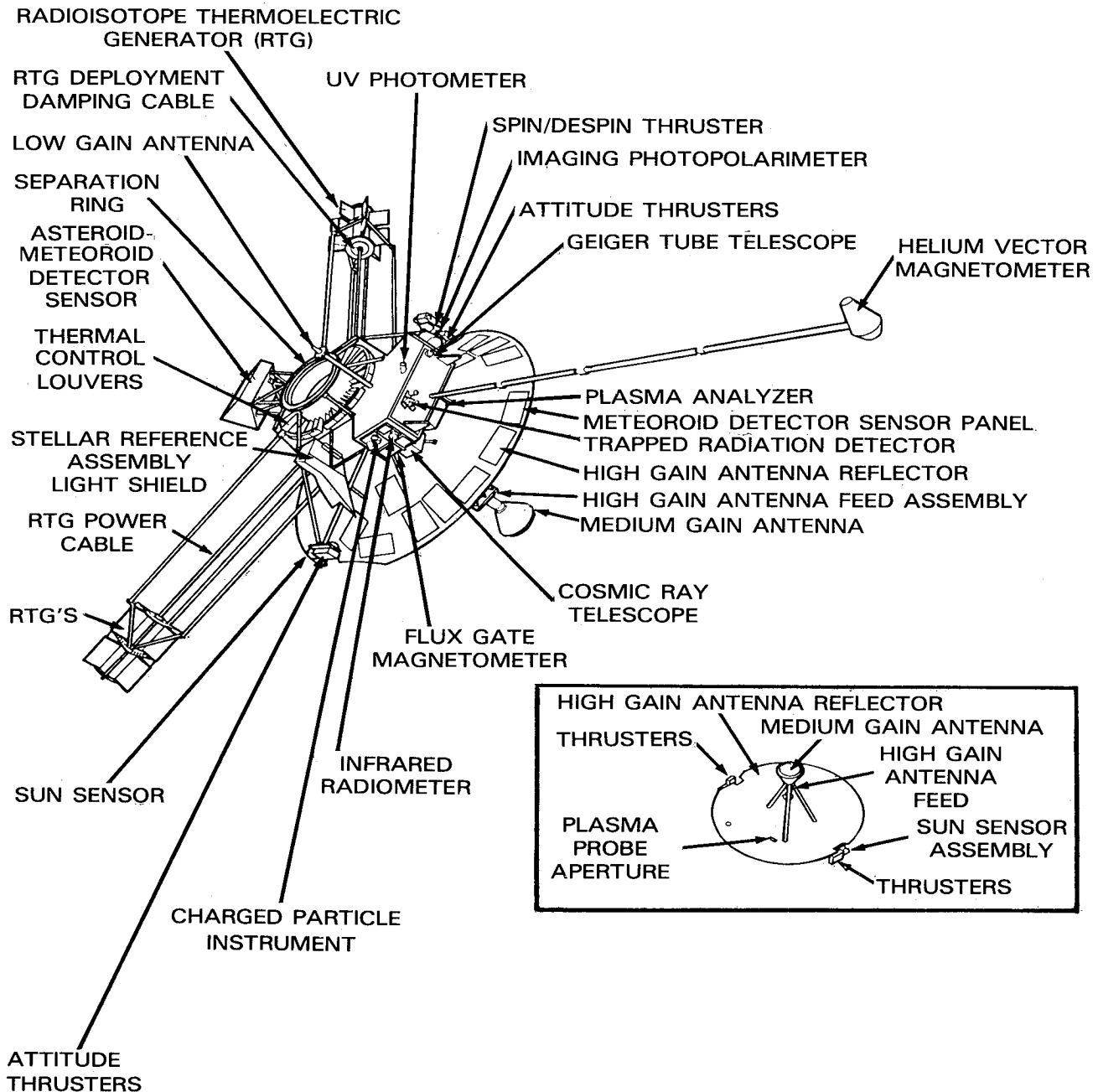

Figure 3-10. Pioneer 10/11 Spacecraft

1979. The 582-kilogram spacecraft carried 17 experiments that measured and analyzed the planet's atmosphere and gravitational field (see table 3-125). *Pioneer Venus 2* was a unique spacecraft. Weighing 904 kilograms, it consisted of an overall bus with one large (316-kilogram) and three small (90-kilogram) probes. The vehicle released its scientific payload of hard-landers in November 1978 (see table 3-126). Highly instrumented, the probes were all designated for separate landing zones so that investigators could take in situ readings from several areas of the planet during a single mission. Of primary interest was the nature and composition of the Venusian clouds and the structure of the atmosphere. The large probe survived for more than an hour after impact. Ames Research Center also directed the Pioneer Venus program for NASA.<sup>14</sup>

At NASA Headquarters, Fred D. Kochendorfer served as program manager for Pioneer and Albert G. Opp was program scientist. Charles F. Hall, project manager, directed the *Pioneer 10* and *11* operations at Ames Research Center, where John H. Wolfe was project scientist. Hall continued his role as manager for the Pioneer Venus missions, assisted by L. Colin, project scientist. Launches took place at the Kennedy Space Center. The Jet Propulsion Laboratory operated the Deep Space Network.

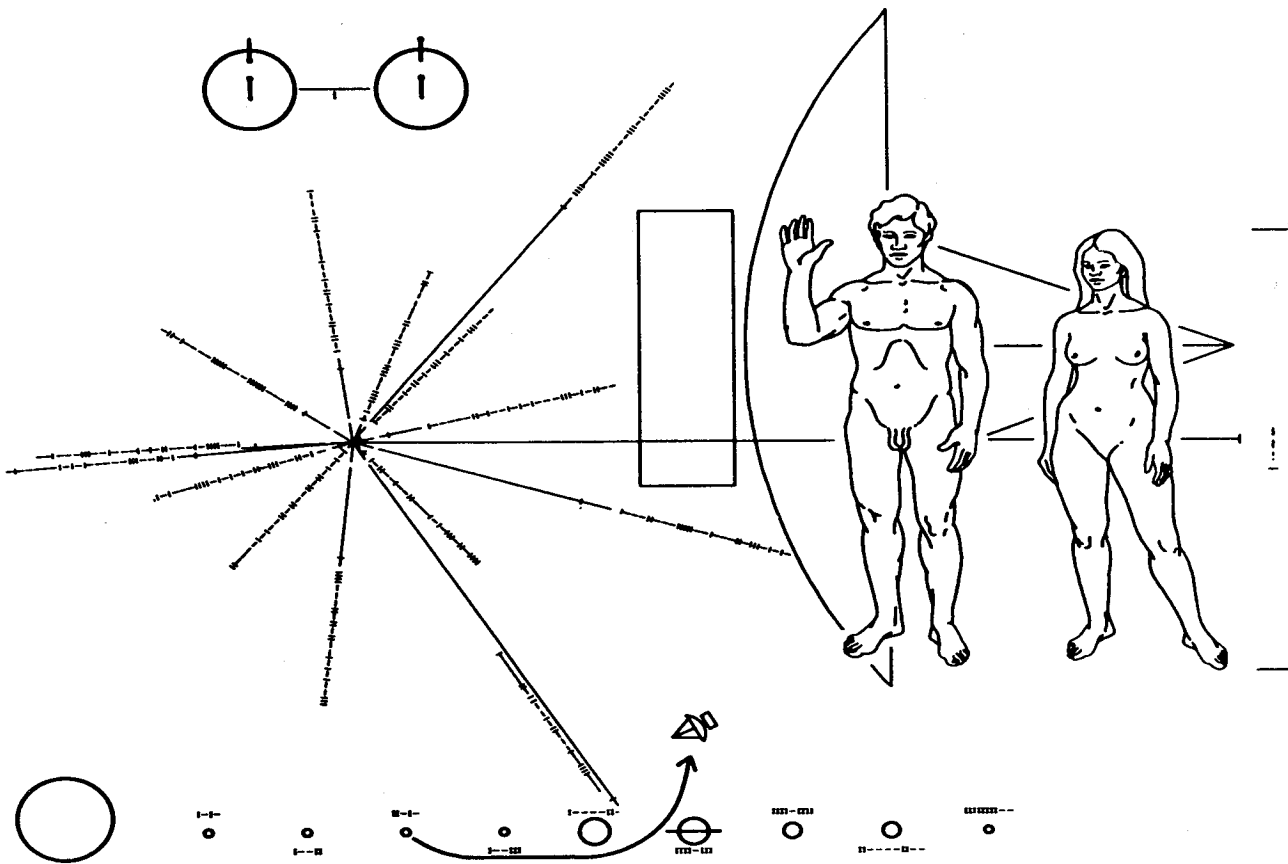

Figure 3-11. Plaque carried on Pioneer 10 and 11 designed to demonstrate to scientifically educated inhabitants of some other star system when Pioneer was launched, from where, and by what kind of beings. Design is engraved into a gold-anodized aluminum plate, 152 × 229 mm, attached to spacecraft's antenna support struts.

Table 3-123. Pioneer 10 Characteristics

---

Also called: Pioneer/Jupiter

Date of launch (location): March 2, 1972 (ETR)

Launch vehicle: Atlas-Centaur

Weight (kg): 258

Shape: hexagonal with a dish antenna

Dimensions (m): 2.9 height

2.7 diameter at widest point

Power source: AgCd battery and 4 RTGs

Responsible NASA center: Ames Research Center

Prime contractor: TRW Systems Group, Inc.

Project manager: Charles F. Hall

Project scientist: John H. Wolfe

Objectives: To study interplanetary characteristics (asteroid/meteoroid flux and velocities, solar plasma, magnetic fields, cosmic rays) beyond 2 AU; determine characteristics of Jupiter (magnetic fields, atmosphere, radiation balance, temperature distribution, photopolarization).

Experiments (responsible institution):

Magnetic fields (JPL)

Plasma (ARC)

Charged particle composition (University of Chicago)

Cosmic ray energy spectra (GSFC)

Jovian trapped radiation (University of California San Diego)

Jovian charged particles (University of Iowa)

Ultraviolet photometry (University of Southern California)

Imagery photopolarimetry (University of Arizona and Dudley Observatory)

Jovian infrared thermal structure (California Institute of Technology)

Asteroid/meteoroid astronomy (General Electric Co.)

Meteoroid detection (LARC)

S-band occultation (JPL)

Celestial mechanics (JPL)

Results: Highly successful; returned huge amounts of scientific data and closeup photos of the distant planets. Crossed the orbit of Mars May 1972, traveled through the asteroid belt, July 1972-February 1973; sent first images of Jupiter November 1973; encountered Jupiter December 3, 1973 (closest approach 130 000 km; took 641 days to travel 826 million km); crossed Saturn's orbit February 1976; crossed the orbit of Uranus July 1979; crossed Neptune's orbit May 1983; left solar system June 13, 1983, heading for the star Aldebaran of the constellation Taurus.

---

Reference: NASA, "Pioneer 10 Mission Report," S-811-72-06, Feb. 23, 1972.

Table 3-124. Pioneer 11 Characteristics

---

Also called:	Pioneer/Saturn
Date of launch (location):	April 5, 1973 (ETR)
Launch vehicle:	Atlas-Centaur
Weight (kg):	270
Shape:	Same as Pioneer 10.
Dimensions (m):	Same as Pioneer 10.
Power source:	Same as Pioneer 10.
Responsible NASA center:	Same as Pioneer 10.
Prime contractor:	Same as Pioneer 10.
Project manager:	Same as Pioneer 10.
Project scientist:	Same as Pioneer 10.
Objectives:	Same as Pioneer 10; plus travel to Saturn, making detailed observations of that planet and its rings.
Experiments (responsible institution):	
	Magnetometer (JPL)
	Fluxgate magnetometer (GSFC)
	Plasma analyzer (ARC)
	Charged particle composition instrument (University of Chicago)
	Cosmic ray telescope (GSFC)
	Geiger tube telescopes (University of Iowa)
	Trapped radiation detector (University of California, San Diego)
	Asteroid/meteoroid detector (General Electric Co.)
	Meteoroid detector (LRC)
	Celestial mechanics (JPL)
	Ultraviolet photometer (University of Southern California)
	Imaging photopolarimeter (University of Arizona)
	Occultation (JPL)
Results:	Highly successful; reached Jupiter (closest approach 43 000 km) December 2, 1974, and Saturn (closest approach 21 400 km) September 1, 1979; major new discoveries regarding Saturn include its 11th moon, magnetic field, and 2 new rings.

---

Source: NASA, "Pioneer G Press Kit," Apr. 1, 1973.

Table 3-125. Pioneer Venus 1 Characteristics

---

Date of launch (location):	May 20, 1978 (ETR)
Launch vehicle:	Atlas-Centaur
Weight (kg):	582
Shape:	Cylindrical with top-mounted dish antenna on a 3-meter mast
Dimensions (m):	2.5 diameter 1.2 height (4.5 including antenna mast)
Power source:	Solar array and 2 NiCd batteries
Responsible NASA center:	Ames Research Center
Project manager:	Charles F. Hall
Project scientist:	L. Colin
Objectives:	With Pioneer Venus 2, to conduct a comprehensive investigation of the atmosphere of Venus. Pioneer Venus 1 would determine the composition of the upper atmosphere and ionosphere, observe the interaction of the solar wind with the ionosphere, and measure the planet's gravitational field.
Experiments (responsible institution):	<ul style="list-style-type: none"> <li>Charged particle retarding potential analyzer (LMSC)</li> <li>Charged particle mass spectrometer (GSFC)</li> <li>Thermal electron temperature Langmuir probe (GSFC)</li> <li>Neutral particle mass spectrometer (GSFC)</li> <li>Cloud photopolarimeter/imaging system (GISS)</li> <li>Temperature sounding infrared radiometer (JPL)</li> <li>Magnetic field fluxgate magnetometer (University of California, Los Angeles)</li> <li>Solar wind plasma analyzer (ARC)</li> <li>Surface radar mapping (Massachusetts Institute of Technology)</li> <li>Electric field (TRW, Inc.)</li> <li>Transient gamma ray burst (LASL)</li> <li>Gas and plasma environment (Stanford Research Institute)</li> <li>Radio occultation (JPL)</li> <li>Atmospheric and solar corona turbulence (JPL)</li> <li>Drag measurements (LRC)</li> <li>Internal density distribution (JPL)</li> <li>Celestial mechanics (MIT)</li> </ul>
Results:	Successful; went in orbit around Venus on December 4, 1978; completed primary mission August 4, 1979; completed first phase of the extended mission July 22, 1980; second phase in progress (1982).
Reference:	NASA, "Pioneer Venus Press Kit," May 9, 1978; NASA "Pioneer Venus 1 Mission Operation Report," S-825-78-01, May 15, 1978; and NASA "Pioneer Venus 2 Mission Operation Report," S-825-78-01/02, Dec. 8, 1982.

---

Table 3-126. Pioneer Venus 2 Characteristics

---

Date of launch (location):	Aug. 8, 1978 (ETR)
Launch vehicle:	Atlas-Centaur
Weight (kg):	904, total bus 316, large probe (1) 90, small probe (3)
Shape:	Cylindrical, overall bus, with conical probes
Dimensions (m):	2.5 diameter, bus 2.9 height, bus 1.5 diameter, large probe 0.8 diameter, small probes
Power source:	AgZn batteries
Responsible NASA center:	Ames Research Center
Project manager:	Charles F. Hall
Project scientist:	L. Colin
Objectives:	With Pioneer Venus 1, to conduct investigations of Venus with hard-impact probes; one large probe, three small probes, and the spacecraft bus take in situ measurements of the atmosphere on their way to the surface to determine nature and composition of clouds, composition and structure of atmosphere, and general circulation patterns of atmosphere.
Experiments (responsible institution):	<p><i>Large Probe Only</i></p> <p>Neutral mass spectrometer (University of Texas, Dallas) Gas chromatograph (ARC) Solar flux radiometer (University of Arizona) Infrared radiometer (ARC) Cloud particle size spectrometer (Particle Measuring Systems, Inc.)</p> <p><i>Large and Small Probes</i></p> <p>Atmospheric structure (ARC) Cloud particles (ARC and University of Paris)</p> <p><i>Small Probe Only</i></p> <p>Net flux radiometer (University of Wisconsin)</p> <p><i>Spacecraft Bus</i></p> <p>Neutral mass spectrometer (University of Bonn) Ion mass spectrometer (GSFC) Differential long baseline interferometry (Massachusetts Institute of Technology) Atmospheric propagation (Stanford Research Institute) Atmospheric turbulence (JPL)</p>
Results:	Successful return of scientific data on Venus; four probes released as planned in November 1978; 22 minutes of data received prior to impact; large probe impacted day-side equatorial latitudes; first small probe impacted day-side mid-southern latitudes; second small probe impacted night-side mid-southern latitudes; third small probe impacted night-side high-northern latitudes. Mission concluded on December 9, 1978.

---

Reference: NASA, "Pioneer Venus Press Kit," May 9, 1978.

## Voyager

In the late 1960s, "Voyager" was the name given a large lander unsuccessfully proposed by NASA for a visit to Mars. In 1977, the agency revived the name for its Mariner-class Jupiter-Saturn project. This two-spacecraft project, in part, replaced the "Grand Tour" missions proposed by NASA, in which four spacecraft would have visited the five outer planets during the late 1970s. Two probes would have journeyed to Jupiter, Saturn, and Pluto in 1977, and two others would have made their way to Jupiter, Uranus, and Neptune in 1979. NASA cancelled the tour in early 1972 in response to restrictive budgets. Voyager, proposed later that year, would take advantage of the rare alignment of Jupiter and Saturn in 1977.

The Jet Propulsion Laboratory oversaw Voyager and, as it had with earlier Mariner projects, assembled the two probes on-site in Pasadena, California. Jupiter and Saturn were again the investigators' targets, but Voyager would carry more instrumentation than the earlier Pioneers and provide a more detailed examination of the two planets.

*Voyager 1* and *2* were launched in September and August 1977, respectively, by Titan-Centaurs. Even though it was launched second, *Voyager 1* led the way for much of the journey because it was put into a faster, shorter trajectory. The two 822-kilogram spacecraft mission modules were equipped with slow-scan color television for receipt of the first live television images of Jupiter and Saturn, in addition to magnetometers, photopolarimeters, radio astronomy receivers, plasma wave instruments and plasma detectors, ultraviolet spectrometers, and other instruments. Spacecraft designers changed the Mariner design to accommodate the many scientific instruments and imaging equipment, a large antenna, and radioisotope thermoelectric generators (see fig 3-12 and tables 3-127 and -128).

The Voyagers reached Jupiter in January and July 1979 and returned images that excited scientists and the general public alike. (*Voyager 1* sent 18 000 images over 98 days, its closest approach being 348 890 kilometers.) They saw the four moons of Jupiter in great detail, active volcanoes on Io, and a ring around the planet similar to the rings of Saturn and Uranus. *Voyager 2* recorded 13 000 images of the planet and its satellites. Using the gravity of Jupiter, the Voyagers continued their travels, arriving at Saturn in November 1980 and August 1981. Many of Saturn's secrets likewise were revealed under Voyagers' cameras and instruments. Voyager discovered three new moons and confirmed the existence of others. It was found that the rings of Saturn can be numbered in the hundreds, rather than the few that had been observed before Voyager. In late 1980, *Voyager 1* was on a course that would take it out of the solar system; *Voyager 2*, deflected by the gravity of Saturn, began heading for Uranus, with an estimated time of arrival of early 1986.<sup>15</sup>

Rodney A. Mills was Voyager program manager at NASA Headquarters. At the Jet Propulsion Laboratory, John R. Casani and James E. Long served as project manager and project scientist. Kennedy Space Center was the launch site. JPL's Deep Space Network provided mission support.



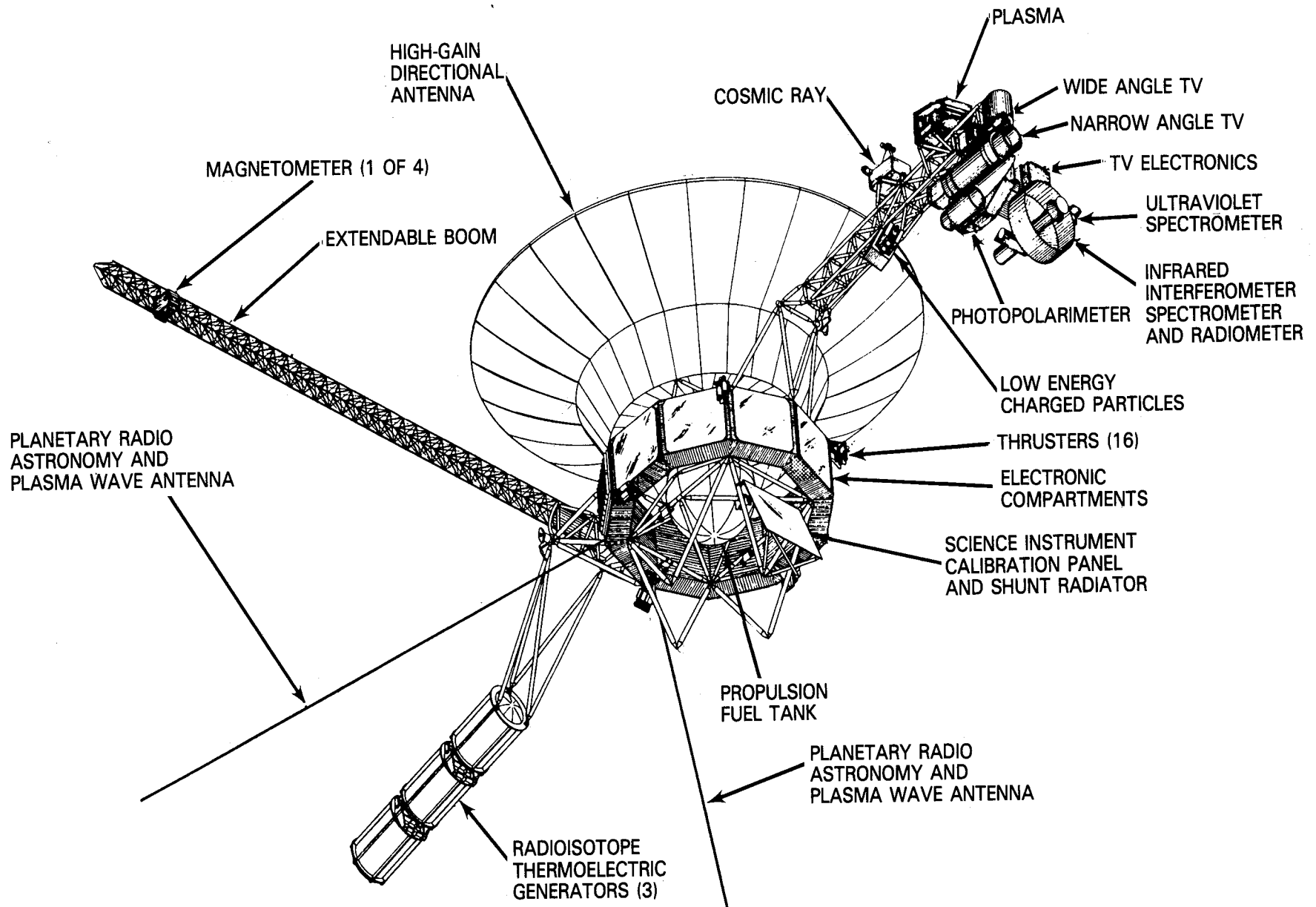

Figure 3-12. Voyager Spacecraft

Source: JPL, "Voyager Jupiter-Saturn Fact Sheet," Dec. 1976, p. 7.

Table 3-127. *Voyager 1* Characteristics

---

Also called: Voyager Jupiter-Saturn  
 Date of launch (location): Sept. 5, 1977 (ETR)  
 Launch vehicle: Titan-Centaur  
 Weight (kg): 822, mission module  
                   1211, propulsion module  
                   47, spacecraft adapter  
                   2080, total  
 Shape: 10-sided main structure, with a 3.66-m diameter parabolic reflector supporter above the spacecraft body  
 Dimensions (m): 4.70 height  
                   1.78 from flat to flat  
                   2.30 science boom  
 Power source: 3 RTGs  
 Responsible NASA center: JPL  
 Project manager: John R. Casani  
 Science Manager: James E. Long  
 Objectives: To conduct comparative studies of the Jupiter and Saturn planetary systems, including their satellites and Saturn's rings; study the interplanetary medium between earth and Saturn.  
 Experiments (responsible institution):  
   Imaging science (University of Arizona)  
   Infrared spectroscopy interferometer and radiometry (GSFC)  
   Ultraviolet spectroscopy (Kitt Peak National Observatory)  
   Photopolarimetry (University of Colorado)  
   Plasma (Massachusetts Institute of Technology)  
   Low-energy charged particles (Johns Hopkins Applied Physics Laboratory)  
   Magnetic fields (GSFC)  
   Planetary radio astronomy (University of Colorado)  
   Plasma wave (TRW Space and Defense Systems)  
   Radio science (Stanford University)  
 Results: Successful; reached vicinity of Jupiter on March 5, 1979 and Saturn on November 12, 1980; returned much new information on both planets.

---

Reference: JPL, "Voyager Jupiter-Saturn Fact Sheet," Dec. 1976.

Table 3-128. *Voyager 2* Characteristics

---

Also called: Voyager Jupiter-Saturn  
 Date of launch (location): Aug. 20, 1977 (ETR)  
 Launch vehicle: Same as *Voyager 1*.  
 Weight (kg): Same as *Voyager 1*.  
 Shape: Same as *Voyager 1*.  
 Dimensions (m): Same as *Voyager 1*.  
 Power source: Same as *Voyager 1*.  
 Responsible NASA center: Same as *Voyager 1*.  
 Project manager: Same as *Voyager 1*.  
 Project scientists: Same as *Voyager 1*.  
 Objectives: Same as *Voyager 1*.  
 Experiments (responsible institution): Same as *Voyager 1*.  
 Results: Successful; reached Jupiter on July 9, 1979 and Saturn on August 25, 1981; scheduled to reach vicinity of Uranus in January 1986 and Neptune in August 1989.

---

Reference: Same as *Voyager 1*.

## Other Lunar and Planetary Projects

During *Apollo 15* and *16*, before the crews began their return journey to earth, astronauts released lunar subsatellites. These particles and fields satellites were designed to gather data related to the moon's magnetic field, lunar gravity, and the solar wind.

The *Apollo 15* satellite, released on August 4, 1971, was highly successful, returning data until early 1972 (see table 3-129). Ejected into lunar orbit on April 16, 1972, the *Apollo 16* subsatellite was not as successful since it was released into an orbit closer to the moon than planned. The satellite crashed into the lunar surface in May (see table 3-130).

Table 3-129. *Apollo 15* Subsatellite Characteristics

---

Also called:	A-15 Particles and Fields Subsatellite
Date of launch (range):	July 26, 1971 (ETR)
Date of ejection:	Aug. 4, 1971
Launch vehicle:	Saturn V
Shape:	hexagonal
Weight (kg):	36
Dimensions (m):	0.79 length 0.36, diameter
Power source:	solar cells plus AgCd battery
Prime contractor:	TRW
Date of reentry:	N/A Selenocentric orbit in 1984
Responsible NASA center:	JSC
Objectives:	To gather data for one year related to the moon's magnetic field, lunar gravity, and the solar wind; ejected from <i>Apollo 15</i> command and service module scientific instrument module bay.
Experiments (responsible organization):	Particle shadows and boundary layer (Univ. of California at Berkeley) Magnetometer (Univ. of California at Los Angeles) S-band transponder (JPL)
Results:	Returned data successfully until early 1972.
Reference:	NASA Hq. Release 71-119k, "Apollo 15 Press Kit," July 15, 1971; and NASA Hq. Release, "Apollo 15 Lunar Satellite," July 4, 1971.

---

Table 3-130. *Apollo 16 Subsatellite* Characteristics

---

Date of launch (range): Apr. 16, 1972  
 Date of ejection: Apr. 24, 1972  
 Launch vehicle: Saturn V  
 Shape: hexagonal  
 Weight (kg): 42  
 Dimensions (m): 0.77, length  
                     0.36, diameter  
 Power source: solar cells plus AgCd battery  
 Prime contractor: TRW  
 Date of reentry: N/A Impacted moon May 29, 1972  
 Responsible NASA center: JSC  
 Project manager:  
 Project scientist:  
 Objectives: Same as for *Apollo 15 Subsatellite*  
 Experiments (responsible organization): same as for *Apollo 15 Subsatellite*  
 Results: Crashed into the lunar surface after 425 revolutions on May 29, 1972. The satellite was ejected into an orbit closer to the moon than planned because of problems with *Apollo 16's* command module engine.

---

Reference: NASA Hq. Release 72-64K, "Apollo 16 Press Kit," Apr. 6, 1972; and NASA Hq. Release, "Apollo 16 Subsatellite," Jan. 23, 1972.

## DESCRIPTION – LIFE SCIENCES PROGRAM

The life sciences program at NASA was always closely allied to the manned spaceflight program, sponsoring studies that evaluated the impact on man of prolonged weightlessness and exposure to the environment of space. In late 1970, the Office of Bioscience Programs officially left the Office of Space Science and Applications (OSSA) to become part of the Office of Manned Space Flight. Areas of study such as exobiology and planetary quarantine were absorbed within OSSA.<sup>16</sup>

In addition to the many experiments and observations conducted during Apollo and Skylab missions during NASA's second decade, life scientists conducted one additional flight project, the last Biosatellite mission.

### Biosatellite

NASA assigned the management of a biological satellite project to the Ames Research Center in October 1962, a time when the agency was keenly seeking data on the effects of space travel on living beings. Running two years behind schedule, the first Biosatellite, which carried 13 experiments with plants, insects, and frog eggs, failed in late 1966 when a retrorocket failure prevented the controlled return of the payload. *Biosatellite 2*, with the same payload, flew in September 1967 with satisfactory results from a three-day experiment.

Investigators wanted to observe a primate for 30 days on the third and last Biosatellite flight. A 21-day mission to precede *Biosatellite 3* had been cancelled in

late 1968. The two-part life sciences satellite was launched on June 28, 1969, with a male pigtail monkey named Bonny as a passenger. On July 7, Bonny's health started to fail; he refused to drink and his vital signs were critical: lowering temperature, reduced heart rate, shallow breathing, excessive sleepiness, and sluggishness. Controllers ordered the reentry capsule to separate from the instrument section, which it did, but inclement weather prevented the recovery team from catching the capsule midair. Air Force pilots picked up Bonny minutes after splashdown and flew him to Hickam Air Force Base in Hawaii. Despite intensive care, Bonny died the next day from causes that were not directly related to his flight.<sup>17</sup>

Thomas P. Dallow directed the Biosatellite project at NASA Headquarters. His counterpart at the Ames Research Center was Charles A. Wilson.

Table 3-131. *Biosatellite 3* Characteristics

---

Date of launch (location):	June 28, 1969 (ETR)
Launch vehicle:	Thor-Delta (DSV-3N)
Weight (kg):	696.7
Shape:	Cylindrical cone adapter and instrument section, with a blunt-cone reentry vehicle with heat-shield.
Dimensions (m):	2.44 total length
	2.06 length, adapter section
	1.45 maximum diameter, adapter section
	1.22 length, reentry vehicle
	1.02 diameter, reentry vehicle base
Power source:	AgZc batteries
Date of reentry:	July 7, 1969
Responsible NASA center:	Ames Research Center
Prime contractor:	General Electric Co.
Project manager:	Charles A. Wilson
Objectives:	To determine the effects of long-term weightlessness on a monkey during a 30-day orbital mission.
Areas of investigation:	Central nervous system
	Circulatory system
	Body chemistry
Results:	Unsuccessful; on the ninth day of flight, Bonny, the pigtail monkey, became ill, and flight controllers ordered the reentry vehicle back to earth. Bonny died shortly thereafter on July 8 at Hickman AFB, Honolulu.

---

Reference: J. W. Ayer, ed., "Biosatellite Project Historical Summary Report," ARC, Dec. 1969.

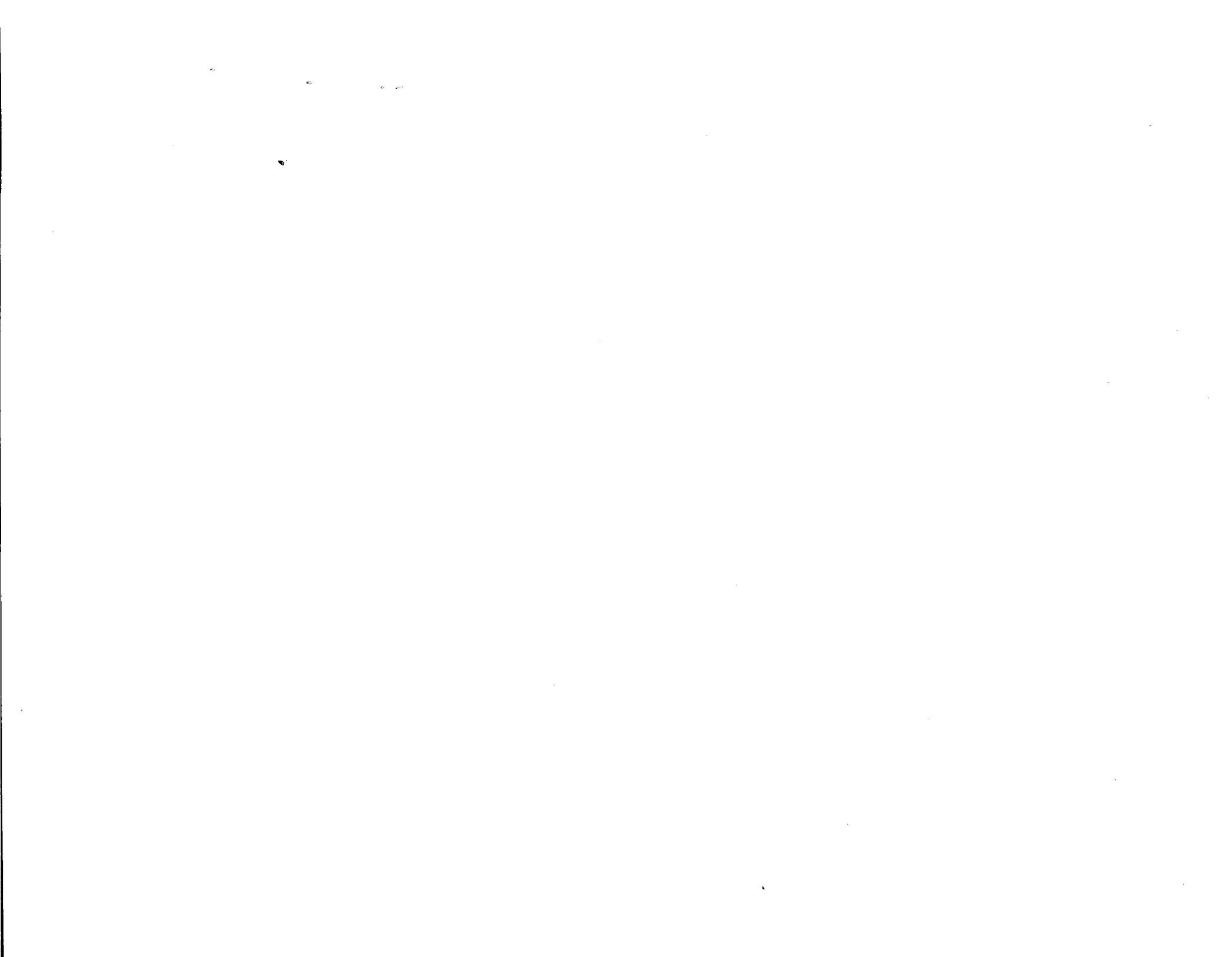

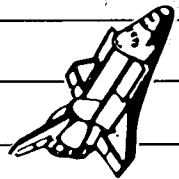

CHAPTER FOUR

---

**SPACE APPLICATIONS**

PRECEDING PAGE BLANK NOT FILMED

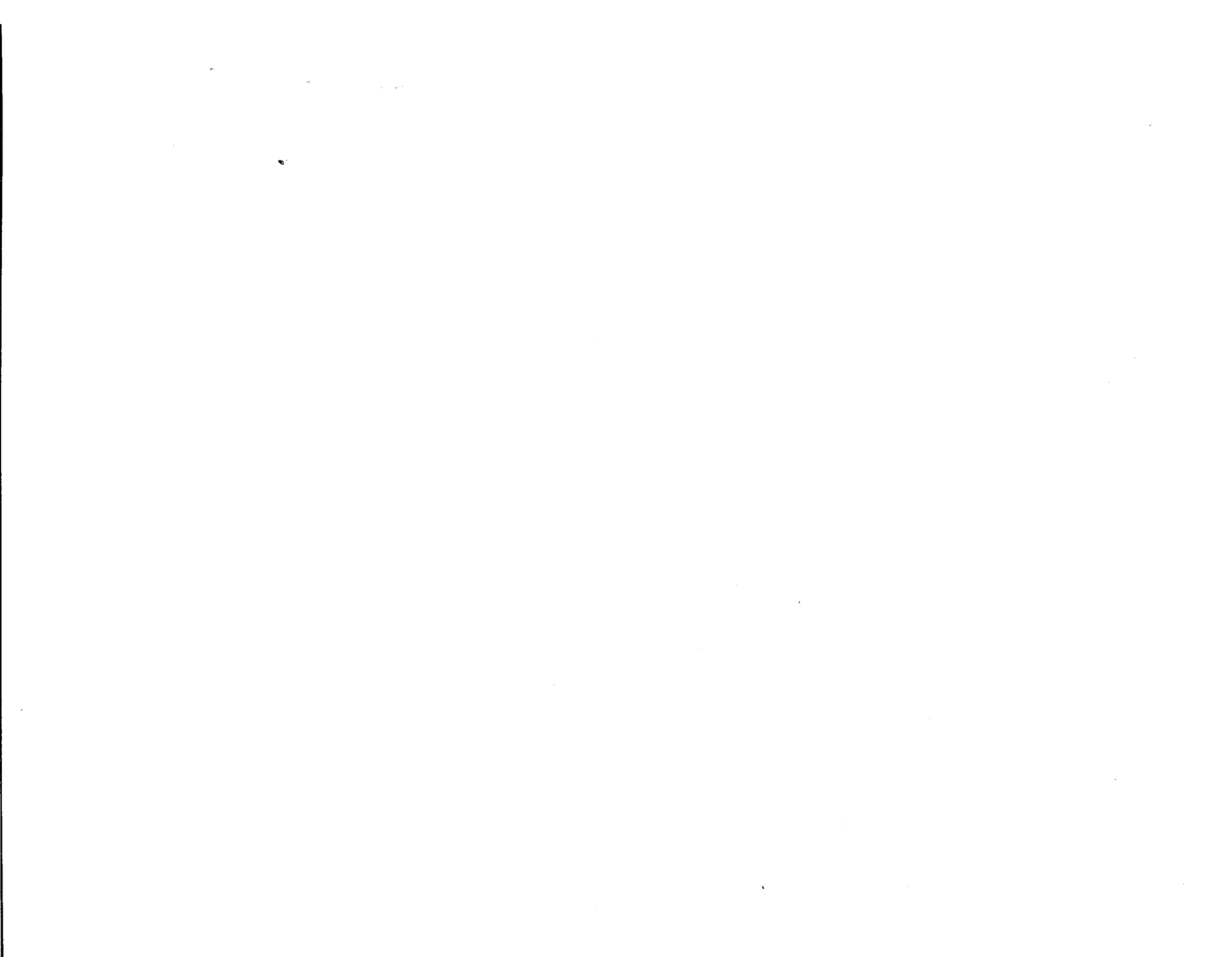



# CHAPTER FOUR

## SPACE APPLICATIONS

### INTRODUCTION

Within the National Aeronautics and Space Administration, the organizational relationship between space applications—the “practical exploitation of space to benefit mankind”—and space science has changed over the years to suit the times. During most of the civilian space agency’s first decade, the two programs were joined under one roof: the Office of Space Science and Applications (OSSA).<sup>\*</sup> Supporters of ambitious science and applications projects waited together, making do with less money, support, and public attention while their manned spaceflight counterparts accomplished the national business at hand: landing a man on the moon and returning him safely by the end of the 1960s—an ambitious, expensive goal pressed on NASA in 1961 by President John F. Kennedy. Once manned lunar operations became almost routine, the nation and NASA settled down to find less spectacular, less expensive, but more obviously beneficial uses for its new space-age tools. The management of space science and space applications during NASA’s second decade was divided in recognition of “the increasing importance of applications satellite programs in the space effort.”<sup>1</sup>

Although President Richard M. Nixon had described his plans for the space program of the 1970s as a program tempered by equal consideration for exploration, scientific knowledge, and practical applications, it soon became obvious that a budget-conscious Congress favored applications projects over “pure science” or exploration for exploration’s sake. According to Dr. John E. Naugle, Associate Administrator for Space Science and Applications (1967–1971), the U.S. had acquired during the 1960s “a basic lead in space exploration, scientific knowledge, and technology.” During the next decade, we could “apply this experience toward the study and solution of looming earthly problems.<sup>2</sup> Indeed, Nixon’s Space Task Group, in advising the president on the future of the national space program, had

**PRECEDING PAGE BLANK NOT FILMED**

---

<sup>\*</sup>From November 1961 through October 1963, space science and space applications were distinct programs; from November 1963 through November 1971 they were managed together; they were separated into two offices again in December 1971; they would be recombined in 1981.

come to that same conclusion in 1969:\* “We have found increasing interest in the exploitation of our demonstrated space expertise and technology for the direct benefit of mankind in such areas as earth resources, communications, navigation, national security, science and technology, and international participation. We have concluded that the space program for the future must include increased emphasis upon space applications.”<sup>3</sup> Two presidents and nine years later, the same policy was reiterated by the White House. President Jimmy Carter hoped the 1980s would “reflect a balanced strategy of applications, science and technology development,” but a strong applications program was first on the list. Space applications “will bring important benefits to our understanding of earth resources, climate, weather, pollution and agriculture.”<sup>4</sup> NASA’s second decade opened and closed with similar calls for action on the part of the space applications community.

### The First Decade Reviewed

Even before enthusiasm and large budgets for the space program started to wane in the face of urban social programs and an escalating military involvement in Southeast Asia, NASA managers were conscious of the need to balance basic research, which hopefully would answer fundamental questions about the nature of matter and the universe and which might have some unforeseen practical benefit, with applied research, which was knowingly geared toward some application. Two early applications projects that contributed to the common good in a demonstrative way were communications and meteorology. NASA’s satellite research led to a revolution in these two service fields.

Satellites offered a simultaneous line-of-sight connection between two points that are shielded from one another by the curvature of the earth. When equipped with receiving, amplifying, and transmitting instruments and placed in precise orbits, satellites were a promising purveyor of long-distance voice, television, and data transmissions. The results of NASA’s early passive and active communications experiments (Echo, Relay, and Syncom) were used by COMSAT, the operational arm of the International Telecommunications Satellite Organization (INTELSAT), which Congress authorized in 1962 to exploit the commercial possibilities of the communications satellite. NASA’s role in the commercial system was limited to launching the satellites (Telstars and INTELSATs) on a reimbursable basis. The agency’s primary responsibility was research and development—designing and testing improved instruments, larger satellite platforms, more sophisticated guidance and control mechanism, and increased-capacity launch vehicles.

The satellite and small sounding rockets were a great boon to meteorology. High above earth on an orbiting platform, television cameras recorded changing cloud cover patterns. Sensors carried into the upper atmosphere on small rockets returned critical data on air temperature and pressure and wind direction and speed.

---

\*Members of the Space Task Group include Spiro T. Agnew, chairman, Robert C. Seamans, Thomas O. Paine, and Lee A. Dubridge; U. Alexis Johnson, Glenn T. Seaborg, and Robert P. Mayo were observers. The group was organized by Nixon in February 1969 for the express purpose of advising him on the direction the U.S. space program should take in the post-Apollo period.

Tiros, NASA's meteorology research and development project, was highly successful. An operational system of meteorology satellites was initiated in 1966, and again NASA surrendered control. The Weather Bureau (later known as the Environmental Sciences Services Administration, or ESSA) oversaw the use of the Tiros Operational System (TOS), with NASA providing launch services. NASA continued its research and development experiments with a second-generation meteorology satellite family, Nimbus.

NASA's third major applications flight program initiated during the 1960s was the Applications Technology Satellite (ATS). This series of spacecraft was designed to carry a variety of experiments—communications, meteorology, and scientific—and to investigate new techniques for spacecraft control. The ATS program, along with other research projects in the fields of communications and navigation, meteorology, geodesy, and remote sensing, was carried over into the agency's next 10 years.

### Space Applications, 1969–1978

The “earthly problems” Naugle alluded to in 1970 were “derivatives of the continuing growth of the world's population—imposing ever-growing demands for the basics of life . . . as well as for such social needs of civilization as improved means of transportation and communications.”<sup>5</sup> Pollution and its impact on the mechanics of the environment was seen as a particularly noxious effect of expanding population and industrialization. If Congress would appropriate the funds, NASA could be particularly well armed to investigate, if not actually to combat, some of these global problems. The synoptic view of earth provided by satellites would help investigators understand, develop, and protect natural and cultural resources and monitor the state of the environment.

This serious task was added to NASA's applications program, in addition to its traditional role of support for advanced communications and meteorology research. Geodetic research was a fourth responsibility. The Office of Applications (OA) divided these areas of responsibility into four programs: weather, climate, and environmental quality; communications; earth resources survey; and earth and ocean dynamics.\*

NASA's Tiros family of meteorology satellites continued to thrive during the 1970s, although sometimes known by other names. *ESSA 9* was the last of the first-generation TOS spacecraft. *Tiros M* was a research and development satellite that paved the way for *NOAAs 1* through *5*, the improved TOS system. *Tiros N*, representing the third generation, was orbited in 1978, bringing to eight the number of Tiros satellites launched in 1969–1978. A second spacecraft design, the Synchronous Meteorology Satellite (SMS), which was capable of daytime and nighttime observations, was first tested in 1974. *SMS 1* and *2* were joined by operational satellites *GOES 1* through *3*. As it had in the 1960s, NASA shared responsibility for the National Meteorological Satellite System with ESSA (later known as the Na-

---

\*These four programs were known by several names during various reorganizations of OSSA/OA. Consult table 4-2 for more detailed information.

tional Oceanic and Atmospheric Administration, or NOAA). Besides daily weather information, NASA satellites collected data of interest to scientists studying the mechanics of storm systems and global weather and climate patterns. The agency also was assigned an official role in the international Global Atmospheric Research Program. Additionally, NASA launched three foreign meteorology satellites as part of its commitment to international cooperation. The sensors carried aloft by five Nimbus spacecraft provided specialists with vertical soundings of the atmosphere, a thermal mapping capability, and data on air pollution. This research satellite program was concluded in 1978.

During the 1970s, NASA expanded its communications satellite launching service to include foreign countries (17 launches), the amateur ham radio community (4), and the U.S. military (11). NASA launch vehicles were used 20 times for INTELSAT payloads and 10 times for other U.S. commercial ventures. Research and development activities were limited to the joint U.S.-Canadian Communications Technology Satellites (CTS) and experiments flown on ATS spacecraft. With *ATS 6*, which was equipped with a 9-meter parabolic antenna, NASA conducted a popular experimental program of educational television and medical support communications to remote, sparsely populated regions. Communications network operations was clearly a commercial affair, but the space agency continued to provide the high-risk applied research that led to improvements of operational systems and the introduction of new hardware.

The earth resources survey program was one of NASA's most publicized new programs of the post-Apollo years. Sensors that could detect and measure the electromagnetic radiation emanating from objects on earth were used to prepare images useful to specialists in the fields of agriculture, forestry, geology, hydrology, and urban planning. Landsat satellites increased man's capabilities for detecting and monitoring living and nonliving resources, acquiring information for food, fiber, and water resources management, mineral and petroleum exploration, and land use classification and assessment. NASA and the Department of Interior worked together to ensure that Landsat data were used by federal, state, and local government agencies and by private concerns.

Satellites can also be used to study the dynamics of continental land masses and the oceans. The Office of Applications sponsored three flight projects that contributed to our understanding of the motion of earth's tectonic plates and oceanographic phenomena. Increasingly accurate global maps and sea charts and earthquake prediction data were the most visible products of Seasat, Lageos, and GEOS. Moreover, these projects pointed to the need for an operational monitoring system of earth's changing surface.

### **Managing the Space Applications Program at NASA**

In October 1967, John E. Naugle, a physicist by training, became associate administrator for space science and applications at NASA Headquarters, replacing Homer E. Newell, Jr., who had led the agency's space science program from its earliest days. Naugle continued to head OSSA until it was divided into two offices in December 1971. One of his deputies, Leonard Jaffee, was responsible for space applications. During the early years of the second decade, space applications programs

were divided between two working divisions: earth observations, led by John M. DeNoyer, which included meteorology (Morris Tepper, director) and earth resources survey projects; and communications, led by Richard B. Marsten.

Charles W. Mathews became the first associate administrator for applications. Mathews, who had been a member of the National Advisory Committee for Aeronautics (NACA), one of NASA's predecessor agencies, had been responsible for the Gemini Program at the Manned Spacecraft Center and for Skylab at Headquarters before becoming deputy associate administrator for manned spaceflight. Jaffee stayed on as deputy. The working directorates were expanded to include communications; earth observations, assumed by William E. Stoney in 1973; flight programs, directed by Pitt G. Thome; and special programs, which embraced the geodetic satellite projects, among others, and was led by Francis L. Williams. This arrangement was basically static through the next two associate administrators. Bradford Johnston, a marketing expert, was appointed to the position by Administrator James Fletcher in June 1976. Anthony J. Calio, a nuclear physicist associated with NASA since the early 1960s, took the reins in October 1977.

Calio was in charge of the program when the name was changed in November 1977. Reemphasizing the program's broad objective of looking earthward from space, the agency renamed OA the Office of Space and Terrestrial Applications (OSTA). Samuel W. Keller became Calio's deputy in May 1978, joining Chief Scientist S. Ichtiaque and Chief Engineer William P. Raney. Program activities were divided among three areas: environmental observations, directed by Lawrence R. Greenwood; resource observations, under Thome; and communications, led by Donald K. Dement. In addition, there were directors for materials processing, an interest of OA's since April 1977 (John R. Carruthers, director), applications system, and technology transfer.\*

Flight project activity was managed on two levels, from Headquarters and from the NASA center to which it was assigned. The Headquarters directors and the center managers divided many tasks. In Washington, projects were explained, budgeted, and defended in-house, before Congress and the Office of Management and Budget. At the field centers, designs were generated and concepts proved, contracts let and monitored, spacecraft and experiment hardware tested, and finally results analyzed. OSSA/OA/OSTA worked with all NASA's field centers to bring to fruition its many flight projects, but it depended primarily on the Goddard Space Flight Center (GSFC) in Maryland. Meteorology and the bulk of the communications projects, as well as ATS and Landsat were assigned to GSFC. The Johnson Space Center (JSC, formerly the Manned Spacecraft Center) managed the aircraft earth resources survey program, with the assistance of Ames Research Center. Lageos was shared by the Marshall Space Flight Center and GSFC. Wallops Flight Center managed GEOS and was the site of many sounding rocket experiments. The Jet Propulsion Laboratory oversaw Seasat. The joint CTS communications satellite was the concern of the Langley Research Center and Goddard. Launches took place at the Kennedy Space Center (Eastern Test Range) and Vandenberg Air Force Base (Western Test Range); launch vehicles were managed by the Lewis Research Center, Goddard, and Marshall.

---

\*See table 4-2 for detailed information on program management.

Table 4-1. Applications Satellites, 1969-1978

Mission Type	Successful	Partly Successful	Unsuccessful	Total
Meteorology, domestic	18	0	2	20
Meteorology, international	3	0	0	3
Communications, domestic*	40	0	5	45
Communications, international	15	1	3	18
Applications Technology				
Satellite	1	1	0	2
Earth Resources Survey	3	0	0	3
Geodetic**	4	0	0	4
Total	84	1	10	95

\*Includes U.S. commercial, military (U.S. and NATO), and joint Canadian-NASA CTS project.

\*\*Includes one satellite launched for U.S. Army.

Table 4-2. Four Phases of Space Applications Management, NASA Headquarters

Phase I  
Jan.-May 1969

Administrator/Deputy Administrator

Associate Administrator, Office of Space Science and Applications (John E. Naugle)

Deputy Associate Administrator, OSSA (Oran W. Nicks)

Deputy Associate Administrator, OSSA (Science) (Henry J. Smith)

Deputy Associate Administrator, OSSA (Engineering) (Vincent L. Johnson)

Director, Advanced Programs (Pitt G. Thome)

Director, Program Review and Resources Management (Eldon D. Taylor)

Director, Space Applications Programs (Leonard Jaffee)

Deputy Director, Space Applications Programs, and Director, Meteorology (Morris Tepper)

Assistant Director, Space Applications Programs (Louis B. C. Fong)

Chief, Program Review and Resources Management (Robert L. Mandeville)

Manager, Advanced Programs and Technical Program (Donald P. Rogers, acting)

Manager, Advanced Instrumentation and Sensor Engineering (Jules Lehmann)

Manager, Applications Technology Satellites Program (Joseph R. Burke)

Chief, Communications Program (A. M. Greg Andrus)

Manager, Earth Resources Survey Disciplines (J. Robert Porter and Robert A. Summers)

Manager, Earth Resources Survey Flights (Theodore E. George)

Manager, Geodetic Satellites Program (Jerome D. Rosenburg)

Chief, Meteorology and Sounding Rockets (William C. Spreen)

Chief, Navigation and Traffic Control Program (Eugene Ehrlich)

Manager, Nimbus Program (Richard I. Haley)

Manager, Operational Systems Support Program (John J. Kelleher)

Manager, Communications Satellite Program (Jerome Friebaum)

Manager, Tiros/TOS Program (Michael L. Garbacz)

Phase II  
June 1969-Nov. 1971

Administrator/Deputy Administrator

Associate Administrator, Office of Space Science and Applications (Naugle)

Deputy Associate Administrator, OSSA (Nicks; Johnson, Sept. 1970)

Deputy Associate Administrator, OSSA (Science) (Smith)

Table 4-2. Four Phases of Space Applications Management, NASA Headquarters  
(Continued)

---

Deputy Associate Administrator, OSSA (Engineering) (Johnson; dropped Sept. 1970)	
Deputy Associate Administrator, OSSA (Applications) (Jaffee)	
Special Assistant (Fong; added 1971)	
Director, Advanced Programs (Thome; Robert G. Wilson, spring 1970)	
Director, Program Review and Resources Management (Taylor; Richard L. Daniels, May 1971)	
Director, Earth Observations Programs (Jaffee, acting; John M. DeNoyer, Dec. 1969)	
Deputy Director, Earth Observations Programs, and Director, Meteorology (Tepper)	
Deputy Director, Flight Program (Thome; added spring 1970)	
Assistant Director, Earth Observations Programs (Fong; dropped 1971)	
Chief, Program Review and Resources Management (Mandeville; Richard T. Hibbard, 1970)	
Managers, Advanced Programs and Technical Program (Summers [1969-70]; Lehmann [1970-71])	
Manager, Advanced Instrumentation and Sensor Engineering Program (Lehmann; added 1971)	
Manager, Earth Resources Survey Flight Program (Theodore E. George)	
Manager, Earth Resources Survey Disciplines Program (Porter; Archibald B. Park, 1970)	
Manager, Earth Resources Experiment Package Program (Thomas L. Fischetti; added mid-1970)	
Chief, Earth Physics and Physics Oceanography Program (Martin J. Swetnick)	
Chief, Meteorology and Sounding Rockets (Spreen)	
Manager, Nimbus Program (Bruton B. Schardt)	
Manager, Operational Meteorology Satellites Program (Garbacz)	
Manager, Global Atmospheric Research Program (Norman L. Durocher; added mid-1970)	
Director, Communications Program (Richard B. Marsten)	
Deputy Director (Rosenberg)	
Chief, Program Review and Resources Management (Albert A. Jenkel)	
Manager, Advanced Programs and Technology Program (Kelleher; Rogers, acting, 1970; Silverman, acting, mid-1970; Samuel W. Fordyce, 1971)	
Manager, Operational Systems Support, (Freibaum; dropped 1971)	
Manager, ATS Program (Burke)	
Manager, Geodetic Satellite Program (Armondo Mancini, acting; Rosenberg, acting, mid-1970)	
Manager, Communications Satellite Program (Andrus)	
Chief, Navigation and Traffic Control Program (Ehrlich)	
Chief, Systems Branch (Donald Silverman)	
Phase III	
Dec. 1971-Oct. 1977	
Administrator/Deputy Administrator	
Associate Administrator, Office of Applications (Charles W. Mathews; Bradford Johnston, June 1976; Anthony J. Calio, Oct. 1977)	
Deputy Associate Administrator, OA (Jaffee)	
Deputy Associate Administrator, OA (Management) (Donald R. Morris; added March 1974)	
Assistant Associate Administrator, OA (Dudley McConnell; added Aug. 1974)	
Special Assistants, (Fong [1971-73], Samuel H. Hubbard [1971-74], Richard H. Sprince [1972-74], Russell L. Schweikart [1974], and Garland C. Minener [1974-75])	
Director, Resources Management (William P. Risso; Jaffee, acting, 1972; Martin F. Sedlazeck, 1973)	
Chief, Management Operations (Forrest Walter; added 1976)	
Budget Officer (J. Duke Sanford; added 1975)	
Director, Data Management (Jaffee, acting; Marsten, acting, 1974; vacant, 1975; added 1972)	
Chief, Data Management (Willis J. Willoughby; vacant, 1974, Herb Ernst, 1975; added 1973)	
Director, User Affairs (Mathews, acting; Albert T. Christensen, 1972; Schweikart, 1974; added 1972; dropped 1976)	

Table 4-2. Four Phases of Space Applications Management, NASA Headquarters  
(Continued)

---

Deputy Director, User Affairs (James T. Richards, Jr; Donald Goedeke, 1976; added 1974)
Principal User Officer, Communications/Navigations (Robert E. Bernier)
Principal User Officer, Special Programs (Melton S. Kramer)
Principal User Officer, Earth Observations Program (Jack Posner)
Director, Special Programs (Francis L. Williams; added 1972)
Manager, GEOC C Program (Dick S. Diller; added 1973; dropped 1976)
Manager, Lageos (Robert L. Spencer; added 1973; dropped 1976)
Manager, Seasat (S. Walter McCandless, Jr.; added 1973)
Manager, Space Processing Applications (James H. Bredt; added 1973)
Manager, Space Processing Operations (Joseph Turtill; added 1977)
Manager, Space Processing Flight Systems (Nolan; added 1974)
Manager, Tectonic Plate Motion Study/Experiments and Supporting Technology/ Geodynamics (James P. Murphy; added 1974)
Manager, Geodetic Program (Charles J. Finley; added 1977)
Chief, Program Review and Resources Management (W. D. Newcomb, Jr.; D. C. Rau, 1976; added 1974)
Director, Technology Applications Program (Mathews, acting; Jerome D. Rosenberg, 1974; vacant, 1977; added 1972)
Manager, Electro-Mechanical Initiatives (Paul F. Barrett; added 1974)
Manager, Environmental Systems Initiatives (Nelson L. Milder; added 1974)
Chief, Program Review and Resources Management (Hibbard; added 1975)
Director, Materials Processing (John R. Carruthers, added April 1977)
Director, Communications Program (Marsten; Vacant, Aug. 1975)
Deputy Director, Communications (Rosenberg; Hubbard, 1974)
Chief, Program Review and Resources Management (Jenkel; Hubbard, 1975)
Manager, Advanced Programs and Technology Program (Fordyce; Andrus, 1973; dropped 1973)
Chief, Technical Consultation Services/Advanced Communications Technology (Edmund Habib; vacant, 1974; Donald K. Dement, 1975; Freibaum, 1976; added 1973)
Chief, Communications Satellites/Sciences Program (Andrus; Fordyce 1973; dropped 1973)
Chief, Energy and Special Studies (Fordyce; added 1973; dropped 1974)
Manager, Traffic Management (John A. Fiebelkorn; Rosenberg, acting, 1973; Marsten, acting, 1974; dropped 1974)
Manager, ATS-CTS (Burke; Harry Mannheimer, early 1974; Adolph J. Cervenka, mid-1974; dropped 1976)
Chief, Systems Programs (Donald Silverman; dropped 1973)
Manager, Spacelab Applications Payloads (Eugene Ehrlich; added 1974)
Manager, Special Communications Applications (Fordyce; added 1974)
Chief, Telecommunications and Computer Pilot Program (Sprince; added 1976)
Manager, Flight Experiments (Wasyf M. Lea, Jr.; added 1974)
Director, Earth Observations Programs (DeNoyer; Jaffee, acting, Oct. 1972; William E. Stoney, Jan. 1973)
Deputy Director, Earth Observations Program, and Director, Meteorology, (Tepper)
Chief, Program Review and Resources Management (Hibbard; G. C. Misener, Jr., 1975; dropped 1976)
Chief, Resources Management (Donald G. Pinkler; added 1975)
Manager, Advanced Instrumentation and Sensor Engineer (Lehmann; added 1974)
Manager, Global Atmospheric Research Program (Robert A. Schiffer; T. H. R. O'Neill, 1974; vacant 1977)
Chief, Environmental Quality (Schiffer; added 1974)
Chief, Meteorology and Sounding Rockets/Weather Programs (Durocher; Richard G. Ter- willinger, acting, 1974; Durocher, 1976; vacant 1977)



Table 4-2. Four Phases of Space Applications Management, NASA Headquarters  
(Continued)

---

Deputy Director, Flight Programs (Thome)

Manager, ERTS-Nimbus Program (Schardt; Mannheimer, 1974)  
 Chief, Earth Resources Survey Program (Gene A. Thorley; James R. Morrison, 1974; added 1973)  
 Manager, Earth Resources Experiment Package (Fischetti; dropped 1974)  
 Manager, Earth Observations Aircraft Program/Spacelab and Shuttle Program Integration (Bernard T. Nolan; added 1973)  
 Manager, Operational Meteorological Satellite Program (Garbacz)  
 Manager, Advanced Missions (Fischetti; added 1974; dropped 1976)  
 Manager, Applications Explorer Missions (Diller; added 1976)  
 Manager, GOES Program (Cervenka; added 1976)

Phase IV

November 1977-1978

Administrator/Deputy Administrator

Associate Administrator, Office of Space and Terrestrial Applications (Calio)  
 Deputy Associate Administrator, OSTA (Jaffee; Samuel W. Keller, May 1978)  
 Chief Scientist (S. Ichtiaque Rasool; added Jan. 1978)  
 Chief Engineer (William P. Raney; added April 1978)  
 Assistant to Associate Administrator (McConnell)

Director, Administration and Management Division (Stanford, acting)

Chief, Resources and Program Management Branch (Kathleen J. Cooter)  
 Chief, Administration Branch, (Sandra L. Morey)

Director, Environmental Observation Division (Lawrence R. Greenwood)

Deputy Director (William P. Bishop)  
 Chief, Oceanic Processes Branch (Bishop, acting 1978)  
 Manager, SEASAT Program (McCandless)  
 Chief, Atmospheric Processes Branch (Shelby G. Tilford)  
 Manager, Nimbus Program (Douglas R. Broome; dropped mid-1978)  
 Manager, Operational Meteorological Satellite Program (Garbacz; dropped mid-1978)  
 Manager, GOES Program (Cervenka; dropped mid-1978)  
 Chief, Operational Systems (Garbacz; added mid-1978)  
 Chief, Research Payloads (Broome; added mid-1978)

Director, Resource Observation Division (Thome)

Chief, Renewable Resources Branch (vacant)  
 Manager, Landsat Program (Mannheimer)  
 Chief, Nonrenewable Resources Branch (vacant)  
 Chief, Geodynamics Branch (vacant)

Director, Applications Systems Division (Keller, acting)

Chief, Flight Systems Branch (vacant)  
 Chief, Information Systems Branch (vacant)  
 Chief, Payload Planning Branch (W. G. Goldberg, Jr.)

Director, Technology Transfer Division (Floyd I. Roberson)

Chief, Applications Development Branch (vacant)  
 Manager, University Programs (Joseph A. Vitale)  
 Chief, Technology Utilization Branch (Louis W. Mogavero)

---

## BUDGET

For a general introduction to the NASA budget process and to the budget tables in this volume, consult chapter 1. Other data that may assist the researcher interested in the cost of NASA's space applications program include budget tables in chapter 1 for the various launch vehicles used by the Office of Space Applications. Chapter 6 provides budget data on the tracking network that supported the agency's applications flight projects. For a more detailed breakdown of the flight project budgets, see the NASA annual budget estimates referred to in chapter 1. Review the bottom notes of all tables carefully before making conclusions about totals for any particular project or year.

### Money for Space Applications

NASA's total budget decreased steadily from 1966 to 1973, when it took a slight increase, only to fall the next year to the lowest sum the space agency had been allocated since 1962.\* Money for space applications, however, increased over the previous year's budget every year but two during the agency's second decade. But even with the increased emphasis by Congress and the White House on practical space projects that would benefit mankind, space applications accounted for only a small wedge of the R&D pie. From 3.05% in 1969, it grew steadily to reach 7.73% in 1978 (see table 4-3).

The following budget charts give the researcher data on the budgets for space applications projects and the various disciplines. Flight projects are broken down

\*With inflation increasing each year, NASA's budget continued to decrease through 1975 in terms of actual spending power. See House Committee on Science and Technology, Subcommittee on Space Science and Applications, *United States Civilian Space Programs, 1958-1978, Report, 97th Cong., 1st session* (Washington, 1981), p. 59.

Table 4-3. Money for Space Applications, 1969-1978

Year	Total NASA Budget Submission	Total NASA R&D Submission	Total NASA Applications Submission/% of R&D
1969	4 370 400	3 677 200	112 200/3.05
1970	3 760 527	3 051 427	135 800/4.45
1971	3 333 000	2 606 100	167 000/6.40
1972	3 271 350	2 517 700	182 500/7.25
1973	3 407 650	2 600 900	194 700/7.49
1974	3 016 000	2 197 000	147 000/6.69
1975	3 267 104	1 346 015	177 500/7.57
1976	3 558 986	2 678 380	175 030/6.53
1977	3 697 000	2 758 925	198 200/7.18
1978	4 080 989	3 026 000	233 800/7.73

further: spacecraft, experiments/sensors, operations. See tables 4-4 and 4-5 for summary information. Refer to chapter 1 for general information concerning what these figures mean and the sources used. Researchers who refer to the original NASA budget estimate volumes and summary chronologies will discover that the agency changed its space applications budget categories several times over the 10-year period. The charts presented in this volume are an attempt to combine the different approaches into one. Take special notice of the many bottom notes.

Table 4-4. Total Space Applications Funding History  
(in thousands of dollars)

Year	Request	Authorization	Programmed
1969	112 200 <sup>a</sup>	98 700 <sup>a</sup>	98 665 <sup>a</sup>
1970	135 800 <sup>a</sup>	128 400 <sup>a</sup>	128 304 <sup>a</sup>
1971	167 000 <sup>a</sup>	167 000 <sup>a</sup>	166 960
1972	182 500 <sup>a</sup>	185 000 <sup>a</sup>	187 500
1973	194 700	207 200	188 700
1974	153 000 <sup>b</sup>	161 000	159 000
1975	177 500	196 300	174 748
1976	229 730 <sup>c</sup>	181 530 <sup>d</sup>	178 230
1977	198 200	198 000	198 200
1978	228 800	239 800	234 800

<sup>a</sup>Included with space science in FY 1969-1972 budget estimates.

<sup>b</sup>Of this, \$6 000 000 was taken from FY 1973 funds.

<sup>c</sup>Includes \$54 700 000 for the transition quarter.

<sup>d</sup>Authorization figures do not include the transition quarter.

Table 4-5. Programmed Costs by Applications Flight-Research Project, 1969-1978

Discipline/Project	1969	1970	1971	1972	1973	1974	1975	1976	1977	1978
Earth Resources Survey										
ERTS/Landsat	2300	15 000	55 750	52 080	32 600	17 400	17 700	18 100	21 200	61 955
Aircraft Program	8900	11 000	10 985	12 350	13 000	16 600	(7700) <sup>b</sup>	(5500)	(12 750)	9100
Meteorology										
Tiros/TOS	5800	3700	3200	2150	4250	12 500	7500	8000	11 700	4100
SMS	---	2700	8850	16 900	18 455	10 000	2100	---	---	---
GARP	---	---	100	1750	3240	5698	7200	7000	5056	(8300)
Soundings	3000	3000	3100	1500	1200	1500	1500	1900	---	---
Severe Storm Observation	---	---	---	---	---	---	6973	7900	6100	(3500)
Nimbus	31 800	27 239	24 700	18 125	28 800	25 200	28 300	18 700	15 400	13 110
Communications-ATS										
ATS	24 700	38 965	23 750	49 162	53 187	17 000	---	---	---	3800
CTS	100	83	75	2600	2732	2760	7750	5500	4000	---
Search and Rescue Satellite	---	---	---	---	---	---	---	---	---	5600
Navigation/Traffic Control Satellite	---	---	3000	---	154	---	---	---	---	---
Radio Interference/Propagation Experiment	---	438	1000	1600	---	---	---	---	---	---
Earth and Ocean Dynamics										
GEOS	2465	1700	2806	2800	5341	3400	2500	---	1435	---
Lageos	---	---	---	---	---	4000	2400	2100	---	---
SEASAT	---	---	---	---	---	---	8000	17 400	29 700	14 867
Applications Explorers										
Heat Capacity Mapping Mission	---	---	---	---	---	---	2588	3500	1700	600
Magnetic Field Satellite	---	---	---	---	---	---	---	---	3200	10 500
Stratospheric Aerosol and Gas Experiment	---	---	---	---	---	---	---	2400	4100	2400
Earth Observatory Satellite	---	---	---	1000	900	3000	---	---	---	---

Table 4-6. Earth Resources Survey Program Funding History  
(in thousands of dollars)

Year	Request	Authorization	Programmed
1969	12 200	---	11 200
1970	25 100	25 100	26 000
1971	52 500	52 500	66 735
1972	48 500	51 000	55 155
1973	48 400	48 400	55 155
1974	42 600	49 600	47 488
1975	58 600	---	34 178
1976	62 030	63 530	34 000
1977	67 300	67 300	53 816
1978	92 000	99 000	71 055

Table 4-7. ERTS/Landsat Earth Resources Survey Program—Funding History  
(in thousands of dollars)

Year	Request	Authorization	Programmed
1969	2000	---	2300
1970	14 100	14 100	15 000
1971	41 500	41 500	55 750
1972	37 500	---	52 080
1973	35 400	35 400	32 600
1974	12 400	---	17 400 <sup>a</sup>
1975	15 100 <sup>b</sup>	---	17 700
1976	21 800 <sup>c</sup>	---	18 100
1977	20 000 <sup>d</sup>	---	21 200
1978	40 900	---	61 955

<sup>a</sup>Includes \$1 000 000 for a multispectral scanner 5th band.

<sup>b</sup>Includes \$4 000 000 for a multispectral scanner 5th band.

<sup>c</sup>Includes \$2 000 000 for a multispectral scanner 5th band.

<sup>d</sup>Includes \$4 000 000 for a thematic mapper for Landsat D and \$2 500 000 for follow-on data analysis.

Table 4-8. ERTS/Landsat—Spacecraft Funding History  
(in thousands of dollars)

Year	Request	Programmed
1969	2000 <sup>a</sup>	1375
1970	6500	1747
1971	13 000	21 921
1972	15 000	19 383
1973	9800	5997
1974	2200	4917
1975	3200	4000
1976	13 300 <sup>b</sup>	7855
1977	8430	7173
1978	14 925	15 000

<sup>a</sup>For spacecraft and support.

<sup>b</sup>Includes \$3 200 000 for the transition quarter.

Table 4-9. ERTS/Landsat—Sensors Funding History  
(in thousands of dollars)

Year	Request	Programmed
1969	---	800
1970	5900	12 453
1971	20 700	21 343
1972	13 500	17 081
1973	23 100	19 674
1974	9500	11 102 <sup>a</sup>
1975	9600 <sup>b</sup>	5000
1976	6000 <sup>c</sup>	5040
1977	6670 <sup>d</sup>	7382
1978	21 000 <sup>e</sup>	31 500

<sup>a</sup>Includes \$1 000 000 for a multispectral scanner 5th band.

<sup>b</sup>Includes \$4 000 000 for a multispectral scanner 5th band.

<sup>c</sup>Includes \$2 000 000 for a multispectral scanner 5th band.

<sup>d</sup>Includes \$4 000 000 for a thematic mapper.

<sup>e</sup>Includes \$14 800 000 for a thematic mapper.

Table 4-10. ERTS/Landsat—Ground Operations Funding History  
(in thousands of dollars)

Year	Request	Programmed
1969	---	125
1970	1700	800
1971	7800	12 486
1972	9000	15 616
1973	2500	6929
1974	700	1381
1975	2300	---
1976	2500 <sup>a</sup>	105
1977	4900 <sup>b</sup>	6645 <sup>c</sup>
1978	4975 <sup>d</sup>	12 300 <sup>e</sup>

<sup>a</sup>Includes \$100 000 for the transition quarter.

<sup>b</sup>Includes \$2 500 000 for follow-on data analysis and operations.

<sup>c</sup>Includes \$1 700 000 for follow-on data analysis and operations.

<sup>d</sup>Includes \$1 000 000 for follow-on data analysis and operations.

<sup>e</sup>Includes \$200 000 for extended mission operations and \$10 400 000 for remote sensor technology transfer and support activities.

Table 4-11. Earth Resources Aircraft Program Funding History  
(in thousands of dollars)

Year	Request	Authorization	Programmed
1969	10 200	---	8900
1970	11 000	11 000	11 000
1971	11 000	11 000	10 985
1972	11 000	---	12 350
1973	13 000	13 000	13 000 <sup>e</sup>
1974	16 000	---	16 600
1975	17 300	---	--- <sup>a</sup>
1976	16 930 <sup>b</sup>	---	--- <sup>c</sup>
1977	--- <sup>d</sup>	---	--- <sup>e</sup>
1978	--- <sup>f</sup>	---	9100 <sup>g</sup>

<sup>a</sup>\$7 700 000 programmed for applications research and technology development aircraft support for development of capabilities in remote sensing of Earth resources.

<sup>b</sup>Includes \$3 600 000 for the transition quarter.

<sup>c</sup>\$5 500 000 programmed for applications research and technology development aircraft support for development of capabilities in remote sensing of Earth resources.

<sup>d</sup>\$600 000 requested for applications research and technology development aircraft support for development of capabilities in remote sensing of Earth resources.

<sup>e</sup>\$12 750 000 programmed for applications research and technology development aircraft support for development of capabilities in remote sensing of Earth resources.

<sup>f</sup>\$500 000 requested for applications research and technology development aircraft support for development of capabilities in remote sensing of Earth resources.

<sup>g</sup>For applications systems airborne instrumentation research program.

Table 4-12. Earth Resources—Data Interpretation Techniques, Special Investigations,  
and Data Analysis Funding History  
(in thousands of dollars)

Year	Request	Programmed
1972	---	9889
1973	---	9555
1974	12 600	13 488
1975	22 400	8778 <sup>a</sup>
1976	36 800 <sup>b</sup>	10 400 <sup>a</sup>
1977	14 800 <sup>a</sup>	--- <sup>c</sup>
1978	13 400 <sup>a</sup>	---

<sup>a</sup>For applications transfer and demonstration program.

<sup>b</sup>Includes \$12 200 000 (\$2 900 000 for the transition quarter) for applications systems verification tests and \$24 600 000 (\$500 000 for the transition quarter) for data interpretation techniques, etc.

<sup>c</sup>\$19 866 000 was programmed for advanced research and technology development data interpretation techniques, etc.

Table 4-13. Earth Resources Survey Program—Earth Resources Experiment Package (EREP) Funding History  
(in thousands of dollars)

Year	Request	Programmed
1973	---	--- <sup>a</sup>
1974	---	--- <sup>a</sup>
1975	3800	--- <sup>b</sup>
1976	1500	---

<sup>a</sup>Funded by the Office of Manned Space Flight.

<sup>b</sup>It was estimated in the FY 1976 budget estimate that \$2 500,000 would be programmed for EREP in FY 1975; the category was dropped in the FY 1977 estimate.

Table 4-14. Meteorology Program Funding History  
(in thousands of dollars)

Year	Request	Authorization	Programmed
1969	40 900	---	40 600
1970	41 000	38 100	36 639
1971	50 900	51 100	40 850
1972	42 700	42 700	40 425
1973	53 800	56 800	55 945
1974	53 900	---	54 898
1975	57 000	---	53 273
1976	59 700	---	43 100
1977	40 800	---	39 756
1978	33 900	---	9110

Table 4-15. Meteorology Program—Tiros/TOS Funding History  
(in thousands of dollars)

Year	Request	Authorization	Programmed
1969	5800	---	5800
1970	5200	3700	3700
1971	3200	3200	3200
1972	1600	1600	2150
1973	8000	9000	4250
1974	13 000	---	12 500
1975	9000	---	7500
1976	18 500 <sup>a</sup>	---	8000
1977	8600 <sup>b</sup>	---	11 700
1978	4600 <sup>c</sup>	---	4100

<sup>a</sup>Includes \$2 100 000 for the transition quarter for Tiros N and \$2 400 000 for the transition quarter for operational satellite improvements.

<sup>b</sup>Another \$1 600 000 was requested for weather and climate observation and forecasting project follow-on data analysis and operations to be applied to Nimbus, Tiros, and other related projects.

<sup>c</sup>Includes \$2 500 000 for follow-on data analysis operations.

Table 4-16. Tiros/TOS—TOS/ITOS Improvement Funding History  
(in thousands of dollars)

Year	Request	Authorization	Programmed
1969	2500	---	1500
1970	4000	---	1667
1971	2500	---	2559
1972	1600	---	2150
1973	2200	3200	--- <sup>a</sup>
1974	---	---	2500 <sup>b</sup>
1975	---	---	---
1976	7400 <sup>a</sup>	---	---

<sup>a</sup>It was estimated in the FY 1974 budget estimate that \$1 640 000 would be programmed for ITOS in FY 1973; the category was dropped in the FY 1975 estimate.

<sup>b</sup>For operational satellite improvements to include ITOS and GOES.

<sup>c</sup>Includes \$2 400 000 for the transition quarter.

Table 4-17. Tiros/TOS—Tiros M Spacecraft Funding History  
(in thousands of dollars)

Year	Request	Programmed
1969	3300	4300
1970	1200	2033
1971	700	641
1972	---	--- <sup>a</sup>

<sup>a</sup>It was estimated in the FY 1973 budget estimate that \$202 000 would be programmed for Tiros M spacecraft in FY 1972; the category was dropped in the FY 1974 estimate.



Table 4-18. Tiros/TOS—Tiros N Spacecraft and Support Funding History  
(in thousands of dollars)

Year	Request	Authorization	Programmed
1973	5800	5800	---
1974	6740	---	6323
1975	7000	---	4482
1976	7200 <sup>a</sup>	---	5515
1977	6500	---	8391
1978	2100	---	3759

<sup>a</sup>Includes \$1 700 000 for the transition quarter.

Table 4-19. Tiros/TOS—Tiros N Sensors Funding History  
(in thousands of dollars)

Year	Request	Programmed
1973	---	4250
1974	2760	3677
1975	2000	3018
1976	3600 <sup>a</sup>	2332
1977	1875	1549
1978	---	34

<sup>a</sup>Includes \$300 000 for the transition quarter.

Table 4-20. Tiros/TOS—Tiros N Gound Operations Funding History  
(in thousands of dollars)

Year	Request	Programmed
1974	500	---
1975	---	---
1976	300 <sup>a</sup>	153
1977	225	1760 <sup>b</sup>
1978	2500 <sup>c</sup>	307

<sup>a</sup>Includes \$100 000 for the transition quarter.

<sup>b</sup>Includes \$1 600 000 for follow-on data analysis and operations.

<sup>c</sup>For follow-on data analysis and operations.

Table 4-21. Meteorology Program—SMS (Synchronous Meteorological Satellite  
Funding History  
(in thousands of dollars)

Year	Request	Authorization	Programmed
1970	3600	3600	2700
1971	15 600	15 600	8850
1972	13 000	13 000	16 900
1973	11 500	11 500	18 455 <sup>a</sup>
1974	7000	---	10 000
1975	4900 <sup>b</sup>	---	2100

<sup>a</sup>Includes \$1 755 000 for operational satellite improvements.

<sup>b</sup>Includes \$3 500 000 for operational satellite improvements.

Table 4-22. SMS—Spacecraft Funding History  
(in thousands of dollars)

Year	Request	Programmed
1970	3600 <sup>a</sup>	235
1971	10 200	7205
1972	10 428	11 892
1973	8947	13 234
1974	5849	---
1975	1400	---

<sup>a</sup>For spacecraft and support.

Table 4-23. SMS—Sensors Funding History  
(in thousands of dollars)

Year	Request	Programmed
1970	---	2305
1971	2200	700
1972	1292	3524
1973	1544	4382 <sup>a</sup>
1974	628	---
1975	3500 <sup>b</sup>	---

<sup>a</sup>Includes \$1 755 000 for operational satellite improvements.

<sup>b</sup>For operational satellite improvements.

Table 4-24. SMS—Ground Operations Funding History  
(in thousands of dollars)

Year	Request	Programmed
1970	---	160
1971	3200	945
1972	1280	1484
1973	1009	839
1974	523	---

Table 4-25. Global Atmospheric Research Program (Studies) Funding History  
(in thousands of dollars)

Year	Request	Authorization	Programmed
1971	1000	1000	1000
1972	2500	2500	1750
1973	4500	6500	3240
1974	7000	---	5698
1975	7400	---	7200
1976	10 000 <sup>a</sup>	---	7000
1977	6000	---	5056
1978	5000	---	--- <sup>b</sup>

<sup>a</sup>Includes \$3 000 000 for the transition quarter.

<sup>b</sup>\$8 300 000 was programmed for applied research and development activities—global weather (including GARP).

Table 4-26. Soundings, Meteorological Funding History  
(in thousands of dollars)

Year	Request	Authorization	Programmed
1969	3000	---	3000
1970	3000	3000	3000
1971	3100	3100	3100
1972	2500	2500	1500
1973	1500	1500	1200
1974	1500	---	1500 <sup>a</sup>
1975	1700	---	1500 <sup>a</sup>
1976	2500 <sup>b</sup>	---	1900 <sup>a</sup>
1977	2100 <sup>a</sup>	---	---
1978	2100 <sup>a</sup>	---	---

<sup>a</sup> Included as part of applications research and technology development (weather and climate).

<sup>b</sup> Includes \$600 000 for transition quarter.

Table 4-27. Meteorology Program—Severe Storm Observation Program Funding History  
(in thousands of dollars)

Year	Request	Programmed
1975	---	6973
1976	1800 <sup>a</sup>	7900
1977	7100	6100
1978	6500	--- <sup>b</sup>

<sup>a</sup> Includes \$300 000 for the transition quarter.

<sup>b</sup> \$3 500 000 was programmed for applications research and development activities—severe storms.

Table 4-28. Meteorology Program—Nimbus Funding History  
(in thousands of dollars)

Year	Request	Authorization	Programmed
1969	32 100	---	31 800
1970	29 200	27 800	27 239
1971	28 000	28 200	24 700
1972	23 100	23 100	18 125
1973	28 300	28 300	28 800
1974	25 400 <sup>a</sup>	---	25 200 <sup>b</sup>
1975	34 000 <sup>c</sup>	---	28 300
1976	26 900 <sup>d</sup>	---	18 700
1977	17 000 <sup>e</sup>	---	15 400
1978	15 700	---	13 110 <sup>f</sup>

<sup>a</sup>Includes \$16 400 000 for Nimbus 5 and F and \$9 000 000 for Nimbus G, a pollution-monitoring spacecraft.

<sup>b</sup>Includes \$16 400 000 for Nimbus 5 and F and \$8 800 000 for Nimbus G.

<sup>c</sup>Includes \$7 000 000 for Nimbus 5 and F and \$27 000 000 for Nimbus G.

<sup>d</sup>Includes \$3 500 000 (\$900 000 for the transition quarter) for Nimbus 5 and F and \$15 000 000 (\$7 500 000 for the transition quarter) for Nimbus G.

<sup>e</sup>Includes \$1 600 000 for weather and climate observation and forecasting project follow-on data analysis to be applied to Nimbus, Tiros, and other related satellite projects.

<sup>f</sup>Includes \$900 000 for Nimbus extended operations.

Table 4-29. Nimbus—Spacecraft Funding History  
(in thousands of dollars)

Year	Request	Programmed
1969	18 000	22 826
1970	17 400	18 291
1971	15 500	18 001
1972	12 750	9969
1973	15 310	15 388
1974	15 165	8235
1975	15 230	5917
1976	10 500 <sup>a</sup>	6309
1977	5300	3798
1978	4800	3700

<sup>a</sup>Includes \$2 500 000 for the transition quarter.

Table 4-30. Nimbus—Sensors Funding History  
(in thousands of dollars)

Year	Request	Programmed
1969	12 100	7489
1970	8800	7089
1971	11 300	5691
1972	9420	7637
1973	11 226	12 330
1974	9050	15 948
1975	16 970	13 083
1976	12 600 <sup>a</sup>	6671
1977	7100	9619
1978	7900	4610

<sup>a</sup>Includes \$4 300 000 for the transition quarter.

Table 4-31. Nimbus—Ground Operations Funding History  
(in thousands of dollars)

Year	Request	Programmed
1969	2000	1485
1970	3000	1859
1971	1200	1008
1972	930	519
1973	1764	1082
1974	1185	1017
1975	1800	---
1976	3800 <sup>a</sup>	20
1977	4600	1983
1978	3000 <sup>b</sup>	3900

<sup>a</sup>Includes \$1 600 000 for the transition quarter.

<sup>b</sup>Includes \$1 000 000 for follow-on data analysis and operations.

Table 4-32. Communications-Applications Technology Satellite Program Funding History  
(in thousands of dollars)

Year	Request	Authorization	Programmed
1969	31 300	---	24 800
1970	44 300	41 100	39 486
1971	34 200	34 200	27 825
1972	63 900	63 900	53 362
1973	64 500	72 000	56 073
1974	22 100	---	19 760
1975	5250	---	7750
1976	4900	---	5500
1977	4000	---	4000
1978	9400	---	9400

Table 4-33. Communications-Applications Technology Satellite Program—  
Applications Technology Satellite (ATS)  
(in thousands of dollars)

Year	Request	Authorization	Programmed
1969	31 200	---	24 700
1970	44 200	41 000	38 965
1971	31 100	31 100	23 750
1972	60 300	60 300	49 162
1973	61 200	61 200	53 187
1974	19 000 <sup>a</sup>	---	17 000 <sup>b</sup>
1975	3700 <sup>c</sup>	---	---
1976	3700 <sup>e</sup>	---	---
1977	---	---	---
1978	---	---	3800 <sup>f</sup>

<sup>a</sup>Includes \$3 000 000 for experiments coordination and operations support for ATS F and CTS.

<sup>b</sup>Includes \$800 000 for experiments coordination and operations support for ATS F and CTS.

<sup>c</sup>For experiments coordination and operations support for ATS F and CTS.

<sup>d</sup>It was estimated in the FY 1976 budget estimate that \$6 200 000 would be programmed for ATS in FY 1975; the category was dropped in the FY 1977 estimate.

<sup>e</sup>For experiments coordination and operations support for ATS F and CTS; includes \$800 000 for the transition quarter.

<sup>f</sup>For communications follow-on data analysis and operations for ATS 6 and CTS.

Table 4-34. ATS—Spacecraft Funding History  
(in thousands of dollars)

Year	Request	Programmed
1969	15 300	14 293
1970	19 100	18 450
1971	15 600	1049
1972	26 300	26 443
1973	25 250	---
1974	12 500	---

Table 4-35. ATS—Experiment and Instrumentation Funding History  
(in thousands of dollars)

Year	Request	Programmed
1969	13 100	9824
1970	21 200	18 506
1971	14 200	16 985
1972	31 000	18 543
1973	33 250	---
1974	3000	---

Table 4-36. ATS—Operations Funding History  
(in thousands of dollars)

Year	Request	Programmed
1969	2800	583
1970	3900	2009
1971	1300	5716 <sup>a</sup>
1972	3000	4176 <sup>b</sup>
1973	2700 <sup>c</sup>	---
1974	3500 <sup>d</sup>	---
1975	3700 <sup>e</sup>	---
1976	---	---
1977	---	---
1978	---	3800 <sup>f</sup>

<sup>a</sup>Includes \$3 205 000 for extended operations (ATS 1-5).

<sup>b</sup>Includes \$1 450 000 for extended operations (ATS 1-5).

<sup>c</sup>Includes \$1 200 000 for extended operations (ATS 1-5).

<sup>d</sup>Includes \$3 000 000 for experiments coordination and operations support for ATS F and CTS.

<sup>e</sup>For experiments coordination and operations support for ATS F and CTS.

<sup>f</sup>For communications follow-on data analysis and operations for ATS 6 and CTS.

Table 4-37. Communications-Applications Technology Satellite Program—  
Small ATS Funding History  
(in thousands of dollars)

Year	Request	Authorization	Programmed
1973	---	5000	---

Table 4-38. Communications-ATS Program—Communications Technology Satellite (CTS) Funding History  
(in thousands of dollars)

Year	Request	Authorization	Programmed
1969	100	---	100
1970	100	100	83
1971	100	100	75
1972	2600	2600	2600
1973	3300	3300	2732
1974	3100 <sup>a</sup>	---	2760 <sup>b</sup>
1975	1550 <sup>c</sup>	---	7750 <sup>d</sup>
1976	1200 <sup>e</sup>	---	5500 <sup>f</sup>
1977	4000 <sup>g</sup>	---	4000 <sup>g</sup>
1978	3800 <sup>g</sup>	---	---

<sup>a</sup>An additional \$3 000 000 was requested for experiments coordination and operations support for CTS and ATS F.

<sup>b</sup>An additional \$800 000 was programmed for experiments coordination and operations support for CTS and ATS F.

<sup>c</sup>An additional \$3 700 000 was requested for experiments coordination and operations support for CTS and ATS F.

<sup>d</sup>Includes \$6 200 000 for follow-on data analysis and operations.

<sup>e</sup>Includes \$100 000 for the transition quarter; an additional \$3 700 000 (\$800 000 for the transition quarter) was requested for experiments coordination and operations support for CTS and ATS F.

<sup>f</sup>Includes \$4 400 000 for follow-on data analysis and operations support.

<sup>g</sup>Includes \$3 700 000 for follow-on data analysis and operations.

Table 4-39. CTS—Spacecraft Funding History  
(in thousands of dollars)

Year	Request	Programmed
1969	100 <sup>a</sup>	100 <sup>a</sup>
1970	100	83 <sup>a</sup>
1971	100 <sup>a</sup>	---
1972	2600 <sup>a</sup>	100
1973	470	339
1974	500	280
1975	790	---
1976	620	---

<sup>a</sup>For spacecraft and support.

Table 4-40. CTS—Experiments Funding History  
(in thousands of dollars)

Year	Request	Programmed
1972	---	2400
1973	2530	2247
1974	1950	2405
1975	560	---
1976	330	---

Table 4-41. CTS—Operational Support Funding History  
(in thousands of dollars)

Year	Request	Programmed
1973	300	100
1974	650	75
1975	200	---
1976	250 <sup>a</sup>	---

<sup>a</sup>Includes \$100 000 for the transition quarter.

Table 4-42. Communications-Applications Technology Satellite Program—Search and Rescue Satellite System Funding History  
(in thousands of dollars)

Year	Request	Programmed
1978	5600	5600

Table 4-43. Communications-Applications Technology Satellite Program—Navigation/Traffic Control Satellite Studies Funding History  
(in thousands of dollars)

Year	Request	Authorization	Programmed
1971	3000 <sup>a</sup>	3000	3000 <sup>b</sup>
1972	---	---	---
1973	---	---	154 <sup>c</sup>

<sup>a</sup>For navigation/traffic control satellite studies.

<sup>b</sup>For air traffic control studies.

<sup>c</sup>For communications traffic management studies.

Table 4-44. Communications-Applications Technology Satellite Program—Radio Interference and Propagation Program Funding History  
(in thousands of dollars)

Year	Request	Authorization	Programmed
1970	---	---	438
1971	---	---	1000
1972	1000	1000	1600
1973	---	2500	---



Table 4-45. Earth and Ocean Dynamics Program Funding History  
(in thousands of dollars)

Year	Request	Authorization	Programmed
1969	3000	---	2465
1970	3000	1700	1700
1971	3500	3500	2806
1972	1300	1300	2800
1973	5000	5000	5341
1974	7600	---	7400
1975	---	13 900	12 900
1976	26 800	---	19 500
1977	28 500	---	31 225
1978	16 100	---	14 867

Table 4-46. Earth and Ocean Dynamics Program—Geodetic Satellite (GEOS)  
Funding History  
(in thousands of dollars)

Year	Request	Authorization	Programmed
1969	4000	---	2465
1970	3000	1700	1700
1971	3500	3500	2806
1972	1300	1300	2800
1973	5000	5000	5341
1974	3400 <sup>a</sup>	---	3400
1975	900 <sup>a</sup>	---	2500 <sup>b</sup>
1976	---	---	---
1977	1800 <sup>c</sup>	---	1435 <sup>d</sup>

<sup>a</sup>Another \$2 700 000 was requested for Earth and ocean physics experiment data analysis to be applied to GEOS, LAGEOS, and SEASAT investigations.

<sup>b</sup>Includes \$1 600 000 for GEOS 3 follow-on data analysis and operations. Another \$1 100 000 was programmed for Earth dynamics monitoring and forecasting project follow-on data analysis and operations to be applied to GEOS, LAGEOS, and other investigations.

<sup>c</sup>For GEOS 3 follow-on analysis and operations. Another \$1 400 000 was requested for Earth dynamics monitoring and forecasting project follow-on data analysis and operations to be applied to GEOS, LAGEOS, and other investigations.

<sup>d</sup>For follow-on data analysis and operations for GEOS and other related satellite investigations.

Table 4-47. GEOS—Spacecraft Funding History  
(in thousands of dollars)

Year	Request	Programmed
1969	4000 <sup>a</sup>	2465 <sup>a</sup>
1970	3000 <sup>a</sup>	1700 <sup>a</sup>
1971	3500 <sup>a</sup>	1166
1972	1300 <sup>a</sup>	1232 <sup>b</sup>
1973	2400	2400 <sup>b</sup>
1974	2400 <sup>b</sup>	---
1975	70 <sup>b</sup>	---

<sup>a</sup>For spacecraft and support (GEOS 1 and 2).

<sup>b</sup>Not specified as to mission.

Table 4-48. GEOS—Sensors Funding History  
(in thousands of dollars)

Year	Request	Programmed
1972	---	443
1973	1800	1595
1974	700	---
1975	402	---

Table 4-49. GEOS—Operations Funding History  
(in thousands of dollars)

Year	Request	Programmed
1971	---	1640
1972	---	---
1973	800	200
1974	300	---
1975	428	---

Table 4-50. Earth and Ocean Dynamics Program—LAGEOS Funding History  
(in thousands of dollars)

Year	Request	Programmed
1974	4200 <sup>a</sup>	4000 <sup>a</sup>
1975	5000 <sup>a</sup>	2400 <sup>b</sup>
1976	4800 <sup>c</sup>	2100 <sup>d</sup>
1977	1400 <sup>e</sup>	---
1978	1900 <sup>e</sup>	---

<sup>a</sup>Includes \$2 700 000 for Earth and ocean physics experiment data analysis to be used for LAGEOS, GEOS, and SEASAT.

<sup>b</sup>Includes \$1 100 000 for follow-on data analysis and operations.

<sup>c</sup>Includes \$300 000 for the transition quarter and \$3 500 000 (\$800 000 for the transition quarter) for Earth and ocean physics data analysis.

<sup>d</sup>Includes \$1 900 000 for follow-on data analysis and operations.

<sup>e</sup>For follow-on data analysis and operations.

Table 4-51. LAGEOS—Spacecraft Funding History  
(in thousands of dollars)

Year	Request	Programmed
1974	1200	830
1975	1455	---

Table 4-52. LAGEOS—Experiments Funding History  
(in thousands of dollars)

Year	Request	Programmed
1974	300	---

Table 4-53. LAGEOS—Operations Funding History  
(in thousands of dollars)

Year	Request	Programmed
1974	2700 <sup>a</sup>	3170 <sup>b</sup>
1975	3545 <sup>a</sup>	---
1976	4800 <sup>c</sup>	---

<sup>a</sup>For Earth and ocean physics experiment data analysis to be used for LAGEOS, GEOS, and SEASAT.

<sup>b</sup>Includes \$300 000 for the transition quarter and \$3 500 000 (\$800 000 for the transition quarter) for Earth and ocean physics experiment data analysis to be used for LAGEOS, GEOS, and SEASAT.

<sup>c</sup>Includes \$2 700 000 for Earth and ocean physics experiment data analysis to be used for LAGEOS, GEOS, and SEASAT.

Table 4-54. Earth and Ocean Dynamics Program—SEASAT Funding History  
(in thousands of dollars)

Year	Request	Programmed
1975	8000	8000
1976	22 000 <sup>a</sup>	17 400
1977	25 300	29 790
1978	14 200	14 867 <sup>b</sup>

<sup>a</sup>Includes \$5 000 000 for the transition quarter.

<sup>b</sup>Includes \$500 000 for experiments and operations for a geodynamics experimental ocean satellite.

Table 4-55. SEASAT—Spacecraft Funding History  
(in thousands of dollars)

Year	Request	Programmed
1975	3200	---
1976	8700 <sup>a</sup>	9875
1977	15 315	16 960
1978	7147	9106

<sup>a</sup>Includes \$1 700 000 for the transition quarter.

Table 4-56. SEASAT—Sensors Funding History  
(in thousands of dollars)

Year	Request	Programmed
1975	4800	8000
1976	13 300 <sup>a</sup>	5840
1977	8715	9860
1978	738	1720

<sup>a</sup>Includes \$3 300 000 for the transition quarter.

Table 4-57. SEASAT—Operations Funding History  
(in thousands of dollars)

Year	Request	Programmed
1976	---	1685 <sup>a</sup>
1977	1270	2970 <sup>b</sup>
1978	6315 <sup>c</sup>	4041 <sup>d</sup>

<sup>a</sup>Includes \$1 600 000 for follow-on data analysis and operations.

<sup>b</sup>Includes \$1 700 000 for follow-on data analysis and operations.

<sup>c</sup>Includes \$2 800 000 for follow-on data analysis and operations.

<sup>d</sup>Includes \$500 000 for experiments and operations for a geodynamic experimental ocean satellite.

Table 4-58. Other Projects—Applications Explorers Funding History  
(in thousands of dollars)

Year	Request	Authorization	Programmed
1975	2600	---	2588
1976	8500	5900	5900
1977	10 300	10 300	9000
1978	13 200	13 200	13 500

Table 4-59. Applications Explorers—Heat Capacity Mapping Mission Funding History  
(in thousands of dollars)

Year	Request	Programmed
1975	2600	2588
1976	4100 <sup>a</sup>	3500
1977	2200	1700
1978	600	600

<sup>a</sup>Includes \$600 000 for the transition quarter.

Table 4-60. Applications Explorers—Magnetic Field Satellite Funding History  
(in thousands of dollars)

Year	Request	Programmed
1977	2000	3200
1978	10 200	10 500

Table 4-61. Applications Explorers—  
Stratospheric Aerosol and Gas Experiment Funding History  
(in thousands of dollars)

Year	Request	Programmed
1976	4400 <sup>a</sup>	2400
1977	6100	4100
1978	2400	2400

<sup>a</sup>Includes \$2 000 000 for the transition quarter.

Table 4-62. Other Projects—Earth Observatory Satellite Studies Funding History  
(in thousands of dollars)

Year	Request	Authorization	Programmed
1972	1000	1000	1000
1973	1000	2000	900
1974	3000	3000	3000
1975	1000	---	--- <sup>a</sup>

<sup>a</sup>It was estimated in the FY 1976 budget estimate that \$1 000 000 would be programmed for Earth observatory satellite studies in FY 1975; the category was dropped in the FY 1977 estimate.

Table 4-63. Other Projects—Shuttle Experiment Payload Definition Funding History  
(in thousands of dollars)

Year	Request	Authorization	Programmed
1974	4500	4500	4500
1975	4500	---	--- <sup>a</sup>
1976	4500 <sup>b</sup>	4000	--- <sup>b</sup>
1977	2000 <sup>d</sup>	---	2500 <sup>e</sup>
1978	13 200 <sup>f</sup>	---	12 900 <sup>g</sup>

<sup>a</sup>It was estimated in the FY 1976 budget estimate that \$4 500 000 would be programmed for Shuttle experiment definition in FY 1975; the category was changed in the FY 1977 estimate.

<sup>b</sup>Includes \$1 500 000 for the transition quarter.

<sup>c</sup>As of the FY 1977 budget estimate, the general category for Shuttle experiment definition was dropped; funds for Shuttle experiments were divided among the various programs.

<sup>d</sup>Includes \$800 000 for environmental quality monitoring Spacelab payload development and \$1 200 000 for communications Spacelab payload development.

<sup>e</sup>Includes \$1 000 000 for Earth resources detection and monitoring Shuttle/Spacelab payload development; \$800 000 for environmental quality monitoring Shuttle/Spacelab payload development; and \$700 000 for communications Shuttle/Spacelab payload development.

<sup>f</sup>Includes \$5 700 000 for Earth resources detection and monitoring experiment for Shuttle/Spacelab; \$2 600 000 for environmental quality monitoring experiments for Shuttle/Spacelab; \$2 700 000 for weather and climate observations and forecasting experiments for Shuttle/Spacelab; and \$2 200 000 for communications experiments for Shuttle/Spacelab.

<sup>g</sup>Includes \$3 620 000 for resources observations Shuttle/Spacelab payload development; \$6 040 000 for environmental observations Shuttle/Spacelab payload development; \$2 240 000 for applications systems Shuttle/Spacelab mission design and integration; and \$1 000 000 for communications Shuttle/Spacelab payload development.

Table 4-64. Supporting Research and Technology/Advanced Studies Funding History  
(in thousands of dollars)

Year	Request	Authorization	Programmed
1969	23 800 <sup>a</sup>	---	19 600 <sup>a</sup>
1970	22 400 <sup>a</sup>	22 400 <sup>a</sup>	24 479 <sup>a</sup>
1971	25 900 <sup>a</sup>	25 900 <sup>a</sup>	28 744 <sup>a</sup>
1972	25 100 <sup>a</sup>	25 100 <sup>a</sup>	15 594 <sup>b</sup>
1973	22 000 <sup>a</sup>	23 000 <sup>a</sup>	15 286 <sup>c</sup>
1974	20 900 <sup>d</sup>	---	21 954 <sup>e</sup>
1975	34 650 <sup>a</sup>	---	72 959 <sup>g</sup>
1976	48 300 <sup>h</sup>	---	77 230 <sup>i</sup>
1977	79 900 <sup>j</sup>	---	92 019 <sup>k</sup>
1978	90 800 <sup>l</sup>	---	95 868 <sup>m</sup>

<sup>a</sup> Includes studies in the fields of communications, Earth resources, geodesy, meteorology, and navigation. Traffic management was added in FY 1973. As of FY 1974, advanced research and technology funds were divided among the various programs.

<sup>b</sup> Includes \$412 000 for design and development of advanced experimental meteorological instruments; \$4 614 000 for advanced techniques in weather observing and forecasting; \$1 978 000 for environmental sensor definition and feasibility evaluation; \$427 000 for design and development of advanced experimental Earth resources instruments; \$261 000 for design and development of advanced experimental geodesy instruments; \$1 102 000 for geodesy measurement systems and forecasting techniques; \$909 000 for design and development of advanced experimental communications instruments; and \$5 500 000 for communications systems techniques and technology.

<sup>c</sup> Includes \$4 400 000 for advanced techniques in weather observing and forecasting; \$2 300 000 for pollution monitoring sensor definition and feasibility evaluations, modeling, and operational methodology; \$1 859 000 for Earth and ocean physics measurement systems, forecasting techniques, and modeling advanced studies; \$2 033 000 for communications systems technology and techniques; and \$4 694 000 for advanced applications experiment studies.

<sup>d</sup> Includes \$500 000 for design and development of advanced experimental meteorology instruments; \$5 700 000 for advanced techniques in weather observations and forecasting; \$2 700 000 for environmental sensor definition and feasibility evaluation; \$1 600 000 for design and development of advanced experimental Earth resources instruments; \$400 000 for design and development of advanced experimental geodesy instruments; \$2 700 000 for geodesy measurement systems and forecasting techniques; \$3 100 000 for space processing advanced experiment definition and development (formerly funded under Space Flight Operations); and \$2 000 000 for applications studies.

<sup>e</sup> Includes \$4 828 000 for weather and climate advanced techniques in observing and forecasting; \$2 796 000 for pollution monitoring sensor definition and feasibility evaluations, modeling, and operational methodology; \$3 000 000 for Earth and ocean physics measurement systems, forecasting techniques, and modeling advanced studies; \$2 825 000 for space processing; \$2 540 000 for communications technology consultation and support studies; \$4 700 000 for advanced applications flight experiments; and \$1 265 000 for applications systems analyses.

<sup>f</sup> Includes \$5 000 000 for advanced techniques in weather observing and forecasting; \$2 800 000 for pollution monitoring sensor definition and feasibility evaluations, modeling, and operations methodology; \$2 000 000 for tectonic plate motion study; \$2 600 000 for Earth and ocean physics measurement systems, forecasting techniques, and modeling advanced studies; \$3 500 000 for space processing; \$2 000 000 for energy applications; \$1 650 000 for communications technology consultation and support studies; \$1 400 000 for advanced communications research; \$4 000 000 for data management; \$4 700 000 for advanced applications experiment studies; and \$5 000 000 for applications systems analysis.

<sup>g</sup> Includes \$32 209 000 for Earth resources detection and monitoring applications research and technology development; \$1 900 000 for tectonic plate motion study; \$4 800 000 for applications research and technology development; \$5 600 000 for ocean condition monitoring and forecasting applications research and technology development; \$7 400 000 for environmental quality monitoring applications research and technology development; \$9 000 000 for weather and climate observations and forecasting applications research and technology development; \$4 600 000 for materials processing;

Table 4-64. Supporting Research and Technology/Advanced Studies Funding History  
(in thousands of dollars) (Continued)

\$1 650 000 for communications technology consultation and support studies; \$2 600 000 for communications applications research and technology development; \$3 200 000 for information management.

<sup>h</sup>Includes \$8 100 000 (\$2 400 000 for the transition quarter) for advanced techniques in weather observing and forecasting; \$5 400 000 (\$1 200 000 for the transition quarter) for pollution sensor definition and feasibility evaluations, modeling, and operational methodology; \$3 400 000 (\$800 000 for the transition quarter) for tectonic plate motion study; \$4 000 000 (\$900 000 for the transition quarter) for Earth and ocean physics measurement systems, forecasting techniques, and modeling advanced studies; \$4 900 000 (\$1 200 000 for the transition quarter) for space processing; \$2 700 000 (\$600 000 for the transition quarter) for communications technology consultation and support studies; \$1 900 000 (\$500 000 for the transition quarter) for advanced communications research; \$5 500 000 (\$1 500 000 for transition quarter) for data management; \$6 400 000 (\$1 400 000 for the transition quarter) for applications systems analyses; and \$6 000 000 (\$1 300 000 for the transition quarter) for advanced applications flight experiments.

<sup>i</sup>Includes \$32 100 000 for Earth resources detection and monitoring applications research and technology development; \$2 600 000 for tectonic plate motion study; \$3 300 000 for Earth dynamics monitoring and forecasting applications research and technology development; \$4 800 000 for ocean condition monitoring and forecasting applications research and technology development; \$9 000 000 for environmental quality monitoring applications research and technology development; \$12 030 000 for weather and climate observations and forecasting applications research and technology development; \$5 900 000 for materials processing; \$2 100 000 for communications technology consultation and support studies; and \$5 400 000 for communications applications research and technology development.

<sup>j</sup>Includes \$32 500 000 for Earth resources detection and monitoring applications research and technology development; \$1 900 000 for tectonic plate motion study; \$1 300 000 for applications research and technology development; \$3 500 000 for ocean condition monitoring and forecasting applications research and technology development; \$9 900 000 for environmental quality monitoring applications research and technology development; \$13 000 000 for weather and climate observations and forecasting applications research and technology development; \$9 200 000 for materials processing; \$2 600 000 for communications technology consultation and support studies; \$2 800 000 for communications applications research and technology development; and \$3 200 000 for information management.

<sup>k</sup>Includes \$53 162 000 for Earth resources detection and monitoring applications research and technology development; \$1 890 000 for tectonic plate motion study; \$1 625 000 for Earth dynamics monitoring and forecasting applications research and technology development; \$1 100 000 for ocean condition monitoring and forecasting applications research and technology development; \$7 901 000 for environmental quality monitoring applications research and technology development; \$7 099 000 for global weather program support; \$600 000 for climate research applications research and technology development; \$8 090 000 for materials processing; \$2 550 000 for communications technology consultation and support studies; and \$8 002 000 for communications applications research and technology development.

<sup>l</sup>Includes \$32 000 000 for Earth resources detection and monitoring applications research and technology development; \$2 200 000 for tectonic plate motion study; \$3 800 000 for Earth dynamics monitoring and forecasting applications research and technology development; \$5 000 000 for ocean condition monitoring and forecasting applications research and technology development; \$9 200 000 for environmental quality monitoring applications research and technology development; \$11 900 000 for weather and climate observations and forecasting applications research and technology development; \$15 500 000 for materials processing; \$3 100 000 for communications technology consultation and support studies; \$900 000 for communications applications transfer and demonstration program; and \$7 200 000 for communications applications research and technology development.

<sup>m</sup>Includes \$6 940 000 for tectonic plate (geodynamics) study; \$29 630 000 for resource observations applications research and data analysis; \$5 600 000 for environmental observations operational satellite improvement program (advanced research and development); \$29 298 000 for environmental observations applications research and data analysis; \$2 000 000 for applications systems data management; \$3 100 000 for space communications technology consultation and support studies; \$5 650 000 for space communications applications research and data analysis; and \$13 650 000 for materials processing.

## CHARACTERISTICS

The rest of this chapter describes NASA's four major applications programs and the flight projects assigned to them.\* For each flight project, the researcher will find an introductory narrative, a chronology of events, and mission profile sheets.

### Meteorology Program

During its second decade, NASA conducted advanced research and development activities in the field of meteorology and served as launch vehicle manager for the National Oceanic and Atmospheric Administration's fleet of operational satellites. In addition, the space agency was an active participant in the Global Atmospheric Research Program, an international meteorological research effort. GARP and NASA's major meteorology flight projects, Tiros, SMS, and Nimbus, are described below.

Morris Tepper was NASA's director of meteorology from 1961 through 1977. From mid-1969, meteorology was part of the NASA Headquarters Earth Observations Program (changed to Environmental Observations Program in late 1977). Assisting Tepper was William G. Spreen, chief of meteorology and sounding rockets through 1971, when Norman L. Durocher took the post. Durocher, who had been manager of GARP since 1970, turned the research program over to Robert A. Schiffer, who was succeeded by T. H. R. O'Neil in 1974. Schiffer became chief of environmental quality. In the November 1977 agency-wide reorganization, meteorology was assigned to the atmospheric processes branch, Shelby G. Tilford, chief. Michael L. Garbacz was long-time manager of operational meteorology satellites. (For more information, see table 4-2.)

**Tiros Family.** NASA inherited the Tiros (Television Infrared Observation Satellite) concept from the Advanced Research Projects Agency (ARPA) in 1958 when the space agency was created. Ten research and development launches of this successful weather satellite led to the first Tiros Operational System (TOS) mission (*ESSA 1*) in 1966. The Environmental Science Services Administration (ESSA) was responsible for the operational system, while NASA provided a launching capability and advanced research on improved Tiros spacecraft. First-generation Tiros spacecraft carried two-camera advanced vidicon camera systems (AVCS), which took 6 or 12 images per orbit at 260-second intervals, which were stored on tape recorders for transmission to the National Environmental Satellite Center; or automatic picture transmission (APT) systems, which allowed the transmission of real-time cloud cover pictures to any APT ground receiver within audio range of the satellite (4 AVCS versions; 5 APT versions). NASA's second decade began with the last launch of the TOS series, *ESSA 9*, in February 1969.

---

\*Only those missions actually flown during 1969-78 are considered. Several applications projects that received their funding and research start in this decade but had not reached flight-ready status by the close of 1978 will be included in a future volume.



*Tiros M* was an operational prototype of an Improved Tiros Operational System (ITOS). This second-generation satellite was box-like, while the first Tiros satellites had been drum-shaped. It weighed 400 kilograms, twice as much as the early Tiros spacecraft; and it carried two AVCSs, two APTs, and two scanning radiometers. And NASA included increasingly sophisticated instruments on the NOAA 1-5 spacecraft which made up ITOS. NOAA 1, launched on December 11, 1970, was identical to its R&D predecessor, but NOAA 2 (October 15, 1972) was equipped with a very high-resolution radiometer (VHRR) that provided images from which the temperature of the cloud tops and the land areas below could be determined, a vertical temperature profile radiometer, and a scanning radiometer. To NOAA 3, 4, and 5 (November 6, 1973; November 15, 1974; and July 29, 1976) a solar proton monitor was added. A new attitude control system ensured that NOAA spacecraft would always face earth (the original Tiros was spin stabilized). Operating in sun-synchronous orbits, these spacecraft provided systematic cloud cover observation for the National Oceanic and Atmospheric Administration (formerly ESSA).

In October 1978, NASA launched another Tiros prototype, *Tiros N*. This newest member of the Tiros family again took a new configuration. It was pentagonal, weighing 1405 kilograms. Along with its new face, it was given a new job—longer-range forecasting, which would be accomplished by surroundings rather than by image-taking. For 29 months, meteorologists monitored *Tiros N*'s 7 instruments.

Tiros spacecraft were provided by RCA Astro-Electronics Division under contract to the Goddard Space Flight Center. RCA started an in-house weather satellite study in 1951 and worked for first the Army Ballistic Missile Agency, then ARPA, and finally NASA to design and fabricate the first Tiros satellite. *Tiros N* was based on an RCA-U.S. Air Force spacecraft design called Block 5D.

At Goddard, the Tiros project was managed in the projects directorate by William W. Jones (*ESSA 9-NOAA 2*), Jack Sargent (*NOAA 3*), Stanley Weiland (*NOAA 4*), and Gilbert A. Branchflower (*NOAA 5-Tiros N*). At NASA Headquarters, Michael L. Garbacz was long-time manager of the operational meteorology satellite program.

Delta launch vehicles of various configurations were used to launch all the second-decade Tiros satellites except *Tiros N*. This large spacecraft was orbited by an Atlas F vehicle.

Table 4-65. Chronology of Tiros Development and Operations

Date	Event
Late 1965	GSFC awarded RCA Astro-Electronics Division a study contract for a second-generation TOS.
June 1966	Tiros J was cancelled and replaced by Tiros M, a new-generation satellite.
Nov. 5, 1966	NASA announced that it would negotiate with RCA for a design of an improved Tiros (Tiros M); it would be larger and stabilized so that it always faced Earth.
Feb. 1967	The Tiros M design study was completed.
Apr. 25, 1967	NASA awarded RCA a contract for Tiros M and three follow-on operational spacecraft.
May 11, 1967	GSFC issued an RFP for the VHRR; proposals were due in June. Rather than procure Nimbus-type instruments at a higher cost from IT&T, NASA chose a proposal submitted by Santa Barbara Research Center.
Nov. 4, 1967	A Tiros M design review was concluded at RCA with no major topics left unsatisfactory.
Oct. 1968	Fabrication of Tiros M was completed.
Feb. 26, 1969	<i>ESSA 9</i> was launched successfully.
Jan. 23, 1970	<i>Tiros M</i> was launched successfully; operations were turned over to NOAA in June.
Dec. 11, 1970	<i>NOAA 1</i> was launched successfully.
May 8, 1971	A Tiros N project approval document was signed at NASA Headquarters.
Oct. 21, 1971	The launch of ITOS B failed because of a launch vehicle failure.
Oct. 15, 1972	<i>NOAA 2</i> was launched successfully.
July 16, 1973	The launch of ITOS E failed because of a launch vehicle failure.
Nov. 6, 1973	<i>NOAA 3</i> was launched successfully.
Feb. 1974	The Office of Management and Budget approved Tiros N.
June 7, 1974	GSFC initiated a Tiros N design study.
Aug. 9, 1974	NASA awarded a contract to RCA for two more ITOS spacecraft and parts for a third to be used by NOAA.
Nov. 15, 1974	<i>NOAA 4</i> was launched successfully.
Dec. 10, 1974	France's Centre National d'Etudes Spatiales agreed to design and build a data collection system for Tiros N.
Feb. 1975	A request for proposals was issued for a Tiros N spacecraft.
Oct. 21, 1975	NASA awarded a contract to RCA for eight Tiros N-type spacecraft (long lead-time contracts had been let in April).
Oct. 27, 1975	The Department of Commerce awarded a contract to Aeronutronic Ford to build a space environment monitoring system for Tiros N.
July 7, 1976	GSFC awarded a contract to IT&T Aerospace Optical Division to modify the HIRS carried on Nimbus G for Tiros N.
July 29, 1976	<i>NOAA 5</i> was launched successfully.
Oct. 19, 1976	GSFC awarded a contract to RCA for Tiros N spacecraft integration.
Oct. 13, 1978	<i>Tiros N</i> was launched successfully; operations were turned over to NOAA in November. The satellite was turned off on February 21, 1981.

Table 4-66. ESSA 9 Characteristics

---

Also called: TOS-G  
 Date of launch (location): Feb. 26, 1969 (ETR)  
 Launch vehicle: Delta E  
 Weight (kg): 157  
 Shape: Cylindrical  
 Dimensions (m): 1.07, diameter  
                   0.57, height  
 Power source: solar cells plus NiCd batteries  
 Responsible NASA center: Goddard Space Flight Center  
 Prime contractor: RCA  
 Project manager: William W. Jones  
 Objectives: Operational meteorological satellite (global cloud cover information); ESSA project.  
 Equipment: 2 Automatic Vidicon Camera Systems (AVCS)  
 Results: Successful; last of TOS series; launched in response to failure of one of *ESSA 7's* cameras.

---

Reference: NASA, "ESSA 9 Mission Operations Report," S-602-69-10, Dec. 2, 1969

Table 4-67. ITOS 1 Characteristics

---

Also called: Tiros M  
 Date of launch (location): Jan. 23, 1970 (WTR)  
 Launch vehicle: Delta N-6  
 Weight (kg): 309  
 Shape: cubical with three solar panels  
 Dimensions (m):  $1 \times 1 \times 1.2$  (main body)  
 Power source: solar panels plus NiCd batteries  
 Responsible NASA center: Goddard Space Flight Center  
 Prime contractor: RCA  
 Project manager: William W. Jones  
 Spacecraft manager: Charles M. Hunter  
 Objectives: Evaluate operational prototype of second-generation Improved TIROS satellite.  
 Equipment: 2 AVCS  
               2 Automatic Picture Transmission systems (APT)  
               2 Scanning Radiometers (SR)  
 Results: Successful; turned over to NOAA in June 1970 (project funded by NASA). Launched with *Oscar 5* amateur radio operators satellite.

---

Reference: NASA, "ITOS 1 Mission Operations Report," S-601-69-10, Dec. 22, 1969

Table 4-68. NOAA 1 Characteristics

---

Also called: ITOS-A  
 Date of launch (location): Dec. 11, 1970 (WTR)  
 Launch vehicle: Delta N-6  
 Weight (kg): 409  
 Shape: Cubical with three solar panels  
 Dimensions (m): 1 × 1 × 1.2 (main body)  
 Power source: solar cells plus NiCd batteries  
 Responsible NASA center: Goddard Space Flight Center  
 Prime contractor: RCA  
 Project manager: William W. Jones  
 Objectives: Operational NOAA meteorology satellite operating in Sun-synchronous orbit (provide systematic cloud-cover observations)  
 Equipment: 2 (AVCS)  
               2 APT  
               2 SR  
 Results: Successful; (second-generation improved TIROS series; Tiros M-type). Launched with a secondary payload—CEPE (Cylindrical Electrostatic Probe Experiment), designed to obtain data on electron density and temperature and ion current.

---

Table 4-69. ITOS B Characteristics

---

Would have been called: NOAA 2  
 Date of launch (location): Oct. 21, 1971 (WTR)  
 Launch vehicle: Same as NOAA 1  
 Weight (kg): Same as NOAA 1  
 Shape: Same as NOAA 1  
 Dimensions (m): Same as NOAA 1  
 Power source: Same as NOAA 1  
 Responsible NASA center: Same as NOAA 1  
 Project manager: Same as NOAA 1  
 Objectives: Same as NOAA 1  
 Equipment: 2 APT  
               2 AVCS  
               2 SR  
               Solar Proton Monitor (SPM)  
               Flat Plate Radiometer  
 Results: Unsuccessful because of launch vehicle second-stage oxidizer system gas leak; orbit not achieved.

---

Table 4-70. NOAA 2 Characteristics

---

Also called: ITOS-D  
 Date of launch (location): Oct. 15, 1972 (WTR)  
 Launch vehicle: Delta 0300  
 Weight (kg): Same as NOAA 1  
 Shape: Same as NOAA 1  
 Dimensions (m): Same as NOAA 1  
 Power source: Same as NOAA 1  
 Responsible NASA center: Same as NOAA 1  
 Prime contractor: Same as NOAA 1  
 Project manager: Same as NOAA 1  
 Objectives: Same as NOAA 1, plus take pictures from which the temperature of the cloud tops and land areas can be determined  
 Equipment: Very High Resolution Radiometer (VHRR)  
               Vertical Temperature Profile Radiometer (VTPR)  
               SR  
 Results: Successful.

---

Reference: NASA, "NOAA 2 Mission Operations Report," E-601-72-13, Oct. 3, 1972

Table 4-71. ITOS-E Characteristics

---

Would have been called: NOAA 3  
 Date of launch (location): July 16, 1973 (WTR)  
 Launch vehicle: Delta 0330  
 Weight (kg): Same as NOAA 1  
 Shape: Same as NOAA 1  
 Dimensions (m): Same as NOAA 1  
 Power source: Same as NOAA 1  
 Responsible NASA center: Same as NOAA 1  
 Prime contractor: Same as NOAA 1  
 Project manager: Jack Sargent  
 Objectives: Same as NOAA 1  
 Equipment: VHRR  
               VTRR  
               SR  
               SPM  
 Results: Unsuccessful; second stage of launch vehicle failed 270 seconds after ignition; did not achieve orbital velocity.

---

Table 4-72. NOAA 3 Characteristics

---

Also called: ITOS-F  
 Date of launch (location): Nov. 6, 1973 (WTR)  
 Launch vehicle: Delta 0330  
 Weight (kg): Same as NOAA 1  
 Shape: Same as NOAA 1  
 Dimensions (m): Same as NOAA 1  
 Power source: Same as NOAA 1  
 Responsible NASA center: Same as NOAA 1  
 Prime contractor: Same as NOAA 1  
 Project manager: Jack Sargent  
 Objectives: Same as NOAA 1  
 Equipment: VHRR  
               VTRR  
               SR  
               SPM  
 Results: Successful.

---

Reference: NASA, "NOAA 3 Mission Operations Report," E-601-73-15, Oct. 2, 1973

Table 4-73. NOAA 4 Characteristics

---

Also called: ITOS-G  
 Date of launch (location): Nov. 11, 1974 (WTR)  
 Launch vehicle: Delta 2310  
 Weight (kg): Same as NOAA 1  
 Shape: Same as NOAA 1  
 Dimensions (m): Same as NOAA 1  
 Power source: Same as NOAA 1  
 Responsible NASA center: Same as NOAA 1  
 Prime contractor: Same as NOAA 1  
 Project manager: Same as NOAA 1  
 Objectives: Same as NOAA 1  
 Equipment: VHRR  
               VTRR  
               SR  
               SPM  
 Results: Successful.

---

Reference: NASA, "NOAA 4 Mission Operations Report," E-601-74-16, Oct. 18, 1974

Table 4-74. NOAA 5 Characteristics

---

Also called: ITOS-H  
 Date of launch (location): July 29, 1976 (WTR)  
 Launch vehicle: Delta 2310  
 Weight (kg): Same as NOAA 1  
 Shape: Same as NOAA 1  
 Dimensions (m): Same as NOAA 1  
 Power source: Same as NOAA 1  
 Responsible NASA center: Same as NOAA 1  
 Prime contractor: Same as NOAA 1  
 Project manager: Gilbert A. Branchflower  
 Objectives: Same as NOAA 1  
 Equipment: VHRR  
               VTRR  
               SR  
               SPM  
 Results: Successful.

---

Reference: NASA, "NOAA 5 Mission Operations Report," E-601-76-17, July 28, 1976

Table 4-75. Tiros N Characteristics

---

Also called: NOAA-A, Operational Temperature Sounding Satellite, Television Infrared Observations Satellite N  
 Date of launch (location): Oct. 13, 1978 (WTR)  
 Launch vehicle: Atlas F  
 Weight (kg): 1405  
 Shape: Pentagonal with instruments mounted from the two ends and a solar panel extending from a boom on one end  
 Dimensions (m): 3.71 height  
                   1.88 diameter  
 Power source: Solar panel plus NiCd batteries  
 Responsible NASA center: Goddard Space Flight Center  
 Prime contractor: RCA  
 Project manager: Gilbert A. Branchflower  
 Spacecraft manager: W. Peacock  
 Objectives: Evaluate operational prototype of third-generation meteorology satellite (14-month lifetime); participate in GARP.  
 Equipment: Tiros Operational Vertical Sounder  
               High-Resolution Infrared Radiation Sounder  
               Stratospheric Sounding Unit  
               Microwave Sounding Unit  
               Advanced VHRR  
               Space Environment Monitor  
               Total Energy Detector  
               Medium-Energy Proton and Electron Detector  
               High-Energy Proton and Electron Detector  
               Data Collection System (Random-Access)  
 Results: Successful; NOAA assumed operational control of the satellite on Nov. 6, 1978; it was turned off on Feb. 21, 1981.

---

Reference: NASA, "Tiros N Mission Operations Report," E-614-78-01, Oct. 1, 1978

**Synchronous Meteorological Satellite—GOES.** The advantage of the Synchronous Meteorological Satellite (SMS) over the Tiros NOAA satellites was its ability to provide daytime and nighttime coverage from geostationary orbit. For the first time, the meteorologist had access to an entire hemisphere around the clock.

NASA funded and managed the SMS project, but when the concept was found satisfactory for an operational system, the National Oceanic and Atmospheric Administration assumed responsibility for it. The NOAA satellites, identical to *SMS 1* and *2*, launched on May 17, 1974 and February 6, 1975, were named GOES, for Geostationary Operational Environmental Satellite. Three operational GOES satellites were put to use as part of the National Operational Meteorology Satellite System:\* *GOES 1* on October 16, 1975, *GOES 2* on June 16, 1977, and *GOES 3* on June 16, 1978.

SMS-GOES, cylindrical and weighing 600 kilograms, had three distinct capabilities. (1) Images collected by the visible and infrared spin scan radiometer (VISSR) were of a high quality: daytime resolution down to 3.2 kilometers and nighttime infrared resolution of 9 kilometers could be achieved (see fig. 4-1). (2) With its data collection system (DCS), the spacecraft could randomly query some 10 000 remote earth-based sensors located on such platforms as ships, buoys, and forest fire observation stations. Useful information on earthquakes, winds, rainfall, humidity, temperature, and water levels was thus obtained. (3) The space environment monitoring system was composed of three instruments: a magnetometer, x-ray sensor, and energetic particles sensor.

Satellite data were sent to NOAA's Command and Data Acquisition Station, Wallops Island, Virginia, where the signals were converted to a useable photographic form. This information was retransmitted to the NOAA Center, Suitland, Maryland. From Suitland, data were sent over high-quality telephone lines to five regional weather centers (Miami, San Francisco, Kansas City, Washington, and Honolulu). The regional centers forwarded information, including enlargements of weather photos, to all Weather Service Forecast Offices. Offices received updated photographs every 30 minutes.

An operational weather satellite in synchronous orbit had been an objective of the meteorological community since the first weather satellite was launched in the early 1960s, and ESSA assigned high priority to the establishment of an operational system of geostationary satellites in 1969. NASA first proposed SMS in its FY 1970 budget, but the project soon ran into schedule, money, and weight-gain problems. According to Deputy Administrator George M. Low, "the introduction of a number of advanced features at various points during the definition phase of the program established satisfactory technical approaches but resulted in an inadequate definition of the effort required."<sup>6</sup> The first flight-ready SMS model was not delivered until the spring of 1973; the first launch followed one year later.

SMS-GOES spacecraft were built for the government by Philco-Ford Corporation under contract to GSFC. Part of the projects directorate, SMS-GOES was under the direction of Don V. Fordyce (SMS) and Robert H. Pickard (GOES).

---

\*The National Operational Environmental Satellite System (NOESS) was established in 1966 for the continuous observation of the atmosphere on an operational basis.



Michael L. Garbacz was NASA Headquarters manager of the operational meteorology satellite program.

Delta model 2914 was used to launch these five satellites. All launches took place at the Eastern Test Range.

Table 4-76. Chronology of SMS-GOES Development and Operations

Date	Event
Feb. 1, 1963	GSFC awarded a four-month contract to Republic Aviation Corp. for an overall study of SMS requirements.
Apr. 22, 1963	GSFC awarded a four-month study contract to RCA to determine how Tiros camera technology could be applied to SMS. A four-month study contract was also awarded to Hughes Aircraft Co. to determine how Syncom technology could be applied to SMS.
Nov. 18, 1963	At an in-house presentation at GSFC, participants reviewed the findings of the three study contracts. From this review, an SMS program proposal was prepared.
Jan. 30, 1964	NASA and Department of Commerce representatives signed an Agreement for Operational Meteorological Satellites.
June 1966	GSFC completed an in-house "Synchronous Operational Meteorological Satellite Feasibility Study," a phase A study.
Apr. 1969	NASA announced that SMS would use the ATS spin scan cameras.
June 3, 1969	NASA held a briefing on SMS for ESSA.
Jan. 1970	GSFC completed an in-house phase B SMS study.
Feb. 3, 1970	ESSA sent its requirements for SMS to NASA.
Feb. 13, 1970	GSFC released an RFP for an SMS spacecraft; proposals were due in April.
Apr. 9, 1970	A project approval document for SMS was approved at NASA Headquarters.
June 24, 1970	NASA agreed to ESSA's requirements for SMS.
July 1970	NOAA approved of the SMS Project Plan.
July 24, 1970	NASA awarded a contract to Philco-Ford to develop the SMS spacecraft. The first launch was scheduled for 1972. The contract called for three spacecraft, the third to serve as the first GOES spacecraft.
Jan. 10, 1971	Philco-Ford's contract was definitized.
June 1971	The SMS spacecraft design was executed.
July 1972	Philco-Ford began fabrication of a qualification model SMS spacecraft. The first launch was now scheduled for October 1973.
May 1973	The first SMS flight model was delivered to NASA.
May-July 1973	NASA and Department of Commerce representatives signed an agreement concerning operational environmental satellite systems.
Oct. 24, 1973	GSFC awarded Philco-Ford a contract for two more GOES spacecraft for a total of three.
May 17, 1974	<i>SMS 1</i> was launched successfully; it was operational until January 1976; it was boosted out of orbit in January 1981.
Feb. 6, 1975	<i>SMS 2</i> was launched successfully; it was moved to a different location in December 1975.
Oct. 16, 1975	<i>GOES 1</i> was launched successfully; it was moved during the summer of 1978 to support GARP.
Nov. 1975	GSFC solicited letters of interest from contractors interested in building a follow-on GOES spacecraft.
June 16, 1977	<i>GOES 2</i> was launched successfully.
June 16, 1978	<i>GOES 3</i> was launched successfully.

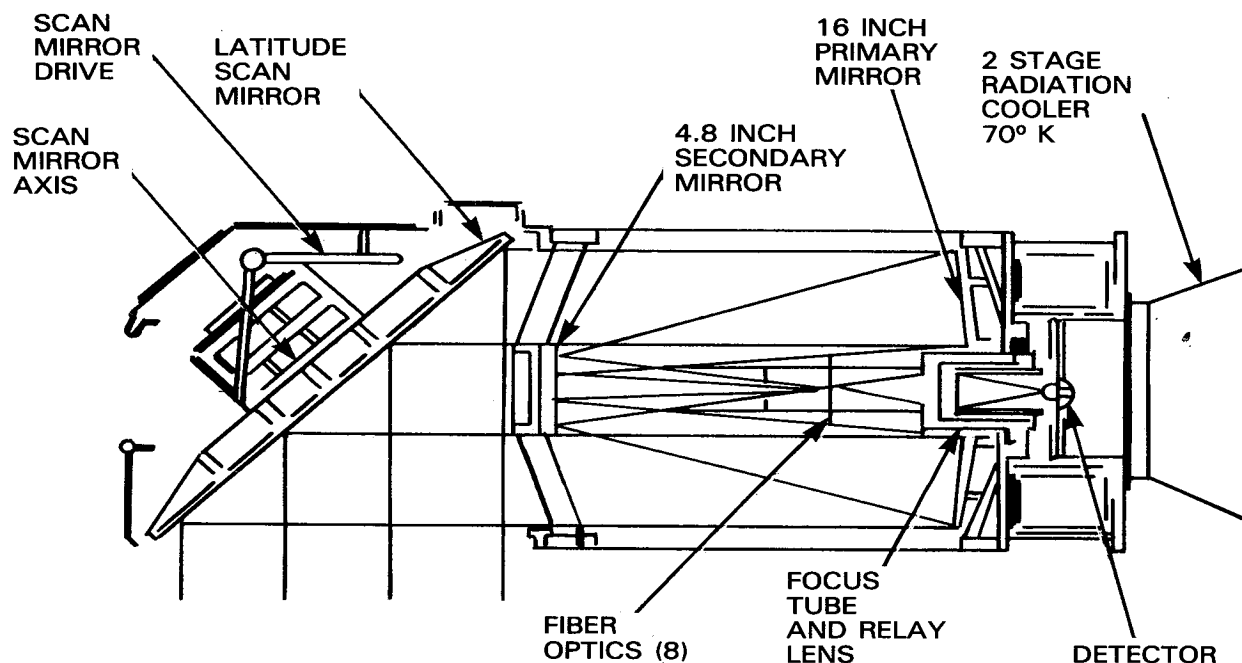

Figure 4-1. Video data are generated on SMS-GOES by a visible and infrared spin scan radiometer. Its major parts include a telescope (Ritchey-Chretien version of the classical cassegrainian telescope), a radiometer (8 channels for visible scan operations in the 0.55- to 0.80-micron band and 2 for infrared scan in the 10.5- to 12.6-micron band), an optical line step scanner, and an electronics module.

Source: NASA, Synchronous Meteorological Satellite, A Mission Operation Report, E-608-74-01, May 10, 1974.

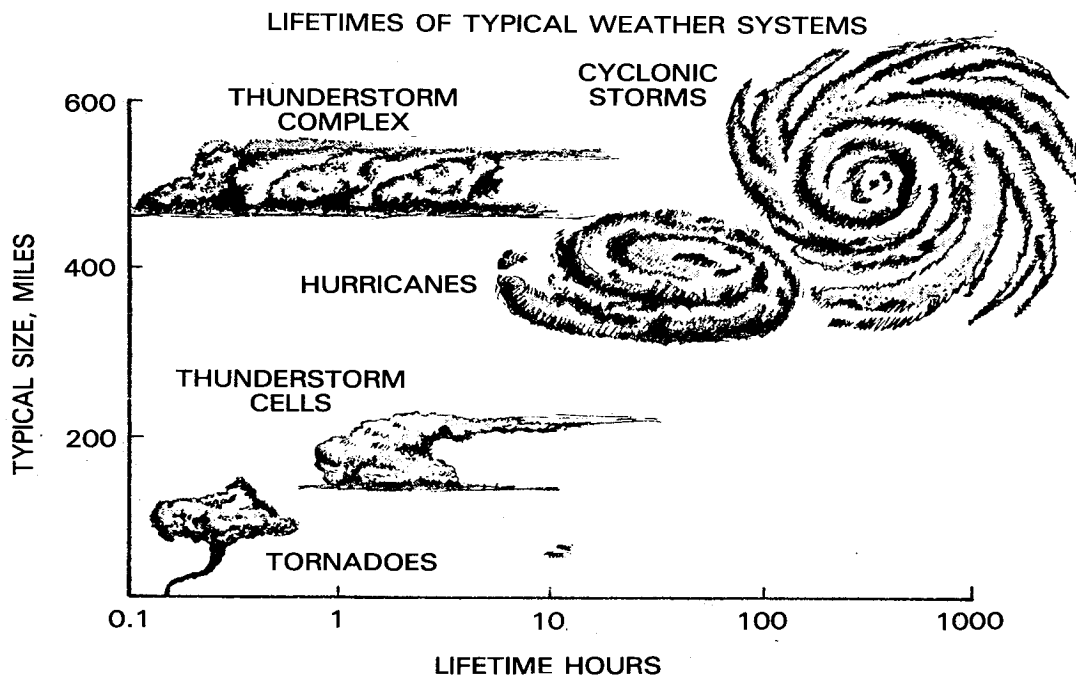

Figure 4-2. Access to remote sensors and 24-hour observations gave meteorologists an opportunity to study weather systems, even short-duration tornadoes and thunderstorms.

Source: NASA, OSSA, "Summary of the Synchronous Meteorological Satellite Program," March 1967, p. 3.

Table 4-77. SMS 1 Characteristics

---

Also called: Synchronous Meteorological Satellite  
 Date of launch (location): May 17, 1974 (ETR)  
 Launch vehicle: Delta 2914  
 Weight (kg): 628  
 Shape: cylindrical with magnetometer mounted on one end  
 Dimensions (m): 1.91 diameter  
                   2.30 height  
 Power source: Solar cells plus NiCd batteries  
 Responsible NASA center: Goddard Space Flight Center  
 Prime contractor: Philco-Ford Corp.  
 Project manager: Don V. Fordyce  
 Objectives: Evaluate prototype operational meteorological satellite for the National Weather Service of the National Oceanic and Atmospheric Administration; for one year SMS 1 should provide regular daytime and nighttime meteorological observations in support of the national operational meteorological satellite system.  
 Equipment: Visible and Infrared Spin Scan Radiometer (VISRR)  
               Data Collection System (DCS)  
 Results: Successful; first geostationary meteorological satellite; was operational until Jan. 1976; boosted out of orbit Jan. 1981.

---

Reference: NASA, "SMS 1 Mission Operations Report," E-608-74-01, May 10, 1974.

Table 4-78. SMS 2 Characteristics

---

Also called: Synchronous Meteorological Satellite  
 Date of launch (location): Feb. 6, 1975 (ETR)  
 Launch vehicle: Delta 2914  
 Weight (kg): 628  
 Shape: cylindrical with magnetometer mounted on one end  
 Dimensions (m): 1.91 diameter  
                   2.30 height  
 Power source: Solar cells plus NiCd batteries  
 Responsible NASA center: Goddard Space Flight Center  
 Prime contractor: Philco-Ford Corp.  
 Project manager: Don V. Fordyce  
 Objectives: Same as SMS 1.  
 Equipment: Visible and Infrared Spin Scan Radiometer (VISSR)  
               Data Collection System (DCS)  
 Results: Successful; moved to alternate location in Dec. 1975.

---

Reference: NASA, "SMS 1 Mission Operations Report," E-608-75-02, Jan. 9, 1975.

Table 4-79. GOES 1 Characteristics

---

Also called: Geostationary Operational Environmental Satellite; SMS-C  
 Date of launch (location): Oct. 16, 1975 (ETR)  
 Launch vehicle: Delta 2914  
 Weight (kg): 294  
 Shape: cylindrical  
 Dimensions (m): 2.30 height; 3.45 including 83-cm magnetometer  
                   1.91 diameter  
 Power source: Solar cells plus NiCd batteries  
 Responsible NASA center: Goddard Space Flight Center  
 Prime contractor: Philco-Ford  
 Project manager: Robert H. Rickard  
 Objectives: Three-year operational meteorological satellite; replace SMS in providing capability for  
             continuous observation of the atmosphere.  
 Equipment: VISSR  
             DCS  
 Results: Successful; first of a series of six GOES satellites; moved during the summer of 1978 to sup-  
           port GARP.

---

Reference: NASA, "GOES 1 Mission Operations Report," E-608-75-03, Sept. 22, 1975.

Table 4-80. GOES 2 Characteristics

---

Also called: Geostationary Operational Environmental Satellite  
 Date of launch (location): June 16, 1977 (ETR)  
 Launch vehicle: Delta 2914  
 Weight (kg): 294  
 Shape: cylindrical  
 Dimensions (m): 2.30 height; 3.45 including 83-cm magnetometer  
                   1.91 diameter  
 Power source: Solar cells plus NiCd batteries  
 Responsible NASA center: Goddard Space Flight Center  
 Prime contractor: Philco-Ford  
 Project manager: Robert H. Rickard  
 Objectives: Three-year operational meteorological satellite.  
 Equipment: VISSR  
             DCS  
 Results: Successful.

---

Reference: NASA, "GOES 2 Mission Operations Report," E-608-77-04, May 24, 1977.

Table 4-81. GOES 3 Characteristics

---

Also called: Geostationary Operational Environmental Satellite  
 Date of launch (location): June 16, 1978 (ETR)  
 Launch vehicle: Delta 2914  
 Weight (kg): 294  
 Shape: cylindrical  
 Dimensions (m): 2.30 height; 3.45, including 83-cm magnetometer  
                   1.91 diameter  
 Power source: Solar cells plus NiCd batteries  
 Responsible NASA center: Goddard Space Flight Center  
 Prime contractor: Philco-Ford  
 Project manager: Robert H. Rickard  
 Objectives: Three-year operational meteorological satellite.  
 Equipment: VISSR  
               DCS  
 Results: Successful.

---

Reference: NASA, "GOES 3 Mission Operations Report," E-612-78-01, May 19, 1978.

**Nimbus.** The Nimbus program, approved in 1959 as NASA's second-generation meteorology satellite program, was operationally successfully concluded in 1978 with the launch of the last of seven polar-orbiting satellites. However, data from *Nimbus 7* were still being received from the spacecraft's sophisticated instruments in the early 1980s. Nimbus was flown not as an operational satellite but as an advanced research satellite on which new sensing instruments and data-gathering techniques were tested. The Environmental Science Services Administration (ESSA), however, did become a routine user of Nimbus data. Its coverage of conditions over oceans and other areas where few upper atmospheric measurements were made was very valuable to the agency.

Shaped like a butterfly with solar-panel wings, the configuration of Nimbus changed little from its first use in 1964. What did evolve was the payload. The first meteorology satellites provided scientists with cloud pictures from which air movement could be determined and infrared data that reflected the temperature variations of the earth's surface. Instruments carried in *Nimbus 3* and *4* (launched April 14, 1969, and April 8, 1970) yielded vertical profiles of the temperatures in the atmosphere and information on the global distribution of ozone and water vapor. With each mission, these profiles were refined and extended. *Nimbus 4* demonstrated the feasibility of determining wind velocity fields by accurately tracking balloons. *Nimbus 5* (December 10, 1972) provided improved thermal maps of the earth. Environmental conditions such as sea ice cover and rainfall were monitored by *Nimbus 6* (June 12, 1975). *Nimbus 7* (October 24, 1978) also was called the "Air Pollution and Oceanographic Observing Satellite." In addition to mapping upper atmospheric characteristics, this last satellite of the series collected extensive data over the planet's oceans, extended scientists' solar and earth radiation data base, and monitored man-made and natural pollutants.<sup>7</sup>

An important Nimbus instrument for meteorologists was the temperature-humidity infrared radiometer (THIR), part of the payloads on *Nimbus 4-7*. THIR was a two-channel high-resolution scanning radiometer designed to perform two major functions: provide continuous day and night cloud top or surface temperatures, and provide information on the moisture content of the upper

troposphere and stratosphere and the location of jet streams and frontal systems. The THIR radiometer consisted of an optical scanner and an electronic module. In contrast to television, no images were formed within the radiometer; the THIR sensor merely transformed the received radiation into an electrical output (see fig. 4-3).

The random access measurement system (RAMS) on *Nimbus 6* generated many well publicized international experiments. In the early 1960s, the Committee on Atmospheric Sciences of the National Academy of Sciences established a Panel on International Meteorological Cooperation to study the feasibility of a global observation experiment to measure the state and motion of the entire lower atmosphere. The most promising system to accomplish this was a polar-orbiting satellite that would transmit data gathered by constant-level balloons and fixed or drifting buoys while making radiometer measurements in the infrared and microwave regions of the electromagnetic spectrum. The feasibility of locating and collecting data from balloons and floating platforms was proved by the interrogation, recording, and location system (IRLS) carried on *Nimbus 3* and *4* and by the French satellite *Eole*.<sup>\*</sup> The system developed for *Nimbus 6* did not require the complex interrogation function; the platforms would randomly transmit signals to the satellite.

NASA invited investigators from around the world to participate in a tropical wind, energy conversion, and reference level experiment (TWERLE), which would use constant-level balloons and ocean and ice buoys. A total of 393 TWERLE balloons was launched and tracked in 1975, which contained sensors for measuring atmospheric pressure, temperature, and altitude. In addition to TWERLE investigators, other parties using *Nimbus 6*'s RAMS included balloonists, scientists and oil drillers interested in iceberg drift, marine biologists, sailors, and participants of an around-the-world antique automobile race.<sup>8</sup>

*Nimbus* was built for NASA by the General Electric Company under contract to the Goddard Space Flight Center. Harry Press served as project manager and William Nordberg as project scientist during *Nimbus 3* and *4*. Stanley Weiland and John S. Theon took over for *Nimbus 5*, with Jack Sargent becoming manager for *Nimbus 6*. Ronald K. Browning and William R. Bandeen oversaw the last *Nimbus* flight. *Nimbus* was managed as part of Goddard's flight directorate. At NASA Headquarters, Richard I. Haley, Burton B. Schardt (*Nimbus 3-5*), Harry Mannheim (*Nimbus 6*), and Douglas R. Broome (*Nimbus 7*) had turns as program directors.

Thorad-Agena D vehicles launched *Nimbus 3* and *4* from the Western Test Range. Delta 2910s were used for the last three missions.

---

<sup>\*</sup>IRLS was used for many applications. One that received a great deal of publicity was the *Nimbus 3* elk experiment of 1970. To provide information on migration patterns of wild animals, collars equipped with the necessary electronics were put on two elk in Wyoming. Twice daily, *Nimbus 3* was to interrogate the collars to get information on air and skin temperature, altitude above sea level, light intensity, and location. Monique the elk died of pneumonia one week after its collar was put on; Monique II was shot by hunters after it had been tracked for one month.

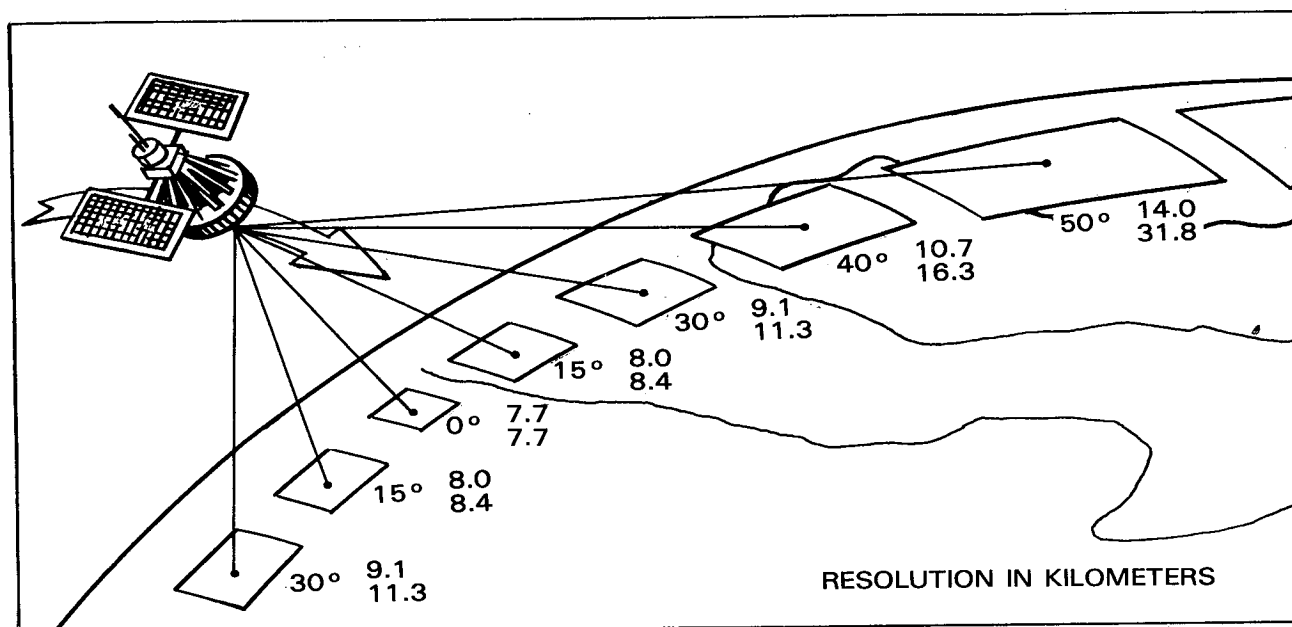

Figure 4-3. At an altitude of 11 112 kilometers, ground resolution was 7.67 km. The scan rate of 48 rpm provided contiguous coverage along the satellite's path. Due to the earth-scan geometry of THIR, as nadir angle increased, overlapping occurred between consecutive scans, reaching 350 percent overlap at the horizons and resulting in a loss of ground resolution in the direction of the satellite motion. This figure shows the relationship between nadir angle and ground resolution element size along the path of the satellite.

Source: GSFC, "The Nimbus 5 User's Guide," Nov. 1972, p. 20.

Table 4-82. Chronology of Nimbus Development and Operations

Date	Event
Early 1968	Congress approved a follow-on Nimbus program (Nimbus E and F).
June 1968	NASA Headquarters approved a replacement for Nimbus B.
Nov. 1968	Congress cut \$6.5 million from the Nimbus budget, forcing the agency to modify its plans.
Jan. 15, 1969	GSFC released an RFP for a Nimbus spacecraft.
Jan. 17, 1969	NASA terminated <i>Nimbus 2</i> operations after it had successfully completed all its objectives.
Jan. 22, 1969	A project approval document for Nimbus E and F was approved at NASA Headquarters. Nimbus E was scheduled for launch in the second quarter of 1972, Nimbus F for the second quarter of 1973.
Mar. 12, 1969	GE submitted its proposal for Nimbus to GSFC.
Apr. 14, 1969	<i>Nimbus 3</i> was launched successfully. Operations were ceased in March 1972.
July 1, 1969	GE's phase C contract was extended six months; phase D was shortened from 32 to 28 months.
July 25, 1969	A Nimbus E payload was approved; six of the originally proposed eight experiments were retained.
July 29, 1969	<i>Nimbus 3</i> 's IRIS failed.
Aug. 1, 1969	GSFC completed its evaluation of GE's proposal.
Nov. 20, 1969	For Nimbus F, 12 experiments were chosen from 33 proposals for a tentative payload; the number was reduced to 11 in August 1970.
Nov. 26, 1969	The Nimbus program manager recommended a Nimbus follow-on program of two flights (Nimbus G and H).
Feb. 1970	GSFC awarded contracts for Nimbus E experiments.
Mar. 31, 1970	GSFC awarded GE a contract for the fabrication of the Nimbus spacecraft; the contract was definitized in June.

Table 4-82. Chronology of Nimbus Development and Operations (Continued)

---

Apr. 8, 1970	<i>Nimbus 4</i> was launched successfully.
Jan. 25, 1971	The number of experiments being considered for <i>Nimbus F</i> was increased to 14; 12 were approved in March.
Feb. 1972	Because of budget tightening efforts, funds were reallocated from <i>Nimbus</i> to ERTS; three <i>Nimbus</i> experiments under consideration were dropped. GSFC awarded contracts for <i>Nimbus F</i> experiments.
July 1972	The tracking and data relay experiment was removed from <i>Nimbus E</i> , but it was kept as part of <i>Nimbus F</i> .
Dec. 10, 1972	<i>Nimbus 5</i> was launched successfully; operations were terminated in April 1983.
Mar. 29, 1973	NASA Headquarters sent GSFC guidelines for the initiation of <i>Nimbus G</i> . <i>Nimbus G</i> would provide data on pollution, oceanography, and meteorology; launch was scheduled for early 1977.
Aug. 1, 1973	GE presented a low-cost <i>Nimbus G</i> spacecraft development plan to NASA Headquarters.
Dec. 14, 1973	GE Presented a second cost proposal to NASA for <i>Nimbus G</i> not to exceed \$15.66 million.
Mar. 20, 1974	NASA Headquarters briefed OMB on <i>Nimbus G</i> .
Apr. 1974	The launch readiness date for <i>Nimbus F</i> was changed to October 1974.
Nov. 7, 1974	GSFC awarded GE a contract for <i>Nimbus G</i> development.
Nov. 27, 1974	The <i>Nimbus F</i> launch date was changed to May-June 1975.
Apr. 6, 1975	GSFC awarded a contract to Beckman Instruments for a <i>Nimbus G</i> instrument to measure and monitor concentrations of ozone (SBUV/TOMS).
May 1975	The launch date for <i>Nimbus G</i> was estimated as late 1978.
June 12, 1975	<i>Nimbus 6</i> was launched successfully; operations ended in September 1983.
Sept. 17, 1976	NASA Headquarters reviewed the status of <i>Nimbus G</i> .
Oct. 24, 1978	<i>Nimbus 7</i> was launched successfully; it was still operational in 1983.

---



Table 4-83. Nimbus 3 Characteristics

---

Also called: Nimbus B2  
Date of launch (location): April 14, 1969 (WTR)  
Launch vehicle: Long-Tank Thrust-Augmented Thor (Thorad)-Agena D  
Weight (kg): 571  
Shape: butterfly (1.42-meter torus ring base and hexagonal-shaped housing plus two solar paddle wings)  
Dimensions (m): 3.05 tall  
                  3.55 wide  
                  1.52 diameter ring  
Power source: Solar panels plus 8 NiCd batteries  
                  RTG (SNAP-19)  
Responsible NASA center: GE Company  
Project manager: Harry Press  
Project scientist: William Nordberg  
Objectives: Acquire global samples of infrared spectra from which vertical temperature profiles of the atmosphere may be derived; global mapping of radiative energy balance of Earth atmosphere and cloud cover over one seasonal cycle; demonstrate feasibility of surface pressure and wind measurements with IRLS; global mapping of Earth and its cloud cover (day and night) over a three-month period. Flight test a System for Nuclear Auxiliary Power (SNAP-19), a 50-watt radioactive thermal generator, developed by the Atomic Energy Commission. (Repeat of Nimbus B launch attempt, which failed because of a launch vehicle malfunction in May 1968.)  
Equipment: Medium Infrared (MRIR)  
                  High Resolution Infrared Radiometer (HRIR)  
                  Advanced TV Image Dissector Camera System (IDCS)  
                  Satellite Infrared Spectrometer (SIRS)  
                  Infrared Interferometer Spectrometer (IRIS)  
                  Monitor of Ultraviolet Solar Energy (MUSE)  
                  Interrogation, Recording, and Location System (IRLS)  
Results: Successful; provided daily atmospheric temperature readings up to 30 480 meters; although designed for only 12 months it was operational until March 1972. Launched with SECOR Army satellite.

---

Reference: NASA, "Nimbus 3 Mission Operations Report," S-604-69-04, Apr. 5, 1969.

Table 4-84. Nimbus 4 Characteristics

---

Also called: Nimbus D  
 Date of launch (location): April 8, 1970 (WTR)  
 Launch vehicle: Thorad-Agena D  
 Weight (kg): 571  
 Shape: butterfly (1.42-meter torus ring base and hexagonal shaped housing plus two solar paddle wings)  
 Dimensions (m): 3.05 tall  
                   3.55 wide  
                   1.52 diameter ring  
 Power source: Solar panels plus 8 NiCd batteries  
 Responsible NASA center: GE Company  
 Project manager: Harry Press  
 Project scientist: William Nordberg  
 Objectives: Acquire global samples of atmospheric radiation measurements to compare vertical temperature, water vapor, and ozone profiles; demonstrate feasibility of determining wind velocity fields by tracking multiple balloons.  
 Equipment: Advanced TV Image Dissector Camera System (IDCS)  
               Satellite Infrared Spectrometer (SIRS)  
               Monitor of Ultraviolet Solar Energy (MUSE)  
               Interrogation, Recording, and Location System (IRLS)  
               Infrared Interferometer Spectrometer (IRIS)  
               Backscatter Ultraviolet Spectrometer (BUV)  
               Filter Wedge Spectrometer (FWS)  
               Selective Chopper Radiometer (SCR)  
               Temperature Humidity Infrared Radiometer (THIR)  
 Results: Successful and versatile; six of the nine experiments were still operational in 1975.

---

Reference: NASA, "Nimbus 4 Mission Operations Report," S-604-70-04, Apr. 6, 1970.

Table 4-85. Nimbus 5 Characteristics

---

Also called: Nimbus E  
 Date of launch (location): Dec. 10, 1972 (WTR)  
 Launch vehicle: Delta 2910  
 Weight (kg): 772  
 Shape: butterfly (1.42-meter torus ring base and hexagonal shaped housing plus two solar paddle wings)  
 Dimensions (m): 3.05 tall  
                   3.55 wide  
                   1.52 diameter ring  
 Power source: Solar panels plus 8 NiCd batteries  
 Responsible NASA center: GE Company  
 Project manager: Stanley Weiland  
 Project scientist: John S. Theon  
 Objectives: Improve and extend capability for vertical soundings of temperature and moisture in the atmosphere; demonstrate improved thermal mapping of the Earth.  
 Equipment: Selective Chopper Radiometer (SCR)  
               Temperature Humidity Infrared Radiometer (THIR)  
               Infrared Temperature Profile Radiometer (ITPR)  
               Nimbus E Microwave Spectrometer (NEMS)  
               Electrically Scanning Microwave Radiometer (ESMR)  
               Surface Composition Mapping Radiometer (SCMR)  
 Results: Successful; ceased operations in April 1983.

---

Reference: NASA, "Nimbus 5 Mission Operations Report," S-604-72-05, Nov. 28, 1972.

Table 4-86. Nimbus 6 Characteristics

---

Also called:	Nimbus F
Date of launch (location):	June 12, 1975 (WTR)
Launch vehicle:	Delta 2910
Weight (kg):	585
Shape:	butterfly (1.42-meter torus ring base and hexagonal shaped housing plus two solar paddle wings)
Dimensions (m):	3.05 tall 3.55 wide 1.52 diameter ring
Power source:	Solar panels plus 8 NiCd batteries
Responsible NASA center:	GE Company
Project manager:	Jack Sargent
Project scientist:	John S. Theon
Objectives:	Contribute to the Global Atmospheric Research Program (GARP) by refining and extending the capability for vertically sounding the temperature and moisture of the atmosphere; provide experimental monitoring of environmental conditions (e.g., sea ice cover, rainfall).
Equipment:	Temperature Humidity Infrared Radiometer (THIR) Electrically Scanning Microwave Radiometer (ESMR) Scanning Microwave Radiometer (SCAMS) High Resolution Infrared Sounder (HIRS) Tropical Wind, Energy Conversion, and Reference Level Experiment (TWERLE) Earth Radiation Budget Experiment (ERB) Limb Radiance Inversion Radiometer (LRIR) Pressure Modulated Radiometer (PMR) Tracking and Data Relay Experiment (T&DRE)
Results:	Successful; ceased operations in September 1983; TWERLE used many ways beyond balloon tracking: ocean temperature from buoys, animal migration, adventurers (Eagle 1 trans-Atlantic balloon; dog-sled expedition at the North Pole), sailing vessels. Satellite demonstrated the data relay capabilities of the Tracking and Data Relay Experiment.

---

Reference: NASA, "Nimbus 6 Mission Operations Report," S-604-75-07, June 3, 1975; and Charles Cote, Ralph Taylor, and Eugene Gilbert, eds., *Nimbus 6 Random Access Measurement System Applications Experiments*, NASA SP-457 (Washington, D.C.: GPO, 1982).

Table 4-87. Nimbus 7 Characteristics

---

Also called:	Nimbus G
Date of launch (location):	Oct. 24, 1978 (WTR)
Launch vehicle:	Delta 2910
Weight (kg):	987
Shape:	butterfly (1.42-meter torus ring base and hexagonal shaped housing plus two solar paddle wings)
Dimensions (m):	3.05 tall 3.55 wide 1.52 diameter ring
Power source:	Solar panels plus 8 NiCd batteries
Responsible NASA center:	GE Company
Project manager:	Ronald K. Browning
Project scientist:	William R. Bandeen
Objectives:	To determine the feasibility of mapping upper atmospheric characteristics; to determine the feasibility to apply space-collected oceanographic data for science and applications purposes, and to extend the solar and Earth radiation data base.
Equipment:	Temperature Humidity Infrared Radiometer (THIR) Earth Radiation Budget Experiment (ERB) Limb Infrared Monitoring of the Stratosphere (LIMS) Stratospheric and Mesospheric Sounder (SAMS) Stratospheric Aerosol Measurement II (Sam II) Solar Backscatter Ultraviolet and Total Ozone Mapping Spectrometer (SBUV/TOMS) Scanning Multichannel Microwave Radiometer (SMMR) Coastal Zone Color Scanner (CZCS)
Results:	Successful; last of the series; in 1983 the satellite entered its fifth year of uninterrupted operations; first satellite designed to monitor manmade and natural pollutants; mapped ozone distribution.

---

Reference: NASA, "Nimbus 7 Mission Operations Report," S-604-75-08, Sept. 1, 1978.

**Other Meteorology Satellites.** In addition to its own research and development satellites and the weather service's operational satellites, NASA launched three other metsats.

For the European Space Agency (ESA) in November 1977, NASA launched *Meteosat I*, designed to investigate thermal characteristics and cloud imagery from geostationary orbit. For Japan, the U.S. space agency orbited *GMS* (Geostationary Meteorology Satellite), also called *Himawari*, in July 1977. This satellite collected cloud cover data over the Pacific from Hawaii to Pakistan. NASA was reimbursed by ESA and Japan for the Delta launchers and the agency's technical support of the two missions.

France's Centre National d'Études Spatiales and NASA worked together on the Cooperative Applications Satellite *Eole*, with France providing the satellite and the U.S. the launch vehicle, technical support, and analysis of the results. The satellite tracked some 750 instrumented balloons launched from Argentina from which it received data on wind speed and direction and air temperature and pressure. The 85-kilogram satellite was launched from Wallops Island by a Scout vehicle in August 1971.

**International Meteorological Program.** In December 1961 in reply to President John F. Kennedy's call for international cooperation in the peaceful uses of outer space, the United Nations enacted General Assembly Resolution 1721. A recommendation to conduct an extensive global meteorological program was an important

part of that resolution. Two years later in December 1963, the UN formally endorsed a specific plan for international cooperation in meteorological training and research. The World Meteorological Organization, an agency of the United Nations, coordinated the World Weather Program, of which there were two components: the World Weather Watch, initiated in 1963, and the Global Atmospheric Research Program (GARP), endorsed in 1966. Broad goals of the World Weather Program included extending the time range and scope of weather prediction, assessing the consequences of man's pollution of the atmosphere, and determining the feasibility of large-scale weather modification. World Weather Watch was the program's operational arm, providing global observations, data processing, and telecommunications systems that brought each member nation basic weather information. GARP, a joint effort of the World Meteorological Organization and the International Council of Scientific Unions, was the research arm.<sup>9</sup>

Participating in the first major GARP observational experiment, the GARP Atlantic Tropical Experiment (GATE), were several U.S. organizations: the Department of Commerce (NOAA), the Department of Defense (USAF and USN), the Department of State, the Department of Transportation (USCG), the National Science Foundation, and NASA. GATE was planned to provide data on the behavior of tropical weather systems. Specialists hoped to incorporate this information into mathematical models of the global atmosphere. Programmed by computers, such models, together with satellite observations, could be used to produce computerized weather forecasts for several days in advance.

GATE was conducted from June 15 to September 23, 1974, over a 51.8 million square kilometer area of tropical land and seas from the eastern Pacific, across Latin America, the Atlantic, and Africa, to the western Indian Ocean. Some 4000 scientists, ship and aircraft crews, and technicians from 66 countries participated. Instruments were fixed on 38 ships, 65 buoys, 13 aircraft, and 6 satellites, gathering information from the top of the atmosphere to 1500 meters below the sea surface.

NASA's *SMS 1*, *Nimbus 5*, and *ATS 3* satellites participated, along with *NOAA 2* and *3*. They furnished essential information on cloud systems, cloudtop heights and temperatures, cloud liquid water content, wind speed and direction, temperature and moistness in the atmosphere, and sea surface temperatures, day and night. *Vanguard*, part of NASA's global tracking and data acquisition network, was one of 38 ships involved. It gathered upper air wind profile and surface net data. NASA also provided a Convair 990 aircraft (1 of 13 participating aircraft) to make intensive measurements of air temperature, humidity, dew point, and pressure and to monitor other phenomena.

NASA was also assigned a major role in the First GARP Global Experiment (FGGE) planned for the late 1970s. The main feature of this ambitious international undertaking was a nine-satellite observing system: five in geostationary orbits (three U.S., one European, and one Japanese) and four in polar orbits (two U.S. and two Soviet).\* To prepare for the experiment, NASA conducted a Data Systems Test

---

\*In geostationary orbit were *GOES 1*, *2*, and *3*, *Meteosat*, and *GMS*. In polar orbit were *Tiros N*, *NOAA 6*, and two USSR satellites of the Meteor class. *Nimbus 7* also supplied information on ocean rainfall and sea surface temperatures, bringing to 10 the number of satellites supporting FGGE.

(DST) during 1974-1976 using conventional data collection systems and operational research and development satellites. The test checked the adequacy of the FGGE observing systems, data processing plans, and numerical forecasting models. The 11-month experiment, involving 147 countries, began in January 1979.

Table 4-88. Meteosat 1 Characteristics

---

Date of launch (location): Nov. 23, 1977 (ETR)  
 Launch vehicle: Delta 2910  
 Weight (kg): 697  
 Shape: cylindrical  
 Dimensions (m): 2.1 diameter  
                   4.3 height  
 Power source: Solar cells and NiCd batteries  
 Responsible NASA center: Goddard Space Flight Center  
 Prime contractor: Cannes Establishment of Aerospatiale, for the European Space Agency  
 Project manager: Robert Goss  
 Objectives: For three years, conduct meteorological experiments to investigate thermal characteristics and cloud imagery from geostationary orbit; participate in GARP.  
 Equipment: Telescope Radiometer  
 Results: Successful.

---

Reference: NASA, "Meteosat 1 Mission Operations Report," M-492-102-77-01, Nov. 16, 1977.

Table 4-89. GMS Characteristics

---

Also called: Geostationary Meteorology Satellite; Himawari  
 Date of launch (location): July 14, 1977 (ETR)  
 Launch vehicle: Delta 2914  
 Weight (kg): 281  
 Shape: cylindrical with antenna-instrument array mounted on one end  
 Dimensions (m): 3.0 height  
                   2.1 diameter  
 Power source: Solar cells and NiCd batteries  
 Responsible NASA center: Goddard Space Flight Center  
 Prime contractor: Hughes Aircraft Company for Nippon Electric Co. Ltd., in conjunction with the Japanese National Space Development Agency  
 Project manager: Robert Goss  
 Objectives: For five years, collect cloud cover data over the Pacific from Hawaii to Pakistan from stationary orbit; contribute to GARP  
 Equipment: Visible and Infrared Spin Scan Radiometer (VISSR)  
               Space Environment Monitor (SEM)  
 Results: Successful.

---

Reference: NASA, "GMS Mission Operations Report," M-492-101-77-01, July 7, 1977.

Table 4-90. Eole Characteristics

---

Also called:	Cooperative Applications Satellite 1 (CAS-1)
Date of launch (location):	Aug. 16, 1971 (Wallops Island)
Launch vehicle:	Scout
Weight (kg):	85
Shape:	Octagonal-shaped prism with eight solar panels extended from one end and conical antennas from the other.
Dimensions (m):	0.58 length 0.71 diameter
Power source:	Solar panels and NiCd batteries
Responsible NASA center:	Goddard Space Flight Center
Responsible organizations:	NASA and the French Centre National d'Etudes Spatiales
Project manager:	Samuel R. Stevens
Project scientist:	William Bundeen
Objectives:	Collect information on wind speed and direction, air temperature, and pressure from 500-750 instrumented balloons in the southern hemisphere launched from Argentina.
Balloons:	helium filled, 8 kg, 3.7-m diameter, life minimum of 30 days; reach altitude of 11 850 m.
Results:	Successful.

---

Reference: NASA, "Eole Mission Operations Report," S-876-71-02, Aug. 5, 1971

### Communications Program

During its second decade, NASA launched 63 communications satellites. All but five were operational satellites launched to provide commercial communications, military network, support, or aids to navigation (see table 4-91). The space agency provided the launch vehicles (Deltas, Atlas-Centaurs, and Scouts), the necessary ground support, and initial tracking and data acquisition on a reimbursable basis. Seventeen comsats were launched for foreign countries, 11 for the U.S. military, 10 for U.S. commercial communications companies, 20 for the International Telecommunications Satellite Consortium (Intelsat), and 4 for the Radio Amateur Satellite Corporation on a noninterfering basis with other payloads. Only two, *CTS 1* (Communications Technology Satellite) and *Fltsatcom* (launched for the U.S. Navy), were exclusively research and development projects.

CTS was a joint project shared with NASA by the Canadian Department of Communications. *CTS 1* was designed specifically to advance the technology of high-radiated radio-frequency-power satellites. Launched in January 1976 and operated for 34 months, it was the most powerful communications satellite launched to date. NASA's other advanced communications experiments were carried aboard the Applications Technology Satellites, which are discussed later in this chapter. A number of these experiments were related to the problems of frequency spectrum utilization.

The foreign, commercial, and military comsats, *CTS 1*, and the Intelsat series are considered on the following pages. For information on ATS, see elsewhere in this chapter.

At NASA Headquarters in early 1969, the communications program was under the purview of A. M. Greg Andrus, who in June 1969 became communications satellite program manager under Richard B. Marsten, new director of the communications program. Marsten was assisted by Jerome D. Rosenberg, deputy direc-

tor. Rosenberg was replaced by Samuel H. Hubbard in 1974; Andrus by Samuel W. Fordyce in 1973. For more information, see table 4-2.

Table 4-91. Communications Satellites Launched by NASA, 1969-1978

Communications Satellites	Origin	Launched on a Reimbursable Basis	Operational	Successful
Anik 1-4	Canada	yes	yes	yes
BSE	Japan	yes	op. & R&D	yes
Comstar 1-3	Comsat	yes	yes	yes
CS	Japan	yes	yes	yes
CTS 1	U.S.-Canada	joint	R&D	yes
Fltsatcom	USN	yes	yes	yes
Intelsat III (6)	Intelsat	yes	yes	4 of 6
Intelsat IV (8)	Intelsat	yes	yes	6 of 8
Intelsat IVA (6)	Intelsat	yes	yes	5 of 6
Marisat 1-3	Comsat	yes	yes	yes
NATO (5)	DoD	yes	yes	yes
Oscar 5-8	Amateur Radio	non-interfering*	op. & R&D	yes
OTS 1-2	ESA	yes	yes	1 of 2
P76-5	USAF	yes	R&D	yes
Palapa 1-2	Indonesia	yes	yes	yes
SATCOM 1-2	RCA	yes	yes	yes
Sirio	Italy	yes	yes	yes
Skynet (4)	U.K. (military)	yes	yes	3 of 4
Symphonie 1-2	W. Germany	yes	yes	yes
Transit (4)	USN	yes	yes	3 of 4
Westar 1-2	Western Union	yes	yes	yes
				55 of 63

\*Launched without charge and with a primary payload that was not impacted by the secondary payload's presence.

Table 4-92. Anik 1 Characteristics

Also called: Telesat-A; Canadian Communications Satellite; Anik A-1 ("anik" is Eskimo for brother)  
 Date of launch (location): Nov. 9, 1972 (ETR)  
 Launch vehicle: Delta 1914  
 Weight (kg): 270  
 Shape: cylindrical with a parabolic mesh antenna extending from one end  
 Dimensions (m): 1.8 diameter  
                   3.3 height  
 Power source: Solar cells plus NiCd batteries  
 NASA's role: Launch vehicle and support (reimbursable)  
 Cooperating organizations: NASA and Telesat of Canada  
 Prime contractor: Hughes Aircraft Company  
 Responsible NASA center: Goddard Space Flight Center  
 Project manager: Robert J. Goss  
 Objectives: Provide transmission of TV, voice, data, etc., (analog or digital signals) throughout Canada for seven years.  
 Results: Successful; first of a series of Canadian domestic communications satellites; handled up to 10 color TV channels or 9600 telephone circuits. First launch of a Delta "straight 8" configuration. Operated in synchronous orbit over the equator.

Reference: NASA, "Anik 1 Mission Operations Report," S-492-201-72-01, Nov. 6, 1972.



Table 4-93. Anik 2 Characteristics

---

Also called: Telesat-B; Anik A-2  
 Date of launch (location): Apr. 20, 1973 (ETR)  
 Launch vehicle: Delta 1914  
 Weight (kg): 273  
 Shape: cylindrical with a parabolic mesh antenna extending from one end  
 Dimensions (m): 1.8 diameter  
                   3.3 height  
 Power source: Solar cells plus NiCd batteries  
 NASA's role: Launch vehicle and support (reimbursable)  
 Cooperating organizations: NASA and Telesat of Canada  
 Prime contractor: Hughes Aircraft Company  
 Responsible NASA center: Goddard Space Flight Center  
 Project manager: Robert J. Goss  
 Objectives: Provide transmission of TV, voice, data, etc., (analog or digital signals) throughout  
                   Canada for seven years.  
 Results: Successful; second in series.

---

Reference: NASA, "Anik 2 Mission Operations Report," S-492-201-73-02, Mar. 7, 1973.

Table 4-94. Anik 3 Characteristics

---

Also called: Telesat-C; Anik A-3  
 Date of launch (location): May 7, 1975 (ETR)  
 Launch vehicle: Delta 2914  
 Weight (kg): 270  
 Shape: cylindrical with a parabolic mesh antenna extending from one end  
 Dimensions (m): 1.8 diameter  
                   3.3 height  
 Power source: Solar cells plus NiCd batteries  
 NASA's role: Launch vehicle and support (reimbursable)  
 Cooperating organizations: NASA and Telesat of Canada  
 Prime contractor: Hughes Aircraft Company  
 Responsible NASA center: Goddard Space Flight Center  
 Project manager: Robert J. Goss  
 Objectives: Provide transmission of TV, voice, data, etc., (analog or digital signals) throughout  
                   Canada for seven years.  
 Results: Successful; third and last of "A" series.

---

Reference: NASA, "Anik 3 Mission Operations Report," S-492-201-75-03, Apr. 25, 1975.

C-4

Table 4-95. Anik 4 Characteristics

---

Also called: Telesat-D; Anik B-1

Date of launch (location): Dec. 16, 1978 (ETR)

Launch vehicle: Delta 3914

Weight (kg): 474

Shape: Box-shaped with a reflector and antenna mounted on one end and two paddle-shaped solar arrays extending on booms from two opposite sides

Dimensions (m): 2.17 diameter

1.12 length (3.26 including solar arrays)

Power source: Solar cells plus 3 NiCd batteries

NASA's role: Launch vehicle and support (reimbursable)

Cooperating organizations: NASA and Telesat of Canada

Prime contractor: RCA-Astroelectronics

Responsible NASA center: Goddard Space Flight Center

Mission coordinator: Philip Frustace

Objectives: Provide point-to-point voice, TV, and data communications between widely scattered and remote areas throughout Canada from synchronous orbit over the equator.

Results: Successful; first of second-generation Anik satellites.

---

Reference: NASA, "Anik 3 Mission Operations Report," S-492-201-78-04, Dec. 12, 1978.

Table 4-96. BSE Characteristics

---

Also called: Broadcast Satellite—Experimental; Mid-Scale Broadcasting Satellite for Experimental Purposes; Yuri

Date of launch (location): Apr. 7, 1978 (ETR)

Launch vehicle: Delta 2914

Weight (kg): 327 (orbital)

Shape: Box-shaped with an antenna mounted on one side and two solar paddles extending from opposing sides.

Dimensions (m): 1.3 width (8.9 with panels extended)

1.2 length

3.9 height

Power source: Solar panels plus NiCd batteries

NASA's role: Launch vehicle and support (reimbursable).

Cooperating organizations: NASA and Japanese National Space Development Agency

Prime contractor: General Electric for Tokyo Shibaura Electric Co.

Responsible NASA center: Goddard Space Flight Center

Project manager: Robert J. Goss

Objectives: To evaluate new methods of transmitting high-quality color TV images to the Japanese islands from stationary orbit.

Results: Successful.

---

Reference: NASA, "BSE Mission Operations Reports," M-492-212-78-01, Feb. 28, 1978.

Table 4-97. Comstar 1 Characteristics

---

Also called: Comstar D-1  
 Date of launch (location): May 13, 1976 (ETR)  
 Launch vehicle: Atlas SLV-3D-Centaur D-1A  
 Weight (kg): 816.5  
 Shape: Cylindrical with a parabolic antenna and reflectors mounted on one end.  
 Dimensions (m): 0.61 height  
                     0.24 diameter  
 Power source: Solar cells plus NiCd batteries  
 NASA's role: Launch vehicle (reimbursable)  
 Cooperating organizations: NASA and COMSAT  
 Prime contractor: Hughes Aircraft Co.  
 Responsible NASA center: Langley Research Center  
 Mission project engineer: Kenneth A. Adams  
 Objectives: To provide commercial telephone communications for seven years from geosynchronous orbit.  
 Results: Successful; first in a series; leased to AT&T and GTE Satellite Corp.; began service in July 1976; provided 14 000 two-way high-quality voice circuits.

---

Reference: NASA Hq., "Project COMSTAR I-A," Press Release 76-75, Apr. 27, 1976; and COMSAT General Corp., "The Launch of COMSTAR," May 1976.

Table 4-98. Comstar 2 Characteristics

---

Also called: Comstar D-2  
 Date of launch (location): July 22, 1976 (ETR)  
 Launch vehicle: Atlas SLV-3D-Centaur D-1A  
 Weight (kg): 816.5  
 Shape: Cylindrical with a parabolic antenna and reflectors mounted on one end.  
 Dimensions (m): 0.61 height  
                     0.24 diameter  
 Power source: Solar cells plus NiCd batteries  
 NASA's role: Launch vehicle (reimbursable)  
 Cooperating organizations: NASA and COMSAT  
 Prime contractor: Hughes Aircraft Co.  
 Responsible NASA center: Langley Research Center  
 Mission project engineer: Kenneth A. Adams  
 Objectives: To serve as a backup telephone communications link for peak-load services.  
 Results: Successful; second in series.

---

Reference: NASA, "Comstar 2 Mission Operations Report," M-491-201-76-02, July 20, 1976.

Table 4-99. Comstar 3 Characteristics

---

Also called: Comstar D-3  
 Date of launch (location): June 29, 1975 (ETR)  
 Launch vehicle: Atlas SLV-3D-Centaur D-1A  
 Weight (kg): 792  
 Shape: Cylindrical with a parabolic antenna and reflectors mounted on one end.  
 Dimensions (m): 0.61 height  
                     0.24 diameter  
 Power source: Solar cells plus NiCd batteries  
 NASA's role: Launch vehicle (reimbursable)  
 Cooperating organizations: NASA and COMSAT  
 Prime contractor: Hughes Aircraft Co.  
 Responsible NASA center: Langley Research Center  
 Mission project engineer: Richard E. Orezechowski  
 Objectives: To serve as a telephone communications link for future systems growth.  
 Results: Successful; third in series.

---

Reference: NASA, "Comstar 2 Mission Operations Report," M-491-201-78-03, June 14, 1978.

Table 4-100. CS (Sakura) Characteristics

---

Also called: Japan Communications Satellite ("Sakura" is Japanese for cherry blossom)  
 Date of launch (location): Dec. 15, 1977 (ETR)  
 Launch vehicle: Delta 2914  
 Weight (kg): 340 (orbital)  
 Shape: Cylindrical with horn-shaped reflector-antenna mounted on one end.  
 Dimensions (m): 3.48 height  
                     2.18 diameter  
 Power source: Solar cells plus NiCd batteries  
 NASA's role: Launch vehicle (reimbursable)  
 Cooperating organizations: NASA and Japanese National Space Development Agency  
 Prime contractor: Ford Aerospace for Mitsubishi Electric Co.  
 Responsible NASA center: Goddard Space Flight Center  
 Mission project engineer: Robert J. Goss  
 Objectives: To provide communications coverage for the Japanese islands for three years.  
 Results: Successful; third in series.

---

Reference: NASA, "Sakura Mission Operations Report," M-492-211-77-01, Dec. 14, 1977.

**Communications Technology Satellite.** The Communications Technology Satellite (CTS), a joint U.S.-Canadian project, demonstrated that powerful satellite systems can bring low-cost television to remote areas anywhere on the globe. More than 160 U.S. experiments were conducted with CTS during its 34-month lifetime (January 17, 1976 to November 24, 1979), ranging from business teleconferences with two-way television and voice contact to emergency use during a 1977 flood in Pennsylvania. A highly instrumented portable ground terminal supported operations for the synchronous-orbit satellite.

Officials representing Canada's Department of Communications and NASA first signed an agreement concerning the project in April 1971. The Canadian Communications Research Centre designed and built the 347-kilogram spacecraft, and NASA tested it and provided a Delta launcher and instruments for the payload.

With a life expectancy of two years, the cylindrical satellite with long solar panel wings operated in the 12 to 14 gigahertz frequency band. Its solar powered traveling wave transmitter, provided by NASA's Lewis Research Center in Cleveland, had 10 to 20 times the broadcast power of typical communications satellites of the 1970s (see fig. 4-5). This higher broadcast power made it possible to use much smaller and far less expensive ground receiving equipment.

At the Lewis Research Center, William H. Robbins acted as CTS project manager, and William H. Hawersaat was his deputy. Patrick L. Donoughe served as U.S. experiments manager. Missions operations were managed at the Goddard Space Flight Center in Maryland by Robert G. Sanford. Adolph J. Cervenka was responsible for NASA Headquarters management of the project.

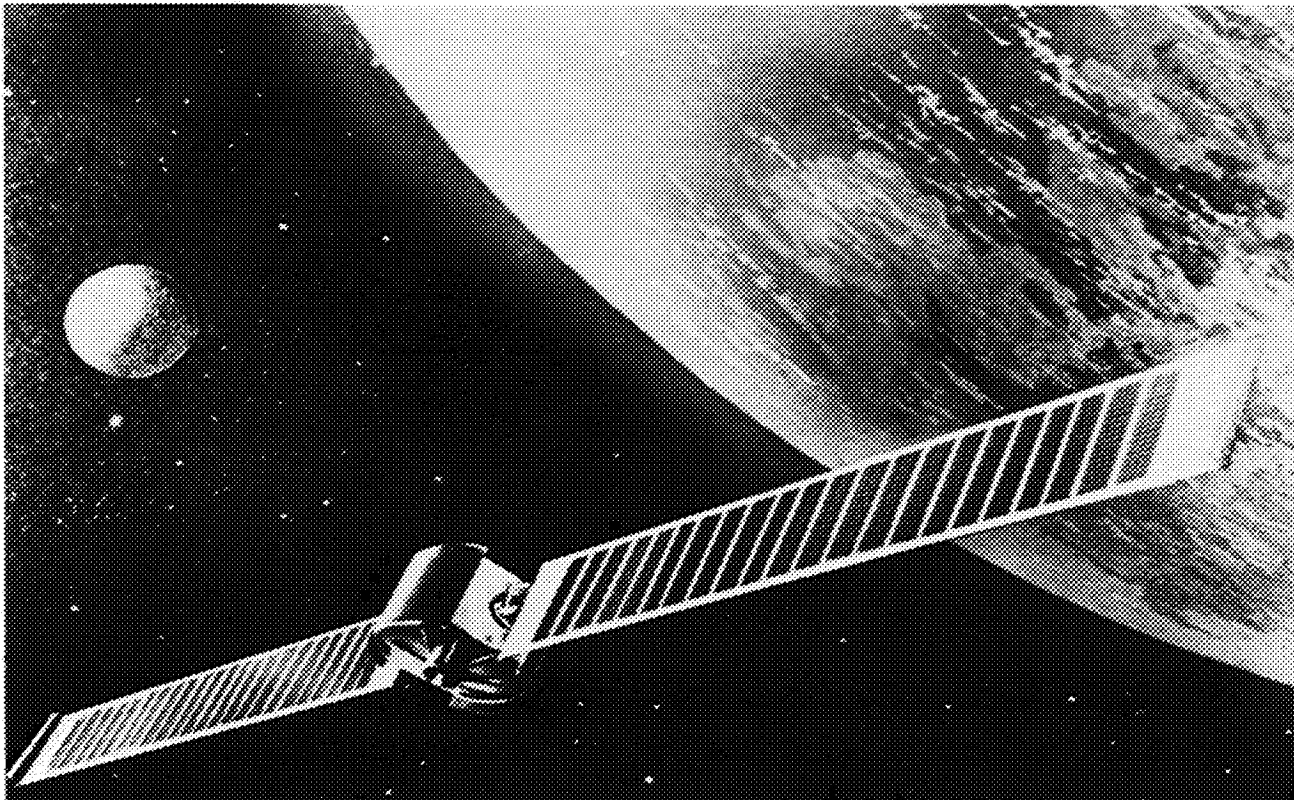

*Figure 4-4. The large-winged Communications Technology Satellite was a joint U.S.-Canadian project that demonstrated new communications technology.*

ORIGINAL PAGE IS  
OF POOR QUALITY

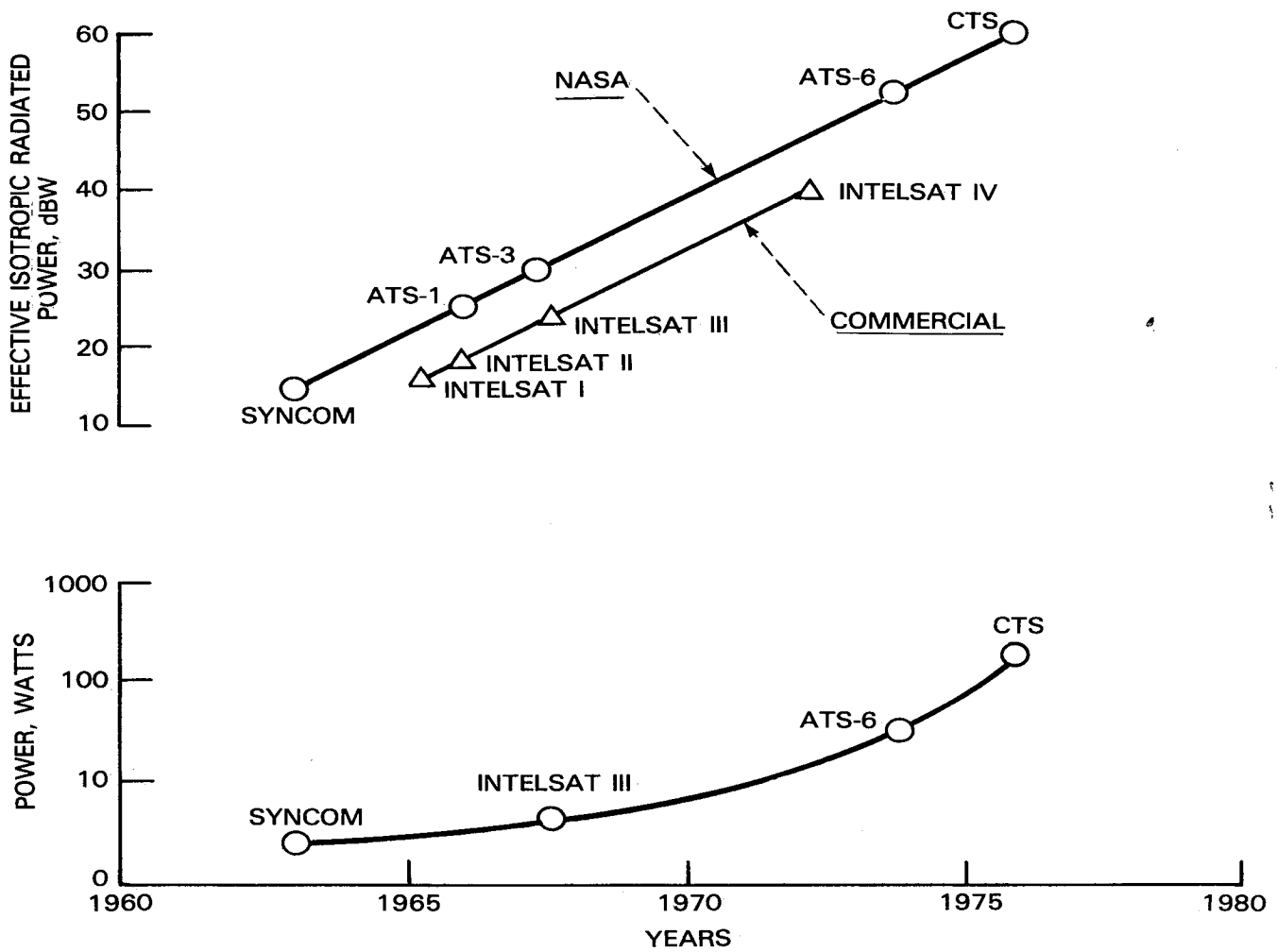

Figure 4-5. CTS transmitted at a high power level (200 watts), permitting the reception of color television with a simple, low-cost ground receiver. In remote areas of the U.S. and Canada, the population density was not sufficient for the large receiving stations typical of those used for communications satellites in the 1970s. With CTS, community service organizations, health care agencies, educational institutions, and businesses in remote areas had access to television communications systems.

Source: Lewis Research Center, "Communications Technology Satellite," Jan. 1976, pp. 2-3.

Table 4-101. CTS-1 Characteristics

---

Also called: Communications Technology Satellite

Date of launch (location): Jan. 17, 1976 (ETR)

Launch vehicle: Delta 2914

Weight (kg): 676.8

Shape: Roughly cylindrical with solar panels

Dimensions (m): 1.88 height (16.5 with solar panels extended)  
1.83 diameter

Power source: Solar cells plus NiCd batteries

NASA's role: Launch vehicle, spacecraft testing, instruments (traveling wave tube)

Cooperating organizations: NASA and Canadian Department of Communications

Spacecraft provider: Canadian Communications Research Center

Responsible NASA center: Goddard Space Flight Center  
Lewis Research Center

Mission operators managers: William H. Robbins; Robert G. Sanford

Objectives: To advance the technology of spacecraft-mounted and related ground-based components applicable to high-radiated RF-power satellites; two year experiment program.

U.S. experiments: Transmitter Experiment Package

Solar Array Technology Experiment

Attitude Control System Experiment

Biomedical Communications

Health Communications

Communications Support for Decentralized Medical Education

Health Educational Television

College Curriculum Sharing

Project Interchange

Satellite Distribution Experiment

Communications in Lieu of Transportation

Transportable Emergency Earth Terminal

Interactive Techniques for Intra-NASA Applications

Communications Link Characterization

12 GHz Low-Cost Receivers

Results: Successful; most powerful communications satellite launched to that date; operations ceased in Oct. 1979.

---

Reference: NASA, "CTS Mission Operations Report," E-610-76-01, Dec. 30, 1975.

Table 4-102. Fltsatcom-1 Characteristics

---

Also called:	Fleet Satellite Communications
Date of launch (location):	Feb. 9, 1978 (ETR)
Launch vehicle:	Atlas SLV-3D-Centaur D-1AR
Weight (kg):	1874
Shape:	Hexagonal with umbrella-shaped antenna and two solar paddles mounted on two Y-shaped booms from opposite sides
Dimensions (m):	1.27 height 2.44 diameter (4.88 with antenna)
Power source:	Solar cells plus NiCd batteries
NASA's role:	Launch vehicle and ground support (reimbursable)
Cooperating organizations:	NASA and U.S. Navy
Prime contractor:	TRW Defense and Space Systems
Responsible NASA center:	Langley Research Center
Project engineer:	K. Adams
Objectives:	To provide communications capability for five years for the U.S. Air Force with narrow-band and wideband channels and for the U.S. Navy for fleet relay and fleet broadcast channels.
Results:	Successful; first of a series. System provided an operational near-global satellite communications system (four satellites) to support high-priority communications requirements of the Navy and Air Force.

---

Reference: NASA, "Fltsatcom Mission Operations Report," M-491-202-78-01, Jan. 25, 1978.

**Intelsat Family.** The International Telecommunications Satellite Consortium (Intelsat) was established in August 1964 to develop, implement, and operate an international communications satellite system. Each member nation (68 members in 1969; 92 in 1978) owned an investment share of the consortium proportional to its international traffic in a global satellite system and owned and operated its own ground stations. The Communications Satellite Corporation (Comsat), authorized by the U.S. Congress in 1962, served as the management and operations arm of Intelsat.

*Intelsat I*, a 38-kilogram synchronous-orbit communications satellite, was orbited in April 1965. Four *Intelsat II* satellites were put to work in 1966-1967. In December 1968, the first successful launch of an *Intelsat III* model took place. Four more of the 146-kilogram, third-generation, TRW-built satellites followed over the next two years (2 other *Intelsat III*s were unsuccessful), providing commercial communications links for the continents. Four satellites in synchronous orbits above the equator provided communications service across the Atlantic and Pacific Oceans, north and south of the equator. Each spin-stabilized satellite was capable of handling 1200 high-quality voice circuits or 4 color television channels.

The next member of the satellite family, *Intelsat IV*, was larger, weighing in at 718 kilograms in orbit, and more capable. *Intelsat IV* could provide 3000 to 9000 telephone circuits, or 12 color television channels, or a combination of telephone, television, data, and other forms of communications. A special feature of this spacecraft, made by Hughes Aircraft Company with the assistance of 10 international subcontractors, was two "spot beam" antennas, steerable dish antennas that could direct spot beams at selected parts of the world, providing them with max-



imum capacity service. In addition, the satellite had two receiving and two transmitting horn antennas. Seven Intelsat IV satellites were orbited in 1971-1975 (an eighth failed); however, the series suffered anomalies with the receivers and onboard batteries. Because of these hardware problems and because plans for the fifth-generation Intelsat called for a very advanced spacecraft, Hughes proposed a IV½, or IVA, model. Intelsat IVA had a capacity two-thirds greater than its immediate predecessor. It also employed frequency reuse through spot beam separation, permitting communications in different directions on the same frequencies by using different transponders, thereby doubling the use of the same frequency. *Intelsat IVA-F1*, 826 kilograms in orbit, was launched in September 1975. Four others joined it by the end of 1978 (a sixth IVA failed), each capable of 6250 two-way voice circuits plus two television channels.

In 1976, Intelsat chose Aeronutronic Ford to build its fifth-generation comsat. The 900-kilogram satellite was expected to manage 12 000 voice circuits. The first of the series was launched in 1980.

Long-tank thrust-augmented Thor-Delta launch vehicles were used to orbit the Intelsat III satellites. Atlas-Centaurs were used for the heavier Intelsat IVs and IVAs. In late 1978, Intelsat had decided to buy Atlas-Centaur vehicles for the first four fifth-generation satellites and the European Ariane for the sixth. The communications consortium planned to book space on Shuttle for the remaining two payloads. Using Shuttle would save Intelsat considerable money. In 1976 dollars, it would cost \$37.6 million to launch Intelsat V in the 1980s; \$19.4 million on Shuttle. In 1977, it was predicted that taking advantage of the reusable launcher would cost \$22.1 million if the payload was exclusively Intelsat; the price would come down to \$14.7 million if Intelsat shared the cargo bay with another client.

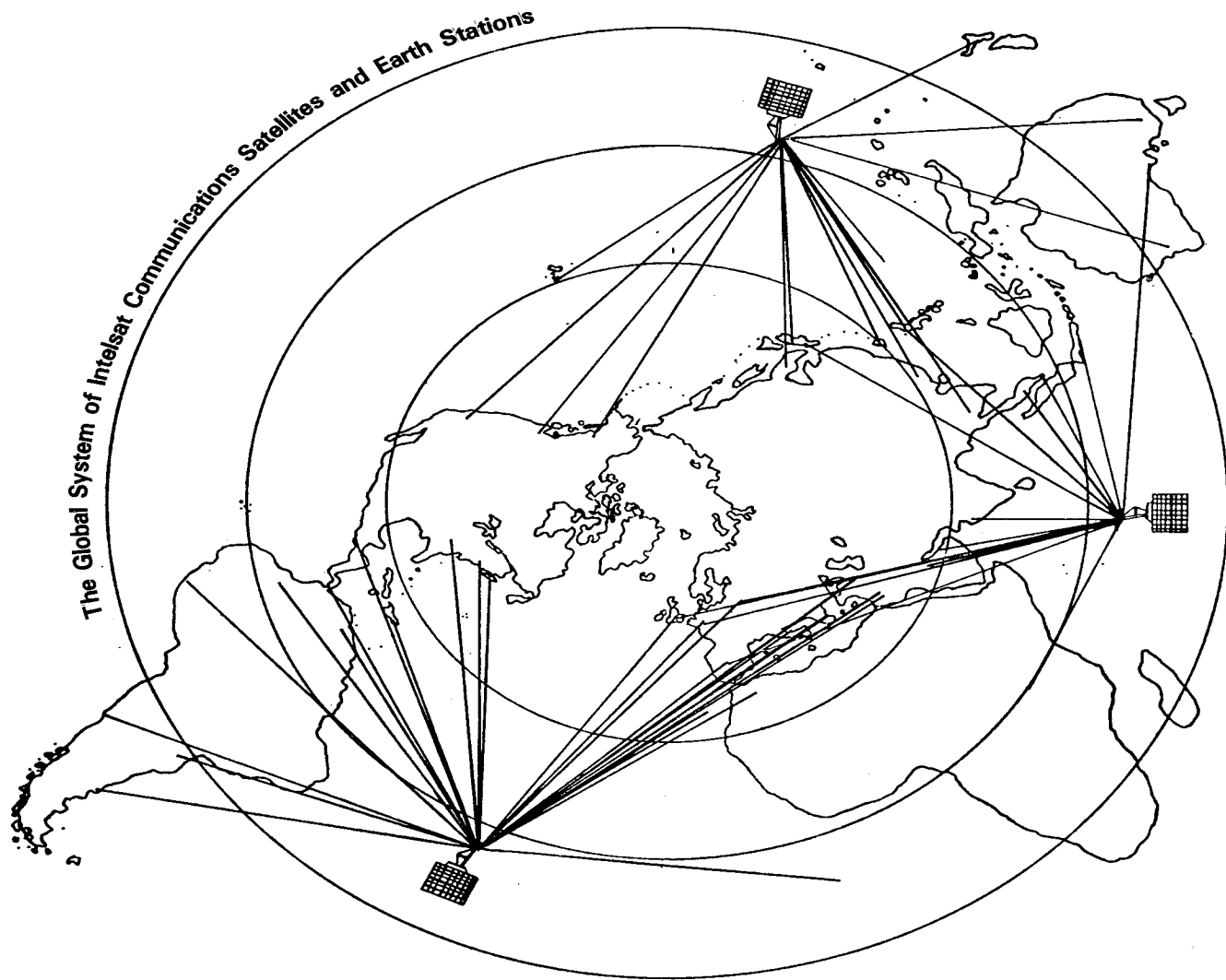

**Earth Stations Served by  
Atlantic Ocean Satellites**

Andover, Maine (U.S.)  
Asadabad, Iran  
Ascension Island, U.K.  
Balcarce, Argentina  
Buitrago, Spain  
Camatagua, Venezuela  
Cayey, Puerto Rico (U.S.)  
Choconta, Colombia  
Etam, W. Va. (U.S.)  
Fucino, Italy  
Goonhilly Downs, U.K.  
Grand Canary Island, Spain

Lanlate, Nigeria  
Longovilo, Chile  
Lurin, Peru  
Mill Village, Canada  
Pleumeur Bodou, France  
Raisting, Germany  
Sehous, Morocco  
Tangua, Brazil  
Thermopylae, Greece  
Tulancingo, Mexico  
Utibe, Panama

**Earth Stations Served by  
Indian Ocean Satellite**

Arbaniyeh, Lebanon  
Arvi, India  
Buitrago, Spain  
Ceduna, Australia  
Djatiluhur, Indonesia  
Fucino, Italy  
Goonhilly Downs, U.K.  
Kuantan, Malaysia  
Longonot, Kenya  
Raisting, Germany  
Ras Abu Jarjur, Bahrain  
Si Racha, Thailand  
Umm Al-Aish, Kuwait  
Yamaguchi, Japan

**Earth Stations Served by  
Pacific Ocean Satellites**

Bartlett, Alaska (U.S.)  
Brewster, Washington (U.S.)  
Carnarvon, Australia  
Guam (U.S.)  
Hong Kong (U.K.)  
Ibaraki, Japan  
Jamesburg, California (U.S.)  
Kum San, Republic of Korea  
Moree, Australia  
Paumalu, Hawaii (U.S.)  
Sri Racha, Thailand  
Taipei, Republic of China  
Tanay, Philippines

*Figure 4-6. Intelsat Satellites and Ground Network*

Table 4-103. Chronology of Intelsat Development and Operations, 1969-1978

Date	Event
Feb. 5, 1969	<i>Intelsat III F-3</i> was launched successfully by NASA for Intelsat. The satellite was moved from over the Pacific to over the Indian Ocean in May 1969 because of recurring problems with the comsat. It was operational until April 1979.
Apr. 21, 1969	Intelsat chose the Atlas-Centaur vehicle to launch the Intelsat IV series instead of a Thor-Delta model or Titan.
May 21, 1969	<i>Intelsat III F-4</i> was launched successfully and served as a Pacific link.
July 25, 1969	<i>Intelsat III F-5</i> , planned as an Atlantic link, did not obtain proper orbit because of a malfunction of the launch vehicle's third stage.
Jan. 1970	Intelsat IV's thermal design was verified in a seven-day vacuum chamber test at the Jet Propulsion Laboratory.
Jan. 14, 1970	<i>Intelsat III F-6</i> was launched successfully and served as an Atlantic link.
Apr. 1970	Lockheed Missile & Space Company, with 13 other companies as partners, announced plans to compete for the development of a new-generation Intelsat satellite (to be called Intelsat V).
April 22, 1970	<i>Intelsat III F-7</i> was placed in a lower transfer orbit than planned because of a launch vehicle guidance system problem, but it was placed into synchronous orbit by the spacecraft's apogee motor. The satellite served as an Atlantic link.
July 23, 1970	<i>Intelsat III F-8</i> , the last of the series and planned as a Western Pacific link, was placed into the correct transfer orbit, but was lost shortly after its apogee motor fired to put it into synchronous orbit.
Jan. 15, 1971	<i>Intelsat IV F-2</i> , the first of the new series, was successfully launched and served as an Atlantic link.
Dec. 19, 1971	<i>Intelsat IV F-3</i> was launched and served as an Atlantic link.
Jan. 22, 1972	<i>Intelsat IV F-4</i> was launched and served as a Pacific link.
Mar. 1, 1972	Fairchild Industries, Lockheed, and Hughes Aircraft Company submitted bids for an Intelsat V design.
Mar. 27, 1972	Intelsat chose Lockheed to furnish a system design study for an Intelsat V series.
Apr. 28, 1972	Lockheed suggested an Intelsat IV½ design, an uprated IV that would give them additional time to develop the advanced technology required for Intelsat V.
June 13, 1972	<i>Intelsat IV F-5</i> was launched and served as an Indian Ocean link.
Sept. 5, 1972	Hughes and British Aircraft Corporation agreed to study the feasibility of an advanced Intelsat IV satellite with twice the capacity.
Dec. 1972	Because of reservations on the part of the Federal Communications Commission regarding the role of an uprated Intelsat IV as compared to a new trans-Atlantic cable system, Intelsat delayed the purchase of the so-called Intelsat IV½.
Feb. 2, 1973	The uprated Intelsat IV was finally approved by Intelsat; it would be called the IVA.
Mar. 22, 1973	Intelsat approved a contract with Hughes for three Intelsat IVAs; the contract was awarded in May.
Aug. 23, 1973	<i>Intelsat IV F-7</i> was launched and served as an Atlantic link.
Nov. 21, 1974	<i>Intelsat IV F-8</i> was launched and served as a Pacific link.
Dec. 6, 1974	Intelsat awarded Hughes a contract for three more IVAs, for a total of six.
Feb. 20, 1975	<i>Intelsat IV F-6</i> , planned as a Pacific link, was destroyed along with its launcher 450 seconds after liftoff because of a launch vehicle failure.
May 22, 1975	<i>Intelsat IV F-1</i> was launched and served as an Indian Ocean link; it was the last launch of the IV series.
July 17, 1975	Intelsat issued RFPs for an Intelsat V, the design for which was approved in April 1975; proposals were due on November 1, 1975.
Aug. 1, 1975	TRW Systems Group established an industry team and submitted a proposal for the fabrication of seven Intelsat V satellites.
Sept. 26, 1975	<i>Intelsat IVA F-1</i> , the first of the IVA series, was launched and served as an Atlantic link.
Sept. 30, 1975	Aeronutronics Ford Corp. formed an industry team to bid on an Intelsat V satellite.
Jan. 29, 1976	<i>Intelsat IVA F-2</i> was launched and served as an Atlantic link.

Table 4-103. Chronology of Intelsat Development and Operations, 1969-1978  
(Continued)

May 19-27, 1976	Intelsat narrowed the field of Intelsat V competitors to two: Hughes and Aeronutronic Ford. Proposals from Lockheed and TRW were eliminated in March.
July 21-28, 1976	Intelsat chose Aeronutronic Ford for final negotiations for Intelsat V; a contract was awarded in September; the first launch was scheduled for 1979.
May 26, 1977	<i>Intelsat IVA F-4</i> was launched and served as an Atlantic link.
Sept. 29, 1977	<i>Intelsat IVA F-5</i> , planned as an Indian Ocean link, was destroyed 55 seconds after liftoff along with its launch vehicle because of an Atlas-stage malfunction.
Jan. 7, 1978	<i>Intelsat IVA F-3</i> was launched and served as an Indian Ocean link.
March 31, 1978	<i>Intelsat IVA F-6</i> , the last of the IVA series, was launched and served as an Indian Ocean link.
Sept. 1978	Intelsat considered the European Ariane as a possible alternative to Shuttle or Atlas-Centaur for launching its Intelsat V series.
Dec. 1978	Intelsat decided to use Atlas-Centaur, Ariane, and Shuttle for launching its seven Intelsat V satellites. The first four will be launched by Atlas-Centaur, the fifth and seventh will be orbited by Shuttle, and the sixth will be put in place by Ariane. Atlas-Centaur would be made available as a backup launch vehicle if Shuttle did not meet its schedule for operational use.

Table 4-104. Intelsat-III F-3 Characteristics

Date of launch (location):	Feb. 5, 1969 (ETR)
Launch vehicle:	Thrust-Augmented Long-Tank Thor-Delta
Weight (kg):	146 (orbital)
Shape:	Cylindrical with an antenna mounted on one end
Dimensions (m):	1.04 height (1.98 with antenna) 1.42 diameter
Power source:	Solar cells plus NiCd batteries
NASA's role:	Launch vehicle and ground support (reimbursable)
Cooperating organizations:	NASA and Communications Satellite Corporation, representing the International Telecommunications Satellite Consortium (Intelsat)
Prime contractor:	TRW Systems Group
Objectives:	Commercial communications support for five years from synchronous orbit above the equator (Pacific link); capable of 1200 voice circuits or 4 TV channels.
Results:	Successful; moved to Indian Ocean location in May 1969 to a less busy station because of a malfunction; repositioned again in June 1973 over the Pacific to serve as a backup; placed on standby status in May 1977; ceased operations in April 1979.

Reference: NASA, "Intelsat-III F-3 Mission Operations Report," S-633-69-03, Jan. 27, 1969.

Table 4-105. Intelsat-III F-4 Characteristics

---

Date of launch (location): May 21, 1969 (ETR)  
Launch vehicle: Thrust-Augmented Long-Tank Thor-Delta  
Weight (kg): 146 (orbital)  
Shape: Cylindrical with an antenna mounted on one end  
Dimensions (m): 1.04 height (1.98 with antenna)  
1.42 diameter  
Power source: Solar cells plus NiCd batteries  
NASA's role: Launch vehicle and ground support (reimbursable)  
Cooperating organizations: NASA and Communications Satellite Corporation, representing the International Telecommunications Satellite Consortium (Intelsat)  
Prime contractor: TRW Systems Group  
Objectives: Commercial communications support for five years from synchronous orbit above the equator (Pacific link); capable of 1200 voice circuits or 4 TV channels.  
Results: Successful; completed global chain of Intelsat satellites.

---

Reference: NASA, "Intelsat-III F-4 Mission Operations Report," S-633-69-04, May 23, 1969.

Table 4-106. Intelsat-III F-5 Characteristics

---

Date of launch (location): July 25, 1969 (ETR)  
Launch vehicle: Thrust-Augmented Long-Tank Thor-Delta  
Weight (kg): 146 (orbital)  
Shape: Cylindrical with an antenna mounted on one end  
Dimensions (m): 1.04 height (1.98 with antenna)  
1.42 diameter  
Power source: Solar cells plus NiCd batteries  
NASA's role: Launch vehicle and ground support (reimbursable)  
Cooperating organizations: NASA and Communications Satellite Corporation, representing the International Telecommunications Satellite Consortium (Intelsat)  
Prime contractor: TRW Systems Group  
Objectives: Commercial communications support for five years from synchronous orbit above the equator (Atlantic link); capable of 1200 voice circuits or 4 TV channels; replace Intelsat-III F-2.  
Results: Unsuccessful; launch vehicle third stage malfunctioned; satellite was not placed in the proper orbit.

---

Reference: NASA, "Intelsat III F-5 Mission Operations Report," S-633-69-05, July 8, 1969.

Table 4-107. Intelsat-III F-6 Characteristics

---

Date of launch (location): Jan. 14, 1970 (ETR)  
 Launch vehicle: Thrust-Augmented Long-Tank Thor-Delta  
 Weight (kg): 146 (orbital)  
 Shape: Cylindrical with an antenna mounted on one end  
 Dimensions (m): 1.04 height (1.98 with antenna)  
                   1.42 diameter  
 Power source: Solar cells plus NiCd batteries  
 NASA's role: Launch vehicle and ground support (reimbursable)  
 Cooperating organizations: NASA and Communications Satellite Corporation, representing the International Telecommunications Satellite Consortium (Intelsat)  
 Prime contractor: TRW Systems Group  
 Objectives: Commercial communications support for five years from synchronous orbit above the equator (Atlantic link); capable of 1200 voice circuits or 4 TV channels; replace Intelsat-III F-2.  
 Results: Successful.

---

Reference: NASA, "Intelsat III F-6 Mission Operations Report," S-633-70-06, Jan. 5, 1970.

Table 4-108. Intelsat-III F-7 Characteristics

---

Date of launch (location): Apr. 22, 1970 (ETR)  
 Launch vehicle: Thrust-Augmented Long-Tank Thor-Delta  
 Weight (kg): 146 (orbital)  
 Shape: Cylindrical with an antenna mounted on one end  
 Dimensions (m): 1.04 height (1.98 with antenna)  
                   1.42 diameter  
 Power source: Solar cells plus NiCd batteries  
 NASA's role: Launch vehicle and ground support (reimbursable)  
 Cooperating organizations: NASA and Communications Satellite Corporation, representing the International Telecommunications Satellite Consortium (Intelsat)  
 Prime contractor: TRW Systems Group  
 Objectives: Commercial communications support for five years from synchronous orbit above the equator (Atlantic link).  
 Results: Successful; placed in lower transfer orbit than planned due to launch vehicle guidance system anomaly, but was successfully placed into synchronous orbit by the spacecraft's apogee motor.

---

Reference: NASA, "Intelsat III F-7 Mission Operations Report," S-633-70-05, Apr. 21, 1970.

Table 4-109. Intelsat-III F-8 Characteristics

---

Date of launch (location): July 22, 1970 (ETR)  
 Launch vehicle: Thrust-Augmented Long-Tank Thor-Delta  
 Weight (kg): 146 (orbital)  
 Shape: Cylindrical with an antenna mounted on one end  
 Dimensions (m): 1.04 height (1.98 with antenna)  
                   1.42 diameter  
 Power source: Solar cells plus NiCd batteries  
 NASA's role: Launch vehicle and ground support (reimbursable)  
 Cooperating organizations: NASA and Communications Satellite Corporation, representing the International Telecommunications Satellite Consortium (Intelsat)  
 Prime contractor: TRW Systems Group  
 Objectives: Commercial communications support for five years from synchronous orbit above the equator (Western Pacific link).  
 Results: Unsuccessful; launched into correct transfer orbit, but lost after apogee motor fired to put it into synchronous orbit; last of the Intelsat III series.

---

Reference: NASA, "Intelsat III F-8 Mission Operations Report," S-633-70-06, July 17, 1970.

Table 4-110. Intelsat-IV F-2 Characteristics

---

Date of launch (location): Jan. 25, 1971 (ETR)  
 Launch vehicle: Atlas-Centaur  
 Weight (kg): 1403  
 Shape: Cylindrical with an antenna mounted on one end  
 Dimensions (m): 5.36 height  
                   2.37 diameter  
 Power source: Solar cells plus NiCd batteries  
 NASA's role: Launch vehicle and ground support (reimbursable)  
 Cooperating organizations: NASA and Communications Satellite Corporation, representing the International Telecommunications Satellite Consortium (Intelsat)  
 Prime contractor: Hughes Aircraft Co.  
 Objectives: Commercial communications support from synchronous orbit above the equator (Atlantic link); capable of 3000 to 9000 telephone circuits or 12 color TV channels or a combination of telephone, TV, data, and other forms of communications.  
 Results: Successful; first of a new series.

---

Reference: NASA, "Intelsat IV F-2 Mission Operations Report," S-634-71-01, Jan. 17, 1971.

Table 4-111. Intelsat-IV F-3 Characteristics

---

Date of launch (location): Dec. 19, 1971 (ETR)  
Launch vehicle: Atlas-Centaur  
Weight (kg): 1403  
Shape: Cylindrical with an antenna mounted on one end  
Dimensions (m): 5.36 height  
                  2.37 diameter  
Power source: Solar cells plus NiCd batteries  
NASA's role: Launch vehicle and ground support (reimbursable)  
Cooperating organizations: NASA and Communications Satellite Corporation, representing the International Telecommunications Satellite Consortium (Intelsat)  
Prime contractor: Hughes Aircraft Co.  
Objectives: Commercial communications support from synchronous orbit above the equator (Atlantic link); capable of 3000 to 9000 telephone circuits or 12 color TV channels or a combination of telephone, TV, data, and other forms of communications.  
Results: Successful.

---

Reference: NASA, "Intelsat-IV F-3 Mission Operations Report," S-634-71-02, Nov. 23, 1971.

Table 4-112. Intelsat-IV F-4 Characteristics

---

Date of launch (location): Jan. 22, 1972 (ETR)  
Launch vehicle: Atlas-Centaur  
Weight (kg): 1387  
Shape: Cylindrical with an antenna mounted on one end  
Dimensions (m): 5.36 height  
                  2.37 diameter  
Power source: Solar cells plus NiCd batteries  
NASA's role: Launch vehicle and ground support (reimbursable)  
Cooperating organizations: NASA and Communications Satellite Corporation, representing the International Telecommunications Satellite Consortium (Intelsat)  
Prime contractor: Hughes Aircraft Co.  
Objectives: Commercial communications support from synchronous orbit above the equator (Pacific link); capable of 3000 to 9000 telephone circuits or 12 color TV channels or a combination of telephone, TV, data, and other forms of communications.  
Results: Successful.

---

Reference: NASA, "Intelsat IV F-4 Mission Operations Report," E-634-72-03, Jan. 20, 1972.



Table 4-113. Intelsat-IV F-5 Characteristics

---

Date of launch (location): June 13, 1972 (ETR)  
Launch vehicle: Atlas-Centaur  
Weight (kg): 1387  
Shape: Cylindrical with an antenna mounted on one end  
Dimensions (m): 5.36 height  
                  2.37 diameter  
Power source: Solar cells plus NiCd batteries  
NASA's role: Launch vehicle and ground support (reimbursable)  
Cooperating organizations: NASA and Communications Satellite Corporation, representing the International Telecommunications Satellite Consortium (Intelsat)  
Prime contractor: Hughes Aircraft Co.  
Objectives: Commercial communications support from synchronous orbit above the equator (Indian link); capable of 3000 to 9000 telephone circuits or 12 color TV channels or a combination of telephone, TV, data, and other forms of communications.  
Results: Successful.

---

Reference: NASA, "Intelsat IV F-5 Mission Operations Report," E-634-72-04, June 12, 1972.

Table 4-114. Intelsat-IV F-6 Characteristics

---

Date of launch (location): Feb. 20, 1975 (ETR)  
Launch vehicle: Atlas-SLV-3D-Centaur D-1A  
Weight (kg): 1387  
Shape: Cylindrical with an antenna mounted on one end  
Dimensions (m): 5.36 height  
                  2.37 diameter  
Power source: Solar cells plus NiCd batteries  
NASA's role: Launch vehicle and ground support (reimbursable)  
Cooperating organizations: NASA and Communications Satellite Corporation, representing the International Telecommunications Satellite Consortium (Intelsat)  
Prime contractor: Hughes Aircraft Co.  
Objectives: Commercial communications support from synchronous orbit above the equator (Pacific link); capable of 3000 to 9000 telephone circuits or 12 color TV channels or a combination of telephone, TV, data, and other forms of communications.  
Results: Unsuccessful; launch vehicle failed and range safety officer destroyed spacecraft and vehicle 450 seconds after liftoff.

---

Reference: NASA, "Intelsat IV F-6 Mission Operations Report," E-634-75-07, Feb. 26, 1975.

Table 4-115. Intelsat-IV F-7 Characteristics

---

Date of launch (location): Aug. 23, 1973 (ETR)  
 Launch vehicle: Atlas SLV-3D-Centaur D-1A  
 Weight (kg): 1387  
 Shape: Cylindrical with an antenna mounted on one end  
 Dimensions (m): 5.36 height  
                   2.37 diameter  
 Power source: Solar cells plus NiCd batteries  
 NASA's role: Launch vehicle and ground support (reimbursable)  
 Cooperating organizations: NASA and Communications Satellite Corporation, representing the International Telecommunications Satellite Consortium (Intelsat)  
 Prime contractor: Hughes Aircraft Co.  
 Objectives: Commercial communications support from synchronous orbit above the equator (Atlantic link); capable of 3000 to 9000 telephone circuits or 12 color TV channels or a combination of telephone, TV, data, and other forms of communications.  
 Results: Successful.

---

Reference: NASA, "Intelsat IV F-7 Mission Operations Report," E-634-73-05, Aug. 23, 1973.

Table 4-116. Intelsat-IV F-8 Characteristics

---

Date of launch (location): Nov. 21, 1974 (ETR)  
 Launch vehicle: Atlas SLV-3D-Centaur D-1A  
 Weight (kg): 1387  
 Shape: Cylindrical with an antenna mounted on one end  
 Dimensions (m): 5.36 height  
                   2.37 diameter  
 Power source: Solar cells plus NiCd batteries  
 NASA's role: Launch vehicle and ground support (reimbursable)  
 Cooperating organizations: NASA and Communications Satellite Corporation, representing the International Telecommunications Satellite Consortium (Intelsat)  
 Prime contractor: Hughes Aircraft Co.  
 Objectives: Commercial communications support from synchronous orbit above the equator (Pacific link); capable of 3000 to 9000 telephone circuits or 12 color TV channels or a combination of telephone, TV, data, and other forms of communications.  
 Results: Successful.

---

Reference: NASA, "Intelsat-IV F-8 Mission Operations Report," E-634-74-06, Nov. 22, 1974.

Table 4-117. Intelsat-IV F-1 Characteristics

---

Date of launch (location): May 22, 1975 (ETR)  
Launch vehicle: Atlas SLV-3D-Centaur D-1A  
Weight (kg): 1387  
Shape: Cylindrical with an antenna mounted on one end  
Dimensions (m): 5.36 height  
                  2.37 diameter  
Power source: Solar cells plus NiCd batteries  
NASA's role: Launch vehicle and ground support (reimbursable)  
Cooperating organizations: NASA and Communications Satellite Corporation, representing the International Telecommunications Satellite Consortium (Intelsat)  
Prime contractor: Hughes Aircraft Co.  
Objectives: Commercial communications support for synchronous orbit above the equator (Indian link); capable of 3000 to 9000 telephone circuits or 12 color TV channels or a combination of telephone, TV, data, and other forms of communications.  
Results: Successful; last of Intelsat IV series.

---

Reference: NASA, "Intelsat IV F-1 Mission Operations Report," E-634-75-08, May 16, 1975.

Table 4-118. Intelsat-IVA F-1 Characteristics

---

Date of launch (location): Sept. 26, 1975 (ETR)  
Launch vehicle: Atlas SLV-3D-Centaur D-1AR  
Weight (kg): 826  
Shape: Cylindrical with three antennas mounted on one end supported by a single mast  
Dimensions (m): 6.99 overall height  
                  2.38 diameter  
Power source: Solar cells plus 2 NiCd batteries  
NASA's role: Launch vehicle and ground support (reimbursable)  
Cooperating organizations: NASA and Communications Satellite Corporation, representing the International Telecommunications Satellite Consortium (Intelsat)  
Prime contractor: Hughes Aircraft Co.  
Objectives: Commercial communications support from synchronous orbit above the equator (Atlantic link); capable of 6250 two-way voice circuits and 2 color TV channels.  
Results: Successful; first of a new intermediate series.

---

Reference: NASA, "Intelsat IVA F-1 Mission Operations Report," E-491-633-75-01, Sept. 25, 1975.

Table 4-119. Intelsat-IVA F-2 Characteristics

---

Date of launch (location): Jan. 29, 1976 (ETR)  
 Launch vehicle: Atlas SLV-3D-Centaur D-1AR  
 Weight (kg): 826  
 Shape: Cylindrical with three antennas mounted on one end supported by a single mast  
 Dimensions (m): 6.99 overall height  
                   2.38 diameter  
 Power source: Solar cells plus 2 NiCd batteries  
 NASA's role: Launch vehicle and ground support (reimbursable)  
 Cooperating organizations: NASA and Communications Satellite Corporation, representing the International Telecommunications Satellite Consortium (Intelsat)  
 Prime contractor: Hughes Aircraft Co.  
 Objectives: Commercial communications support from synchronous orbit above the equator (Atlantic link); capable of 6250 two-way voice circuits and 2 color TV channels.  
 Results: Successful.

---

Reference: NASA, "Intelsat IVA F-2 Mission Operations Report," E-491-633-76-02, Feb. 12, 1976.

Table 4-120. Intelsat-IVA F-4 Characteristics

---

Date of launch (location): May 26, 1977 (ETR)  
 Launch vehicle: Atlas SLV-3D-Centaur D-1AR  
 Weight (kg): 826  
 Shape: Cylindrical with three antennas mounted on one end supported by a single mast  
 Dimensions (m): 6.99 overall height  
                   2.38 diameter  
 Power source: Solar cells plus 2 NiCd batteries  
 NASA's role: Launch vehicle and ground support (reimbursable)  
 Cooperating organizations: NASA and Communications Satellite Corporation, representing the International Telecommunications Satellite Consortium (Intelsat)  
 Prime contractor: Hughes Aircraft Co.  
 Objectives: Commercial communications support from synchronous orbit above the equator (Atlantic link); capable of 6250 two-way voice circuits and 2 color TV channels.  
 Results: Successful.

---

Reference: NASA, "Intelsat-IVA F-4 Mission Operations Report," E-491-633-77-05, May 20, 1977.

Table 4-121. Intelsat-IVA F-5 Characteristics

---

Date of launch (location): Sept. 29, 1977 (ETR)  
 Launch vehicle: Atlas SLV-3D-Centaur D-1AR  
 Weight (kg): 826  
 Shape: Cylindrical with three antenna mounted on one end supported by a single mast  
 Dimensions (m): 6.99 overall height  
                   2.38 diameter  
 Power source: Solar cells plus 2 NiCd batteries  
 NASA's role: Launch vehicle and ground support (reimbursable)  
 Cooperating organizations: NASA and Communications Satellite Corporation, representing the International Telecommunications Satellite Consortium (Intelsat)  
 Prime contractor: Hughes Aircraft Co.  
 Objectives: Commercial communications support for synchronous orbit above the equator (Indian link); capable of 6250 two-way voice circuits and 2 color TV channels.  
 Results: Unsuccessful; Atlas stage of the launch vehicle malfunctioned; range safety officer destroyed vehicle 55 seconds after liftoff.

---

Reference: NASA, "Intelsat-IVA F-5 Mission Operations Report," E-491-633-77-06, Sept 15, 1977.

Table 4-122. Intelsat-IVA F-3 Characteristics

---

Date of launch (location): Jan. 7, 1978 (ETR)  
 Launch vehicle: Atlas SLV-3D-Centaur D-1AR  
 Weight (kg): 826  
 Shape: Cylindrical with three antennas mounted on one end supported by a single mast  
 Dimensions (m): 6.99 overall height  
                   2.38 diameter  
 Power source: Solar cells plus 2 NiCd batteries  
 NASA's role: Launch vehicle and ground support (reimbursable)  
 Cooperating organizations: NASA and Communications Satellite Corporation, representing the International Telecommunications Satellite Consortium (Intelsat)  
 Prime contractor: Hughes Aircraft Co.  
 Objectives: Commercial communications support for synchronous orbit above the equator (Indian link); capable of 6250 two-way voice circuits and 2 color TV channels.  
 Results: Successful.

---

Reference: NASA, "Intelsat-IVA F-3 Mission Operations Report," E-491-633-78-05, Jan. 5, 1978.

Table 4-123. Intelsat-IVA F-6 Characteristics

---

Date of launch (location): Mar. 31, 1978 (ETR)  
 Launch vehicle: Atlas SLV-3D-Centaur D-1AR  
 Weight (kg): 826  
 Shape: Cylindrical with three antennas mounted on one end supported by a single mast  
 Dimensions (m): 6.99 overall height  
                   2.38 diameter  
 Power source: Solar cells plus 2 NiCd batteries  
 NASA's role: Launch vehicle and ground support (reimbursable)  
 Cooperating organizations: NASA and Communications Satellite Corporation, representing the International Telecommunications Satellite Consortium (Intelsat)  
 Prime contractor: Hughes Aircraft Co.  
 Objectives: Commercial communications support for synchronous orbit above the equator (Indian link); capable of 6250 two-way voice circuits and 2 color TV channels.  
 Results: Successful; last of the IVA series.

---

Reference: NASA, "Intelsat-IVA F-6 Mission Operations Report," E-491-633-78-06, Mar. 20, 1978.

Table 4-124. Marisat 1 Characteristics

---

Date of launch (location): Feb. 19, 1976 (ETR)  
 Launch vehicle: Delta 2914  
 Weight (kg): 655  
 Shape: Cylindrical with three antennas mounted on one end  
 Dimensions (m): 3.66 overall height  
                   2.13 diameter  
 Power source: Solar cells plus NiCd batteries  
 NASA's role: Launch vehicle and ground support (reimbursable)  
 Cooperating organizations: NASA and Comsat General  
 Prime contractor: Hughes Aircraft Co.  
 Objectives: Participate in a three-satellite maritime commercial communications system (Atlantic link); provide operational communications for the Navy for two years under lease; improve ability to transmit/receive distress signals, search and rescue traffic, and weather reports.  
 Results: Successful; Navy extended operations through 1981; ground stations were operated at Santa Paula, CA, and Southbury, CT.

---

Reference: NASA, "Project Marisat A," Press Release 76-22, Feb. 6, 1976.

Table 4-125. Marisat 2 Characteristics

---

Date of launch (location): June 10, 1976 (ETR)  
 Launch vehicle: Delta 2914  
 Weight (kg): 655  
 Shape: Cylindrical with three antennas mounted on one end  
 Dimensions (m): 3.66 overall length  
                   2.13 diameter  
 Power source: Solar cells plus NiCd batteries  
 NASA's role: Launch vehicle and ground support (reimbursable)  
 Cooperating organizations: NASA and Comsat General  
 Prime contractor: Hughes Aircraft Co.  
 Objectives: Participate in a three-satellite maritime commercial communications system (Pacific link).  
 Results: Successful.

---

Reference: NASA, "Project Marisat B," Press Release 76-June 1976.

Table 4-126. Marisat 3 Characteristics

---

Date of launch (location): Oct. 14, 1976 (ETR)  
 Launch vehicle: Delta 2914  
 Weight (kg): 655  
 Shape: Cylindrical with three antennas mounted on one end  
 Dimensions (m): 3.66 overall length  
                   2.13 diameter  
 Power source: Solar cells plus NiCd batteries  
 NASA's role: Launch vehicle and ground support (reimbursable)  
 Cooperating organizations: NASA and Comsat General  
 Prime contractor: Hughes Aircraft Co.  
 Objectives: Participate in a three-satellite maritime commercial communications system (Indian link).  
 Results: Successful.

---

Reference: NASA, "Marisat C Mission Operations Report," M-492-25-76-02, Oct. 14, 1976.

Table 4-127. NATO 1 Characteristics

---

Date of launch (location): Mar. 20, 1970 (ETR)  
 Launch vehicle: Delta DSV-3M  
 Weight (kg): 190  
 Shape: Cylindrical  
 Dimensions (m): 0.81 height  
                   1.37 diameter  
 Power source: Solar cells plus NiCd batteries  
 NASA's role: Launch vehicle and ground support (reimbursable)  
 Cooperating organizations: NASA, Department of Defense, USAF, and NATO  
 Prime contractor: Philco Ford Space & Reentry Systems Division for USAF  
 Responsible NASA center: Goddard Space Flight Center  
 Project manager: Robert Goss  
 Objectives: Military communications  
 Results: Successful; one of two.

---

Reference: NASA, "NATO-A Pre-Launch Mission Operations Report," S-492-70-01, March 5, 1970.

Table 4-128. NATOSAT 2 Characteristics

---

Also called: NATO 2

Date of launch (location): Feb. 2, 1971 (ETR)

Launch vehicle: Delta DSV-3M

Weight (kg): 190

Shape: Cylindrical

Dimensions (m): 0.81 height  
1.37 diameter

Power source: Solar cells plus NiCd batteries

NASA's role: Launch vehicle and ground support (reimbursable)

Cooperating organizations: NASA, Department of Defense, USAF, and NATO

Prime contractor: Philco Ford Space & Reentry Systems Division for USAF

Responsible NASA center: Goddard Space Flight Center

Project manager: Robert Goss

Objectives: Military communications

Results: Successful; greater capacity than NATO 1.

---

Reference: NASA, "NATO-B Pre-Launch Mission Operations Report," S-492-70-02, Aug. 11, 1970.

Table 4-129. NATO III A Characteristics

---

Date of launch (location): Apr. 22, 1976 (ETR)

Launch vehicle: Delta 2914

Weight (kg): 720

Shape: Cylindrical

Dimensions (m): 2.23 length (3.1 overall length)  
2.20 diameter

Power source: Solar cells plus NiCd batteries

NASA's role: Launch vehicle (reimbursable)

Cooperating organizations: NASA, Department of Defense, USAF, and NATO

Prime contractor: Philco Ford Space & Reentry Systems Division for USAF

Responsible NASA center: Goddard Space Flight Center

Project manager: Robert Goss

Objectives: Military communications

Results: Successful; greater capacity than NATO 1 or NATOSAT 2; operated as part of the NATO Defense Satellite Communications System.

---

Reference: NASA, "NATO III A Mission Operations Report," M-492-207-76-01, Apr. 19, 1976.

Table 4-130. NATO III B Characteristics

---

Date of launch (location): Jan. 28, 1977 (ETR)

Launch vehicle: Delta 2914

Weight (kg): 720

Shape: Cylindrical

Dimensions (m): 2.23 length (3.1 overall length)  
2.20 diameter

Power source: Solar cells plus NiCd batteries

NASA's role: Launch vehicle (reimbursable)

Cooperating organizations: NASA, Department of Defense, USAF, and NATO

Prime contractor: Philco Ford Space & Reentry Systems Division for USAF

Responsible NASA center: Goddard Space Flight Center

Project manager: Robert Goss

Objectives: Military communications

Results: Successful.

---

Reference: NASA, "NATO-III B Communications Satellite," M-492-207-77-02, Jan. 18, 1977.

Table 4-131. NATO III C Characteristics

---

Date of launch (location): Nov. 19, 1978 (ETR)  
 Launch vehicle: Delta 2914  
 Weight (kg): 720  
 Shape: Cylindrical  
 Dimensions (m): 2.23 length (3.1 overall length)  
                   2.20 diameter  
 Power source: Solar cells plus NiCd batteries  
 NASA's role: Launch vehicle (reimbursable)  
 Cooperating organizations: NASA, Department of Defense, USAF, and NATO  
 Prime contractor: Philco Ford Space & Reentry Systems Division for USAF  
 Responsible NASA center: Goddard Space Flight Center  
 Project manager: Robert Goss  
 Objectives: Military communications  
 Results: Successful.

---

Reference: NASA, "NATO-III C Communications Satellite," M-492-207-78-03, Nov. 15, 1978.

Table 4-132. Oscar 5 Characteristics

---

Also called: Australis, Oscar A; Orbiting Satellite—Carrying Amateur Radio (Oscar)  
 Date of launch (location): Jan. 23, 1970 (ETR)  
 Launched with: Itos 1  
 Launch vehicle: Delta N-6  
 Weight (kg): 14  
 Shape: Cylindrical  
 Power source: Batteries  
 NASA's role: Launch vehicle (launched on a noninterference basis piggyback with other payloads; no NASA objectives)  
 Cooperating organizations: NASA, University of Melbourne, and Radio Amateur Satellite Corp.  
 Spacecraft provider: Amateur radio operators at the University of Melbourne  
 Objectives: Broadcast low-frequency radio transmissions for two months for use by ham radio operators' experiments.  
 Results: Successful; last of the first-generation Oscar satellites.

---

Reference: NASA, "ITOS 1 Mission Operations Report," S-601-69-10, Dec. 22, 1969.

Table 4-133. Oscar 6 Characteristics

---

Also called: AMSAT  
 Date of launch (location): Oct. 15, 1972 (WTR)  
 Launched with: NOAA 2  
 Launch vehicle: Delta 0300  
 Weight (kg): 18.5  
 Shape: Rectangular  
 Power source: Solar cells and batteries  
 NASA's role: Launch vehicle (launched on a noninterference basis piggyback with other payloads; no NASA objectives)  
 Cooperating organizations: NASA and Radio Amateur Satellite Corp.  
 Spacecraft provider: Radio Amateur Satellite Corp  
 Objectives: Conduct a one-year experimental program of multiple access communications with a large number of low-powered ham radio equipment.  
 Results: Successful; first of a new generation of Oscar satellites.

---

Reference: NASA, "Improved TIROS Operational Satellite (ITOS-D) Mission Operations Report," E-601-72-13, Oct. 3, 1972.



Table 4-134. Oscar 7 Characteristics

---

Also called: AMSAT  
Date of launch (location): Nov. 15, 1974 (WTR)  
Launched with: NOAA 4  
Launch vehicle: Delta 2310  
Weight (kg): 29.5  
Shape: Rectangular  
Dimensions (m): 0.42 diameter  
                  0.43 height  
Power source: Solar cells and batteries  
NASA's role: Launch vehicle (launched on a noninterference basis piggyback with other payloads; no NASA objectives)  
Cooperating organizations: NASA and Radio Amateur Satellite Corp.  
Spacecraft provider: Radio Amateur Satellite Corp.  
Objectives: Conduct a three-year educational program; demonstrate feasibility of use of "bush" emergency, medical, aeronautical, maritime, and land mobile communications.  
Results: Successful.

---

Reference: NASA, "NOAA 4 Mission Operations Report," E-601-74-16, Oct. 18, 1974.

Table 4-135. Oscar 8 Characteristics

---

Also called: AMSAT  
Date of launch (location): Mar. 5, 1978 (WTR)  
Launched with: Landsat 3  
Launch vehicle: Delta  
Weight (kg): 27  
Shape: Rectangular  
Dimensions (m): 0.42 diameter  
                  0.43 height  
Power source: Solar cells and batteries  
NASA's role: Launch vehicle (launched on a noninterference basis piggyback with other payloads; no NASA objectives)  
Cooperating organizations: NASA and Radio Amateur Satellite Corp.  
Spacecraft provider: Radio Amateur Satellite Corp.  
Objectives: Expand educational programs that bring communications satellites into U.S. and Canadian classrooms; provide communications for a wide range of ham radio experiments.  
Results: Successful.

---

Reference: NASA, "Landsat 3 Mission Operations Report," E-641-78-03, Feb. 22, 1978.

Table 4-136. OTS 1 Characteristics

---

Also called: Orbital Test Satellite; Operations Technology Satellite  
 Date of launch (location): Sept. 13, 1977 (ETR)  
 Launch vehicle: Delta 3914  
 Weight (kg): 865  
 Shape: Six-sided with two solar panels  
 Dimensions (m): 2.13 length (9.26 with solar array deployed)  
                   2.39 height  
 Power source: Solar panels and NiCd battery  
 NASA's role: Launch vehicle (reimbursable)  
 Cooperating organizations: NASA and European Space Agency  
 Prime contractor: Hawker Siddeley Dynamics  
 Objectives: Three-year commercial communications system for Europe; capable of 6000 telephone circuits.  
 Results: Unsuccessful; Castor IV strap-on motor malfunctioned during launch; vehicle exploded 54 seconds after liftoff.

---

Reference: ESA, "ESA's OTS-2 Communications Satellite Due to Launch End April," ESA news release, Apr. 7, 1978; and NASA, "OTS 1 Mission Operations Report," M-492-210-77-01, Sept. 8, 1977.

Table 4-137. OTS 2 Characteristics

---

Also called: Orbital Test Satellite; Operations Technology Satellite  
 Date of launch (location): May 11, 1978 (ETR)  
 Launch vehicle: Delta 3914  
 Weight (kg): 865  
 Shape: Six-sided with solar panels  
 Dimensions (m): 2.39 height  
                   2.13 length (9.26 with solar panels deployed)  
 Power source: Solar panels plus NiCd battery  
 NASA's role: Launch vehicle (reimbursable)  
 Cooperating organizations: NASA and European Space Agency  
 Prime contractor: Hawker Siddeley Dynamics  
 Objectives: Three-year commercial communications system for Europe; capable of 6000 telephone circuits.  
 Results: Successful.

---

Reference: ESA, "OTS—One Year in Orbit," ESA News Release, May 16, 1979.

Table 4-138. P76-5 Wideband Characteristics

---

Date of launch (location): May 22, 1976 (WTR)  
 Launch vehicle: Scout  
 Weight (kg): 72.6  
 Shape: Rectangular  
 Dimensions (m): Not available  
 Power source: Not available  
 NASA's role: Launch vehicle (reimbursable)  
 Cooperating organizations: NASA and U.S. Air Force  
 Prime contractor: Not available  
 Objectives: To evaluate certain propagation effects of disturbed plasmas on radar and communications systems.  
 Results: Launch Successful.

---

Reference: NASA, "P76-5 Mission Operations Report," M-490-602-76-01, Apr. 21, 1976.

Table 4-139. Palapa 1 Characteristics

---

Date of launch (location): July 8, 1976 (ETR)  
Launch vehicle: Delta 2914  
Weight (kg): 574  
Shape: Cylindrical with antenna mounted on one end.  
Dimensions (m): 1.83 diameter  
                    3.35 height  
Power source: Solar cells plus NiCd batteries  
NASA's role: Launch vehicle (reimbursable)  
Cooperating organizations: NASA and Indonesia  
Responsible NASA center: Goddard Space Flight Center  
Project manager: Robert Goss  
Prime contractor: Hughes Aircraft Co. for the government of Indonesia  
Objectives: To provide commercial communications for 7 years; capable of 12 color TV channels or  
                    4000 telephone circuits (identical to Canadian Telesat and Westar satellites)  
Results: Successful; first of a series of Indonesian satellites.

---

Reference: NASA, "Palapa 1 Mission Operations Report," M-492-208-76-01, July 1, 1976.

Table 4-140. Palapa 2 Characteristics

---

Date of launch (location): Mar. 10, 1977 (ETR)  
Launch vehicle: Delta 2914  
Weight (kg): 574  
Shape: Cylindrical with antenna mounted on one end  
Dimensions (m): 1.83 diameter  
                    3.35 height  
Power source: Solar cells plus NiCd batteries  
NASA's role: Launch vehicle (reimbursable)  
Cooperating organizations: NASA and Indonesia  
Responsible NASA center: Goddard Space Flight Center  
Project manager: Robert Goss  
Prime contractor: Hughes Aircraft Co., for the government of Indonesia  
Objectives: To provide commercial communications for 7 years; capable of 12 color TV channels or  
                    4000 telephone circuits (identical to Canadian Telesat and Westar satellites).  
Results: Successful.

---

Reference: NASA, "Palapa B Mission," M-492-208-77-02, Apr. 30, 1977.

Table 4-141. SATCOM 1 Characteristics

---

Also called: RCA 1  
Date of launch (location): Dec. 13, 1975 (ETR)  
Launch vehicle: Delta 3914  
Weight (kg): 867  
Shape: Rectangular with two solar panels extended on booms from opposite sides and an antenna and reflector mounted on one end.  
Dimensions (m): 1.62 width  
1.17 height (11.28 with panels deployed)  
Power source: Solar cells plus NiCd batteries  
NASA's role: Launch vehicle (reimbursable)  
Cooperating organizations: NASA and RCA  
Responsible NASA center: Goddard Space Flight Center  
Project manager: Robert Goss  
Prime contractor: RCA Corp.; Astro-Electronics Div. for RCA Global Communications, Inc.; and RCA Alaska Communications, Inc.  
Objectives: To provide commercial communications for 8 years to the U.S.; capable of 24 color TV channels or 24 000 telephone circuits.  
Results: Successful; first launch of a planned three-satellite network.

---

Reference: NASA, "SATCOM 1 Mission Operations Report," M-492-206-75-01, Dec. 4, 1975.

Table 4-142. SATCOM 2 Characteristics

---

Also called: RCA 2  
Date of launch (location): Mar. 26, 1976 (ETR)  
Launch vehicle: Delta 3914  
Weight (kg): 867  
Shape: Rectangular with two solar panels extended on booms from opposite sides and an antenna and reflector mounted on one end  
Dimensions (m): 1.62 width  
1.17 height (11.28 with panels deployed)  
Power source: Solar cells plus NiCd batteries  
NASA's role: Launch vehicle (reimbursable)  
Cooperating organizations: NASA and RCA  
Responsible NASA center: Goddard Space Flight Center  
Project manager: Robert Goss  
Prime contractor: RCA Corp.; Astro-Electronics Div. for RCA Global Communications, Inc.; and RCA Alaska Communications, Inc.  
Objectives: To provide commercial communications for 8 years to the U.S.; capable of 24 color TV channels or 24 000 telephone circuits.  
Results: Successful; satellite began experiencing control problems in Sept. 1979.

---

Reference: NASA, "SATCOM 2 Mission Operations Report," M-492-206-75-02, Mar. 18, 1976.

Table 4-143. Sirio Characteristics

---

Date of launch (location): Aug. 25, 1977 (ETR)  
 Launch vehicle: Delta 2313  
 Weight (kg): 398  
 Shape: Cylindrical with antenna mounted on one end  
 Dimensions (m): 1.44 diameter  
                   0.95 height (2 overall)  
 Power source: Solar cells plus NiCd batteries  
 NASA's role: Launch vehicle (reimbursable)  
 Cooperating organizations: NASA and Italy  
 Responsible NASA center: Goddard Space Flight Center  
 Project manager: Robert Goss  
 Prime contractor: Compagnia Industriale Aerospaziale for the government of Italy.  
 Objectives: To conduct communications technology experiments and study effects of meteorological conditions on signal propagation.  
 Results: Successful.

---

Reference: NASA, "Sirio Mission Operations Report," M-492-209-77-01, Aug. 11, 1977.

Table 4-144. Skynet 1 Characteristics

---

Also called: IDCSP/A Spacecraft  
 Date of launch (location): Nov. 21, 1969 (ETR)  
 Launch vehicle: Delta DSV-3M  
 Weight (kg): 243  
 Shape: Cylindrical with antenna mounted on one end  
 Dimensions (m): 1.37 diameter  
                   0.81 height (1.6 overall)  
 Power source: Solar cells plus NiCd batteries  
 NASA's role: Launch vehicle (reimbursable)  
 Cooperating organizations: NASA and the United Kingdom  
 Responsible NASA center: Goddard Space Flight Center  
 Project manager: Robert Goss  
 Prime contractor: Philco Ford  
 Objectives: To provide military communications support as part of the Initial Defense Communications Satellite Program/Augmented (U.K.); serve as the Indian Ocean link in the system.  
 Results: Successful.

---

Reference: NASA, "Skynet 1 Mission Operations Report," S-890-69-01, Nov. 10, 1969.

Table 4-145. Skynet 2 Characteristics

---

Also called: IDCSP/A Spacecraft  
 Date of launch (location): Aug. 19, 1970 (ETR)  
 Launch vehicle: Delta DSV-3M  
 Weight (kg): 243  
 Shape: Cylindrical with antenna mounted on one end.  
 Dimensions (m): 1.37 diameter  
                   0.81 height (1.6 overall)  
 Power source: Solar cells plus NiCd batteries  
 NASA's role: Launch vehicle (reimbursable)  
 Cooperating organizations: NASA and the United Kingdom  
 Responsible NASA center: Goddard Space Flight Center  
 Project manager: Robert Goss  
 Prime contractor: Philco Ford  
 Objectives: To provide military communications support as part of the Initial Defense Communications Satellite Program/Augmented (U.K.); serve as the Indian Ocean link in the system.  
 Results: Unsuccessful; malfunctioning onboard apogee motor prevented deployment to synchronous orbit.

---

Reference: NASA, "Skynet 2 Mission Operations Report," S-890-70-02, Aug. 3, 1970.

Table 4-146. Skynet IIA Characteristics

---

Date of launch (location): Jan. 18, 1974 (ETR)  
 Launch vehicle: Delta 2313  
 Weight (kg): 435  
 Shape: Cylindrical with antenna mounted on one end  
 Dimensions (m): 1.90 diameter  
                   2.09 height  
 Power source: Solar cells plus NiCd batteries  
 NASA's role: Launch vehicle (reimbursable)  
 Cooperating organizations: NASA and the United Kingdom  
 Responsible NASA center: Goddard Space Flight Center  
 Project manager: Robert Goss  
 Prime contractor: Marconi Space and Defense Systems, Ltd.  
 Objectives: To provide military communications support as part of the Initial Defense Communications Satellite Program/Augmented (U.K.); serve as the Indian Ocean link in the system; second-generation Skynet satellite design.  
 Results: Unsuccessful; second stage of the launch vehicle failed.

---

Reference: NASA, "Skynet IIA Mission Operations Report," S-890-74-03, Jan. 8, 1974.

Table 4-147. Skynet IIB Characteristics

---

Date of launch (location): Nov. 22, 1974 (ETR)  
 Launch vehicle: Delta 2313  
 Weight (kg): 435  
 Shape: Cylindrical with antenna mounted on one end  
 Dimensions (m): 1.90 diameter  
                   2.09 height  
 Power source: Solar cells plus NiCd batteries  
 NASA's role: Launch vehicle (reimbursable)  
 Cooperating organizations: NASA and the United Kingdom  
 Responsible NASA center: Goddard Space Flight Center  
 Project manager: Robert Goss  
 Prime contractor: Marconi Space and Defense Systems, Ltd.  
 Objectives: To provide military communications support as part of the Initial Defense Communications Satellite Program/Augmented (U.K.); serve as the Indian Ocean link in the system; second-generation Skynet satellite design.  
 Results: Successful.

---

Reference: NASA, "Skynet IIB Mission Operations Report," S-890-74-04, Nov. 7, 1974.

Table 4-148. Symphonie 1 Characteristics

---

Date of launch (location): Dec. 18, 1974 (ETR)  
 Launch vehicle: Delta 2914  
 Weight (kg): 402  
 Shape: Hexagonal cylinder with three solar-panel wings  
 Dimensions (m): 1.85 diameter (2.5 tip-to-tip)  
                   0.50 height  
 Power source: Solar panels plus NiCd batteries  
 NASA's role: Launch vehicle (reimbursable)  
 Cooperating organizations: NASA, the Federal Republic of Germany, and France  
 Responsible NASA center: Goddard Space Flight Center  
 Project manager: Robert Goss  
 Prime contractor: Consortium Industriel France—Allemand pour Symphonie for the FRG  
 Objectives: To provide experimental communications between Europe and Africa and South America; capable of 1200 telephone, 8 voice, or 2 color TV circuits.  
 Results: Successful.

---

Reference: NASA, "Symphonie 1 Mission Operations Report," S-492-204-74-01, Dec. 3, 1974.

Table 4-149. Symphonie 2 Characteristics

---

Date of launch (location): Aug. 27, 1975 (ETR)  
 Launch vehicle: Delta 2914  
 Weight (kg): 402  
 Shape: Hexagonal cylinder with three solar-panel wings  
 Dimensions (m): 1.85 diameter (2.5 tip-to-tip)  
                     0.50 height  
 Power source: Solar panels plus NiCd batteries  
 NASA's role: Launch vehicle (reimbursable)  
 Cooperating organizations: NASA, the Federal Republic of Germany, and France  
 Responsible NASA center: Goddard Space Flight Center  
 Project manager: Robert Goss  
 Prime contractor: Consortium Industriel France—Allemand pour Symphonie for the FRG  
 Objectives: To provide experimental communications between Europe and Africa and South America;  
                     capable of 1200 telephone, 8 voice, or 2 color TV circuits.  
 Results: Successful.

---

Reference: NASA, "Symphonie 2 Mission Operations Report," S-492-204-75-02, July 25, 1975.

Table 4-150. Triad OI-1X (Transit) Characteristics

---

Also called: Transit INS-1  
 Date of launch (location): Sept. 2, 1972 (WTR)  
 Launch vehicle: Scout  
 Weight (kg): 94  
 Shape: Central body cylindrical; joined by booms to two other sections (power unit, disturbance compensation unit, and electronics unit)  
 Dimensions (m): 0.76 width  
                     7.47 overall length  
 Power source: RTG 930 watts  
 NASA's role: Launch vehicle (reimbursable)  
 Cooperating organizations: NASA and U.S. Navy  
 Responsible NASA center: Goddard Space Flight Center  
 Project manager: Robert Goss  
 Prime contractor: Johns Hopkins Applied Physics Laboratory  
 Objectives: To provide communications support for military navigation.  
 Results: Successful.

---

Reference: DoD, Off. of Ass't. Secretary of Defense, "Navy Navigation Satellite," Fact Sheet, n.d.; and DoD, Off. of Ass't. Secretary of Defense, "Navy and Commercial Users Share Navigation Satellite," News Release 632-72, Sept. 5, 1972.



Table 4-151. NNS 0-20 (Transit) Characteristics

---

Also called: Navy Navigation Satellite; Transit  
 Date of launch (location): Oct. 29, 1973 (WTR)  
 Launch vehicle: Scout  
 Weight (kg): Not available.  
 Shape: Octagonal central body with four solar paddles  
 Dimensions (m): Not available  
 Power source: Solar panels plus NiCd batteries  
 NASA's role: Launch vehicle (reimbursable)  
 Cooperating organizations: NASA and U.S. Navy  
 Responsible NASA center: Goddard Space Flight Center  
 Project manager: Robert Goss  
 Prime contractor: Johns Hopkins Applied Physics Laboratory  
 Objectives: To provide communications support for military navigation.  
 Results: Successful; part of the five-satellite Navy Navigation Satellite System, made up of several different kinds of Transit satellites.

---

Reference: Geoff Richard, "Transit—The First Navigational Satellite System," *Spaceflight* 21 (Feb. 2, 1979): 50-55.

Table 4-152. TIP II (Transit) Characteristics

---

Also called: Transit Improvement Program  
 Date of launch (location): Oct. 11, 1975 (WTR)  
 Launch vehicle: Scout  
 Weight (kg): 162  
 Shape: Cylindrical with four solar paddles  
 Dimensions (m): Not available  
 Power source: Solar panels plus NiCd batteries  
 NASA's role: Launch vehicle (reimbursable)  
 Cooperating organizations: NASA and U.S. Navy  
 Responsible NASA center: Goddard Space Flight Center  
 Project manager: Robert Goss  
 Prime contractor: Johns Hopkins Applied Physics Laboratory  
 Objectives: To provide improved communications support for military navigation.  
 Results: Unsuccessful; solar panels did not deploy; spacecraft began to tumble after being inserted into transfer orbit.

---

Reference: NASA, "TIP II Mission Operations Report," M-490-601-75-10, Oct. 1, 1975.

Table 4-153. Transit Characteristics

---

Date of launch (location): Oct. 28, 1977 (WTR)  
 Launch vehicle: Scout  
 Weight (kg): 162  
 Shape: Octagonal with four solar paddles and antennas  
 Dimensions (m): Not available  
 Power source: Solar panels plus NiCd batteries  
 NASA's role: Launch vehicle (reimbursable)  
 Cooperating organizations: NASA and U.S. Navy  
 Responsible NASA center: Goddard Space Flight Center  
 Project manager: Robert Goss  
 Prime contractor: Johns Hopkins Applied Physics Laboratory for Western Union Telegraph Co.  
 Objectives: To provide improved navigational support for the Navy; part of the Navy Navigation Satellite System.  
 Results: Launch successful.

---

Reference: NASA, "Transit Mission Operations Report," M-490-601-77-03, Sept. 30, 1977.

Table 4-154. Westar 1 Characteristics

---

Date of launch (location): Apr. 13, 1974 (ETR)  
 Launch vehicle: Delta 2914  
 Weight (kg): 571  
 Shape: Cylindrical with antenna mounted on one end  
 Dimensions (m): 1.56 height  
                   1.85 diameter  
 Power source: Solar panels plus NiCd batteries  
 NASA's role: Launch vehicle (reimbursable)  
 Cooperating organizations: NASA and Western Union  
 Responsible NASA center: Goddard Space Flight Center  
 Project manager: Robert Goss  
 Prime contractor: Hughes Aircraft Co., for the Western Union Telegraph Co.  
 Objectives: To provide commercial communications; capable of 14 400 voice channels or 12 color TV channels.  
 Results: Successful; first of a series of three.

---

Reference: NASA, "Westar Mission Operations Report," S-492-203-74-01, Apr. 1, 1974.

Table 4-155. Westar 2 Characteristics

---

Date of launch (location):	Oct. 10, 1974 (ETR)
Launch vehicle:	Delta 2914
Weight (kg):	571
Shape:	Cylindrical with antenna mounted on one end
Dimensions (m):	1.56 height 1.85 diameter
Power source:	Solar panels plus NiCd batteries
NASA's role:	Launch vehicle (reimbursable)
Cooperating organizations:	NASA and Western Union
Responsible NASA center:	Goddard Space Flight Center
Project manager:	Robert Goss
Prime contractor:	Hughes Aircraft Co. for Western Union Telegraph Co.
Objectives:	To provide commercial communications ; capable of 14 400 voice channels or 12 color TV channels.
Results:	Successful; second of a series of three.

---

Reference: NASA, "Westar Mission Operations Report," S-492-203-74-02, Sept. 28, 1974.

### Applications Technology Satellite

The overall objective of the Applications Technology Satellite (ATS) program was to investigate and flight-test technological developments common to a number of satellite applications. Designers of ATS at Hughes Aircraft Company and the Goddard Space Flight Center built on the successful Syncom communications satellite design. Each of six ATS spacecraft carried a variety of communications, meteorology, and scientific experiments, in addition to providing a platform for evaluating three different kinds of spacecraft stabilization systems.

*ATS 1* (1966) and *ATS 3* (1967) were synchronous-orbit spin-stabilized satellites. *ATS 2* (1967) was a medium-altitude gravity-gradient-stabilized vehicle. *ATS 4* (1968) and *ATS 5* (1969) were synchronous-orbit gravity-gradient-stabilized. *ATS 6*, a new design launched in 1974, was synchronous-orbit three-axis-actively-stabilized.

Funds for the first five ATS missions were released in 1964. *ATS F* and *G* were approved in 1968. Congress, however, struck the second advanced ATS from the roster in January 1973 in response to budget constraints. Attempts to revive it by NASA in mid-1974 failed.

*ATS 5*, launched in August 1969, was the last of the original five missions. This cylindrical spacecraft carried a gravity gradient experiment designed to provide basic design information about this new system for spacecraft stabilization. In addition, *ATS 5* investigators planned four communications experiments, the evaluation of an ion engine thruster, a solar cell experiment, four particle measurements, and four other scientific investigations in the areas of electric fields, solar radio, electron content of the ionosphere and magnetosphere, and magnetic fields. The mission, however, was only partially successful.

After the spacecraft was placed in a nominal transfer orbit, excessive nutational motion caused the spacecraft to spin transversely. Even after the motor case was ejected and the spacecraft established its spin about its long axis, the spin was in the

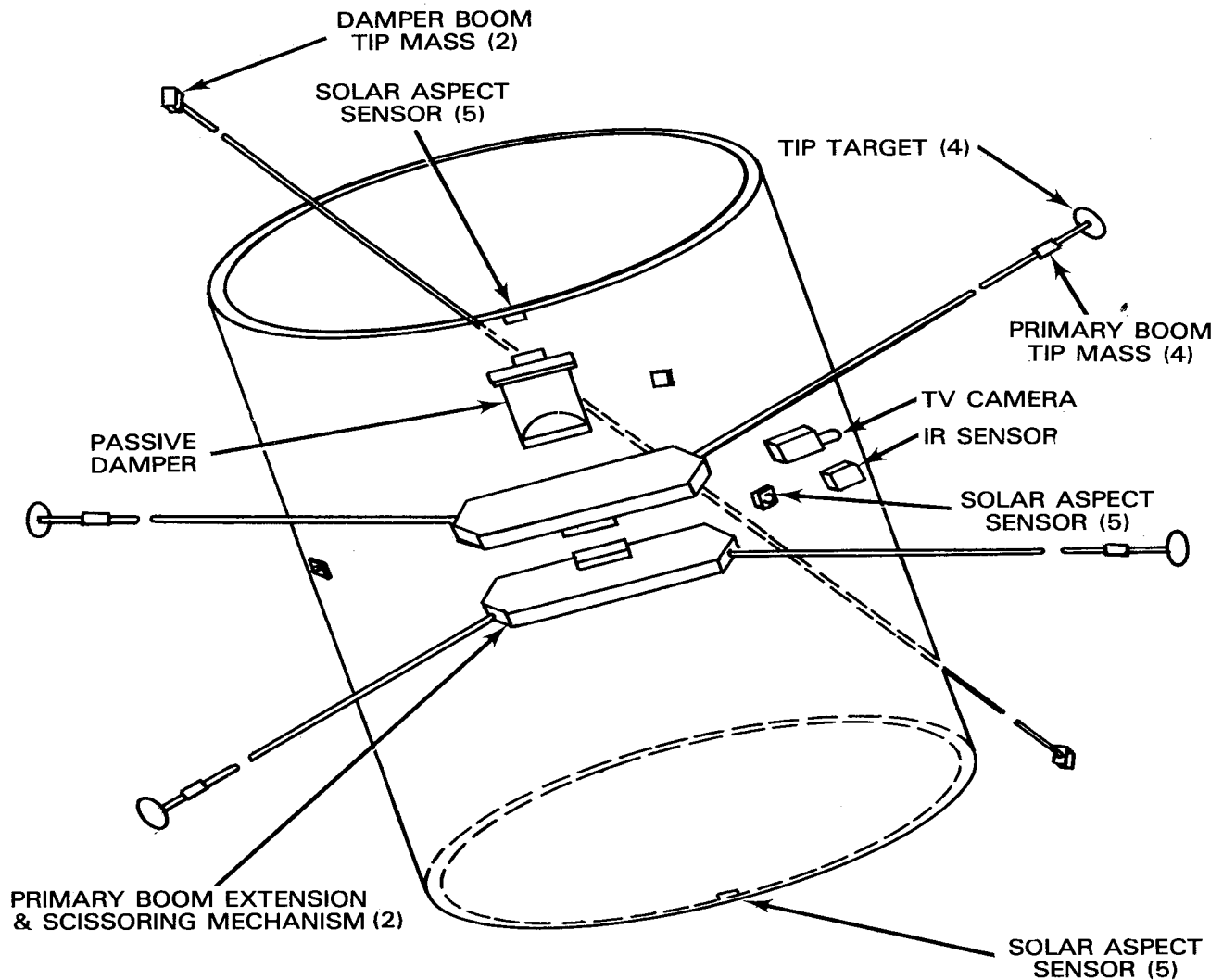

Figure 4-7. The ATS 5 gravity gradient stabilization system was designed to serve as a verification of a previously developed mathematical model for a gravity-stabilized vehicle in synchronous orbit. The system was comprised of three major hardware areas: (1) four gravity gradient booms, extension mechanisms, and a scissoring mechanism, (2) passive dampers, and (3) attitude sensors.

Source: NASA, "ATS 5 Mission Operations Report," S-630-69-05, July 29, 1969, p. 27.

opposite direction planned. The important gravity gradient experiments were rendered useless. Only some secondary experiments were conducted successfully.

*ATS 6*, a much heavier, more sophisticated satellite than its predecessors, was built by Fairchild Industries for the Goddard Space Flight Center.\* It was designed to serve basically as a multipurpose communications satellite with a large 9.14-meter aperture parabolic antenna. The highly successful *ATS 6*, launched in May 1974, was used to conduct 15 major experiments in the fields of space communications (2), space technology (3), tracking and data relay (1), space science (5), and user ex-

\*See table 4-156 for details on the contractor selection process for *ATS F* and *G*.

periments (1). Its user experiments were highly publicized, providing educational broadcasts to remote areas, communications links between rural clinics and urban hospitals, educational programs in India, and educational and medical programs in the Appalachian and Rocky Mountains. Its initial geosynchronous orbit allowed users in the U.S. to take advantage of the advanced services offered by *ATS 6*. In 1975, NASA moved it eastward over Central Africa, from where it could be used by India. The astronauts aboard the Apollo and Soyuz spacecraft also took advantage of the new position of *ATS* to augment their communications links during the Apollo-Soyuz Test Project in July 1975. The following year, it was repositioned over the western hemisphere again. This last *ATS* spacecraft was operational through August 1979.

At NASA Headquarters, Joseph R. Burke and Albert G. Opp served as program manager and program scientist for *ATS 5*. During the last mission, Harry Mannheimer was program manager, assisted by Paul J. McCeney, program engineer. Applications Technology Satellite was managed by the Goddard Space Flight Center, where Robert J. Darcey and T. L. Aggson acted as project manager and project scientist. For *ATS 6*, John M. Thole had assumed the project manager role, with Edward A. Wolff serving as project scientist and Anthony H. Sabehhaus as spacecraft manager.

The first series of *ATS* spacecraft were launched by Atlas-Agena and Atlas-Centaur boosters. A Titan IIIC orbited *ATS 6*. All launches took place at the Kennedy Space Center.

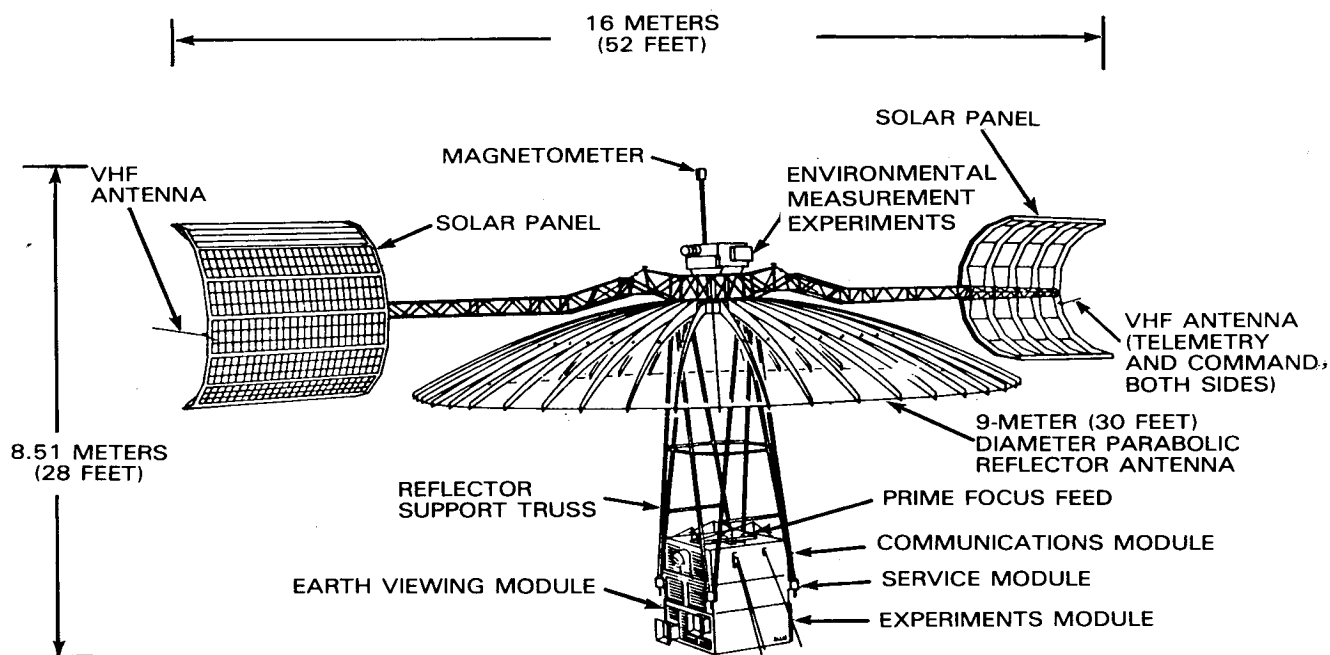

Figure 4-8. The large parabolic antenna of *ATS 6* dwarfs the main spacecraft body.

Source: NASA, "ATS 6 Mission Operations Report," E-630-74-06, May 24, 1974, p. 32.

Table 4-156. Chronology of Applications Technology Satellites 5 and 6 Development and Operations

Date	Item
May 1966	The Goddard Space Flight Center awarded three contracts for feasibility studies (Phase A) for an advanced Applications Technology Satellite (ATS F and G) to Fairchild-Hiller, General Electric (GE) Company, and Lockheed Missiles and Space.
July 7, 1966	Goddard issued a request for proposals (RFP) to industry for an ATS antenna design study.
Aug. 22, 1966	Goddard received antenna design study proposals from nine companies.
Dec. 14, 1966	Goddard awarded an antenna design study contract to Goodyear.
Jan. 1967	The three contractors completed their feasibility studies for Goddard.
May 14, 1967	Goodyear completed its antenna study.
June 27, 1967	NASA exercised its option to continue its contract with Goodyear and requested the company to proceed with a detailed design and fabrication of a full-scale test model of its antenna.
Jan. 16, 1968	NASA issued an invitation to participate in the ATS F and G missions to potential investigators.
Feb. 8, 1968	Goddard solicited Phase B/C ATS proposals from industry.
Sept. 1968	Goddard awarded Phase B/C contracts to GE and Fairchild.
Oct. 1968	NASA chose 18 experimenters for the ATS F mission.
Apr. 1969	Goodyear delivered its model antenna to Goddard.
Aug. 12, 1969	NASA launched ATS 5 into transfer orbit. Excessive motion caused the spacecraft to spin transversely. After the motor case was ejected, the spacecraft began spinning about the proper axis, but going the wrong direction. The gravity gradient experiments could not be performed; only secondary experiments were accomplished.
Sept. 1969	GE and Fairchild submitted Phase D proposals to Goddard.
Dec. 1969	At NASA's direction, GE and Fairchild submitted revised Phase D proposals, taking into account recent budget adjustments.
Late 1969- Early 1970	The source evaluation board charged with selecting an ATS prime contractor met. Their initial scoring was Fairchild 699, GE 664. Second scoring was Fairchild 683, GE 670. A final score showed Fairchild 686, GE 687. They judged the two proposals to be technically equal; the cost differences were minor.
Feb. 5, 1970	NASA advised GE and Fairchild that further budget cuts would cause a delay in launching ATS F by one year; the agency asked the potential contractors to submit revised proposals based on the new launch target.
Feb. 16, 1970	Fairchild advised NASA that it would try to meet the Feb. 27 deadline for the revised proposal, but that Mar. 6 was the earliest date it could guarantee submission.
Feb. 18, 1970	GE advised NASA that it needed additional time to reply to the request for a revised proposal; it would try to submit by Mar. 4.
Feb. 25, 1970	Fairchild called Goddard, advising the center of its intention to submit a telegraphic request for extension to Mar. 2. (Fairchild later claimed that they were told by NASA that a similar request from GE had not been approved and their request could not be approved either.)
Feb. 27, 1970	Fairchild submitted its proposal at 4 p.m.
Mar. 4, 1970	Fairchild submitted an optional proposal, which was later rejected. Fairchild also learned that GE had not yet delivered its bid and asked that its proposal not be submitted to Goddard personnel until receipt of GE's, but the proposal had already been circulated.
Mar. 6, 1970	GE submitted its bid, which had been revised to show a reduction in overhead costs; the new total was just below that of Fairchild's.
Mar. 10, 1970	NASA conducted a fact-finding session with Fairchild at Goddard.
Mar. 11-12, 1970	NASA conducted a fact-finding session with GE at Goddard.
Apr. 3, 1970	The source evaluation board reported that the two proposers were technically equal, but that GE's proposal was approximately 2% lower in cost.

Table 4-156. Chronology of Applications Technology Satellites 5 and 6 Development and Operations (Continued)

Date	Item
Apr. 7, 1970	The board delivered its oral report to the NASA administrator.
Apr. 8, 1970	NASA announced that the ATS contract would be awarded to GE. Fairchild claimed that GE could have used the extra week it took to deliver its proposal unfairly, since its contract was already circulating at Goddard during that time.
Apr. 9, 1970	NASA Administrator Thomas O. Paine requested that the General Accounting Office (GAO) review the events leading to the selection of GE as the contractor for ATS.
July 2, 1970	GAO advised NASA to reconsider the selection and reopen the bidding.
July 16, 1970	Paine appointed a Selection Panel and an ATS Procurement Review Committee to review the decision to award GE the contract over Fairchild.
Aug. 26, 1970	The committee delivered its report.
Sept. 5, 1970	On the recommendations of the committee, NASA reversed its decision and awarded the ATS contract to Fairchild, based on Fairchild's superior technical abilities.
Nov. 12, 1970	NASA announced the experimenters for ATS F.
Spring 1972	Because of cost overruns and other problems with the contractor management, NASA postponed the ATS F launch from spring 1973 to spring 1974.
Sept. 1972	Lewis Research Center announced that it would be contracting for a study of an advanced ATS (H/I) satellite to be launched in 1977-1978. Advanced ATS was proposed as a new start for FY 1973 by Associate Administrator John Naugle, but it was not approved by Congress.
Jan. 1973	Congress decreased funding for NASA's applications program by \$35.7 million. As a result, NASA decided to cancel the ATS G mission.
Sept. 1973	At the Johnson Space Center, technicians completed the ATS F mechanical and structural qualifications program.
May 30, 1974	NASA launched <i>ATS 6</i> successfully. It was used during its first year of operations to transmit medical and educational programs to remote communities in Alaska, the Rocky Mountains, and Appalachia.
May-July 1974	Members of Congress who favor continuing the ATS program with the launching of ATS G lobbied for support; they were unsuccessful.
Nov. 1974	NASA directed Fairchild to mothball the ATS G spacecraft.
May-June 1975	NASA controllers moved <i>ATS 6</i> from its initial location in the western hemisphere to a location over eastern Africa where it can support communications experiments in India.
July 15-24, 1975	<i>ATS 6</i> made real-time television possible during the joint U.S.-USSR Apollo-Soyuz Test Project.
July 1975	NASA invited organizations to propose experiments for the third year of <i>ATS 6</i> operations.
Aug.-Dec. 1976	NASA began moving <i>ATS 6</i> back to the western hemisphere in August. It was used along the way in direct broadcasting experiments in many developing countries.
May 7, 1979	<i>ATS 6</i> 's prime east thruster failed.
June 30, 1979	NASA terminated <i>ATS 6</i> services to users.
July 13, 1979	Two more thrusters failed on <i>ATS 6</i> .
Aug. 6, 1979	NASA boosted <i>ATS 6</i> out of geostationary orbit.
Nov. 24, 1979	Ground controllers reactivated <i>ATS 6</i> for use with a NOAA experiment.

Table 4-157. ATS 5 Characteristics

---

Also called: Applications Technology Satellite; ATS E  
 Date of launch (location): Aug. 12, 1969 (ETR)  
 Launch vehicle: Atlas-Centaur  
 Weight (kg): 431  
 Shape: Cylindrical with booms extending from its sides and an apogee motor extending from one end  
 Dimensions (m): 1.4 diameter  
                   1.8 length  
 Power source: Solar panels and 2 NiCd batteries  
 Responsible NASA Center: Goddard Space Flight Center  
 Prime contractor: Hughes Aircraft Company  
                   GE Company—Gravity Gradient Experiment  
 Project manager: Robert J. Darcey  
 Project scientist: T. L. Aggson  
 Objectives: Conduct gravity gradient experiment directed toward providing basic design information;  
                   conduct secondary experiments (communications, applications, and scientific).  
 Fields of investigation: Communications  
                               Stabilization and pointing technology  
                               Orbital technology  
                               Space environment degradation  
 Results: Partially successful; excessive motion caused the spacecraft to spin transversely in its transfer orbit; after motor case was ejected, the spacecraft established the proper spin but in the wrong direction. The gravity gradient experiments could not be performed; only some secondary experiments could be conducted.

---

Reference: NASA, "ATS 5 Mission Operations Report," S-630-69-05, Aug. 6, 1969.

Table 4-158. ATS 6 Characteristics

---

Also called: Applications Technology Satellites; ATS F  
 Date of launch (location): May 30, 1974 (ETR)  
 Launch vehicle: Titan III C  
 Weight (kg): 1336  
 Shape: Rectangular earth-viewing module connected by a tubular support truss to a 9.15-meter parabolic antenna; two solar panels on booms extend from opposite sides on top of the antenna.  
 Dimensions (m): 8.51 overall height  
                   16.0 width with booms extended  
 Power source: Solar panels plus two NiCd batteries  
 Responsible NASA center: Goddard Space Flight Center  
 Prime contractor: Fairchild Industries  
 Project manager: John M. Thole  
 Project scientist: Edward A. Wolff  
 Spacecraft Manager: Anthony H. Sabehhaus  
 Objectives: In near-geostationary orbit erect a 9-meter antenna structure capable of providing a good-quality signal to small, inexpensive ground receivers; stabilize a spacecraft using a three-axis control system.  
 Fields of investigation: Communications  
                               Spacecraft technology  
                               Tracking and data relay  
                               Space science (charged particles, cosmic ray, and magnetic field measurements)  
                               User experiments  
 Results: Highly successful; initially positioned over U.S.; moved for use in India in 1975; moved back to western hemisphere in 1976. Operational through August 1979.

---

Reference: NASA, "ATS 6 Mission Operations Report," E-630-74-06, May 24, 1974.



## Earth Observations Program

NASA's earth observations program included three related but distinct projects during the 1970s: (1) Aboard Skylab, astronauts continued the evaluations of earth photography and sensing techniques started during the Gemini program of the 1960s. Three Skylab crews worked with the Earth Resources Experiments Package (EREP) in 1973-1974. (2) Specially-equipped aircraft further tested cameras and remote sensing equipment. The Johnson Space Center and the Ames Research Center participated in this Earth Resources Survey Program, using several different aircraft. (3) NASA launched its first Earth Resources Technology Satellite (ERTS) in 1972, which was equipped with instruments tested during the manned space program and flown on survey aircraft. Later renamed Landsat, this satellite project was a joint NASA-user agency undertaking.

According to Dr. John DeNoyer, director of the earth observation programs for the Office of Space Science and Applications, speaking before the House Committee on Science and Astronautics in 1970, the program was designed to "develop economical techniques for surveying the resources of our earth, measuring the changes in these resources, and monitoring many environmental and ecological relationships."<sup>10</sup> Specifically, the agency hoped to achieve the following objectives:

- To define problems to which space technology could make a beneficial contribution with repetitive, synoptic observations and measurements from space.
- To determine the performance of multispectral sensors and establish signature recognition criteria.
- To develop additional sensors.
- To develop data handling techniques for the processing of data from earth observation satellites.
- To determine the requirements for a global environmental monitoring system.

Satellite data would be applied to several resource management fields: agriculture, forestry, and range resources; cartography and land use; geology; water resources; oceanography and marine resources; and environmental monitoring (see table 4-159).

Photographing and measuring the earth from orbital platforms was not an idea unique to the earth observations program. NASA satellites had been sensing the planet since the first Tiros weather satellite was launched in 1960. As listed in table 4-160, a variety of increasingly sophisticated sensors were developed for meteorology payloads and Applications Technology Satellites during the 1960s and 1970s. ERTS and Landsat craft, however, were the first satellites devoted exclusively to the monitoring of earth's resources.

Table 4-159. Potential Applications of Earth Resources Satellite Data

Agriculture, Forestry, and Range Resources	Cartography and Land Use/Cover	Geology	Water Resources	Oceanography and Marine Resources	Environment
Discrimination of vegetative types:	Classification of land uses/cover	Identification of rock types	Determination of water boundaries and surface water area and volume	Determination of turbidity patterns and circulation	Monitoring surface mining and reclamation
Crop types	Mapping and map updating	Mapping of major geologic units	Mapping of floods and flood plains	Mapping shoreline changes	Mapping and monitoring of water pollution
Timber types	Categorization of land capability	Revising geologic maps	Determination of areal extent of snow and snow boundaries	Mapping of shoals and shallow areas	Determination of effects of natural disasters
Range vegetation	Separation of urban and rural categories	Delineation of unconsolidated rock and soils	Measurement of glacial features	Mapping of ice for shipping	Monitoring environmental effects of man's activities (lake eutrophication, defoliation, etc.)
Measurement of crop acreage by species	Preparation of regional plans	Mapping igneous intrusions	Measurement of sediment and turbidity patterns	Study of eddies and waves	
Measurement of timber acreage and volume by species	Mapping of transportation networks	Mapping recent volcanic surface deposits	Determination of water depth		
Determination of range readiness and biomass	Mapping of land-water boundaries	Mapping landforms	Delineation of irrigated fields		
Determination of vegetation stress	Mapping of wetlands	Search for surface guides to mineralization	Inventory of lakes and water impoundments		
Determination of soil associations		Determination of regional structures			
Assessment of grass and forest fire damage		Mapping lineaments (fractures)			

Source: Off. of Space and Terrestrial Applications, NASA, "The Landsat Story," Jan. 1980., p. 14.

Table 4-160. Earth Observation Sensors Carried by NASA Satellites, 1960-1978

Name	Launched	Master Sensors
TIROS I	01 Apr 60	1 Wide and 1 narrow camera
TIROS II	23 Nov 60	2 TV, passive & active IR scan
TIROS III	12 Jul 61	2 wide-angle cameras, HB, 2 IR
TIROS IV	08 Feb 62	2 TV, 2 IR, HB
TIROS V	19 Jun 62	2 TV
TIROS VI	18 Sep 62	2 TV
TIROS VII	19 Jun 63	2 TV, IR, ion probe, HB
TIROS VIII	21 Dec 63	1st APT TV direct readout & 1 TV
Nimbus 1	28 Aug 64	3 AVCS, 1 APT, HRIR 3-axis stabil.
TIROS IX	22 Jan 65	First "wheel"; 2 TV global coverage
TIROS X	01 Jul 65	Sun synchronous, 2 TV
ESSA 1	03 Feb 66	1st operational system, 2 TV, FPR
ESSA 2	28 Feb 66	2 APT, global TV coverage
Nimbus 2	15 May 66	3 AVCS, HRIR, MRIR
ESSA 3	02 Oct 66	2 AVCS, FPR
ATS I	06 Dec 66	Spin scan camera
ESSA 4	26 Jan 67	2 APT
ESSA 5	20 Apr 67	2 AVCS FPR
ATS III	05 Nov 67	Color spin scan camera
ESSA 6	10 Nov 67	1 APT TV
ESSA 7	16 Aug 68	2 AVCS, FPR, S-Band
ESSA 8	15 Dec 68	2 APT TV
ESSA 9	26 Feb 69	2 AVCS, FPR, S-Band
Nimbus 3	14 Apr 69	SIRS A, IRIS, MRIR, IDCS, MUSE, IRLS
ITOS 1	23 Jan 70	2 APT, 2 AVCS, 2 SR, FPR, 3-axis stabil.
Nimbus 4	15 Apr 70	SIRS B, IRIS, SCR, THIR, BUV, FWS, IDCS, IRLS, MUSE
NOAA 1	11 Dec 70	2 APT, 2 AVCS, 2 SR, FPR
Landsat 1	23 July 72	MSS, 3 RBV's
NOAA 2	15 Oct 72	2 VHRR, 2 VTPR, 2 SR, SPM
Nimbus 5	11 Dec 72	SCMR, ITPR, NEMS, ESMR, THIR
NOAA 3	06 Nov 73	2 VHRR, 2 VTPR, 2 SR, SPM
SMS 1	17 May 74	VISSR, DCS, WEFAX, SEM
NOAA 4	15 Nov 74	2 VHRR, 2 VTPR, 2 SR, SPM
Landsat 2	22 Jan 75	MSS, 3 RBV's
SMS 2	06 Feb 75	VISSR, DCS, WEFAX, SEM
Nimbus 6	12 Jun 75	ERB, ESMR, HIRS, LRIR, T&DR, SCAMS, TWERLE, PMR
GOES 1	16 Oct 75	VISSR, DCS, WEFAX, SEM
NOAA 5	29 Jul 76	2 VHRR, 2 VTPR, 2 SR, SPM
GOES 2	16 Jun 77	VISSR, DCS, WEFAX SEM
Landsat 3	05 Mar 78	MSS, 2 RBV's
HCMM	25 Apr 78	HCMMR
GOES 3	16 Jun 78	VISSR, SEM, WEFAX
Seasat	27 Jun 78	SMMR, VIRR, SAR, Radar altimeter, microwave scatterometer
TIROS-N	13 Oct 78	TOVS, AVHRR
Nimbus-7	23 Oct 78	CZCS, ERB, LIMS, SBUV/TOMS, SAM-II, SAMS, SMMR

Table 4-160. Earth Observation Sensors Carried by NASA Satellites, 1960-1978  
(Continued)

<sup>a</sup>Key to sensor acronyms:

APT—Automatic Picture Transmission TV	PMR—Pressure Modulated Radiometer
AVCS—Advanced Vidicon Camera System	RBV—Return Beam Vidicon Camera
AVHRR—Advanced Very High Resolution Radiometer	SAM II—Stratosphere Aerosol Measurement
BUV—Backscatter Ultraviolet Spectrometer	SAMS—Stratospheric and Mesospheric Sounder
CZCS—Coastal Zone Color Scanner	SAR—Seasat Synthetic Aperture Radar
DCS—Data Collection System	SBUV/TOMS—Solar Backscatter Ultraviolet and Total Ozone Mapping Spectrometer
ERB—Earth Radiation Budget	SCAMS—Scanning Microwave Spectrometer
ESMR—Electronic Scanning Microwave Radiometer	SCMR—Surface Composition Mapping Radiometer
FPR—Flat Plate Radiometer	SCR—Selective Chopper Radiometer
FWS—Filter Wedge Spectrometer	SEM—Space Environmental Monitor
HB—Heat Budget Instrument	SIRS—Satellite Infrared Spectrometer
HCMR—Heat Capacity Mapping Radiometer	SMMR—Scanning Multichannel Microwave Radiometer
HRIS—High Resolution Infrared Sounder	SPM—Solar Proton Monitor
HRIR—High Resolution Infrared Radiometer	SR—Scanning Radiometer
IDCS—Image Dissector Camera System	THIR—Temperature Humidity Infrared Radiometer
IRIS—Infrared Interferometer Spectrometer	T&DR—Tracking and Data Relay
IRLS—Interrogation, Recording and Location Subsystem	TOVS—TIROS Operational Vertical Sounder
ITPR—Infrared Temperature Profile Radiometer	TWERLE—Tropical Wind Energy Reference Experiment
LIMS—Limb Infrared Monitoring of the Atmosphere	VHRR—Very High Resolution Radiometer
LRIR—Limb Radiance Infrared Radiometer	VIRR—Visible Infrared Radiometer
MRIR—Medium Resolution Infrared Radiometer	VISSR—Visible Infrared Spin-Scan Radiometer
MSS—Multispectral Scanner	VTPR—Vertical Temperature Profile Radiometer
MUSE—Monitor of Ultraviolet Solar Energy	WEFAX—Weather Facsimile
NEMS—Nimbus E Microwave Spectrometer	TV—Television Cameras

Source: Daniel J. Fink, *Earth Observation—Issues and Perspectives*, AIAA 16th Annual Meeting and Technical Display, May 6-11, 1980, Theodore von Karman Lecture (New York: American Institute of Aeronautics and Astronautics, 1980), pp. 16-17.

**Earth Resource Experiments Package.** The first reports from Mercury astronauts of the view of the earth that spaceflight provided them spawned public interest in earth observation. Hand-held cameras became a popular item for late Mercury and Gemini manned flights. The systematic use of hand-held cameras during 1965 and 1966 by Gemini astronauts produced approximately 1100 photographs in normal color and infrared, which were useful to geologists. The higher-resolution images served as a stimulus to the agency's earth observations program and to the development of remote sensors.<sup>11</sup>

In early discussions, Apollo applications program managers suggested that earth resources observations should be included among possible objectives for an orbiting manned laboratory. Leonard Jaffe, acting director of the Earth Observations Program Division of OSSA, supported the proposal. EREP grew from four instruments suggested in 1969 to six. A multispectral photographic facility was an improved version of an experiment that had flown on *Apollo 9*; six different cameras would each record a different spectral range of visible to infrared light. The other five experiments would record the intensity of radiation emitted by or reflected from

surface features. Two spectrometers and a 10-band multispectral scanner operated in the infrared spectrum. Another instrument served as a microwave radiometer and a radar scatterometer. A passive L-band radiometer mapped temperatures of terrestrial surfaces, and a higher-resolution camera aided in the interpretation of data from the other sensors. NASA would operate EREP, but it asked prospective investigators to suggest uses for the data the package would provide during 60 earth-oriented passes. At a Skylab Results Symposium held in 1974, teams of investigators reported on the earth resources program. The microwave instruments showed promise for measuring soil moisture and the multispectral photographs were applicable for mapping geological and agricultural features. One group was using multispectral images in a computerized program of land-use determination. These preliminary results indicated that Skylab's sensors had performed as expected and that the investigators had found them useful.<sup>12</sup>

**Aircraft Project.** NASA's Earth Resources Survey Aircraft Project had its roots in aerial reconnaissance and photogrammetry—mapmaking from aerial photographs—used extensively since World War I. NASA managers recognized that aircraft could also serve as less expensive testbeds for radar and earth observation instruments being designed for spacecraft. The Johnson Space Center acquired its first aircraft, a Convair 240A, in late 1964. Engineers equipped it with mapping and multispectral cameras and radar and infrared systems. The next year, NASA borrowed a Lockheed P-3A from the Navy that could operate at intermediate altitudes (6000-16 500 meters). Two Lockheed C-130Bs were added to the fleet before the end of the decade. NASA Acting Administrator George M. Low approved the use of high-altitude aircraft in 1970, and Ames Research Center acquired two Lockheed U-2s the following year, and the Johnson Space Center gained access to a WB-57F. NASA used other military aircraft on a noninterference basis.

Sensors tested on aircraft could be repaired or improved between flights, something not possible with spacecraft-borne instruments. And high-altitude aircraft could provide useful sample data for the users so that they might develop their interpretative methods in advance of receiving the actual satellite data. Such data also served to stimulate interest among the user community.

**ERTS/Landsat.** NASA's Office of Manned Space Flight initiated the agency's enthusiasm for an earth observations program. It was the intention of OMSF in the mid-1960s that the program would be conducted on manned missions, with unmanned orbital satellite tests of the instruments to precede manned flights. NASA's plans for an incremental, large program were not conducive to the early development of a useful tool for potential data users, the number of which had been growing steadily.

Since 1964, the agency had let contracts to universities and transferred funds to other government agencies for studies of the usefulness of remote sensing data. These studies generated a great deal of enthusiasm for an earth resources remote-sensing satellite. The University of Michigan began work on a multispectral scanner to be used in earth orbit. The U.S. Geological Survey of the Department of the Interior submitted its suggestions for a Small Orbiting earth Resources Observatory in August 1966. The Department of Agriculture also was anxious to have access to data of the type promised by an earth observations satellite.

In September 1966, the Department of the Interior publicly announced its intentions to plan an Earth Resources Observation Satellite (EROS) program, with the

first launch to take place in 1969. Interior, who insisted that there were flight-ready sensors available, was pressing for an operational system; NASA, a research and development agency, contended that any EROS-type satellite would be experimental in nature. NASA responded to Interior officially in April 1967; the space agency believed that there was a need for significant development of sensor, data storage, and data transmission technologies before they would be mission-ready. But NASA, through its Office of Space Science and Applications, did accelerate its program, predicting a launch by the early 1970s, and began a series of budget fights with the Bureau of the Budget, Congress, and the White House that were to be an annual feature of the ERTS project.<sup>13</sup>

NASA gave sensor development a high priority. Three types were considered for a simple earth observations satellite: photographic cameras, television cameras (vidicons), and scanners. Goddard Space Flight Center personnel conducted a preliminary design study in 1967 and worked on improving existing sensor designs through the fall of 1968. In October, managers approved the satellite project and initiated a full-scale design and development phase, assigning its management to Goddard. RCA began to work on a return beam vidicon, and the University of Michigan continued development of their scanner. Interior focused its energies on an EROS Data Center, which would distribute ERTS data to the users. An Earth Resources Survey Program Review Committee, with representatives from several agencies interested in EROS, monitored the program's progress.\*

In October 1969, NASA awarded two competitive contracts to GE and TRW for ERTS system design and development. These two companies had had positive experiences with the Nimbus meteorological satellite and the Orbiting Geophysical Laboratory, respectively. The following year, the space agency selected GE, with Bendix Corporation as its data processing system subcontractor, as the prime contractor for ERTS. The team of contractors met the first launch date. The Western Test Range successfully launched *ERTS 1* on July 23, 1972. Before the launch of the second satellite on January 22, 1975, NASA changed the name of the project to Landsat. *Landsat 3*, with improved sensing capabilities, was launched on March 5, 1978, and a fourth satellite was scheduled for 1980. (See table 4-161 for a detailed chronology of events, and tables 4-162 through 164 for mission information.)

The first three Landsat missions all surpassed their predicted operational lifetimes. NASA deactivated *Landsat 1* in 1978 and *Landsat 2* in 1980.<sup>14</sup>

The Office of Space Science and Applications (later the Office of Applications and later still the Office of Space and Terrestrial Applications) managed the Landsat program. Before ERTS became an approved project in 1969, J. Robert Porter led an Office of Earth Resources Survey Disciplines under the direction of Leonard Jaffe, director of space applications programs. By the time of the first launch, the Office of Applications had formed an earth observation programs directorate, which was led by John M. DeNoyer, formerly of the Department of the Interior. Bruton B. Schardt served as DeNoyer's ERTS-Nimbus program director. Three years later, William E. Stoney assumed leadership of the directorate, and Harry Mannheimer

---

\*Membership in 1970 included John E. Naugle, NASA, chairman; William T. Pecors, Department of the Interior; T. C. Byerly, Department of Agriculture; Robert M. White, Department of Commerce; Robert A. Frosch, Department of the Navy; and Leonard Jaffe, NASA.

became program manager for Landsat-Nimbus. Pitt G. Thome was director of the Resource Observation Division of the new Office of Space and Terrestrial Applications in 1978, with Mannheimer retained as program manager for Landsat. At the Goddard Space Flight Center where the project was directed, W. E. Scull served as project manager for *Landsat 1*, while W. Nordberg acted as project scientist. For *Landsat 2*, Jack Sargent took over as project manager, with Stanley C. Freden as project scientist. Freden and project manager R. Browning oversaw *Landsat 3*. All launches took place at the Western Test Range.

Table 4-161. Chronology of Landsat Development and Operations

Date	Item
Feb. 13-15, 1962	The University of Michigan sponsored the first of a series of Symposium on Remote Sensing of the Environment.
June 1964	NASA acquired its first CV-240A aircraft; the agency initially used it to test electronic systems for the Apollo program.
July 1964	NASA requested that the U.S. Geological Survey undertake studies, jointly funded by NASA and the Department of Interior, of the possible applications of evolving instruments designed for remote sensing of the earth and the moon.
Nov. 1964	NASA initiated its Earth Observations Aircraft Flight Program. The first flights, using the CV-240A, took place in June 1965.
Feb. 1965	NASA initiated its Earth Resources Survey (ERS) Program to develop methods for remote sensing of earth resources from space.
Mar. 2, 1965	At NASA's request, the Department of Agriculture began studying the applicability of remote sensing to solving agricultural problems. Agriculture expanded its studies to include all types of remote sensors relative to problems of geology, hydrology, geography, and cartography in December.
Dec. 1965	NASA borrowed a Lockheed P-3A aircraft from the Navy for its Earth Resources Survey Program; it became operational in January 1967.
1966	The Department of Commerce began to participate in ERS with the formation of an Environmental Sciences Group within the Environmental Science Services Administration (later National Oceanic and Atmospheric Administration).
Early 1966	NASA Headquarters transferred the Earth Resources Survey Program from the manned space science program to the space applications program.
July 26, 1966	NASA Headquarters designated the Manned Spacecraft Center (later the Johnson Space Center) manager of earth resources experiments that would be flown on manned missions.
Sept. 21, 1966	The Department of Interior announced that an Earth Resources Observation Satellites (EROS) Program was being initiated to gather data about natural resources from earth-orbiting satellites carrying remote sensing observation instruments. This would be a multiagency program.
Oct. 21, 1966	The Department of Interior submitted to NASA performance specifications for EROS, including spacecraft requirements.
Feb. 1967	NASA began in-house Phase A feasibility studies of an Earth Resources Technology Satellite (ERTS), which were completed in Oct. The studies concluded that ERTS was feasible using existing state-of-the-art equipment; launch could take place in 1970.
Mar. 1967	NASA Headquarters authorized the Goddard Space Flight Center to study the feasibility of automated spacecraft systems for ERTS.
Apr. 28, 1967	NASA requested inputs from industry for its Phase A ERTS study; 29 companies responded and about half of them made presentations at Goddard starting the next month.
Oct. 1967	In response to presentations to the Bureau of the Budget (BOB) on ERTS, the Bureau declined to authorize any funds for the project.

Table 4-161. Chronology of Landsat Development and Operations (Continued)

Date	Item
Dec. 20, 1967	BOB restored \$2 million of the requested funding for ERTS with which to continue studies. The agency would not be able to begin hardware development.
June 1968	NASA acquired a C-130B ERS aircraft.
July 15, 1968	An interagency Earth Resources Survey Program Review Committee was established with participation from USDA, USN, ESSA (NOOA), USGS, and NASA.
July 1968	NASA acquired a Lockheed C-130B aircraft from the Air Force to replace its CV-240A.
Sept. 1968	At the Manned Spacecraft Center, project managers and principal investigators presented the results of their ERS aircraft program participation. At a meeting at NASA Headquarters, the user agencies developed a discipline rationale for the program.
Sept. 1968	NASA awarded Bendix Corp. a contract for the installation of a multispectral scanner system in NASA's NC-130B aircraft.
Dec. 2, 1968	NASA managers signed the project approval document for ERS to cover aircraft operations, procurement of remote sensors, and equipment and services for data handling and sensor requirements.
Jan. 7, 1969	NASA managers signed the project approval document for Phase B/C ERTS, which included conducting an economic benefits study, project definition, spacecraft systems design study, and long lead-time sensor and instrument development.
Apr.-July 1969	NASA conducted an ERS Foreign Test Site Research project in Mexico, Brazil, and Argentina.
Apr. 30, 1969	The interagency committee formally transmitted ERTS design specifications to its members for approval.
May 21, 1969	NASA issued 12 requests for proposals (RFP) for definition and design of ERTS systems; responses were due in June.
June 20, 1969	NASA approved a contract with RCA Astro-Electronics Division for an ERTS return beam vidicon multispectral three-camera system.
July 24, 1969	An Earth Resources Data Facility was established at the Manned Spacecraft Center to contain documentation from NASA and user agency investigators participating in the ERS program.
Aug. 1969	NASA phased out its CV-240A and replaced it with a Lockheed Hercules C-130B, which became operational in September.
Aug. 16, 1969	NASA approved a contract with Hughes Aircraft Company for a multispectral scanner system for ERTS.
Oct. 17, 1969	NASA selected TRW, Inc., and General Electric Company (GE) for contract negotiations for the prime ERTS Phase B/C contract.
Nov. 13, 1969	NASA awarded letter contracts to TRW and GE (contracts were definitized in January 1970).
Feb. 9, 1970	Goddard issued a letter contract to RCA for the ERTS videotape recorder.
Feb. 11, 1970	TRW and GE delivered their ERTS definition/preliminary design studies and proposals to Goddard.
Apr. 1970	NASA issued contracts to Hughes for a multispectral scanner and to RCA for a return beam vidicon.
June 15, 1970	Funds were approved for an on-center ERTS tracking facility at Goddard.
June 1970	NASA selected GE as provider of the microwave radiometer/scatterometer-altimeter for the Earth Resources Experiment Package (EREP) to be flown on manned spaceflight missions; the agency also selected Honey Radiation Center as provider of EREP's 10-band multispectral scanner.
July 14, 1970	NASA issued RFPs to potential experimenters for use of ERTS A and B data.
July 15, 1970	NASA announced its selection of GE as prime contractor (Phase D) for ERTS (contract definitized in May 1971).
Sept. 22-24, 1970	GE held the ERTS Conceptual Design Review.



Table 4-161. Chronology of Landsat Development and Operations (Continued)

Date	Item
Oct. 27, 1970	NASA awarded RCA a contract for flight model videotape recorders and associated equipment for ERTS.
Nov. 1970	NASA completed preliminary design reviews and critical design reviews for EREP.
Dec. 24, 1970	NASA's Acting Administrator, George M. Low, approved the use of a High Altitude Airborne Research Project using U-2 aircraft.
Jan. 19, 1971	NASA issued RFPs to prospective investigators for use of data from EREP, which would fly on Skylab.
Feb. 2-5, 1971	Goddard conducted a briefing for 651 potential ERTS and EREP investigators.
Mar. 1971	NASA froze the ERTS A/B spacecraft design.
Apr. 2, 1971	NASA announced that it intended to expand its airborne research program by acquiring two Lockheed U-2 aircraft. Lockheed delivered the aircraft to Ames Research Center in June.
May 8, 1971	NASA had received over 550 proposals from potential users of ERTS and EREP data. In June, that number would grow to 600; in July to 701.
June 11, 1971	NASA proposed ERTS C as a new project for FY 1971, with launch scheduled for March 1974 on a Delta N. Congress did not approve funds.
July 15, 1971	The contractor delivered the ERTS spacecraft data collection system.
Aug. 1971	NASA conducted its first U-2 operational mission, simulating ERTS activities.
Sept. 24, 1971	The contractor delivered the ERTS video tape recorder.
Oct. 20, 1971	NASA announced its initial selection of ERTS and EREP investigators.
Dec. 1971	The contractor delivered the ERTS multispectral scanner.
July 23, 1972	NASA successfully launched <i>ERTS 1 (Landsat 1)</i> .
1973-1975	In 1973, NASA again began proposing a third ERTS mission. Congress approved the project in June 1974, only to have the Office of Management and Budget throw it out. However, in January 1975, President Gerald Ford overrode OMB's decision. ERTS C was included in the FY 1976 budget. Project planners now called for a September 1977 launch.
Apr. 12, 1973	NASA's Convair 990 aircraft collided with a Navy P-3 Orion over Moffett Field, California, killing all 11 aboard the NASA craft.
May 8, 1973	The Johnson Space Center awarded GE a contract to study future earth resources systems.
July 12, 1974	NASA announced that 93 research teams had been selected to participate in ERTS follow-on investigations. Investigators would use data from <i>ERTS 1</i> and <i>ERTS B</i> , scheduled for launch in early 1975.
Aug. 1974	The Senate conducted hearings on bills that would establish a separate Office of Earth Resources Survey Systems within NASA and an Earth Resources Observation Administration within the Department of Interior to administer the operational phase of ERTS. NASA Administrator James C. Fletcher argued that it was too early in the program to separate development and operations; NASA opposed the bill.
Sept. 18, 1974	In further hearings on establishing operational offices for ERTS, an OMB official testified that it was too early to set up such a management structure for the still-experimental satellite.
Nov. 25, 1974	Senator Frank E. Moss introduced an amendment to one of the bills that would have established operational offices for ERTS; his amendment would continue experimentation with earth resources remote-sensing satellite systems through 1979. NASA and the Department of the Interior would have to ensure continuity of satellite data during this period.
1974	During its operations through 1974, <i>ERTS 1</i> had transmitted 100 000 photos covering three-fourths of the earth's land masses; over 300 U.S. and foreign investigators had received data.
Jan. 14, 1975	NASA changed the name of the project from ERTS to Landsat.
Jan. 22, 1975	NASA successfully launched <i>Landsat 2</i> .

Table 4-161. Chronology of Landsat Development and Operations (Continued)

Date	Item
Apr. 4, 1975	NASA awarded Goodyear Aerospace Corp. a contract for a Special Purpose Processor to augment existing computing capability for <i>Landsat 2</i> 's Large Area Crop Inventory Experiment.
Oct. 20, 1975	NASA awarded RCA a contract for the return beam vidicon for Landsat C, which would have twice the resolution of earlier instruments.
Dec. 16, 1975 Dec. 1975	NASA chose Lockheed Electronics Co. to supply the tape recorder for Landsat C. As of December 1975, <i>Landsat 2</i> had returned more than 53 000 images; 300 000 messages from data-collection platforms had been sent to users; 2600 sample sites for the Large Area Crop Inventory Experiment had been processed. NASA declared that primary objectives had been achieved.
Jan. 30, 1976	The General Accounting Office submitted a report on Landsat to Congress. It recommended, among other things, that NASA implement a training program for potential users of Landsat data.
Dec. 1, 1977	The House of Representatives Committee on Science and Technology recommended a five-year Earth Resources Satellite Information System validation program to assure a more orderly management of earth resources activities.
Early 1978	NASA terminated <i>Landsat 1</i> (ERTS 1) operations.
Mar. 5, 1978	NASA successfully launched <i>Landsat 3</i> .
July 1978	Lockheed opened a remote sensing applications laboratory in Houston to market Landsat data products.
Jan. 1980	NASA retired <i>Landsat 2</i> .
June 1980	NASA reactivated <i>Landsat 2</i> to participate in tests being conducted by NOAA.

Table 4-162. Landsat 1 Characteristics

Also called: Earth Resources Technology Satellite (ERTS 1)
Date of launch (location): July 23, 1972 (WTR)
Launch vehicle: Thor-Delta 0900
Weight (kg): 941
Shape: Butterfly
Dimensions (m): 3.0 height 3.4 width with solar panels extended
Power source: Solar panels plus 8 NiCd batteries
Responsible NASA center: Goddard Space Flight Center
Prime contractor: General Electric Co.
Project manager: W. E. Scull
Project scientist: W. Nordberg
Objectives: Acquisition of synoptic, multispatial images for three months from which useful data can be obtained for investigations in such disciplines as agriculture and forestry, resources management, land use, marine research, mapping, and charting.
Instrumentation: Multispectral Scanner (4-band scanning radiometer) Return Beam Vidicon Camera System (3-camera high-resolution TV sensor) Data Collection System Wide-band Tape Recorders (2)
Results: Successful; NASA terminated operations in early 1978.

Reference: NASA Hq., "ERTS-A Press Kit," July 20, 1972.

Table 4-163. Landsat 2 Characteristics

---

Also called: Earth Resources Technology Satellite (ERTS B)  
 Date of launch (location): Jan. 22, 1975 (WTR)  
 Launch vehicle: Delta 2910  
 Weight (kg): 953  
 Shape: Butterfly  
 Dimensions (m): 3.0 height  
                   3.4 width with solar panels extended  
 Power source: Solar panels plus 8 NiCd batteries  
 Responsible NASA center: Goddard Space Flight Center  
 Prime contractor: General Electric Co.  
 Project manager: Jack Sargent  
 Project scientist: Stanely C. Freden  
 Objectives: Acquisition of sufficient multispectral imagery over the U.S. and foreign countries to improve remote sensing interpretive techniques and to further demonstrate the practical applications of ERTS-type data.  
 Instrumentation: Multispectral Scanner (4-band scanning radiometer)  
                   Return Beam Vidicon Camera System (3-camera high-resolution TV sensor)  
                   Data Collection System  
                   Wide-band Tape Recorders (2)  
 Results: Successful; NASA retired the system in Jan. 1980 and reactivated it six months later for further tests.

---

Reference: NASA, "Landsat 2 Mission Operations Report," E-641-7502, Jan. 9, 1975.

Table 4-164. Landsat 3 Characteristics

---

Also called: Earth Resources Technology Satellite (ERTS C)  
 Date of launch (location): Mar. 5, 1978 (WTR)  
 Launch vehicle: Delta 2910  
 Weight (kg): 900  
 Shape: Butterfly  
 Dimensions (m): 3.0 height  
                   3.4 width with solar panels extended  
 Power source: Solar panels plus 8 NiCd batteries  
 Responsible NASA center: Goddard Space Flight Center  
 Prime contractor: General Electric Co.  
 Project manager: R. Browning  
 Project scientist: Stanley C. Freden  
 Objectives: Acquisition of multispectral imagery with the five-band multispectral scanner over large areas of the world to further demonstrate the applications of Landsat imagery for crop inventory and other practical uses; acquisition of high-resolution return beam vidicom data.  
 Instrumentation: Multispectral Scanner (5-band scanning radiometer)  
                   Return Beam Vidicon Camera System (2-camera high-resolution TV sensor)  
                   Data Collection System  
                   Wide-band Tape Recorders (2)  
 Results: Successful.

---

Reference: NASA, "Landsat 3 Mission Operations Report," E-641-78-03, Feb. 22, 1978.

**Other Earth Observation Flight Projects.** NASA launched five other earth observation-type missions during the 1970s: *GEOS 3*, *LAGEOS*, *Seasat 1*, *TOPO 1*, and *Heat Capacity Mapping Mission (HCMM)*.

*GEOS 3* was the third satellite in a series designed to gain knowledge of earth's shape and dynamic behavior (*Explorer 29* and *Explorer 36* preceded it in 1965 and 1968). NASA specifically assigned *GEOS 3* the task of measuring precisely the topography of the ocean surface and the sea state—wave height, period, and direction. Launched in April 1975 from the Western Test Range and directed by the Wallops Flight Center, it spent its first year providing altimeter calibrations from the North Atlantic to investigators and conducting global satellite-to-satellite (*GEOS 3* to *ATS 6*) calibrations, in addition to providing ground tracking data. The rest of the satellite's lifetime was spent collecting ground tracking data and providing altimeter data globally. Active until 1979, *GEOS 3* contributed to fulfilling the oceanographic, geodetic, and radar calibration requirements of the Department of Commerce and the Department of Defense and served as an interim step between the National Geodetic Satellite Program and the emerging earth and ocean physics applications program (see table 4-165).

The golf ball-appearing *LAGEOS*, launched in May 1976, was a passive satellite covered with more than 400 laser retroreflectors. Under the management of the Marshall Space Flight Center, *LAGEOS* demonstrated the capability of laser satellite tracking techniques to make accurate determinations of the movement of the earth's crust and rotational motions. The concept for such a mission was initially studied by the Smithsonian Astrophysical Observatory (SAO) in 1970 and by Marshall Space Flight Center (Project Cannonball) in 1971. With *LAGEOS*, investigators observed phenomena associated with earthquakes, fault motions, regional strain fields, dilatancy, tectonic plate motion, polar motion, earth rotation, and solid earth tides. The satellite was tracked by SAO's Baker-Nunn camera network (see table 4-166).

In 1973, NASA proposed a satellite project by which the feasibility of acquiring data applicable to monitoring and predicting physical ocean phenomena could be demonstrated. Interest in such a capability was shared by the National Oceanographic and Atmospheric Administration and the Department of Commerce. NASA Headquarters assigned *Seasat* to the Jet Propulsion Laboratory in 1975, who chose Lockheed as the prime spacecraft contractor later that year. With its five sensors, *Seasat 1* was launched from the Western Test Range in June 1978. Unfortunately, 106 days after launch the spacecraft failed because of an electrical short (see table 4-167).

In 1970, NASA launched on a reimbursable basis *TOPO 1* for the U.S. Army Topographic Command. This small satellite was the first of a series designed to investigate a new technique for accurate real-time determination of position on earth's surface for mapping purposes. *TOPO 1* was part of the Army's Geodetic Sequential Collation of Range Program (see table 4-168).

The Heat Capacity Mapping Mission, also known as Applications Explorer Mission A, was launched by a Scout vehicle on April 26, 1978. In near-earth sun-synchronous orbit, HCMM proved the feasibility of using day/night thermal imagery to generate apparent thermal inertial values and temperature cycle data for a variety of purposes. Investigators hoped these data could be applied to measuring and monitoring surface soil moisture changes, measuring plant canopy temperatures, measuring urban heat levels, mapping surface thermal gradients on

land and in water and related tasks. HCMM's major instrument was a Heat Capacity Mapping Radiometer. The mission was the first in what was hoped would be a series of low-cost modular spacecraft that would operate in special orbits to satisfy unique data acquisition requirements on an experimental basis (see table 4-169).

Table 4-165. GEOS 3 Characteristics

---

Also called: Geodynamics Experimental Ocean Satellite  
 Date of launch (location): Apr. 9, 1975 (WTR)  
 Launch vehicle: Delta 1410  
 Weight (kg): 340  
 Shape: Octahedron topped by a truncated pyramid with a gravity gradient boom extending from one end and a doppler beacon from the other  
 Dimensions (m): 1.32 width  
                   0.81 length (6 maximum overall length)  
 Power source: Solar cells plus NiCd batteries  
 Responsible NASA center: Wallops Flight Center  
 Prime contractor: Johns Hopkins Applied Physics Laboratory  
 Project manager: Laurence C. Rossi  
 Project scientists: H. Ray Stanley  
 Objectives: Demonstrate the feasibility and utility of mapping the geometry of the sea surface and measuring wave height; contribute to the development of technology for future satellite radar altimeter systems.  
 Instruments: Radar Altimeter  
                   C-Band and S-Band Transponders  
                   Laser Retroreflectors  
 Results: Successful; NASA terminated the operations of the altimeter in July 1979.

---

Reference: NASA, "GEOS 3 Mission Operations Report," E-855-75-01, Apr. 8, 1975.

Table 4-166. LAGEOS Characteristics

---

Also called: Laser Geodynamics Satellite  
 Date of launch (location): May 4, 1976 (WTR)  
 Launch vehicle: Delta 2913  
 Weight (kg): 411  
 Shape: Spherical (covered with 426 laser retroreflectors, giving it the appearance of a golf ball)  
 Dimensions (m): 0.6 diameter  
 Power source: Passive  
 Responsible NASA center: Marshall Space Flight Center  
 Prime contractor: Bendix Corp., satellite assembly  
                   Perkin-Elmer Corp, laser retroreflectors  
 Project manager: Charles W. Johnson  
 Project manager, orbital phase: Chris C. Stephanides, Goddard Space Flight Center  
 Project scientist: David Smith, Goddard Space Flight Center  
 Objectives: Over a period of many years from a 5900-kilometer orbit, demonstrate the feasibility of using a ground-to-satellite laser ranging system to monitor motion of earth's tectonic plates, to monitor geodetic reference systems, to determine more accurately universal time, and to collect data on the time-varying behavior of earth's polar positions.  
 Special feature: Laser Retroreflectors (426)  
 Results: Successful.

---

Reference: NASA Hq., "Project Lageos Press Kit," Press Release 76-67, Apr. 15, 1976; Victor Seigel, "Earth's Shifting Surface," ASA 80-3 (NASA's About Space and Aeronautics series), Mar. 1980; and Robert L. Spencer, "Lageos—A Geodynamics Tool in the Making," *Journal of Geological Education* 25 (Mar. 1977): 38-42.

Table 4-167. Seasat 1 Characteristics

---

Also called: Ocean Dynamics Satellite  
 Date of launch (location): June 27, 1978 (WTR)  
 Launch vehicle: Atlas F  
 Weight (kg): 2300  
 Shape: Two-module spacecraft: cylindrical support bus with two solar paddles; and a roughly cylindrical sensor module with antennas and instruments extending from it  
 Dimensions (m): 21.0 length  
                   1.5 diameter  
 Power source: Solar panels plus NiCd batteries  
 Responsible NASA center: Jet Propulsion Laboratory  
 Prime contractor: Lockheed Missiles and Space Co.  
 Project manager: W. E. Giberson  
 Objectives: Demonstrate techniques for global monitoring of oceanographic data for both applications and scientific user; demonstrate key features of an operational ocean dynamics monitoring system.  
 Instruments: Scanning Multichannel Microwave Radiometer  
                   Radar Altimeter  
                   Microwave Wand Scatterometer  
                   Synthetic Aperture Imaging Radar  
                   Visible and Infrared Scanning Radiometers  
 Results: Successful for 106 days when it lost power on Oct. 10 because of a short in one of the slip-ring assemblies used to connect the rotating solar arrays into the power subsystem. NASA declared the satellite lost on Nov. 21, 1978.

---

Reference: NASA, "Seasat 1 Mission Operations Report," E-655-78-01, June 23, 1978; and U.S. Congress, House of Representatives, Committee on Science and Technology, Subcommittee on Space Science and Applications, *SEASAT (Cost, Performance and Schedule Review); Report*, 95th Cong., 1st sess. (Washington, 1977).

Table 4-168. TOPO 1 Characteristics

---

Also called: Topographic Satellite  
 Date of launch (location): Apr. 8, 1970 (WTR)  
 Launch vehicle: Thorad-Agena D  
 Weight (kg): 18  
 Shape: Rectangular  
 Dimensions (m):  $0.36 \times 0.30 \times 0.23$   
 Power source: Solar cells plus NiCd battery  
 NASA role: Launch vehicle (reimbursable); launched with Nimbus 4 weather satellite.  
 Cooperating organizations: NASA and U.S. Army Topographic Command, Off. of Chief of Engineers  
 Results: Investigate a new technique for accurate real-time determination of position on the earth's surface for mapping purposes.  
 Instruments: Electronic ranging equipment  
 Results: Successful; first of a series that would utilize tracking equipment and spacecraft from the Army's Geodetic SECOR (Sequential Collation of Range) Program.

---

Reference: NASA, "Nimbus 4 Mission Operations Report," S-604-70-04, Apr. 6, 1970.

Table 4-169. Heat Capacity Mapping Mission Characteristics

---

Also called: HCMM; Applications Explorer Mission A (Aem-A)

Date of launch (location): Apr. 26, 1978 (WTR)

Launch vehicle: Scout

Weight (kg): 134

Shape: 6-sided prism with 2 solar panels

Dimensions (m):  $0.63 \times 0.63$ ; 1.6 with solar panels extended

Power source: Solar cells plus NaCd battery

Date of reentry: Feb 28, 1983

Responsible NASA center: Goddard Space Flight Center

Prime contractor: Boeing Aerospace Co.

Project manager: Larry R. Tant

Objectives: To conduct research into the feasibility of using day/night thermal imagery to generate apparent thermal inertial values and temperature cycle data.

Instrument: Heat Capacity Mapping Radiometer (HCRM)

Results: Successful; orbits allowed measurement of earth's surface for its maximum temperature and then 12 hours later measured the same area's minimum temperature.

---

Reference: NASA, "Heat Capacity Mapping Mission (HCMM) Launch," E-651-78-01, Apr. 19, 1978.

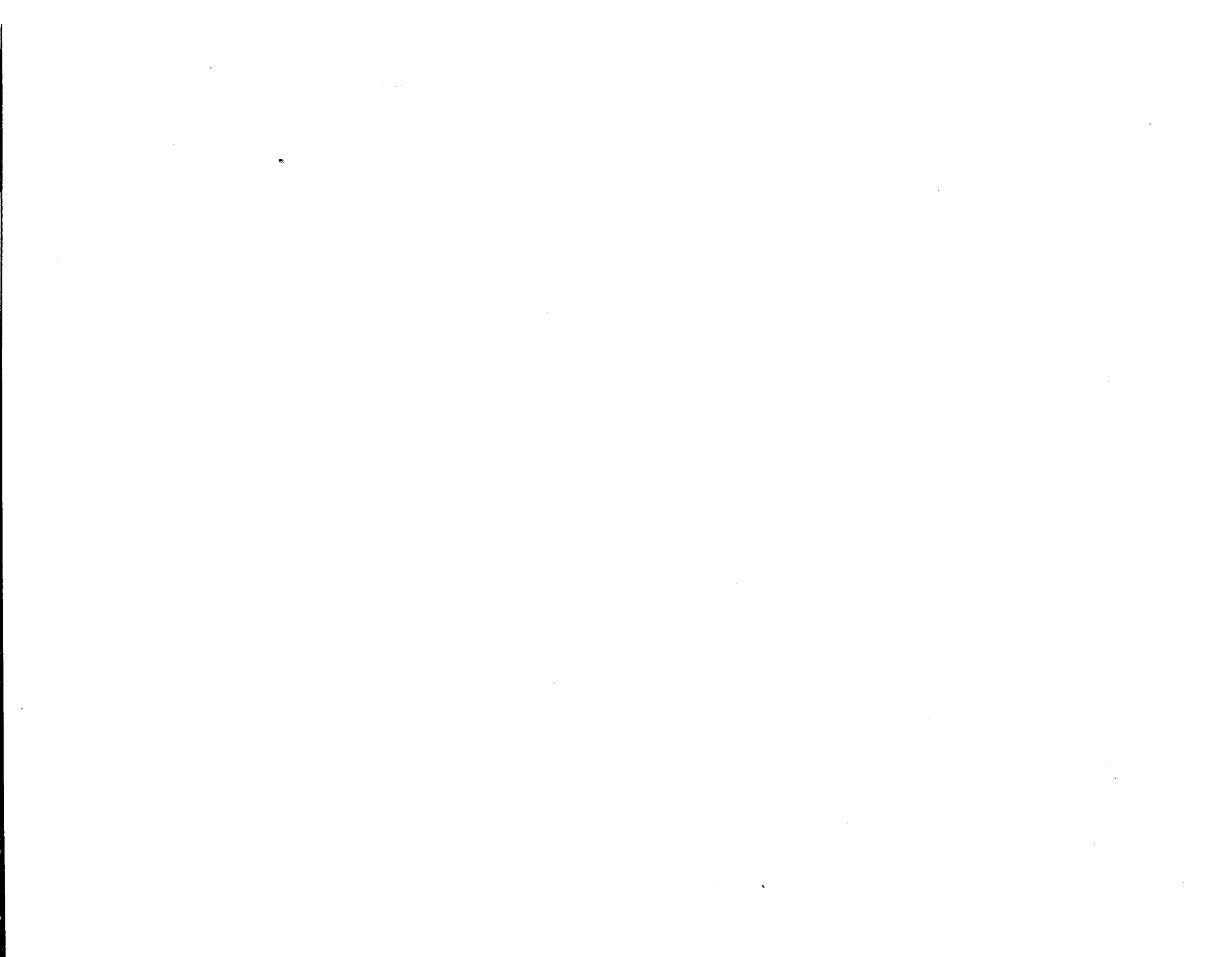



PRECEDING PAGE BLANK NOT FILMED



---

CHAPTER FIVE

---

**AERONAUTICS AND  
SPACE RESEARCH**

---

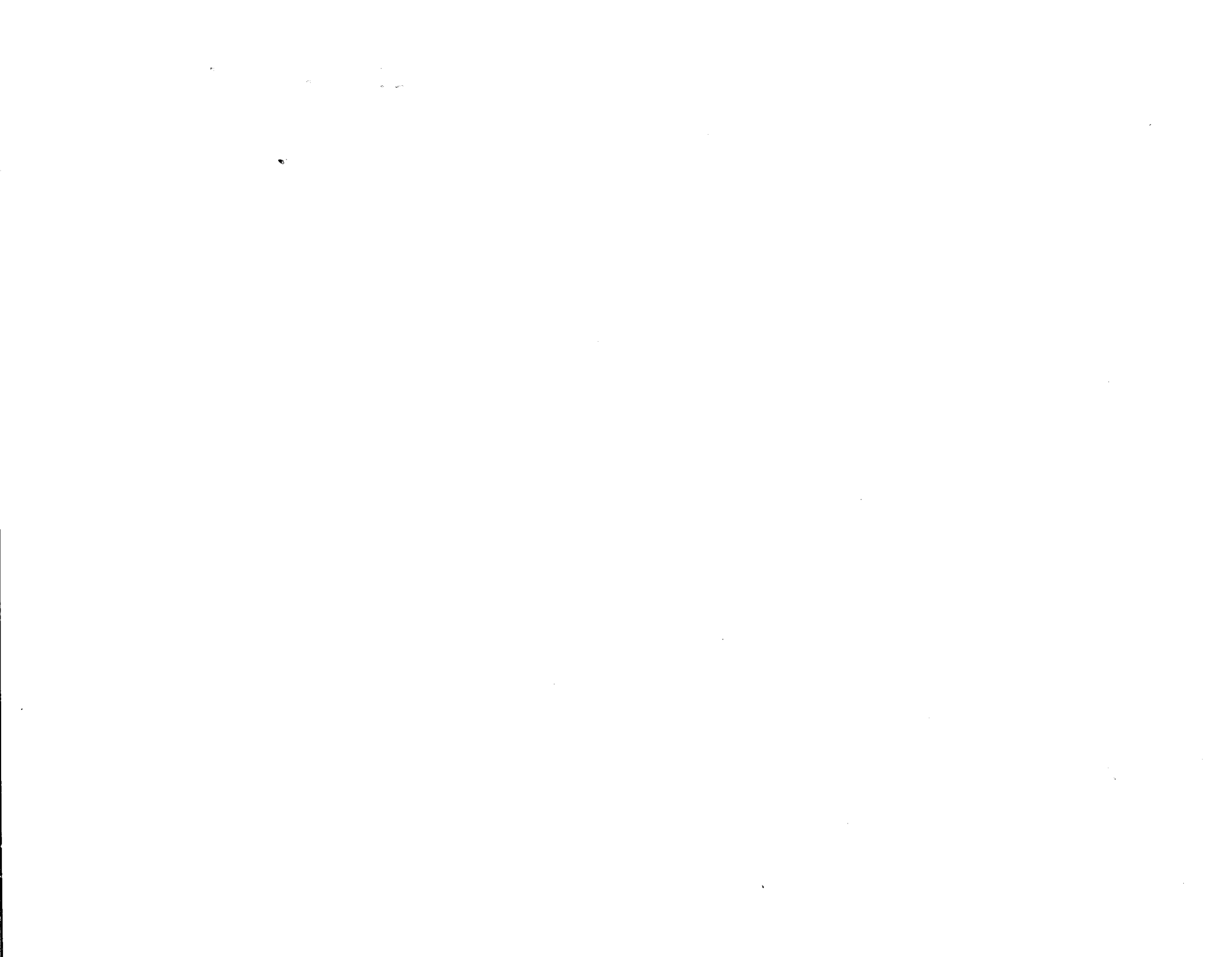

## CHAPTER FIVE

# AERONAUTICS AND SPACE RESEARCH

### INTRODUCTION

During most of NASA's first 14 years, advanced research tasks, aeronautical and space, were assigned to the Office of Advanced Research and Technology (OART).<sup>\*</sup> More than any other directorate of the civilian space agency, OART was patterned after the National Advisory Committee for Aeronautics (NACA), NASA's predecessor organization. Congress established NACA in 1915 to address the growing number of problems posed by the airplane. Five years later, the advisory body became a national research organization with its own aeronautical laboratory with purview for such research areas as aircraft power plants, aerodynamics, materials and structures, aircraft construction, and operating problems. The NACA also shared responsibility with the military services for guided missile and rocket research in the 1940s, and had grown to include four research centers when NASA was established in the fall of 1958.

#### The First Decade Reviewed

OART's programs were less visible and often harder to define and justify than those of the manned spaceflight and science and applications offices, but they were equally important. NASA was charged during its first decade with sending a man to the moon and returning him safely and exploring the near-earth and interplanetary environments, tasks that required great advances in technology. OART helped provide new electronic and computing equipment, attitude control devices, more comfortable and efficient life support systems, highly productive solar cells, and other pieces of hardware and processes without which NASA could not have accomplished its many goals.

OART's basic research program addressed four areas: fluid physics, electrophysics, materials, and applied mathematics. The space vehicle systems group

---

<sup>\*</sup> OART was established as part of the November 1961 agencywide reorganization. For more on the management of advanced research projects during NASA's first decade, see vol. 2.

looked at advanced spacecraft design and structure, with special emphasis on reentry configurations and aerodynamics. NASA's popular lifting body program was conducted by the Space Vehicle Research Division, with flight testing at the Flight Research Center in California. The Electronics and Control Division continually improved the onboard guidance and navigation systems carried by manned and unmanned spacecraft, data processing procedures, and communications and tracking systems. Scientists, medical doctors, and technicians concerned with human factor systems designed and tested life support equipment needed by astronauts and conducted experiments on advanced man-vehicle systems. Electric, chemical, and nuclear propulsion also were subjects tackled by OART personnel.

Aeronautics research received the biggest share of OART's attention and budget during the 1960s, and a trend toward greater participation in aeronautics was building late in the decade. Although most of NASA's energies were delegated to space projects during the first decade, aeronautics teams were assigned to conduct or oversee applied research in every regime of flight, from hovering to supersonic, including the well-publicized X-15 project. General aviation needs were also addressed by OART.

### **Aeronautics and Space Technology, 1969–1978**

Advanced research needs during the early years of NASA's second decade were met as they had been during the first 10 years. But a 1972 reorganization and increasing attention to basic and applied aeronautical research drastically changed the flavor of the agency's research program. Formally, the new Office of Aeronautics and Space Technology (OAST) was designed to serve national needs by building a research and technology base, conducting systems and design studies, and carrying out systems and experimental programs. Its work fell into the following categories: air transportation system improvement, spacecraft subsystem improvement, providing technical support to the military, and applications of technology to nonaerospace systems.<sup>1</sup>

Specifically, OAST and its contractors worked on such projects as reducing aircraft noise and airport congestion, short takeoff and landing aircraft crosswind landings, vertical takeoff and landing aircraft autoland systems, aircraft ride quality, aircraft safety, fire safety technology, advanced supersonic aircraft technology, optical mass memory systems, laser communications, new solar energy systems, Space Shuttle support, and atmospheric entry designs. This list is just a sampling; OAST was flexible and changed its goals as directed by NASA management, Congress, the military services, and industry.

### **Managing the Aeronautics and Space Technology Program**

From 1969 through 1978, OART/OAST had nine different associate administrators, either acting or permanently assigned, leading the program's activities. Each brought his own management style and changes. Table 5-1 tracks the Office of Advanced Research and Technology and the Office of Aeronautics and Space Technology through four distinct phases of management.

James M. Beggs, who had become the associate administrator for OART in 1968, left NASA in early 1969 to become Under Secretary of Transportation. Bruce T. Lundin and Oran W. Nicks took turns as acting heads of the office until Roy P. Jackson was appointed in November 1970. Jackson rejoined Northrop Corporation in late 1973. Edwin C. Kilgore and Bruce K. Holloway served as temporary leaders until Alan M. Lovelace was assigned the job in August 1974. Lovelace became Deputy Director of the agency in 1976, leaving the research post vacant again. Robert E. Smylie acted in the position until December 1976, when James J. Kramer was assigned as associate administrator for OAST, first as acting, then permanently in October 1977. The associate administrators were assisted by a revolving cast of deputies, special assistants, and division directors (see table 5-1 for details).

It was NASA's policy to conduct a great amount of its work through contractors, whose work was directed, monitored, and augmented by an in-house staff. Research centers that contributed primarily to the agency's research and aeronautics program included the Flight Research Center (aeronautics flight testing) in California, Ames Research Center (life sciences, aeronautics) in California, Langley Research Center (aeronautics) in Virginia, and the Lewis Research Center (propulsion) in Ohio.

Table 5-1. Four Phases of Advanced Research (OART/OAST) Management, NASA Headquarters

---

Phase I  
1969

Administrator/Deputy Administrator

Associate Administrator, Office of Advanced Research and Technology (James M. Beggs; Bruce T. Lundin, acting, March 1969)

Deputy Associate Administrator (Lundin)

Deputy Associate Administrator, Aeronautics (Charles W. Harper)

Director, Aeronautical Vehicles Div. (William Pomeroy; Albert J. Evans, spring 1969)

Director, Biotechnology and Human Research Div. (Walton J. Jones)

Director, Chemical Propulsion Div. (Adelbert O. Tischler)

Director, Electronics and Control Div. (Frank J. Sullivan)

Director, Mission Analysis Div. (Leonard Roberts)

Director, Power and Electric Propulsion Div. (William H. Woodward)

Director, Programs and Resources Div. (Paul E. Cotton)

Director, Basic Research Div. (Hermann H. Kurzweg)

Director, Special Programs Off. (R. D. Ginter)

Director, Space Vehicles Div. (Milton B. Ames, Jr.)

Manager, AEC-NASA Space Nuclear Propulsion Off. (Milton Klein)

OART Safety Officer (H. Kurt Strass)

Phase II  
1970-1974

Administrator/Deputy Administrator

Associate Administrator, Office of Advanced Research and Technology/Office of Aeronautics and Space Technology (1972) (Oran W. Nicks, acting; Roy P. Jackson, Nov. 1970; Edwin C. Kilgore, acting, Oct. 1973; Bruce K. Holloway, acting, March 1974; Alan M. Lovelace, Aug. 1974)

Deputy Associate Administrator, Aeronautics (Neil A. Armstrong; dropped 1972; J. Lloyd Jones, 1974)

Table 5-1. Four Phases of Advanced Research (OART/OAST) Management,  
NASA Headquarters (Continued)

Deputy Associate Administrator, Management (Kilgore; dropped 1974)  
 Deputy Associate Administrator, Programs (George W. Cherry; added 1972; dropped 1974)  
 Deputy Associate Administrator, Technology (Seymour C. Himmel; added 1972; Robert E. Smylie, 1973)  
 Director, Advanced Concepts and Mission Div. (Richard J. Wisniewski; dropped 1973)  
 Director, Aeronautical Operating Systems Div. (Cherry; Robin Ransome, 1972; Kenneth E. Hodge, 1973)  
 Director, Aeronautical Propulsion Div. (Albert J. Evans, acting; Harry W. Johnson, 1971)  
 Director, Aeronautical Research Div./Aerodynamics and Vehicle Systems Div. (1971) (Evans; William S. Aiken, Jr., acting, 1972; J. Lloyd Jones, mid-1972; Kramer, 1974)  
 Director, Advanced Transport Technology Program Off./Supercritical Technology Office (1971)/Transportation Experiment Program Off. (1972)/Transport Technology Programs Off. (1974) (Gerald G. Kayten; William H. Gardner, acting, 1973; Aiken, 1974)  
 Director, Guidance, Control, and Information Systems Div. (Sullivan; Peter R. Kurzhals, 1974)  
 Director, Environmental Systems and Effects Div./Aeronautical Life Sciences Div. (1971)/Aeronautical Man-Vehicle Technology Div. (1973) (Walton L. Jones; Leo Fox, 1971; Gene E. Lyman, 1972)  
 Director, Lifting Body Program Off./Entry Technology Off. (1971) (Frederick J. DeMeritte; dropped late 1973)  
 Director, Materials and Structures Div. (George C. Deutsch)  
 Chairman, Research Council/Chief Scientist, OAST (Kurzweg; dropped early 1974)  
 Director, Research and Institutional Management Div. (Cotton; E.H. Schneider, 1972; Frank E. Penaranda, 1974)  
 Director, Safety and Operating Systems Off. (Strass; John C. Loria, 1972; dropped 1974)  
 Director, Shuttle Technologies Off./Manned Space Technology Off. (1973) (Tischler; William Hayes, 1972)  
 Manager, Space Nuclear Systems Off. (Klein; David S. Gabriel, 1972; dropped 1973)  
 Director, Space Propulsion and Power Div. (Woodward)  
 Director, Short Takeoff and Landing Program Off. (Kayten; dropped 1972)  
 Director, Technology Applications Off./Energy and Environmental Technology Off. (1973) (Ginter; dropped 1974)  
 Director, Military Aircraft Program Off. (Albert J. Evans; added 1972)  
 Director, JT3D/JT8D Refan Program Off. (James J. Kramer; William H. Roudebush, 1973; added 1972)  
 NASA Deputy Director, NASA-DOT Noise Abatement Off. (Walter Dankhoff; Bernard Maggin, fall 1972; added 1972)  
 Director, Advanced Supersonic Technology Off./Hypersonic Research Off. (Aiken; added 1972; dropped 1974)  
 NASA Deputy Director, NASA-DOT CARD Study Implementation Off. (W. N. Gardner; added mid-1972)  
 Director, Applications and Space Science Technology Off. (DeMeritte; added fall 1973)  
 Director, Research Div. (Carl Schwenk; added 1973)  
 Director, Study and Analysis Off. (Kayten; added 1973)  
 Director, Independent Research and Development Off. (Ralph R. Nash; added 1974)

Phase III  
1975-1977

Administrator/Deputy Administrator

Associate Administrator, Office of Aeronautics and Space Technology (Lovelace; Smylie, acting, July 1976; Kramer, acting, Dec. 1976; Kramer, Oct. 1977)  
 Deputy Associate Administrator (Smylie; Kramer, acting, fall 1976; Paul F. Holloway, acting, late 1976)  
 Special Assistant for Civil Aviation (Hodge; added 1976)  
 Special Assistant for Military Aviation (Evans; added 1976)

Table 5-1. Four Phases of Advanced Research (OART/OAST) Management,  
NASA Headquarters (Continued)

---

Director, Aerodynamics and Vehicle Systems Div. (Kramer; Aiken, 1976)  
 Director, Aeronautical Man-Vehicle Systems Div. (Lyman)  
 Director, Space Technology Coordinating Off. (DeMeritte)  
 Director, Guidance, Control, and Information Systems Div./Electronics Div. (1977) (Kurzahls)  
 Director, Military Aircraft Program Off. (Evans; dropped 1976; Evans became Special Assistant)  
 Director, Aeronautical Propulsion Div. (Johnson)  
 Director, Resources and Management Systems Div. (Penaranda)  
 Director, Aeronautical Operating Systems Off. (Hodge)  
 Director, Space Propulsion and Power Div. (James Lazar)  
 Director, Research Div. (Schwenk)  
 Director, Space Shuttle Technology Payloads Off. (Hayes)  
 Director, Civil Aircraft Programs Off. (Aiken; dropped 1976; Hodge became Special Assistant)  
 Director, Materials and Structures (Deutsch)  
 Director, Study, Analysis, and Planning Off. (Kayten)  
 Director, Aircraft Energy Efficiency Off. (Kramer; added 1976)  
 Director, Research Aircraft Program Off. (Evans; added 1976)

Phase IV  
1978

Administrator/Deputy Administrator

Associate Administrator, Office of Aeronautics and Space Technology (Kramer)

Deputy Associate Administrator (John M. Kleinberg)

Chief Engineer (Aiken)

Director, Energy Systems Div. (Ralph I. LaRock, acting; Donald A. Beattie, late 1978)

Director, Aeronautical Systems Div. (Aiken, acting)

Director, Resources and Management Systems Div. (C. Robert Nysmith, acting; William P. Peterson, late 1978)

Director, Administration and Program Support Div. (Nysmith)

Director, Space Systems Div. (Kurzahls, acting)

Director, Research and Technology Div. (Deutsch)

---

## BUDGET

The Office of Advanced Research and Technology/Office of Aeronautics and Space Technology routinely received from 7 to 11% of NASA's total research and development budget, with the bulk of the funds going to manned spaceflight and space science and applications programs. OART/OAST's projects were smaller, were often conducted under the joint auspices of another government agency, and were sometimes short-term; they usually did not require expensive flight tests. OART/OAST products often hitched a test ride on manned and scientific payloads.

Because of the changing management of OART/OAST and its evolving goals, it is not possible to trace the funding for individual projects over the 10-year period as done in the other chapters. Instead, the following budget charts present funding data for each year. Selected projects are reported on individually. For more detailed information, consult the NASA annual budget estimates. However, the user should not expect to find the budget categories to be similar from year to year or to be broken down into smaller project fields.

Table 5-2. OART Budget Estimate, 1969

Basic Research	\$ 22 000 000
Space Vehicle Systems	35 300 000
Electronic Systems	39 400 000
Human Factor Systems	21 700 000
Space Power and Electric Propulsion Systems	44 800 000
Nuclear Rockets	60 000 000
Chemical Propulsion	36 700 000
Aeronautics	76 900 000
Total	<u>\$336 800 000</u>
Total NASA R&D Budget	\$3 677 200 000
Percentage of Total for OART	9%
Selected Projects:	
Aeronautics	
Advanced Research and Technology	\$ 16 080 000
General Aviation	520 000
V/STOL	9 600 000
Subsonic	15 100 000
Supersonic	24 220 000
Hypersonic	11 380 000
Space Vehicle Systems	
Lifting Body Program	1 200 000
Human Factor Systems	
Otolith	1 500 000
Space Power and Electric Propulsion Systems	
SNAP	7 500 000
Nuclear Rockets	
NERVA	<u>41 000 000</u>



Table 5-3. OART Budget Estimate, 1970

Basic Research	\$ 21 400 000
Space Vehicle Systems	30 000 000
Electronic Systems	35 000 000
Human Factor Systems	23 600 000
Space Power and Electric Propulsion Systems	39 900 000
Nuclear Rockets	36 500 000
Chemical Propulsion	25 100 000
Aeronautics	78 900 000
Total	\$290 400 000
 Total NASA R&D Budget	 \$3 877 520 000
 Percentage of Total for OART	 7%
 Selected Projects:	
Aeronautics	
Advanced Research and Technology	\$ 21 785 000
General Aviation	500 000
V/STOL	11 250 000
Subsonic	16 190 000
Supersonic	20 900 000
Hypersonic	8 275 000
Space Vehicle Systems	
Lifting Body Program	1 200 000
Human Factor Systems	
Otolith	2 000 000
Space Power and Electric Propulsion Systems	
SNAP	5 000 000
Nuclear Rockets	
NERVA	27 500 000

Table 5-4. OART Budget Estimate, 1971

Basic Research	\$ 17 600 000
Space Vehicle Systems	30 000 000
Electronic Systems	22 400 000
Human Factor Systems	17 900 000
Space Power and Electric Propulsion Systems	30 900 000
Nuclear Rockets	38 000 000
Chemical Propulsion	20 300 000
Aeronautics	87,100 000
Total	\$264 200 000
Total NASA R&D Budget	\$2 606 100 000
Percentage of Total for OART	10%
Selected Projects:	
Aeronautics	
Advanced Research and Technology	\$ 31 565 000
General Aviation	925 000
V/STOL	15 030 000
Subsonic	11 900 000
Supersonic	21 905 000
Hypersonic	5 775 000
Nuclear Rockets	
NERVA	32 000 000

Table 5-5. OAST Budget Estimate, 1972

Aeronautics Research and Technology	\$110 000 000
Space Research and Technology	75 105 000
Nuclear Power and Propulsion	27 720 000
Total	\$212 825 000
Total NASA R&D Budget	\$2 517 700 000
Percentage of Total for OAST	8%
Selected Projects:	
Aeronautics	
Experimental STOL Transport Research	\$ 15 000 000
Aerodynamics and Vehicle Systems	42 000 000
Propulsion	22 300 000
Operating Systems	6 500 000
Materials and Structures	11 000 000
Guidance, Control, and Information	3 000 000
Power	400 000
Supercritical Technology	6 700 000
Nuclear Power and Propulsion	
NERVA	9 900 000

Table 5-6. OAST Budget Estimate, 1973

Aeronautics Research and Technology	\$163 440 000
Space Research and Technology	64 760 000
Nuclear Power and Propulsion	21 100 000
Total	<u>\$249 300 000</u>
Total NASA R&D Budget	\$2 600 900 000
Percentage of Total for OAST	10%
Selected Projects:	
Aeronautics	
Research and Technology Base	\$ 90 640 000
Systems and Experimental Programs	65 800 000
Systems and Design Studies	7 000 000
Experimental Quiet Engine for CTOL	1 000 000
Experimental Quiet Engine for STOL	2 000 000
JT 3D/JT8D Refan Project	9 000 000
YF-12 Project	4 700 000
Rotor System Test Vehicle Research	1 500 000
Tilt Rotor Research	1 500 000
VTOL Experiments	500 000
STOL Experiments	2 500 000
Space Research	
Lifting Body Program	700 000

Table 5-7. OAST Budget Estimate, 1974

Aeronautics Research and Technology	\$171 000 000
Space Research and Technology	65 000 000
Nuclear Power and Propulsion	4 000 000
Total	<u>\$240 000 000</u>
Total NASA R&D Budget	\$2 288 000 000
Percentage of Total for OAST	10%
Selected Projects:	
Aeronautics	
Research and Technology Base	\$ 79 001 000
Systems and Design Studies	5 473 000
Systems and Experimental Programs	86 526 000
Quiet Clean Short-Haul Experimental Engine	4 000 000
Refan Project	18 000 000
YF-12 Project	5 499 000
TACT	1 122 000
Rotor Systems	5 266 000
Tilt Rotor Research	5 345 000
VTOL Experiments	800 000
STOL Experiments	4 667 000
Space Research	
Lifting Body Program	1 050 000

Table 5-8. OAST Budget Estimate, 1975

Aeronautics Research and Technology	\$166 400 000
Space and Nuclear Research and Technology	74 800 000
Total	\$241 200 000
Total NASA R&D Budget	\$2 346 015 000
Percentage of Total for OAST	10%
Selected Projects:	
Aeronautics	
Research and Technology Base	\$ 83 900 000
Systems and Design Studies	5 000 000
Systems and Experimental Programs	47 500 000
Quiet Clean Short-Haul Experimental Engine	10 000 000
Refan Project	1 000 000
YF-12 Project	5 300 000
TACT	800 000
Rotor Systems	7 100 000
Tilt Rotor Research	1 500 000
VTOL Experiments	4 300 000
Space Research	
Lifting Body Program	1 000 000

Table 5-9. OAST Budget Estimate, 1976

Aeronautics Research and Technology	\$175 350 000
(plus transition quarter)	46 800 000
Space Research and Technology	74 900 000
(plus transition quarter)	22 300 000
Total	\$319 350 000
Total NASA R&D Budget	\$2 678 380 000
(plus transition quarter)	730 600 000
Total	\$3 408 980 000
Percentage of Total for OAST	9%
Selected Projects (1976 + transition quarter):	
Research and Technology Base	\$108 900 000
Systems Studies	3 700 000
Systems Technology Programs	62 350 000
Experimental Programs	47 200 000
Quiet Clean Short-Haul Experimental Engine	12 000 000
Tilt Rotor Research	2 200 000
Rotor Systems	3 100 000

Table 5-10. OAST Budget Estimate, 1977

Aeronautics Research and Technology	\$189 100 000
Space Research and Technology	82 000 000
Total	\$271 100 000
Total NASA R&D Budget	\$2 758 925 000
Percentage of Total for OAST	10%
Selected Projects:	
Aeronautics	
Research and Technology Base	\$ 89 700 000
Systems Studies	3 000 000
Systems Technology Programs	60 800 000
Experimental Programs	35 600 000
Quiet Clean Short-Haul Experimental Engine	3 300 000
Tilt Rotor Research	800 000
Rotor Systems	300 000
Highly Maneuverable Aircraft	5 500 000

Table 5-11. OAST Budget Estimate, 1978

Aeronautics Research and Technology	\$231 000 000
Space Research and Technology	97 700 000
Total	\$328 700 000
Total NASA R&D Budget	\$3 011 000 000
Percentage of Total for OAST	11%
Selected Projects:	
Aeronautics	
Research and Technology Base	\$ 97 550 000
Systems Studies	3 000 000
Systems Technology Programs	72 200 000
Experimental Programs	58 250 000
Quiet Clean Short-Haul Experimental Engine	600 000
Tilt Rotor Research	300 000
Highly Maneuverable Aircraft	2 800 000

## PROGRAM DESCRIPTIONS

### Research

During NASA's first decade and until a 1970 reorganization of the Office of Advanced Research and Technology, basic research was included as one of its major divisions. Basic research was defined as fundamental investigations of the physical and mathematical laws that governed NASA's flights. Findings did not have to have a specific application to any ongoing projects, but instead contributed to the general pool of scientific knowledge in the subject area. The term "basic" was dropped in

1970 and OART/OAST's research tasks became increasingly applicable to approved agency projects.

Hermann H. Kurzweg, appointed director of research in 1961, was active in that position until 1970, when he was named chief scientist for OAST. The chief scientist position was dropped in early 1974. In the 1970 reorganization, George C. Deutsch became director of a Materials and Structures Division, materials and structures having previously been part of the basic research program. A Research Division was added to OAST again in 1973, with Carl Schwenk serving as its director through 1977. In 1978, the office was renamed research and technology, and Deutsch was appointed director.

The basic research program was divided into four sections: fluid dynamics, electrophysics, materials, and applied mathematics. As noted above, materials and structures became increasingly important as an applied research field during the 1970s. Research also continued in the other areas, albeit at a less visible level. The research program was never generously funded, but it was supported by all NASA's research centers and a great many contractors.

**Fluid dynamics.** Specialists working in this field sought to better understand the different flow processes of liquid and gas mixtures involved in aircraft, spacecraft, and propulsion system operation. NASA was especially interested in the dynamics of entry into an atmosphere.

Among the many investigations under way in the 1970s, the following are typical: gas dynamic laser research, sonic boom research, fluid dynamics of the interaction and dispersion of atmospheric pollution, and skin-friction balance for measurements of the skin friction of supersonic aircraft structures. Progress was also made on resolving some of the confusion and scatter that existed in wind tunnel measurements of the location and extent of the transition of the viscous boundary layer from laminar to turbulent.

In 1974, NASA attempted to launch a Space Plasma High Voltage Interaction Experiment (Sphinx) into an elliptical orbit to investigate the effect of charged particles on high-voltage solar cells, insulators, and conductors. Sphinx was an auxiliary payload, to be launched with a Viking spacecraft model by a Titan IIIE-Centaur. Because of a launch vehicle failure, the vehicles were destroyed by the range safety officer eight minutes after launch.

**Electrophysics.** This special branch of physics is devoted to investigating the macroscopic and atomic electric behavior of solids, liquids, and magnetic force fields. Among other things, NASA specialists assigned to this field during the 1970s worked on a technique for continuously tuning a laser over many wavelengths. Such a technique was needed to develop a laser for use in electronic communication systems. In another task, tests were conducted to develop techniques for avoiding voltage breakdown in radio frequency transmission lines and antennas.

**Applied mathematics.** Mathematicians working for NASA investigated a class of stochastic optimal control problems to learn more about exact solutions of nonlinear stochastic differential equations. Performance criteria included minimum time, minimum expected fuel consumption, and least upper bound fuel consumption. The results were applicable to calculations relating to the control of vehicles by low-thrust engines.

**Materials and structures.** The aim of materials and structures research is to provide increased payload capability as a result of structural weight reductions and low-

cost energy conservation systems. Specific assignments included the following: developing a new technique for obtaining more processable higher-temperature-resistant polymers for use as matrix materials in advanced resin fiber composites; finding a seal that can maintain close separation without solid-to-solid rubbing; designing a feedback-controlled heat pipe and a thermal diode heat pipe that permit heat transfer in only one direction (tested aboard *ATS-6*; improving thermal protection for manned reentry vehicles; developing new composite materials overwrapped on metal liners for use in pressure vessels; inventing graphite-polyimide structures for use in advanced space vehicles; and developing an iron-based alloy for use in cryogenic fuel tanks.

In 1970, NASA released for public use its computer program for structural analysis (NASTRAN). It was used in the design and analysis of various types of aeronautical and space vehicle structures and in the design of other structures such as railroad roadbeds and tracks, nuclear reactors, and skyscrapers. With NASTRAN, engineers could conduct complete thermal analyses as well as predict aircraft flutter.

### Space Vehicle Systems

The Space Vehicle Systems Division within OART/OAST was concerned with problems vehicles might encounter during launch, ascent through the atmosphere, spaceflight, and atmospheric entry. During NASA's second decade, this group conducted two major aerothermodynamic research projects: lifting body research and planetary entry research.

Milton B. Ames, an old NACA hand, was director of the Space Vehicle Division from 1961 until the 1970 reorganization. The 1970 roster listed Frederick J. DeMeritte as director of the lifting body/entry technology program until 1973, when the division was dropped. It reappears in 1975 as the Aerodynamics and Vehicle Systems Division, led by James J. Kramer. William S. Aiken, Jr., assumed the post in 1976, when Kramer became acting associate administrator. In 1978, Aiken was acting director of the Aeronautical Systems Division.

**Lifting bodies.** Lifting bodies, wingless vehicles that obtain aerodynamic lift from their shape alone, were the subject of serious research at NASA from the early 1960s through 1975. This configuration was one of three that was studied in the original search in the 1950s for a suitable spacecraft design, and many specialists at NASA's Ames and Langley Research Centers believed that the glider concept would have merit for a later-generation vehicle. During NASA's first 10 years, Langley and Ames sponsored wind tunnel research and flight testing on a variety of lifting body designs.

Two lifting bodies were flight tested at NASA's Flight Research Center in the California Mojave Desert during the 1960s. Both were built by Norair Division of Northrop Corporation. Ames Research Center personnel favored a flattop round-bottomed vehicle with a blunt nose and vertical tail fins called the M2-F1/2. Langley designed a round-top flat-bottomed vehicle, also with a blunt nose and three vertical tail fins, designated the HL-10 (see table 5-12). Both were designed to be released in midair from under the wing of a B-52, from which they could glide to a desert landing strip or conduct a powered test flight. Made of aluminum, they weighed less than 2500 kilograms and could accommodate one pilot.

The M2-F2, first flown in 1966, was damaged during a crash landing during its 16th flight. The HL-10's maiden flight also took place in 1966. Two years later an XLR-11 engine was installed to give it the capability of powered flight. Under the terms of a joint agreement, both NASA and Air Force pilots tested the lifting bodies at the Flight Research Center, which shared facilities with Edwards Air Force Base. Additionally, the Air Force had its own lifting body design, the X-24 built by the Martin Company, which NASA pilots would help evaluate.

Lifting body test flights became almost routine during the early 1970s. The M2-F2 was rebuilt as the M2-F3 (see table 5-13). Northrop added a center vertical fin and installed an XLR-11 engine. Flown for the first time in June 1970, it was tested 27 times before it was retired in December 1972. It reached supersonic speeds for the first time in August 1971 and later flew at a top speed of Mach 1.6.

Pilots flew the HL-10 for a total of 37 flights and simulated Space Shuttle-type approach and landings. The HL-10 reached a maximum speed of Mach 1.86 and an altitude of 27 524 meters. Its last flight was in July 1970.

Martin completed the X-24A in July 1967, and NASA and the Air Force spent until early 1969 conducting wind tunnel and captive flight tests with it (see table 5-14). It took its first glide flight in April 1969; it was flown powered the following September. The Air Force's lifting body was a half-cone (flat top and round bottom) with three vertical tail fins. Like the others it was equipped with an XLR-11 engine and weighed 2850 kilograms. It was flown 28 times. A fire in the engine section caused minor damage in August 1970, and the Air Force sent it back to Martin for external modifications. A forebody was added to the nose, and the planform was changed into a double-delta configuration. The 6250-kilogram X-24B flat iron had higher lift/drag characteristics, which increased its flexibility as a test vehicle (see table 5-15). The planform also was representative of configurations being investigated for future hypersonic aircraft. Pilots tested the X-24B 36 times from August 1973 through November 1975. Its fastest speed was Mach 1.76, its maximum altitude 22 580 meters. The very last lifting body flight conducted by NASA was with the X-24B: the 144th flight on November 26, 1975. NASA had decided that it had obtained all the useful flight data on transonic and hypersonic flight that could be had from the three lifting body types and terminated its program (see table 5-16 for a log of flights). Much of the data would prove valuable in the design of the reusable Space Shuttle.

The Air Force continued to pursue more advanced lifting body designs. NASA had originally agreed to contribute to an X-24C hypersonic (Mach 6) flight testing program, but had to terminate its support in 1978 for budgetary reasons (see table 5-17 for more information on the development of the X-24).



Table 5-12. HL-10 Lifting Body Characteristics

Shape:	Half-cone body (round top, flat bottom) with blunt nose and three vertical tail fins.
Dimensions (m):	
Length:	6.75
Width:	4.59
Height:	3.48
Engine:	XLR-11
Weight (kg):	2400 (with water ballast test tanks full, 4100)
Construction:	Aluminum
Controls:	Thick elevon between each fin and center fin for pitch and roll; split rudder on center fin for yaw and speed brake
First flight:	December 22, 1966
Last flight:	July 17, 1970
Times flown:	37
Test pilots:	Bruce A. Peterson, Jerauld R. Gentry, John A. Manke, William H. Dana, Peter Hoag
Cognizant:	LaRC (design)
NASA center:	FRC (flight testing)
Program manager:	John McTigue, FRC
Contractor:	Northrop Corporation, prime
Remarks:	Also used to simulate Shuttle prototype approach and landing sequence.
Mode of operation:	Released in midair from under the wing of a B-52.

Table 5-13. M2-F3 Lifting Body Characteristics

Shape:	Half-cone body (flattop, round bottom) with blunt nose and three vertical tail fins
Dimensions (m):	
Length:	6.75
Width:	2.92
Height:	2.69
Engine:	XLR-11
Weight (kg):	2300 (with water ballast test tanks full, 4100)
Construction:	Aluminum
Controls:	Rudder on outer face of each fin for yaw; upper flaps for roll control and pitch trim; full-length pitch flap on lower surface of tail; center vertical fin for improved lateral control
First flight:	June 2, 1970
Last flight:	December 21, 1972
Times flown:	27
Test pilots:	William H. Dana, John A. Manke, Cecil Powell, Jerauld R. Gentry
Cognizant:	ARC (design)
NASA center:	FRC (flight testing)
Program manager:	John McTigue
Contractor:	Northrop Corporation, prime
Remarks:	Modified M2-F2, which suffered a crashlanding in May 1967; redesignated the M2-F3; center vertical fin added.
Mode of operation:	Released in midair from under the wing of a B-52

Table 5-14. X-24A Lifting Body Characteristics

---

Shape:	Half-cone body (flattop, round bottom) with round nose and three vertical tail fins
Dimensions (m):	
Length:	7.5
Width:	4.1
Engine:	XLR-11
Weight (kg):	2850
Construction:	Aluminum
Controls:	Aileron and elevator and pair of split rudders on each of the outer fins ,
First flight:	April 17, 1969
Last flight:	June 4, 1971
Times flown:	28
Test pilots:	Jerauld R. Gentry, John A. Manke, Cecil Powell
Cognizant:	ARC
NASA center:	FRC (flight testing)
Program manager:	John McTigue, FRC
Contractor:	Martin Marietta Corporation
Remarks:	Joint Air Force-NASA program (earlier called SV-SP)
Mode of operation:	Released in midair from under the wing of a B-52

---

Table 5-15. X-24B Lifting Body Characteristics

---

Shape:	Double-delta planform, flat-bottom (flat-iron shaped)
Dimensions (m):	
Length:	11.9
Width:	7.1
Height:	3.14
Engine:	XLR-11
Weight (kg):	6250
Construction:	Aluminum
Controls:	78° double delta for center-of-gravity control, 3° nose ramp for hypersonic trim; nosewheel steering; dual rudders; ailerons
First flight:	August 1, 1973
Last flight:	November 26, 1975
Times flown:	36
Test pilots:	John A. Manke, Michael V. Love, Einar Enevoldson, Francis R. Scobee, Thomas McMurty
Cognizant:	ARC
NASA center:	ARC
Program manager:	John McTigue, FRC
Contractor:	Martin Marietta Corporation
Remarks:	Air Force modification of X-24A (FDL-8 shape built around X-24A frame)
Mode of operation:	Released in midair from under the wing of a B-52

---

Table 5-16. Lifting Body Flight Log, 1969-1975

No.	Date	Flight no.*	Pilot	Max. alt. (m)	Max. speed (km/hr)	Max. Mach	Flight time (sec.)	Remarks
1969								
31	04-17	H-1-2	Jerauld R. Gentry (USAF)	14 450	763	.72	217	
32	04-17	H-15-27	John A. Manke (NASA)	16 070	973	.99	400	3 chambers activated
33	04-25	H-16-28	William H. Dana (NASA)	13 720	743	.70	252	
34	05-08	X-2-3	Gentry	13 720	735	.69	253	
35	05-09	H-17-29	Manke	16 250	1197	1.13	410	3 chambers activated; 1st supersonic
36	05-20	H-18-30	Dana	14 970	959	.09	414	
37	05-28	H-19-31	Manke	18 960	1311	1.24	398	2 chambers activated
38	06-06	H-20-32	Peter C. Hoag (USAF)	13 720	727	.67	231	
39	06-19	H-21-33	Manke	19 540	1483	1.40	378	2 chambers activated
40	06-23	H-22-34	Dana	19 450	1350	1.27	373	2 chambers activated
41	08-06	H-23-35	Manke	23 190	1641	1.54	372	First 4-chambered flight
42	08-21	X-3-5	Gentry	12 190	615	.58	270	
43	09-03	H-24-37	Dana	23 760	1541	1.45	414	4 chambers activated
44	09-09	X-4-7	Gentry	12 190	647	.59	232	4 chambers activated
45	09-18	H-25-39	Manke	24 140	1340	1.26	426	4 chambers activated
46	09-24	X-5-8	Gentry	12 190	637	.59	257	
47	09-30	H-26-40	Hoag	16 380	780	.92	436	2 chambers activated
48	10-22	X-6-10	Manke	12 190	623	.59	238	
49	10-27	H-27-41	Dana	18 470	1675	1.58	417	
50	11-03	H-28-42	Hoag	19 540	1482	1.40	439	
51	11-13	X-7-11	Gentry	13 720	687	.65	270	
52	11-17	H-29-43	Dana	19 690	1693	1.59	408	
53	11-21	H-30-44	Hoag	24 169	1532	1.43	378	
54	11-25	X-8-12	Gentry	13 720	730	.69	266	
55	12-12	H-31-46	Dana	24 370	1401	1.31	428	
1970								
56	01-19	H-32-47	Hoag	26 410	1398	1.31	410	
57	01-26	H-33-48	Dana	26 730	1443	1.35	411	
58	02-18	H-34-49	Hoag	20 520	1976	1.86	380	Max. speed for HL-10

Table 5-16. Lifting Body Flight Log, 1969-1975 (Continued)

No.	Date	Flight no.*	Pilot	Max. alt. (m)	Max. speed (km/hr)	Max. Mach	Flight time (sec.)	Remarks
59	02-24	X-9-14	Gentry	14 326	819	.77	258	
60	02-27	H-35-51	Dana	27 524	1400	1.31	416	Max. alt. for HL-10
61	03-19	X-10-15	Gentry	13 533	919	.87	434	First powered X-24 flight
62	04-02	X-11-17	Manke	17 892	919	.87	435	
63	04-22	X-12-17	Gentry	17 587	981	.93	408	
64	05-14	X-13-18	Manke	13 594	795	.75	513	2 chambers activated
65	06-02	M-17-26	Dana	13 716	755	.69	218	First M2-F3 flight
66	06-11	H-36-52	Hoag	13 716	809	.74	202	
67	06-17	X-14-19	Manke	18 593	1051	.99	432	
68	07-17	H-37-53	Hoag	13 716	803	.73	252	
69	07-21	M-18-27	Dana	13 716	708	.66	228	
70	07-28	X-15-20	Gentry	17 678	996	.94	388	
71	08-11	X-16-21	Manke	19 477	1047	.99	413	
72	08-26	X-17-22	Gentry	12 649	737	.69	479	2 chambers activated
73	10-14	X-18-23	Manke	20 696	1261	1.19	411	First supersonic flight
74	10-27	X-19-24	Manke	21 763	1446	1.36	417	
75	11-02	M-19-28	Dana	13 716	690	.63	236	
76	11-20	X-20-25	Gentry	20 604	1456	1.37	432	
77	11-25	M-20-29	Dana	15 819	859	.81	377	First powered flight for M2-F3
1971								
78	01-21	X-21-26	Manke	15 819	1093	1.03	462	
79	02-04	X-22-27	Cecil Powell (USAF)	13 716	700	.66	235	
80	02-09	M-21-30	Gentry	13 716	755	.71	241	
81	02-18	X-23-28	Manke	20 544	1606	1.51	447	
82	02-26	M-22-31	Dana	13 716	821	.77	348	
83	03-01	X-24-29	Powell	17 343	1064	1.00	437	
84	03-29	X-25-30	Manke	21 488	1667	1.60	446	Max speed for X-24
85	05-12	X-26-32	Powell	21 610	1477	1.39	423	
86	05-25	X-27-33	Manke	19 903	1265	1.19	548	3 chambers activated
87	06-04	X-28-34	Manke	16 581	867	.82	517	Final X-24A flight

Table 5-16. Lifting Body Flight Log, 1969-1975 (Continued)

No.	Date	Flight no.*	Pilot	Max. alt. (m)	Max. speed (km/hr)	Max. Mach	Flight time (sec.)	Remarks
88	07-23	M-23-34	Dana	18 440	788	.93	353	
89	08-09	M-24-35	Dana	18 898	1035	.97	415	
90	08-25	M-25-37	Dana	20 513	1163	1.10	390	First M-2 supersonic flight
91	09-24	M-26-38	Dana	12 802	772	.73	210	
92	11-15	M-26-39	Dana	13 716	784	.74	215	
93	12-01	M-28-40	Dana	21 580	1356	1.27	391	
94	12-16	M-29-41	Dana	14 265	861	.81	451	
1972								
95	07-25	M-30-45	Dana	18 562	1049	.99	420	
96	08-11	M-31-46	Dana	20 480	1168	1.10	375	
97	08-24	M-32-47	Dana	20 330	1344	1.27	376	
98	09-12	M-33-48	Dana	14 020	935	.88	387	
99	09-27	M-34-49	Dana	20 330	1424	1.34	366.5	
100	10-05	M-35-50	Dana	20 210	1455	1.37	376	
101	10-19	M-36-51	Manke	14 360	961	.91	359	
102	11-01	M-37-52	Manke	21 730	1292	1.21	378	
103	11-09	M-38-53	Powell	14 260	961	.91	364	
104	11-21	M-39-54	Manke	20 330	1524	1.44	377	
105	11-29	M-40-55	Powell	20 570	1432	1.35	357	
106	12-06	M-41-56	Powell	20 820	1265	1.19	332	
107	12-13	M-42-57	Dana	20 330	1712	1.613	383	Max. speed for M-2
108	12-21	M-43-58	Manke	21 790	1377	1.29	390	Last M2-F3 flight; max alt.
1973								
109	08-01	B-1-3	Manke	12 190	740	0.65	252	First glide flight for X-24B
110	08-17	B-2-4	Manke	13 720	722	0.66	267	
111	08-31	B-3-5	Manke	13 720	771	.73	277	
112	09-18	B-4-6	Manke	13 720	724	.69	271	
113	10-04	B-5-9	Michael V. Love (USAF)	13 720	732	.69	279	
114	11-15	B-6-13	Manke	16 080	961	.92	404	First X-24B powered flight
115	12-12	B-7-14	Manke	19 080	1038	.99	307	
1974								
116	02-15	B-8-15	Love	13 720	724	.68	307	
117	05-05	B-9-16	Manke	18 390	1139	1.09	437	First X-24B supersonic flight

Table 5-16. Lifting Body Flight Log, 1969-1975 (Continued)

No.	Date	Flight no.*	Pilot	Max. alt. (m)	Max. speed (km/hr)	Max. Mach	Flight time (sec.)	Remarks
118	04-30	B-10-21	Love	15 860	930	.88	419	
119	05-24	B-11-22	Manke	17 060	1212	1.14	448	
120	06-14	B-12-23	Love	19 970	1303	1.23	405	
121	06-28	B-13-24	Manke	20 770	1480	1.39	427	
122	08-08	B-14-25	Love	22 370	1644	1.54	395	
123	08-29	B-15-26	Manke	22 080	1170	1.10	467	
124	10-25	B-16-27	Love	21 990	1873	1.76	417	Max. speed for X-24B
125	11-15	B-17-28	Manke	21 960	1722	1.62	481	
126	12-17	B-18-29	Love	20 960	1667	1.59	420	
1975								
127	01-14	B-19-30	Manke	22 180	1862	1.75	477	
128	03-20	B-20-32	Love	21 450	1537	1.44	409	
129	04-18	B-21-33	Manke	17 650	1279	1.20	450	
130	05-06	B-22-34	Love	22 370	1541	1.44	448	
131	05-22	B-23-35	Manke	22 580	1744	1.63	461	Max. alt. for X-24B
132	06-06	B-24-36	Love	21 980	1786	1.68	474	
133	06-25	B-25-38	Manke	17 680	1427	1.34	426	
134	07-15	B-26-39	Love	21 180	1685	1.58	415	
135	08-05	B-27-40	Manke	18 290	1381	1.23	420	
136	08-20	B-28-41	Love	21 950	1625	1.58	420	
137	09-09	B-29-42	Dana	21 640	1593	1.50	435	
138	09-23	B-30-43	Dana	17 680	1255	1.20	438	Last rocket-powered flight
139	10-09	B-31-44	Einar Enevoldson (NASA)	13 720	724	.70	251	
140	10-21	B-32-45	Francis R. Scobee (USAF)	13 720	743	.70	255	
141	11-03	B-33-46	Thomas McMurtry (NASA)	13 720	734	.70	248	
142	11-12	B-34-47	Enevoldson	13 720	734	.70	241	
143	11-19	B-35-48	Scobee	13 720	740	.70	249	
144	11-26	B-36-49	McMurtry	13 720	740	.70	245	Last lifting body flight

\* Vehicle letter code, plus flight number of that particular vehicle, plus B-52 carrier flight number (M = M2-F3, H = HL-10, X = X-24, B = X-24B).

Table 5-17. Chronology of X-24A/B/C Lifting Body Development and Operations

Date	Item
July 1967	X-24A rolled out by Martin Marietta Corp. and turned over to Air Force.
Feb.-March 1968	Ames Research Center conducts wind tunnel tests on the X-24A.
Apr. 4, 1969	USAF/NASA conducted the first captive flight of the X-24A.
Apr. 17, 1969	USAF/NASA conducted the first glide flight of the X-24A.
Sep. 9, 1969	USAF/NASA conducted the first powered flight of the X-24A.
Aug. 26, 1970	A fire in the rocket engine section caused minor damage.
Dec. 15, 1971	X-24A was shipped to Martin Marietta for conversion into a new configuration.
Feb. 4, 1972	NASA and the Air Force signed a memorandum of understanding on the use of the X-24B and other lifting bodies.
Oct. 11, 1972	Martin Marietta rolled out the X-24B, with delivery to the Flight Research Center scheduled for Oct. 22.
June 1973	Under an Air Force contract, Martin Marietta studied a growth version of the X-24B.
June 1973	Personnel at the Flight Research Center conducted taxi tests with the X-24B.
July 19, 1973	USAF-NASA conducted the first captive flight test with the X-24B.
Aug. 1, 1973	USAF-NASA conducted the first glide test with the X-24B.
Nov. 15, 1973	USAF-NASA conducted the first powered flight test with the X-24B.
Feb. 15, 1974	The X-24B flew at supersonic speed for the first time.
Oct. 1974	An X-24C model was subjected to wind tunnel tests at the Arnold Engineering Development Center.
Oct. 25, 1974	The X-24B reached its maximum speed of Mach 1.76.
May 22, 1975	The X-24B reached its maximum altitude of 22 580 meters.
Aug. 5, 1975	The X-24B made its first runway landing.
Nov. 26, 1975	NASA conducted its last lifting body flight, using the X-24B.
Dec. 1975	NASA and the Air force signed a memorandum of understanding on the development of an experimental aircraft for hypersonic manned flight testing (X-24C).
July 20, 1976	Air Force held a prebid conference for potential contractors on the X-24C.
Aug. 1976	A new X-24C configuration was tested in wind tunnels at Arnold.
Aug. 31, 1978	NASA terminated its support of the X-24C project for budget reasons.

**Planetary entry.** NASA had approval to send two instrumented landers to the planet Mars in 1976 and needed an entry and landing system to ensure the vehicles a soft touchdown. Over five years, OAST's space vehicle systems group conducted a variety of flight and wind tunnel tests of large parachutes designed for the Viking landers. The specialists were concerned with obtaining more stable operation at high speeds and with the very low density and pressure conditions of the Martian atmosphere. The type of chute chosen was the disc-gap-band parachute.

In a related area of research, OAST tested an inflatable device designed to be attached to the aft end of a planetary entry vehicle to provide even greater deceleration. OAST also developed a computing program to determine the heating rates of spacecraft during planetary entry.

On June 20, 1971, OAST conducted a Planetary Atmosphere Experiments Test at Wallops Station, Virginia, using a Scout booster. The test demonstrated that it was possible to obtain density, pressure, and temperature data from a probe vehicle entering the atmosphere at a high speed (see table 5-18).

In 1974, an Advanced Atmosphere Entry Technology program was initiated to

establish a base of information to permit the design of probes that could safely land on the outer planets. Included in the program were methods for estimating entry heating.

Table 5-18. PAET Mission Characteristics

---

Also called: Planetary Atmosphere Experiments Test	
Date of launch (location): June 20, 1971 (Wallops)	
Launch vehicle: Scout	
Dimensions (cm): 64.0 long 91.4 diameter	
Shape: Blunt cone with spherical segment nose; hemispherical afterbody.	
Date of reentry: June 20, 1971	
Cognizant NASA center: Ames Research Center	
Objectives:	To investigate means of determining structure and composition of unknown planetary atmosphere; determine if circular spiral pitching motion could be achieved with blunt entry vehicle; obtain flight performance data on low-density ablator.
Results:	Successful; spacecraft achieved planned trajectory; real-time and delayed-time playback telemetry were obtained.

---

Reference: NASA, "Planetary Atmosphere Experiments Test (PAET)," Press Kit 71-99, June 13, 1971.

## Guidance, Control, and Information Technology

Recognizing the importance of electronics to the development and reliable operation of spacecraft, NASA worked to build an expertise in this field during the 1960s. When the Office of Advanced Research and Technology was first established in late 1961, a division of electronics and control was included in its organization. In addition to expanding electronics activities at the agency's existing centers and among its contractors, NASA established an Electronics Research Center (ERC) near Cambridge, Massachusetts, in 1964. ERC was responsible for guidance and control, instrumentation and data processing, communications, and electromagnetic research.

During the budget-cutting years after the successful Apollo lunar landing, NASA was forced by Congress to close ERC in 1970. NASA Administrator Thomas O. Paine admitted that the agency "could not afford to continue to invest broadly in electronics research."<sup>2</sup> On June 30, the facility was transferred to the Department of Transportation as the Transportation Systems Center. Electronics research in support of space and aeronautics projects would again be assigned to the remaining NASA centers and to its contractors. During NASA's second decade, efforts were directed at improving the operational characteristics and data handling efficiency of a great number of electronics systems, while reducing their size, weight, cost, and power requirements. By 1978, NASA's official goal was to develop "a technology base that would enable a 1000-times increase in flow of space-derived information at one-tenth the cost of mission operations."<sup>3</sup> Following is a sampling of projects conducted during the 1970s.

At the Ames Research Center, specialists, working from flight test records and digital computers, developed a new procedure for mathematically modeling air-



frames, vehicle control systems, and pilot dynamics. This procedure made possible more accurate predictions of vehicle and pilot performance before flight.

Ames, the Marshall Space Flight Center, and the Manned Spacecraft Center worked together to develop a backup manual guidance and control system for the Saturn V launch vehicle. This system gave Apollo astronauts the added capability of injecting into earth orbit for some failures of the automatic guidance and control system rather than aborting the mission.

Before ERC closed, personnel there completed an operational model of a scanning electron mirror microscope. The instrument was built to examine semiconductor devices, particularly integrated circuits that do not have multilevel flat surfaces.

ERC also developed a technique for more cost-effective programming of small computers. Called a time-shared disc operating system, it allowed the computer to participate in program development by continuous interaction with the user.

NASA also was involved in the development of a pilot warning collision threat indicator that would be acceptable to the general aviation industry. Specialists at Ames worked to optimize operating frequencies, size, and weight, thereby reducing its cost. A first round of flight tests of the hardware took place in the early 1970s. Ames was also involved in enhancing the safety and utility of general aviation aircraft by designing a new split-surface control system and an inexpensive flight director display system.

Goddard Space Flight Center was assigned the task of overseeing research in optical methods for data processing. Scientists applied lasers and coherent optics to the problems of handling large amounts of experiment data from spacecraft.

At Langley, an improved landing radar for vertical and short takeoff and landing (V/STOL) aircraft was tested. This device proved excellent for measuring range and range rate at low altitudes. In 1972, a totally automatic landing system was demonstrated by a CH 46 helicopter.

The Jet Propulsion Laboratory, which is charged with the agency's deep space exploration program, worked on a large dish-type antenna that could be stowed folded during launch. The antenna was composed of a single curved surface. Specialists believed that an antenna as large as 17 meters was possible. JPL also readied a dual frequency (S-X band) experiment that was flown on *Mariner 10*, which was launched in November 1973.

Together, Ames and Goddard produced telemetry coding techniques that improved information transmission rate and error reduction for spacecraft communications channels. A laboratory prototype was built in 1970.

Also at Goddard, a team developed microcircuit techniques during the early 1970s that were applicable to the design of low-power high-performance miniaturized spacecraft computing systems.

In 1970, Goddard conducted its first balloon experiments to measure the effect of the atmosphere on laser beams. A detector package was carried aloft by the balloon, and two lasers on the ground operated at wavelengths of 10.6 and 0.5 microns. Marshall Space Flight Center in 1973 conducted laser communication tests using high-altitude aircraft.

Marshall developed and tested an inertial laser gyro for use on a three-axis strapdown system. Digital gyro data were sent directly to a computer to determine the rate and position of the vehicle. Langley, also working on control gyro research,

designed a high-response variable-momentum control moment gyro. It could be applied to spacecraft control systems and had twice the momentum storage capacity of a similar device carried on Skylab.

The first flight of an aircraft in which the control surfaces were moved through electronic signal inputs and digital computers with no mechanical reversion capability was made at Flight Research Center in 1972.

A CV 990 aircraft was used by Ames in 1972 to test its program to evaluate power-off automatic landings like those the reusable Space Shuttle would make in the 1980s. The autoland system provided terminal area energy management and landing guidance. Tests indicated that unpowered automatic landings would be possible with existing ground navigation aids. In another Shuttle-related research project, Langley worked to design the craft's antenna systems. Specialists were concerned with how to protect the antennas against thermal and structural stress. Langley also developed a medium-power microwave traveling wave tube for the Shuttle.

For the joint U.S.-Canadian Communications Technology Satellite, launched in 1976, OAST improved the efficiency of microwave power-amplifier tubes from 10-20% efficiency to more than 50%.

In 1975, NASA research staff demonstrated the ability of a breadboard model of an all-solid-state star tracker (STELLAR) to track automatically multiple stars in a single field of view.

Frank J. Sullivan was the director of OART/OAST's electronics program from 1965 until 1974, when Peter R. Kurzhals took over as leader of the Guidance, Control and Information Systems Division. Still under Kurzhals' direction, the office was renamed the Electronics Division in 1977, only to become the Space Systems Division the next year.

## **Human Factor Systems**

Life sciences activities at NASA were spread among three directorates: Office of Space Science, Office of Manned Space Flight (later Office of Space Flight and then Office of Space Transportation Systems), and OART/OAST. This continued a tradition begun during the 1960s. The research directorate had responsibility for the human factor systems program, in which it was held that man was a critical component of the spacecraft system, or part of a man-machine system.

Human factor specialists were concerned with the interfaces between pilot/astronaut and his craft that influenced his health, comfort, survival, and decision-making skills. Life support systems, protective garments, information displays, and spacecraft controls were all under the purview of this group. A related area of interest was understanding the physical and psychological reactions of man to long exposures to the space environment. Although a critical program, the human factor systems effort was not highly visible, and funding levels were always low. There were no major flight projects devoted solely to human factors research, although each manned spaceflight and the many series of aircraft test flights returned data of interest to the specialists. The following are examples of the kinds of projects undertaken by OAST in the field of human factor systems research.

NASA, along with the National Academy of Sciences, sought to determine the

cause for a type of motion sickness experienced by several Apollo astronauts. OART/OAST researchers developed several instruments that could be used to measure various physiological activity during flight, including an electro-optical instrument to measure the blood oxygen level and a device to measure respiratory gas flow volume digitally.

A reverse osmosis water reclamation unit using glass membranes was developed under the auspices of OART/OAST at Ames Research Center. And the Manned Spacecraft Center supported research to fabricate a prototype emergency life support system, which included a breathing vest, a gas-operated pump for air and coolant circulation, and a sublimator unit for cooling. MSC was also working on a constant-volume metal fabric spacesuit of only one layer.

Looking ahead to life aboard a permanent space station, doctors and technicians were interested in observing the results of extended confinement on human subjects. During Tektite I and II, conducted in 1969 and 1970, Navy, NASA, and Department of the Interior marine scientists and biomedical and behavioral researchers collected information on group interactions, psychomotor performance, and habitability. During the first experiment, four scientists spent 60 days in a nitrogen-oxygen environment at a depth of 13 meters in the Caribbean Sea. Several teams of scientists were observed in the second underwater environment experiment, also for 60 days. The subjects' responses to their artificial environment provided data useful in predicting crew behavior and in designing a space station habitat.

In related projects, MSC took a survey among its astronauts and among Air Force pilots to determine their preference for off-duty activities during a long-duration flight. MSC also began the development of flexible boots and other garments that would make a long flight more comfortable. At Langley Research Center, researchers designed shelters for crews stationed on the moon for long periods of time.

OART/OAST sponsored one small flight project during the second decade: the Orbiting Frog Otolith Experiment (OFO). Two bullfrogs were observed during a seven-day orbital flight in 1970 to gain information on the adaptability of the vestibule in the inner ear to sustained weightlessness and acceleration (see table 5-19).

Ames Research Center assisted the Department of Defense during the early 1970s by designing a liquid-cooled helmet for Army helicopter pilots. Pilots operating in the jungles of Southeast Asia were subjected to such severe heat that their bodies could not maintain a normal temperature. As it was impractical to cool the entire cockpit, the NASA-designed helmet liner was used to improve the pilots' comfort and heat balance.

Walton L. Jones was director of OART/OAST's Biotechnology and Human Research Division from 1964 through 1970. In 1971, the division was retitled aeronautical life sciences, and in 1973 it carried the name Aeronautical Man-Vehicle Technology Division. Leo Fox assumed the directorship in 1971, followed by Gene E. Lyman in 1972. Lyman served as director of the Aeronautical Man-Vehicle Systems Division through 1977. The 1978 management roster carried no biotechnology slot.

Table 5-19. OFO Mission Characteristics

---

Also called: Orbiting Frog Otolith Experiment  
 Launch date (location): November 9, 1970 (Wallops)  
 Launch vehicle: Scout  
 Shape: Cylindrical  
 Weight (kg): 132.5  
 Cognizant NASA center: Ames Research Center  
 Objectives: To obtain data on functioning and adaptability in weightlessness of the vestibule of the inner ear, which controls balance, through microelectrodes implanted in the vestibular nerves of two male bullfrogs (*Rana castebianca*). Mission data to be collected for three to five days.  
 Results: All mission objectives met; data collected until November 15, when batteries ceased functioning. Adaptation to weightlessness occurred and extended to the organ.

---

### Space Power and Propulsion Systems

During the 1960s, NASA continually improved the dependability and efficiency of its family of chemical propulsion launch vehicles. But advanced researchers were looking ahead to the demands of future decades and to new sources of propulsion and onboard power. Permanent orbital space stations and interplanetary spacecraft traveling far from the sun would have special requirements.

Three propulsion sources were available: chemical, electric, and nuclear. NASA had had a great deal of experience in improving chemical systems during its first decade of operations, but researchers sought during the 1970s for lighter-weight, ever more efficient systems. Electric propulsion could be put to work in zero gravity in combination with traditional chemical or nuclear vehicles. Nuclear propulsion had been the subject of much study by NASA and the Atomic Energy Commission (AEC) since 1960. The space agency had agreed to take a major responsibility in the development of a nuclear launch capability and had spent considerable funds during the 1960s developing and testing supporting hardware.

Batteries and solar cells have provided spacecraft with onboard power since the beginning of the space program, and OART/OAST worked through two decades improving this system. Battery size and weight were reduced and solar cells given longer lives and greater efficiency. Nuclear sources for spacecraft power—radioisotope generators and reactors—were studied and tested.

Lewis Research Center continued to be the lead center for advanced propulsion and power systems research during the 1970s. Large-budget projects were not approved; even so, systematic, but slow, progress on a great variety of propulsion-power sources was made.

Adelbert O. Tischler directed OART/OAST's chemical propulsion research from 1963 through 1969. Milton Klein managed the AEC-NASA Space Nuclear Propulsion Office for NASA. William H. Woodward was assigned management authority over power and electric propulsion. In the 1970 reorganization, oversight of chemical and electric propulsion and power research was combined into one office, the Space Propulsion and Power Division, under Woodward. Nuclear research remained under the purview of Klein in the Space Nuclear Systems Office. He was succeeded by David S. Gabriel in 1972; the office was dropped the following year. James Lazar replaced Woodward in 1975 and remained in that position through the rest of the second decade.

**Chemical propulsion.** During the 1960s, the most visible chemical propulsion projects being conducted by NASA were the large solid rocket motor and the M-1 liquid propellant engine, the so-called "million-pound thrust engine." Both of these projects progressed to the hardware development and testing point when a shortage of funds and lack of clear need for the big motors led to their postponement and cancellation late in the decade.

During the 1970s, NASA concentrated on less expensive chemical propulsion projects, most of which were aimed at improving currently available products or processes. Progress was made, for example, in developing a chemical process to manufacture oxygen difluoride more inexpensively. Researchers looked at a flox-methane space storable combination. And tests were conducted with gaseous oxygen and gaseous hydrogen for possible use as an auxiliary propellant.

On the solid propellant side, a series of solid motor prototypes were successfully tested during the decade in the search for a high-efficiency motor. Among their features were lightweight all-carbon nozzles and expansion cones, special igniters that provided a several-second thrust buildup to minimize shock to the spacecraft, and flexible propellants. A low-acceleration motor was also designed and tested. A high energy restartable motor that could deliver 10% more energy was tested during the early 1970s. A new sounding rocket, the Astrobee F, required OAST's assistance with the development of its dual thrust system.

OART/OAST also settled down to solving Shuttle main engine design problems. Technology efforts were directed toward improving turbomachinery and accurately calculating combined chamber and nozzle performance. Shuttle's auxiliary propulsion system demanded OAST's attention, as well, as tests proved the superiority of a high-pressure gaseous oxygen-gaseous hydrogen system.

For interplanetary spacecraft, OAST designed a hydrazine monopropellant attitude control system. The program also demonstrated the need for pump-fed engines for large planetary orbiters and landers.

Another major goal of the chemical propulsion researchers was to discover new energy storage concepts capable of more than doubling the specific impulse of current chemical rockets. They evaluated atomic hydrogen for this project with some encouraging results.

**Electric propulsion.** Electric propulsion provides relatively low-powered thrust for use in zero gravity. Once in orbit, electric propulsion systems can boost a payload into a different orbit or be used during orbital stationkeeping or docking maneuvers. Electric power generated by a solar or nuclear device is fed to a thruster system, which can be electrothermal, electrostatic, or electromagnetic. In addition to laboratory tests, NASA conducted several flight experiments during the 1960s and 1970s to evaluate candidate electric propulsion systems.

Project SERT (Space Electric Rocket Test) was initiated in the early 1960s, with the first ballistic test flight of an electric rocket being accomplished in 1964. The test proved out the Lewis Research Center electron bombardment design (cesium thruster). Official approval of an orbital test was given in 1966, but the launch was postponed until 1970. SERT 2 was to have demonstrated the long-term operation of electric thrusters, but electrical shorts in the high-voltage system caused the thrusters to fall short of their expected six months lifetime (see table 5-20).

In 1971, test of the first breadboard model of a fully automatic electric propel-

Table 5-20. SERT 2 Mission Characteristics

---

Also called:	Space Electric Rocket Test
Date of launch (location):	February 3, 1970 (Western Test Range)
Launch vehicle:	Thorad-Agena
Shape:	Cylindrical with large solar array
Weight (kg):	1500
Cognizant NASA center:	Lewis Research Center
Objectives:	To operate electric ion thruster system in space for six months; determine variation of thruster power efficiency; measure extent of coupling between ion beam and space plasma; measure magnitude of ion engine's thrust; measure long-term effects of ion thruster efflux on silicon-cell solar array.
Results:	Mission judged unsuccessful; apparent electrical shorts in the high-voltage system caused the ion thrusters to cease functioning. Thruster 1 operated 3782 hours; Thruster 2, 2011 hours (goal was 4383 hours). Secondary objectives were met; mission contributed to advancement of ion systems.

---

Reference: NASA, Lewis Research Center, "SERT II Press Kit," 70-2, Jan. 30, 1970.

sion system for an interplanetary spacecraft commenced. Such a system, which would rely on solar energy, would be used on an interplanetary flight mission.

An auxiliary electric propulsion engine was tested onboard *ATS 6*, launched in 1974 and used successfully for many years. The ion thruster engine was designed for the difficult north-south stationkeeping requirements of the satellite. By the end of the decade, NASA had made substantial progress in the development of ion thrusters for both low-energy applications and higher energy levels for primary propulsion systems.

**Nuclear propulsion.** NASA's interest in nuclear propulsion dates to the early 1960s, when the agency recognized that it should investigate how the products of atomic research would affect space power and propulsion systems. With the Atomic Energy Commission, NASA formed a joint Space Nuclear Propulsion Office, from which the space agency could monitor and evaluate any new applicable technology developed by the AEC. Powerful boosters and onboard spacecraft power systems were among the products NASA had in mind.

NASA's first joint venture with AEC included testing AEC's Kiwi family of reactors. For nuclear rocket development, NASA assumed responsibility for the nonreactor components, for combining the reactor and other hardware into engine systems, for vehicle development, and for providing the necessary propellants. Reactor testing was to be followed by the development of a prototype vehicle in 1964 and a flight vehicle in 1965. The first contract for a 75 000-pound-thrust Nuclear Engine for Rocket Applications (NERVA), of which the reactor would be one element, was let in 1961. Numerous problems with hardware development and testing led to a postponement of the schedule. NERVA required expensive test stands and a long lead time to solve the many new problems associated with the technology, and it did so at a time when Congress was looking for projects to pare from NASA's budget. But the agency's nuclear program survived into the second decade, with a new-generation reactor, Phobos, being tested during the summer of 1968 and NERVA test engines being assembled for evaluation in 1969. However, it did not flourish.

During 1969, NASA conducted NERVA tests from March through August, with 28 successful engine startups. The engine operated for a total of 2.8 hours, including 3.5 minutes at full thrust (55 000 pounds). The next year saw the preliminary design of the NERVA flight engine, with a preliminary design review being initiated in October. Studies called for reusable stages, 11 meters in diameter. In 1971, the engine baseline design was completed and engine component detailed design was initiated. Fiscal year 1972 funding restrictions allowed NASA to support only selected critical engine hardware development; other aspects of the program were put on hold. In 1972, NERVA was officially cancelled. NASA's space nuclear program was reduced to investigating ways to use atomic energy on a much smaller scale than NERVA. The next year, the joint NASA-AEC Space Nuclear Systems Office was abolished since there were no plans to use a nuclear rocket during the next 10 to 15 years. NASA's interest turned to using atomic energy for auxiliary onboard power systems.

**Electric power.** Designers could tap three sources for onboard spacecraft power: chemical, solar, and nuclear. Batteries, the chemical source, used alone can provide power for only a short time. Teamed with solar cells, they are a reliable source. The chemical-solar combination was used successfully throughout the 1960s, often tailor-made for the specific mission's needs. By the end of the first decade, this kind of system could be depended on for up to 1000 watts of electrical power. But spacecraft of the 1970s and 1980s would require megawatts of electricity for operating direct broadcast satellites or providing a crew bound for Mars enough power for their life support system. OART/OAST was tasked with finding either a much-improved solar-chemical system or a nuclear system or a combination of some kind. Two kinds of nuclear power sources were available: radioisotope generators (RTG) and reactors. The AEC-NASA partnership in place during the 1960s and early 1970s for the development of a nuclear rocket was extended to investigate nuclear power sources.

AEC had begun its Systems for Nuclear Auxiliary Power (SNAP) program in the 1950s; NASA showed interest in SNAP in the early 1960s. It chose SNAP-8, a reactor system, for future spacecraft applications and SNAP-11, an RTG, for a Surveyor orbiting lunar vehicle. With the cancellation of the Surveyor orbiter, NASA turned to AEC for an RTG for the Nimbus meteorological satellite. SNAP-19, onboard Nimbus B, sank to the bottom of the ocean along with chunks of the spacecraft after a launch vehicle failure. Another SNAP-19 proved successful onboard *Nimbus 3* in 1969. An RTG was also installed and used on the Viking Mars spacecraft, which landed in 1976. SNAP-27, an RTG, was used to power the Apollo lunar surface experiment package placed on the moon by the crew of *Apollo 12*. Pioneer probes bound for the outer satellites would also carry RTGs.

NASA continued to test reactor-type SNAPs as well. In 1971, the 2-10 Kw Brayton turbogenerator being tested by the agency passed 8000 hours of operation. A contract was let for the development of a 15-80 Kw unit. In 1975, a 2000-10 000 watt Brayton turbine power system completed more than 20 000 hours of testing.

Although considerable attention was being given nuclear power sources, NASA did not ignore chemical-solar systems. Solar cells were improved (1977 goals called for solar cells five times thinner and lighter than those in use at the time) and nongassing lightweight nickel-cadmium batteries were evaluated. Specifications were written for primary batteries with a shelf life of 5 to 10 years for outer planet atmospheric entry probes.

## Aeronautics

The Office of Advanced Research and Technology was reorganized in 1970 to “provide increasing emphasis on improving aeronautical research.”<sup>4</sup> From one OART division, aeronautics expanded to three: aeronautical operating systems, aeronautical research, and aeronautical propulsion, with special offices devoted to STOL and experimental transport aircraft. NASA was starting to answer its critics who had been accusing the space agency of ignoring the traditional role it had inherited from NACA of leading this country’s aeronautical research program. Those critics, which included the Senate Committee on Aeronautics, were concerned with the health of general and military aviation, challenges from overseas manufacturers of aircraft in the international marketplace, and the United States’s place as a technological leader.<sup>5</sup> The Committee questioned the adequacy of the nation’s aeronautics policy and urged NASA to support aeronautics more staunchly than it had during the 1960s when it had been preoccupied with landing a man on the moon.

In 1969, the Aeronautics Division held itself responsible for the advancement of subsonic, supersonic, and hypersonic flight, as well as flight safety, jet noise, sonic booms, cockpit instrumentation, aircraft handling qualities, and the operating environment. This list of concerns would grow rapidly over the next 10 years.

The 1972 change in the advanced research directorate’s name, from the Office of Advanced Research and Technology to the Office of Aeronautics and Space Technology, was more than a symbolic gesture. It put aeronautics at the associate administrator’s level at NASA Headquarters. In 1972, NASA increased its professional staff working on aeronautics projects by 7%, while reducing the total staff by 3%. According to Roy P. Johnson, Associate Administrator for OAST, “We now have 20 percent of our NASA people resource working on aeronautics technology.”<sup>6</sup> Budgets for aeronautics were also increasing. And the agency was taking on new roles: “Our goal in NASA is to provide the technology that will permit making the airplane unobtrusive in its environment,” according to Johnson.<sup>7</sup> Noise reduction would become a major OAST assignment. OAST also added a Military Aircraft Support Program Office to its roster of management tools in 1972.

Alan M. Lovelace, OAST Associate Administrator in 1976, publicly advocated that NASA should address high-risk technology development of potential near-term applicability as it related to fuel conservation, safety, and noise and emission reduction. In addition, NASA “is supporting the development of long-range technology that will provide major gains in performance, productivity, and commercial service. Thus, when the point of designing new military or commercial aircraft is reached, a major step forward can be made at lower technical and financial risk.” Lovelace made NASA’s role even clearer: “Aeronautical research and technology development will continue to be of vital importance to the U.S. as a factor in better transportation, greater military preparedness, and sustained world leadership.”<sup>8</sup> The civilian agency would do this by doing three things: providing an improved understanding and confidence in the major technical disciplines; generating and demonstrating the technology required to alleviate current aeronautical problems and supporting anticipated next-generation systems; and establishing research foundations for advanced systems for the long-range future.

This kind of rhetoric was repeated by the next associate administrator, James J. Kramer, when he spoke before the Subcommittee on Transportation, Aviation, and



Weather of the House Committee on Science and Technology in 1977. He said that NASA agreed "completely that preeminence in aeronautics is absolutely vital to the national interest and that this point should be accepted as national policy." That preeminence depended on research and technology. Kramer also supported the view "that government activity should go beyond traditional research technology bounds and should extend to the point where results can be readily applied by industry."<sup>9</sup> The number of NASA aeronautics projects rose over the second decade to meet these noble goals.

For many years, OART/OAST associate administrators had on their staffs a deputy associate administrator for aeronautics. Charles W. Harper, who had come from Ames Research Center, was director of aeronautics from 1964 to 1967, when he first became deputy associate administrator for aeronautics. Neil A. Armstrong took that post in the 1970 reorganization. It was dropped from the books from 1972 to 1973 and reclaimed by J. Lloyd Jones in 1974. In 1975, the position was once more left off the roster and was not reinstated during the rest of the second decade. William Pomeroy and Albert J. Evans took turns serving as directors of aeronautical vehicles during 1969. In 1970 the management structure for aeronautics became much more complex. As noted above, there were three aeronautics-related divisions and a growing number of project/program offices to address special requirements (see table 5-1). NASA centers that played a major role in the aeronautics program included Ames Research Center, Flight Research Center, and Langley Research Center.

The following projects are examples of the types of activity OART/OAST was engaged in during its second decade. It is not a complete list but does include all major research and test flight projects.

**General aviation.** A General Aviation Technology Office was established within OAST in 1973 to develop the technology base for the design and development of safer, more productive, and superior U.S. general aviation aircraft.<sup>10</sup> NASA was responding to the growing importance of the general aviation segment of the U.S. civil air transportation system and the ever-increasing number of hours flown and people, cargo, and mail carried and acres of crops serviced. A Panel on General Aviation Technology was added to NASA's Research and Technology Advisory Group, technical workshop series were initiated, and joint research efforts were undertaken. By 1976, the list of general aviation interests included stall-spin research, crashworthiness, pilot operations, flight efficiency, propulsion, avionics, environmental impact, and agricultural aircraft.<sup>11</sup>

The objective of NASA's stall-spin research program was to provide design data and criteria for efficient light aircraft that will not stall or spin unintentionally. From wind tunnel and model stall-spin tests, the agency progressed to full-scale tests in 1976. Improved structural crashworthiness was another goal. NASA hoped to provide greater protection to passengers in the event of a crash through theoretical analyses and predictions of the dynamic behavior of aircraft structures under crash impact loads. An automated pilot warning and advisory system also was under development that would be of special value to general aviation pilots flying out of uncontrolled airports. Airfoils designed by the civilian agency were optimized for general aviation applications, improving the efficiency of light aircraft. NASA's work in the propulsion area was directed toward reducing the environmental impact of aircraft engines and improving fuel economy. During the late 1970s, NASA also

began to study how the agricultural community could more efficiently use the airplane to increase farm production.

**Environmental factors.** During the 1970s, NASA became committed to helping solve a number of problems associated with the negative impact that airplanes and airports have on the environment. To alleviate aircraft noise, the agency initiated a quiet engine program, demonstrated that existing engines could be refanned, and experimented with a new quiet, clean, short-haul engine. Aircraft atmospheric pollutants served as a catalyst to NASA's clean combustor program and a global air sampling effort. In addition, urban dwellers' complaints of large airport congestion and noise served to draw OAST into studies of these problems.

The quiet engine program, initiated in the late 1960s, led to demonstrations in 1972 of NASA's Quiet Engine with complete nacelle acoustic treatment to decrease the noise of the engines' fans. Noise levels were even lower than the original goals of the program; takeoff, flyover, and approach noise (effective perceived noise decibels) was reduced substantially. A Quiet Jet Propulsive-Lift Experimental Aircraft (QUESTOL) was built for NASA by Lockheed-Georgia Company in the 1970s to serve as a testbed for research on quieting jet transport aircraft. In another program, NASA modified the JT3D/JT8D jet engine to run more quietly by refanning it. The original two-stage fan was replaced with a larger single-stage fan. This engine powered a major portion of U.S. narrow-body commercial aircraft. The modified engine reduced the noise footprint by 75%. The Quiet, Clean General Aviation Turbofan (QCGAT) Program began in 1975 to ground test several general aviation turbine-powered engines. NASA also conducted research in an attempt to quiet the rotor and propeller noise of V/STOL aircraft.

NASA's programs in exhaust emission reduction included investigations to determine the effect of combustion temperature, pressure, and equivalence ratio on the generation of pollutants (smoke, hydrocarbons, carbon monoxide, and oxides of nitrogen). One specific project undertaken at the Lewis Research Center was clean jet engine combustor research. It was Lewis's goal to demonstrate that lower aircraft emissions could be reached without sacrificing either combustion efficiency or the combustor's ability to reignite in flight. Modified fuel nozzles and advanced fuel injection technology to control the combustion process were other areas under investigation. Related to these efforts was the Global Air Sampling Program (GASP). NASA began to gather measurements on the effects of pollution in the atmosphere in the mid-1970s by attaching sampling devices on airliners.

Along with the Department of Transportation, NASA was concerned with airport noise and crowding problems. In addition to its programs to reduce aircraft takeoff and approach noise pollution, the OART/OAST sponsored a number of studies of human behavioral responses to airport noise. An Aircraft Noise Reduction Laboratory was constructed at Langley Research Center.

**V/STOL aircraft.** NASA initiated a V/STOL research program in the 1960s and continued this activity during the second decade. VTOL research involved the development of advanced flexible navigation, guidance, and control avionics to improve the operational efficiency, public acceptance, safety, and reliability of these vehicles. One major goal was an automatic takeoff and landing system for helicopters. With the Department of Transportation, NASA sought to develop a data base for use by industry and government agencies in establishing system concepts, design criteria, and operational procedures for STOL aircraft. An advanced

integrated avionics and display (STOLAND) system was developed to perform navigation, guidance, and control tasks during the mid-1970s. NASA and the Canadian Department of Industry, Trade, and Commerce sponsored a joint program to test the Augmentor Wing Jet STOL Aircraft, an extensively modified C-8A military transport craft. This research program explored at low speeds the interrelationships between aerodynamics, handling qualities, and performance of the augmentor wing concept. This concept integrated aircraft engine, wing, and flap in order to increase aerodynamic lift, a concept investigated for potential use in STOL jet transports.

**Supersonic/hypersonic research.** In addition to the lifting body program discussed above, NASA conducted several other flight and wind tunnel research programs to investigate the designs and handling characteristics of aircraft at supersonic and hypersonic velocities. The popular X-15 program had come to an end in 1968, the agency having exhausted the research potential of that aircraft. NASA's part in the search for a national Supersonic Transport Aircraft also ceased as that program was cancelled in 1971. NASA and Air Force test pilots used the YF-12 research aircraft in a supersonic flight program during the early 1970s, but NASA's interest in advancing supersonic technology was restricted to making supersonic flight efficient with low noise and environmental impact. In addition to manned flights and wind tunnel tests, the agency evaluated the advantages of using remotely piloted research vehicles for flight research involving hazardous or new high-risk aircraft concepts. The Firebee II is an example of this type of aircraft, used by the Lewis Research Center in the mid-1970s in support of a future highly maneuverable aircraft (HIMAT).

**Military support programs.** Advising the military on aircraft research needs had been one of the National Advisory Committee on Aeronautics's primary jobs during the decades before NASA was established. During the 1970s, NASA expanded its support of the Department of Defense in maintaining the superiority of military aircraft. NASA and the Air Force had been working together since the late 1950s in their evaluation of the X-series of research aircraft, lifting bodies, and other high-speed experimental aircraft, but the civilian agency took a broader role in the military after the 1970 reorganization of OART.

NASA assisted the military by developing advanced technology suitable for future military systems and providing direct technical support to specific aircraft programs to enhance the success of their development. Such programs include the F-15 fighter, B-1 bomber, YF-16, YF-17, and F-18. The Highly Maneuverable Aircraft Technology program was initiated as a result of Air Force interest. From work with drones and remotely piloted research vehicles, the two agencies planned to test-fly two vehicles in 1979. With the Army, NASA worked on two helicopter projects: the Tilt Rotor Research Aircraft (XV-15) and the Rotor Systems Research Aircraft. These custom-designed vehicles were readied for flight tests in 1976 and 1977. The Rotor Systems Research Aircraft used both its rotor system and wings to develop lift; advanced rotor concepts would be tested on it. Tilt-rotor handling and control characteristics were evaluated with the other research vehicle, as well as automatic landing systems. For fighter aircraft, NASA worked on supercritical wing technology. A modified F-8 supersonic fighter was used to evaluate a new airfoil shape as part of the joint USAF-NASA Transonic Aircraft Technology (TACT) Program.

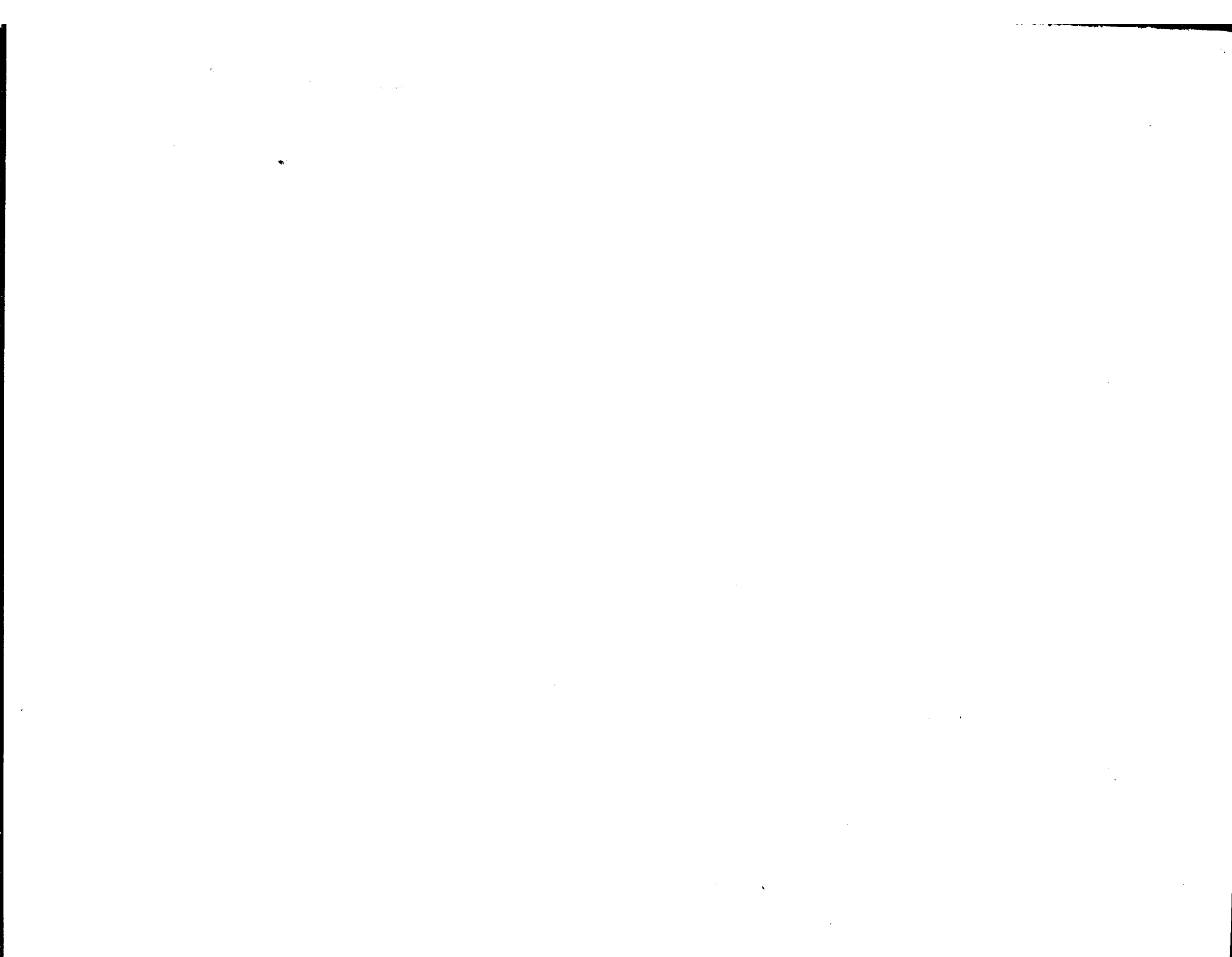



PRECEDING PAGE BLANK NOT FILMED

---

CHAPTER SIX

---

**TRACKING AND DATA  
ACQUISITION**

---

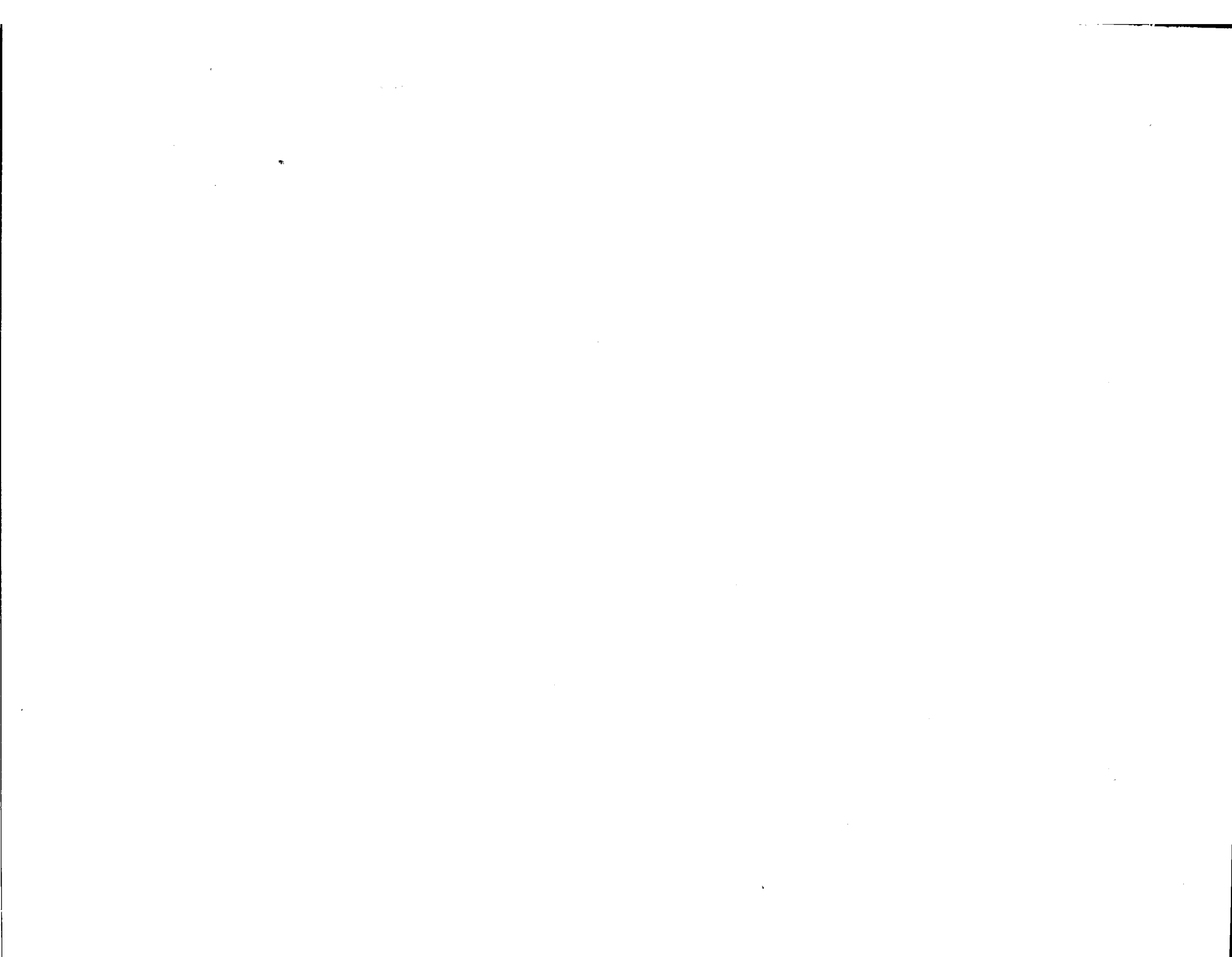

## CHAPTER SIX

# TRACKING AND DATA ACQUISITION

### INTRODUCTION

Simply defined, tracking is the process of determining the location and motion (speed and direction) of a vehicle during all phases of flight. Initial tracking observations of any flight are especially important; from these data controllers near the launch site determine if the vehicle is on the proper flight path and if it subsequently attains its prescribed flight path. During a mission, either manned or unmanned, knowing the exact location of the spacecraft at certain times is likewise critical to mission success, for antennas, scientific instruments, and cameras have to be in just the right place pointing just the right way. Tracking can be accomplished optically or by one of several radio wave techniques.<sup>1</sup>

Data acquisition is the reception at a ground station of scientific and engineering data generated by a spacecraft. The process of conveying data from spacecraft to earth via radio waves is called radio telemetry. Raw data, often stored on spacecraft recorders until it can be conveniently relayed, are coded and converted into usable information by data reduction equipment at ground stations. Information is sent to a spacecraft (uplinked) in a similar fashion. The process of sending messages to a spacecraft and receiving information from it is generally known as command and control.

#### **The First Decade Reviewed**

When NASA was established in 1958, it inherited along with several satellite and probe projects four rudimentary systems for tracking and acquiring data: the Naval Research Laboratory's Minitrack radio interferometer system built for the International Geophysical Year (1957-1958); the Jet Propulsion Laboratory (JPL) tracking scheme called Microlock developed to support the Army's Explorer project; JPL's large tracking antenna designed for the Pioneer lunar probe project; and the National Advisory Committee for Aeronautics's (NACA) X-series research aircraft tracking range. The NACA, along with its X-series partner, the U.S Air Force, had also begun to examine the tracking and data acquisition needs of the Air Force's proposed Dyna-Soar reusable earth orbital vehicle. Since the 1940s, the military had

supported missile research with tracking facilities built along several missile ranges. The Smithsonian Astrophysical Observatory was another organization that offered NASA its expertise in the tracking field. Its 12-station network was equipped with Baker-Nunn cameras capable of tracking satellites optically. From these several tracking schemes, NASA took what it needed to support its first ventures into space.

**Space Tracking and Data Acquisition Network.** The Naval Research Laboratory's Vanguard satellite project included a radio tracking network dubbed Minitrack, which used radio interferometers and Yagi antennas to obtain orbital data on satellites whose orbits did not incline more than 45 degrees.\* Originally Minitrack was composed of nine stations, several of which were strung along the 75th meridian within 45 degrees north or south of the equator. In 1959 when NASA took over management of Vanguard, Minitrack had grown to include 12 stations.\*\* But during the early 1960s, the satellite network was always changing. Stations were added to support spacecraft with orbits that took them further away from the equator; existing stations were improved; others were dropped from the net.<sup>2</sup> In 1960, the network switched to a frequency of 136-137 megahertz, a range set aside by the International Telecommunications Union for space research. The Rosman, North Carolina, station, which opened in 1963, was the first of a second generation of satellite tracking facilities that did not require an interferometer. It sported a 26-meter pointable antenna, which supported the new observatory-class satellite.

As NASA's satellites became more sophisticated, data acquisition rather than tracking became the more critical of the network's tasks, and the equipment added to the stations reflected the change. Satellite Automatic Tracking Antennas (SATAN)—one type for telemetry reception, a second for command—replaced the Yagi arrays to serve either as a complement to the large dish antennas or as the prime receiver-command antenna at stations where there were no large dishes. Since the original Minitrack system could not track spacecraft sent into highly eccentric or synchronous orbits, specialists at the Goddard Space Flight Center, which had been assigned the satellite tracking and data acquisition task, devised an alternate tracking device called Goddard Range and Range Rate Equipment (GRARR). The GRARR sent a signal to the spacecraft, which replied through a transponder. By recording the time of signal transit to and from the satellite, distance could be determined, while doppler measurement could provide range rate. By 1964, NASA officials were using the name Space Tracking and Data Acquisition Network (STADAN) for this expanded, updated satellite network.<sup>3</sup>

Improved tracking and data acquisition equipment and increased automation allowed NASA to work toward maintaining a minimum number of stations. From 22 stations in 1965, the system was reduced to 17 in 1968.<sup>+</sup> Goddard served as mis-

---

\*A radio interferometer consists of two or more radio telescopes (antennas) separated by known distances, which can pinpoint sources of radiation such as a signal in the radio range transmitted by a beacon fixed on a vehicle in space. Yagi antennas were fixed so that they could track satellites from horizon to horizon (rockinghorse antennas).

\*\* Antigua, Antofagasta, Blossom Point, Fort Stewart, Grand Turk, Havana, Johannesburg, Lima, Quito, San Diego, Santiago, and Woomera.

+ Alaska, Carnarvon, Darwin, Fort Myers, Goddard NTTF, Johannesburg, Kauai, Lima, Mojave, Orroral Valley, Quito, Rosman, Santiago, St. John's, Tananarive, Toowoomba, and Winkfield.



sion control for the satellites that STADAN supported. The center was also the site of the Network Test and Training Facility (NTTF), where new equipment bound for tracking stations was tested and new personnel were trained.

**Manned Spaceflight Network.** During the late 1940s, NACA's Pilotless Aircraft Research Station at Wallops Island, Virginia, was tracking experimental aircraft and rockets with radar. Additionally, the military had established missile ranges in the deserts of New Mexico and across the south Atlantic from Florida to the island of Barbados with radar and telemetry equipment at several locations. Equipment borne by aircraft and ships augmented the island-station system. In the 1950s, NACA and the Department of Defense established a joint high-speed research aircraft program that called for sophisticated tracking and communications gear, and in the opinion of many, the logical extension of this program was manned orbital flight. Accordingly, tracking specialists began to define the global tracking network such a mission would require.

The possibility of manned spaceflight was one of several programs that the new space agency began to address in 1958. Working first at the Langley Research Center in Virginia, formerly a NACA laboratory, and later at the Manned Spacecraft Center in Houston, the Space Task Group had a huge task ahead of it, of which tracking was only one of several critical parts. The Space Task Group's mission planners established the base requirements for manned flight tracking operations.\* Mercury, the first step in NASA's manned program, demanded continuous coverage by all systems from launch to orbital insertion and again during reentry, two-way voice communications, telemetry trajectory measurements, and uplinked commands, and it made these demands around the globe.

Mercury tracking stations would be equipped with proven C-band (RCA FPS-16) and S-band (Reeves Instrument Corp. Verlor) radar units. Active acquisition aids would assist the narrow-band radars in locating the orbiting spacecraft, and transponders would ensure a strong return signal. UHF (ultrahigh frequency) radio was specified for the primary communications link between the spacecraft and ground stations, with an HF (high frequency) backup and a second set of UHF equipment available at each ground station. Communications on the ground (telemetry, commands, radar acquisition data, tracking data, voice messages, teletype) were to be real-time. A global network of 17 tracking stations was called for, some of which were already in existence as part of military ranges. New sites would connect the Pacific Missile Range with the Atlantic Missile Range, continue the net across Africa, the Indian Ocean, Australia, and the Pacific.\*\* The Manned Spaceflight Network (MSFN) was operating by July 1961.

Like the satellite system, the Manned Spaceflight Network changed to meet new

---

\*In 1959, the tracking group was established as the Tracking and Ground Instrumentation Unit (TAGIU), an organizational entity at Langley separate from the Space Task Group. In 1961, many TAGIU personnel were transferred to the Goddard Space Flight Center.

\*\*NASA contractors began constructing new stations in 1959 at Bermuda; Canton Island; Corpus Christi, Texas; Grand Canary Island; Guayman, Mexico; Kano, Nigeria; Kauai, Hawaii; Muchea and Woomera, Australia; and Zanzibar. NASA-owned equipment was sent to Cape Canaveral, Grand Bahama Island, Grand Turk Island, Eglin Air Force Base, Point Arguello, and the White Sands Missile Range. DoD contributed additional ground support and two tracking ships.

mission profiles. For missions longer than the first Mercury flights, the network needed beefing up, especially in the Pacific. Additional instrumented ships assisted the network with both voice and telemetry operations, and DoD provided supplementary coverage from its ground stations. In addition, DoD aircraft with voice relay and radar equipment assisted the net during reentry and landing.

The Manned Spaceflight Network had to expand its operations even more during Project Gemini, which called for longer flights with two-man crews and rendezvous operations in earth orbit with two spacecraft. A move toward increased computerization and decreased voice support made possible a more centralized network with fewer primary stations and more secondary stations for Gemini, although those major facilities had to be better equipped. Some Mercury stations were dropped; many were supplemented with new hardware. All was ready in 1965 for the first manned Gemini flight.

Apollo, NASA's manned lunar exploration program, would include operations near earth, in cislunar space, in lunar orbit, and on the moon's surface, most of which was beyond the Manned Spaceflight Network's grasp as it was configured for Gemini. But NASA began to consult with deep space tracking experts regarding Apollo's requirements as early as 1961. The Jet Propulsion Laboratory in Pasadena, California had been in the tracking and data acquisition business since the early 1950s and had begun construction of its first 26-meter-diameter dish antenna for tracking lunar probes before NASA was established. The Mercury-Gemini stations could be adopted for Apollo's near-Earth operations, and JPL's 26-meter antennas or ones like them could reach out to Apollo spacecraft on the Moon. However, since there was some doubt as to whether or not there were enough conventional MSFN stations and because Apollo spacecraft would be sending back more telemetry than existing stations could receive, NASA updated the equipment at its stations and augmented the ground communications system to ready the network for lunar missions.

For Apollo, NASA introduced a unified (and higher—1550–5200 megacycles) frequency band, the S-band (USB), for communications. Existing Gemini stations were equipped with 9-meter USB antennas, and three 26-meter USB stations were constructed roughly 120 degrees apart around the globe, located near Deep Space Network antennas at Goldstone in California; near Canberra, Australia, and near Madrid, Spain. USB instrumentation and C-band radar were installed on five tracking ships and VHF/UHF and USB equipment was put on eight aircraft. As it had for Mercury and Gemini, DoD augmented the network with its stations, especially in the south Atlantic. For the first round of Apollo flights, the network was a large one, with 14 primary stations (11 of which were equipped with 9-meter USB antennas), 5 ships, 5 aircraft, 4 secondary stations, and 9 DoD support stations.\* In December 1968, *Apollo 8's* crew orbited the moon, generating scientific and engineering telemetry, photographic images, and voice communications, all of which were received in good order on earth.<sup>4</sup>

**Deep Space Network.** U.S. government officials became officially concerned with how to track an object beyond earth orbit in early 1958 when the Advanced

---

\*The primary stations included Antigua, Ascension Island, Bermuda, Grand Bahama, Merritt Island, Grand Canary, Madrid, Carnarvon, Canberra, Guam, Kauai, Goldstone, Guaymas, and Corpus Christi.

Research Projects Agency approved the Pioneer lunar probe series. The Jet Propulsion Laboratory's tracking-communications team was able to suggest two possible schemes for tracking spacecraft that would be operating at such distances from earth: a single station in the U.S. equipped with a large parabolic dish antenna, which would be in contact with the spacecraft during a single period daily when it was in view; or a similarly equipped three-station network located roughly 120 degrees apart in longitude, which would provide continuous support. Obviously, the three-station plan was preferable, but there was not enough time to implement it. JPL erected a 26-meter-diameter antenna (Pioneer Station) in southern California's Mojave Desert to support the early Pioneer missions, a series of unsuccessful probes.

JPL's tracking team spent the next several years building and improving the three components of their deep space tracking system: a mission control center at JPL; a communications system that linked the tracking stations with mission control and operated as part of the broader NASA Communications System; and the network of stations. In addition to Goldstone, where a second 6-meter antenna was built, Deep Space Network (DSN) stations were put into operation in Spain (Robledo and Cerebros near Madrid), Woomera and Tidbinbilla, Australia, and South Africa. A 64-meter antenna was under construction as early as 1963. JPL's Space Flight Operations Facility was the functional center of the network.\*<sup>5</sup>

### **Managing the Tracking and Data Acquisition Program**

Overall management authority for the Office of Tracking and Data Acquisition (OTDA) at NASA Headquarters was assumed by Gerald M. Truszynski for most of the agency's second decade. Truszynski joined the National Advisory Committee for Aeronautics (NACA), NASA's predecessor organization, as an instrumentation specialist, first at the Langley Memorial Aeronautical Laboratory and later at the Edwards Air Force Base-NACA High-Speed Flight Station complex, where he helped develop the X-series aircraft tracking range. In 1960, he came to NASA Headquarters as a staff member of OTDA, becoming Associate Administrator for Tracking and Data Acquisition in 1968. Reporting to Truszynski and his deputy, H. R. Brockett, 1969-1974, and Norman Pozinsky, 1975-1978, were directors for program coordination and management resources (Thomas V. Lucas, 1969-1974, and Richard L. Stock, 1975-1978), network operations and communications (Charles A. Taylor), and network support and systems development (Pozinsky, 1969-1975, and Frederick B. Bryant, 1976-1978). Chiefs for network operations (James C. Bavely), communications and frequency management (Paul A. Price, 1969-1973, Elbert L. Eaton, 1974-1977, and Harold G. Kimball, 1978), and data processing (Kenneth Webster) further fleshed out the management framework. In 1978, William Schneider took over for the retiring Truszynski. Schneider had been Deputy Associate Administrator for Space Transportation Systems since 1974. (See table 6-1 for details on how the management of the tracking and data acquisition program changed at NASA Headquarters during the decade.)

---

\* For more information on the first 10 years of NASA's tracking and data acquisition program and the three networks see Linda N. Ezell, *NASA Historical Data Book, 1958-1968*, vol. 2, *Programs and Projects*, NASA SP-4012(02) (Washington, 1987), chap. 5.

The two centers most directly involved with tracking and data acquisition were the Goddard Space Flight Center in Maryland and the Jet Propulsion Laboratory (JPL) in California. Goddard's activities were managed by two directorates: networks and mission and data operations. Of interest to Goddard managers and engineers were network engineering, facilities and services, computing and analysis, operations, and procedures and evaluation, communications, the Tracking and Data Relay Satellite System, information processing, and advanced data systems. The Space Tracking and Data Acquisition Network and the NASA Communications System were managed at Goddard. Overseeing tracking operations in deep space was assigned to the Jet Propulsion Laboratory, where an assistant laboratory director supervised the Office of Tracking and Data Acquisition. Managers for tracking and data acquisition programs, planning, technology development, mission support, program control, operations, and facilities kept the Deep Space Network operating to support interplanetary missions.

Table 6-1. Two Phases of Tracking and Data Acquisition Management, NASA Headquarters, 1969-1978

---

Phase I 1969-1977
Administrator/Deputy Administrator
Associate Administrator, Office of Tracking and Data Acquisition (Gerald M. Truszynski)
Deputy Associate Administrator, OTDA (H. R. Brockett; Norman Pozinsky, Sept. 1975)
Director, Systems Planning and Development (Truszynski, acting, 1969; dropped 1969)
Director, Program Coordinator and Resources Management (Thomas V. Lucas; Richard L. Stock, 1975)
Director, Operations, Communications, and Automated Data Processing (Charles A. Taylor)
Chief, Network Operations (James C. Bavely)
Chief, Communications and Frequency Management (Paul A. Price; Elbert L. Eaton, 1974)
Chief, ADP Management (Kenneth Webster; dropped 1974)
Director, DoD Coordination (Frederick B. Bryant; dropped 1969)
Director, Network Support Implementation/Development and Engineering/System Development Programs (Pozinsky; Bryant, 1976)
Director, Advanced Systems (Bryant; added 1970)
Phase II 1978
Administrator/Deputy Administrator
Associate Administrator, Office of Space Tracking and Data Systems (William Schneider)
Deputy Associate Administrator (Pozinsky)
Director, Program Review and Resource Management (Stock)
Director, Network Operations and Communications Programs (Taylor)
Chief, Network Operations (Bavely)
Chief, Communications and Frequency Management (Harold G. Kimball)
Director, Network Systems Development Programs (Bryant)
Director, Tracking and Data Satellite System (Schneider, acting)

---

## BUDGET

### Money for Tracking and Data Acquisition

The Office of Tracking and Data Acquisition's budget was divided three ways: network operations, equipment or systems implementation, and supporting research and technology or advanced systems. Network operations and equipment/systems implementation monies were divided among the Manned Spaceflight Network (through FY 1970), the Space Tracking and Data Acquisition Network, the Deep Space Network, aeronautics and sounding rocket support, communications, and data processing. When the MSFN was disbanded, the cost of maintaining the former manned tracking stations that would now support unmanned missions as well was assigned to the STADAN. Supporting research and technology was renamed the Advanced Systems Program in FY 1971. While most of OTDA's research tasks were carried over in the new program, some of the budget categories were reorganized, dropped, or renamed. For a more detailed breakdown of the tracking and data acquisition budget than is provided in the following tables, consult the NASA annual budget estimates. Consult table 6-3 for a budget summary of the three major program areas and table 6-4 for a summary of the money programmed for the individual networks.

As will be discussed elsewhere in this chapter, NASA made plans during the 1970s to lease rather than buy a Tracking and Data Relay Satellite System, which would simplify tracking operations during the 1980s. The agency funded advanced design studies for the system under a supporting research and technology/advanced systems budget category (table 6-21, New Systems/Spacecraft-to-Ground Communications, Telemetry, and Command). Only in FY 1975 were funds programmed for TDRSS as a distinct program (table 6-28).

Review the bottom notes of the following tables carefully before making conclusions about totals for any single year or for any particular aspect of a program. It would also be useful to review the introduction to the budget section of chapter 1 for general information on NASA's budget and on the sources and format used for the budget tables in this book.

Table 6-2. Total Tracking Data and Acquisition Funding History  
(in thousands of dollars)

Year	Request	Authorization	Programmed
1969	304 800	289 800	279 672
1970	298 000	278 000	278 000
1971	298 000	295 200	289 943
1972	264 000	264 000	264 000
1973	259 100	259 100	248 331
1974	250 000	244 000	244 000
1975	250 000	250 000	248 000
1976	309 400 <sup>a</sup>	240 800 <sup>b</sup>	240 800
1977	258 000	255 000	255 000
1978	281 700	280 200	278 300

<sup>a</sup>Includes \$66 400 000 for the transition quarter.

<sup>b</sup>Does not include funds for the transition quarter.

Table 6-3. Programmed Cost by Tracking and Data Acquisition Program Areas  
(in thousands of dollars)

	1969	1970	1971	1972	1973	1974	1975	1976	1977	1978
Network Operations										
Manned Spaceflight Network <sup>a</sup>	83 493	78 904	---	---	---	---	---	---	---	---
Space Tracking and Data Acquisition Network <sup>a</sup>	43 520	44 450	115 086	111 472	104 801	99 525	102 400	98 189	105 326	120 170
Deep Space Network	32 231	34 863	37 949	38 798	11 100	32 975	37 489	40 309	41 500	46 570
Aeronautics and Sounding Rocket Support	5627	5275	5598	5343	3330	4300	4197	3865	4334	4982
Communications	48 480	45 140	37 111	30 768	2400	32 500	26 038	26 535	26 584	27 931
Data Processing	16 003	16 549	15 936	15 419	7330	22 600	22 476	23 638	25 856	28 931
Equipment/Systems Implementation										
Manned Spaceflight Network <sup>a</sup>	9223	11 422	---	---	---	---	---	---	---	---
Space Tracking and Data Acquisition Network <sup>a</sup>	8676	9598	35 605	29 152	20 970	19 400	20 313	19 150	19 000	18 632
Deep Space Network	14 291	13 168	20 628	13 335	11 100	13 283	13 351	10 886	13 940	11 640
Aeronautics and Sounding Rocket Support	3439	3937	3769	4536	3330	3007	2700	2523	2846	3095
Communications	1742	1816	3648	2434	2400	2274	3160	3284	4014	3433
Data Processing	1791	1168	1713	1243	3900	4936	2976	3200	2900	3600
Supporting Research and Technology/Advanced Systems	11 156	11 710	12 900	11 500	8500	9200	9300	9221	8700	9316

<sup>a</sup>The MSFN and STADAN were combined into one network in 1973.

Table 6-4. Programmed Costs by Network/System  
(in thousands of dollars)

	1969	1970	1971	1972	1973	1974	1975	1976	1977	1978	Total
<b>Manned Spaceflight Network<sup>a</sup></b>											
Operations	83 493	78 904	---	---	---	---	---	---	---	---	162 397
Equipment/Systems Implementation	9223	11 422	---	---	---	---	---	---	---	---	20 645
Total	92 716	90 326	---	---	---	---	---	---	---	---	183 042
<b>Space Tracking and Data Acquisition Network<sup>a</sup></b>											
Operations	43 520	44 450	115 086	111 472	104 801	99 525	102 400	98 189	41 500	46 570	807 513
Equipment/Systems Implementation	8676	9598	35 605	29 152	20 970	19 400	20 313	19 150	19 000	18 632	200 496
Total	52 196	54 048	150 691	140 624	125 771	118 925	122 713	117 339	60 500	65 202	1 008 009
<b>Aeronautics/Sounding Rocket Support</b>											
Operations	5627	5275	5598	5343	3330	4300	4197	3865	4334	4982	46 851
Equipment/Systems Implementation	3439	3937	3769	4536	3330	3007	2700	2523	2846	3095	33 182
Total	9066	9212	9367	9879	6660	7307	6897	6388	7180	8077	80 033
<b>Communications</b>											
Operations	48 480	45 140	37 111	30 768	2400	32 500	26 038	26 535	26 584	27 931	303 487
Equipment/Systems Implementation	1742	1816	3648	2434	2400	2400	2274	3160	4014	3433	27 321
Total	50 222	46 956	40 759	33 202	4800	34 900	28 312	29 695	30 598	31 364	330 808
<b>Data Processing</b>											
Operations	16 003	16 549	15 936	15 419	7330	22 600	22 476	23 638	19 000	18 632	177 583
Equipment/Systems Implementation	1791	1168	1713	1243	3900	4936	2976	3200	2900	3600	27 427
Total	17 794	17 717	17 649	16 662	11 230	27 536	25 452	26 838	21 900	22 232	205 010

<sup>a</sup>The MSFN and STADAN were combined into one network in 1973.

Table 6-5. Tracking and Data Acquisition Operations Funding History  
(in thousands of dollars)

Year	Request	Authorization	Programmed
1969	239 800	239 800	229 354
1970	239 400	231 400	225 181
1971	229 600	229 600	211 680
1972	210 000	210 000	201 800
1973	203 600	203 600	194 701
1974	198 200	192 200	191 900
1975	192 800	192 800	192 600
1976	243 600 <sup>a</sup>	191 400 <sup>b</sup>	192 536
1977	206 800	--- <sup>c</sup>	203 600
1978	229 900	--- <sup>d</sup>	228 584

<sup>a</sup>Includes \$51 200 000 for the transition quarter.

<sup>b</sup>Does not include funds for the transition quarter.

<sup>c</sup>Total TD&A reduction of \$3 000 000 was to be distributed among the various programs with no specific directions from the conference committee.

<sup>d</sup>Total TD&A reduction of \$1 500 000 was to be distributed among the various programs with no specific directions from the conference committee.

Table 6-6. Tracking and Data Acquisition Operations—  
Manned Spaceflight Network Funding History  
(in thousands of dollars)\*

Year	Request	Programmed
1969	91 500	83 493
1970	89 200	78 904
1971	79 200	--- <sup>a</sup>
1972	67 100	---

\*The MSFN was combined with the Space Tracking and Data Acquisition Network in the FY 1973 budget request.

<sup>a</sup>The amount programmed was estimated at \$69 100 000 in the FY 1972 budget estimate.

Table 6-7. Tracking and Data Acquisition Operations—Space Tracking and  
Data Acquisition Network Funding History  
(in thousands of dollars)\*

Year	Request	Programmed
1969	42 000	43 520
1970	44 500	44 450
1971	44 000	115 086 <sup>a</sup>
1972	43 500	111 472
1973	105 800	104 801
1974	108 200	99 525
1975	98 200	102 400
1976	123 000 <sup>b</sup>	98 189
1977	108 800	105 326
1978	122 300	120 170

\*The STADAN and the Manned Spaceflight Network were combined in the FY 1973 budget estimate.

<sup>a</sup>The amount programmed for STADAN only was estimated at \$45 700 000 in the FY 1972 budget estimate.

<sup>b</sup>Includes \$26 000 000 for the transition quarter.



Table 6-8. Tracking and Data Acquisition Operations—Deep Space Network  
Funding History  
(in thousands of dollars)

Year	Request	Programmed
1969	37 000	32 231
1970	36 900	34 863
1971	39 800	37 949
1972	38 000	38 798
1973	38 000	11 100
1974	33 700	32 975
1975	12 000	37 489
1976	48 600 <sup>a</sup>	40 309
1977	43 000	41 500
1978	46 800	46 570

<sup>a</sup>Includes \$10 200 000 for the transition quarter.

Table 6-9. Tracking and Data Acquisition Operations—Aeronautics and  
Sounding Rocket Support Funding History  
(in thousands of dollars)

Year	Request	Programmed
1969	6700	5627
1970	6300	5275
1971	5300	5598
1972	5100	5343
1973	4500	3330
1974	5300	4300
1975	3300	4197
1976	5200 <sup>a</sup>	3865
1977	4200	4334
1978	4600	4982

<sup>a</sup>Includes \$1 100 000 for the transition quarter.

Table 6-10. Tracking and Data Acquisition—Communications Funding History  
(in thousands of dollars)

Year	Request	Programmed
1969	48 600	48 480
1970	46 500	45 140
1971	42 800	37 111
1972	37 200	30 768
1973	34 100	2400
1974	33 000	32 500
1975	3200	26 038
1976	34 900 <sup>a</sup>	26 535
1977	26 000	26 584
1978	28 300	27 931

<sup>a</sup>Includes \$7 000 000 for the transition quarter.

Table 6-11. Tracking and Data Acquisition Operations—Data Processing Funding History  
(in thousands of dollars)

Year	Request	Programmed
1969	14 000	16 003
1970	16 000	16 549
1971	18 500	15 936
1972	19 100	15 419
1973	21 200	7330
1974	18 000	22 600
1975	3900	22 476
1976	31 900 <sup>a</sup>	23 638
1977	24 800	25 856
1978	27 900	28 931

<sup>a</sup>Includes \$6 900 000 for the transition quarter.

Table 6-12. Tracking and Data Acquisition Equipment/Systems  
Implementation Funding History  
(in thousands of dollars)

Year	Request	Authorization	Programmed
1969	52 200	37 200	39 162
1970	46 100	34 100	41 109
1971	55 500	52 700	65 363
1972	42 500	42 500	50 700
1973	44 000	44 000	45 130
1974	42 700	42 700	42 900
1975	48 000	48 000	42 500
1976	54 300 <sup>a</sup>	41 400 <sup>b</sup>	39 043
1977	42 500	--- <sup>c</sup>	42 700
1978	42 500	--- <sup>d</sup>	40 400

<sup>a</sup>Includes \$12 900 000 for the transition quarter.

<sup>b</sup>Does not include funds for the transition quarter.

<sup>c</sup>Total TD&A reduction of \$3 000 000 was to be distributed among the various programs with no specific directions from the conference committee.

<sup>d</sup>Total TD&A reduction of \$1 500 000 was to be distributed among the various programs with no specific directions from the conference committee.

Table 6-13. Tracking and Data Acquisition Equipment/Systems Implementation—  
Manned Spaceflight Network Funding History  
(in thousands of dollars)\*

Year	Request	Programmed
1969	17 500	9223
1970	13 300	11 422
1971	9800	--- <sup>a</sup>
1972	9100	---

\*The MSFN was combined with the Space Tracking and Data Acquisition Network in the FY 1973 budget estimate.

<sup>a</sup>The amount programmed was estimated at \$12 700 000 in the FY 1972 budget estimate.

Table 6-14. Tracking and Data Acquisition Equipment/Systems Implementation—  
Space Tracking and Data Acquisition Network Funding History  
(in thousands of dollars)\*

Year	Request	Programmed
1969	12 800	8676
1970	13 000	9598
1971	16 400	35 605 <sup>a</sup>
1972	13 900	29 152
1973	19 900	20 970
1974	19 900	19 400
1975	25 600	20 313
1976	22 500 <sup>b</sup>	19 150
1977	19 000	19 000
1978	20 000	18 632

\*The STADAN and the Manned Spaceflight Network were combined in the FY 1973 budget estimate.

<sup>a</sup>The amount programmed for STADAN only was estimated at \$18 100 000 in the FY 1972 budget estimate.

<sup>b</sup>Includes \$5 100 000 for the transition quarter.

Table 6-15. Tracking and Data Acquisition Equipment/Systems Implementation—  
Deep Space Network Funding History  
(in thousands of dollars)

Year	Request	Programmed
1969	12 000	14 291
1970	12 500	13 168
1971	21 700	20 628
1972	13 000	13 335
1973	12 200	11 100
1974	12 500	13 283
1975	12 000	13 351
1976	19 700 <sup>a</sup>	10 886
1977	14 000	13 940
1978	12 700	11 640

<sup>a</sup>Includes \$5 400 000 for the transition quarter.

Table 6-16. Tracking and Data Acquisition Equipment/Systems Implementation—  
Aeronautics and Sounding Rocket Funding History  
(in thousands of dollars)

Year	Request	Programmed
1969	4300	3439
1970	3600	3937
1971	3100	3769
1972	3300	4536
1973	3100	3330
1974	3200	3007
1975	3300	2700
1976	3400 <sup>a</sup>	2523
1977	2600	2846
1978	3000	3095

<sup>a</sup>Includes \$700 000 for the transition quarter.

Table 6-17. Tracking and Data Acquisition Equipment/Systems Implementation – Communications Funding History (in thousands of dollars)

Year	Request	Programmed
1969	3000	1742
1970	2200	1816
1971	2800	3648
1972	2200	2434
1973	2800	2400
1974	2300	2274
1975	3200	3160
1976	3800 <sup>a</sup>	3284
1977	3900	4014
1978	3500	3433

<sup>a</sup>Includes \$800 000 for the transition quarter.

Table 6-18. Tracking and Data Acquisition Equipment/Systems Implementation – Data Processing Funding History (in thousands of dollars)

Year	Request	Programmed
1969	2600	1791
1970	1500	1168
1971	1700	1713
1972	1000	1243
1973	6000	3900
1974	4800	4936
1975	7330	2976
1976	4900 <sup>a</sup>	3200
1977	3000	2900
1978	3300	3600

<sup>a</sup>Includes \$900 000 for the transition quarter.

Table 6-19. Tracking and Data Acquisition Supporting Research and Technology/Advanced Systems Funding History (in thousands of dollars)

Year	Request	Authorization	Programmed
1969	12 800	12 800	11 156
1970	12 500	12 500	11 710
1971	12 900	12 900	12 900
1972	11 500	11 500	11 500
1973	11 500	11 500	8500
1974	9100	9100	9200
1975	9200	9200	9300
1976	11 500 <sup>a</sup>	8000 <sup>b</sup>	9221
1977	8700	---- <sup>c</sup>	8700
1978	9300	---- <sup>d</sup>	9316

<sup>a</sup>Includes \$2 300 000 for the transition quarter.

<sup>b</sup>Does not include funds for the transition quarter.

<sup>c</sup>Total TD&A reduction of \$3 000 000 was to be distributed among the various programs with no specific directions from the conference committee.

<sup>d</sup>Total TD&A reduction of \$1 500 000 was to be distributed among the various programs with no specific directions from the conference committee.

Table 6-20. Tracking and Data Acquisition Supporting Research and Technology/  
Advanced Systems—Receiving and Transmitting Subsystems/Tracking,  
Orbit Determination and Ground-Based Navigation Funding History  
(in thousands of dollars)

Year	Request	Programmed
1969	2250	2457
1970	2510	2663
1971	2200	3131 <sup>a</sup>
1972	2080	3063
1973	2770	2430
1974	2400	--- <sup>b</sup>
1975	2140	---

<sup>a</sup>The amount programmed for receiving and transmitting subsystems only was estimated at \$2 220 000 in the FY 1972 budget estimate.

<sup>b</sup>The amount programmed for tracking, orbit determination, and ground-based navigation was estimated at \$2 490 000 in the FY 1975 budget estimate; the advanced systems category was not broken down by individual projects in the FY 1976 through FY 1980 budget estimates.

Table 6-21. Tracking and Data Acquisition Supporting Research and Technology/  
Advanced Systems—New Systems/Spacecraft-to-Ground Communications,  
Telemetry, and Command Funding History  
(in thousands of dollars)\*

Year	Request	Programmed
1969	1350	387
1970	1370	890
1971	1700	5401 <sup>a</sup>
1972	1400	4583
1973	4370	2860
1974	3000	--- <sup>b</sup>
1975	3190	---

\*Includes the Tracking and Data Relay Satellite System (TDRSS).

<sup>a</sup>The amount programmed for new systems only was estimated at \$1 730 000 in the FY 1972 budget estimate.

<sup>b</sup>The amount programmed for spacecraft-to-ground communications, telemetry, and command was estimated at \$3 360 000 in the FY 1975 budget estimate; the advanced systems category was not broken down by individual projects in the FY 1976 through FY 1980 budget estimates.

Table 6-22. Tracking and Data Acquisition Supporting Research and Technology/  
Advanced Systems—Network Performance and Operations Funding History  
(in thousands of dollars)

Year	Request	Programmed
1969	---	732
1970	630	333
1971	590	2969
1972	700	2269
1973	2450	1720
1974	1750	--- <sup>a</sup>
1975	1840	---

<sup>a</sup>The amount programmed for network operations and control technology was estimated at \$1 590 000 in the FY 1975 budget estimate; the advanced systems category was not broken down by individual projects in the FY 1976 through FY 1980 budget estimates.

Table 6-23. Tracking and Data Acquisition Supporting Research and Technology/  
Advanced Systems—Data Handling and Processing Funding History  
(in thousands of dollars)

Year	Request	Programmed
1969	1580	1619
1970	1970	1540
1971	1410	1399
1972	1340	1585
1973	1910	1490
1974	1950	--- <sup>a</sup>
1975	2030	---

<sup>a</sup>The amount programmed for data handling and processing was estimated at \$1 760 000 in the FY 1975 budget estimate; the advanced systems category was not broken down by individual projects in the FY 1976 through FY 1980 budget estimates.

Table 6-24. Tracking and Data Acquisition Supporting Research and Technology—  
Integrated Systems Analysis, Development, and Test Funding History  
(in thousands of dollars)

Year	Request	Programmed
1969	3320	2367
1970	2540	3241
1971	3280	--- <sup>a</sup>
1972	3060	---

<sup>a</sup>The amount programmed was estimated at \$3 560 000 in the FY 1972 budget estimate; this budget category was dropped when the supporting research and technology program was renamed the advanced systems program.

Table 6-25. Tracking and Data Acquisition Supporting Research and Technology—  
Antenna Subsystems Funding History  
(in thousands of dollars)

Year	Request	Programmed
1969	1080	1420
1970	1340	1362
1971	1260	--- <sup>a</sup>
1972	1100	---

<sup>a</sup>The amount programmed was estimated at \$1 260 000 in the FY 1975 budget estimate; this budget category was dropped when the supporting research and technology program was renamed the advanced systems program.

Table 6-26. Tracking and Data Acquisition Supporting Research and Technology—  
Spacecraft Subsystems Funding History  
(in thousands of dollars)

Year	Request	Programmed
1969	1130	1173
1970	900	880
1971	1260	--- <sup>a</sup>
1972	950	---

<sup>a</sup>The amount programmed was estimated at \$1 050 000 in the FY 1972 budget estimate; this budget category was dropped when the supporting research and technology program was renamed the advanced systems program.

Table 6-27. Tracking and Data Acquisition Supporting Research and Technology—  
Data Processing and Reduction Funding History  
(in thousands of dollars)

Year	Request	Programmed
1969	2090	1001
1970	1150	801
1971	1200	---- <sup>a</sup>
1972	870	---

<sup>a</sup>The amount programmed was estimated at \$940 000 in the FY 1972 budget estimate; this budget category was combined with data handling and processing in the FY 1973 budget estimate.

Table 6-28. Tracking and Data Acquisition Tracking and Data Relay Satellite System  
Funding History  
(in thousands of dollars)

Year	Request	Programmed
1975	---	3600

\*Also see table 6-21.

## NETWORK CHARACTERISTICS

### Manned Spaceflight Network, 1969-1972

As discussed above, the Manned Spaceflight Network (MSFN) was expanded significantly and its equipment updated to support lunar exploration missions. In 1969, the network consisted of 10 stations with 9-meter antennas, 3 stations with 26-meter antennas, 1 transportable 9-meter antenna located at Grand Bahama Island, 5 instrumented ships, and 8 aircraft. Additional support could be counted on from the 3 Deep Space Network 26-meter antennas, the STADAN station at Tananarive, and DoD facilities at Point Arguello, the Eastern Test Range, and the White Sands Missile Range.

*Apollo 11*, the first manned lunar landing, took place in July 1969, and the MSFN provided its support as planned. The 9-meter united S-band antennas were used during near-earth operations, with the 26-meter USB antennas taking over for cislunar and lunar activities. After the successful completion of the first landing, the Apollo mission schedule was revised to reflect a renewed concern by Congress over NASA's budget. Significant changes in the network configuration were also possible for the next flight: only one tracking ship and four aircraft were required, and fewer ground stations were put on line. This smaller network adequately supplied *Apollo 12* (1970) with tracking and data acquisition services and served the crew of *Apollo 13* when an onboard system failure forced them to make an emergency return trip home. *Apollo 14* and *15* were conducted in 1971, with the latter mission giving the trackers an additional piece of apparatus to watch: the Lunar Roving Vehicle. A new Lunar Communications Relay Unit served as a portable relay station between

the astronauts and the network stations, freeing the astronauts from relying exclusively on the lunar module as their only communications link.

During 1972, the MSFN and the STADAN networks were consolidated as one Spaceflight Tracking and Data Network (STDN). With the increasing trends toward high-data-rate satellites and real-time control requirements for unmanned spacecraft, the small number of manned flights planned for the post-Apollo years, and the always urgent requirement to avoid duplication and unnecessary costs, the agency could not justify operating two distinct nets. Eleven MSFN stations continued to provide for the tracking and data acquisition needs of Apollo and Skylab missions on a priority basis but also began to work with unmanned satellites. The 11 stations transferred to the spaceflight network were located at Cape Kennedy, Bermuda, Ascension Island, Grand Canary Island, Carnarvon, Guam, Kauai, Corpus Christi, Madrid, Canberra, and Goldstone. Additionally, the net retained four instrumented aircraft and one tracking ship. The transportable antenna was moved from Grand Bahama to St. John's, Newfoundland, to provide Skylab launch support.

To test the tracking network as configured for Apollo and to train the ground personnel, NASA launched two Test and Training (TETR) satellites in 1967 and 1968. Also called TTS, *TETR 1* and *2* provided targets for checkout and training of equipment and operations personnel. They were launched as secondary payloads with *Pioneer 8* and *Pioneer 9*, respectively. NASA attempted to launch an additional TETR satellite on August 27, 1969, with Pioneer E. These two satellites failed to orbit because the launch vehicle was destroyed by the range safety officer when it began behaving erratically eight minutes after launch. Another launch on September 29, 1971, with the satellite *Orbiting Solar Observatory 7*, was successful. The 18-kilogram tracking target *TETR 3*, was used by the Apollo network personnel to test the net as modified late in the Apollo program.

Table 6-29. NASA Manned Spaceflight Network Stations, 1969-1972

Station	9-m Antenna	26-m Antenna	Launch/ Recovery Support Only	Colated with DSN 26-m Antenna	Years in Service (including STDN use)
Antigua	X				1967-70
Ascension Island	X				1967-
Bermuda	X				1961-
Canberra		X			1967-
Cape Kennedy	X				1961-
Carnarvon	X			X	1964-74
Corpus Christi	X				1961-74
Goldstone/Apollo Station	X	X		X	1967-
Grand Bahama	X				1967-70
Grand Canary	X				1961-75
Guam	X				1966-
Guaymas	X				1961-70
Kauai	X				1961-
Madrid		X		X	1967-
Merritt Island			X		1973-
Tananarive			X		1965-75





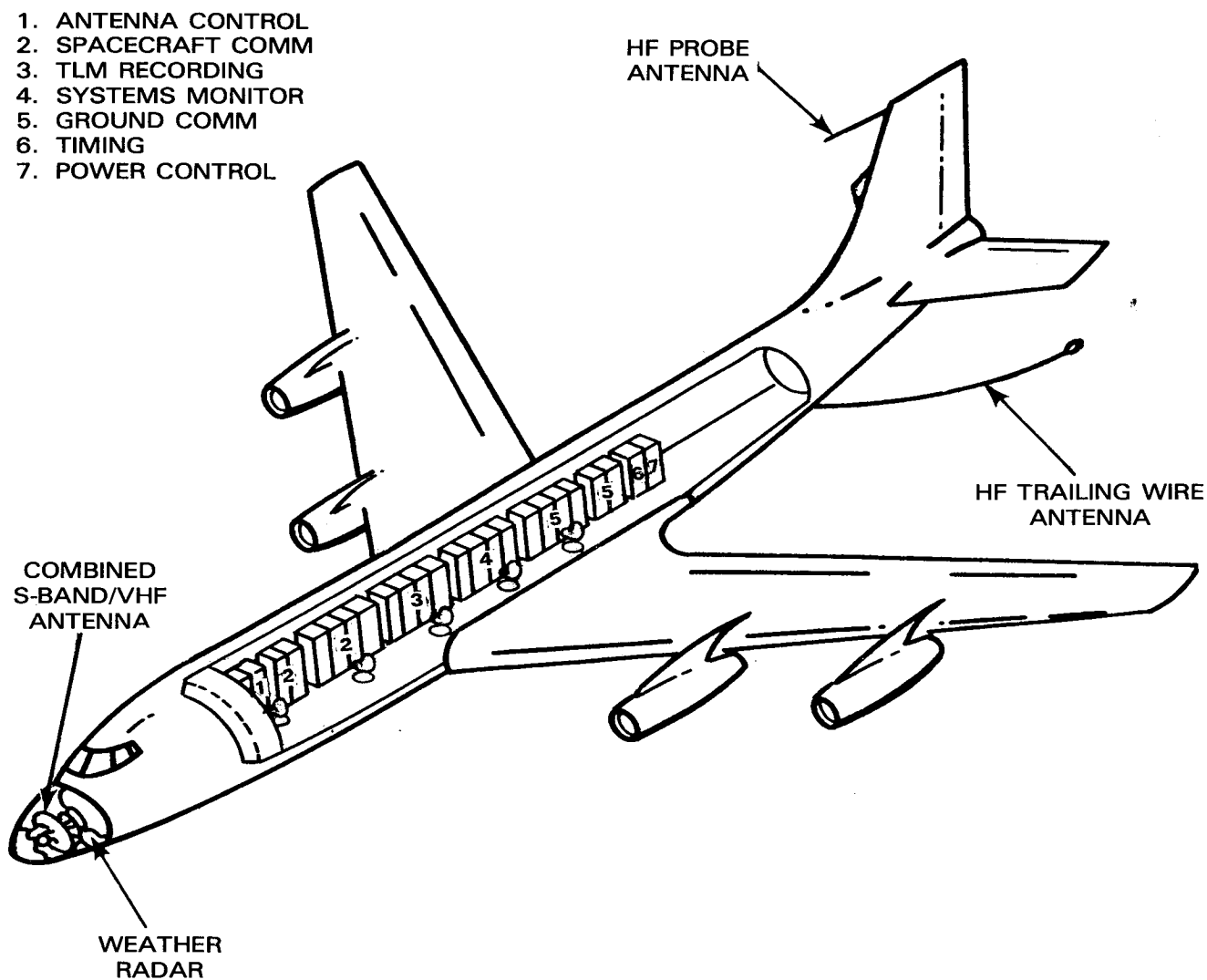

Figure 6-2. Apollo Range Instrumentation Aircraft

Where there were no ground stations, NASA relied on a fleet of eight Apollo Range Instrumentation Aircraft (ARIA) for extra voice and telemetry support during Apollo orbital injection and reentry. Douglas Aircraft Company and Bendix Corporation prepared Air Force C-135s for their new role by adding a bulbous nose, which accommodated a 2-meter antenna and weather radar, and by installing telemetry and communications hardware in the body (see figure 6-2 above). ARIA, first tested in 1966, was capable of S-band telemetry and voice reception, S-band voice transmission, air-to-ground voice relay on VHF, and telemetry recording. After the conclusion of the Apollo program, the Air Force continued to fly ARIA to support its own and NASA's tracking needs, but the first letter of the acronym came to stand for "Advanced" rather than "Apollo." Two ARIA supplemented the operations of the Space Tracking and Data Acquisition Network (STADAN) during the 1970s.

## Spaceflight Tracking and Data Network, 1969–1978

Throughout the 1970s, NASA continued to streamline its satellite tracking network, improving the equipment at primary stations and dropping other facilities from the system. Even though the average daily workload for the satellite trackers at the Goddard Space Flight Center was 40 spacecraft, NASA was able to close 3 stations in 1969 (Lima, Toowoomba, and Darwin) and 2 in 1970 (St. John's and Guaymas).

In 1972, the agency merged the Manned Spaceflight Network and the Spaceflight Tracking and Data Acquisition Network into one single operation, the Spaceflight Tracking and Data Network (STDN). The merger was primarily a money-saving tactic, for there was no approved manned flight schedule for the immediate post-Apollo years to justify keeping a tracking network intact exclusively for manned missions; and unmanned applications and scientific satellites such as the Earth Resources Technology Satellites (ERTS), which were designed to return high rates of data, could make use of stations and equipment assigned to the MSFN. Eleven stations, four AIRA instrumented aircraft, and one tracking ship, the *USNS Vanguard*, were transferred to the new STDN, bringing the total number of stations in the combined network to 17: Alaska, Ascension, Bermuda, Canary Island, Canberra, Carnarvon, Goldstone, Guam, Johannesburg, Kauai, Madrid, Merrit Island, Quito, Rosman, Santiago, Tananarive, and Winkfield.\* Goddard's Network Testing and Training Facility continued to serve as the training and new equipment testing center. A new Image Processing Facility also opened its doors at Goddard in 1972. This data processing center was built to handle the large quantities of video data transmitted by ERTS.

The STDN continued to fill the tracking and data acquisition needs of approximately 40 satellites each day plus *Apollo 16* and *17* in 1972, the Skylab missions in 1973, and the Apollo-Soyuz Test Project in 1975. All the while, NASA continued to draw the net in closer, because for each station it phased out the agency realized a substantial savings in operating funds but did not lose personnel, since the stations were manned by contractor employees.\*\* In 1974, the Minitrack facility at Goldstone was closed, along with Carnarvon and Canary Island, but Goddard came on line as an operational station. Two other stations were dropped the following year, one unexpectedly.

The Tananarive tracking station on Madagascar, off the east coast of Africa, was built in 1964 to give manned spacecraft ground controllers additional information on Gemini spacecraft orbital injection.<sup>+</sup> As with most of NASA's agreements with foreign countries that allowed the agency to build a facility on its soil, there was no exchange of funds. No rent was exacted for the site. The 10-year memorandum of understanding between the U.S. and the Malagasy Republic stressed the international benefits of space research to all mankind. And the tracking station would generate much-needed weather forecasts that would give the Republic maximum

---

\*Ft. Myers station was closed in 1972.

\*\* Bendix and Ford Aerospace and Communications provided most of the personnel for the tracking stations. There were usually one or two NASA employees per station.

+ This permanent station replaced a mobile facility (Majunga station) that began operations in 1963.

coverage, especially during hurricane season, and would provide jobs for some 200 local residents. The station proved critical to the MSFN and was transferred to the STDN in 1972. In February 1975, the chief of state of Malagasy was assassinated, and a rival government took control of the islands. Negotiations in the coming months between NASA and the new rulers centered on the Malagasy demand for rent on the station site: \$1 million per year retroactive to 1963. The U.S. could not agree to such a demand, and on July 14th, the Supreme Council of Revolution of the Malagasy Republic ordered the station closed and placed it under the control of the armed forces. NASA and Bendix employees were allowed to evacuate, but all equipment was left behind.\* So that support for the Apollo-Soyuz Test Project would not be disrupted, NASA made use of the orbiting *Applications Technology Satellite 6* to serve as a relay link. The workload from other satellites was shifted to other stations. Early trajectory support of launches was provided by increased use of ARIA and the *USNS Vanguard*.

The other closing in 1975 also took place in the shadow of politics. South Africa was one of the sites identified by the Naval Research Laboratory tracking specialists in the late 1950s as necessary for Project Vanguard. A Minitrack station was erected 26 kilometers northeast of Johannesburg in 1958. NASA followed suit and built a Deep Space Network 26-meter antenna 64 kilometers northwest of the city at Hartebeesthoek in 1961 and moved the satellite tracking equipment to the same general location, later adding a 14-meter antenna.\*\* The Johannesburg station was an important one for both earth orbital and interplanetary missions during the 1960s. Late in the decade and in the early 1970s, the existence of an American government facility in a country that practiced apartheid became a focal point of Congressional debate over NASA's budget. Each year a small but growing number of lawmakers would propose omitting funds for operating the Johannesburg station from the space agency's authorization. In 1973, NASA announced that for technical reasons it would phase out its South African facilities. Because the Deep Space Network could utilize its Madrid station, whose new 64-meter antenna had just been completed, that part of the Johannesburg complex was closed in 1974. The STDN facility could not be shut down until 1975 because it was vital to Project Viking near-earth operations.

New hardware was added to three STDN stations in 1975. To support Landsat/ERTS, special wideband equipment for handling higher data rates was installed at Alaska, Goldstone, and Goddard stations.

Also in 1975, the Office of Tracking and Data Acquisition established a special-purpose laser tracking network in support of *Geos 3*, whose mission was to measure the geometry of the ocean surface. Lasers were located at Wallops Flight Center (Virginia), Bermuda, Grand Turk Island, and the Eastern Test Range. The laser tracking system was implemented in 1976 in conjunction with Project Lageos to apply the science of plate tectonics to studying continental drift.

---

\* A NASA inspection team was allowed to return to the station in September 1978 to determine what equipment the agency would like to recover. Agreement over removal of the hardware was reached in October 1979, and the equipment was repatriated in March 1980. The remaining property was turned over to the Malagasy Republic by diplomatic note.

\*\* South Africa was also the site of a Smithsonian Astrophysical Observatory precision optical station at Olifantfontein and a DoD missile tracking station near Pretoria.

Tracking and data acquisition specialists also were involved in planning for the next-generation space transportation system — Shuttle. The telemetry facility at the Dryden Flight Research Center, located near Edwards Air Force Base in California, was built to support the flight testing of high-speed research aircraft for NASA and the Air Force. It was being modified to support Shuttle approach and landing tests, which were scheduled to begin in 1977. Tracking and data acquisition for Shuttle during earth orbital operations in the 1980s was being studied as well. NASA hoped to have a Tracking and Data Relay Satellite System in place in time for the first Shuttle flights (see discussion below).

STDN personnel closed out the second decade by further improving their operation at the Goddard Space Flight Center. A new telemetry processing system eliminated the need for tape recording data at each station. As of 1977, data entered a mass storage system directly from communications lines, eliminating delays in recording and then in shipping the tapes from stations to Goddard. In 1978, the Goddard control center was modified to allow participating project scientists to manipulate their experiments directly, working with the trackers and controllers in real time. And the Image Processing Facility was improved with new master data processing units. These additions and improvements were necessary, for the Spaceflight Tracking and Data Network was monitoring and commanding some 50 spacecraft daily by the end of NASA's second 10 years.

### **Deep Space Network, 1969–1978**

The Deep Space Network continued operations through the second decade much as it had started the first, depending primarily on a three-station network. At Canberra, Australia, in the Mojave Desert in California, and near Madrid, Spain, NASA's 26-meter and 64-meter deep space antennas serve as the communications link with interplanetary probes, satellites, and landers. A fourth facility near Johannesburg, South Africa, was closed in 1974 (see discussion above). At the Goldstone tracking complex in California, there were four distinct DSN stations: Echo (26-meter), Mars (64-meter), Pioneer (26-meter), and Venus (9- and 34-meter). At Madrid, there were two: Robledo (26- and 64-meter) and Cebreros (26-meter). The first of the second-generation giant 64-meter facilities had become operational in 1968 at Goldstone, with the second and third being readied in 1973 at Canberra and Madrid. These two classes of antennas were used successfully in the 1970s with few modifications.

In 1969 and 1970, the DSN kept scientists in touch with *Mariner 6* and *7* spacecraft as they flew by Mars. Pioneer missions to the more distant planets returned photographs and scientific data through the network for most of the decade. *Mariner 9* and *10*, probe missions to Venus and Mercury, demanded several mid-course trajectory changes from the trackers. But the event that caused the most excitement among deep space trackers and interplanetary scientists was the 1976 landing on Mars by two Viking spacecraft. For the first time, a spacecraft on the surface of another planet was controlled, commanded, and interrogated. The DSN proved flexible to the scientists' and engineers' changing needs during the complex mission operations.

Goldstone's 64-meter antenna was also used for radio astronomy experiments, several of which were designed to provide Project Viking personnel with more infor-

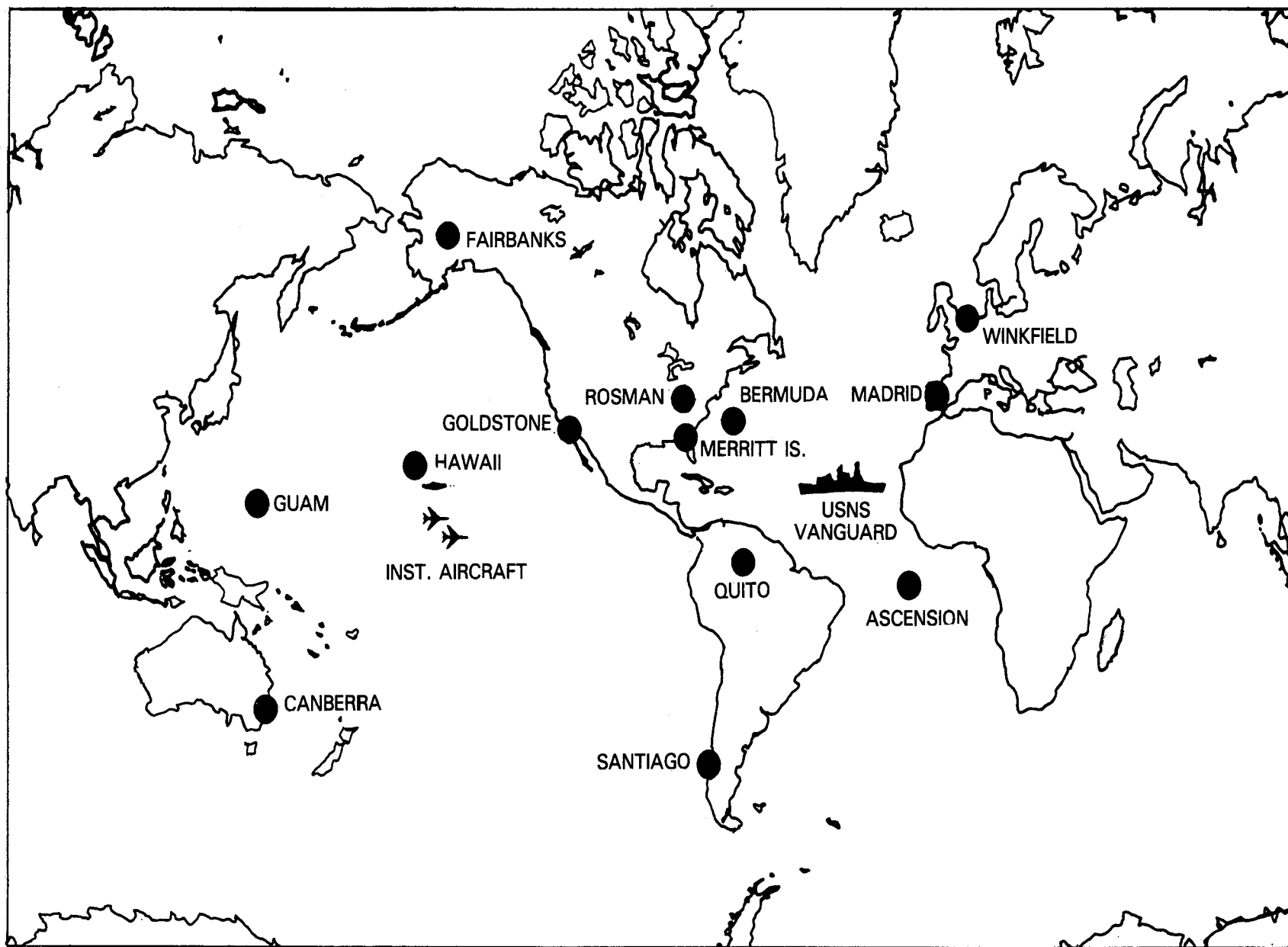

Figure 6-3. Spaceflight Tracking and Data Network, 1975

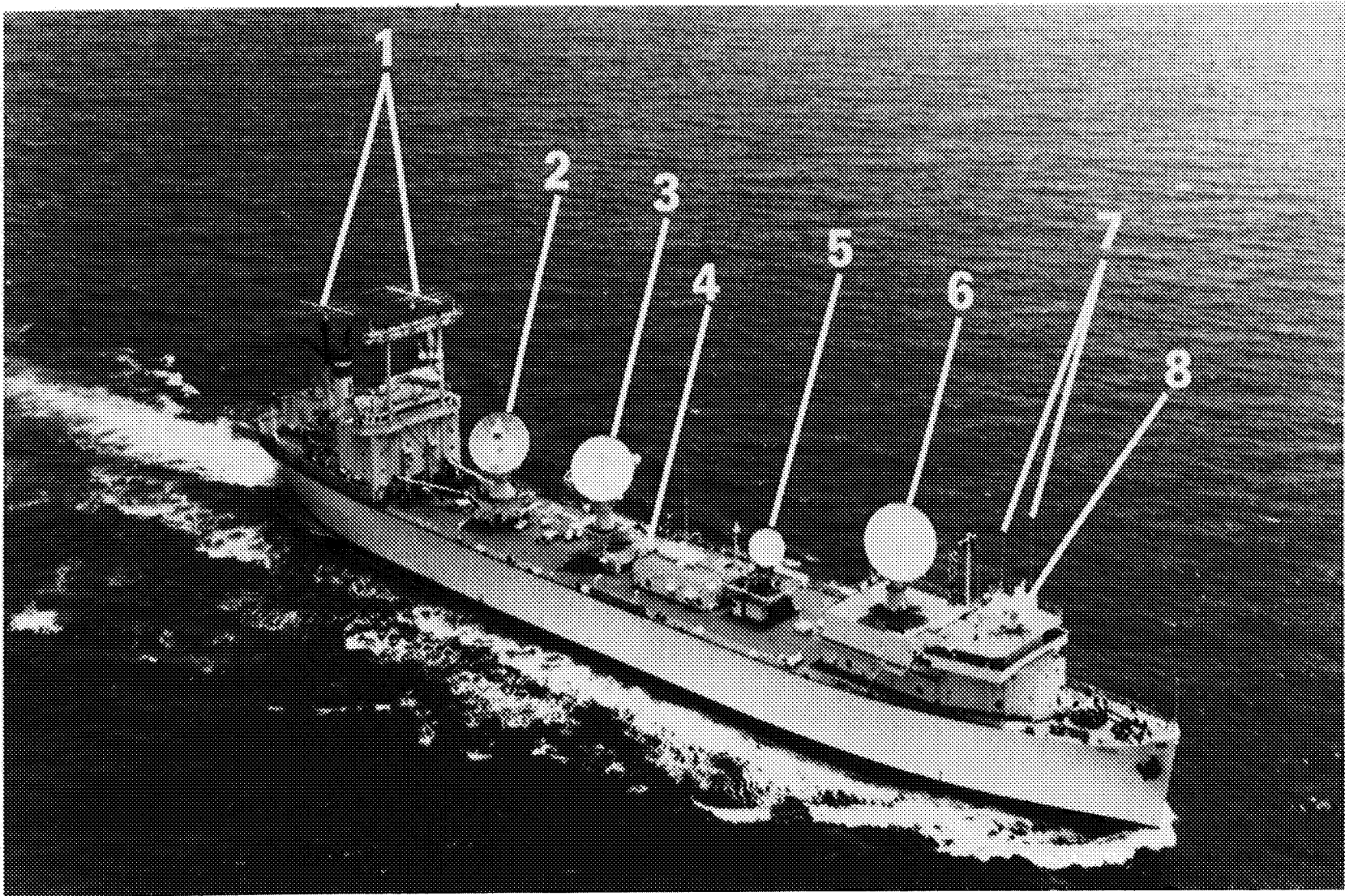

Figure 6-4. STDN Tracking Ship. NASA contracted with General Dynamics in 1964 to convert three retired World War II T-2 tankers into instrumented tracking ships for Apollo. Measuring 181 meters overall and 23 meters at the beam, they carried 9-M USB antennas, radar units, and telemetry and command equipment. The ships were operated by civilian crews of the military sea transport group. (1) Log Periodic Antenna, (2) Medium Gain UHF Telemetry Antenna, (3) Unified S-Band Antenna, (4) Star Tracker Dome, (5) C-Band Tracker Antenna, (6) SATCOM Terminal Antenna, (7) HF Whip Antenna, (8) Command Control Antenna.

mation on the Martian surface. In 1970, radio astronomers demonstrated the use of radar at planetary distances. By the next year, they had mapped the Martian surface. In 1973, the 64-meter dish was put to work conducting the first radar probe of Saturn.

At two other Deep Space Network stations, tracking and data acquisition experts tested equipment and theories and experimented with new equipment and procedures. The Compatibility Test Station was located at Cape Kennedy. At the Goddard Venus station, the network's research and development center, advanced research projects, such as the conversion of a 26-meter antenna to a dual-frequency (S- and X-bands) 34-meter antenna, took place.

The 26-meter-diameter steerable parabolic dish antennas erected first at Goldstone deep space station were patterned after the radio astronomy antennas in use at the Carnegie Institute and elsewhere in the late 1950s with three significant modifications. A closed-loop device for automatically pointing the antenna at the target was added, as was an electrical feed apparatus for driving the servocontrol system, which responded to signals from the spacecraft. The antenna's gear system was simplified for the space tracking role. A polar mount steered the antenna from one horizon to the other at a sidereal rate; a smaller declination gear wheel controlled pivot movement up and down. Made of aluminum, the parabolic dish offered a focal length of about 11 meters and a pointing accuracy of better than 0.02 degrees. The acquisition antenna had a diameter of 1.8 meters. The entire structure weighed over 45 000 kilograms and stood 37 meters tall. Precision operation was possible in winds up to 32 kilometers per hour; accurate operation was still feasible in winds up to 48 kilometers per hour. The antenna could survive in any position during 113-kilometer-per-hour winds, and it could be stowed in a survival position (reflect at zenith) to withstand harsher conditions. Operating at a radio frequency band of 2090-2120 megahertz for transmission and 2270-2300 for reception, the antenna had an average power capability of 20 kilowatts, 40 kilowatts at peak. Goldstone's Venus antenna had a special high-power transmitter. DSN 26-meter antennas were used at Goldstone (2), Canberra, Johannesburg, Madrid (2), and Woomera.

The Deep Space Network extended its range to the most distant planets of the solar system with the addition of three 64-meter-diameter antennas. These parabolic antennas could maintain spacecraft communications to a distance of 2½ to 3 times the range achieved by the 26-meter antennas and had 6½ times more transmitting and receiving capability. Standing 71 meters tall, the structure weighed 7.2 million kilograms. Its azimuth-elevation mount and motors (1300 horsepower) could move the giant dish from a horizon-pointing attitude to a straight-up position in three minutes. Goldstone's Mars station went into operation in 1968 and Madrid's Robledo and Canberra's Tidbinbilla in 1973. The stations in Spain and Australia have 100-kilowatt transmitters; at Goldstone the uplink signal can be radiated at up to 400 kilowatts.



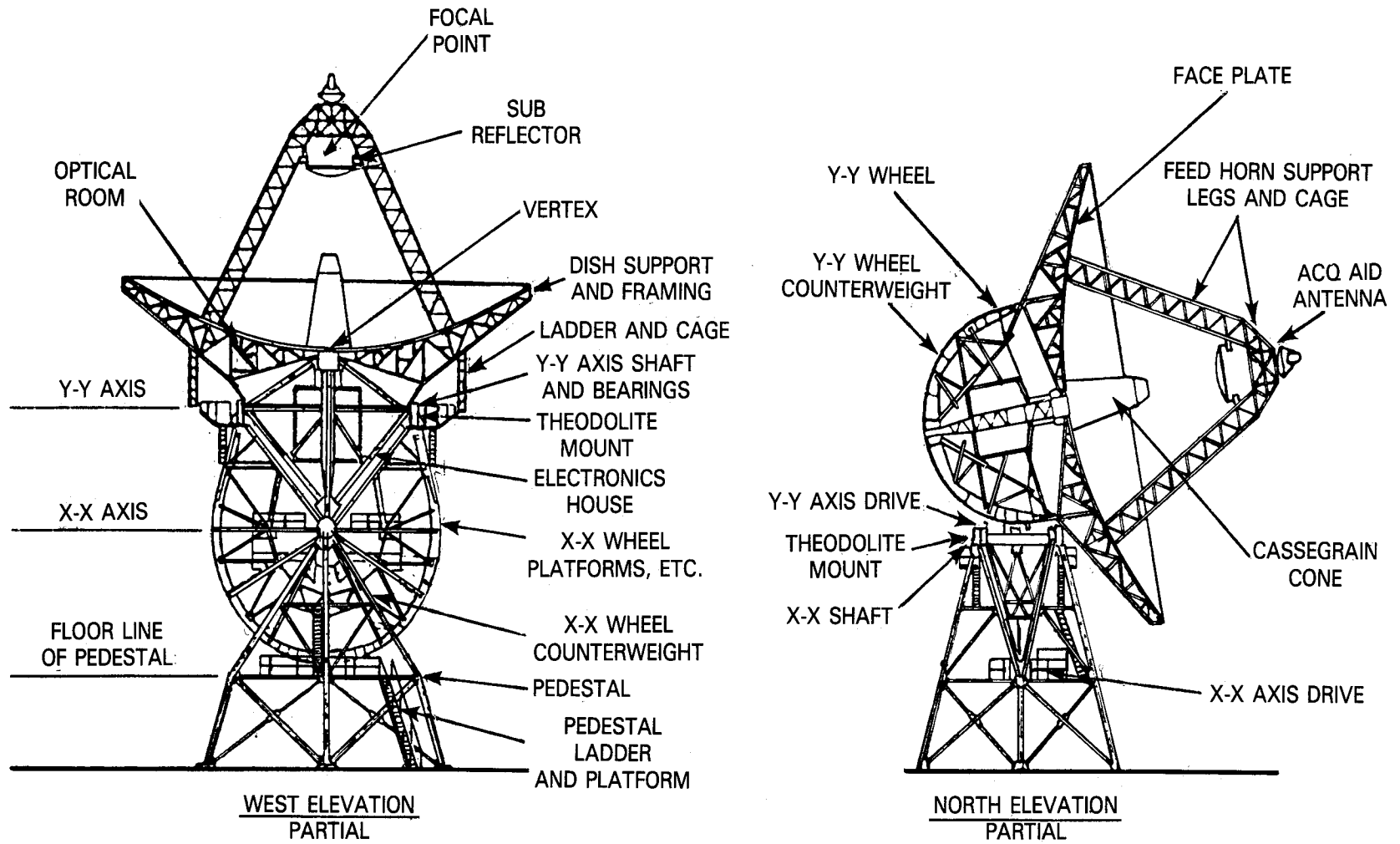

Figure 6-5. Deep Space Network 26-meter Antenna

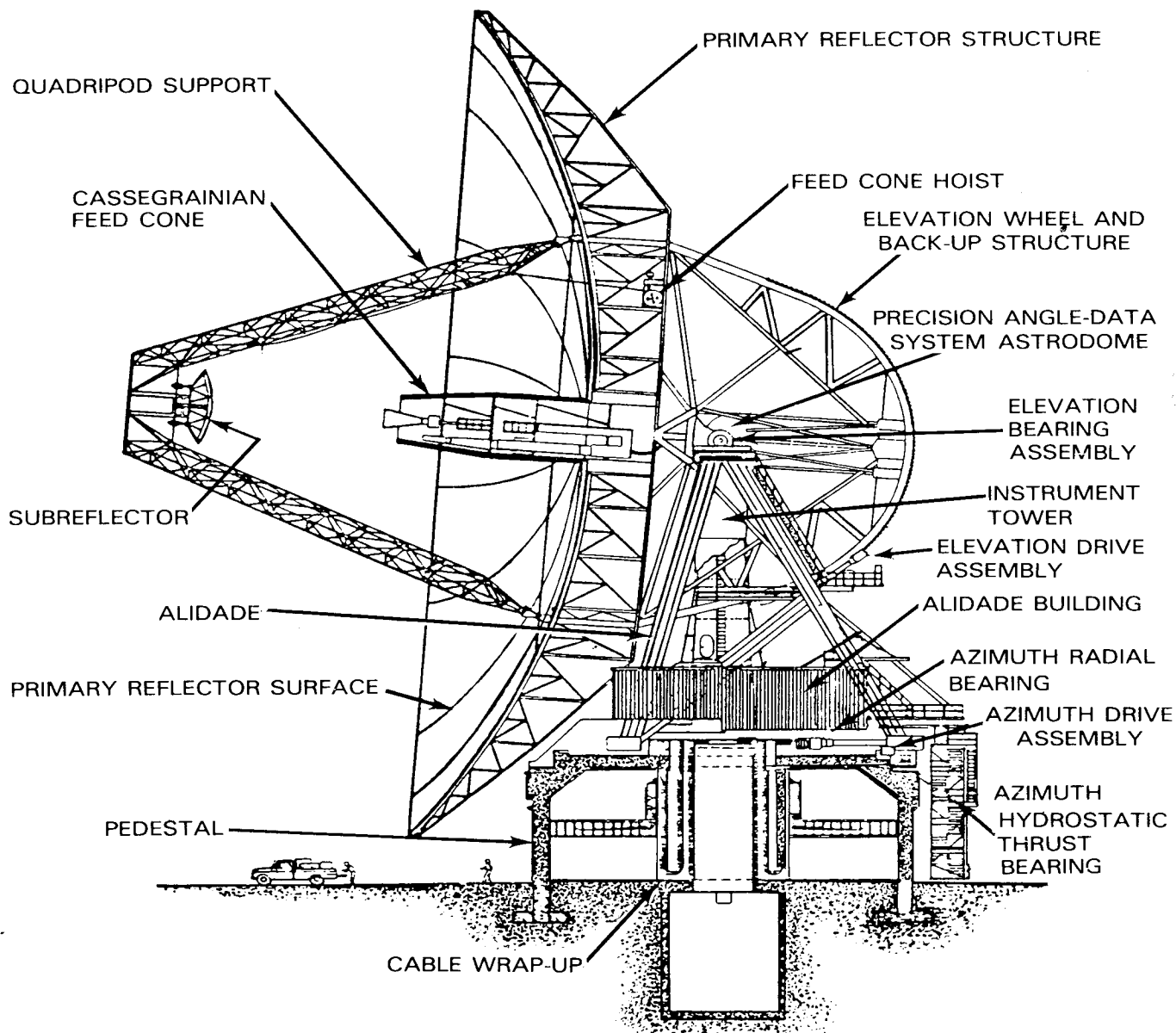

Figure 6-6. Deep Space Network 64-meter Antenna.

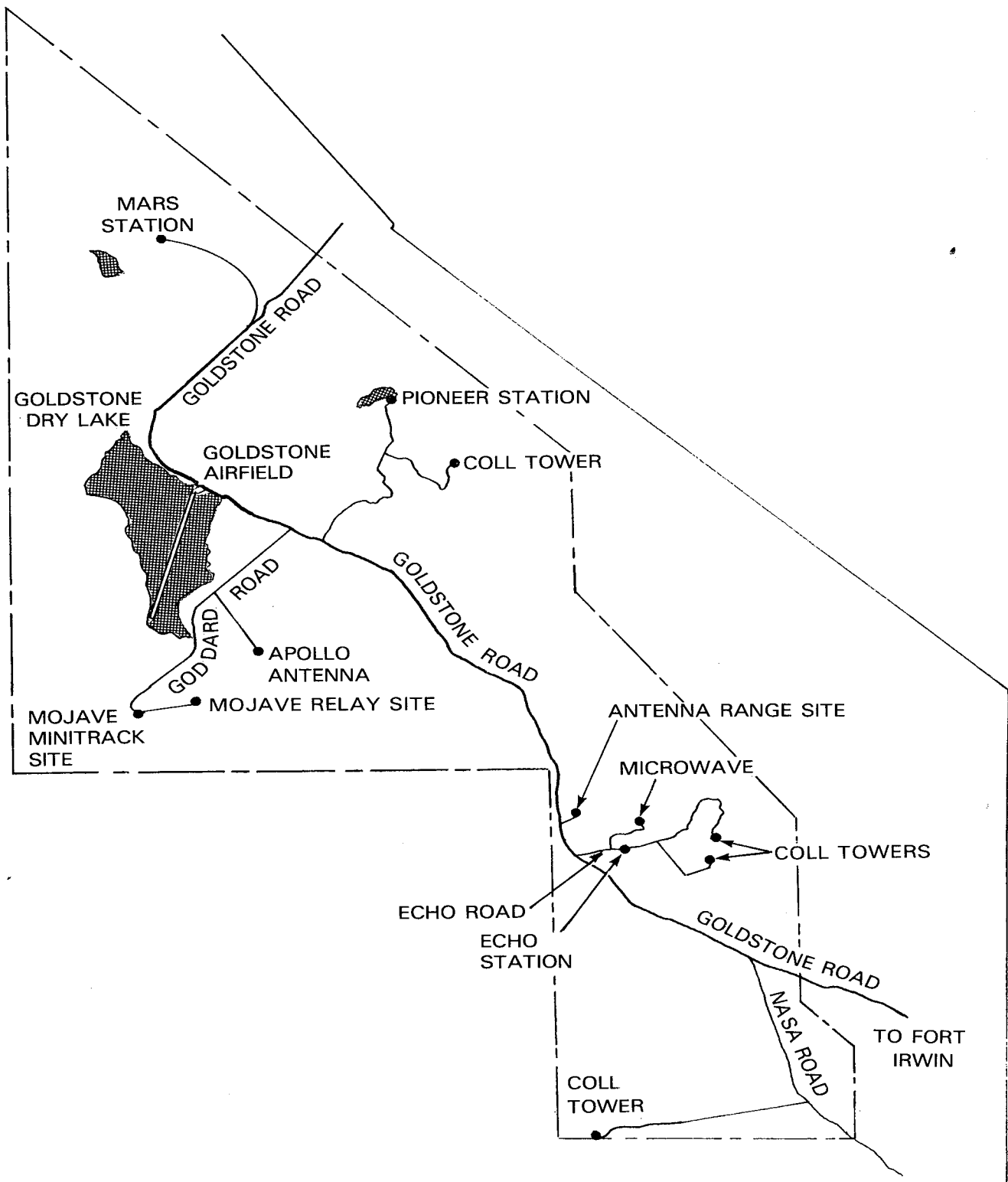

Figure 6-7. NASA's Goldstone Space Communications Station in southern California's Mojave Desert was the site of the largest collection of NASA tracking and data acquisition equipment. In addition to the Mojava STADAN station (14-m antenna) and the Apollo station (26-m antenna), there were four deep space stations at this location: Mars (64-m antenna), Pioneer (26-m antenna), Echo (26-m antenna), and Venus (9- and 34-m antennas). These facilities were built on a 176-square-kilometer plot of land leased by NASA from DoD. The station was managed by the Jet Propulsion Laboratory.

Table 6-30. Spaceflight Tracking and Data Acquisition Network/Spaceflight Tracking and Data Network Stations, 1969-1978

Station	Former MSFN Station	Years Operational
Alaska		1962-
Ascension Island	X	1967-
Bermuda	X	1961-
Canberra	X	1965-
Cape Kennedy	X	1961-
Carnarvon		1964-1974
Darwin		1966-1969
Ft. Myers		1959-1972
Goldstone/Mojave		1960-1969
Grand Bahama	X	1967-1970
Grand Canary	X	1961-1975
Guam	X	1966-
Kasima Machi <sup>a</sup>		1967-1970
Kauai		1965-
Lima		1957-1969
Madrid	X	1967-
Merritt Island	X	1973-
Network Test and Training Facility <sup>b</sup>		1966-
Quito		1957-
Rosman		1963-1981
Santiago		1957-
Singapore <sup>a</sup>		1963-1970
St. John's <sup>c</sup>		1960-1970
Tananarive		1965-1975
Toowoomba		1966-1969
White Sands	X	1961-
Winkfield		1961-

<sup>a</sup>Collateral stations.

<sup>b</sup>Became an operational part of the network in 1974.

<sup>c</sup>Mobile tracking equipment used on St. John's for Skylab and ASTP launches.

Table 6-31. Deep Space Network Stations, 1969-1978

Station	Number	Antenna (m)	Years Operational
Ascension Island	72	9	1966-69
Cape Kennedy Compatibility Test Station	71	1.3	1965-
Canberra (Tidbinbilla)	42	26	1965-
		64	
Goldstone Echo	12	26	1960-
Goldstone Mars	14	64	1968-
Goldstone Pioneer	11	26	1958-
Goldstone Venus	13	9	1962-
		34*	
Johannesburg	51	26	1961-74
Madrid (Robledo)	61	26	1965-
		64	
Madrid (Cebreros)	62	26	1967-
Woomera	41	26	1960-72

\*Modified 26-meter antenna.

Table 6-32. Tracking and Data Acquisition Stations, 1969-1978

Station (Location)	Code Name or Number	Latitude Longitude	Type of Station			Established	Phased Out	Equipment	Remarks
			STADAN	MSFN	DSN				
Alaska (near Fairbanks)	ALASKA	64°59'N 147°31'W	X			1962		GRARR and MOTS; SATAN receivers and command; dish antennas (12, 14, and 26 m)	Also referred to as Fairbanks station. ESSA also operated a station equipped with a 26-m antenna in nearby Gilmore. Planned to be used as 1 of 5 TDRSS orbital support stations.
Antigua (British West Indies)	ANG	17°09'N 61°47'W		X		1967	1970	9-m USB; VHF telemetry links; telemetry recording	DoD also operated a tracking station on Antigua which supported NASA until 1970.
Ascension Island (South Atlantic)	ASN	7°57'S 14°35'W	X	X	X	1967		9-m USB; VHF telemetry links; FM remoting telemetry; decommutators; telemetry recording; data processing; communications (voice, VHF air to ground, teletype, video, and high-speed data); 9-m DSN antenna	Primary USB station for near-Earth Apollo operations. DoD also operated a station on Ascension. DSN operations were phased out in 1969.
Bermuda (Atlantic)	BDA	32°15'N 64°50'W	X	X		1961		C-band radar; 9-m USB; VHF telemetry links; FM remoting telemetry; decommutators; telemetry recording; data processing; communications (voice, VHF air to ground, teletype, video, high-speed data)	Data received at Bermuda were crucial in making the go-no-go decision for orbital insertion. Bermuda also provided reentry tracking for Atlantic recovery situations. Planned to be used as 1 of 2 TDRSS launch support stations.
Canary Island. See Grand Canary.									
Canberra (southeastern Australia)	CANBERRA 42	35°24'S 148°59'E	X	X	X	1965		26-m USB; FM remoting telemetry; decommutators; telemetry recording; data processing; communications (voice, video, teletype, and high-speed data); 64-m antenna	Also officially called Honeysuckle Creek as part of the MSFN and Tidbinbilla as part of the DSN. Supported Apollo lunar operations. 26-m antenna transferred to the DoD in 1973. Planned to be used as 1 of 5 TDRSS orbital support stations. The 64-m antenna, 1 of 3 built by NASA, became operational in 1973.

Table 6-32. Tracking and Data Acquisition Stations, 1969-1978 (Continued)

Station (Location)	Code Name or Number	Latitude Longitude	Type of Station			Established	Phased Out	Equipment	Remarks
			STADAN	MSFN*	DSN				
Cape Kennedy (Florida)	CAPE 71	28°28'N 80°34'W	X	X	X	1961	9-m USB; radar (FPS-16, ODOP, and optical); acquisi- tion aid; telemetry reception; data processing, communica- tions (voice, VHF air to ground, and telemetry); 1.3-m DSN antenna	Not considered part of the global STADAN or MSFN networks but supported Eastern Test Range launches. The DSN Compatability Test Station, located nearby (28°29'N), was built in 1965.	
Carnarvon (western Australia)	CARVON or CRO	24°54'S 113°43'E	X	X		1964	1974	GRARR; 9-m USB; C-band radar; VHF telemetry links; FM remoting telemetry; decommutators; telemetry re- cording; data processing; com- munications (voice, VHF air to ground, teletype, video, and high-speed data)	Equipment from Muchea (closed 1964 and Woomera (closed 1966) stations was consolidated here. For Project Biosatellite, Yagi com- mand equipment was used here.
Cebreros. See Madrid.									
Corpus Christi (Texas)	TEX	27°39'N 97°23'W		X		1961	1974	9-m USB; VHF telemetry links; FM remoting telemetry; decommutators; telemetry re- cording; data processing; com- munications (voice, VHF air to ground, teletype, video, and high-speed data)	Station not critical for STADAN operations.
Darwin (north- central Australia)	DARWIN	12°17'S 130°49'E	X			1965	1969	4.3-m antenna; Yagi command	Antenna transferred to Kauai sta- tion.
Fairbanks. See Alaska.									
Ft. Myers (Florida)	FTMYRS	26°33'N 81°52'W	X			1959	1972	SATAN receivers and com- mand; 3 Yagi command; MOTS	
Gilmore. See Alaska.									
Goddard. See Network Test and Training Facility.									

Table 6-32. Tracking and Data Acquisition Stations, 1969-1978 (Continued)

Station (Location)	Code Name or Number	Latitude Longitude	Type of Station			Established	Phased Out	Equipment	Remarks	
			STADAN	MSFN*	DSN					
Goldstone (California)								Goldstone, located in the Mojave Desert, is the largest concentration of NASA tracking and data acquisition equipment. There are 6 individual stations. Planned to be used as 1 of 5 TDRSS global support stations.		
	MOJAVE	35°20'N 116°54'W	X			1960	1969	14-m antenna; SATAN receivers and command		
	GDS	35°20'N 116°54'W	X	X		1967		9-m antenna; 26-m USB; FM remoting telemetry; decommutators; telemetry recording; data processing; communications (voice, teletype, video, and high-speed data)	Also called Apollo station.	
	ECHO 12	35°18'N 116°49'W					X	1960	26-m antenna	
	MARS 14	35°26'N 116°44'W					X	1968	64-m antenna	NASA's first 64-m antenna; used to support planetary missions.
	PIONEER 11	35°23'N 116°51'W					X	1958	26-m antenna	
	VENUS 13	35°26'N 116°53'W					X	1962	9-m antenna 34-m antenna	DSN research and development facility.
	Grand Bahama (south Atlantic)	GBM	26°38'N 78°16'W		X		1967	1970	9-m USB; VHF telemetry links; FM remoting telemetry; decommutators; telemetry recording; data processing; communications (voice, VHF air to ground, teletype; video; and high-speed data)	Critical station during launch phase. DoD also operated a tracking facility on Grand Bahama, which supported NASA missions.

Table 6-32. Tracking and Data Acquisition Stations, 1969-1978 (Continued)

Station (Location)	Code Name or Number	Latitude Longitude	Type of Station			Established	Phased Out	Equipment	Remarks
			STADAN	MSFN*	DSN				
Grand Canary (near coast of Morocco)	CYI	27°44'N 15°36'W	X	X	1961	1975	C-band radar; 9-m USB; VHF telemetry links; FM remoting telemetry; decommutators; telemetry recording; data processing; communications (voice; VHF air to ground, teletype, video, and high-speed data)		
Guam (Pacific)	GWM	13°18'N 144°44'E	X	X	1966		9-m USB; VHF telemetry links; FM remoting telemetry; decommutators; telemetry recording; data processing; communications (voice, VHF air to ground, teletype, video, and high-speed data)		
Guaymas (Mexico)	GYM	27°57'N 110°43'W		X	1961	1970	9-m USB; VHF telemetry links; FM remoting telemetry; decommutators; telemetry recording; data processing; communications (voice, VHF air to ground, teletype, video, and high-speed data)		

Hawaii. See Kauai.

Honeysuckle Creek. See Canberra.



Table 6-32. Tracking and Data Acquisition Stations, 1969-1978 (Continued)

Station (Location)	Code Name or Number	Latitude Longitude	Type of Station		Established	Phased Out	Equipment	Remarks
			STADAN	MSFN*				
Johannesburg (South Africa)	JOBURG 51	25°53'S 27°42'E	X		1958	1975	14-m antenna; SATAN receivers and command; Yagi command; MOTS; 26-m antenna	The STADAN facility began operation in 1958 and was closed in 1975. The DSN facility, located at Hartbeesthoek, opened in 1961 and was closed in 1974. DoD also operated a station in the vicinity, known as Pretoria. The Smithsonian Astrophysical Observatory maintained a facility in the area at Olifantsfontein. Officially NASA closed its operation for technical reasons, but the agency was also under political pressure from Congress to do so because of South Africa's apartheid practices.
Kasima Machi (Japan)		35°57'N 140°40'E	X		1967	1970		Collateral station.
Kauai (Hawaii)	KAUAIH or HAW	22°07'N 157°40'W	X	X	1961		2 Yagi command; 4.3-m antenna; C-band radar; 9-m USB; VHF telemetry links; FM remoting telemetry; decommutators; telemetry recording; data processing; communications (voice, VHF air to ground, teletype, video, and high-speed data)	The MSFN station began operations in 1961 and the STADAN in 1965.
Lima (Peru)	LIMAPU	11°47'S 77°09'W	X		1957	1969	SATAN receivers and command; Yagi command; MOTS	
Madagascar. See Tananarive.								
Madrid (Spain)								
								There were 3 individual NASA stations near Madrid. Planned to be 1 of 5 TDRSS orbital support stations.

Table 6-32. Tracking and Data Acquisition Stations, 1969-1978 (Continued)

Station (Location)	Code Name or Number	Latitude Longitude	Type of Station			Established	Phased Out	Equipment	Remarks
			STADAN	MSFN*	DSN				
	MAD	40°27'N 4°10'W	X	X		1967	26-m antenna; FM remoting telemetry; decommutators; telemetry recording; data processing; communications (voice, video, teletype, and high-speed data)	Referred to officially as Madrid station.	
	61	40°26'N 4°10'W				1965	26-m antenna 64-m antenna	Known as the Robledo DSN station. The 64-m antenna, 1 of 3 built by NASA, became operational in 1973.	
	62	40°27'N 4°22'W				1967	26-m antenna	Known as the Cebreros DSN station.	
Merritt Island (Florida)	MIL	28°25'N 80°40'W	X	X		1973	3.7-m USB; C-band radar; VHF telemetry links; FM remoting telemetry; decommutators; telemetry recording; data processing; communications (voice, VHF air to ground, teletype, video, and high-speed data)	Located near the Cape Kennedy launch complex. Planned to be used as 1 of 2 TDRSS launch support stations.	
Mojave. See Goldstone.									
Network Test and Training Facility (Maryland)	NTTF	38°59'N 76°51'W	X	X	X	1966		Located at Goddard Space Flight Center, this facility was used only for testing new equipment bound for the networks and for training new personnel until 1974, when it was made part of the operational network.	
Orroral Valley (Southeastern Australia)	ORORAL	35°38'S 148°57'E	X			1965	26-m antenna; 2 SATAN receivers and command; Yagi command; MOTS	Provided geodetic data for the South Pacific area.	
Quito (Ecuador)	QUITOE	37'S 78°35'W	X			1957	12-m antenna; SATAN receivers and command; 3 Yagi command; MOTS		

Table 6-32. Tracking and Data Acquisition Stations, 1969-1978 (Continued)

Station (Location)	Code Name or Number	Latitude Longitude	Type of Station			Established	Phased Out	Equipment	Remarks
			STADAN	MSFN*	DSN				
Robledo. See Madrid.									
Rosman (North Carolina)	ROSMAN	35°12'N 82°52'W	X			1963	1981	2 26-m antennas; GRARR; 3 SATAN receivers and com- mand; MOTS; ATS telemetry and command	Received high-data-rate telemetry from observatory-class satellites. Facility turned over to DoD in 1981. Planned to be used as 1 of 5 TDRSS orbital support stations.
Santiago (Chile)	SNTAGO	33°09'S 70°40'W	X			1957		12-m antenna; GRARR; 2 SATAN receivers; 1 SATAN command; Yagi command; MOTS	
Singapore (South- east Asia)		2° S 103° E	X			1963	1970		Collateral station.
St. John's (Newfoundland)	NEWFLD	47°44'N 52°43'W	X			1960	1970	3 Yagi command; MOTS	
Tananarive (Malagasy Republic)		19°00'S 47°18'E	X			1965	1975	14-m antenna; GRARR	This STADAN station also sup- ported Apollo operations. The sta- tion was abandoned when a new revolutionary government demand- ed \$10 million in back rent (no ex- change of funds had ever been agreed to). Some of the equipment left at the facility was repatriated in 1980.
Tidbinbilla. See Canberra.									
Toowoomba (eastern Australia)	TOOMBA	27°24'S 151°56'E	X			1966	1969	14-m antenna; SATAN receivers; Yagi command; transportable ATS equipment	Used primarily to support ATS. Also referred to as Cooby Creek.

Table 6-32. Tracking and Data Acquisition Stations, 1969-1978 (Continued)

Station (Location)	Code Name or Number	Latitude Longitude	Type of Station		Established	Phased Out	Equipment	Remarks
			STADAN	MSFN* DSN				
White Sands (New Mexico)	WHS	32°21'N 106°22'W	X	X	1961		C-band radar; communications (voice and teletype)	This station provided support dur- ing Apollo. Located on the Army's White Sands Missile Range, the station was equipped with DoD radar and NASA-owned acquisi- tion aids. Planned to be used as the site of the TDRSS ground sta- tion.
Winkfield (England)	WNKFLD	51°27'N 00°42'W	X		1961		4.3-m antenna; SATAN re- ceivers and command; Yagi command; MOTS	Operated by British personnel.
Woomera (southern Australia)	41	31°23'S 136°53'E			1960	1972	26-m antenna	
Tracking ships	<i>Huntsville</i>			X	1962	1969		Originally used to support Mer- cury; modified for Apollo.
	<i>Mercury</i>			X	1966	1969		Instrumented by NASA, this re- fitted tanker was used in the Pacific during Apollo operations.
	<i>Redstone</i>			X	1966	1969		Instrumented by NASA, this re- fitted tanker was used in the In- dian Ocean during Apollo opera- tions.
	<i>Vanguard</i>		X	X	1966	1978		Instrumented by NASA, this re- fitted tanker was used in the Atlantic during Apollo operations and later as part of the STADAN.

Table 6-32. Tracking and Data Acquisition Stations, 1969-1978 (Continued)

Station (Location)	Code Name or Number	Latitude Longitude	Type of Station		Established	Phased Out	Equipment	Remarks
			STADAN	MSFN* DSN				
	<i>Watertown</i>			X	1962	1969		Originally used to support Mercury; modified for Apollo.
Apollo Range Instrumentation Aircraft	ARIA		X	X	1966			Eight instrumented aircraft were used as communications relays to support Apollo operations in areas where there were no ground stations, especially during reentry and landing. In 1975, 2 aircraft remained in the STADAN network.

## Tracking and Data Relay Satellite System

Studies for a tracking and data acquisition system that relied on synchronous orbit satellites rather than a network of ground stations date back to the early 1960s, when the Air Force contracted with the Lockheed Missiles and Space Company and the General Electric Company to investigate the feasibility of an "Instrumentation Satellite." In 1964, Goddard Space Flight Center tracking personnel requested that the NASA Headquarters Office of Tracking and Data Acquisition consider funding an orbiting tracking and data station as a supporting research and technology task. Managers in Washington were intrigued with the idea but suggested that the subject was better suited for an advanced study. Two years later in April 1966, RCA Astro-Electronics Division and Lockheed were awarded six-month contracts to define the characteristics of an "Orbiting Data Relay Network." By the fall of 1967, OTDA was convinced that the tracking satellite had a place in the tracking net of the future and established at Goddard a Data Relay Satellite System (DRSS) Requirements and Interface Panel, which included specialists from the manned spaceflight and space science and applications offices. The panel's assignment was to oversee the definition phase of such a system.

The general consensus called for a two-satellite network, with the spacecraft placed in geosynchronous orbit about 130 degrees apart over the equator (over the northeast corner of Brazil—the east satellite—and southwest of Hawaii—the west satellite). The planners hoped that a system could "be developed to augment and, to the extent practical, to replace certain of the facilities that now comprise NASA's tracking and data acquisition network."<sup>6</sup> The agency hoped to have a tracking satellite system in orbit by 1974-1975.

In May 1971, Goddard issued a request for proposals to industry for an analysis and conceptual design for a Tracking and Data Relay Satellite System (TDRSS), which was answered by Hughes Aircraft and North American Rockwell. Before these two contractors finished their studies in 1973, NASA's budget conscious leaders realized that Congress would not support a development effort that would lead to a system ready for flight within two years. In an effort to get the project started without committing the agency to a future purchase of several satellites, OTDA began to consider the possibility of leasing rather than buying a satellite system. Since TDRSS was planned as a support facility rather than a research and development project, NASA considered leasing to be a viable option. All the technology required to implement the TDRSS was labeled as either off-the-shelf or in such an advanced state of development that it was considered state of the art.<sup>7</sup> In September 1973, Administrator James C. Fletcher wrote to individual members of Congress advising them of the agency's budget needs for FY 1975. Among the new starts listed was TDRSS. He wrote, "Our studies have shown that the only way to meet our future tracking and data acquisition needs with reasonable expenditure of funds will be through a . . . TDRSS. Such a system will improve our earth orbital tracking and data acquisition capabilities and meet the high data rates anticipated when the space shuttle is in operation, while at the same time permitting the elimination of most of the ground stations in the present . . . STDN." Fletcher went on to explain that this approach, while a cost saver for the future, would require "large government expenditures for development and construction of ground terminals in the FY 1976-78 period when space shuttle development expenditures will be at their

peak." The alternative was leasing the services from an industry-established system, including both the satellites and the ground station. NASA had already identified six companies that were interested in the project, but it needed the assistance of Congress to "develop the necessary legislative language to authorize NASA to enter" into this type of contractual arrangement.<sup>8</sup> Congress debated the wisdom of such a relationship through the spring of 1974, but finally authorized it in May.

NASA had the authority to lease a satellite system from a contractor for 10 years. By October 1974, 27 companies or teams of companies had indicated their interest in bidding for the design, fabrication, and operation of TDRSS, the first launch of which was now scheduled for 1979. On February 7, 1975, Goddard issued a request for proposals for two or more Phase A (detailed system design and cost proposal) studies. RCA Global Communications, Inc., and Western Union Telegraph Company teamed with TRW Systems Group were awarded contracts in June. Hughes Aircraft was set to work defining the antennas required for the spacecraft that were to be tracked.<sup>9</sup>

In addition to the two active satellites in the system, there would also be an in-orbit spare. The trackers would be equipped with VHF, UHF, S-band, X-band, and KU-band capability and high and low data rate user service for a maximum of 28 users per satellite. These capabilities would eliminate the need for spacecraft on-board tape recorders, which would increase spacecraft usefulness because of the relatively short lifetime of these recorders. The satellites, which would serve primarily those spacecraft operating below 5000 kilometers, were to be designed to last five years. One continental U.S. ground station would be built at White Sands Test Facility, New Mexico, with an 18-meter parabolic dish antenna. The TDRSS control center also would be located at White Sands. Additionally, Canberra, Alaska, Goldstone, Rosman, and Madrid ground stations would provide orbital support. In 1974, NASA predicted that it would initially employ Delta 2914 launch vehicles for TDRSS, with Shuttle being used for future launches.

By September 1976, Western Union and RCA were competing for a Phase B TDRSS contract; their bids were due in December. Hughes was awarded the contract for the user antenna system, and other potential contractors competed for the contract for three multiplexer-demultiplexers for ground communications support. On December 12, NASA chose Western Union Space Communications, Inc., as the prime contractor for TDRSS. Subcontractors included TRW and the Electronics Systems Division of Harris, Inc. The fixed-price contract (\$79.6 million per year for 10 years) called for six spacecraft with components for a seventh, but no money would be forthcoming until the system was operational. That date had been pushed back to 1980, and the launch vehicle for the first two satellites had been changed to Atlas-Centaur, with all subsequent TDRSS launches to be handled by Shuttle.

For the next several years, the schedule and means for launching TDRSS, its escalating budget, a renewed debate over the lease-versus-buy issue, and Shuttle schedule delays combined to cast a shadow over the satellite tracking system. And the first launch, which would not occur until 1983, did not mark the end of the project's problems.

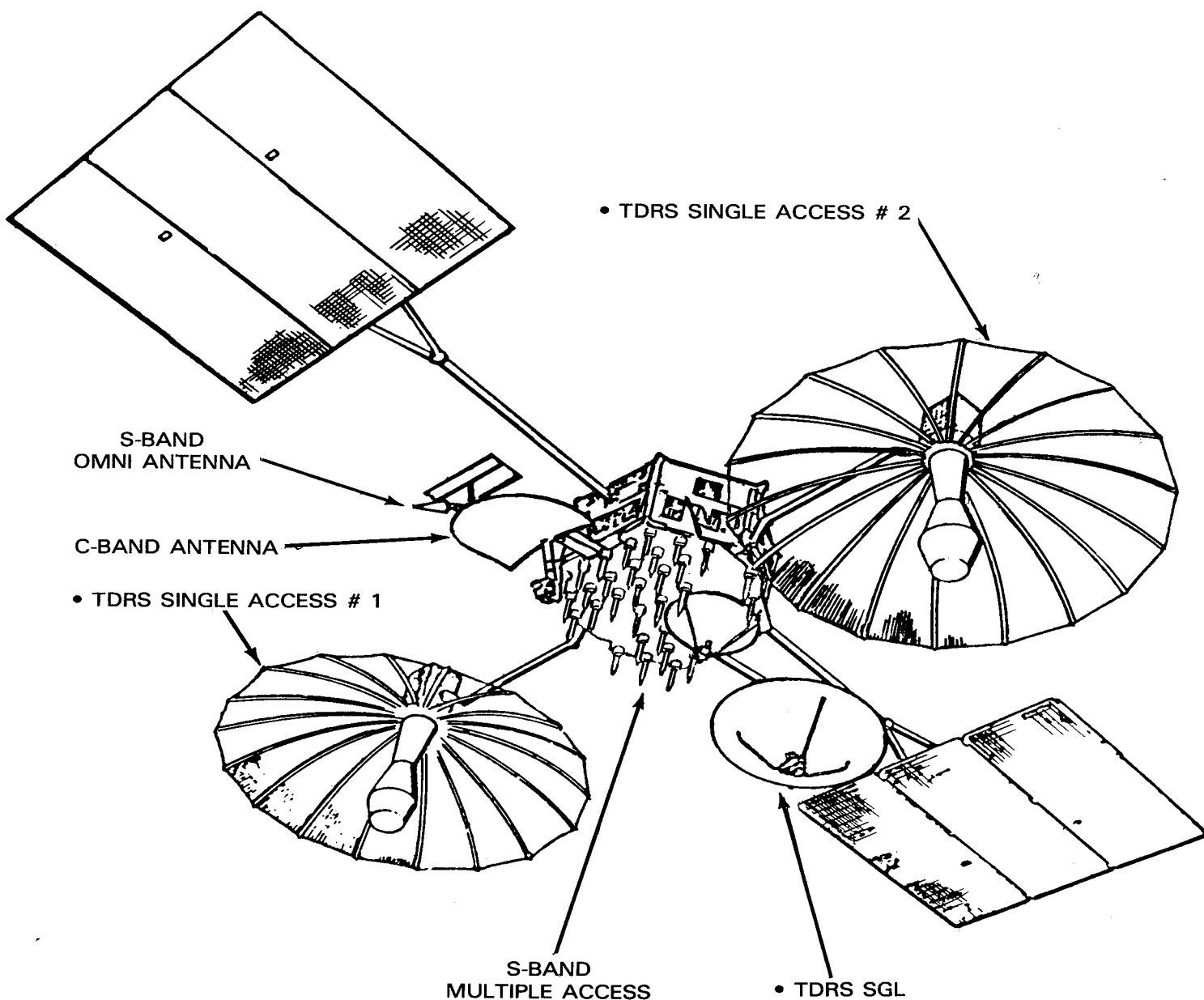

*Figure 6-8. Tracking and Data Relay Satellite TDRSS, which would be inserted into a geosynchronous orbit, was equipped with three-axis stabilization and monopropellant hydrazine thrusters. Its power was realized from two solar arrays ( $3.94 \times 3.62$  m) with NiCd battery storage. The 198 000-kg satellite had a hexagonal main body ( $2.4 \times 1.27$  m) and was equipped with two dual frequency S-band and K-band steerable 4.9-meter antennas, one C-band 1.47-meter fixed antenna, and one K-band space-ground link steerable 2-meter antenna. It had one 20-user S-band multiple access return channel and one time-shared S-band multiple access forwarding channel. The satellites were to last 5 to 10 years.*

Source: NASA Hq., "Fact Sheet, NASA's Tracking and Data Relay Satellite System," Release, 82-186, Dec. 1982.



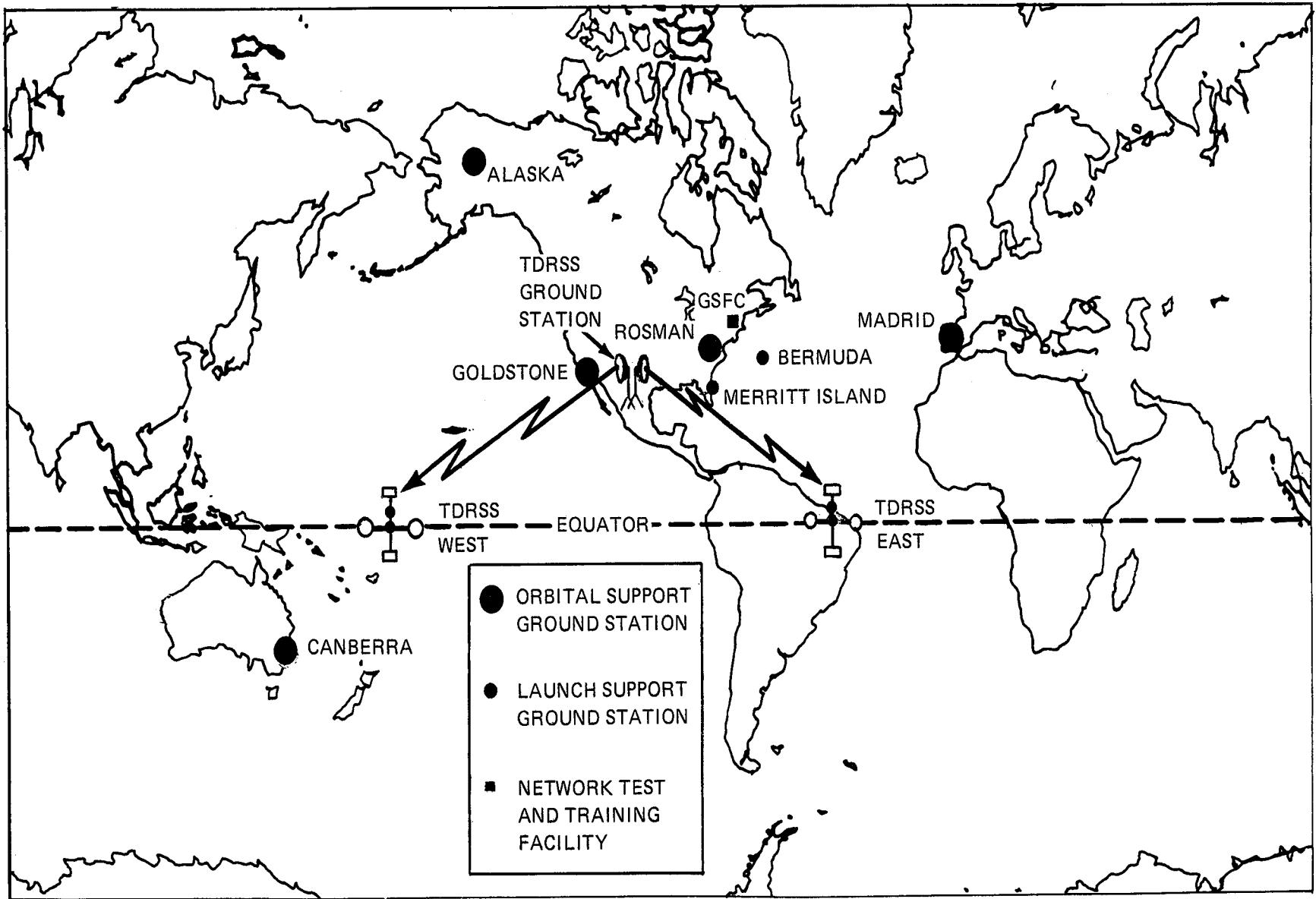

Figure 6-9. 1980 TDRSS Network

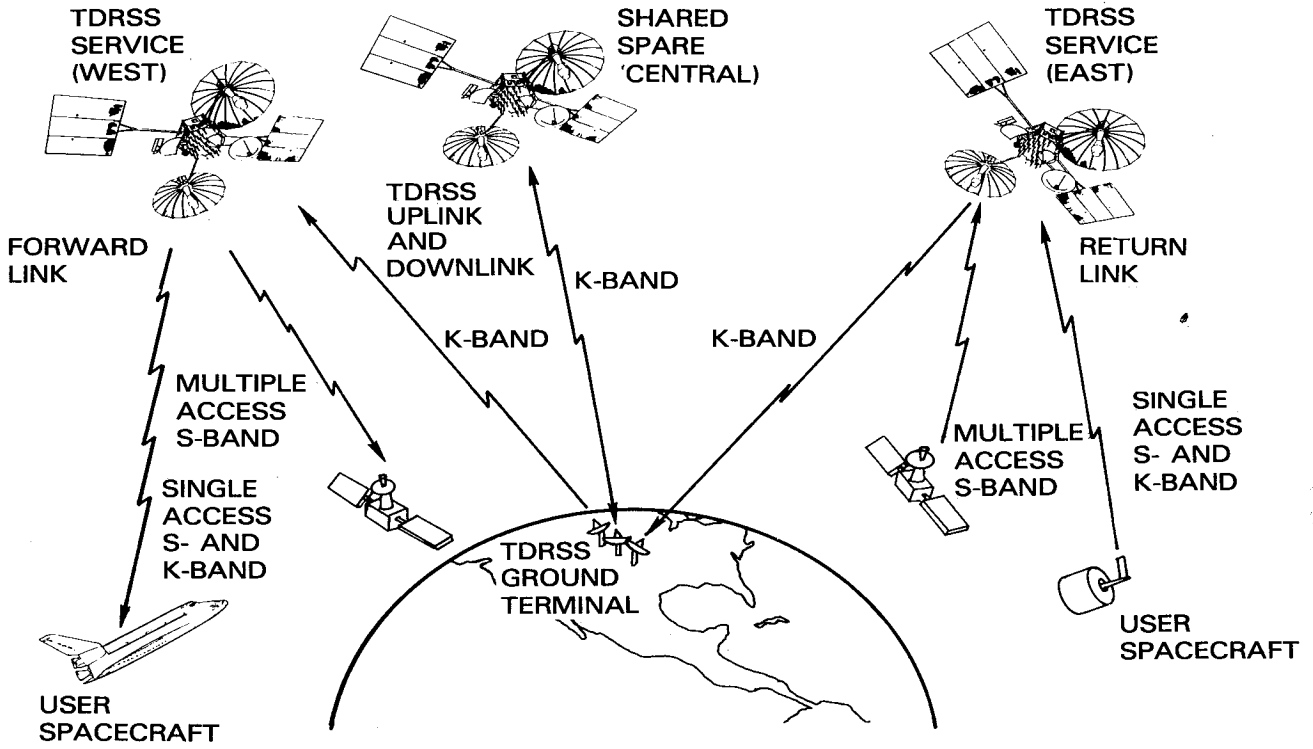

Figure 6-10. TDRSS Concept

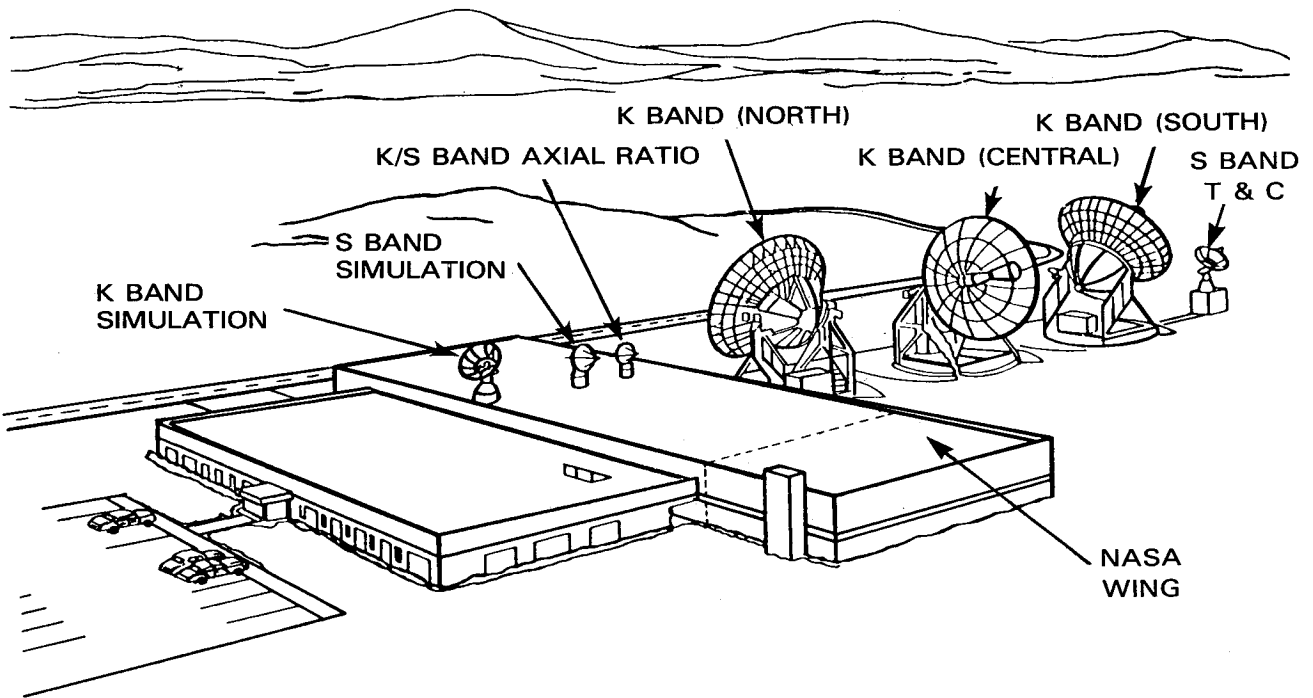

Figure 6-11. White Sands Ground Terminal.

# NOTES

## CHAPTER 1

1. NASA Policy Directive 8610.5, "Reimbursement for Launch Vehicles and Other Services Which Are Associated with Space Flights to Non-U.S. Government Users," Jan. 12, 1973.
2. William Hines, "Feast Over; NASA's Fiscal Famine Under Way," *Sunday Star* (Washington, D.C.), June 9, 1968.
3. For an overall look at each fiscal year, consult Executive Off. of the President, Off. of Management and Budget (OMB), *The United States Budget in Brief* (Washington, published each fiscal year).
4. Executive Off. of the President, OMB, *The United States Budget in Brief, Fiscal Year 1979* (Washington, 1978), pp. 74-75.
5. NASA, "Budget Estimates, Fiscal Year 1970," vol. 1, "Summary Data," 1969, pp. RD1, CF1, and RPM1.
6. The following letters are representative of the dialogue between NASA and BoB/OMB: James C. Fletcher to George P. Schultz, Sept. 30, 1971; Caspar W. Weinberger to Fletcher, July 21, 1972; Fletcher to James T. Lynn, Nov. 20, 1975; and Fletcher to Lynn, Nov. 26, 1975 (all located in the NASA History Off. Documents Collection, Washington, D.C.).
7. For further information on NASA's budget process, see Arnold Levine, *Managing NASA in the Apollo Era, 1963-1969*, NASA SP-4102 (Washington, 1983).
8. Space Task Group, "The Post-Apollo Space Program: Directions for the Future; Space Task Group Report to the President," Sept. 1969; see also NASA, "America's Next Decades in Space; A Report for the Space Task Group," Sept. 1969.
9. Marshall Space Flight Center, "Space Shuttle Solid Rocket Booster Fact Book," SA44-77-01, June 1977, p. 1.

## CHAPTER 2

1. "Manned vs Unmanned Argument Becoming Academic—Myers," *Space Daily*, Mar. 1, 1972, p. 5.
2. "NASA's Man for Manned Space Flight," *Aerospace Facts* (Thiokol Corp.) (July-Sept. 1974): 6-9.
3. NASA, *This Is NASA*, NASA EP-155 (Washington, 1979), p. 20; and Thomas O. Paine to Clinton P. Anderson, Nov. 21, 1969. Also see Loyd S. Swenson, Jr., James M. Grimwood, and Charles C. Alexander, *This New Ocean; A History of Project Mercury*, NASA SP-4201 (Washington, 1966), pp. 508,

- 643; Barton C. Hacker and Grimwood, *On the Shoulders of Titans; A History of Project Gemini*, NASA SP-4203 (Washington, 1977), pp. 173-75, 387-88, 581-82; and Courtney G. Brooks, Grimwood, and Swenson, *Chariots for Apollo: A History of Manned Lunar Spacecraft*, NASA SP-4205 (Washington, 1979), pp. 25, 110-11, 167-68.
4. For a one-volume summary, see JSC, "Apollo Program Summary Report," JSC-09423, Apr. 1975.
  5. For astronaut biographies and more information, see U.S. House of Representatives, Committee on Science and Technology, *Report, Astronauts and Cosmonauts, Biographical and Statistical Data*, 98th Cong., 1st sess. (Washington, 1983).
  6. W. David Compton and Charles D. Benson, *Living and Working in Space: A History of Skylab*, NASA SP-4208 (Washington, 1983), pp. 104-10.
  7. *Ibid.*, pp. 339-60.
  8. *Ibid.*, p. 347.
  9. Edward C. Ezell and Linda N. Ezell, *The Partnership: A History of the Apollo-Soyuz Test Project*, NASA SP-4209 (Washington, 1978), pp. 161-93.
  10. *Ibid.*, pp. 161-93.
  11. *Ibid.*, pp. 195-224. Also see JSC, "Apollo Soyuz Mission Evaluation Report," JSC-10607, pp. 4-1 through 4-4.
  12. Space Task Group, "The Post-Apollo Space Program: Directions for the Future; Space Task Group Report to the President," Sept. 1969, pp. 14-15; see also NASA, "America's Next Decade in Space; A Report for the Space Task Group," Sept. 1969.
  13. For details on the approach and landing tests, consult NASA, "Space Shuttle Orbiter Test Flight Series," Press Release 77-16, Feb. 4, 1977; and David Baker, "Evolution of the Space Shuttle; Approach and Landing Test Program," *Spaceflight* 19 (June 1977): 213-17; and Baker, "Evolution of the Space Shuttle; Free Flight Tests Begin," *Spaceflight* 20 (Jan. 1978): 21-40.

### CHAPTER 3

1. Space Task Group, "The Post-Apollo Space Program: Directions for the Future; Space Task Group to the President," Sept. 1969; see also NASA, "America's Next Decades in Space; A Report for the Space Task Group," Sept. 1969.
2. Homer E. Newell, *Beyond the Atmosphere: Early Years of Space Science*, NASA SP-4211 (Washington, 1980), pp. 287-95.
3. Office of the White House Press Secretary, White House Fact Sheet, "U.S. Civil Space Policy," Oct. 11, 1978, p. 1.
4. House of Representatives, Committee on Science and Technology, Subcommittee on Space Science and Applications, *United States Civilian Space Programs, 1958-1978, Report*, 97th Cong., 1st sess. (Washington, 1981), pp. 721-60.
5. Wallace H. Tucker, *The Star Splitters: The High Energy Astronomy Observatories*, NASA SP-466 (Washington, 1984), provides an overall history of HEAO and its fields of investigation.

6. NASA Hq., "OAO-B," Press Release 70-174, Oct. 29, 1970.
7. Subcommittee on Space Science and Applications, *United States Civilian Space Programs*, pp. 745-46.
8. *Ibid.*, pp. 747-48, 751.
9. For information on spacecraft design changes, see W. H. Follett, L. T. Ostwald, J. O. Simpson et al., "A Decade of Improvements to Orbiting Solar Observatories," n.d., 12 pp. Located in NASA History Office Documents Collection, Washington, D.C. An introduction to the follow-on series is provided by Robert R. Ropelewski, "OSO to Study Sun in Quiet Period," *Aviation Week and Space Technology* (July 26, 1970): 34-36.
10. Ezell, Edward C. and Linda N. Ezell, *On Mars: Exploration of the Red Planet, 1958-1978*, NASA SP-4212 (Washington, 1984), pp. 121-38.
11. *Ibid.*, 155-66, 434-46; and Subcommittee on Space Science and Applications, *United States Civilian Space Programs*, pp. 764-83.
12. James A. Dunne and Eric Burgess, *The Voyage of Mariner 10*, NASA SP-424 (Washington, 1977).
13. For a project history of Viking consult Ezell and Ezell, *On Mars*.
14. R. O. Fimmel, James Van Allen, and Eric Burgess, *Pioneer—First to Jupiter, Saturn, and Beyond*, NASA SP-446 (Washington, 1980.; "Pioneer Saturn" [Special Issue], *Science* 207 (Jan. 25, 1980): 400-53; and "Pioneer Saturn" [Special Issue], *Journal of Geophysical Research* 85 (Nov. 1, 1980): 5651-5958.
15. Subcommittee on Space Science and Applications, *United States Civilian Space Programs*, pp. 804-05.
16. For a discussion of NASA's life sciences program, see chapt. 16, Newell, *Beyond the Atmosphere*, pp. 274-82.
17. J. W. Dyer, ed., *Biosatellite Project Historical Summary Report* (Moffett Field, CA: Ames Research Center, 1969).

#### CHAPTER 4

1. NASA Hq. Press Release 69-76, "Space Applications Office Reorganized," May 15, 1969. John E. Naugle, associate administrator for space science and applications, made this remark two years before the official split between science and applications. From 1969 until the reorganization in 1971, OSSA underwent changes that made the eventual separation essentially a change on paper only; the two parts of OSSA had already begun functioning as separate entities.
2. "OSSA's R&D Tasks toward Seventies Stress Satellites for Serving Man," *Aerospace Management* (General Electric) 5 (May 1969): 73-79.
3. "The Post-Apollo Space Program: Directions for the Future," Sept. 1969, pp. i, iii, 6, 12.
4. House Committee on Science and Technology, Subcommittee on Space Science and Applications, *United States Civilian Space Programs, 1958-1978, Report*, 97th Cong., 1st sess. (Washington, 1981), pp. 1120-21.
5. "OSSA's R&D Tasks toward Seventies," pp. 73-79.
6. Memo, George M. Low to John W. Townsend, Jr., Mar. 16, 1972.
7. Harry Press and Wilbur B. Huston, "Nimbus: A Progress Report,"

- Astronautics & Aeronautics* (March 1968): 56-65; and Gerald L. Wick, "Nimbus Weather Satellites: Remote Soundings of the Atmosphere," *Science* (June 18, 1971): 51-53.
8. Charles Cote, Ralph Taylor, and Eugene Gilbert, eds., *Nimbus 6 Random Access Measurement System Applications Experiments*, NASA AP-457 (Washington, 1982).
  9. Gerald S. Schatz, "Global Weather Experiment," *News Report* (National Academy of Sciences, National Academy of Engineering, Institute of Medicine, National Research Council) 28 (Dec. 1978): 1, 6-7, 9-13; and "GATE, GARP, and the World Weather Program," *GATE News* (NOAA) (May 9, 1974).
  10. "Statement of Dr. John DeNoyer, Director of Earth Observations Programs, Office of Space Science and Applications, before the Committee on Science and Astronautics, House of Representatives" (Feb. 1970), pp. 14-15.
  11. Pamela E. Mack, "The Politics of Technological Change: A History of Landsat," unpublished doctoral dissertation, University of Pennsylvania, 1983, pp. 34-35.
  12. W. David Compton and Charles D. Benson, *Living and Working in Space: A History of Skylab*, NASA SP-4208 (Washington, 1983), pp. 182-96, 345-47.
  13. Mack, pp. 58-70, 99-106.
  14. Mack, chaps. 11-14, discusses the experiences of the user communities.

## CHAPTER 5

1. NASA, *Aeronautics and Space Report of the President, 1974 Activities* (Washington, 1976), p. 31.
2. NASA Steering Group, "Report on Closing of NASA ERC," Oct. 1, 1970; and NASA, *Astronautics and Aeronautics, 1970, Chronology on Science, Technology, and Policy*, NASA SP-4015 (Washington, 1972), p. 219.
3. NASA, *Aeronautics and Space Report of the President, 1978 Activities* (Washington, 1979), p. 33.
4. NASA Hq., "Research and Technology Office Reorganized," Press Release 70-183, Oct. 27, 1970.
5. George N. Chatham, "Toward a New National Policy for Aeronautics," *Astronautics & Aeronautics* (March 1970): 16-17.
6. Roy P. Jackson, "Spotlight on Aeronautics," speech, AIAA National Capital Section, Washington, D.C., March 2, 1972. Located in NASA History Office Documents Collection.
7. Jackson, "Remarks," speech, Conference on Aircraft Engine Noise Reduction, Cleveland, OH. Located in NASA History Off. Documents Collection.
8. Alan M. Lovelace, "NASA's Goal: Keeping the US Number One in Aeronautics," *Air Force Magazine* (Feb. 1976); 36-40.
9. James J. Kramer, "NASA Aeronautics FY 1978 Authorization Request, Statement," congressional testimony, Subcommittee on Transportation, Aviation and Weather, Committee on Science and Technology, House of Representatives, Feb. 16, 1977. Located in NASA History Off. Documents Collection.

10. NASA Hq., "NASA Establishes General Aviation Technology Office," Press Release 73-93, May 7, 1973.
11. NASA Hq., "General Aviation Technology Program," Press Release 76-51, March 1976.

## CHAPTER 6

1. For further information on tracking and data acquisition techniques, see Samuel Glasstone, *Sourcebook on the Space Sciences* (New York, et al.: D. Van Nostrand Co., Inc., 1965), pp. 217-39.
2. John T. Mengel and Paul Hergert, "Tracking Satellites by Radio," *Scientific American* 198 (Jan. 1958), deals specifically with the Minitrack system. See also Constance McLaughlin Green and Milton Lomask, *Vanguard: A History*, NASA SP-4202 (Washington, 1970), pp. 145-63.
3. William R. Corliss, "Histories of the Space Tracking and Data Acquisition Network (STADAN), the Manned Space Flight Network (MSFN), and the NASA Communications Network (NASCOM)," NASA CR-140390, June 1974, pp. 24-57, discusses the evolution of STADAN equipment. For information on communications and data handling operations and equipment, see Corliss, *Scientific Satellites*, NASA SP-133 (Washington, 1967), pp. 133-63.
4. For information on manned spaceflight tracking, communications, and data acquisition equipment, see Howard C. Kyle, "Manned Spaceflight Communications Systems," in A. V. Dalakrishnan, ed., *Advances in Communication Systems*, vol. 2 (New York: Academic Press, 1966), pp. 195-204; Loyd S. Swenson, Jr., James M. Grimwood, and Charles C. Alexander, *This New Ocean; A History of Project Mercury*, NASA SP-4201 (Washington, 1966), pp. 392-97; Corliss, "Histories of the Space Tracking and Data Acquisition Network (STADAN), the Manned Space Flight Network (MSFN), and the NASA Communications Network (NASCOM)," pp. 140-61; Barton C. Hacker and Grimwood, *On the Shoulders of Titans: A History of Project Gemini*, NASA SP-4203 (Washington, 1977), pp. 584-92; and JSC, "Apollo Program Summary Report," JSC-09423, Apr. 1975.
5. For information on the Deep Space Network, see Nichola A. Renzetti, ed., "A History of the Deep Space Network, from Inception to January 1, 1969," JPL Tech. Rept. 32-1533, vol. 1, Sept. 1, 1971; JPL, "DSIF: Goldstone," JPL Tech. Memo 33-205, 1965; and Corliss, "A History of the Deep Space Network," NASA CR-151915, May 1, 1976.
6. Edmond C. Buckley to George E. Mueller et al., "Data Relay Satellite System Requirements and Interface Panel," Sept. 1, 1967; and Gerald M. Truszynski to John F. Clark, "Data Relay Satellite System Studies," Dec. 3, 1968.
7. Richard L. Stock to record, "Senate Space Committee Inquiry Re: TDRSS," Sept. 7, 1973.
8. James C. Fletcher to Roy L. Ash, Sept 28, 1973; and Thomas V. Lucas to Robert Lottmann, "TDRSS Economic Benefit/Cost Analysis," Apr. 5, 1974.
9. Truszynski to record, "TDRSS Possible Bidders," Feb. 27, 1975; and Fletcher to record, "Selection of Contractor for Tracking and Data Relay Satellite System Services (TDRSS)," Feb. 1977.





APPENDIX A

**ORGANIZATION CHARTS**

PRECEDING PAGE BLANK NOT FILMED

# NATIONAL AERONAUTICS AND SPACE ADMINISTRATION

MAY 1, 1970

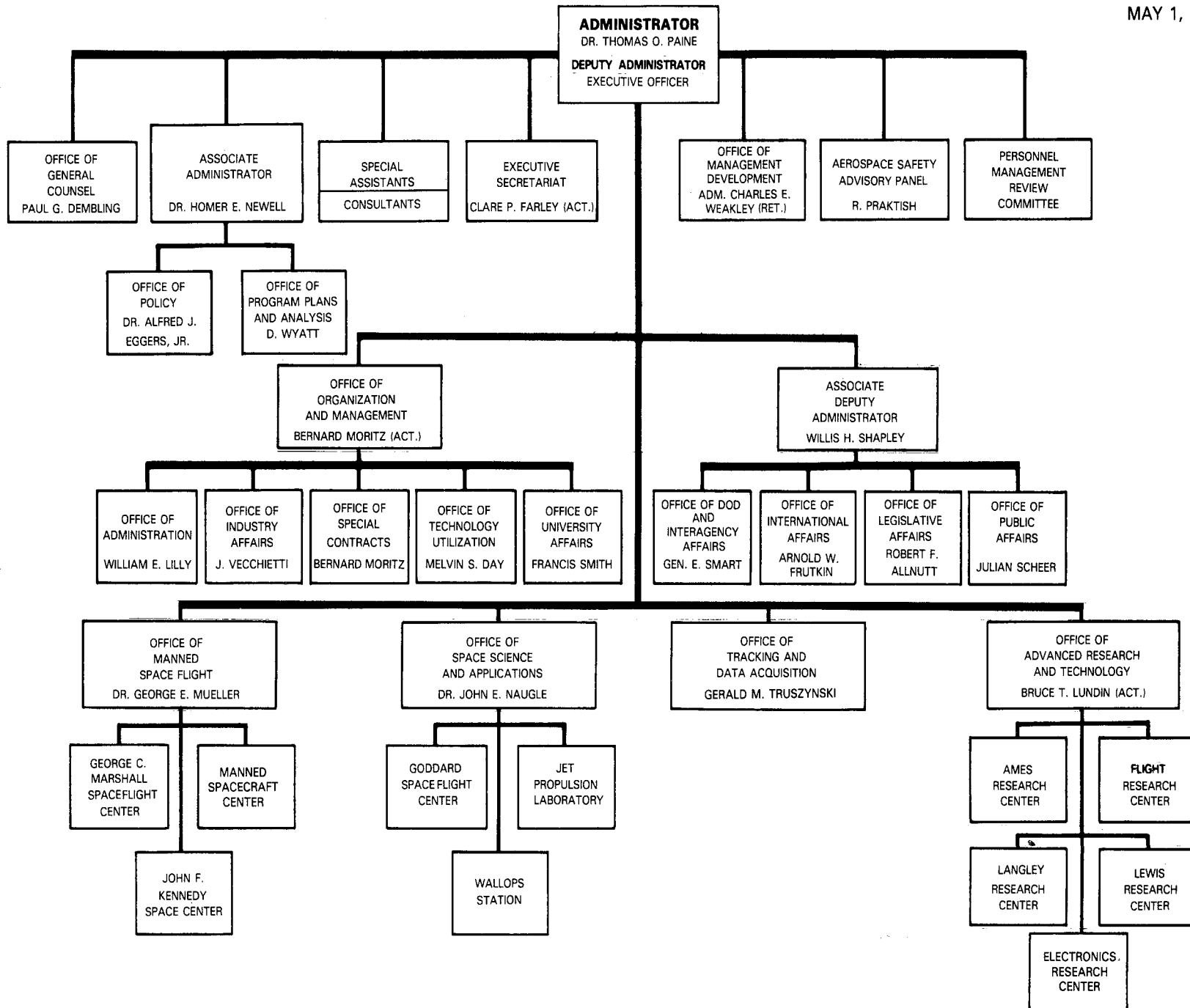

# NATIONAL AERONAUTICS AND SPACE ADMINISTRATION

DECEMBER 3, 1971

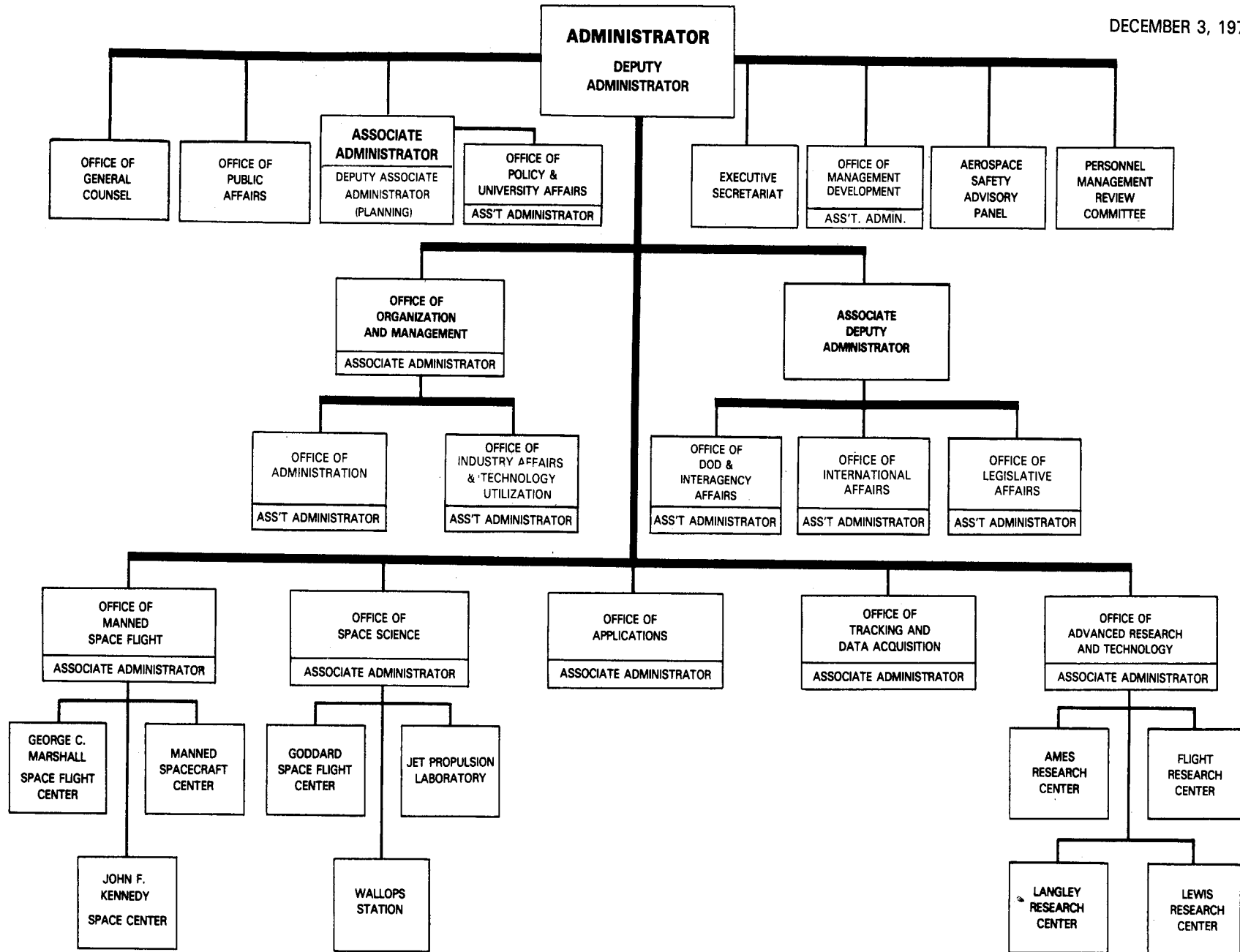

# NATIONAL AERONAUTICS AND SPACE ADMINISTRATION

FEBRUARY 5, 1973

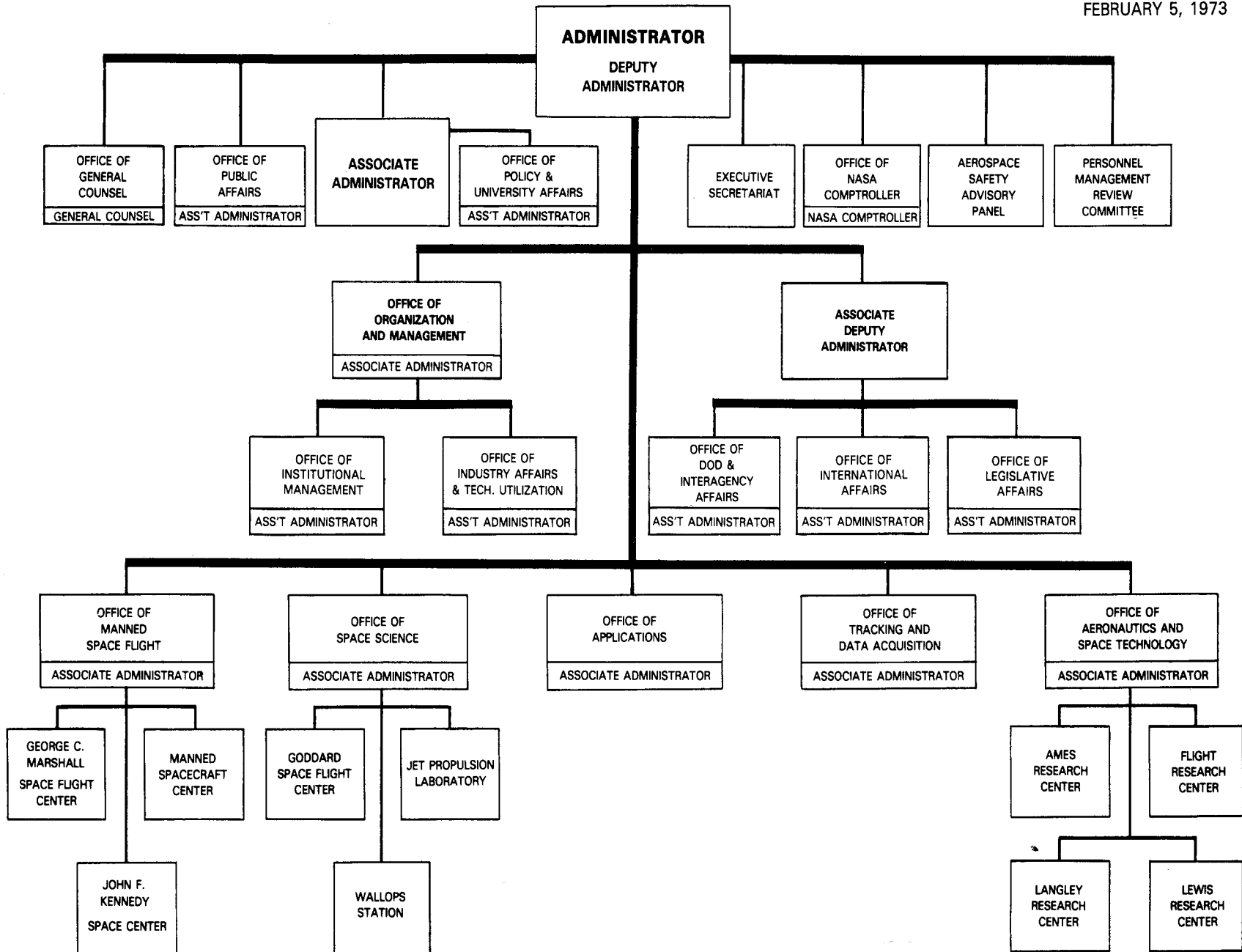

# NATIONAL AERONAUTICS AND SPACE ADMINISTRATION

MARCH 1975

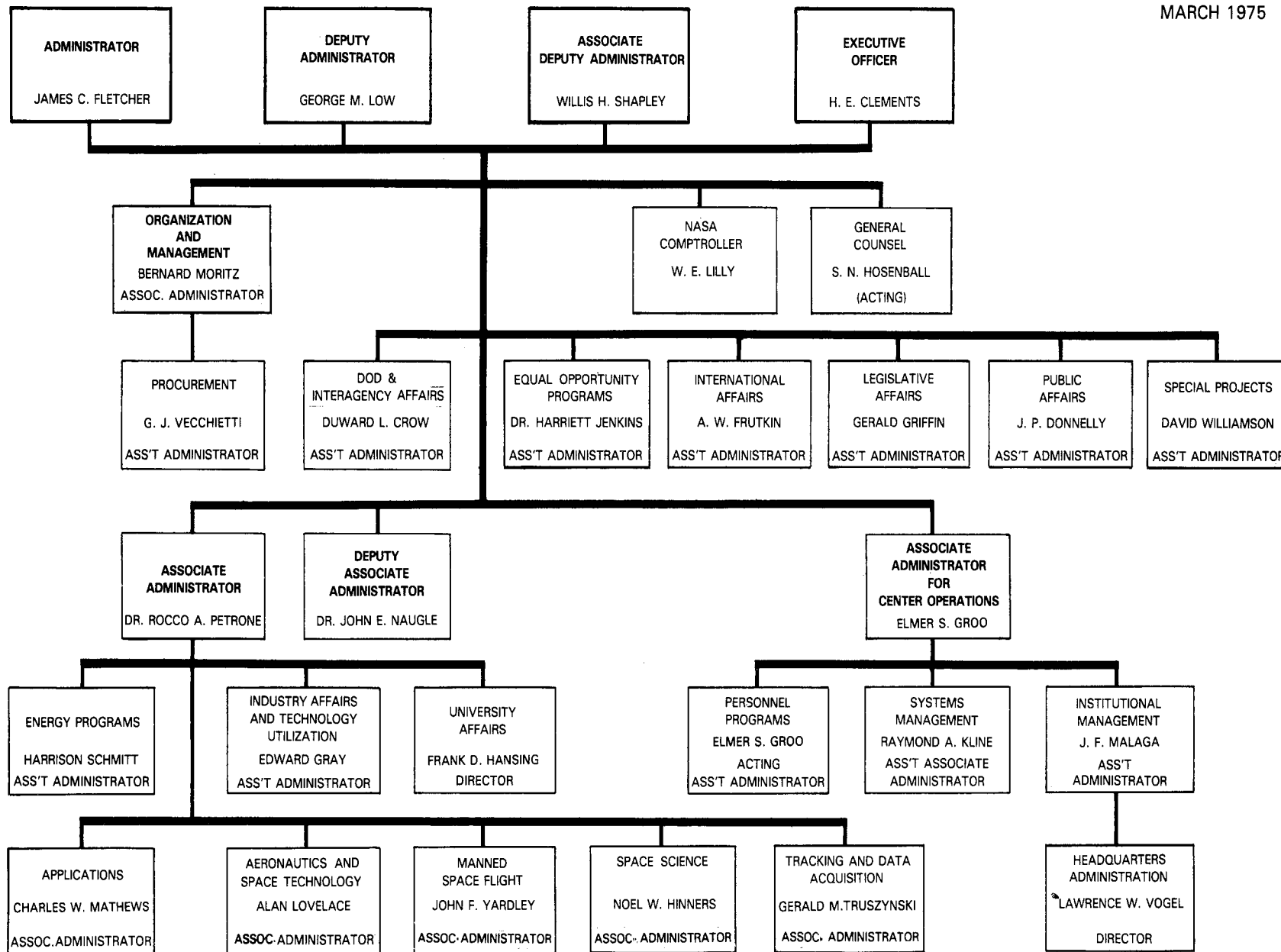

# NATIONAL AERONAUTICS AND SPACE ADMINISTRATION

MARCH 29, 1976

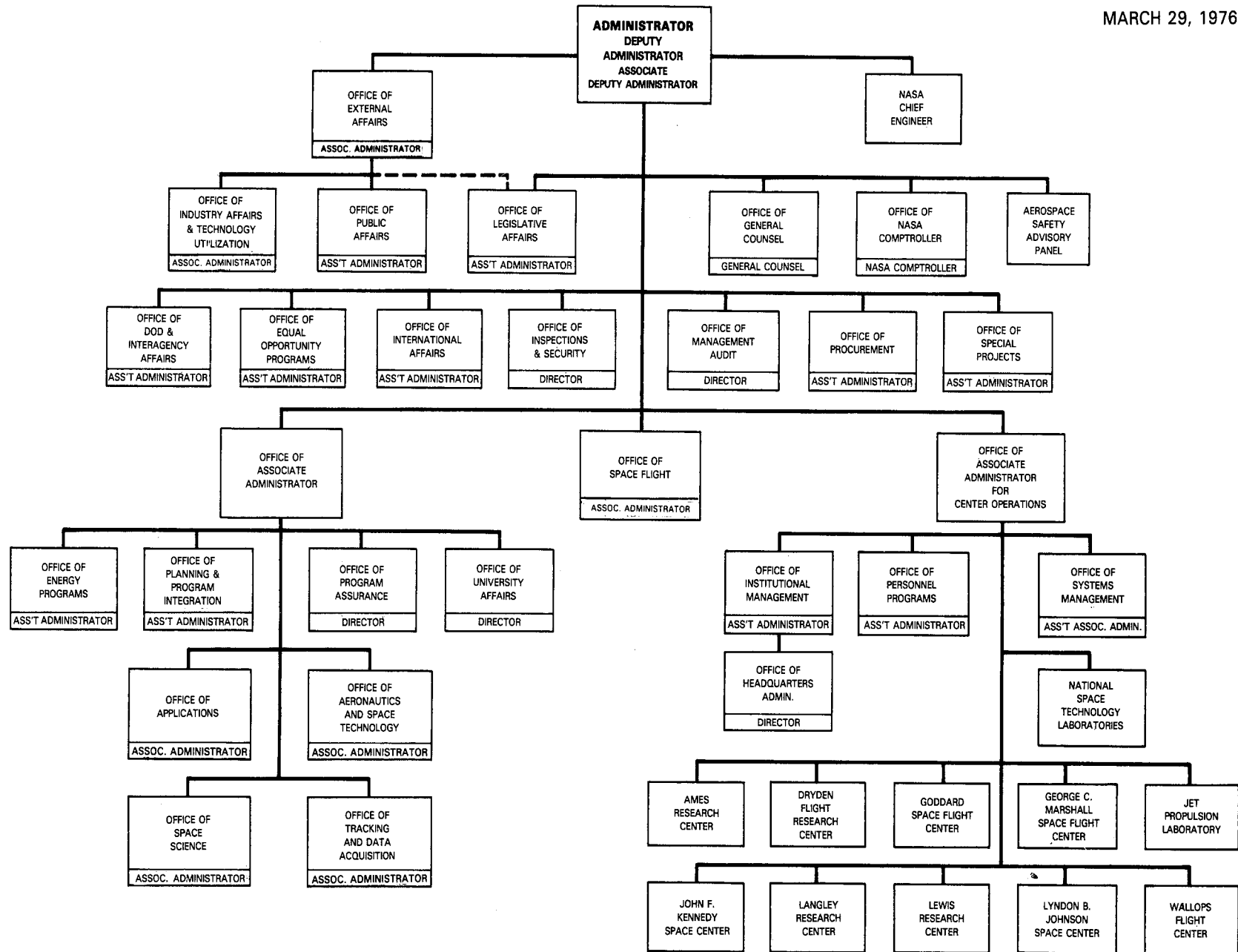

# NATIONAL AERONAUTICS AND SPACE ADMINISTRATION

OCTOBER 18, 1978

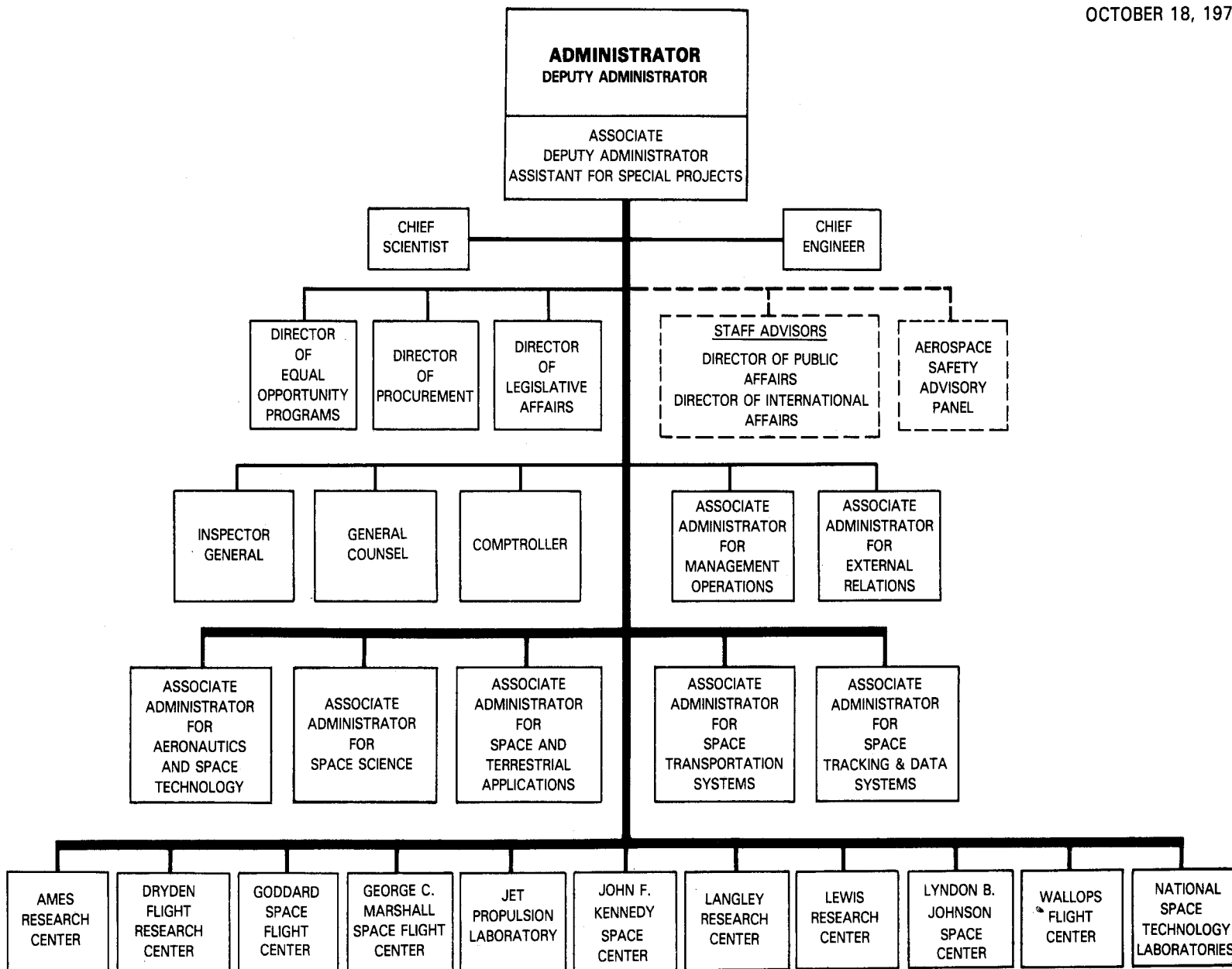





APPENDIX B

**SOUNDING ROCKET FLIGHTS,  
1969-1978**

PRECEDING PAGE BLANK NOT FILMED

## Sounding Rocket Flights, 1969-1978

Date of Launch	Site*	Experiment	Sounding Rocket	Scientific Requirements Met
1969				
1-10	WS	Planetary UV	Aerobee 150/150A	No
1-10	PB	Ozone	Nike Cajun	Yes
1-11	PB	Grenade	Nike Cajun	Yes
1-17	NOR	Ionospheres	Arcas	No
1-17	SWE	Grenade	Nike Cajun	Yes
1-17	WI	Grenade	Nike Cajun	Yes
1-18	NOR	Ionospheres	Arcas	Yes
1-19	PB	Grenade	Nike Cajun	Yes
1-19	SWE	Grenade	Nike Cajun	Yes
1-20	FC	Grenade	Nike Cajun	Yes
1-22	FC	Grenade	Nike Cajun	Yes
1-23	SWE	Grenade	Nike Cajun	Yes
1-24	WI	Grenade	Nike Cajun	Yes
1-25	SWE	Grenade	Nike Cajun	Yes
1-26	PB	Grenade	Nike Cajun	Yes
1-26	WI	Artificial Aurora	Aerobee 350	Yes
1-26	WI	Ionospheres	Nike Tomahawk	No
1-27	WI	Rocket Test	Arcas	Yes
1-28	WI	Stellar X-ray	Nike Tomahawk	No
1-30	FC	Grenade	Nike Cajun	Yes
1-31	WS	Stellar Spectra	Aerobee 150/150A	Yes
1-31	PB	Grenade	Nike Cajun	Yes
1-31	PB	Ozone	Nike Cajun	Yes
1-31	WI	Ionospheres	Nike Apache	Yes
1-31	WI	Ozone	Arcas	Yes
1-31	WI	Atm. Composition	Nike Apache	Yes
1-31	WI	Atm. Composition	Nike Apache	Yes
1-31	WI	Grenade	Nike Cajun	No
2-4	FC	Atm. Composition	Aerobee 150/150A	Yes
2-4	PB	Grenade	Nike Cajun	Yes
2-6	FC	Grenade	Nike Cajun	Yes
2-6	FC	Atm. Composition	Aerobee 150/150A	No
2-6	WI	Ionospheres	Nike Apache	Yes
2-6	WI	Ozone	Arcas	Yes
2-6	WI	Atm. Composition	Nike Apache	Yes
2-6	WI	Grenade	Nike Cajun	Yes
2-8	WS	Planetary UV	Aerobee 150/150A	No
2-8	FC	Ionospheres	Nike Apache	Yes
2-12	FC	Ionospheres	Nike Apache	Yes
2-12	FC	Airglow	Aerobee 150/150A	No
2-12	WS	Solar Studies	Aerobee 150/150A	No
2-13	WI	Lum. Cloud	Nike Tomahawk	Yes
2-14	WI	Lum. Cloud	Nike Apache	Yes
2-14	WI	Lum. Cloud	Nike Apache	Yes
2-14	WI	Lum. Cloud	Nike Apache	Yes
2-14	WI	Lum. Cloud	Nike Apache	Yes
2-14	WI	Lum. Cloud	Nike Apache	Yes
2-14	WI	Lum. Cloud	Nike Apache	Yes
2-17	FC	Ionospheres	Nike Apache	Yes
2-20	FC	Ionospheres	Nike Apache	No
2-27	FC	Auroral Studies	Nike Apache	Yes
2-28	WI	Black Brant III Test	Special Projects	Yes

## Sounding Rocket Flights, 1969-1978 (Continued)

Date of Launch	Site*	Experiment	Sounding Rocket	Scientific Requirements Met
1969				
3-3	WS	Cosmic Ray	Aerobee 150/150A	Yes
3-7	WS	Stellar Spectra	Aerobee 150/150A	Yes
3-7	NWT	Electric Fields	Nike Tomahawk	Yes
3-8	NWT	Electric Fields	Nike Tomahawk	Yes
3-9	NWT	Electric Fields	Nike Tomahawk	Yes
3-11	FC	Auroral Studies	Nike Tomahawk	Yes
3-14	WS	Stellar Studies	Aerobee 150/150A	Yes
3-14	WS	Stellar Spectra	Aerobee 150/150A	No
3-17	FBKS	Auroral Studies	Nike Tomahawk	Yes
3-28	SP	Grenade	Nike Cajun	Yes
3-28	WI	Grenade	Nike Cajun	Yes
3-29	SP	Grenade	Nike Cajun	Yes
3-29	WI	Grenade	Nike Cajun	Yes
4-8	WS	Solar Studies	Aerobee 150/150A	Yes
4-12	FC	SPICE	Nike Apache	Yes
4-13	FC	SPICE	Nike Apache	Yes
4-14	WS	Solar Studies	Aerobee 150/150A	Yes
4-14	FC	SPICE	Nike Apache	Yes
4-16	WS	Solar Studies	Aerobee 150/150A	Yes
4-17	FC	Auroral Studies	Nike Tomahawk	Yes
4-17	WS	Solar Studies	Aerobee 150/150A	Yes
4-17	WI	Ionospheres	Nike Apache	No
4-26	IND	X-ray Astronomy	Nike Apache	Yes
4-27	WS	Stellar X-ray	Aerobee 150/150A	Yes
4-28	IND	X-ray Astronomy	Nike Apache	Yes
5-1	WI	Black Brant III Test	Special Projects	Yes
5-8	SP	Grenade	Nike Cajun	Yes
5-8	WI	Grenade	Nike Cajun	Yes
5-10	SP	Grenade	Nike Cajun	Yes
5-10	WI	Grenade	Nike Cajun	Yes
5-12	WI	Ionospheres	Nike Apache	Yes
5-12	WI	Atm. Structure	Nike Apache	Yes
5-15	WI	Gravity Preference	Aerobee 150/150A	Yes
5-16	WS	Solar UV	Aerobee 150/150A	Yes
5-28	WS	Micrometeorite	Nike Apache	Yes
6-9	WS	Micrometeorite	Nike Apache	Yes
6-12	WI	System Test	Special Projects	Yes
6-13	WS	Airglow	Aerobee 150/150A	Yes
6-13	BRAZ.	Stellar X-ray	Aerobee 150/150A	Yes
6-20	WS	Stellar UV	Aerobee 150/150A	No
6-22	BRAZ.	Stellar X-ray	Aerobee 150/150A	No
6-26	BRAZ.	Ionospheres	Javelin	Yes
6-28	WI	Airglow	Nike Apache	Yes
7-16	WI	Stellar X-ray	Nike Tomahawk	No
8-13	WS	Micrometeorite	Nike Apache	Yes
8-21	WI	Atm. Composition	Nike Tomahawk	Yes
8-21	WI	Thermosphere Probe	Nike Tomahawk	Yes
8-21	WI	Atm. Structure	Nike Apache	Yes
8-22	WS	Micrometeorite	Nike Apache	Yes
9-5	WS	Solar Physics	Aerobee 150/150A	No
9-10	WS	Stellar Spectra	Aerobee 150/150A	No
9-10	WI	Ionospheres	Nike Apache	Yes

## Sounding Rocket Flights, 1969-1978 (Continued)

Date of Launch	Site*	Experiment	Sounding Rocket	Scientific Requirements Met
1969				
9-11	WS	Solar Studies	Aerobee 150/150A	Yes
9-12	WI	Ionospheres	Nike Apache	Yes
9-17	WS	Solar Studies	Aerobee 150/150A	Yes
9-19	BRAZ.	Energetic Particles	Black Brant VC	Yes
9-23	WS	Solar Studies	Aerobee 150/150A	Yes
9-24	WS	Solar Studies	Aerobee 150/150A	No
10-3	WS	Stellar X-ray	Aerobee 150/150A	Yes
10-4	WI	Stellar X-ray	Nike Tomahawk	Yes
10-10	RB	D-Region Ionospheres	Arcas	Yes
10-15	WI	Radio Astronomy	Astrobee 1500	Yes
10-16	WS	Stellar Spectra	Aerobee 150/150A	Yes
10-29	WI	Ion Composition	Arcas	No
11-4	WS	Solar Physics	Aerobee 150/150A	Yes
11-4	WS	Solar Physics	Aerobee 150/150A	Yes
12-5	WS	Stellar X-ray	Nike Apache	Yes
12-5	WS	Stellar X-ray	Aerobee 150/150A	Yes
12-13	WS	Stellar UV	Aerobee 150/150A	No
12-13	WI	Lum. Cloud	Nike Apache	Yes
12-14	WI	Lum. Cloud	Nike Apache	Yes
12-17	WS	Solar Studies	Aerobee 150/150A	Yes
1970				
1-2	IND	Ionospheres	Nike Apache	Yes
1-5	CRR	Grenade	Nike Cajun	Yes
1-5	WI	Grenade	Nike Cajun	Yes
1-10	WI	Grenade	Nike Cajun	Yes
1-10	PB	Grenade	Nike Cajun	Yes
1-13	CRR	Grenade	Nike Cajun	Yes
1-13	WI	Lum. Cloud	Nike Apache	No
1-13	CRR	Atm. Structure	Nike Apache	Yes
1-14	WI	Lum. Cloud	Nike Cajun	Yes
1-14	CRR	Grenade	Nike Cajun	Yes
1-14	WI	Lum. Cloud	Nike Apache	Yes
1-14	CRR	Auroral Studies	Nike Tomahawk	Yes
1-14	WI	Lum. Cloud	Nike Apache	Yes
1-14	WI	Lum. Cloud	Nike Apache	Yes
1-14	WI	Lum. Cloud	Nike Apache	Yes
1-14	WI	Lum. Cloud	Nike Apache	Yes
1-14	WI	Lum. Cloud	Nike Apache	Yes
1-14	WI	Grenade	Nike Apache	Yes
1-14	WI	Grenade	Nike Apache	Yes
1-14	WI	Grenade	Nike Cajun	Yes
1-16	CRR	Auroral Studies	Nike Tomahawk	No
1-16	WI	Ozone	Bullpup Cajun	No
1-16	WI	Ozone	Arcas	No
1-17	CRR	Auroral Studies	Nike Tomahawk	Yes
1-25	WS	UV Spectra	Aerobee 150/150A	Yes
1-29	PB	Grenade	Nike Cajun	Yes
1-29	PB	Grenade	Nike Cajun	Yes
2-3	PB	Grenade	Nike Cajun	Yes
2-3	PB	Grenade	Nike Cajun	Yes
2-3	NOR	Auroral Studies	Nike Tomahawk	Yes
2-4	CRR	Ionospheres	Nike Apache	No

## Sounding Rocket Flights, 1969-1978 (Continued)

Date of Launch	Site	Experiment	Sounding Rocket	Scientific Requirements Met
1970				
2-4	CRR	Auroral Studies	Nike Tomahawk	Yes
2-5	CRR	Auroral Studies	Nike Tomahawk	Yes
2-5	WI	Rocket & Instrumentation Test	Aerobee 170	Yes
2-7	WS	X-ray Spectra	Aerobee 150/150A	No
2-10	CRR	Magnetic Fields	Nike Tomahawk	Yes
2-10	CRR	Ionospheres	Nike Apache	No
2-14	WS	X-ray Spectra	Aerobee 170	Yes
2-18	CRR	Auroral Studies	Javelin	Yes
2-19	CRR	Auroral Studies	Nike Apache	Yes
2-24	CRR	Ionospheres	Arcas	Yes
2-28	CRR	Auroral Studies	Nike Apache	No
3-1	CRR	Ionospheres	Arcas	Yes
3-2	BI	Electric Fields	Nike Tomahawk	Yes
3-2	FB	Electric Fields	Nike Tomahawk	Yes
3-3	FB	Electric Fields	Nike Tomahawk	Yes
3-4	BI	Electric Fields	Nike Tomahawk	Yes
3-4	FB	Electric Fields	Nike Tomahawk	Yes
3-5	BI	Electric Fields	Nike Tomahawk	Yes
3-6	WI	Ozone	Nike Cajun	Yes
3-6	WI	Atm. Structure	Nike Apache	Yes
3-6	WI	Ionospheres	Nike Apache	No
3-6	WI	Atm. Structure	Arcas	Yes
3-7	WI	Atm. Structure	Arcas	Yes
3-7	WI	Ionospheres	Nike Apache	Yes
3-7	WI	Atm. Structure	Arcas	Yes
3-7	WI	Ozone	Nike Cajun	Yes
3-7	WI	Atm. Structure	Arcas	Yes
3-7	WI	Atm. Structure	Nike Apache	Yes
3-7	WI	Thermosphere Probe	Nike Tomahawk	Yes
3-7	WI	Solar Physics	Aerobee 170	No
3-7	WI	Solar Physics	Aerobee 150/150A	Yes
3-7	WI	Ionospheres	Nike Apache	Yes
3-7	WI	Ionospheres	Nike Apache	Yes
3-7	WI	Airglow	Nike Tomahawk	No
3-7	WI	Ionospheres	Nike Apache	Yes
3-7	WI	Ozone	Nike Cajun	No
3-7	WI	Ionospheres	Nike Apache	Yes
3-7	WI	Atm. Structure	Nike Apache	Yes
3-7	WI	Energetic Particles	Javelin	Yes
3-7	WS	Solar Studies	Aerobee 150/150A	Yes
3-7	WI	Atm. Structure	Arcas	Yes
3-7	WS	Solar Studies	Aerobee 150/150A	No
3-7	WI	Atm. Structure	Arcas	Yes
3-7	WS	Solar Studies	Aerobee 150/150A	Yes
3-7	WI	Atm. Structure	Arcas	Yes
3-8	NOR	Auroral Studies	Nike Tomahawk	Yes
3-8	WI	Atm. Structure	Nike Apache	Yes
3-8	WI	Grenade	Nike Cajun	No
3-8	WI	Atm. Structure	Arcas	No
3-8	WI	Atm. Structure	Arcas	Yes
3-9	IND	Ionospheres	Nike Tomahawk	Yes

## Sounding Rocket Flights, 1969-1978 (Continued)

Date of Launch	Site*	Experiment	Sounding Rocket	Scientific Requirements Met
1970				
3-9	IND	Ionospheres	Nike Tomahawk	Yes
3-9	IND	Ionospheres	Nike Tomahawk	Yes
3-14	WS	Stellar Studies	Aerobee 150/150A	No
3-19	IND	Ionospheres	Nike Apache	Yes
3-19	IND	Ionospheres	Nike Apache	Yes
3-19	IND	Ionospheres	Nike Apache	Yes
3-20	WS	Composition	Nike Cajun	No
3-26	CRR	Auroral Observations	Aerobee 150/150A	Yes
3-26	CRR	Airglow	Nike Tomahawk	Yes
3-27	IND	Mag. Fields, Ionospheres	Nike Apache	Yes
3-27	IND	Lower Ionosphere (Equatorial)	Arcas	Yes
3-27	IND	Lower Ionosphere (Equatorial)	Arcas	Yes
3-27	IND	Lower Ionosphere (Equatorial)	Arcas	Yes
3-27	IND	Lower Ionosphere (Equatorial)	Arcas	Yes
3-27	PAK	Grenade	Black Brant VC	Yes
3-28	PAK	Grenade	Black Brant IIIB	Yes
4-3	CRR	Auroral Studies	Javelin	Yes
4-11	CRR	Auroral Studies	Nike Tomahawk	Yes
4-13	WS	Airglow	Aerobee 150/150A	No
4-14	WS	Test, Stellar X-ray	Aerobee 350	No
4-16	CRR	Ionospheres	Arcas	Yes
4-16	CRR	Ionospheres	Nike Apache	No
4-28	CRR	Dust Particles	Aerobee 150/150A	Yes
5-1	CRR	Dust Particles	Aerobee 150/150A	Yes
5-8	WSMR	X-ray Studies	Aerobee 170	No
5-11	CRR	Atm. Composition	Aerobee 150/150A	Yes
5-14	PMR	Ozone	Arcas	No
5-26	AUST	UV Spectra	Aerobee 150/150A	No
5-29	AUST	X-ray Studies	Aerobee 150/150A	Yes
6-2	WSMR	Stellar Spectra	Aerobee 150/150A	Yes
6-2	WSMR	UV Spectra	Aerobee 150/150A	No
6-2	AUST	X-ray Studies	Aerobee 150/150A	Yes
6-18	PMR	Ozone	Arcas	Yes
6-22	WSMR	Solar Studies	Aerobee 150/150A	No
6-22	WI	Grenade	Nike Cajun	Yes
6-25	WI	Grenade	Nike Cajun	Yes
6-27	WSMR	X-ray Studies	Aerobee 170	Yes
6-27	WSMR	X-ray Studies	Nike Apache	Yes
7-2	WSMR	Far UV	Aerobee 150/150A	No
7-16	WI	Sporadic E	Nike Cajun	Yes
7-27	WSMR	Stellar Studies	Aerobee 150/150A	No
7-30	WI	Energetic Particles	Nike Tomahawk	No
8-3	WI	Atm. Structure	Nike Apache	Yes
8-8	WI	Noctilucent Cloud	Nike Apache	Yes
8-8	SWE	Noctilucent Cloud	Nike Apache	Yes
8-8	SWE	Noctilucent Cloud	Nike Apache	Yes
8-8	SWE	Noctilucent Cloud	Nike Apache	Yes
8-13	WI	Radiation Belt Studies	Aerobee 350	Yes

## Sounding Rocket Flights, 1969-1978 (Continued)

Date of Launch	Site*	Experiment	Sounding Rocket	Scientific Requirements Met
1970				
8-13	WSMR	Extreme UV Spectra	Aerobee 150/150A	Yes
8-22	WSMR	Stellar UV	Aerobee 170	No
8-28	WSMR	X-ray Studies	Nike Apache	Yes
9-1	WI	Helium Geocorona	Javelin	Yes
9-17	WI	Grenade	Nike Cajun	Yes
9-17	WI	Atm. Structure	Nike Apache	Yes
9-21	WI	Atm. Structure	Nike Cajun	Yes
9-22	WSMR	Airglow	Nike Apache	No
9-22	WSMR	X-ray Spectra	Aerobee 170	Yes
9-25	BRAZ	Energetic Particles	Black Brant IV	Yes
9-28	WSMR	X-ray Spectra	Aerobee 170	No
9-29	BRAZ	Energetic Particles	Black Brant IV	Yes
10-5	WI	Barium Ion Probe	Javelin	Yes
10-7	WI	Barium Release	Nike Tomahawk	Yes
10-10	PL	Ozone	Arcas	No
10-14	WI	Atm. Composition	Nike Cajun	Yes
10-17	PL	Ozone	Arcas	Yes
10-28	WSMR	Air Sample	Aerobee 150/150A	No
10-31	WSMR	Stellar UV	Aerobee 170	Yes
11-6	PN	Ozone	Arcas	Yes
11-10	FB	Auroral Studies	Nike Tomahawk	Yes
11-13	PN	Ozone	Arcas	Yes
11-13	NOR	Auroral Studies	Aerobee 170	Yes
11-18	FB	Auroral Studies	Nike Tomahawk	Yes
11-20	WSMR	Atm. Composition	Nike Apache	No
11-20	EGL	Atm. Structure	Nike Apache	Yes
11-24	WSMR	Solar X-ray	Aerobee 150/150A	Yes
12-2	WSMR	Stellar UV	Aerobee 150/150A	Yes
12-15	WI	Lum. Cloud	Nike Apache	Yes
12-15	WI	Lum. Cloud	Nike Apache	Yes
12-15	WI	Lum. Cloud	Nike Apache	Yes
12-15	WI	Lum. Cloud	Nike Apache	Yes
12-15	WI	Lum. Cloud	Nike Apache	Yes
12-17	WSMR	Atm. Composition	Nike Apache	Yes
12-19	WSMR	X-ray Studies	Aerobee 170	Yes
1971				
1-7	PB	Grenade	Nike Cajun	Yes
1-7	CRR	Grenade	Nike Cajun	Yes
1-7	WI	Grenade	Nike Cajun	Yes
1-12	PB	Grenade	Nike Cajun	Yes
1-12	WI	Grenade	Nike Cajun	Yes
1-13	WS	Composition	Nike Cajun	Yes
1-13	CRR	Grenade	Nike Cajun	Yes
1-22	NOR	Auroral Studies	Nike Tomahawk	Yes
1-24	WS	Stellar Spectra	Aerobee 150/150A	Yes
1-25	CRR	SPICE	Nike Apache	Yes
1-25	WS	Venus UV	Aerobee 150/150A	Yes
1-25	WS	Dawn Airglow	Aerobee 170	Yes
1-25	CRR	SPICE	Nike Apache	Yes

## Sounding Rocket Flights, 1969-1978 (Continued)

Date of Launch	Site*	Experiment	Sounding Rocket	Scientific Requirements Met
1971				
1-28	IND	Ionospheres Studies	Nike Apache	Yes
1-28	IND	Ionospheres Studies	Nike Apache	Yes
1-29	KE	Ion Composition	Nike Apache	Yes
1-29	WI	D-Region Ionospheres	Arcas	Yes
1-31	KE	Ionospheres	Nike Apache	Yes
2-8	WS	Airglow	Aerobee 170	Yes
2-14	FBKS	Auroral Studies	Nike Tomahawk	Yes
2-20	CRR	Ionospheres	Arcas	Yes
2-22	WI	X-ray Polarization	Aerobee 350	No
2-24	WS	Micrometeorite	Aerobee 150/150A	Yes
2-24	Hawaii	Ozone	Arcas	Yes
3-1	WS	Stellar UV	Aerobee 170	Yes
3-3	CRR	Ionospheres	Arcas	Yes
3-3	Hawaii	Ozone	Arcas	Yes
3-5	GU	Launcher Compatibility	Special Projects	Yes
3-5	Hawaii	Ozone	Arcas	Yes
3-10	WI	Grenade	Nike Cajun	Yes
3-10	WI	Lum. Cloud	Nike Apache	Yes
3-10	WI	Lum. Cloud	Nike Apache	Yes
3-10	WI	Lum. Cloud	Nike Apache	Yes
3-10	WI	Grenade	Nike Cajun	Yes
3-13	WS	Airglow	Nike Apache	No
3-15	GU	Ozone	Nike Cajun	Yes
3-15	FM	Electric Fields	Nike Tomahawk	Yes
3-15	PM	Electric Fields	Nike Tomahawk	Yes
3-16	FBKS	Auroral Studies	Nike Tomahawk	No
3-16	GU	Ozone	Nike Cajun	Yes
3-17	FBKS	Auroral Studies	Nike Tomahawk	Yes
3-18	FM	Electric Fields	Nike Tomahawk	Yes
3-18	GU	Grenade	Nike Cajun	Yes
3-19	FM	Electric Fields	Nike Tomahawk	Yes
3-19	FBKS	Auroral Studies	Nike Tomahawk	No
3-19	FM	Magnetic Fields	Nike Tomahawk	Yes
3-20	FM	Electric Fields	Nike Tomahawk	Yes
3-20	WS	Soft X-ray	Aerobee 170	No
3-21	FM	Electric Fields	Nike Tomahawk	Yes
3-21	FBKS	Auroral Studies	Nike Tomahawk	Yes
3-22	FM	Magnetic Fields	Nike Tomahawk	Yes
3-31	CRR	Auroral Studies	Nike Tomahawk	Yes
4-19	IND	Lum. Cloud	Nike Apache	Yes
4-23	WS	Airglow	Nike Apache	Yes
4-23	WS	Micrometeorites	Nike Apache	Yes
4-25	IND	Ionosphere Studies	Nike Apache	Yes
4-25	IND	Lum. Cloud	Nike Apache	No
4-26	SP	Lum. Cloud	Nike Cajun	Yes
4-26	SP	Lum. Cloud	Nike Cajun	Yes
4-26	SP	Lum. Cloud	Nike Cajun	Yes
4-26	SP	Lum. Cloud	Nike Cajun	Yes
4-29	WS	Solar X-ray	Aerobee 170	Yes
4-30	IND	Ionosphere Studies	Nike Apache	Yes
5-1	WS	Stellar UV	Aerobee 150/150A	Yes
5-1	WS	Stellar X-ray	Aerobee 170	Yes





## Sounding Rocket Flights, 1969-1978 (Continued)

Date of Launch	Site*	Experiment	Sounding Rocket	Scientific Requirements Met
1971				
9-20	FGU	Grenade	Nike Cajun	Yes
9-21	FGU	Grenade	Nike Cajun	Yes
9-21	FGU	Grenade	Nike Cajun	Yes
9-21	FGU	Grenade	Nike Cajun	Yes
9-21	FGU	Grenade	Nike Cajun	Yes
9-21	FGU	Grenade	Nike Cajun	Yes
9-21	FGU	Grenade	Nike Cajun	Yes
9-21	FGU	Grenade	Nike Cajun	Yes
9-22	FGU	Grenade	Nike Cajun	Yes
10-13	WS	Ionospherics	Nike Cajun	Yes
10-13	WS	Ionospherics	Nike Cajun	Yes
10-13	WS	D-Region Studies	Arcas	Yes
10-19	WS	Test & Support	Aerobee 170	Yes
10-23	WS	Soft X-ray Astronomy	Aerobee 170	Yes
10-27	WS	Stellar Spectra	Aerobee 170	No
11-17	Kenya	Stellar Astronomy	Nike Tomahawk	Yes
11-20	WS	Stellar UV	Aerobee 170	Yes
11-20	WS	Stellar UV	Aerobee 170	No
12-6	PB	Pitot Tube	Nike Apache	Yes
12-6	PB	Grenade	Nike Cajun	Yes
12-6	PB	Pitot Tube	Nike Apache	Yes
12-6	PB	Pitot Tube	Nike Apache	Yes
12-6	PB	Pitot Tube	Nike Apache	Yes
12-6	PB	Grenade	Nike Cajun	Yes
12-6	PB	Atomic Oxygen	Nike Cajun	Yes
12-6	PB	Ozone	Nike Cajun	Yes
1972				
1-6	WI	Ionospherics	Arcas	Yes
1-12	NOR	Energetic Particles	Nike Apache	Yes
1-13	NOR	Particles & Fields	Nike Tomahawk	Yes
1-15	FC	Ionospherics	Arcas	Yes
1-15	FC	Ionospherics	Arcas	Yes
1-27	WI	Perf. Test Flight	Black Brant VC	Yes
1-28	WSMR	Aeronomy	Nike Apache	No
1-31	WI	Ionospherics	Arcas	Yes
1-31	WI	Ionospherics	Nike Apache	Yes
2-2	FBKS	Auroral Part. & Field	Nike Tomahawk	Yes
2-7	SWE	Auroral Aeronomy	Nike Tomahawk	Yes
2-10	WI	Energetic Part.	Javelin	Yes
2-14	NOR	Auroral Energetic	Nike Tomahawk	Yes
2-15	FC	Aeronomy	Nike Apache	Yes
2-19	WSMR	X-ray Astronomy	Aerobee 170	Yes
2-25	FBKS	Auroral Part.	Nike Tomahawk	Yes
3-7	FBKS	Fields & Neutral Wind	Nike Tomahawk	Yes
3-7	FBKS	Fields & Neutral Wind	Nike Tomahawk	Yes
3-9	FBKS	Fields & Neutral Wind	Nike Tomahawk	Yes
3-9	WI	Energetic Part.	Nike Tomahawk	No
3-17	FC	Auroral Studies	Aerobee 150/150A	Yes
3-31	FC	Auroral Aeronomy	Aerobee 150/150A	Yes
4-1	WSMR	X-ray Astronomy	Aerobee 170	Yes

## Sounding Rocket Flights, 1969-1978 (Continued)

Date of Launch	Site*	Experiment	Sounding Rocket	Scientific Requirements Met
1972				
4-7	IN	Langmuir Probe	Nike Apache	Yes
4-21	WSMR	Aeronomy	Aerobee 150/150A	No
4-24	WSMR	Solar Physics	Aerobee 170	Yes
5-4	WI	Meteorology	Arcas	Yes
5-12	WSMR	Astronomy	Aerobee 170	Yes
5-16	ANT	Meteorology	Arcas	Yes
5-17	PB	Meteorology	Nike Cajun	Yes
5-17	PB	Meteorology	Nike Cajun	Yes
5-17	PB	Meteorology	Nike Cajun	Yes
5-17	PB	Meteorology	Nike Cajun	Yes
5-19	WSMR	X-ray Astronomy	Aerobee 170	Yes
5-19	WSMR	Cosmic X-ray	Aerobee 170	Yes
5-23	ANT	Meteorology	Arcas	Yes
5-31	NOR	Ionospherics	Nike Cajun	Yes
5-31	NOR	Ionospherics	Nike Apache	Yes
5-31	WSMR	Solar UV Spec.	Black Brant VC	No
6-9	WSMR	Astronomy	Aerobee 170	Yes
6-9	WSMR	Galactic Astronomy	Black Brant VC	Yes
6-9	WSMR	Galactic Astronomy	Nike Apache	Yes
6-13	WSMR	Solar Physics	Aerobee 170	No
6-21	WSMR	Comp. & Photo	Aerobee 150/150A	Yes
6-27	WSMR	Solar Physics	Aerobee 170	Yes
7-3	SP	Ionospherics	Nike Apache	Yes
7-6	SP	Ionospherics	Nike Cajun	Yes
7-10	WSMR	Solar Physics	Aerobee 170	No
7-10	WSMR	Solar Physics	Aerobee 170	Yes
7-14	WSMR	Astronomy	Aerobee 170	Yes
7-27	WSMR	Solar Physics	Aerobee 170	Yes
8-4	FC	Eng. & Particles	Nike Apache	Yes
8-4	FC	Eng. & Particles	Nike Apache	No
8-5	WSMR	Astronomy	Aerobee 170	No
8-10	WSMR	Ast., Soft X-ray	Aerobee 170	No
8-10	WSMR	Astronomy	Aerobee 170	Yes
9-1	WSMR	Aeronomy	Aerobee 170	Yes
9-12	FC	Part. & Fields	Javelin	No
9-16	WSMR	Astronomy	Aerobee 170	Yes
9-25	FC	Fields & Part.	Black Brant VC	Yes
9-26	WI	Flight Perf.	Special Projects	Yes
10-8	SWE	Aeronomy	Nike Apache	Yes
10-9	SWE	Aeronomy	Nike Apache	Yes
10-12	SWE	Aeronomy	Nike Apache	Yes
10-13	FBKS	Planetary Atmos.	Nike Apache	No
10-13	FBKS	Planetary Atmos.	Nike Apache	Yes
10-13	FBKS	Planetary Atmos.	Nike Apache	Yes
10-15	Hawaii	Artificial Aurora	Special Projects	Yes
10-21	FBKS	Auroral Studies	Nike Tomahawk	No
10-24	WSMR	Skylab Cong.	Black Brant VC	Yes
10-30	WSMR	Solar Physics	Aerobee 170	No
11-1	WI	Ionospherics	Arcas	Yes
11-1	WI	Energetic Elect.	Nike Apache	Yes
11-2	FC	Ionospherics Physics	Arcas	Yes

## Sounding Rocket Flights, 1969-1978 (Continued)

Date of Launch	Site*	Experiment	Sounding Rocket	Scientific Requirements Met
1972				
11-2	FC	Ionospheric Physics	Black Brant VC	No
11-4	WSMR	Aeronomy	Nike Apache	Yes
11-8	WSMR	Spectro. of Spectrum	Aerobee 170	Yes
11-14	WSMR	Solar Physics	Aerobee 170	Yes
11-20	WSMR	Rocket Test Flight	Aerobee 200	Yes
12-5	WI	Ionospheric	Arcas	Yes
12-5	WI	Ionospheric	Nike Apache	Yes
12-8	WSMR	Soft X-ray	Aerobee 170	Yes
12-11	WSMR	Meas. Sun Brightness	Aerobee 170	No
12-13	WSMR	Solar UV Measurement	Aerobee 170	Yes
1973				
1-16	WI	Ionosphere	Nike Apache	Yes
1-16	WI	Ele. Density & Coll.	Arcas	Yes
1-16	NOR	Energetic Particles	Nike Tomahawk	Yes
1-18	WSMR	Solar Physics	Aerobee 200	Yes
1-22	WSMR	Skylab/CALROC Test	Black Brant VC	Yes
1-27	NOR	Proton 2	Nike Tomahawk	Yes
2-2	CRR	Ionospheric Physics	Arcas	No
2-2	CRR	Ionospheric Physics	Arcas	Yes
2-6	NOR	Particles & Field	Nike Tomahawk	Yes
2-9	SWE	Aeronomy-Auroral	Nike Tomahawk	Yes
2-10	WSMR	Galactic X-ray	Black Brant VC	Yes
2-28	CRR	Aeronomy	Aerobee 150/150A	Yes
3-1	CRR	Aurora Studies	Nike Apache	Yes
3-5	WSMR	Solar UV	Aerobee 170	Yes
3-5	WSMR	Ionospheric Physics	Nike Apache	No
3-8	WSMR	Solar Physics	Aerobee 170	Yes
3-16	FBKS	Auroral Studies	Nike Tomahawk	Yes
3-21	FBKS	Electric Field	Nike Tomahawk	Yes
3-22	FBKS	Electric Field	Nike Tomahawk	Yes
3-24	WSMR	Map. Ext. X-ray	Aerobee 170	Yes
3-27	FBKS	Electric Field	Nike Tomahawk	Yes
3-30	WSMR	X-ray Astronomy	Aerobee 170	Yes
3-30	FBKS	Electric Field	Nike Tomahawk	Yes
3-31	FBKS	Electric Field	Nike Tomahawk	Yes
4-3	WSMR	Skylab/CALROC	Black Brant VC	No
4-10	WSMR	Astronomy	Aerobee 170	Yes
5-19	WSMR	CALROC Test	Black Brant VC	Yes
5-23	WSMR	Aeronomy	Aerobee 150/150A	Yes
5-25	WSMR	Stellar UV	Aerobee 170	Yes
6-2	WSMR	Solar Physics	Aerobee 170	Yes
6-4	WSMR	Skylab/CALROC	Black Brant VC	No
6-6	WSMR	Solar Physics	Aerobee 200	Yes
6-13	WSMR	Skylab/CALROC	Black Brant VC	Yes
6-30	WI	Ionosphere	Nike Cajun	Yes
6-30	WI	Ionosphere	Nike Apache	Yes
6-30	WI	Ionospheric Physics	Astrobee D	No
7-2	WSMR	X-ray Astronomy	Aerobee 170	Yes
7-17	WI	Meteorology	Nike Cajun	Yes

## Sounding Rocket Flights, 1969-1978 (Continued)

Date of Launch	Site*	Experiment	Sounding Rocket	Scientific Requirements Met
1973				
7-17	WI	Meteorology	Nike Cajun	Yes
7-17	WI	Aeronomy	Javelin	Yes
7-18	WI	Meteorology	Nike Cajun	Yes
7-18	WI	Meteorology	Nike Cajun	Yes
7-25	WSMR	Heat Pipe	Aerobee 200	Yes
7-25	WSMR	Rail Rocket Test	Aerobee 200	No
7-28	WSMR	Aeronomy	Nike Tomahawk	No
8-1	SWE	Aeronomy	Nike Apache	Yes
8-1	SWE	Aeronomy	Nike Apache	Yes
8-2	SWE	Ionospheric Physics	Nike Cajun	Yes
8-3	WI	Ionosphere	Nike Apache	Yes
8-5	SWE	Ionosphere	Nike Apache	Yes
8-6	SWE	Aeronomy	Nike Apache	Yes
8-9	WSMR	Skylab/CALROC	Black Brant VC	Yes
8-9	WI	USAF Test	Black Brant IV	Yes
8-10	WI	Ionosphere	Nike Apache	Yes
8-14	WSMR	Aeronomy	Nike Apache	Yes
8-16	ANT	Meteorology	Arcas	No
8-16	ANT	Meteorology	Arcas	No
8-23	WSMR	Astronomy	Aerobee 200	No
8-30	WSMR	Solar Physics	Black Brant VC	Yes
9-4	WSMR	Skylab/CALROC	Black Brant VC	Yes
9-13	WSMR	Solar Physics	Aerobee 170	Yes
9-19	ANT	Meteorology	Arcas	Yes
9-21	WSMR	Solar Physics	Aerobee 200	Yes
10-4	WSMR	Cosmic X-ray	Aerobee 170	Yes
10-19	ANT	Meteorology	Arcas	No
10-24	WSMR	Planetary Atmosphere	Aerobee 200	Yes
11-1	AUST	Galactic Astronomy	Aerobee 170	Yes
11-1	AUST	Astronomy	Aerobee 170	Yes
11-6	AUST	Astronomy	Aerobee 170	Yes
11-9	AUST	Astronomy	Aerobee 170	Yes
11-9	AUST	Astronomy	Aerobee 170	Yes
11-12	AUST	Astronomy	Aerobee 170	Yes
11-12	AUST	Astronomy	Aerobee 170	Yes
11-18	BRAZ	Ionosphere	Javelin	Yes
11-22	BRAZ	Ionosphere	Javelin	Yes
11-23	WSMR	Solar Physics	Aerobee 200	No
11-23	ANT	Meteorology	Arcas	No
11-27	FBKS	Aeronomy	Black Brant IV	Yes
12-4	FBKS	Aeronomy	Black Brant IV	Yes
12-10	WSMR	Skylab/CALROC	Black Brant VC	Yes
12-19	WSMR	Catura/LMSC	Aerobee 200	Yes
1974				
1-5	WS	Comet Kohoutek	Aerobee 200	Yes
1-8	WS	Comet Kohoutek	Aerobee 200	Yes
1-13	WS	Comet Kohoutek	Aerobee 200	No
1-15	WS	Skylab Support	Black Brant VC	Yes
1-16	WI	Ion & Electrons	Nike Apache	Yes

## Sounding Rocket Flights, 1969-1978 (Continued)

Date of Launch	Site*	Experiment	Sounding Rocket	Scientific Requirements Met
1974				
1-16	WI	Positive Ions	Arcas	Yes
1-16	WS	Solar Physics	Aerobee 200	No
1-17	FB	Barium Release	Nike Tomahawk	Yes
1-21	FB	Barium Release	Nike Tomahawk	Yes
1-22	FB	Barium Release	Nike Tomahawk	Yes
1-22	WS	Solar Physics	Aerobee 200	Yes
1-27	NOR	Mag. Physics	Nike Tomahawk	Yes
1-31	ANT	Meteorology	Arcas	Yes
2-9	WS	Astronomy	Aerobee 200	Yes
2-12	WS	Astronomy	Aerobee 200	Yes
2-20	SWE	Mag. Physics	Nike Tomahawk	Yes
2-20	SWE	Mag. Physics	Nike Tomahawk	Yes
2-22	CRR	Nitric Oxide	Nike Apache	Yes
2-26	WS	Solar Physics	Black Brant VC	No
3-1	CRR	Aeronomy	Nike Apache	No
3-2	CRR	Nitric Oxide	Nike Apache	Yes
3-5	CRR	Aeronomy	Nike Apache	No
3-10	FBKS	Auroral	Nike Tomahawk	Yes
3-16	WS	Astronomy	Aerobee 200	Yes
3-21	FGU	Meteorology	Nike Cajun	Yes
3-21	FGU	Meteorology	Nike Cajun	Yes
3-21	FGU	Meteorology	Arcas	No
3-22	FGU	Meteorology	Nike Cajun	Yes
3-22	FGU	Meteorology	Nike Cajun	Yes
3-22	FGU	Meteorology	Arcas	No
3-21	CRR	Mag. Physics	Aerobee 200	Yes
4-6	WS	X-ray Astronomy	Aerobee 350	Yes
4-17	FBKS	Mag. Physics	Black Brant VC	Yes
4-19	WI	Ionospheric Physics	Nike Apache	Yes
5-8	WS	Astrobee F Test	Special Projects	No
5-14	WI	Flt. Performance	Nike/Malemute	Yes
5-15	WI	Ionospheric Physics	Nike Apache	Yes
5-15	WS	Solar Physics	Aerobee 200	Yes
5-29	WI	Hawk Test	Aerobee 100	Yes
6-16	WS	Galactic Astronomy	Black Brant VC	Yes
6-19	WS	Solar Physics	Aerobee 200	Yes
6-22	WS	Astronomy	Aerobee 200	Yes
6-27	WS	Solar Physics	Aerobee 200	Yes
6-29	WI	Aeronomy	Black Brant VC	Yes
6-29	WI	Positive Ion	Arcas	Yes
6-30	WI	Ion Physics	Nike Apache	No
6-30	WI	Ion Physics	Nike Apache	Yes
6-30	WI	Mag. Physics	Arcas	Yes
6-30	WI	Ion Physics	Arcas	Yes
6-30	WI	Aeronomy	Nike Apache	Yes
6-30	WI	Aeronomy	Nike Apache	Yes
6-30	WI	Ion Physics	Nike Apache	Yes
7-2	GRN	Mag. Physics	Nike Tomahawk	Yes
7-4	CRR	Mag. Physics	Nike Apache	Yes
7-5	CRR	Mag. Physics	Nike Apache	Yes
7-8	GRN	Mag. Physics	Nike Tomahawk	Yes

## Sounding Rocket Flights, 1969-1978 (Continued)

Date of Launch	Site*	Experiment	Sounding Rocket	Scientific Requirements Met
1974				
7-20	WS	Gal. Astronomy	Aerobee 170	Yes
7-25	WS	Mag. Physics	Arcas	Yes
8-14	WI	Aeronomy	Nike Apache	Yes
9-7	WS	Gal. Astronomy	Aerobee 200	Yes
9-18	WS	Solar Physics	Aerobee 170	Yes
9-24	WI	Vehicle Test	Nike/Malemute	Yes
10-3	WS	Gal. Astronomy	Aerobee 200	Yes
10-4	WS	Heat Pipe	Black Brant VC	Yes
10-10	WS	Mag. Physics	Black Brant IIIB	No
10-19	WS	Solar Physics	Aerobee 200	No
11-3	Hawaii	Gal. Astronomy	Aerobee 170	Yes
11-8	WI	Vehicle Test	Hawk	Yes
11-16	WS	Gal. Astronomy	Aerobee 170	Yes
11-16	WS	Gal. Astronomy	Aerobee 170	No
11-25	WS	Aeronomy	Nike Tomahawk	Yes
11-25	WS	Gal. Astronomy	Black Brant VC	Yes
11-25	WS	Gal. Astronomy	Aerobee 200	No
11-27	WS	Solar Physics	Aerobee 200	Yes
12-6	WI	Aeronomy	Nike Tomahawk	Yes
12-13	NOR	Mag. Physics	Nike Tomahawk	Yes
12-28	WS	Gal. Astronomy	Aerobee 200	Yes
1975				
1-20	WS	Solar Physics	Black Brant VC	Yes
1-26	KI	Mag. Physics	Arcas	Yes
1-26	KI	Mag. Physics	Arcas	Yes
2-1	WS	Gal. Astronomy	Aerobee 170	Yes
2-3	WS	Gal. Astronomy	Aerobee 350	Yes
2-3	KI	Mag. Physics	Arcas	Yes
2-10	CRR	Aeronomy	Nike Apache	Yes
2-11	CRR	Mag. Physics	Javelin	Yes
2-13	WS	Mag. Physics	Aerobee 200	Yes
2-13	CRR	Aeronomy	Nike Apache	Yes
2-15	KI	Mag. Physics	Arcas	Yes
2-15	KI	Mag. Physics	Arcas	Yes
2-25	CRR	Aeronomy	Nike Apache	Yes
3-1	FB	Mag. Physics	Nike Tomahawk	No
3-8	WS	Gal. Astronomy	Aerobee 200	No
3-10	CRR	Aeronomy	Aerobee 150/150A	Yes
3-12	CRR	Aeronomy	Nike Apache	Yes
3-13	WS	Meteorology	Arcas	Yes
3-15	WS	Gal. Astronomy	Aerobee 200	Yes
3-15	WS	Gal. Astronomy	Aerobee 350	Yes
3-18	FB	Mag. Physics	Nike Tomahawk	Yes
3-23	FB	Mag. Physics	Nike Tomahawk	Yes
4-4	FB	Mag. Physics	Nike Tomahawk	No
4-8	WI	Meteorology	Nike Cajun	Yes
4-10	WS	Gal. Astronomy	Aerobee 170	Yes
4-13	FB	Mag. Physics	Nike Tomahawk	Yes
4-13	FB	Mag. Physics	Nike Tomahawk	Yes

## Sounding Rocket Flights, 1969-1978 (Continued)

Date of Launch	Site*	Experiment	Sounding Rocket	Scientific Requirements Met
1975				
4-16	FB	Mag. Physics	Nike Tomahawk	Yes
5-15	WS	Astrobee "F" and "O" G Test	Astrobee F	Yes
5-23	Peru	Mag. Physics	Arcas	Yes
5-23	Peru	Meteorology	Arcas	Yes
5-24	Peru	Mag. Physics	Arcas	Yes
5-24	Peru	Meteorology	Arcas	No
5-24	Peru	Meteorology	Arcas	Yes
5-24	Peru	Mag. Physics	Nike Tomahawk	Yes
5-24	Peru	Mag. Physics	Nike Tomahawk	Yes
5-27	Peru	Aeronomy	Nike Apache	Yes
5-27	Peru	Aeronomy	Nike Apache	Yes
5-28	Peru	Mag. Physics	Arcas	Yes
5-28	Peru	Mag. Physics	Nike Apache	Yes
5-28	Peru	Mag. Physics	Arcas	Yes
5-30	Peru	Mag. Physics	Nike Apache	Yes
5-31	Peru	Aeronomy	Nike Apache	No
6-2	Peru	Mag. Physics	Nike Apache	Yes
6-3	Peru	Mag. Physics	Nike Tomahawk	No
6-3	Peru	Aeronomy	Nike Apache	Yes
6-7	Peru	Mag. Physics	Nike Tomahawk	Yes
6-9	Peru	Aeronomy	Nike Apache	No
6-9	Peru	Aeronomy	Aerobee 170	No
6-27	WI	Terrier Malemute Test	Terrier/Malemute	No
7-10	WS	Gal. Astronomy	Aerobee 170	Yes
7-15	WS	Recovery System Test & Mag. Physics	Arcas	Yes
7-15	WS	Mag. Physics	Astrobee D	Yes
7-21	WS	Solar Physics	Black Brant VC	Yes
7-24	WI	Meteorology	Arcas	Yes
7-24	WI	Meteorology	Nike Cajun	Yes
7-28	WS	Solar Physics	Black Brant VC	Yes
7-29	WI	Meteorology	Arcas	Yes
7-29	WI	Meteorology	Arcas	Yes
8-7	WI	Meteorology	Nike Cajun	Yes
8-16	WS	High Energy Astrophysics	Aerobee 170	No
8-18	WS	Vehicle Systems Test	Special Projects	Yes
8-26	WS	Aeronomy	Aerobee 170	Yes
9-9	WI	Vehicle Systems Test	Special Projects	Yes
9-24	WI	Mag. Physics	Nike Tomahawk	Yes
10-3	WS	High Energy Astrophysics	Aerobee 200	No
10-9	WS	Lunar and Planetary Astron.	Aerobee 170	Yes
10-18	WS	High Energy Astrophysics	Aerobee 170	Yes
10-29	WS	Gal. Astronomy	Aerobee 170	Yes
11-8	WS	High Energy Astrophysics	Aerobee 170	No
11-18	WI	Meteorology	Nike Cajun	Yes
11-18	WI	Vehicle Systems Test	Nike/Javelin	Yes
11-19	WI	Meteorology	Nike Cajun	Yes
11-21	WI	Meteorology	Nike Cajun	Yes
12-3	WI	Meteorology	Nike Cajun	Yes



## Sounding Rocket Flights, 1969-1978 (Continued)

Date of Launch	Site*	Experiment	Sounding Rocket	Scientific Requirements Met
1975				
12-4	WI	Meteorology	Nike Cajun	Yes
12-6	WS	High Energy Astrophysics	Aerobee 350	Yes
12-6	WS	Gal. Astronomy	Aerobee 170	Yes
12-11	WS	Space Processing	Black Brant VC	Yes
12-15	Greenland	Meteorology	Arcas	Yes
12-16	WS	Vehicle/Launcher Test	Special Projects	Yes
12-21	Greenland	Meteorology	Arcas	Yes
12-21	Greenland	Meteorology	Arcas	Yes
1976				
1-10	WFC	Vehicle Systems Test	Special Projects	Yes
1-15	WFC	Vehicle Systems Test	Special Projects	No
1-18	WFC	Plasma Physics	Nike Tomahawk	No
1-18	WFC	Plasma Physics	Astrobee D	Yes
1-23	WFC	Plasma Physics	Astrobee D	Yes
1-30	WFC	Plasma Physics	Arcas	Yes
1-31	PFRR	Plasma Physics	Black Brant VC	Yes
2-1	Norway	Plasma Physics	Nike Tomahawk	Yes
2-17	PFRR	Plasma Physics	Nike Tomahawk	Yes
2-18	WSMR	Solar Physics	Black Brant VC	Yes
2-27	Greenland	Meteorology	Arcas	Yes
2-28	PFRR	Plasma Physics	Nike Tomahawk	Yes
3-1	PFRR	Plasma Physics	Nike Tomahawk	Yes
3-2	CRR	Plasma Physics	Nike Apache	No
3-4	Greenland	Meteorology	Arcas	Yes
3-5	WSMR	Cometary Physics	Aerobee 170	Yes
3-5	WSMR	Cometary Physics	Aerobee 200	Yes
3-10	WSMR	Cometary Physics	Aerobee 170	Yes
3-19	WFC	Meteorology	Nike Cajun	Yes
3-22	CRR	Plasma Physics	Aerobee 170	Yes
3-23	WSMR	Galactic Astronomy	Aerobee 200	Yes
3-26	CRR	Aeronomy	Aerobee 170	Yes
3-26	WSMR	Solar Physics	Aerobee 200	Yes
3-27	PFRR	Plasma Physics	Nike Tomahawk	Yes
3-27	PFRR	Plasma Physics	Nike Tomahawk	Yes
3-28	PFRR	Plasma Physics	Nike Tomahawk	Yes
3-30	PFRR	Plasma Physics	Nike Tomahawk	Yes
3-30	PFRR	Engineering Test	Astrobee F	Yes
3-30	Sweden	Plasma Physics	Aries	No
3-31	CRR	Plasma Physics	Black Brant VC	Yes
3-31	CRR	Plasma Physics	Arcas	Yes
4-21	WSMR	High Energy Astrophysics	Aerobee 200	Yes
5-11	WSMR	High Energy Astrophysics	Aerobee 200	Yes
5-11	WSMR	Solar Physics	Aerobee 200	Yes
5-13	WSMR	Plasma Physics	Astrobee D	Yes
5-17	WSMR	Space Processing	Black Brant VC	Yes
5-23	Hawaii	Superfluid Helium in O-g	Black Brant VC	Yes

## Sounding Rocket Flights, 1969-1978 (Continued)

Date of Launch	Site*	Experiment	Sounding Rocket	Scientific Requirements Met
1976				
6-11	WFC	Engineering Test	Nike/Javelin	Yes
6-17	WSMR	High Energy Astrophysics	Aerobee 350	Yes
6-29	WSMR	Aeronomy	Nike Tomahawk	Yes
6-29	WSMR	Solar Physics	Aerobee 170	Yes
7-13	WSMR	Vehicle Systems Test	Special Projects	Yes
7-18	WFC	Vehicle Systems Test	Special Projects	No
7-26	WSMR	Vehicle Systems Test	Special Projects	Yes
8-4	WSMR	Solar Physics	Aerobee 200	Yes
8-11	WSMR	Plasma Physics	Astrobee D	Yes
8-11	WFC	Vehicle Systems Test	Special Projects	Yes
8-12	WFC	Plasma Physics	Nike Tomahawk	Yes
8-22	Greenland	Plasma Physics	Nike Tomahawk	Yes
8-27	Greenland	Plasma Physics	Nike Tomahawk	Yes
9-16	WSMR	Solar Physics	Aerobee 170	Yes
9-21	PFRR	Plasma Physics	Nike Tomahawk	Yes
9-23	PFRR	Plasma Physics	Nike Tomahawk	Yes
9-30	PFRR	Plasma Physics	Nike Tomahawk	No
10-6	WFC	Plasma Physics	Nike Cajun	No
10-22	WSMR	Solar Physics	Black Brant VC	Yes
10-29	WFC	Aeronomy	Nike Tomahawk	Yes
10-30	WSMR	Galactic Astronomy	Aerobee 200	Yes
11-17	WSMR	Solar Physics	Nike Black Brant V	Yes
11-19	WSMR	High Energy Physics	Nike Black Brant V	Yes
11-27	Norway	Plasma Physics	Terrier/Malemute	Yes
11-27	Norway	Plasma Physics	Nike Tomahawk	Yes
12-14	WSMR	Space Processing	Black Brant VC	Yes
1977				
1-8	WFC	Plasma Physics	Nike Tomahawk	Yes
1-8	WFC	Plasma Physics	Astrobee D	Yes
1-8	WFC	Plasma Physics	Arcas	Yes
1-14	PFRR	Plasma Physics	Terrier/Malemute	Yes
1-15	WSMR	Lunar & Planetary Astronomy	Black Brant VC	Yes
1-15	WSMR	High Energy Astrophysics	Aerobee 170	Yes
1-18	PFRR	Plasma Physics	Terrier/Malemute	No
11-23	Norway	Plasma Physics	Nike Tomahawk	Yes
2-6	Norway	Plasma Physics	Nike Tomahawk	Yes
2-7	PFRR	Plasma Physics	Nike Tomahawk	Yes
2-10	PFRR	Plasma Physics	Nike Tomahawk	Yes
2-11	Sweden	Plasma Physics	Arcas	Yes
2-11	Sweden	Plasma Physics	Nike Tomahawk	Yes
2-15	CRR	Aeronomy	Nike Apache	Yes
2-15	Austr.	High Energy Astrophysics	Aerobee 200	Yes
2-15	Austr.	High Energy Astrophysics	Aerobee 200	Yes
2-15	Sweden	Aeronomy	Arcas	Yes
2-16	WSMR	Galactic Astronomy	Astrobee F	No
2-16	Norway	Plasma Physics	Nike Tomahawk	Yes
2-17	Austr.	Galactic Astronomy	Aerobee 170	Yes
2-17	Austr.	Galactic Astronomy	Aerobee 200	Yes
2-21	Austr.	Galactic Astronomy	Aerobee 200	Yes

## Sounding Rocket Flights, 1969-1978 (Continued)

Date of Launch	Site*	Experiment	Sounding Rocket	Scientific Requirements Met
1977				
2-21	Austr.	Solar Physics	Aerobee 170	Yes
2-23	Austr.	High Energy Astrophysics	Aerobee 200	Yes
2-25	CRR	Aeronomy	Nike Hawk	Yes
3-8	CRR	Aeronomy	Nike Hawk	Yes
3-9	WSMR	Solar Physics	Black Brant VC	Yes
3-12	WSMR	Galactic Astronomy	Astrobee F	No
3-19	CRR	Plasma Physics	Astrobee F	Yes
3-20	Sweden	Plasma Physics	Aries	Yes
3-22	WSMR	Galactic Astronomy	Aerobee 200	Yes
4-8	CRR	Aeronomy	Nike Tomahawk	Yes
4-16	WSMR	Galactic Astronomy	Black Brant VC	Yes
5-20	WSMR	Aeronomy	Aerobee 170	No
5-25	WSMR	High Energy Astrophysics	Aerobee 200	Yes
6-9	WSMR	High Energy Astrophysics	Nike Black Brant V	Yes
6-21	WSMR	Space Processing	Black Brant VC	No
7-12	WSMR	Aeronomy	Nike Hawk	Yes
7-14	WSMR	Vehicle Systems Test	Special Projects	Yes
7-19	WFC	Vehicle Systems Test	Special Projects	Yes
7-21	WSMR	Galactic Astronomy	Astrobee F	No
7-27	WSMR	High Energy Astrophysics	Nike Black Brant V	Yes
7-27	WSMR	High Energy Astrophysics	Astrobee F	Yes
8-10	WFC	Plasma Physics	Nike Apache	Yes
8-17	WSMR	Aeronomy	Nike Tomahawk	No
8-17	WSMR	Plasma Physics	Nike Tomahawk	No
9-29	WSMR	Lunar & Planetary Astronomy	Astrobee F	Yes
10-2	WSMR	High Energy Astrophysics	Aerobee 200	Yes
12-2	WFC	Vehicle Systems Test	Special Projects	Yes
12-11	WSMR	Galactic Astronomy	Aerobee 200	Yes
12-11	WSMR	Galactic Astronomy	Astrobee F	Yes
12-11	WSMR	Aeronomy	Nike Tomahawk	Yes
12-14	WSMR	Aeronomy	Nike Hawk	Yes
1978				
1-4	SipleS	Plasma Physics	Arcas	No
1-4	SipleS	Plasma Physics	Arcas	Yes
1-4	SipleS	Plasma Physics	Arcas	Yes
1-5	WFC	Plasma Physics	Nike Apache	Yes
1-9	WSMR	Aeronomy	Astrobee F	Yes
1-10	WSMR	High Energy Astrophysics	Astrobee F	No
1-12	SipleS	Plasma Physics	Arcas	Yes
1-30	Norway	Plasma Physics	Nike Tomahawk	Yes
1-31	WSMR	Solar Physics	Nike Black Brant V	Yes
2-2	PFRR	Plasma Physics	Terrier/Malemute	Yes
2-4	WSMR	High Energy Astrophysics	Aerobee 200	No
2-10	WSMR	Galactic Astronomy	Black Brant VC	Yes
2-13	WSMR	Solar Physics	Black Brant VC	Yes
2-27	PFRR	Plasma Physics	Nike Tomahawk	Yes
2-27	PFRR	Plasma Physics	Nike Tomahawk	Yes
2-28	WSMR	Aeronomy	Aerobee 170	Yes
3-1	PFRR	Plasma Physics	Nike Tomahawk	Yes

## Sounding Rocket Flights, 1969-1978 (Continued)

Date of Launch	Site*	Experiment	Sounding Rocket	Scientific Requirements Met
1978				
3-8	WSMR	High Energy Astrophysics	Astrobee F	Yes
3-9	PFRR	Plasma Physics	Terrier/Malemute	Yes
3-10	PFRR	Plasma Physics	Nike Tomahawk	Yes
3-12	CRR	Aeronomy	Nike Hawk	Yes
3-13	CRR	Plasma Physics	Astrobee F	Yes
3-21	PFRR	Aeronomy	Arcas	Yes
3-27	PFRR	Aeronomy	Arcas	No
3-27	PFRR	Meteorology	Nike Tomahawk	Yes
3-27	PFRR	Aeronomy	Arcas	Yes
3-27	PFRR	Plasma Physics	Arcas	Yes
3-29	PFRR	Meteorology	Nike Tomahawk	Yes
3-29	PFRR	Aeronomy	Arcas	Yes
3-29	PFRR	Aeronomy	Arcas	Yes
3-29	PFRR	Aeronomy	Arcas	Yes
3-30	CRR	Aeronomy	Nike Hawk	Yes
3-30	PFRR	Plasma Physics	Arcas	Yes
4-9	CRR	Plasma Physics	Nike Black Brant V	Yes
4-11	WSMR	High Energy Astrophysics	Nike Black Brant V	Yes
4-13	Sweden	Plasma Physics	Nike Hawk	Yes
5-6	WSMR	High Energy Astrophysics	Aerobee 170	Yes
5-15	WSMR	Galactic Astronomy	Astrobee F	Yes
6-11	WFC	Plasma Physics	Nike Apache	Yes
6-15	WFC	Plasma Physics	Nike Tomahawk	Yes
6-20	WFC	Plasma Physics	Nike Apache	Yes
6-26	WFC	Plasma Physics	Nike Tomahawk	Yes
7-20	WSMR	High Energy Astrophysics	Astrobee F	Yes
8-14	WSMR	Solar Physics	Nike Black Brant V	No
8-15	WFC	Stratosphere Research	Arcas	Yes
8-28	WFC	Stratosphere Research	Arcas	Yes
9-11	WSMR	Space Processing	Black Brant VC	Yes
9-20	WSMR	Lunar & Planetary Astron	Astrobee F	Yes
9-26	WSMR	Galactic Astronomy	Astrobee F	No
9-27	WFC	Plasma Physics	Nike Apache	Yes
10-31	WFC	Vehicle Systems Test	Special Projects	Yes
11-3	WSMR	Plasma Physics	Aerobee 170	Yes
11-16	WSMR	Solar Physics	Aerobee 170	Yes
11-27	Norway	Plasma Physics	Nike Tomahawk	Yes
11-27	Norway	Plasma Physics	Nike Tomahawk	Yes
12-1	WSMR	Lunar & Planetary Astron	Astrobee F	Yes
12-11	WSMR	High Energy Astrophysics	Astrobee F	Yes
12-11	WSMR	Aeronomy	Nike Tomahawk	Yes
12-15	WFC	Meteorology	Arcas	Yes
1979				
1-9	WSMR	Lunar & Planetary Astron	Astrobee F	Yes
1-17	WSMR	Solar Physics	Astrobee F	Yes
1-26	PFRR	Plasma Physics	Terrier/Malemute	No
1-27	WFC	Meteorology	Arcas	Yes
1-28	WFC	Meteorology	Arcas	Yes
1-28	CRR	Plasma Physics	Astrobee F	No
2-20	CRR	Stratosphere Research	Astrobee D	Yes

## Sounding Rocket Flights, 1969-1978 (Continued)

Date of Launch	Site*	Experiment	Sounding Rocket	Scientific Requirements Met
1979				
2-24	RedLake	Plasma Physics	Nike Tomahawk	Yes
2-26	Chikuni	Plasma Physics	Astrobee D	Yes
2-26	RedLake	Plasma Physics	Nike Tomahawk	Yes
2-26	RedLake	Aeronomy	Nike Tomahawk	Yes
2-26	RedLake	Plasma Physics	Nike Tomahawk	Yes
2-26	RedLake	Plasma Physics	Nike Tomahawk	Yes
2-27	Chikuni	Plasma Physics	Astrobee D	Yes
3-1	WSMR	Solar Physics	Black Brant VC	Yes
3-14	WSMR	High Energy Astrophysics	Astrobee F	No
3-19	Sweden	Plasma Physics	Aries	Yes
3-20	WSMR	Galactic Astronomy	Astrobee F	Yes
3-24	PFRR	Plasma Physics	Special Projects	Yes
3-31	Sweden	Plasma Physics	Aries	Yes

## \*Firing Site Abbreviations:

ANT	Antigua	NOR	Andoya, Norway
ASC	Ascension Island	NZ	Karikari, New Zealand
AUS	Woomera, Australia	PAK	Karachi, Pakistan
BI	Barter Island, Alaska	PB	Point Barrow, Alaska
BRAZ	Natal, Brazil	PL	Primrose Lake, Canada
CRR	Fort Churchill, Canada	PMR	Pacific Missile Range, California
EGL	Eglin Air Force Base	PN	Fort Sherman, Panama
FBKS	Poker Flat Rocket Range, Fairbanks, Alaska	PR	Camp Tortuguera, Puerto Rico
FC	Fort Churchill, Canada	RB	Resolute Bay, Northwest Territories, Canada
FGR	Fort Greely, Alaska	SP	Arenosillo, Spain
FGU	Kourou, French Guiana	SUR	Coronie, Surinam
FM	Fox Main, Hall Beach, NWT, Canada	SW	Kiruna, Sweden
GRN	Sondre Stromfjord, Greenland	SWE	Kiruna, Sweden
HAWAII	Barking Sands, Hawaii	WFC	Wallops Flight Center, Virginia
IN	Thumba, India	WSMR	White Sands Missile Range, New Mexico
IND	Thumba, India	WS	White Sands Missile Range, New Mexico
ITALY	Sardinia, Italy		
KE	Keweenaw, Michigan		
KENYA	Kenya (San Marco)		
NWT	Cape Parry, Northwest Territories, Canada		

\*Source: *NASA Sounding Rocket Flights Compendium*, kept current by NASA Headquarters, Office of Space Science and Applications, Astrophysics Division, Flight Programs Branch.



# NOTE ON SOURCES

The author of the second and third volumes of the NASA Historical Data Book series relied on hundreds of individual sources to compile the many tables presented in them. Because so many sources were often consulted, no attempt was made to footnote each fact and figure; instead a major reference is usually cited for the researcher who needs more information than what is presented here. This note will serve as a further guide for the user who wishes to pursue the material from which these volumes were compiled.

NASA Headquarters's History Office in Washington, D.C., served as the author's office and primary source of documentary material. The following kinds of documents were available in the many program, project, and biographical files: NASA press releases, speeches, congressional testimony, contractor reports, related articles from periodicals and newspapers, correspondence, and photographs. Especially important were mission operation reports (often cited as MORs) and midterm and prelaunch reviews. The author used such reports as her authority when confronted with conflicting data or memories. The serious researcher interested in the manned spaceflight program should also consult the Johnson Space Center History Office and the related archives housed at the Fondern Library, Rice University, Houston, Texas.

In addition to these archival records, the author found the series *Astronautics and Aeronautics, Chronology on Science, Technology and Policy* to be most valuable. *A&A*, as it is commonly called, is compiled by staff members of the NASA Headquarters History Office; a volume is available for each year, starting with 1963. Three other general volumes the researcher should consult are: Helen Wells, Susan H. Whitely, and Carrie E. Karegeannes, *Origins of NASA Names*, NASA SP-4402 (Washington, 1976); Frank W. Anderson, Jr., *Orders of Magnitude; A History of NACA and NASA, 1915-1980*, NASA SP-4403 (Washington, 1981); and House of Representatives, Committee on Science and Technology, Subcommittee on Space Science and Applications, *United States Civilian Space Programs, 1958-1978, Report* (Washington, 1981). For those interested in how NASA managed its programs during the Apollo program, refer to Arnold Levine, *Managing NASA in the Apollo Era*, NASA SP-4102 (Washington, 1982). A useful tool for tracking the management of programs is the collection of NASA Headquarters and NASA center telephone directories kept at the NASA History Office.

The budget tables for all six chapters were compiled from one primary source, the "NASA Chronological History Fiscal Year Budget Submissions," prepared for Congress annually by NASA's Budget Operations Division of the Office of Administration, NASA Headquarters. Each volume lists the amount requested for that fiscal year (e.g., FY 1972), an estimate of the amount that will be programmed for the preceding year (e.g., FY 1971), and the amount actually programmed the year

before that (e.g., FY 1970). In addition to the budget figures, the volumes contain a brief summary of the project and a statement of the work required during the coming year. Please refer to the budget section of chapter 1 for more information on the budget process and the tables prepared for this book.

The author found the following major works to be useful in preparing the six chapters of the third volume (refer to the source notes for journal articles, papers, press accounts, and the like):

### Chapter 1:

Baker, David. *The Rocket: The History and Development of Rocket & Missile Technology*. New York: Crown Publishers, 1978.

Benson, Charles D. and William B. Faherty. *Moonport; A History of Apollo Launch Facilities and Operations*. NASA SP-4204, Washington, 1978.

Bilstein, Roger E. *Stages to Saturn: A Technological History of the Apollo/Saturn Launch Vehicles*. NASA SP-4206, Washington, 1980.

### Chapter 2:

Belew, Leland F. and Ernst Stuhlinger, *Skylab: A Guidebook*. Marshall Space Flight Center, 1973.

Brooks, Courtney G., James M. Grimwood, and Loyd S. Swenson. *Chariots for Apollo: A History of Manned Lunar Spacecraft*. NASA SP-4205, Washington, 1976.

Compton, W. David and Charles D. Benson. *Living and Working in Space: A History of Skylab*. NASA SP-4208, Washington, 1983.

Ezell, Edward C. and Linda Neuman Ezell. *The Partnership: A History of the Apollo-Soyuz Test Project*. NASA SP-4209, Washington, 1978.

### Chapter 3:

Ezell, Edward C. and Linda Neuman Ezell, *On Mars: Exploration of the Red Planet*. NASA SP-4212, Washington, 1983.

Newell, Homer E. *Beyond the Atmosphere: Early Years of Space Science*. NASA SP-4211, Washington, 1980.

Pitts, John. *The Human Factor*. NASA SP-4213, Washington, 1986.

### Chapter 4:

Mack, Pamela E. "The Politics of Technological Change: A History of Landsat," unpublished doctoral dissertation, University of Pennsylvania, 1983.



**Chapter 5:**

Hallion, Richard P. *On the Frontier: Flight Research at Dryden, 1946–1981*. NASA SP-4303, Washington, 1984.

**Chapter 6:**

Corliss, William R. “Histories of the Space Tracking and Data Acquisition Network (STADAN), the Manned Space Flight Network (MSFN), and the NASA Communications Network (NASCOM).” NASA CR-140390, June 1974.

In 1973, NASA adopted the metric system for its publications. Although many metric weights and measurements are now commonly used in the U.S., some may still seem foreign to the reader. Probably the most frequently questioned measurement is “newtons of thrust”: pounds of thrust  $\times$  4.448. A useful publication for the user not familiar with the metric system is E. A. Mechtly, *The International System of Units, Physical Constants and Conversion Factors*, NASA SP-7012, 2d. rev. (Washington, 1973). Also be aware that the weights given for launch vehicles and spacecraft are “wet weights”; that is, the weight with fuel. Dates and times of mission events are local. Ground elapsed time is the amount of time in hours, minutes, and seconds that has elapsed since launch.



# INDEX

*Page references to illustrations or photographs are in italics.*

- A
- Able, 21, 31
- Adams, Kenneth A., 293, 298
- Advanced Research Projects Agency, 266, 267, 389
- Aerojet-General Corporation, 43 n, 48, 49
- Aerojet Liquid Rocket Company, 121
- aeronautics and space research, 347-81; budget, 353-60; management, 350-53; programs, 359-81
- Aeronutronic Ford Corporation, 268, 299, 301-2
- Aeros 1*, 2, 30, 179, 181, 182
- Aerospace Corporation, 173, 200
- Agema, 6, 14, 15, 21, 31, 41, 133, 149
- Aggson, T. L., 327, 330
- Agriculture, U. S. Department of, 335-38
- Agnew, Spiro T., 127 n, 236 n
- Aiken, William S., Jr., 352-53, 361
- Air Force, U. S. Department of the, 4, 21, 22, 23, 25, 28, 31-33, 37-42, 80 n, 81, 97, 98, 100, 200, 267, 287, 290, 298, 312-14, 316, 338, 362, 364-69, 373, 381, 385, 404, 407, 424; Cambridge Research Laboratories, 161, 173, 196; Space and Missile Systems Organization, 38, 42
- Aldrin, Edwin E., Jr., 53, 74, 81, 85
- Alleghany Ballistics Laboratory, 29
- Allen, Richard J., 58, 59
- Allenby, R. J., 58, 59
- Aller, Robert O., 7, 58-60
- Alouette, 152
- American Airlines, 121
- American Science and Engineering, Inc., 154, 167
- American Telephone and Telegraph Company, 26, 293
- Ames, Milton B., Jr., 351, 361
- Ames Research Center, 130, 202, 219, 221-25, 230-31, 239, 331, 335, 339, 351, 361, 364, 369-74, 379
- Ancremanne, Marcel J., 131
- Anik 1, 35, 290; Anik 2, 35, 290, 291; Anik 3, 36, 37, 162, 290, 291; Anik 4, 37, 290, 292
- Anders, William A., 85
- Anderson, George M., 59
- Andrews, Edward P., 59, 60
- Andrus, A. M. Greg, 240-242, 289-90
- ANS*, 179; *ANS 1*, 30, 181, 183
- Antares, 21
- Apollo: budget, 14, 17, 18, 61, 67, 71-72; crew, 3, 53, 54, 73, 74, 77, 78-91, 94, 98, 99, 104, 108, 371, 373; experiments, 93, 377; missions, 13, 74, 93, 94, 99, 127, 230, 370, 388, 401, 402, 413, 415, 417, 420, 422, 423; program, 3, 5, 7, 8, 20, 27, 53-57, 59, 73, 80, 81-94, 337, 404; spacecraft, 26, 54, 73, 75-78, 78, 97, 98, 100, 101, 108, 109, 111-112, 114; *Apollo 8*, 26, 73, 388; *Apollo 9*, 26, 28, 54, 74, 77, 81, 83, 334; *Apollo 10*, 26, 28, 54, 74, 81, 84; *Apollo 11*, 26, 28, 53, 74, 80, 81, 85, 93, 108, 401; *Apollo 12*, 28, 54, 74, 82, 86, 377, 401; *Apollo 13*, 26, 28, 54, 78, 82, 87, 401; *Apollo 14*, 28, 54, 78, 82, 88, 401; *Apollo 15*, 28, 54, 78, 79, 79, 82, 89-90, 229, 230, 401; *Apollo 16*, 28, 54, 78, 80, 82, 90-91, 229, 230, 405; *Apollo 17*, 28, 54, 78, 80, 82, 91-92, 403, 405; *Apollo 20*, 81, 82; "Apollo X," 97
- Apollo Applications, 26, 55, 57, 63, 64, 94, 98, 99, 100, 334
- Apollo Range Instrumentation Aircraft, 404-6, 404, 423
- Apollo-Soyuz Test Project, 3, 14, 17, 27, 28, 81, 108-13, 110-11, 327, 329, 405, 406, 414; budget, 61, 65-67; crew, 109, 111-12; experiments, 113; program, 55-56, 59, 73; spacecraft, 109; working groups, 109
- Apollo Telescope Mount, 94, 95, 96, 98-101, 103, 165 n. *See also* Skylab
- Applications Technology Satellites (ATS), 23, 39, 42, 237-39, 245, 255, 256, 275, 289, 325-30, 328-29, 331, 333, 421; ATS 1-4, 256, 287, 325; ATS 5, 24, 25, 256, 325-26, 326, 328-30; ATS 6, 38, 39, 41, 42, 238, 255, 256, 325-27, 327, 328-30, 342; ATS A-D, 325; ATS E, 325, 330; ATS F, 42, 255-57, 325, 326 n, 328-30; ATS G, 39, 42, 325, 326 n, 328-29; ATS H-I, 329
- Ariane, 299, 302
- Ariel 4*, 5, 30, 179, 181, 184, 185
- Arizona, University of, 222, 223, 225, 228
- Armstrong, Neil A., 53, 74, 81, 85, 351, 379

## A (Continued)

Armstrong, William O., 57, 58, 60  
 Army Ballistic Missile Agency, 97, 152, 267  
 Army, U. S. Department of the, 128, 152, 240, 283, 342, 344, 373, 381, 385  
 Arnold Engineering Development Center, 369  
 Ashworth, C. Dixon, 131, 171, 175  
 Atlas, 5, 16, 20-22, 25, 26, 149, 207;  
   Atlas F, 3 n, 6, 7, 14, 15, 20-22, 60, 267, 273, 344  
 Atlas-Agena, 327  
 Atlas-Centaur, 3, 4, 4, 6, 7, 21-23, 25, 26, 38, 60, 165, 166, 168-72, 210-12, 219, 222-25, 289, 293, 294, 298, 299, 301, 302, 305-11, 327, 330, 425  
 Atomic Energy Commission, 155, 283, 374, 376, 377  
 Azur (*GRS-1*), 30, 179, 181, 186

## B

Ball Brothers Research Corporation, 98, 168, 172, 174-77  
 Banded, William R., 280, 286, 289  
 Barrett, Paul F., 242  
 Bass, Abram S., 57, 58  
 Bauer, Siegfried J., 182  
 Bavely, James C., 389, 390  
 Bean, Alan L., 82, 83, 86, 94 n, 101, 105, 111  
 Beattie, Donald A., 353  
 Beckman Instruments, 282  
 Beggs, James M., 351  
 Behring, W. E., 177  
 Bekey, Ivan, 60  
 Bell Aerospace, 32  
 Bell Telephone Laboratories, Inc., 154  
 Bendix Corporation, 167, 336, 338, 343, 404, 405 n, 406  
 Bergen, University of (Norway), 187  
 Biosatellite, 33, 128, 133, 146, 230-31, 416; *Biosatellite 1*, 230; *Biosatellite 2*, 230; *Biosatellite 3*, 35, 129, 230, 231  
 Bernier, Robert E., 242  
 Berry, Charles A., 58  
 Birmingham, University of (U.K.), 184  
 Bishop, William P., 243  
 Bluford, Guion S., 80 n  
 Bobko, Karol J., 80 n  
 Bobkov, Valentin N., 109  
 Boeing Aerospace Company, 345  
 Boeing Company, 26, 27, 43 n, 48, 82, 97-99, 114 n, 121-23, 206, 209, 216  
 Bogart, Frank A., 57

Bogges, Albert, 197  
 Bologna, University of, 177  
 Bonn, University of, 225  
 Boreas. *See* European Space Research Organization  
 Branchflower, Gilbert A., 267, 273  
 Brand, Vance D., 85, 105, 109, 111, 112  
 Brandenstein, Daniel C., 80 n  
 Bredt, James H., 242  
 British Aircraft Corporation, 184, 185, 189, 301  
 Broadcast Satellite - Experimental (BSE), 37, 290, 292  
 Brockett, H. R., 389, 390  
 Broome, Douglas R., 243, 280  
 Browning, Ronald K., 187, 280, 286, 337, 341  
 Brunk, W., 130  
 Bryant, Frederick B., 389, 390  
 Buchli, James F., 80 n  
 Budget, U. S. Bureau of the, 9-11, 336-38  
 Bundesministerium fur Bildung und Wissenschaft (BMBW), 182, 186, 190  
 Burke, Joseph R., 240-42, 327  
 Bushuyev, Konstantin D., 109  
 Butler, Paul, 154, 155, 158  
 Byerly, T. C., 336 n

## C

Calgary University of, 197  
 California Institute of Technology, 128, 158, 160, 166, 169, 170, 173, 195, 210-212, 222  
 California, University of, 195; at Berkeley, 154, 155, 210, 229; at Los Angeles, 173, 193, 194, 224, 229; at San Diego, 166, 169, 179, 222, 223  
 Calio, Anthony J., 131, 239, 241, 243  
*Cameo*, 37, 181, 187  
 Canada, 123, 181, 196, 238, 290, 294, 315, 372; Communications Research Centre of, 197, 294, 297; Defense Research Board of, 196; Department of Communications of, 196, 289, 294, 297; Department of Industry, Trade, and Commerce of, 381  
 Canady, J. E., Jr., 164  
 Canberra, Australia, 388, 388 n, 402, 405, 407, 410, 414, 415, 425  
 Caporale, Anthony J., 199  
 Carnegie Institute, 410  
 Carr, Gerald P., 94 n, 101, 105  
 Carruthers, John R., 239, 242  
 Carter, Jimmy, 127, 236  
 Casani, John R., 226, 228  
 CA Victor Co. (Canada), 196

## C (Continued)

- Centaur, 6, 14, 16, 20-22, 25, 38,  
 40-42, 133, 149, 206, 207, 209, 211,  
 217  
 Cepe (Cylindrical Electrostatic Probe  
 Experiment), 35, 270  
 Cernen, Eugene A., 80-82, 84, 88, 91  
 Cervenka, Adolph J., 242, 243, 295  
 Cherry, George W., 352  
 Chicago, University of, 154, 155, 158,  
 160, 195, 212, 222, 223  
 Christensen, Albert T., 241  
 Chrysler Corporation, 27, 48, 114 n, 121,  
 123  
 Clemente, Joseph M., 58  
 Coats, Michael L., 80 n  
 Coffee, C. W., 162  
 Cohen, Haggai, 57, 60  
 Colin, L., 221, 224, 225  
 Collins, Michael, 53, 74, 81, 85  
 Colorado, University of, 161, 173, 175,  
 177, 179, 210, 211, 228  
 Columbia University, 166, 178  
 Commerce, U. S. Department of, 268,  
 275, 287, 336 n, 337, 342  
 comets: Giacobini-Zinner, 195;  
 Halley's, 195; Kohoutek, 96, 102  
 Communications Satellite  
 Corporation, 25, 26, 290, 293, 294,  
 298, 302-12  
 Communications Technology Satellite  
 (CTS), U. S. - Canadian, 238-40,  
 245, 255-58, 289, 294-97, 295-96,  
 372; CTS 1, 36, 289, 290, 297  
 COMSAT, 236  
 Comstar, 23; *Comstar 1, 2, 3*, 24, 26,  
 290, 293, 294  
 Congress, U.S., 8, 8 n, 9, 11, 25, 26,  
 38, 53, 94, 121, 127, 137, 138, 165,  
 168, 175, 176, 202, 209, 213, 216,  
 235-37, 239, 244, 281, 298, 329, 336,  
 339, 340, 349, 350, 370, 376, 401, 406,  
 419, 424, 425. *See also* House of  
 Representatives, U.S., and Senate,  
 U.S.  
 Conrad, Charles, Jr., 82, 83, 86, 94 n,  
 101, 104  
 Consolidated Vultee Aircraft  
 Corporation, 21  
 Control Data Corporation, 168  
 Cooper, L. Gordon, 84  
 Cooter, Kathleen J., 243  
*Copernicus. See* Orbiting Astronomical  
 Observatories  
 CS (Sakura), 36, 290, 294  
 Costantino, James, 57  
 Cotton, Paul E., 351, 352  
 Covey, Richard O., 80 n  
 Creighton, John O., 80 n  
 Crippen, Robert L., 80 n  
 Culbertson, Philip E., 55, 57-59  
 Cunningham, N. William, 130, 206

## D

- Dallow, Thomas P., 130, 231  
 Dana, William H., 363, 365-68  
 Daniels, Richard L., 130, 131, 241  
 Dankhoff, Walter, 352  
 Darcey, Robert J., 327, 330  
 Dartmouth College, 173  
 Day, LeRoy E., 57-60  
 Deep Space Network, 207, 214, 221,  
 226, 388-92, 395, 397, 401, 402, 406,  
 407, 410, 411-12, 414-23  
 Defense, U.S. Department of, 26, 37,  
 41, 42, 48, 80, 97-100, 102, 121, 127,  
 287, 290, 312-14, 342, 373, 381, 387,  
 387 n, 388, 401, 406 n, 413, 415, 417,  
 419, 421, 422  
 Delta, 3 n, 4, 5, 6, 7, 14, 16, 31, 33,  
 37, 60, 133, 149, 153, 175, 267,  
 271-73, 286, 289, 294, 312-16,  
 318-21, 344; Delta C, 177; Delta  
 E, 154, 155, 158, 197, 269; Delta  
 N, 177, 178, 201, 269, 270; Delta  
 Standard Vehicle 3E, 196; Delta  
 1604, 160; Delta 1900, 161; Delta  
 1910, 178; Delta 1913, 159; Delta  
 2910, 163, 187, 280, 284-86, 288,  
 341; Delta 2914, 189, 275, 277-79,  
 288, 290-292, 294, 297, 311-14, 317,  
 321, 322, 324, 325, 425  
 Dement, Donald K., 239, 242  
 DeMeritte, Frederick J., 352, 353, 361  
 Denmark, 189, 191; Space Research In-  
 stitute of, 170  
 DeNoyer, John M., 130, 239, 241, 242,  
 331, 336  
 Denver, University of, 155  
 Deutsch, George D., 352, 353, 360  
 Dietz, R. H., 109  
 Diller, Dick S., 242, 243  
 Disher, John H., 55-58, 60, 98  
 Donlan, Charles J., 57-59, 114  
 Donoughe, Patrick L., 295  
 Dornier Systems, 180, 182, 194  
 Douglas Aircraft Company, 26, 27, 31,  
 97, 98, 404  
 Dryden Flight Research Center, 49, 123,  
 407  
 Dryden, Hugh L., 97  
 Dual Air Density Satellite, 30  
 Dubin, M., 131  
 Dubridge, Lee A., 127 n, 236 n  
 Dudley Observatory, 222

## D (Continued)

Duke, Charles M., Jr., 82, 87, 90, 91  
 Durocher, Norman L., 241, 242, 266  
 Dwornik, E., 130  
 Dyna Soar, 97

## E

Eaker, Herbert L., 184, 185, 187  
 Earth Resources Experiments Package (EREP), 331, 334-35, 338-39  
 Earth Resources Observation Satellite (EROS), 335-37  
 Earth Resources Survey Program (ERSP), 337-38  
 Earth Resources Technology Satellite (ERTS), 245-47, 282, 331, 335-39, 341, 405, 406 (see also Landsat); *ERTS 1*, 35, 336, 339, 340  
 Eastern Test Range, 22, 41, 83-91, 103-5, 109, 111, 155, 158-60, 163, 168-71, 173, 177, 178, 190, 191, 193, 195, 197, 200, 201, 210-12, 218, 222-25, 228, 229, 231, 239, 269, 275, 277-79, 288, 290-94, 297, 298, 302-14, 316-22, 324, 325, 330, 401, 406, 416  
 Eaton, Elbert L., 389, 390  
 Eaton, Peter T., 6, 7, 33, 60  
 Edwards Air Force Base, 116, 117, 123, 362, 389, 407  
 Edwards, John E., 57  
 Edwards, L. K., 60  
 Ehrlich, Eugene, 240-42  
 Eisele, Donn F., 84  
 Electronics Research Center, 370, 371  
 Enevoldson, Einar, 364, 368  
 Engines Matra (France), 201  
 Engle, Joe H., 88, 116, 118  
 English, Ronald D., 29  
 Environmental Sciences Services Administration (ESSA), 237, 266, 267, 274, 275, 279, 337, 338, 414; *ESSA 1-9*, 333; *ESSA 1*, 266; *ESSA 7*, 269; *ESSA 9*, 35, 237, 266-69  
*Eole*, 30, 280, 286, 289  
 Ernst, Herb, 241  
 European Space Agency, 4, 116, 179-81, 189, 193, 197, 286, 288, 290, 316  
 European Space Research Organization (ESRO), 116, 179, 181, 187-89, 191, 201; ESRO (spacecraft), 152, 181, 187; *ESRO 1B (Boreas)*, 30, 187; *ESRO 4*, 30, 179, 181, 188  
 Evans, Albert J., 351-53, 379  
 Evans, Ronald E., 82, 88, 91, 111

Evans, Wyendell B., 57, 59  
 Expendable Launch Vehicles Program, 56, 60, 73. See also launch vehicles  
 Explorer: program, 128, 133, 134, 152, 168, 179; satellites, 28, 33, 108, 128, 129, 151, 152-64, 165 n, 180; *Explorer 1*, 152; *Explorer 11*, 164; *Explorer 29*, 36, 342; *Explorer 41*, 35, 153, 154; *Explorer 42 (Uhuru)*, 30, 153, 154, 164; *Explorer 44*, 153, 156, 200, 201; *Explorer 45*, 30, 152, 153, 157; *Explorer 46*, 30, 31, 153, 157; *Explorer 47*, 35, 37, 153, 158; *Explorer 48*, 30, 153, 158, 164; *Explorer 49*, 35, 153, 159; *Explorer 50*, 35, 153, 160; *Explorer 51*, 35, 152, 153, 161, 163; *Explorer 52*, 29, 30, 31, 152, 153, 162; *Explorer 53*, 30, 153, 162, 164; *Explorer 54, 55*, 36, 152, 153, 163; Explorer 56 and 57, 164

## F

Fabian, John M., 80 n  
 Fairchild Industries, Inc., 123, 301, 326, 328-30  
 Faraday Laboratories, 173  
 Federal Aviation Administration, 102  
 Federal Communications Commission, 301  
 Federal Home Loan Bank Board, 11 n  
 Federal Preparedness Agency, 102  
 Federal Trade Commission, 11 n  
 Fellows, R., 130  
 Fero, Lester K., 58  
 Fichtel, Carl E., 154, 158, 162  
 Fiebelkorn, John A., 242  
 Field, J. Pemble, Jr., 57, 58  
 Finley, Charles J., 242  
 Fischer, John C., Jr., 97  
 Fischetti, Thomas L., 131, 241, 243  
 Fisher, Anna L., 80 n  
 Fletcher, James C., 129, 239, 339, 424  
 Flinn, Edward A., 131  
 Fltsatcom, 23, 24, 26, 289, 290, 298  
 Flight Research Center, 350, 351, 361-64, 369, 372, 379  
 Fong, Louis B. C., 240-41  
 Ford Aerospace and Communications, 294, 405  
 Ford, Gerald R., 8, 339  
 Fordyce, Don V., 274, 277  
 Fordyce, Samuel W., 241-42, 290  
 Fox, Leo, 352, 373  
 France, 4, 189, 191, 268, 280, 286, 321, 322; Centre National de la Recherche Scientifique, 175, 178;

## F (Continued)

## France (Continued)

Centre d'Etudes Nucleaires, 170, 201;  
Centre National d'Etudes Spatiales,  
268, 286, 289

Frank, M. Pete, 109  
Franta, Allen L., 186  
Freden, Stanley C., 337, 341  
Freitag, Robert F., 57, 58, 60  
Friebaum, Jerome, 240-42  
Frosch, Robert A., 31, 336 n  
Frustace, Philip, 292  
Fullerton, Charles G., 80 n, 116, 118

## G

Gabriel, David S., 352, 374  
Gagarin, Yuri, 108  
Galileo (program), 133, 143  
Garbacz, Michael L., 240, 241, 243,  
266, 267, 275  
Gardner, Dale A., 80 n  
Gardner, William H., 352  
Gardner, W. N., 352  
Garriot, Owen K., 94 n, 101, 105  
Gay, Clarence C., Jr., 58, 59  
Gemini (program), 20, 53, 61, 74, 239,  
331, 334, 388, 405  
General Accounting Office, U.S., 49,  
122, 329, 340  
General Dynamics, 21, 22, 23, 25, 26,  
43 n, 48, 114, 121, 409; Convair  
Aerospace Division, 21, 22, 23, 40,  
42, 48, 123, 168; Rocketdyne  
Division, 114, 121, 122, 123  
General Electric Company, 41, 122,  
216, 222, 223, 231, 280-86, 292,  
328-30, 336, 338-41, 424; Space  
Systems Organization, 167  
General Services Administration,  
U.S., 11 n  
Gentry, Jerauld, R., 363-66  
Geodynamics Experimental Ocean  
Satellite (GEOS), 36, 238, 239, 245,  
259, 260, 261, 342, 343; *GEOS*  
*1*, 181, 189, 260; *GEOS 2*, 37, 181,  
189, 260; *GEOS 3*, 36, 259, 406  
Geological Survey, U.S., 211, 335, 337,  
338  
George, Theodore, E., 240, 241  
Geostationary Meteorology Satellite  
(GMS), 36, 286, 287 n, 288  
Geostationary Operational Environmental  
Satellite (GOES), 250, 274, 275;  
*GOES 1, 2, 3*, 36, 237, 274, 275,  
278, 287 n, 333

Germany, Federal Republic of, 4, 181,  
182, 186, 188-91, 290, 321, 322  
Giberson, Walker E., 212, 344  
Gibson, Edward G., 94 n, 101, 105  
Gibson, Robert L., 80 n  
Gillam, Isaac T., IV, 6, 33  
Gilruth, Robert R., 100  
Ginter, R. D., 351, 352  
Glahn, Carl W., 130, 206  
Glaser, Harold, 131  
Glaser, N., 131  
Glenn, John J., Jr., 53, 108  
Global Air Sampling Program  
(GASP), 380  
Global Atmospheric Research Program  
(GARP), 238, 245, 252, 266, 273,  
275, 285, 287, 288  
Goddard, Robert, 170  
Goddard Space Flight Center, 32, 33,  
128, 130, 152-55, 157-63, 165 n, 166,  
167, 169, 171, 172, 173, 175, 176-80,  
180, 182-87, 189-201, 211, 212, 219,  
222-25, 228, 239, 267-70, 273-75,  
277-82, 288, 289-92, 294, 295, 297,  
312-14, 317-30, 336-41, 343, 345,  
371, 386, 387 n, 390, 405-7, 410, 416,  
419, 424, 425; Image Processing  
Facility,, 405, 407; Network Test and  
Training Facility, 386 n, 387, 405,  
414, 420  
Goedeke, Donald, 242  
Goff, Loyal G., 130  
Goldberg, W. G., Jr., 243  
Goldsby, William D., 7, 60  
Goldstone, California, 388, 388 n, 389,  
402, 405-7, 410, 413, 414, 417, 425  
Goodyear Aerospace Corporation, 328,  
340  
Goozh, Paul E., 6, 7, 29, 60  
Gordon, Richard F., Jr., 82, 83, 86, 89  
Gorman, Harry H., 57, 58  
Goss, Robert J., 191, 201, 288, 290-92,  
294, 312-14, 317-25  
Green, William D., Jr., 99  
Greenwood, Lawrence R., 131, 239, 243  
Gregory, Frederick D., 80 n  
Griffin, Gerald D., 60  
Griggs, Stanley D., 80 n  
Grimes, David W., 163  
Grumman Aerospace Corporation, 43 n,  
48, 114, 114 n, 121-23, 165, 167,  
170-72  
Grumman Aircraft Engineering  
Corporation, 77, 98  
GTE Satellite Corporation, 293

## H

Habib, Edmund, 242  
 Hage, George H., 57  
 Hagner, Donald R., 57, 59  
 Haise, Fred W., Jr., 82, 85, 87, 90, 116, 118  
 Haley, Richard I., 240, 280  
 Hall, Benny B., 130  
 Hall, Charles F., 221, 222, 224, 225  
 Hall, Eldon W., 57, 58  
 Hall, L., 130  
 Halpern, R. E., 166  
 Hamon, William J., 59  
 Hanes, Thomas E., 55, 58, 59  
 Harkleroad, Edgar L., 60  
 Harper, Charles W., 351, 379  
 Harrington, James C., 60  
 Harris Inc.: Electronic Systems Division, 425; Radiation Systems Division, 167  
 Harris, Thomas E., 57  
 Hart, Terry J., 80 n  
 Hartzfield, Henry W., 80 n  
 Harvard College Observatory, 161, 177  
 Hauck, Frederick H., 80 n  
 Haughey, Joseph W., 6  
 Hawersaat, William H., 295  
 Hawker-Siddeley Dynamics, Ltd., 188, 198, 316  
 Hawley, Steven A., 80 n  
 Hayes, William, 352, 353  
 Hearth, Donald P., 129, 202, 206  
 Heat Capacity Mapping Mission (HCMM), 30, 181, 245, 262, 333, 342-43, 345  
 Helios, 141; *Helios 1*, 38, 40-42, 179, 181, 190, 191; *Helios 2*, 38, 40-42, 179, 181, 191  
 Heppner, James P., 187  
 Hercules Powder Co., 29  
 Hess, Norman F., 160  
 Hibbard, Richard T., 241-42  
 Hickam Air Force Base, 231  
 High Energy Astronomy Observatories (HEAO), 23, 128, 129, 133, 135, 136, 152, 164-69, 166; HEAO-A, B, C, 165, 166, 167, 168; *HEAO 1*, 24, 26, 166, 168-70; *HEAO 2*, 24, 26, 37, 166, 168, 169; *HEAO 3*, 166, 168, 170  
 Highly Eccentric Orbiting Satellite (HEOS), 35, 181, 191  
*Himawari*. See Geostationary Meteorology Satellite  
 Himmel, Seymour C., 352  
 Hinnens, Noel W., 6, 129, 131  
 Hoag, Peter C., 363, 365, 366  
 Hodge, Kenneth E., 352, 353

Hoffman, Jeffrey A., 80 n  
 Hoffman, Robert, 157  
 Holcomb, John K., 57, 59  
 Holloway, Bruce K., 351  
 Holloway, Paul F., 352  
 Holt, Steven S., 169, 185  
 Holtz, J., 131  
 House of Representatives, U.S., Committee on Science and Astronautics, 41, 331; Committee on Science and Technology, 340, 379. See also Congress, U.S.  
 Houston, Texas, 56, 78, 109, 114, 387  
 Hovell, Ronald C., 59  
 Howard, Brian T., 57  
 Hubbard, Samuel H., 241, 242, 290  
 Hughes Aircraft Company, 167, 175, 176, 178, 275, 288, 290, 291, 293, 294, 298, 301, 302, 306-12, 317, 324, 325, 330, 338, 424, 425  
 Humphreys, James W., 57, 58  
 Hunter, Charles M., 269  
 Huntsville, Alabama, 26, 44, 56, 165, 167  
 Hyatt, Abraham, 97  
 Hymowitz, Emil, 183

## I

IBM Corporation, 123  
 Imperial College, London, 185, 195  
 Improved Tiros Operational System (ITOS), 250, 267, 268; Itos 1, 35, 269, 314, 333 (see also Tiros M); Itos A, 270 (see also NOAA 1); Itos B, 35, 268, 270 (see also NOAA 2); Itos D, 271 (see also NOAA 2); Itos E, 35, 268, 271. (see also NOAA 3); Itos F, 272 (see also NOAA 3); Itos G, 272 (see also NOAA 4); Itos H, 273 (see also NOAA 5)  
 Indonesia, 4, 290, 317  
 Inscho Mechanical Contractors, 168  
 Instituto Nacional de Technica Aeroespacial Satellite (INTASAT), 181, 192  
 International Telecommunications Satellite Consortium (Intelsat), 4, 23, 236, 238, 289, 290, 298-311, 300; Intelsat I-III, 298; Intelsat IV, 298, 299, 301; Intelsat IV $\frac{1}{2}$ , IVA, V, 299, 301-2; Intelsat IV F-1-F-8, 23-25, 290, 301, 305-9; Intelsat IVA F-1-F-6, 24, 25, 290, 299, 301, 309-11  
 Interior, U.S. Department of, 238, 335-37, 339, 373



## I (Continued)

International Council of Scientific Unions, 287  
 International Satellite for Ionospheric Studies (ISIS): ISIS 1 and 2, 35, 179, 181, 196-97  
 International Sun-Earth Explorer (ISEE), 180; *ISEE 1*, 2, 3, 36, 180, 181, 193-95  
 International Telecommunications Union, 386  
 International Telephone and Telegraph Co., 268  
 International Ultraviolet Explorer (IUE), 179, 180; *IUE 1*, 179, 181, 197-98  
 Iowa, University of, 153-55, 157, 158, 160, 162, 184, 190, 193, 194, 222, 223  
 Irwin, James B., 79, 82, 86, 89  
 Italy, 4, 181, 189, 191, 199, 290, 319

## J

Jackson, John E., 196, 197  
 Jackson, Roy P., 351  
 Jacobs, G., 130  
 Jaffe, Leonard, 130, 238-43, 334, 336, 336 n  
 Jakobowski, Walter, 214  
 Japan, 4, 286, 287, 290, 294; National Space Development Agency of, 288, 292, 294  
 Jenkel, Albert A., 241, 242  
 Jenkins, D., 130  
 Jenkins, Thomas E., 57  
 Jet Propulsion Laboratory, 41, 128, 130, 170, 173, 191, 195, 202, 203, 206, 207, 209-14, 216-18, 221-26, 228, 229, 239, 301, 342, 344, 371, 385, 388-90, 413  
 Johannesburg, South Africa, 386 n, 405-7, 410, 414, 419  
 Johns Hopkins University, The, 200; Applied Physics Laboratory, 153-55, 158, 160-62, 228, 322-24, 343  
 Johnson, Charles W., 343  
 Johnson, Harry W., 352, 353  
 Johnson, Lyndon B., 8, 98, 213, 216  
 Johnson, Rodney W., 58-60  
 Johnson, Roy P., 378  
 Johnson Space Center, 56, 101, 115, 123, 229, 230, 239, 329, 331, 335, 337, 339  
 Johnson, U. Alexis, 127 n, 236 n  
 Johnson, Vincent L., 130, 131, 240, 241  
 Johnston, Bradford, 239, 241

Joint Institute for Laboratory Astrophysics, 176  
 Jones, David M., 98, 99  
 Jones, J. Lloyd, 351, 352, 379  
 Jones, Sidney C., Jr., 60  
 Jones, Walton J., 351, 352, 373  
 Jones, William W., 267, 269, 270

## K

Kayten, Gerald G., 352, 353  
 Keldysh, Mstislav V., 108  
 Kelleher, John J., 240, 241  
 Keller, Samuel W., 239, 243  
 Kelly, John J., 59  
 Kennedy, John F., 8, 53, 235, 286  
 Kennedy Space Center, 37, 42, 49, 56, 74, 81, 94, 98, 101, 117, 121-24, 207, 214, 217, 221, 226, 239, 327; Launch Complex 39A, 74, 83, 85, 86-90, 103; Launch Complex 39B, 84, 101, 102, 104, 105, 111  
 Kerwin, Joseph P., 94 n, 101, 104  
 Kilgore, Edwin C., 351, 352  
 Kimball, Harold G., 389, 390  
 Kinard, William H., 157  
 King, Charles H., Jr., 57, 60  
 King, James, Jr., 59, 131  
 King, Jan, 189  
 Kiruna Geophysical Observatory, 187  
 Kitt Peak National Observatory, 212, 228  
 Klein, Milton, 351, 352, 374  
 Kleinberg, John M., 353  
 Kleinknecht, Kenneth S., 100  
 Kochendorfer, Fred D., 221  
 Kosygin, Aleksey N., 108  
 Kraemer, Robert S., 129-31, 202, 206  
 Kramer, James J., 351-53, 361, 378, 379  
 Kramer, Melton S., 242  
 Kubasov, Valeriy N., 109, 112  
 Kubart, Jerald R., 57  
 Kunec, Edward J., 6, 7, 60  
 Kupperian, J. R., Jr., 171, 172  
 Kurzhals, Peter R., 352, 353, 372  
 Kurzweg, Hermann H., 351, 352, 360

L

Lageos (Laser Geodynamics Satellite), 36, 238, 239, 245, 259-61, 342, 343, 406  
 Lam, B. C., 6, 7, 60  
 Land, E. W., 60

## L (Continued)

Landsat, 33, 238, 239, 245-47, 331, 335-40, 406; *Landsat 1*, 37, 333, 336, 337, 339, 340; *Landsat 2*, 36, 333, 336, 337, 339-41; *Landsat 3*, 37, 315, 333, 336, 337, 340, 341; *Landsat C*, 340; *Landsat D*, 246

Langley Memorial Aeronautical Laboratory, 389; Pilotless Aircraft Research Division, 29, 387

Langley Research Center, 28, 29, 31, 97, 98, 121, 128, 130, 157, 162, 164, 188, 198, 202, 213, 214, 216, 218, 222, 223, 239, 293, 294, 298, 351, 361, 363, 371-73, 379, 380, 387, 387 n

LaRock, Ralph E., 353

launch vehicles, 1-50, 56; budget, 4, 8-19; characteristics, 4, 20-50; expendable, 3, 5, 7, 20, 54, 61, 62; program management, 5-7, 128, 129; reusable, 3, 5, 7, 8, 20, 22, 38, 42, 43, 54, 61, 114

Lavrov, Ilya V., 109

Lawrence, Frank, 189

Lazar, James, 353, 374

Lea, Wasyl M., Jr., 242

Lederer, Jerome F., 57

Lee, Chester M., 55-57, 59, 60

Lee, W. H., 156

Legostayev, Viktor P., 109

Lehmann, Jules, 240-42

Leicester, University of, 185

Lenoir, William E., 105

Leonov, Alexei A., 109, 112

Lewis Research Center, 22, 23, 25, 31, 38-40, 42, 97, 168, 239, 295, 297, 329, 351, 374-76, 380, 381

Liccardi, Anthony L., 59

Liege, University of, 201

Limberis, William R., 160

Lind, Don L., 105

Lindley, Robert N., 58

Ling Temco Vought Aerospace Corporation, 28, 29, 31

Lockheed: - California Company, 97, 98; Electronics Company, 340; - Georgia, 380; Missiles and Space Company, 25, 31, 32, 43 n, 48, 114, 114 n, 121, 122, 167, 178, 193, 301-2, 328, 342, 344, 424; Propulsion Company, 43 n, 48, 49

Lohman, Robert L., 57-60

London, University College of, 171, 172, 177, 185, 187

Long, James E., 226, 228

Longanecker, Gerald W., 157, 197

Lord, Douglas R., 55-58, 60

Loria, John C., 352

## Los Alamos Scientific

Laboratories, 158, 160, 177, 193, 195, 200

Lousma, Jack R., 94 n, 101, 105, 111

Love, Michael V., 364, 367, 368

Lovejoy, William L., 6

Lovelace, Alan M., 351, 352, 378

Lovell, James A., Jr., 82, 85, 87

Low, George M., 99, 274, 335, 339

Lucas, Thomas V., 389, 390

Lucid, Shannon W., 80 n

Lundholm, Joseph G., 98

Lundin, Bruce T., 351

Lunney, Glynn S., 59, 109

Lyman, Gene E., 352, 353, 373

## M

McBride, Jon A., 80 n

McCandless, Bruce, 104

McCandless, S. Walter, Jr., 242, 243

McCeney, Paul J., 327

McConnell, Dudley, 241, 243

McDivitt, James A., 81, 83

McDonald, Frank B., 154, 155, 169

McDonnell Douglas Astronautics Corporation, 23, 31-33, 37, 43 n, 47-49, 94, 98-101, 114, 121-23, 173, 216

McGolrick, Joseph E., 6, 7, 60

McMurtry, Thomas, 364, 368

McNair, Ronald E., 80 n

McTigue, John, 363, 364

Madden, Jeremiah J., 193-95

Madrid, Spain, 180, 180, 388, 388 n, 389, 402, 405-7, 410, 414, 419, 420, 425

Maggin, Bernard, 352

Mahon, Joseph B., 5-7, 56, 60, 129-31

Malagasay Republic, 405, 406, 406 n, 421

Malkin, Myron S., 55, 56, 59, 60, 114

Mancini, Armondo, 241

Mandeville, Robert L., 240, 241

Manke, John A., 363-68

Manned Orbiting Laboratory, 80, 80 n, 93, 97, 98, 100

Manned Spacecraft Center, 56, 94, 97-101, 114, 115, 121, 122, 239, 337, 338, 371, 373, 387

manned spaceflight, 3, 8, 13, 20-22, 26, 51-124; budget, 61-73; characteristics of, 73-124; program management, 55-60

Manned Spaceflight Network (MSFN), 387, 388, 391-94, 396, 397, 401-6, 414, 415-23

## M (Continued)

Mannheimer, Harry, 242, 243, 280, 327, 336, 337  
 Manville, Robert W., 6, 32  
 Maran, Stephen P., 177, 178  
 Marconi Space and Defense Systems, Ltd., 320, 321  
 Marine Corps, U.S., 80 n  
 Mariner, 23, 41, 128, 129, 133, 141, 202-13, 226; *Mariner 2*, 4, 5, 202; *Mariner 6*, 7, 24, 25, 203, 206, 207, 210, 407; *Mariner 8*, 24, 25, 211; *Mariner 9*, 24, 25, 203, 206, 209, 211, 404; *Mariner 10*, 23-5, 203, 206, 209, 212, 371, 404; Mariner F-I, 206, 207, 209, 211  
 Mariner Jupiter/Saturn 1977, 142  
 Mariner Mars 1969, 141, 202, 203, 204, 206, 207, 210  
 Mariner Mars 1971, 141, 202, 205, 206, 207, 209, 211  
 Mariner Mercury-Venus 1973, 202, 203, 206, 208, 209, 212, 212  
 Marisat 1-3, 36, 290, 311, 312  
 Marshall Space Flight Center, 25-27, 44, 48, 49, 56, 81, 82, 94, 97-103, 116, 118 n, 121, 122, 124, 152, 165, 165 n, 166-70, 239, 342, 343, 371  
 Marsten, Richard B., 130, 239, 241-42, 289  
 Martin Company, 38, 362  
 Martin, James S., Jr., 214, 216, 218  
 Martin Marietta Corporation, 38-42, 43 n, 47-49, 98-100, 114, 114 n, 121, 123, 213, 216, 217, 364, 369  
 Maryland, University of, 154, 155, 158, 160  
 Massachusetts Institute of Technology, 158, 160, 162, 166, 169, 178, 200, 212, 224, 225, 228  
 Mathews, Charles W., 57, 58, 98, 239, 241, 242  
 Mattingly, Thomas K., II, 82, 90  
 Mattson, Roger A., 6, 40  
 Max-Planck-Institut, 186, 190, 193-95, 201  
 May, Ellery B., 27  
 Mayo, Robert P., 127 n, 236 n  
 Melbourne, University of, 314  
 Mercury (program), 21, 53, 61, 74, 80, 81, 97, 108, 334, 387, 388, 422, 423  
 Meredith, Leslie H., 187  
 Merritt Island, Florida, 388 n, 414, 420  
 Messerschmitt Bolkow Blohm, 190, 191  
 Meteosat, 36, 287 n; *Meteosat 1*, 286, 288  
 Michigan, University of, 155, 161, 173, 199, 335-37  
 Milañ, University of, 201

Milder, Nelson L., 242  
 Miller, William E., Jr., 59  
 Mills, Rodney A., 226  
 Milwitky, Benjamin, 58  
 Minnesota, University of, 155, 157, 161, 164, 166, 170, 177  
*Miranda*, 30, 181, 198  
 Misener, Garland C., Jr., 241, 242  
 Mississippi Test Facility, 121  
 Mitchell, Edgar D., 82, 84, 88, 90  
 Mitchell, Jesse, 129, 131, 152  
 Mitsubishi Electric Co., 294  
 Mitz, Milton A., 130  
 Moffett Field, California, 219  
 Mogavero, Louis W., 243  
 Mojave Desert, California, 386 n, 389, 407, 413, 414, 417  
 Morey, Sandra L., 243  
 Morris, Donald R., 241  
 Morrison, James R., 243  
 Moss, Frank E., 339  
 Mueller, George E., 57  
 Mullane, Richard M., 80 n  
 Murphy, James P., 242  
 Musgrave, Story, 104  
 Myers, Dale D., 55-58

## N

Nagel, Steven R., 80 n  
 Nash, Ralph R., 352  
 National Academy of Sciences, 165, 280, 372; Physics Survey Committee, 168; Space Science Board, 167-68, 209  
 National Advisory Committee for Aeronautics, 28, 29, 128, 239, 349, 361, 378, 381, 385, 387, 389  
 National Aeronautics and Space Act, 127  
 National Aeronautics and Space Administration (NASA)  
 Headquarters, 5, 6-7, 9, 11, 23, 25, 29, 31-33, 37, 39, 40, 43, 49, 55-60, 81, 82, 94, 97-102, 114, 114 n, 121, 122, 128-31, 152, 165, 165 n, 166, 167, 171, 172, 175, 176, 203, 207, 209, 214, 216, 221, 226, 231, 238-43, 266-68, 275, 280-82, 289, 295, 327, 337, 338, 342, 351-53, 378, 389, 390, 424; Administration, Office of, 11; Advanced Research and Technology, Office of, 7, 55, 97, 99, 349-56, 359-61, 370, 372-74, 377-81; Aeronautics and Space Technology, Office of, 351-53, 356-59, 361, 369, 372-75, 377-80; Applications, Office of, 237-39, 241, 336;

## N (Continued)

## NASA (Continued)

- budget, 8-19, 26, 38; Manned Space Flight, Office of, 5, 13, 55-59, 61, 62, 68, 94, 97-99, 121, 129-31, 146, 230, 249, 335, 372; Planetary Programs, Office of, 202; Space and Terrestrial Applications, Office of, 239, 243, 336, 337; Space Flight, Office of, 6, 7, 55, 61, 62, 130, 372; Space Science, Office of, 13, 68, 82, 129, 131, 132, 203, 214, 372; Space Science and Applications, Office of, 5, 6, 7, 13, 55, 56, 61, 62, 73, 99, 130, 165 n, 216, 230, 235, 237 n, 238-41, 244, 331, 334, 335; Space Science and Exploration, Office of, 206; Space Transportation Systems, Office of, 7, 56, 62, 372; Tracking and Data Acquisition, Office of, 55, 99, 389-91, 406, 424
- National Environmental Satellite Center, 266
- National Geodetic Satellite Program, 342
- National Meteorological Satellite System, 237
- National Oceanic and Space Administration (NOAA), 4, 157, 158, 160, 161, 193, 238, 266-70, 273, 274, 277, 287, 329, 337, 338, 340, 342; *NOAA 1*, 35, 237, 267, 270-73, 333; *NOAA 2*, 35, 237, 267, 268, 270-71, 287, 314, 333; *NOAA 3*, 35, 237, 267, 268, 271, 272, 287, 333; *NOAA 4*, 36, 37, 192, 237, 267, 268, 272, 315, 333; *NOAA 5*, 36, 237, 267, 268, 273; *NOAA 6*, 287 n, 333
- National Operational Environmental Satellite System, 274 n
- National Operational Meteorology Satellite System, 274
- National Parachute Test Range, 50
- National Research Council (Canada), 196, 197
- National Research Council Space Science Board, 167-68
- National Science Foundation, 8, 11 n, 287
- National Science Teachers Association, 101
- Naugle, John E., 6, 129, 130, 167, 235, 237, 238, 290, 329, 336 n
- Naval Research Laboratory, 128, 153, 156, 166, 169, 173, 177-79, 181, 200, 201, 385, 386, 406
- Navy, U.S. Department of the, 4, 26, 29, 49, 80 n, 287, 289, 290, 298, 311, 322-24, 336 n, 337, 338, 373
- Nelson, Evart D., 196, 197
- Nelson, George D., 80 n
- Ness, N. F., 158
- Netherlands, the, 4, 181, 183, 188, 189, 191
- Newcomb, W. D., Jr., 242
- Newell, Homer E., Jr., 127, 129, 238
- New Hampshire, University of, 173, 178
- New Mexico, University of, 173, 177
- Newton, George P., 199
- Nicks, Oran W., 130, 240, 351
- Nikitin, Boris V., 109
- Nimbus, 33, 237, 238, 245, 250, 253-54, 266, 268, 278-86, 281, 336, 337; *Nimbus 1-7*, 333; *Nimbus 2*, 281; *Nimbus 3*, 32, 277-81, 283, 377; *Nimbus 4*, 32, 279-80, 282, 284, 344; *Nimbus 5*, 35, 253, 279, 280, 282, 284, 287; *Nimbus 6*, 36, 279, 280, 282, 285; *Nimbus 7*, 37, 187, 279, 280, 282, 286, 287 n; Nimbus B, 281, 283, 377; Nimbus D, 284; Nimbus E, 281, 282, 284; Nimbus F, 253, 281, 282, 285; Nimbus G, 253, 268, 281, 282, 286; Nimbus H, 281
- Nippon Electric Company, Ltd., 288
- Nixon, Richard M., 8, 43, 94, 100, 108, 113, 114, 121, 127, 167, 235, 236 n
- Nolan, Bernard T., 242, 243
- Nordberg, William, 280, 283, 284, 337, 340
- Norris, Henry W., 214, 216
- Norris, Theodrick B., 6, 39, 129, 131, 152
- North American Air Defense Command, 102, 103
- North American Aviation, Inc., 98, 121
- North American Rockwell Corporation, 26, 27, 43 n, 48, 100, 114-16, 121-23, 424
- North Atlantic Treaty Organization (NATO), 312-14; NATO 1, 35, 290, 312; NATO 2 (NATOSAT 2), 35, 290, 313; NATO III A-C, 36, 37, 290, 313, 314
- Northrop Corporation, 351, 361-63
- Norway, 184, 187
- Norwegian Institute of Cosmic Physics, 187
- Norwegian Space Committee, 187
- Nuclear Engine for Rocket Applications (NERVA), 354-56, 376-77
- Nysmith, C. Robert, 353
- O
- O'Bryant, William T., 58, 59, 131
- Office of Management and Budget, U.S., 8-11, 239, 268, 282, 339
- Olgilvie, Keith W., 193, 194

## O (Continued)

O'Neill, T. H. R., 242, 266  
 Onizuka, Ellison S., 80 n  
 Opp, Albert G., 221, 327  
 Orbiting Astronomical Observatories, 23, 128, 133, 135, 136, 152, 170-72; *OAO 1, 2* 170; *OAO 3 (Copernicus)*, 24, 25, 152, 170-72; *OAO B*, 24, 25, 170, 171  
 Orbiting Frog Otolith Experiment, 30, 354, 355, 373, 374  
 Orbiting Geophysical Observatories, 128, 133, 135, 151, 172; *OGO 6*, 32, 151, 172, 173  
 Orbiting Solar Observatories, 33, 128, 129, 133, 135, 136, 152, 172-79, 174; *OSO 1*, 174; *OSO 5*, 35, 173, 175-78; *OSO 6*, 33, 35, 173, 175-77; *OSO 7*, 35, 173-76, 174, 178, 402; *OSO 8*, 152, 175, 176, 178, 179; *OSO I-K*, 175, 176  
 Operations Technology Satellite, Orbital Test Satellite: *OTS 1*, 290, 316; *OTS 2*, 37, 290, 316  
 Orezechowski, Richard E., 294  
 Oscar 5, 35, 269, 314; Oscar 6, 35, 290, 314; Oscar 7, 36, 37, 192, 290, 315; Oscar 8, 37, 290, 315  
 Ousley, Gilbert W., 190, 191  
 Overmyer, Robert F., 80 n, 109

## P

*P76-5 Wideband*, 30, 290, 316  
 Packard Bell, 173  
 Paine, Thomas O., 94, 100, 108, 127 n, 176, 213, 216, 235 n, 329, 370  
 Palapa 1, 2, 36, 290, 317  
 Palmdale, California, 115, 118  
 Parell, T., 170  
 Paris Observatory, 193-95  
 Paris, University of, 173, 225  
 Park, Archibald B., 241  
 Parker-Elmer Corporation, 99  
 Parker, Robert A. R., 101  
 Particle Measuring Systems, Inc., 225  
 Pasadena, California, 203, 226, 388  
 Peacock, W., 273  
 Pecors, William T., 336 n  
 Penaranda, Frank E., 352, 353  
 Perkin-Elmer Corporation, 343  
 Peterson, Bruce A., 363  
 Peterson, Donald H., 80 n  
 Peterson, William P., 353  
 Petrone, Rocco A., 57, 59  
 Philco-Ford Corporation, 274, 275, 277-79, 319, 320; Space and Reentry Systems Division, 312-14

Phillips, Samuel C., 57, 81  
 Pickard, Robert H., 175, 178, 274, 278, 279  
 Pieper, George F., 184, 186  
 Pinkler, Donald G., 242  
 Pioneer, 23, 128, 129, 137, 202, 219-25, 377, 385, 389, 407; *Pioneer 5*, 219; *Pioneer 6 and 7*, 141; *Pioneer 8 and 9*, 141, 202; *Pioneer 10 and 11*, 23-25, 141, 219, 220-21, 221-23; *Pioneer E*, 35, 402  
 Pioneer/Helios, 133, 141  
 Pioneer-Jupiter, 202, 219, 222. *See also* *Pioneer 10*  
 Pioneer-Saturn, 202, 219, 223. *See also* *Pioneer 11*  
 Pioneer Venus, 23, 141, 202, 221; *Pioneer Venus 1, 2*, 24, 26, 220, 221, 224, 225  
 Pioneer Parachute Company, 49  
 Pittsburgh, University of, 173  
 Planetary Atmosphere Experiments Test, 30, 369-70  
 Pogue, William R., 94 n, 101, 105  
 Pomeroy, John, 58, 59  
 Pomeroy, William, 351, 379  
 Porter, J. Robert, 240, 241, 336  
 Posner, Jack, 242  
 Potate, John S., 57, 59  
 Powell, Cecil, 363, 364, 366, 367  
 Pozinsky, Norman, 389, 390  
 Pratt & Whitney, 23, 25, 121-23  
 Press, Harry, 280, 283, 284  
 Price, Paul A., 389, 390  
 Princeton University, 172  
 Prior, E. J., 164  
 Purcell, J., 171, 172

## R

Radio Amateur Satellite Corporation, 289, 290, 314, 315  
 Radio and Space Research Station (U.K.), 184, 187  
 RAND Corporation, 97  
 Raney, William P., 239, 243  
 Ranger, 128  
 Ransome, Robin, 352  
 Rasool, S. Ichtiague, 131, 239, 243  
 Rau, D. C., 242  
 RCA (Radio Corporation of America), 4, 269, 270, 273, 275, 290, 318, 336, 339, 340, 387; Alaska Communications, Inc., 318; Astro-Electronics Division, 152, 161, 163, 267, 268, 292, 318, 338, 424; Global Communications, Inc., 318, 425  
 Rea, Donald G., 130

## R (Continued)

- Reeves Instrument Corporation, 387  
 Reiff, Glenn, 130  
 Relay, 236  
 Republic Aviation Corporation, 275  
 Resnick, Judith A., 80 n  
 reusable spacecraft, 113, 121, 362, 372, 385  
 Reynolds, Orr E., 129, 130  
 Richards, James T., Jr., 242  
 Ride, Sally K., 80 n  
 Risso, William P., 241  
 Robbins, William H., 295, 297  
 Roberson, Floyd I., 243  
 Roberts, Leonard, 351  
 Rockwell Corporation, 22; Rocketdyne Division, 22, 23, 32, 33  
 Rockwell International, 54, 75, 114, 123, 124  
 Rogers, Donald P., 240, 241  
 Roman, Nancy, 131  
 Roosa, Stuart A., 82, 88, 90, 91  
 Rose, James T., 59, 60  
 Rosen, Milton W., 131  
 Rosenberg, Jerome D., 240-42, 289  
 Rosman, North Carolina, 386, 386 n, 405, 414, 421, 425  
 Ross, Lawrence J., 23  
 Rossi, Lawrence C., 343  
 Rondebush, William H., 352  
 Rutgers University, 177  
 Ryan, Alfred A., 60
- S
- Sabehhaus, Anthony H., 327, 330  
 Sakura. *See* CS  
 Salmanson, Jay A., 6, 7, 60  
 Salyut, 108  
 Sanford, J. Duke, 241, 243  
 Sanford, Robert G., 295, 297  
 Sargent, Jack, 267, 271, 272, 280, 285, 337, 341  
 San Marco (spacecraft), 152; *San Marco* 3, 30, 179, 181, 199; *San Marco* 4, 30, 181, 199; *San Marco* 5, 179  
 San Marco, Kenya, 28, 154, 157, 158, 162, 185, 199  
 Santa Barbara Research Center, 212, 268  
 satellites: communication, 4, 32, 33, 289-94; earth observation, 331-45; scientific, 20, 127, 128, 129, 179-201; weather, 4  
 Satcom 1, 2, 36, 290, 318  
 Satellite Automatic Tracking Antennas, 386, 415, 417, 419, 422  
 Saturn (launch vehicles), 3, 5, 15, 16, 18, 20, 25, 26, 43, 54, 56, 94; Saturn 1, 26; Saturn IB, 3, 4, 13, 14, 17, 20, 21, 26, 27, 61, 80, 94, 97-102, 104, 105, 109, 111; Saturn IC, 48, 122; Saturn IVB, 54, 74, 94, 98, 99; Saturn V, 3, 4, 13, 14, 18, 20, 21, 26, 27, 61, 63, 72, 74, 80, 83-91, 94, 97, 98-101, 103, 122, 229, 230, 371  
 Saunders, J., 130  
 Savage, Melvyn, 57-60  
 Schardt, Alois W., 129, 131, 152  
 Schardt, Bruton B., 241, 243, 280, 336  
 Scherer, Lee R., 58, 59, 130  
 Schiffer, Robert A., 242, 266  
 Schindler, William R., 32, 33  
 Schmerling, E., 131  
 Schmidt, F. Robert, 6, 7, 23, 60  
 Schmitt, Harrison H., 80, 82, 89, 91  
 Schneider, E. H., 352  
 Schneider, William C., 55, 57-59, 100, 389, 390  
 Schneiderman, D., 211  
 Schnitzer, Emanuel, 97  
 Schnyer, Daniel, 57  
 Schrama, Daniel J., 23  
 Schurmeier, H. M., 210  
 Schweikart, Russell L., 81, 83, 104, 241  
 Schwenk, Carl, 352, 353, 360  
 Science Research Council (U.K.), 179, 184, 197, 201  
 Scout, 3, 4, 6, 7, 14, 18, 20, 21, 28, 29, 31, 60, 133, 150, 154, 156-58, 162, 164, 182-88, 198, 199, 286, 289, 316, 322-24, 342, 345, 369, 370, 374  
 Scobee, Francis R., 80 n, 364, 368  
 Scott, David R., 79, 81-83, 86, 89  
 Scull, Wilfred E., 173, 337, 341  
 Seaborg, Glenn T., 127 n, 236 n  
 Seamans, Robert C., 127 n, 236 n  
 Seasat, 238, 239, 245, 259-62, 333, 342; *Seasat 1*, 342, 344  
 Seddon, Margaret R., 80 n  
 Sedlazeck, Martin F., 241  
 Senate, U.S., 339; Committee on Aeronautical and Space Sciences, 97; Committee on Aeronautics, 378. *See also* Congress, U.S.  
 Shatalov, Vladimir A., 109  
 Shaw, Brewster H., Jr., 80 n  
 Shea, John T., 159  
 Sheffield University (U.K.), 184  
 Shepard, Alan B., Jr., 82, 88  
 Shriver, Loren J., 80 n  
 Silverman, Donald, 241, 242  
 Sirio, 36, 290, 319  
 Skaggs, James B., 57

## S (Continued)

Skylab, 53, 95; airlock module, 94, 95, 98-101, 103; budget, 18, 61, 63-65; crew, 94, 94 n, 96, 101, 102, 129, 331; experiments, 106-8; missions, 13, 26, 27, 54, 230, 339, 402, 405, 414; orbital workshop, 20, 26, 54, 94, 95, 96, 98-101, 103, 129, 372; program, 7, 55-58, 73, 94, 97, 99-108, 140, 165 n, 239, 335; *Skylab 1*, 28, 96, 100, 101, 103-4; *Skylab 2*, 28, 94 n, 96, 101, 102, 104; *Skylab 3*, 28, 94 n, 101, 102, 105; *Skylab 4*, 28, 94 n, 101, 102, 105; student project, 101; vehicles, 14, 17

Skynet 1-4, 35, 290, 319-20; Skynet II A, B, 36, 320-21

Slayton, Donald K., 81, 109, 111, 112

Slone, Henry O., 23

Small Astronomy Satellites, 164

Smith, David, 343

Smith, H. E., 109

Smith, Henry J., 130, 131, 240

Smith, Jon M., 60

Smith, Richard G., 27, 59

Smithsonian Astrophysical Observatory, 161, 169, 342, 386, 406 n, 419

Smylie, Robert E., 109, 351

Soffen, Gerald A., 131, 216

Solar Maximum Mission, 133, 136, 139

*Solrad 10*, 156, 200; *Solrad 11A*, *B*, 179, 181, 200, 201

Sortie Lab Task Force, 55, 59

Southern California, University of, 222, 223

Southwest Center for Advanced Studies, 154, 173

Soviet Academy of Scientists, 108

Soyuz, 108, 109

space applications programs, 235-345; budget, 244-65; management of, 238-43

Space Electric Rocket Test (SERT), 375; SERT 2, 32, 375-76

space science, 125-231; budget, 132-151 life sciences, 230-31; physics and astronomy, 151-201; planetary programs, 202-30; program management, 129-32

Space Shuttle, 3, 5, 13, 14, 20, 22, 31, 38, 43, 44-46, 48, 49, 54-56, 63, 102, 114, 115-17, 119-20, 127, 167, 168, 299, 302, 350, 362, 372, 407, 424, 425; approach and landing tests, 54, 115-16, 117, 118, 123, 124, 303, 407; budget, 61, 69-71, 114, 122;

## Space Shuttle (Continued)

carrier aircraft, 116, 117;  
*Columbia*, 118, 124; crew, 80-81, 114, 116, 117, 118; *Enterprise*, 54, 115, 116, 117, 123; experiments, 146, 263; external tank, 14, 19, 20, 43, 44, 44-46, 47, 49, 70, 115, 117, 118 n, 119-20, 122, 123, 124; interim upper stage, 7, 22, 25, 37, 60, 68; main engine, 14, 19, 43, 44, 47-49, 61, 70, 114, 116, 118 n, 119-20, 121, 122, 375; orbital flight test program, 54, 116, 118; orbiter, 7, 20, 43, 44-46, 47, 49, 56, 61, 69, 113-24, 115, 116, 119-20, 121-24; Orbiter 101, 113, 114, 116, 118, 123, 124; Orbiter 102, 114, 118, 124; program, 7, 55, 56, 59, 60, 121-24; solid rocket boosters, 14, 19, 20, 43-50, 44-46, 47, 48-50, 61, 70, 115, 117, 118 n, 119-20

Space Shuttle Task Force, 55, 58, 114

Space Shuttle Task Group, 48, 121

Space Station, 63, 68, 69, 94, 96, 97, 100, 114, 121

Space Station Task Force, 55, 58, 59

Space Task Group, 43, 113, 121, 127, 127 n, 167, 235, 236 n, 387, 387 n

Space Telescope, 133, 136, 139

Space Tracking and Data Acquisition Network, 386, 387, 390-94, 396, 397, 401, 402, 404, 405, 413, 414-23

Space Transportation System, 5, 13, 19, 20, 22, 37, 43-50, 54, 56, 60, 61, 68, 69, 73, 113-14, 121

Spaceflight Tracking and Data Network, 402, 405-7, 408, 409, 414

Spacelab, 55, 56, 59, 60, 68, 116, 133, 136, 139, 146, 263

Spain, 4, 179, 181

Speer, F. A., 166, 167, 169, 170

Spencer, Nelson W., 161, 163, 173

Spencer, Robert L., 242

Spreen, William C., 240, 241, 266

Sprince, Richard H., 241, 242

Sputnik, 108

Stafford, Thomas P., 81, 84, 109, 111, 112

Stallkamp, J. A., 210

Stanford Research Institute, 224, 225

Stanford University, 167, 173, 193, 195, 212, 228

Stanley, H. Ray, 343

State, U.S. Department of, 102, 287

Stecker, Joseph, 183

Steinbacher, R. H., 211

Stephanides, Chris C., 343

Stephens, R., 161

## S (Continued)

Stevens, Samuel R., 289  
 Stevenson, John D., 57  
 Stewart, Robert L., 80 n  
 Stewart, Rodney D., 167  
 Stock, Richard L., 389, 390  
 Stofan, Andrew J., 39, 40, 131  
 Stone, Robert G., 159  
 Stoney, William E., 57, 59, 239, 242, 336  
 Strass, H. Kurt, 351, 352  
 Sullivan, Frank J., 351, 352, 372  
 Sullivan, Kathryn D., 80 n  
 Summerfelt, William A., 58, 59  
 Summers, Robert A., 240, 241  
 Surveyor, 41, 128, 377; *Surveyor* 3, 54, 74, 86  
 Sweden, 187-89  
 Swetnick, Martin J., 241  
 Swigert, John L., Jr., 82, 87  
 Switzerland, 189  
 Symphonie, 321-22; *Symphonie 1 and 2*, 36, 290, 321-22  
 Synchronous Meteorology Satellite (SMS), 237, 245, 251-52, 266, 274; *SMS 1*, 2, 36, 237, 245, 274, 275, 277, 287, 333; SMS-GOES, 274-76, 276. *See also* Geostationary Operational Environmental Satellite  
 Syncom, 236, 275, 325  
 Syromyatnikoy, Vladimir S., 109  
 Systems for Nuclear Auxiliary Power (SNAP), 354-55, 377

## T

Talbot, Joseph, 188  
 Taut, Larry R., 345  
 Taylor, Charles A., 389, 390  
 Taylor, Eldon D., 130, 240, 241  
 Taylor, William B., 98  
 Technical University of Denmark, 187  
 Telesat of Canada, 290-92, 317  
 Telstar, 236  
 Tepper, Morris, 239, 240-42, 266  
 Terwillinger, Richard G., 242  
 Test and Training (TETR)  
   satellites, 402; *TETR 1*, 2, 402; *TETR 3*, 35, 402; *TETR C*, 35  
 Texas, University of, 161, 197, 225  
 Thagard, Norman E., 80 n  
 Theon, John S., 280, 284-85  
 Thiokol Corporation, 22, 23, 29, 31-33, 43, 43 n, 47-49  
 Thole, John M., 131, 175, 177-78, 327, 330  
 Thome, Pitt G., 130, 239, 240-41, 243, 337  
 Thor, 15, 16, 31; Thor-Agena D, 31, 32, 173; Thor-Delta, 3, 3 n, 4, 20, 21, 31-33, 34, 35-36, 191-92, 231, 299, 301-5, 340; T-D 2914, 180, 193, 195, 197. (*see also* Delta 2914); TD-1A, 35, 37, 181, 201  
 Thorad-Agena, 376; Thorad-Agena D, 3 n, 21, 32, 280, 283, 284, 344  
 Thorley, Gene A., 243  
 Tilford, Shelby G., 243, 266  
 Timco, J. W., 57, 58  
 Tiros (Television Infrared Observation Satellite), 237, 245, 250-51, 253, 266-70, 274, 275, 331; Tiros Operational System (TOS), 237, 245, 250-51, 266, 268, 269; Tiros J, 268; *Tiros M*, 237, 250, 267, 268, 270; *Tiros N*, 22, 237, 250-51, 267, 268, 273, 287 n, 333; Tiros I-X, 333  
 Tischler, Adelbert O., 351, 352, 374  
 Titan, 5, 22, 38, 40, 43, 48, 165, 301; Titan III, 6, 7, 20, 38, 41-42, 60; Titan III A, 38, 41; Titan III B, 41; Titan III C, 3 n, 4, 19, 21, 38, 39, 41, 42, 133, 150, 164, 200, 201, 327, 330; Titan III D, 14, 40-42, 164, 167; Titan III E, 42, 164, 167; Titan-Centaur, 42, 190, 191, 213, 226, 228; Titan III D-Centaur, 38, 216; Titan III E-Centaur, 3, 4, 4, 21, 38, 40-42, 218, 360; Titan Mars 1973, 141, 213, 216  
 Tokyo Shibaura Electric Co., 292  
 TOPO 1 (Topographic Satellite), 342, 344  
 Toronto, University of, 161  
 Townsend, Margorie R., 154, 158, 162  
 tracking and data acquisition, 383-428; budget, 391-401; program management, 389-90; networks, 401-428, 403  
 Tracking and Data Relay Satellite System (TDRSS), 168, 390, 391, 399, 407, 414, 417, 419, 420-22, 424-25, 426-28  
 Tracking and Ground Instrumentation Unit (TAGIU), 387  
 Trainor, James H., 190, 191  
 Transit, 30, 322-24; Transit 1-4, 290  
 Transportation, U.S. Department of, 287, 370, 380  
*Triad OI-IX*, 30, 322; *Triad 2*, 3, 30  
 Truly, Richard H., 80 n, 116, 118  
 Truszynski, Gerald M., 389, 390  
 TRW, Inc., 33, 48, 100, 121, 158, 165, 167-70, 172, 173, 175, 176, 219, 224, 229, 230, 298, 336, 338; Space and Defense Systems, 228, 298



## T (Continued)

TRW Systems Group, Inc., 195, 222, 301-5, 425  
 TU Braunschweig, 186, 190  
 Turtill, Joseph, 242

## U

Union of Soviet Socialist Republics, 3, 8, 53, 54, 108, 109, 287, 287 n  
 United Aircraft Corporation, 100  
 United Kingdom, 4, 181, 187-89, 191, 198, 290, 319-21  
 United Nations, 286, 287  
 United Space Boosters, Inc. 47, 49  
 United States, 3, 53, 54, 108, 109, 127, 128, 168, 179, 235, 238, 240, 267, 286, 287, 290, 294, 315, 372, 378, 388, 389 405  
 United Technology Center, 29, 31, 43 n, 48, 49  
 United Technologies Corporation, 47, 49; Chemical Systems Division, 39, 40, 49  
 Universitat Hamburg, 190

## V

Vance, James L., 58, 59  
 Vandenberg Air Force Base, 28, 42, 122, 239  
 Vanguard (satellite), 128, 386, 406  
 van Hoften, James D. A., 80 n  
 Vietnam war, 8, 236  
 Viking, 38, 40, 42, 129, 133, 142, 202, 203, 206, 213-19, 214, 215, 216-17, 360, 369, 377, 406, 407; *Viking I*, 2, 38, 41, 42, 213, 217-19  
 Vitale, Joseph A., 243  
 von Braun, Wernher, 26, 94, 97, 100  
 von Rosenving, Tycho, 195  
 Vought Corporation, 28, 29, 31  
 Voyager, 38, 40, 41, 129, 133, 142, 202, 209, 213, 216, 226-28, 227; *Voyager I*, 2, 38, 41, 412, 226, 228

## W

Wagner, Carl L., Jr., 182  
 Wagner, Robert L., 58, 59  
 Walker, David M., 80 n  
 Wallops Flight Center, 239, 342, 343, 406  
 Wallops Island, Virginia, 28, 153, 156, 157, 274, 286, 289, 387

Wallops Station, Virginia, 369, 370, 374  
 Walter, Forrest, 241  
 Wash, Charles E., 131  
 Washington, D. C., 180, 239, 424  
 Washington University, 166, 170  
 Waugh, Merle G., 57  
 Weather Bureau, U.S., 237, 274, 277  
 Webb, James E., 216  
 Webster, Kenneth, 389, 390  
 Weiland, Stanley, 267, 280, 284  
 Weitz, Paul J., 94 n, 101, 104  
 Westar 1, 2, 36, 290, 317, 324, 325  
 Western Ontario, University of, 196, 197  
 Western Test Range, 31, 154, 161-64, 182-84, 186-89, 191-92, 196-98, 201, 239, 269-73, 280, 283-86, 314-16, 322-24, 336-37, 340-45, 376  
 Western Union: Space Communications, Inc., 425; Telegraph Co., 2, 290, 324, 325, 425  
 West Germany. *See* Germany, Federal Republic of  
 Wetherington, R. L., 59  
 Whirlpool Corporation, 100  
 White, George C., Jr., 57  
 White, Maynard E., 57  
 White, Robert D., 109  
 White, Robert M., 336 n  
 White Sands Missile Range, 387 n, 401, 414, 422  
 White Sands, New Mexico, 422, 425, 428  
 Wible, M. Keith, 58  
 Wild, Jack W., 6, 7, 57, 58, 60  
 Williams, Donald E., 80 n  
 Williams, Francis L., 239, 242  
 Willoughby, Willis J., 241  
 Wilmarth, Verl R., 58  
 Wilson, Charles A., 231  
 Wilson, Robert G., 130, 131, 241  
 Winter, David, 58, 60, 129, 131  
 Wisconsin, University of, 179, 225  
 Wise, Donald U., 58  
 Wisniewski, Richard J., 352  
 Witt, William, 192  
 Woerner, Charles V., 157  
 Wolfe, John H., 221, 222  
 Wolff, Edward A., 327, 330  
 Woodward, William H., 351, 352, 374  
 Worden, Alfred M., Jr., 82, 86, 89  
 Wrublik, D. P., 154

## Y

Yale University, 161  
 Yardley, John F., 6, 7, 55, 56, 58, 59  
 York University, 197

## Y (Continued)

Young, A. Thomas, 129, 131, 202, 206  
Young, John W., 81, 82, 84, 87, 90, 91  
Young, S., 130

# ABOUT THE AUTHOR

Linda Neuman Ezell, born in Fulton County, Illinois, is a curator at the Smithsonian's National Air and Space Museum (NASM) in Washington, D.C. Her specialty within the Space Science and Exploration Department is manned spaceflight.

She came to NASM from the National Aeronautics and Space Administration (NASA) where, as a contractor, she coauthored two books: *The Partnership: A History of the Apollo Soyuz Test Project* (1978) and *On Mars: A History of NASA's Exploration of the Red Planet* (1984). She also prepared the second volume of the NASA Historical Data Book series, covering the period 1958-1978. Her academic background (A.B., Sangamon State University, Springfield, Illinois; graduate work at the University of Houston and George Washington University) is in American technological history.

