

# DEVELOPMENT OF NEW BEAM POSITION DETECTORS FOR THE NA61/SHINE EXPERIMENT

M. Urbaniak\*, Y. Balkova, S. Kowalski, S. Puławski, K. Wójcik  
University of Silesia, Institute of Physics, Chorzów, Poland

## Abstract

NA61/SHINE is a fixed-target experiment located at the CERN Super Proton Synchrotron (SPS). The development of new beam position detectors is part of the upgrade of the detector system. Two types of detectors have been manufactured and tested. The first one is a scintillating fibers detector with a photomultiplier as a readout. The scintillating fibers detector consists of two ribbons, which are arranged perpendicularly to each other. Each ribbon is made of two layers of 250  $\mu\text{m}$  diameter fibers. The grouping method was used, which allows using of a single multichannel photomultiplier for one detector. The second type of detector is based on the single-sided silicon strip detector (SSD). In this project, Si strips produced by Hamamatsu (S13804) were used, where the pitch has a width equal to 190  $\mu\text{m}$ . The developed detectors must meet several requirements: they should work efficiently with proton and lead beams with beam intensity on the level of 100 kHz, the detector's material on the beam-line should be minimized, and the detectors should be able to determine the position of X and Y hit of each beam particle with maximum possible accuracy.

## INTRODUCTION

NA61/SHINE is a fixed-target experiment located in the North Area of the CERN Super Proton Synchrotron (SPS) [1]. Developing a new Beam Position Detector (BPD) is part of the upgrade of the detection system of the experiment during the Long Shutdown 2 (LS2) upgrade. Two alternative BPD designs are described in the paper.

The NA61/SHINE detector system includes Time Projection Chambers (TPCs), Time of Flight detectors (ToF), and Vertex Detector (VD) downstream of the target. The system's primary goal is to measure the particles produced in the interaction of the beam particles with the target. Additionally, upstream of the target is located a set of beam detectors that provides the identification, timing references, and beam position measurements. The schematic layout of the detector system is shown in Fig. 1.

Beam Position Detectors are used to calculate the trajectory of the incoming beam particle based on its measurement in X and Y planes along the beamline. The new beam position detectors should allow for the measurement of the trajectory of each proton or lead beam particle separately with intensities on the level of 100 kHz with maximum possible accuracy. Additionally, the detector should operate in a vacuum. Two types of detector have been designed and manufactured and are currently being tested: a scintillating fibers detector and a single-sided silicon strip detector.

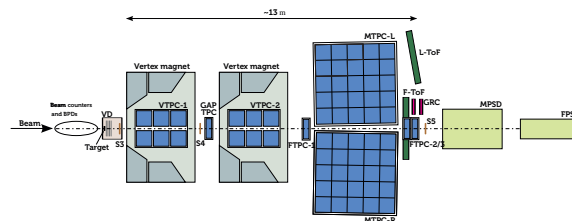

Figure 1: Schematic layout of the NA61/SHINE experiment after the LS2 upgrade.

## SCINTILLATING FIBERS DETECTOR

The scintillating fibers detector consists of two ribbons placed perpendicularly to each other. Such construction allows measuring the position of the particle passage in the XY plane. Each ribbon is made of two layers of scintillating fibers. Saint-Gobain, round shape, double cladding scintillating fibers (BCF-60) with 250  $\mu\text{m}$  diameter were chosen [2]. The BCF-60 has an extra 3HF formulation which increases its radiation hardness. Layers are shifted relative to each other by a distance equal to the radius of a single fiber, which minimizes the detector's dead area. The end of each ribbon is connected to the 256-channel multianode Hamamatsu photomultiplier (H9500). The photo of the prototype detector is presented in Fig. 2.

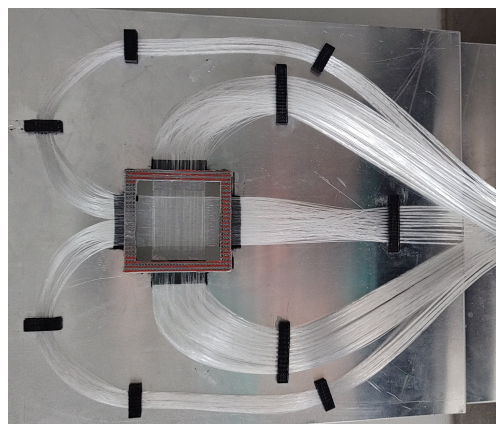

Figure 2: Photo of the scintillating fibers detector.

Finally, grouping of the fibers was implemented to reduce the number of readout channels from 480 to 88. Instead of connecting each fiber to one photomultiplier pixel, ten or twelve fibers are connected into groups and applied to a single pixel. The grouping is as follows: the fiber ends

\* marta.urbania@us.edu.pl

from one side are grouped into 12 groups of contiguous fibers. The other ends of the fibers are grouped based on their position in the first grouping: all first fibers build one group, the second next, etc. Grouping is carried out separately for each layer of the ribbon. After the beam particle passes the ribbon, it generates a signal at both ends of the fiber, which allows for precise position measurement. More details of the grouping method may be found in Ref. [3]. A special matrix has been designed to accurately apply the grouped fibers to the corresponding pixel of the photomultiplier. The matrix is shown in Fig. 3.



Figure 3: Matrix for combining grouped fibers with photomultiplier pixels.

The use of proton and lead beams requires optimizing the detector and its readout for two extreme scenarios. The studies show that only approximately 100 photons will reach the end of the fiber after the passage of the proton beam particle. On the other hand, for the lead nuclei, about 7,000 times more photons will be registered. Results are shown in Fig. 4 for protons and in Fig. 5 for lead nuclei. Additionally, the optical cross-talk between the fibers was studied. Analysis was performed for protons and lead nuclei in the energy range from 10 to 150 GeV per nucleon. The simulation showed that for protons, optical cross-talk is negligible. For lead nuclei, the amount of light leaked to the nearest fibers is, at maximum, on the level of 1% of the light recorded in the struck fiber.

### SILICON STRIP DETECTOR

The second manufactured detector is based on the Hamamatsu S13804 Silicon Strip Matrix [4]. It is a silicon wafer with p-n junctions arranged in a stripe formation. The active area is 97x97 mm<sup>2</sup> in size. The detector has 1024 stripes arranged in two rows. The pitch between the strips is 190 μm. In the final design, two detectors are placed in the 6-way vacuum fitting. One of them determines the position in the X-plane, and the other one, rotated by 90°, determines the position in the Y-plane. The schematic layout of the detector placed in the vacuum fitting is shown in Fig. 6. Detectors are placed on aluminum plates, which stabilize them and

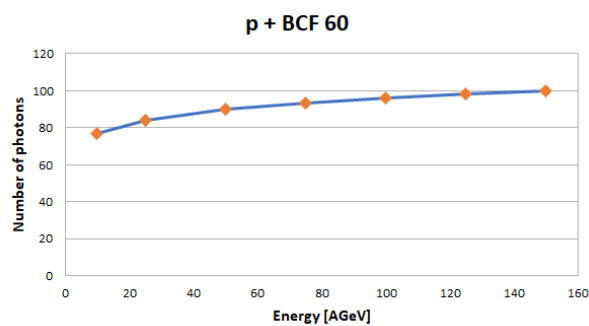

Figure 4: Amount of light at the end of the fiber after the passage of proton.

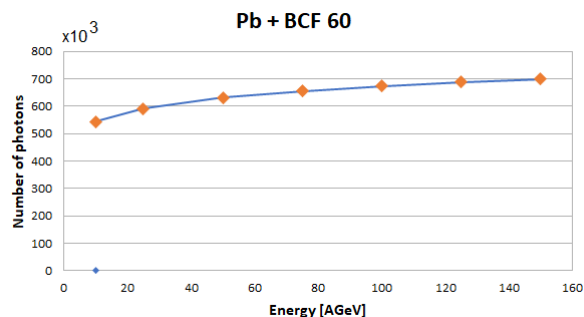

Figure 5: Amount of light at the end of the fiber after the passage of lead nucleus.

ensure that they are in the correct position for the beam. The signal is extracted through ISO-K vacuum flanges with two high-density vacuum feedthrough connectors connected to the detectors by flexible PCB. The photo of the detector is presented in Fig. 7.

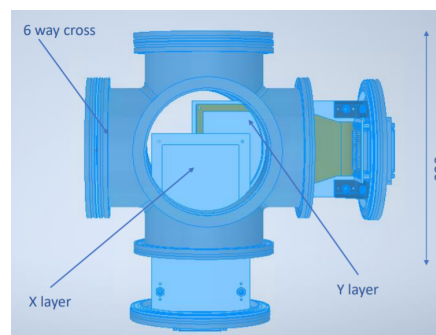

Figure 6: Silicon strip detector in 6-way vacuum fitting.

A dedicated charge amplifier has been manufactured for the detector and is placed outside the vacuum fitting. It consists of a fast and charge-sensitive amplifier, an intermediate amplifier, and an output buffer. Since it was equipped with an electronically-controlled scale-changing feature, the same board is usable for protons and lead nuclei beams. The detector mounted on the beamline is shown in Fig. 8.



Figure 7: Photo of the silicon strip detector.



Figure 8: Silicon strip detector mounted on the beamline.

## TEST RESULTS

Both detectors were tested on a 30 GeV/c proton beam. Tests have shown that the scintillating fibers detector must be tested on a heavy ion beam or a proton beam, with energy that is not near minimum ionization energy. Tests of the strip detector have shown that we can measure the position of passing protons and we can determine the beam profile. However, due to the low signal-to-noise ratio, some signals are lost in the noise, which significantly reduces the detector's performance. An example of a signal from a proton can be seen in Fig. 9. The algorithm for finding the signal and reconstructing the beam position is based on three main pa-

rameters: the signal-to-noise ratio, signal appearance time, and signal rise time. The values of the rise time cut used in the algorithm were selected based on the distribution, which is shown in Fig. 10. Additionally, Fig. 11 shows the distribution of the signal width. An example of a beam profile in the Y position can be seen in Fig. 12.

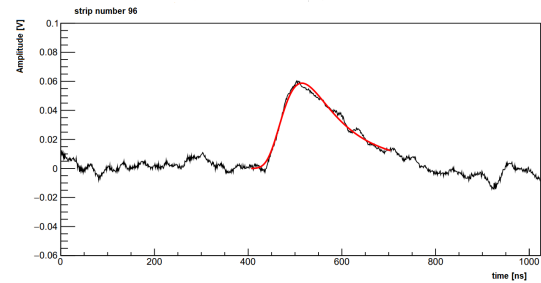

Figure 9: Example of a signal from 30 GeV/c proton, measured by silicon strip detector.

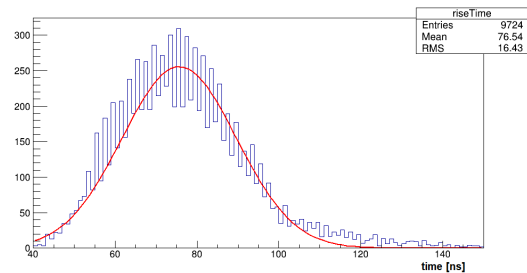

Figure 10: Distribution of the measured signals rise time, by silicon strip detector.

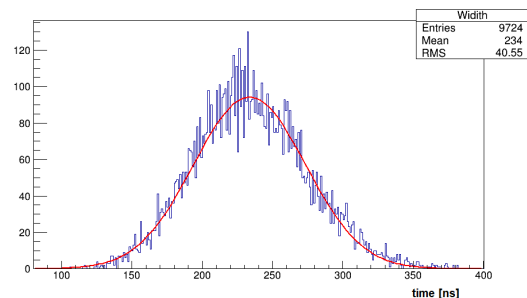

Figure 11: Distribution of the measured signals width, by silicon strip detector.

Currently, the work is ongoing to modify the amplifier to obtain a better signal-to-noise ratio and thus to be able to determine the position of the proton beam with the accuracy assumed during detector construction.

## CONCLUSION

In conclusion, two types of beam position detectors for the NA61/SHINE experiment have been manufactured and

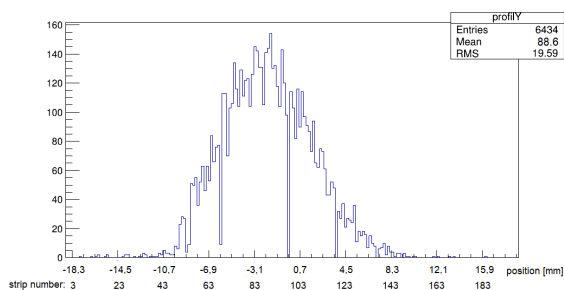

Figure 12: 30 GeV/c protons beam profile in Y position.

are currently being tested. It is planned that both detectors will be used depending on the type of measurement. The estimated positional resolution for silicon strip detector is equal to 190  $\mu\text{m}$ , and for scintillating fiber detector is equal to 125  $\mu\text{m}$ .

The first test results show that the scintillating fiber detector is inefficient for the proton beam with energy near minimum ionization energy. Therefore it will be used for measurements with heavy-ions beams. In addition, tests on protons with energy in the order of several dozen MeV, which, due to higher energy losses in the material, should significantly affect the value of the signal-to-noise ratio, are planned.

Silicon strip detector test results show that we are able to measure the position of the beam particles, but due to

the low signal-to-noise ratio, many signals are lost which reduces the detector performance and requires changes to the amplifier.

## ACKNOWLEDGEMENTS

This work is supported by: National Science Center, Poland Grant No. 2018/31/G/ST2/03910 - BEETHOVEN CLASSIC 3, the Research Excellence Initiative of the University of Silesia in Katowice and Norwegian Financial Mechanism 2014-2021 (grant 2019/34/H/ST2/00585).

## REFERENCES

- [1] N. Abgrall *et al.*, "NA61/SHINE facility at the CERN SPS: beams and detector system", *J. Instrum.*, vol. 9, no. 6, p. P06006, 2014. doi:10.1088/1748-0221/9/06/p06005
- [2] Saint-Gobain, Plastic Fiber, <https://www.crystals.saint-gobain.com/radiation-detection-scintillators/fibers>
- [3] D. Lo Presti *et al.*, "Development of a scintillation-fiber detector for real-time particle tracking", *J. Instrum.*, vol. 8 no. 4, p. P04015, 2013. doi:101088/1748-0221/8/04/P04015
- [4] Hamamatsu, "Single-sided SSD for high energy particle position detection", <https://www.hamamatsu.com/eu/en/product/type/S13804/index.html>