

# Performance Study of MIMO-OFDM Platform in Narrow-band Sub-1 GHz Wireless LANs

Stefan Aust  
NEC Communication Systems, Ltd.,  
1753 Shimonumabe, Nakahara-ku,  
Kawasaki, Kanagawa 211-8666, Japan  
Email: stefanaust@ieee.org

R. Venkatesha Prasad,  
Ignas G.M.M. Niemegeers  
EEMCS, Delft University of Technology,  
P.O. Box 5031, 2600 GA Delft, The Netherlands  
Email: rvprasad@ieee.org;  
I.G.M.M.Niemegeers@tudelft.nl

**Abstract**—Using multiple antennas at the transceivers has become a necessity in high data rate wireless communication systems. Multiple-input multiple-output (MIMO) orthogonal frequency division multiplexing (OFDM) has been adopted as a mandatory modulation scheme in the upcoming IEEE 802.11ah standard. IEEE 802.11ah will specify carrier frequencies for Wireless Local Area Networks (WLANs) operating in the sub-1 GHz band. This is challenging for MIMO-OFDM in sub-1 GHz because of limited bandwidth. Thus building a prototype will provide necessary information to understand this new scenario. We build a prototype in order to test and validate modifications to physical layer (PHY) and media access control (MAC) for narrow-band data transmissions. We present here, in detail, the steps to build a real-time MIMO-OFDM testing platform that is useful for evaluating narrow-band sub-1 GHz transmission characteristics. We analyzed potential MIMO-OFDM implementations and conducted extensive measurements on our platform in order to verify the required system enhancements. This paper gives a hands-on account of designing and testing a sub-1 GHz WLAN platform.

**Index Terms**—WLAN, IEEE 802.11ah, sub-1 GHz, MIMO-OFDM, narrow-band, platform.

## I. INTRODUCTION

The excellent propagation characteristics of frequencies below 1 GHz, such as longer range and better propagation performance, motivates the design of sub-1 GHz wireless communication systems. Studies have shown that sub-1 GHz frequencies have higher reach, e.g., behind vehicles and buildings, where 2.4 GHz WLAN lead to many gray zones [1]. There are already frequencies assigned in different countries allowing the license-free use in the sub-1 GHz ISM (industrial, scientific, medical) radio band, e.g., USA, China, Europe, and Japan. For instance, in Japan the 915-930 MHz band is available for short-range wireless sensors and RFID units [2]. Such sensors can provide a coverage range of up to 70 m line-of-sight (LOS) in indoor locations and up to several hundreds of meter in outdoor environments. Moreover, due to simple modulation schemes, these modules are very power efficient and provide long battery life. Besides the use of sub-1 GHz frequencies for wireless sensors, the IEEE 802.11 work group has started a new standardization project to utilize sub-1 GHz frequencies for WLANs [3]. The IEEE 802.11ah Task Group aims to standardize a long-range WLAN system that will allow up to 1 km range. The modulation scheme proposed will

have to support multi-antenna systems and MAC functions for longer range, robustness and power efficiency.

In order to study the performance of such new WLANs operating at carrier frequencies below 1 GHz, we propose a MIMO platform. We specifically aim at carrier frequencies in the 900 MHz ISM band by using highly flexible Software Defined Radio (SDR) and open-source software. There is no standardized MIMO-OFDM based hardware available that uses carrier frequencies in the sub-1 GHz band. Here, off-the-shelf solutions are not possible. Therefore, we propose a low-cost solution that allows a simple operation of MIMO-OFDM functions using SDR. A platform based on MIMO-OFDM features both in software and hardware is desirable to validate the MIMO performance. A flexible protocol stack would allow us to operate on new standards, such as IEEE 802.11ah. We propose to use an open-source software to design a modular and flexible WLAN platform. The platform should:

- be independent from the carrier frequency  $f_c$ ;
- be easy to reconfigure for new protocol stacks, such as IEEE 802.11ah, IEEE 802.11ac, etc.; and,
- allow MIMO-OFDM operation in narrow-band wireless systems, e.g., 1 MHz.

With the help of our platform we evaluate PHY and MAC building blocks, such as narrow-band channelization and preamble design. Specifically, the contribution of this paper can be summarized as follows:

- 1) we explicate on the issues in applying MIMO-OFDM to narrow-band sub-1 GHz;
- 2) we propose a MIMO-OFDM platform and use software defined radio; and,
- 3) we validate our MIMO-OFDM platform and discuss performance results.

This paper is organized as follows: In Section II motivation for sub-1 GHz WLANs are outlined.

We then present the sub-1 GHz WLAN building blocks in Section III.

The evaluation results of the proposed platform are presented in Section IV and in addition we discuss the strengths and weaknesses of potential MIMO implementations as a basis for our proposed platform. We conclude in Section V.

## II. MOTIVATION FOR SUB-1 GHz MIMO-OFDM

### A. Related Work

Testing platforms for wireless communication, and in particular for MIMO broadband systems, have been widely proposed for cellular systems and WLANs operating at 2.4 GHz or higher carrier frequencies. A low-cost IEEE 802.11n MIMO platform for mesh networks operating at 2.4 GHz using open source software and off-the-shelf 802.11n hardware is proposed in [4]. The authors observed that frame aggregation has major impact on the throughput. However, it was difficult to achieve the expected throughput with the proposed platform. A software defined radio (SDR) system using USRP (Universal Software Radio Peripheral) to evaluate hierarchical modulation schemes at 2.6 GHz to avoid interference from WLAN systems operating at 2.4 GHz is proposed in [5]. Another example of using SDRs is in [6] where a real-time platform using USRP [7] and GnuRadio [8] operating at 2.4 GHz is proposed. The motivation to use USRP in comparison with other small form factor SDRs (Lyrtech or USRP2) is that the USRP has reliable and better user support and allows the use of free open-source software. A modular multi-user (MU) MIMO-OFDM platform using multiple FPGAs with four integrated radio-frequency (RF) chains is proposed in [9]. Although a thorough design approach is proposed, the verification is limited due to the use of expensive FPGAs and proprietary software. A 4×4 MIMO-OFDM platform using FPGAs operating at 902-928 MHz band is discussed in [10]. However, the motivation was to apply the 915 MHz band in order to avoid the highly congested 2.4 GHz band. Results have been reported that verified ray-tracing channel models. However no results were reported on how to design a WLAN MIMO-OFDM system which operates with 1 MHz channel bandwidth.

### B. Rationale for Sub-1 GHz Wireless LANs

Sub-1 GHz WLAN offers many advantages, e.g., simple to use in outdoor environments, excellent propagation characteristics at low frequencies, etc. [11]. In addition, different levels of installation scenarios (license-exempt for low transmission power  $P_{tx}$  ( $P_{tx} < 100$  mW), light licensing for high transmission power ( $P_{tx} > 250$  mW)) are possible. Moreover, high sensitivity and increased link budget improve the reliability of sub-1 GHz. In a nutshell, the advantages can be summarized as:

- 1) Spectrum characteristics:
  - good propagation and penetration;
  - large coverage area and one-hop reach;
  - license-exempt, light licensing.
- 2) Reliability:
  - less congested frequency band;
  - high sensitivity and link margin;
  - available diversity – (frequency, time, space).
- 3) Battery operation:
  - long battery life;
  - short data transmissions.

The IEEE 802.11ah channelization, for United States, South Korea, China, Europe, and Singapore can be found in [3]. We apply the Japanese channelization to our platform using 923 MHz, with 1 MHz channel bandwidth. The *down-clocking*, from 20 MHz down to 1 MHz, need to be applied in order to achieve the narrow-band MIMO-OFDM modulation. Hence, the number of OFDM sub-carriers is significantly reduced and will have an impact on the transmission performance while using narrow-band transmission. We will reflect on specific narrow-band requirements in the following.

### C. The MIMO-OFDM System

MIMO-OFDM is the mandatory modulation scheme for sub-1 GHz WLANs [3]. It allows utilizing the advantages of advanced modulation performance that is already used in IEEE 802.11n at 2.4 GHz in the sub-1 GHz ISM bands. The most important improvement on the PHY layer is the ability to receive and/or transmit simultaneously on multiple antennas which offer a significant enhancement to data rate and channel capacity [5]. A general MIMO model is given by the expression,

$$Y = HX + Z \quad (1)$$

with  $Y$  as the received MIMO signal,  $H$  as complex channel matrix and the transmitted signal  $X$  and  $Z$  as the additive Gaussian noise. For SISO (single-input single-output) the complex channel matrix is given as,

$$h = h_I + j h_Q, \quad (2)$$

with  $h_I$  as the real part and  $h_Q$  the imaginary part of the channel matrix.

For MIMO the Alamouti 2×2 matrix is given by,

$$A = \begin{bmatrix} x_1 & x_2 \\ -x_2^* & x_1^* \end{bmatrix} \quad (3)$$

with  $*$  representing the *complex conjugate* of the transmitted symbol  $x$ . The inverse matrix at the receiver side is given by,

$$H^{-1} = \frac{1}{x_1x_1^* + x_2x_2^*} \begin{bmatrix} x_1 & x_2 \\ -x_2^* & x_1^* \end{bmatrix}. \quad (4)$$

The implementation of the Alamouti matrix allows us to increase the data rate, both for uplink and downlink, by utilizing multiple antennas. We applied the Alamouti matrix in our WLAN MIMO-OFDM platform.

The important feature of IEEE 802.11n compared to legacy WLANs, such as IEEE 802.11b, is the use of wider bandwidth, e.g., 40 MHz, or as in IEEE 802.11ac, 80 MHz, which effectively doubles the throughput. In contrast the upper performance boundary of narrow-band WLAN is not well studied. The theoretical and measured throughput for IEEE 802.11n can be obtained from the *Modulation and Coding Schemes* (MCS) which are listed in Table I and Table II, with MCS rates for  $B = 20$  MHz, non-high-throughput (non-HT), both for SISO (one spatial stream) and MIMO (two spatial streams). Using Shannon's channel capacity formulation,  $C$  which is

TABLE I  
IEEE 802.11n SISO MCS INDEX,  $B = 20$  MHz [12].

MCS	Modulation & coding	Data rate [Mbps]	Spatial stream
0	BPSK, 1/2	6.5	1
1	QPSK, 1/2	13.0	1
2	QPSK, 3/4	19.5	1
3	16-QAM, 1/2	26.0	1
4	16-QAM, 3/4	39.0	1
5	64-QAM, 2/3	52.0	1
6	64-QAM, 3/4	58.5	1
7	64-QAM, 5/6	65.0	1

TABLE II  
IEEE 802.11n  $2 \times 2$  MIMO MCS INDEX,  $B = 20$  MHz [12].

MCS	Modulation & coding	Data rate [Mbps]	Spatial stream
8	BPSK, 1/2	13.0	2
9	QPSK, 1/2	26.0	2
10	QPSK, 3/4	39.0	2
11	16-QAM, 1/2	52.0	2
12	16-QAM, 3/4	78.0	2
13	64-QAM, 2/3	104.0	2
14	64-QAM, 3/4	117.0	2
15	64-QAM, 5/6	130.0	2

defined as the relation of the received signal  $S$  to noise  $N$  given as

$$C = B \cdot \log_2 \left( 1 + \frac{S}{N} \right), \quad (5)$$

with  $B$  as the channel bandwidth in Hz, the upper boundary for throughput of a wireless system at different channel bandwidths can be identified. Robust narrow-band MCS rates have been proposed for IEEE 802.11ah, providing 1 Mbps and 2 Mbps data rates, which aim to support long-range (up to 1 km) coverage with 1 MHz and 2 MHz channel bandwidth [3]. However, it is not known yet that such data rates can be achieved in narrow-band WLAN systems. In the following we will outline our proposed narrow-band WLAN MIMO-OFDM system and discuss the observed throughput limits.

### III. BUILDING BLOCKS OF THE PLATFORM

#### A. Hardware

There are two challenges when setting up SDRs. First, it can be very cost intensive due to the non-standardized hardware. However, we selected the USRP, because it has significant advantages. There is a large community to support all kinds of USRP boards and setups. Other vendors, e.g., MATLAB<sup>TM</sup>, also have started to support data exchange with USRP devices. The other advantage is that the USRP daughter-boards can be switched to other frequencies while using the same protocol stack. The higher costs of USRP can be easily surmounted by using free open-source communication building blocks, such as GnuRadio [8]. However, we found that there is a second challenge while using SDRs. Some software setups for USRPs highly depend on the hardware (here the RF daughter-boards

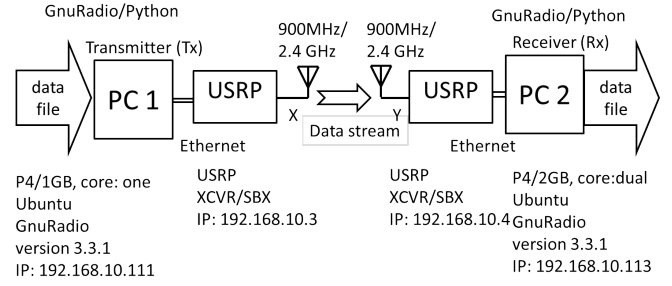

Fig. 1. Platform SISO setup with single USRP (one spatial stream).

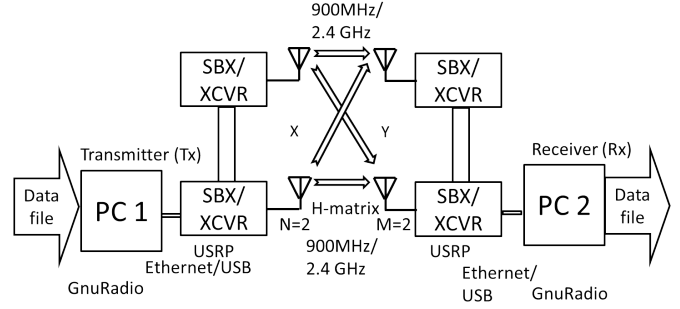

Fig. 2. Platform  $2 \times 2$  MIMO setup with two USRPs (two spatial streams).

used). We will discuss the problems below when we evaluate the platform candidates.

We selected the SBX USB daughter-boards which provide a frequency range from 400 MHz up to 4.4 GHz, with a nominal noise figure of 4 dB. Incidentally, SBX supports the sub-1 GHz band so that this board is useful for transmitting a MIMO-OFDM modulated signal, e.g., at  $f_c = 923$  MHz. Transmission power can be selected anywhere between 30 mW - 100 mW. Moreover, the SBX frequency range covers cellular, Wi-Fi (2.4 GHz band) and WiMAX bands. In addition, we used the XCVR2450 USRP daughter-boards which provide a frequency range between 2.4 GHz - 2.5 GHz and 4.9 GHz - 5.9 GHz which allow us the setup of IEEE 802.11n WLANs.

Fig. 1 shows the platform setup for SISO communication. The setup consists of 2 personal computers and 1 USRP at the transmitter (Tx) and the receiver (Rx). Fig. 2 shows the overall system architecture of the proposed multi-antenna MIMO-OFDM setup, consisting of one transmitter and one receiver, both with two USRP boards attached. The figure illustrates the H-matrix of a  $2 \times 2$  MIMO-OFDM setup. For the evaluation of non-certified radio systems, we used a shielded location to avoid any interference with public wireless networks.

#### B. Software

Our platform has Ubuntu Linux, version 11.04, running on two Pentium-4 PCs. The platform needs to be highly flexible, operating at different frequency bands including sub-1 GHz, 2.4 GHz and higher. Here, we propose the use of software radio platforms. Further, the platform should also allow modifications to hardware and software on each of the

lower ISO/OSI layers to apply MIMO-OFDM for different systems, e.g., PHY down-clocking operations and MAC frame aggregation. Therefore, we are looking up to open-source solutions, which can be easily tested and extended for our purposes.

We tested two potential MIMO implementations, an implementation called  $802.11n^+$  or simply  $n^+$  [13], and a solution called *Hydra* [14]. Both implementations aim at providing building blocks for MIMO support.

$n^+$  provides a basic MIMO framework for transmitting a pre-designed traffic pattern which is then decoded in off-line fashion using MATLAB<sup>TM</sup>. We found that this solution is hard to verify due to a proprietary MIMO implementation – light-weight RTS/CTS, no acknowledgements (ACKs). It also has an inefficient off-line procedure that requires the received signal to be transferred to the MATLAB<sup>TM</sup> user space, where the Fast Fourier Transform (FFT) operation is executed. Main drawback of  $n^+$  is that no two-way communication is supported.

In contrast Hydra claims to support IEEE 802.11n basic features and runs in on-line fashion, i.e., data files can be decoded in real-time at the receiver. Hydra comes with a support for 2-way communication and offers more control over the communication protocol and enables the development of optional features, including framing and block ACKs. Hydra comes with a library that supports limited core functions of IEEE 802.11n operation.

Hydra utilizes the USRP boards as RF front-ends for wireless setup. When comparing various USRP types, the USRP2 supports only single internal RF daughter-boards. This would require two USRP2 and an external clock to operate a  $2 \times 2$  MIMO system. In contrast, the USRP1 supports two internal RF boards, which we used in our WLAN platform using two SBX boards. We compare the building blocks in Table III.

### C. Proposed Modifications

There is a significant software dependency on the USRP RF daughter-boards, as we have stated above. When using Hydra, the use of the XCVR 2450 daughter-board is required in order to execute wireless data communication in the 2.4 GHz band, which is Hydra’s default frequency-band. Software

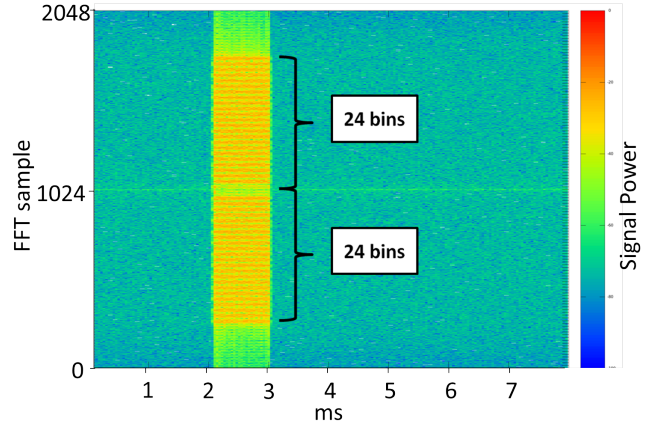

Fig. 3. FFT spectrum screenshot of OFDM signal (packet length 20 bytes) showing single data frame with 48 sub-carriers (bins) when using  $n^+$ .

modifications are needed to operate Hydra on different carrier frequencies, e.g.,  $f_c = 923$  MHz when using SBX daughter-boards. To solve the problem of controlling the SBX board with Hydra, we studied the differences in the hardware architecture of both daughter-boards, the XCVR 2450 and SBX. An intensive study gave us insight into the hardware architecture and how the communication channels and bit-sequences of both daughter-boards are defined [7]. For example, we found that the I/O-control is somewhat different which required significant changes on the serial USRP interface, which we then implemented as a new UHD (USRP Hardware Driver) software library to support SBX boards. We added the new Hydra library in order to support two synchronized SBX boards operating at  $f_c = 923$  MHz and without the use of any external clock synchronization. We found that GnuRadio, version 3.2.2, [8] is a valid compromise which supports Hydra, the modified UHD driver, and the SBX board.

## IV. PLATFORM EVALUATION RESULTS

We conducted extensive field trials to evaluate the performance of two implementations,  $n^+$  and Hydra. The objective is to evaluate the selected hardware and software in order to verify the basic MIMO-OFDM operations and to identify performance boundaries of our proposed WLAN platform.

### A. $n^+$ Performance Evaluation

First, we setup a WLAN platform using  $n^+$  to transmit MIMO-OFDM signals. We observed that the implementation by  $n^+$  is somewhat limited, mainly due to the software design which does not include IEEE 802.11 basic PHY and MAC operations. Fig. 3 shows a screenshot of an OFDM signal of a single data packet (packet length 20 bytes) when using  $n^+$ . It shows 48 OFDM sub-carriers with an observed sending power at 0 dBm. Fig. 4 shows the transmission results of the OFDM signal while using the SISO platform configuration after off-line decoding with MATLAB<sup>TM</sup>. It shows the increased slope (real part) over the sub-carrier. The receiver correctly demodulates the transmitted OFDM signal.

TABLE III

COMPARISON OF BUILDING BLOCKS OF THE EVALUATED SYSTEMS  
(LEGEND: “✓”:=SUPPORTED; “-”:=NOT SUPPORTED).

Building blocks	$n^+$	Hydra	Proposed platform
GNU Radio	✓	✓	✓
MIMO-OFDM	✓	✓	✓
XCVR 2450 support (2.4 GHz)	✓	✓	✓
2-way communication	-	✓	✓
On-line FFT/IFFT	-	✓	✓
Internal clock	-	✓	✓
SBX support (sub-1 GHz)	-	-	✓
Narrow-band (1-16 MHz)	-	-	✓
802.11n MAC (BACK)	-	-	✓

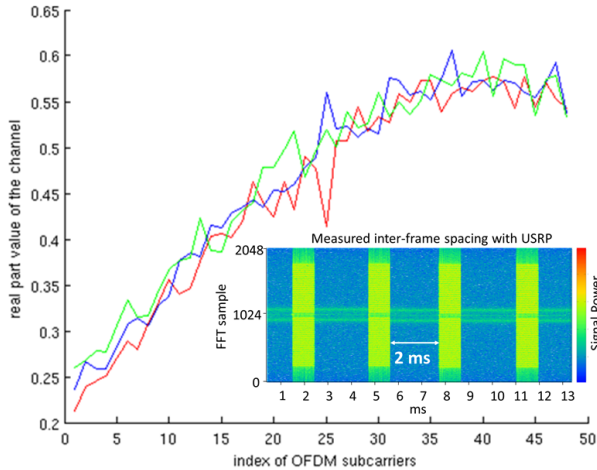

Fig. 4. Result of OFDM transmission showing the performance of the real-part over OFDM sub-carriers when using  $n^+$  SISO configuration.

It is worth noting that a continuous data transmission with  $n^+$  was not possible. Only one single data frame is transmitted, modulated as MIMO signal, which then has to be demodulated off-line using MATLAB<sup>TM</sup>. We added a new software library which would allow us to transmit a continuous data flow with  $n^+$ . The results of transmitting multiple data packets with  $n^+$  is shown in Fig. 4, indicating the measured inter-frame spacing time of 2 ms. We conclude that  $n^+$  is not our favorite candidate simply due to the required off-line demodulation procedure.

### B. Hydra Performance Evaluation

To identify Hydra’s performance boundaries, we measured the round trip time (RTT), packet error rate (PER), channel gain, and data rate for sub-1 GHz SISO and MIMO configuration. We limited our measurement campaign using MCS 0 to MCS 4 for SISO and from MCS 8 to MCS 12 for the MIMO setup, due to the significant increase in error rate for higher MCS rates which indicates significant performance limits of higher modulation rates for narrow-band data transmission at 1 MHz, which we observed in our setup.

To verify the wireless link performance we tested the channel gain of  $2 \times 2$  MIMO in a shielded location. The channel gain measurement results (graphs not shown due to paucity of space and for brevity) is given in Table IV, indicating a robust gain performance over the MIMO link (MCS 8) compared to SISO (MCS 0) at  $f_c = 923$  MHz. The observed PER of the received packet index was below 2%. We then confirmed

TABLE IV  
MEASURED MIMO-OFDM CHANNEL GAIN (MIMO VS. SISO).

Setup	$f_c$	Gain [dB]
MIMO	923 MHz	70
MIMO	2.4 GHz	64
SISO	923 MHz	58
SISO	2.4 GHz	52

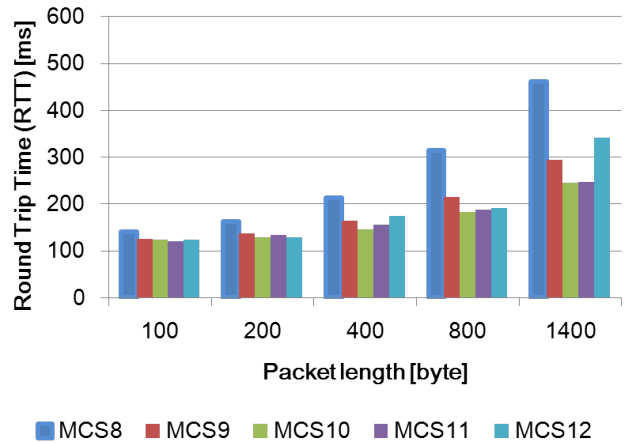

Fig. 5. Observed  $2 \times 2$  MIMO-OFDM delay performance for different ICMP packet length (100, 200, 400, 800, 1400 byte) and MCS 8 to MCS 12 at  $f_c = 923$  MHz,  $B = 1$  MHz.

that the performance is similar compared to results from the literature [15].

Next, we report on the delay and throughput performances of our platform. We used the Internet Control Message Protocol (ICMP) which gives the highest data rate due to less protocol overhead. In addition, we are interested in potential drawbacks and limitations when User Datagram Protocol (UDP) and Transmission Control Protocol (TCP) are used. In particular, the TCP performance will indicate the lower boundaries of our platform, because any transmission limitations would lead to TCP retransmissions.

Then, we report on the MIMO delay performance which is given in Fig. 5. The measurement indicates an increased delay at 461 ms (MCS 8) for 1400 byte packet length. Lowest delay values have been measured at 245 ms (MCS 10).

Next, we show the throughput performance of our  $2 \times 2$  MIMO-OFDM narrow-band WLAN platform in Fig. 6.

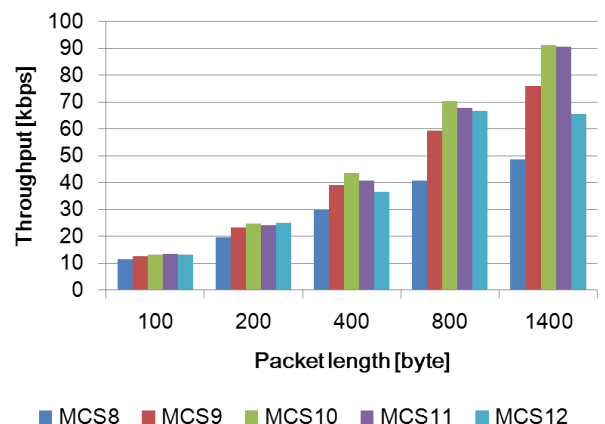

Fig. 6. Observed  $2 \times 2$  MIMO-OFDM throughput performance for different ICMP packet length (100, 200, 400, 800, 1400 byte) and MCS 8 to MCS 12 at  $f_c = 923$  MHz,  $B = 1$  MHz.



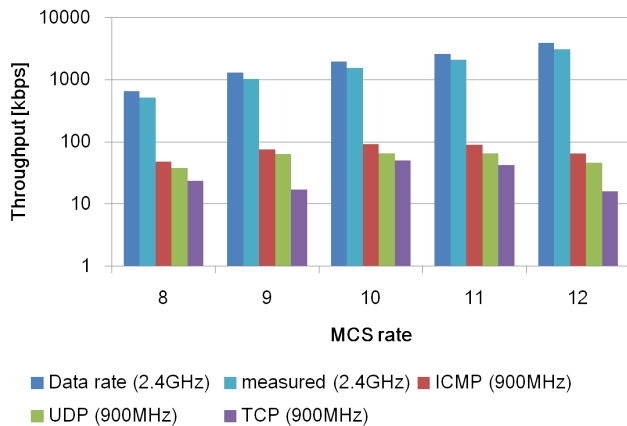

Fig. 7. Observed sub-1 GHz  $2 \times 2$  MIMO performance in a shielded location, ICMP packet length 1400 byte (in addition, we illustrate the upper boundary of data rate at 2.4 GHz  $2 \times 2$  MIMO IEEE 802.11n,  $B = 1$  MHz).

In Fig. 6 it can be observed that the throughput increases for larger packet length (100, 200, 400, 800, 1400 byte) and reaches 91.31 Mbps for 1400 byte ICMP packet length (MCS 10). We observed that higher MCS rates lead to saturated throughput, due to the limited channel bandwidth.

Next, we report on the sub-1 GHz data rates. In order to identify the upper boundaries, we added the results of IEEE 802.11n  $2 \times 2$  MIMO ICMP throughput measurements taken at 2.4 GHz with chip-based Wi-Fi, at 1 MHz channel bandwidth by applying (5) and MCS rates from Table II. Fig. 7 summarizes the throughput measurement results. The highest throughput was measured at 91.31 kbps (MCS 10). Compared with the highest throughput for single antenna system (SISO), which we measured at 87.8 kbps (MCS 2) for ICMP, we conclude that MIMO indeed increases the performance (graphs not shown due to paucity of space and for brevity). In order to validate the sub-1 GHz WLAN throughput performance we compare the observed throughput with the theoretical throughput of IEEE 802.11n. Fig. 7 illustrates that the chip-based WLAN performance is 10 times higher compared to our proposed software-based WLAN platform, due to the real-time software decoding of captured WLAN signals that somewhat limits the performance.

Finally, we report on the UDP and TCP transmission performance. Fig. 7 indicates the highest throughput for UDP measured at 64.7 kbps (MCS 10) and 50.2 kbps (MCS 10) for TCP. The reduction of UDP and TCP data rate is within a regime (30% for UDP, 45% for TCP) which is reasonable due to the increased protocol overhead and also due to the tunneling the captured datagram to the Linux network-stack in Hydra. The TCP performance gives us the insight that the MIMO-OFDM setup is reliable due to the data rate which is not significantly reduced compared to UDP (comparing ICMP, UDP, and TCP throughput performance at MCS 10 in Fig. 7). For operating in a shielded location with 1 m distance between the transmitters, the achieved performance gain is reasonable, which is somewhat limited in our selected experimental setup.

## V. CONCLUSIONS

In this article, we presented the motivations for the need for a MIMO-OFDM platform operating in narrow-band sub-1 GHz. We proposed a real-time MIMO-OFDM platform which operates in the 915-930 MHz ISM band. Our hardware and software solution fulfils the basic modulation requirements and allows an easy modification of the ISO/OSI protocol stack.

To the best of our knowledge this platform is one of the first ones to give a hands-on account of designing and testing a sub-1 GHz platform. We evaluated two potential MIMO implementations and gave a detailed design description of our MIMO-OFDM platform, which is useful for evaluating modulation schemes for narrow-band sub-1 GHz wireless systems. We contributed on extensive measurements in order to validate the novel software enhancements and we identified the performance boundaries of our sub-1 GHz platform using ICMP, UDP, and TCP data transmissions. Next we will enhance the platform by applying a  $4 \times 4$  MIMO-OFDM system to study the possible performance gains and hardware setup, such as low diameter antenna patterns for sub-1 GHz systems.

## REFERENCES

- [1] T. Hikita, T. Kasai, A. Yoshioka, *Integrated Simulator platform for Evaluation of Vehicular Communication Applications*, in the Proceedings of the 2008 IEEE International Conference on Vehicular Electronics and Safety, Columbus, OH, USA, 22-24 September, 2008.
- [2] Association of Radio Industries and Business (ARIB), *915-930 MHz-Band Telemeter, Telecontrol and Data Transmission Radio Equipment for Specified Low Power Radio Station*, English translation, ARIB STD-T108 Ver. 1.0, June 6, 2012.
- [3] Status of Project IEEE 802.11ah, IEEE P802.11 - Task Group AH-Meeting Update, [http://www.ieee802.org/11/Reports/tgah\\_update.html](http://www.ieee802.org/11/Reports/tgah_update.html).
- [4] A. Zubow, R. Sombrutzki, *A low-cost MIMO mesh testbed based on 802.11n*, in the Proceedings of the Wireless Communications and Networking Conference (WCNC), 2012, pp. 3171-3176.
- [5] H. Chang, H. Jin, X. Zhang, D. Liang, M. Peng, W. Wang, *A Software Defined Radio Scheme for the Hierarchical Modulation Based Multimedia Broadcast System Using USRP*, in the Proceedings of the 6th Wireless Communications and Mobile Computing (WiCOM), 2010, pp. 1-4.
- [6] R. C. Qiu, Z. Chen, N. Guo, *Towards A Real-time Cognitive Radio Network Testbed: Architecture, Hardware Platform, and Application to Smart Grid*, the 5th IEEE Workshop on Networking Technologies for Software Defined Radio (SDR) Networks, 2010, pp. 1-6.
- [7] Ettus Research, July 2012 [Online]. Available: <http://www.ettus.com/>.
- [8] GNU Radio, July 2012 [Online]. Available: <http://www.gnuradio.org/>.
- [9] M. Wenk, P. Luethi, T. Koch, P. Maechler, N. Felber, W. Fichter, M. Lerjen, *Hardware platform and implementation of a real-time multi-user MIMO-OFDM testbed*, in the Proceedings of the IEEE International Symposium on Circuits and Systems (ISCAS), 2009, pp. 789-792.
- [10] P. Goud Jr., R. Hang, D. Truhachev, C. Schlegel, *A Portable MIMO Testbed and Selected Channel Measurements*, EURASIP Journal on Applied Signal Processing, vol. 2006, article id 51490, pp. 1-11.
- [11] J. S. Seybold, *Introduction to RF Propagation*, Wiley, 2005.
- [12] IEEE Standard for Information technology - Telecommunications and information exchange between systems Local and metropolitan area networks - IEEE Standards Association, Part 11. Wireless LAN Medium Access Control (MAC) and Physical Layer (PHY) Specifications, IEEE Std 802.11-2012, 29 March 2012.
- [13] K. C.-J. Lin, S. Gollakota, D. Katabi, *Random Access Heterogeneous MIMO Networks*, ACM SIGCOMM 2011 Conference, 2011.
- [14] K. Mandke, S.-H. Choi, G. Kim, R. Grant, R.-C. Daniels, W. Kim, R.W. Heath, S.M. Nettles, *Early Results on Hydra: A Flexible MAC/PHY Multihop Testbed*, 65th IEEE Vehicular Technology Conference (VTC2007-Spring), 22-25 April, 2007, pp. 1896-1900.
- [15] A.A. Abdulla, N.G. Tarhuni, *MIMO Channel Gain Mechanisms Relative to SISO Channel*, International Conference on Communication, Computer and Power (ICCCP 09), 2009, pp. 401-404.