

# FUJIFILM

BL02401-102 **EN**

DIGITAL CAMERA

# X100S

## Owner's Manual

Thank you for your purchase of this product. This manual describes how to use your FUJIFILM X100S digital camera and install the supplied software. Be sure that you have read and understood its contents before using the camera.

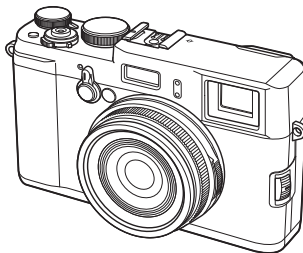

For information on related products, visit our website at  
[http://www.fujifilm.com/products/digital\\_cameras/index.html](http://www.fujifilm.com/products/digital_cameras/index.html)

For more information on the X100S, visit  
<http://fujifilm-x.com/x100s/>

Before You Begin

First Steps

Basic Photography  
and Playback

Basic Movie Recording  
and Playback

The Q (Quick Menu) Button

More on Photography  
and Playback

Menus

Connections

Technical Notes

Troubleshooting

Appendix

Exif Print

SXC1

PictBridge

HDMI®  
HIGH-DEFINITION MULTIMEDIA INTERFACE

### IMPORTANT SAFETY INSTRUCTIONS

- **Read Instructions:** All the safety and operating instructions should be read before the appliance is operated.
- **Retain Instructions:** The safety and operating instructions should be retained for future reference.
- **Heed Warnings:** All warnings on the appliance and in the operating instructions should be adhered to.
- **Follow Instructions:** All operating and use instructions should be followed.

#### Installation

**Power Sources:** This video product should be operated only from the type of power source indicated on the marking label. If you are not sure of the type of power supply to your home, consult your appliance dealer or local power company. For video products intended to operate from battery power, or other sources, refer to the operating instructions.

**Grounding or Polarization:** This video product is equipped with a polarized alternating-current line plug (a plug having one blade wider than the other). This plug will fit into the power outlet only one way. This is a safety feature. If you are unable to insert the plug fully into the outlet, try reversing the plug. If the plug should still fail to fit, contact your electrician to replace your obsolete outlet. Do not defeat the safety purpose of the polarized plug.

**Alternate Warnings:** This video product is equipped with a three-wire grounding-type plug, a plug having a third (grounding) pin. This plug will only fit into a grounding-type power outlet. This is a safety feature. If you are unable to insert the plug into the outlet, contact your electrician to replace your obsolete outlet. Do not defeat the safety purpose of the grounding type plug.

**Overloading:** Do not overload wall outlets and extension cords as this can result in a risk of fire or electric shock.

**Ventilation:** Slots and openings in the cabinet are provided for ventilation, to ensure reliable operation of the video product and to protect it from overheating, and these openings must not be blocked or covered. The openings should never be blocked by placing the video product on a bed, sofa, rug, or other similar surface.

This video product should not be placed in a built-in installation such as a bookcase or rack unless proper ventilation is provided or the manufacturer's instructions have been adhered to. This video product should never be placed near or over a radiator or heat register.

**Attachments:** Do not use attachments not recommended by the video product manufacturer as they may cause hazards.

**Water and Moisture:** Do not use this video product near water—for example, near a bath tub, wash bowl, kitchen sink, or laundry tub, in a wet basement, or near a swimming pool, and the like.

**Power-Cord Protection:** Power-supply cords should be routed so that they are not likely to be walked on or pinched by items placed upon or against them, paying particular attention to cords at plugs, convenience receptacles, and the point where they exit from the appliance.

**Accessories:** Do not place this video product on an unstable cart, stand, tripod, bracket, or table. The video product may fall, causing serious injury to a child or adult, and serious damage to the appliance. Use only with a cart, stand, tripod, bracket, or table recommended by the manufacturer, or sold with the video product. Any mounting of the appliance should follow the manufacturer's instructions, and should use a mounting accessory recommended by the manufacturer.

An appliance and cart combination should be moved with care. Quick stops, excessive force, and uneven surfaces may cause the appliance and cart combination to overturn.



#### Antennas

**Outdoor Antenna Grounding:** If an outside antenna or cable system is connected to the video product, be sure the antenna or cable system is grounded so as to provide some protection against voltage surges and built-up static charges. Section 810 of the National Electrical Code, ANSI/NFPA No. 70, provides information with respect to proper grounding of the

mast and supporting structure, grounding of the lead-in wire to an antenna discharge unit, size of grounding conductors, location of antenna discharge unit, connection to grounding electrodes, and requirements for the grounding electrode.

#### EXAMPLE OF ANTENNA GROUNDING AS PER NATIONAL ELECTRICAL CODE

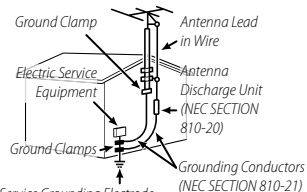

Power Service Grounding Electrode System (NEC ART 250, PART H)

**Power Lines:** An outside antenna system should not be located in the vicinity of overhead power lines or other electric light or power circuits, or where it can fall into such power lines or circuits. When installing an outside antenna system, extreme care should be taken to keep from touching such power lines or circuits as contact with them might be fatal.

#### Use

**Cleaning:** Unplug this video product from the wall outlet before cleaning. Do not use liquid cleaners or aerosol cleaners. Use a damp cloth for cleaning.

**Object and Liquid Entry:** Never push objects of any kind into this video product through openings as they may touch dangerous voltage points or short out parts that could result in a fire or electric shock. Never spill liquid of any kind on the video product.

**Lightning:** For added protection for this video product receiver during a lightning storm, or when it is left unattended and unused for long periods of time, unplug it from the wall outlet and disconnect the antenna or cable system. This will prevent damage to the video product due to lightning and power-line surges.

**Service**

**Service:** Do not attempt to service this video product yourself as opening or removing covers may expose you to dangerous voltage or other hazards. Refer all servicing to qualified service personnel.

**Damage Requiring Service:** Unplug this video product from the wall outlet and refer servicing to qualified service personnel under the following conditions:

- When the power-supply cord or plug is damaged
- If liquid has been spilled, or objects have fallen into the video product.
- If the video product has been exposed to rain or water.
- If the video product has been dropped or the cabinet has been damaged.

If the video product does not operate normally follow the operating instructions. Adjust only those controls that are covered by the operating instructions as an improper adjustment of other controls may result in damage and will often require extensive work by a qualified technician to restore the video product to its normal operation.

When the video product exhibits a distinct change in performance—this indicates a need for service.

**Replacement Parts:** When replacement parts are required, be sure the service technician has used replacement parts specified by the manufacturer or have the same characteristics as the original part. Unauthorized substitutions may result in fire, electric shock or other hazards.



**Safety Check:** Upon completion of any service or repairs to this video product, ask the service technician to perform safety checks to determine that the video product is in proper operating condition.

**Be sure to read these notes before use****Safety Notes**



- Make sure that you use your camera correctly. Read these safety notes and your *Owner's Manual* carefully before use.
- After reading these safety notes, store them in a safe place.

**About the Icons**

The icons shown below are used in this document to indicate the severity of the injury or damage that can result if the information indicated by the icon is ignored and the product is used incorrectly as a result.

	<b>WARNING</b>	This icon indicates that death or serious injury can result if the information is ignored.
	<b>CAUTION</b>	This icon indicates that personal injury or material damage can result if the information is ignored.

The icons shown below are used to indicate the nature of the instructions which are to be observed.

	Triangular icons tell you that this information requires attention ("Important").
	Circular icons with a diagonal bar tell you that the action indicated is prohibited ("Prohibited").
	Filled circles with an exclamation mark indicate an action that must be performed ("Required").

**WARNING**

**If a problem arises, turn the camera off, remove the battery, and disconnect and unplug the AC power adapter.** Continued use of the camera when it is emitting smoke, is emitting any unusual odor, or is in any other abnormal state can cause a fire or electric shock. Contact your FUJIFILM dealer.

**Do not allow water or foreign objects to enter the camera.** If water or foreign objects get inside the camera, turn the camera off, remove the battery, and disconnect and unplug the AC power adapter. Continued use of the camera can cause a fire or electric shock. Contact your FUJIFILM dealer.



Unplugging from power socket



Do not use in the bathroom or shower

**WARNING**

**Do not use the camera in the bathroom or shower.** This can cause a fire or electric shock.



Do not disassemble

**Never attempt to change or take apart the camera (never open the case).** Failure to observe this precaution can cause fire or electric shock.

**Should the case break open as the result of a fall or other accident, do not touch the exposed parts.** Failure to observe this precaution could result in electric shock or in injury from touching the damaged parts. Remove the battery immediately, taking care to avoid injury or electric shock, and take the product to the point of purchase for consultation.



Do not touch internal parts

**Do not change, heat or unduly twist or pull the connection cord and do not place heavy objects on the connection cord.** These actions could damage the cord and cause a fire or electric shock. If the cord is damaged, contact your FUJIFILM dealer.



**Do not place the camera on an unstable surface.** This can cause the camera to fall or tip over and cause injury.



**Never attempt to take pictures while in motion.** Do not use the camera while walking or driving. This can result in you falling down or being involved in a traffic accident.



**Do not touch any metal parts of the camera during a thunderstorm.** This can cause an electric shock due to induced current from the lightning discharge.























**Do not use the battery except as specified.** Load the battery as shown by the indicator.



**Do not heat, change or take apart the battery. Do not drop or subject the battery to impacts. Do not store the battery with metallic products.** Any of these actions can cause the battery to burst or leak and cause fire or injury as a result.



 <b>WARNING</b>	
	<b>Use only batteries or AC power adapters specified for use with this camera. Do not use voltages other than the power supply voltage shown.</b> The use of other power sources can cause a fire.
	<b>If the battery leaks and fluid gets in contact with your eyes, skin or clothing, flush the affected area with clean water and seek medical attention or call an emergency number right away.</b>
	<b>Do not use the charger to charge batteries other than those specified here.</b> The supplied charger is for use only with batteries of the type supplied with the camera. Using the charger to charge conventional batteries or other types of rechargeable batteries can cause the battery to leak, overheat or burst.
	<b>Do not use in the presence of flammable objects, explosive gases, or dust.</b>
	<b>When carrying the battery, install it in a digital camera or keep it in the hard case. When storing the battery, keep it in the hard case. When discarding, cover the battery terminals with insulation tape.</b> Contact with other metallic objects or batteries could cause the battery to ignite or burst.
	<b>Keep memory cards out of the reach of small children.</b> Because memory cards are small, they can be swallowed by children. Be sure to store memory cards out of the reach of small children. If a child swallows a memory card, seek medical attention or call an emergency number.
 <b>CAUTION</b>	
	<b>Do not use this camera in locations affected by oil fumes, steam, humidity or dust.</b> This can cause a fire or electric shock.
	<b>Do not leave this camera in places subject to extremely high temperatures.</b> Do not leave the camera in locations such as a sealed vehicle or in direct sunlight. This can cause a fire.

 <b>CAUTION</b>	
	<b>Keep out of the reach of small children.</b> This product could cause injury in the hands of a child.
	<b>Do not place heavy objects on the camera.</b> This can cause the heavy object to tip over or fall and cause injury.
	<b>Do not move the camera while the AC power adapter is still connected. Do not pull on the connection cord to disconnect the AC power adapter.</b> This can damage the power cord or cables and cause a fire or electric shock.
	<b>Do not cover or wrap the camera or the AC power adapter in a cloth or blanket.</b> This can cause heat to build up and distort the casing or cause a fire.
	<b>When you are cleaning the camera or you do not plan to use the camera for an extended period, remove the battery and disconnect and unplug the AC power adapter.</b> Failure to do so can cause a fire or electric shock.
	<b>When charging ends, unplug the charger from the power socket.</b> Leaving the charger plugged into the power socket can cause a fire.
	<b>Using a flash too close to a person's eyes may temporarily affect the eyesight.</b> Take particular care when photographing infants and young children.
	<b>When a memory card is removed, the card could come out of the slot too quickly. Use your finger to hold it and gently release the card.</b> Injury could result to those struck by the ejected card.
	<b>Request regular internal testing and cleaning for your camera.</b> Build-up of dust in your camera can cause a fire or electric shock. Contact your FUJIFILM dealer to request internal cleaning every two years. Please note that this service is not free of charge.
	<b>Danger of explosion if battery is incorrectly replaced. Replace only with the same or equivalent type.</b>

### The Battery and Power Supply

**Note:** Check the type of battery used in your camera and read the appropriate sections.

The following describes the proper use of batteries and how to prolong their life. Incorrect use can shorten battery life or cause leakage, overheating, fire, or explosion.

#### Li-ion Batteries

**Read this section if your camera uses a rechargeable Li-ion battery.**

The battery is not charged at shipment. Charge the battery before use. Keep the battery in its case when not in use.

#### ■ Notes on the Battery

The battery gradually loses its charge when not in use. Charge the battery one or two days before use.

Battery life can be extended by turning the camera off when not in use.

Battery capacity decreases at low temperatures; a depleted battery may not function at when cold. Keep a fully charged spare battery in a warm place and exchange as necessary, or keep the battery in your pocket or other warm place and insert it in the camera only when shooting. Do not place the battery in direct contact with hand warmers or other heating devices.

#### ■ Charging the Battery

Charge the battery in the supplied battery charger. Charging times will increase at ambient temperatures below +10°C (+50°F) or above +35°C (+95°F). Do not attempt to charge the battery at temperatures above 40°C (+104°F); at temperatures below 0°C (+32°F), the battery will not charge.

Do not attempt to recharge a fully charged battery. The battery does not however need to be fully discharged before charging.

The battery may be warm to the touch immediately after charging or use. This is normal.

**Battery Life**

At normal temperatures, the battery can be recharged about 300 times. A noticeable decrease in the length of time the battery will hold a charge indicates that it has reached the end of its service life and should be replaced.

**Storage**

Performance may be impaired if the battery is left unused for extended periods when fully charged. Run the battery flat before storing it.

If the camera will not be used for an extended period, remove the battery and store it in a dry place with an ambient temperature of from +15 °C to +25 °C (+59 °F to +77 °F). Do not store in locations exposed to extremes of temperature.

**Cautions: Handling the Battery**

- Do not transport or store with metal objects such as necklaces or hairpins.
- Do not expose to flame or heat.
- Do not disassemble or modify.
- Use with designated chargers only.
- Dispose of used batteries promptly.
- Do not drop or subject to strong physical shocks.
- Do not expose to water.
- Keep the terminals clean.
- The battery and camera body may become warm to the touch after extended use. This is normal.

**AA Alkaline/Rechargeable Ni-MH Batteries**

Read this section if your camera uses AA alkaline or rechargeable AA Ni-MH batteries. Information on compatible battery types may be found elsewhere in the camera manual.

**Cautions: Handling the Batteries**

- Do not expose to water, flame, or heat, or store in warm or humid conditions.
- Do not transport or store with metal objects such as necklaces or hairpins.
- Do not disassemble or modify the batteries or battery casing.
- Do not subject to strong physical shocks.

- Do not use batteries that are leaking, deformed, or discolored.
- Keep out of reach of infants and small children.
- Insert in the correct orientation.
- Do not mix old and new batteries, batteries with different charge levels, or batteries of different types.
- If the camera will not be used for an extended period, remove the batteries. Note that the camera clock will be reset.
- The batteries may be warm to the touch immediately after use. Turn the camera off and allow the batteries to cool before handling.
- Battery capacity tends to decrease at low temperatures. Keep spare batteries in a pocket or other warm place and exchange as necessary. Cold batteries may recover some of their charge when warmed.
- Fingerprints and other stains on the battery terminals can impair battery performance. Thoroughly clean the terminals with a soft, dry cloth before inserting them in the camera.



If the batteries leak, clean the battery compartment thoroughly before inserting new batteries.



If fluid from the battery comes into contact with skin or clothing, flush the affected area with water. **If fluid enters your eyes, immediately flush the affected area with water and seek medical attention. Do not rub your eyes. Failure to observe this precaution could result in permanent visual impairment.**

**Ni-MH Batteries**

The capacity of Ni-MH batteries may be temporarily reduced when new, after long periods of disuse, or if they are repeatedly recharged before being fully discharged. This is normal and does not indicate a malfunction. Capacity can be increased by repeatedly discharging the batteries using the discharge option in the camera setup menu and recharging them using a battery charger.

- ⓘ **CAUTION:** Do not use the discharge option with alkaline batteries.

The camera draws a small amount of current even when off. Ni-MH batteries that have been left in the camera for an extended period may be drawn down to the point that they no longer hold a charge. Battery performance may also drop if the batteries are run down in a device such as a flashlight. Use the discharge option in the camera setup menu to discharge Ni-MH batteries. Batteries that no longer hold a charge even after repeatedly being discharged and recharged have reached the end of their service life and must be replaced.

Ni-MH batteries can be recharged in a battery charger (sold separately). Batteries may become warm to the touch after charging. Refer to the instructions provided with the charger for more information. Use the charger with compatible batteries only.

Ni-MH batteries gradually lose their charge when not in use.

**Disposal**

Dispose of used batteries in accord with local regulations.

**AC Power Adapters (Available Separately)**

*This section applies to all camera models.* Use only FUJIFILM AC power adapters designated for use with this camera. Other adapters could damage the camera.

- The AC power adapter is for indoor use only.
- Be sure the DC plug is securely connected to the camera.
- Turn the camera off before disconnecting the adapter. Disconnect the adapter by the plug, not the cable.
- Do not use with other devices.
- Do not disassemble.
- Do not expose to high heat and humidity.
- Do not subject to strong physical shocks.
- The adapter may hum or become hot to the touch during use. This is normal.
- If the adapter causes radio interference, reorient or relocate the receiving antenna.

### Using the Camera

- Do not aim the camera at extremely bright light sources, such as the sun in a cloudless sky. Failure to observe this precaution could damage the camera image sensor.
- Strong sunlight focused through the viewfinder may damage the panel of electronic viewfinder (EVF). Do not aim the electronic viewfinder at the sun.

### Take Test Shots

Before taking photographs on important occasions (such as at weddings or before taking the camera on a trip), take a test shot and view the results to ensure that the camera is functioning normally. FUJIFILM Corporation can not accept liability for damages or lost profits incurred as a result of product malfunction.

### Notes on Copyright

Unless intended solely for personal use, images recorded using your digital camera system cannot be used in ways that infringe copyright laws without the consent of the owner. Note that some restrictions apply to the photographing of stage performances, entertainments, and exhibits, even when intended purely for personal use. Users are also asked to note that the transfer of memory cards containing images or data protected under copyright laws is only permissible within the restrictions imposed by those copyright laws.

### Handling

To ensure that images are recorded correctly, do not subject the camera to impact or physical shocks while images are being recorded.

### Liquid Crystal

In the event that the display is damaged, care should be taken to avoid contact with liquid crystal. Take the urgent action indicated should any of the following situations arise:

- **If liquid crystal comes in contact with your skin**, clean the area with a cloth and then wash thoroughly with soap and running water.
- **If liquid crystal enters your eyes**, flush the affected eye with clean water for at least 15 minutes and then seek medical assistance.
- **If liquid crystal is swallowed**, rinse your mouth thoroughly with water. Drink large quantities of water and induce vomiting, then seek medical assistance.

Although the display is manufactured using extremely high-precision technology, it may contain pixels that are always lit or that do not light. This is not a malfunction, and images recorded with the product are unaffected.

### Trademark Information

**xD-Picture Card** and  are trademarks of FUJIFILM Corporation. The typefaces included herein are solely developed by DynaComware Taiwan Inc. Macintosh, QuickTime, and Mac OS are trademarks of Apple Inc. in the U.S.A. and other countries. Windows 8, Windows 7, Windows Vista, and the Windows logo are trademarks of the Microsoft group of companies. Adobe and Adobe Reader are either trademarks or registered trademarks of Adobe Systems Incorporated in the U.S.A. and/or other countries. The SDHC and SDXC logos are trademarks of SD-3C, LLC. The HDMI logo is a trademark. YouTube is a trademark of Google Inc. All other trade names mentioned in this manual are the trademarks or registered trademarks of their respective owners.

### Electrical Interference

This camera may interfere with hospital or aviation equipment. Consult with hospital or airline staff before using the camera in a hospital or on an aircraft.

### Exif Print (Exif Version 2.3)

Exif Print is a newly revised digital camera file format in which information stored with photographs is used for optimal color reproduction during printing.

### IMPORTANT NOTICE: Read Before Using the Software

Direct or indirect export, in whole or in part, of licensed software without the permission of the applicable governing bodies is prohibited.

## NOTICES

To prevent fire or shock hazard, do not expose the unit to rain or moisture.

Please read the "Safety Notes" and make sure you understand them before using the camera.

**Perchlorate Material—special handling may apply.** See <http://www.dtscc.ca.gov/hazardouswaste/perchlorate>.

### For Customers in the U.S.A.

#### Tested To Comply With FCC Standards FOR HOME OR OFFICE USE

**FCC Statement:** This device complies with Part 15 of the FCC Rules. Operation is subject to the following two conditions: (1) This device may not cause harmful interference, and (2) this device must accept any interference received, including interference that may cause undesired operation.

**CAUTION:** This equipment has been tested and found to comply with the limits for a Class B digital device, pursuant to Part 15 of the FCC Rules. These limits are designed to provide reasonable protection against harmful interference in a residential installation. This equipment generates, uses, and can radiate radio frequency energy and, if not installed and used in accordance with the instructions, may cause harmful interference to radio communications. However, there is no guarantee that interference will not occur in a particular installation. If this equipment does cause harmful interference to radio or television reception, which can be determined by turning the equipment off and on, the user is encouraged to try to correct the interference by one or more of the following measures:

- Reorient or relocate the receiving antenna.
- Increase the separation between the equipment and receiver.
- Connect the equipment into an outlet on a circuit different from that to which the receiver is connected.
- Consult the dealer or an experienced radio/TV technician for help.
- You are cautioned that any changes or modifications not expressly approved in this manual could void the user's authority to operate the equipment.

**Notes on the Grant:** To comply with Part 15 of the FCC Rules, this product must be used with a Fujifilm-specified ferrite-core A/V cable, USB cable, and DC supply cord.

### For Customers in Canada

**CAUTION:** This Class B digital apparatus complies with Canadian ICES-003.

### Disposal of Electrical and Electronic Equipment in Private Households

**In the European Union, Norway, Iceland and Liechtenstein:** This symbol on the product, or in the manual and in the warranty, and/or on its packaging indicates that this product shall not be treated as household waste. Instead it should be taken to an applicable collection point for the recycling of electrical and electronic equipment.



By ensuring this product is disposed of correctly, you will help prevent potential negative consequences to the environment and human health, which could otherwise be caused by inappropriate waste handling of this product.

This symbol on the batteries or accumulators indicates that those batteries shall not be treated as household waste.



If your equipment contains easy removable batteries or accumulators please dispose these separately according to your local requirements.

The recycling of materials will help to conserve natural resources. For more detailed information about recycling this product, please contact your local city office, your household waste disposal service or the shop where you purchased the product.

**In Countries Outside the European Union, Norway, Iceland and Liechtenstein:** If you wish to discard this product, including the batteries or accumulators, please contact your local authorities and ask for the correct way of disposal.

## About This Manual

Before using the camera, read this manual and the warnings in “For Your Safety” (📖 ii). For information on specific topics, consult the sources below.

### **Table of Contents** ..... 📖 x

The “Table of Contents” gives an overview of the entire manual. The principal camera operations are listed here.

### **Warning Messages and Displays** ..... 📖 115

Find out what’s behind that flashing icon or error message in the display.

### **Restrictions on Camera Settings**..... 📖 125

See page 125 for restrictions on the options available in each shooting mode.

### **Troubleshooting** ..... 📖 111

Having a specific problem with the camera? Find the answer here.

### **Glossary**..... 📖 118

The meanings of some technical terms may be found here.

### **Memory Cards**

Pictures are stored on optional SD, SDHC, and SDXC memory cards (📖 15), referred to in this manual as “memory cards.”



## **Caring for the Camera**

---

























For continued enjoyment of your camera, use a soft, dry cloth to clean the camera body after each use. Do not use alcohol, thinner, or other volatile chemicals, which could discolor or deform the leather on the camera body. Any liquid on the camera should be removed immediately with a soft, dry cloth. Use a blower to remove dust from the lens and monitor, then gently wipe with a soft, dry cloth. Any remaining stains can be removed by wiping gently with a piece of FUJIFILM lens-cleaning paper to which a small amount of lens-cleaning fluid has been applied. Care should be taken to avoid scratching the lens or monitor.

























# Table of Contents

<b>For Your Safety</b> .....	ii	<b>Choosing a Display</b> .....	18
IMPORTANT SAFETY INSTRUCTIONS.....	ii	Focusing the Viewfinder .....	19
Safety Notes.....	iii	Adjusting Display Brightness .....	19
NOTICES.....	vii	Bright Ambient Lighting.....	19
<b>About This Manual</b> .....	viii	Using the Hybrid Viewfinder .....	20
<b>Caring for the Camera</b> .....	ix	<b>The DISP/BACK Button</b> .....	21
<b>Before You Begin</b>		Optical Viewfinder: Shooting.....	21
<b>Symbols and Conventions</b> .....	1	Electronic Viewfinder: Shooting.....	21
<b>Supplied Accessories</b> .....	1	LCD Monitor: Shooting.....	21
<b>Parts of the Camera</b> .....	2	Viewfinder/LCD Monitor: Playback.....	22
The Command Dial .....	4	<b>Basic Photography and Playback</b>	
The Command Control.....	5	<b>Taking Photographs</b> .....	23
Camera Displays.....	6	<b>Viewing Pictures</b> .....	25
Shooting: Optical Viewfinder .....	6	Viewing Pictures Full Frame.....	25
Shooting: Electronic Viewfinder.....	7	Viewing Photo Information .....	26
Playback: Electronic Viewfinder .....	7	Playback Zoom .....	26
Shooting: LCD Monitor.....	8	Multi-Frame Playback.....	27
Playback: LCD Monitor.....	8	<b>Deleting Pictures</b> .....	28
<b>First Steps</b>		<b>Using the Flash</b> .....	29
<b>Attaching the Strap</b> .....	9	<b>Macro Mode (Close-ups)</b> .....	31
<b>Charging the Battery</b> .....	11	<b>Basic Movie Recording and Playback</b>	
<b>Inserting the Battery and a Memory Card</b> .....	12	<b>Recording High-Definition (HD) Movies</b> .....	32
Compatible Memory Cards.....	15	<b>Viewing Movies</b> .....	33
<b>Turning the Camera on and Off</b> .....	16		
<b>Basic Setup</b> .....	17		

<b>The Q (Quick Menu) Button</b>		<b>Film Simulation</b>	55
Using the Q (Quick Menu) Button	34	<b>Bracketing</b>	56
<b>More on Photography and Playback</b>		<b>Multiple Exposures</b>	57
<b>Choosing an Exposure Mode</b>	36	<b>Continuous Shooting (Burst Mode)</b>	58
Program AE (P)	36	Viewing Pictures Taken in a Single Burst	59
Shutter-Priority AE (S)	37	<b>Panoramas</b>	60
Aperture-Priority AE (A)	38	Viewing Panoramas	62
Manual Exposure (M)	39	<b>Recording Pictures in RAW Format</b>	63
Shutter Speed and Aperture	40	Creating JPEG Copies of RAW Pictures	64
<b>Long Time-Exposures (T/B)</b>	41	<b>The ND Filter</b>	65
Time (T)	41	<b>Image Search</b>	66
Bulb (B)	41	<b>PhotoBook Assist</b>	67
<b>White Balance</b>	42	Creating a PhotoBook	67
<b>Sensitivity</b>	44	Viewing Photobooks	68
AUTO	45	Editing and Deleting Photobooks	68
<b>Focus Mode</b>	46	<b>The Fn Button</b>	69
MF Assist	47	<b>Saving Settings</b>	70
Focus Frame Selection	48	<b>Advanced Movie Recording</b>	71
<b>Focus/Exposure Lock</b>	49	Depth of Field	71
<b>Exposure Compensation</b>	51	Before Recording	71
<b>Metering</b>	52	Using an External Microphone	71
<b>Using the Self-Timer</b>	53		

## Menus

<b>Using the Menus: Shooting Mode</b> .....	72
Shooting Menu Options (Photographs).....	72
 SELF-TIMER.....	72
 ISO.....	72
 IMAGE SIZE.....	72
 IMAGE QUALITY.....	73
 DYNAMIC RANGE.....	73
 FILM SIMULATION.....	73
 FILM SIMULATION BKT.....	73
 ND FILTER.....	73
 COLOR.....	74
 SHARPNESS.....	74
 HIGHLIGHT TONE.....	74
 SHADOW TONE.....	74
 NR.....	74
 LONG EXPOSURE NR.....	74
 SELECT CUSTOM SETTING.....	74
 EDIT/SAVE CUSTOM SETTING.....	74
 Fn BUTTON.....	74
 DISP. CUSTOM SETTING.....	75
 FRAMING GUIDLINE.....	76
 WIDE CONVERSION LENS.....	76
 MF ASSIST.....	76
 ADVANCED FILTER.....	77
 AF MODE.....	77
 AF ILLUMINATOR.....	78
 AE/AF-LOCK MODE.....	78

 AE/AF-LOCK BUTTON.....	78
 CORRECTED AF FRAME.....	78
 FLASH.....	79
 RED EYE REMOVAL.....	79
 SAVE ORG IMAGE.....	79
Shooting Menu Options (Movie Mode).....	80
 MOVIE MODE.....	80
 FILM SIMULATION.....	80
 MIC LEVEL ADJUSTMENT.....	80
 DISP. CUSTOM SETTING.....	80
 WIDE CONVERSION LENS.....	80
<b>Using the Menus: Playback Mode</b> .....	81
Playback Menu Options.....	81
 RAW CONVERSION.....	81
 ERASE.....	81
 CROP.....	81
 RESIZE.....	82
 PROTECT.....	82
 IMAGE ROTATE.....	83
 COPY.....	83
 RED EYE REMOVAL.....	84
 SLIDE SHOW.....	84
 PHOTOBOK ASSIST.....	85
 MARK FOR UPLOAD TO.....	85
 IMAGE SEARCH.....	85
 PRINT ORDER (DPOF).....	86
 DISP ASPECT.....	86
 PLAYBACK VOLUME.....	86

<b>The Setup Menu</b> .....	87
Using the Setup Menu .....	87
Setup Menu Options .....	88
DATE/TIME .....	88
TIME DIFFERENCE.....	88
言語/LANG.....	88
RESET .....	88
SILENT MODE.....	88
FRAME NO.....	89
FOCUS RING .....	89
FOCUS CHECK .....	89
FOCUS SCALE UNITS.....	89
SOUND SET-UP .....	90
SCREEN SET-UP .....	90
POWER MANAGEMENT.....	91
OVF POWER SAVE MODE .....	91
SHUTTER COUNT.....	91
COLOR SPACE .....	91
Eye-Fi TRANSFER .....	92
FORMAT .....	92

## Connections

<b>Viewing Pictures on a Computer</b> .....	93
Windows: Installing MyFinePix Studio .....	93
Macintosh: Installing RAW FILE CONVERTER.....	95
Importing Pictures or Movies to Mac (Macintosh) .....	96
Connecting the Camera .....	97
<b>Printing Pictures via USB</b> .....	99
Connecting the Camera .....	99
Printing Selected Pictures .....	99
Printing the DPOF Print Order .....	100
Creating a DPOF Print Order.....	101
WITH DATE  /WITHOUT DATE .....	102
RESET ALL.....	103
<b>Viewing Pictures on TV</b> .....	104

**Technical Notes**

<b>Optional Accessories</b> .....	105
Accessories from FUJIFILM.....	105
Attaching Adapter Rings.....	107
Attaching Lens Hoods.....	107
Attaching Protector Filters .....	107
The WCL-X100 Wide Conversion Lens .....	108
Connecting the Camera to Other Devices.....	109
<b>Caring for the Camera</b> .....	110
Storage and Use .....	110
Traveling.....	110

**Troubleshooting**

<b>Problems and Solutions</b> .....	111
<b>Warning Messages and Displays</b> .....	115

**Appendix**

<b>Glossary</b> .....	118
<b>Memory Card Capacity</b> .....	119
<b>Specifications</b> .....	120
<b>Restrictions on Camera Settings</b> .....	125

# Before You Begin

## Symbols and Conventions

The following symbols are used in this manual:

- ⓘ This information should be read before use to ensure correct operation.
- ◆ Additional information that may be helpful when using the camera.
- 📖 Other pages in this manual on which related information may be found.

Menus and other text in the displays are shown in **bold**. In the illustrations in this manual, displays may be simplified for explanatory purposes.

## Supplied Accessories

The following items are included with the camera:



NP-95 rechargeable battery

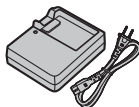

BC-65N battery charger

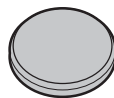

Lens cap

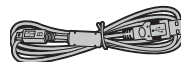

USB cable



CD-ROM



Clip attaching tool



Metal strap clips (x 2)

- Owner's Manual (*this manual*)
- Shoulder strap
- Protective covers (x 2)

## Parts of the Camera

For more information, refer to the page listed to the right of each item.

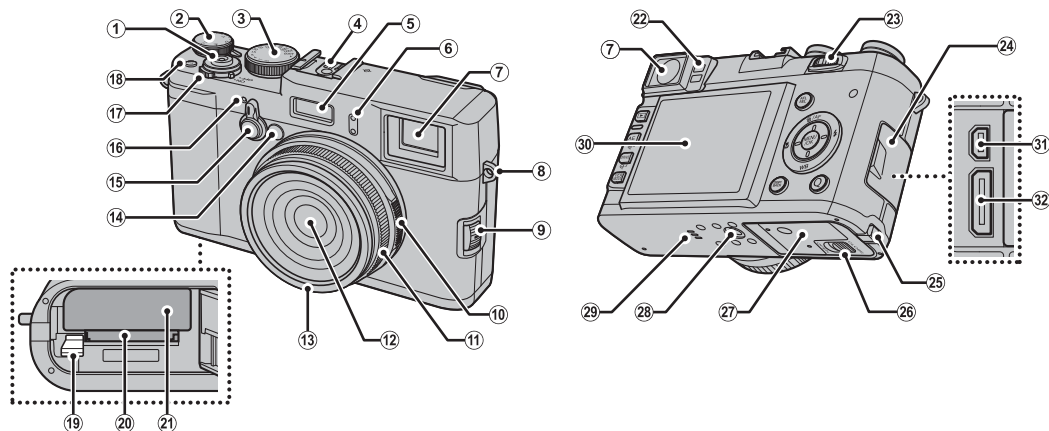

<b>1</b> Shutter button .....	111	<b>13</b> Front ring .....	107	<b>24</b> Connector cover .....	71, 97, 99, 104
<b>2</b> Exposure compensation dial .....	51	<b>14</b> AF-assist illuminator .....	78	<b>25</b> Cable channel cover for DC coupler .....	12
<b>3</b> Shutter speed dial .....	36, 37, 38, 39	Self-timer lamp .....	53	<b>26</b> Battery-chamber cover latch .....	12
<b>4</b> Hot shoe .....	30, 109	<b>15</b> Viewfinder selector .....	20	<b>27</b> Battery-chamber cover .....	12
<b>5</b> Flash .....	29	<b>16</b> Microphone (R) .....	32	<b>28</b> Tripod mount .....	
<b>6</b> Microphone (L) .....	32	<b>17</b> ON/OFF switch .....	16	<b>29</b> Speaker .....	33
<b>7</b> Viewfinder window .....	18	<b>18</b> Fn (Function) button .....	69	<b>30</b> LCD monitor .....	18
<b>8</b> Strap eyelet .....	9	<b>19</b> Battery latch .....	12	<b>31</b> USB multi-connector .....	97, 99
<b>9</b> Focus mode selector .....	23, 46	<b>20</b> Memory card slot .....	13	<b>32</b> HDMI mini connector .....	104
<b>10</b> Aperture ring .....	38, 39	<b>21</b> Battery chamber .....	12		
<b>11</b> Focus ring .....	46	<b>22</b> Eye sensor .....	18		
<b>12</b> Lens .....	ix	<b>23</b> Command control .....	5		



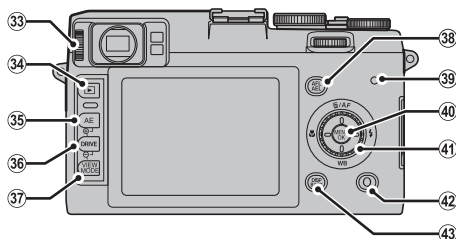

<b>33</b> Diopter adjustment control..... 19	<b>37</b> <b>VIEW MODE</b> button..... 18	<b>41</b> Command dial..... 4
<b>34</b> <b>▶</b> (playback) button..... 25	<b>38</b> <b>AFL/AEL</b> (focus lock/exposure) button..... 46, 49, 78	<b>42</b> <b>Q</b> (quick menu) button..... 19, 34
<b>35</b> <b>AE</b> (autoexposure) button..... 52		<b>43</b> <b>DISP</b> (display)/ <b>BACK</b> button..... 21
<b>36</b> <b>Q</b> (playback zoom in) button..... 26, 27	<b>39</b> Indicator lamp (see below)	<b>44</b> (silent mode) button..... 5
<b>36</b> <b>DRIVE</b> button..... 32, 56, 57, 58, 60	<b>40</b> <b>MENU/OK</b> button..... 4	
<b>36</b> <b>Q</b> (playback zoom out) button..... 26, 27	<b>40</b> Control lock..... 4	

### The Indicator Lamp

The indicator lamp shows camera status as follows:

Indicator lamp	Camera status
Glows green	Focus locked.
Blinks green	Blur, focus, or exposure warning. Picture can be taken.
Blinks green and orange	Recording pictures. Additional pictures can be taken.
Glows orange	Recording pictures. No additional pictures can be taken at this time.
Blinks orange	Flash charging; flash will not fire when picture is taken.
Blinks red	Lens or memory error.

◆ Warnings may also appear in the display (🗨️ 5).

Indicator lamp

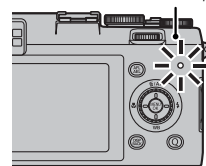

**The Command Dial**

Rotate the command dial to highlight items and press it up (①), right (②), down (③), or left (④) to highlight items and press **MENU/OK** (⑤) to select.

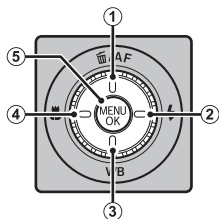
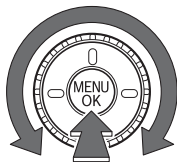

The command dial also serves as the following buttons:

- ①: (delete) button (📖 28)/**AF** (autofocus) button (📖 48)
- ②: (flash) button (📖 29)
- ③: **WB** (white balance) button (📖 42)
- ④: (macro) button (📖 31)

You can also rotate the command dial to choose a combination of shutter speed and aperture (program shift; 📖 36) or to adjust shutter speed in increments of  $\frac{1}{3}$  EV (📖 37, 39).

#### **Control Lock**

To lock the **Q** button and prevent the command dial being used as an **AF**, flash, white balance, or macro button, press **MENU/OK** until is displayed. This prevents accidental operation of these controls during shooting. The controls can be unlocked by pressing **MENU/OK** until is no longer displayed.

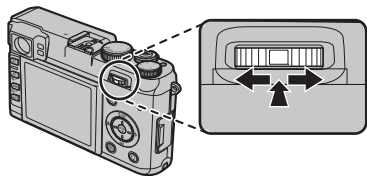

## **The Command Control**

Pressing the command control left or right performs the same function as rotating the command dial. It can also be used to choose a combination of shutter speed and aperture (program shift; [36](#)) or to adjust aperture in increments of  $\frac{1}{3}$  EV ([38, 39](#)).



You can also press the center of the command control to zoom in on the focus area selected in the electronic viewfinder or LCD monitor, or to zoom in on the active focus point during playback or (if **CONTINUOUS** is selected for  **SCREEN SET-UP > IMAGE DISP.** in the setup menu; [90](#)) image review (press again to cancel zoom).

## **Silent Mode**

In situations in which camera sounds or lights may be unwelcome, press the **DISP/BACK** button until the  icon is displayed (about a second), or select **ON** for  **SILENT MODE** in the setup menu ([88](#)). The camera speaker, flash, and AF-assist illuminator/self-timer lamp turn off and flash and volume settings can not be adjusted (note that silent mode can not be enabled or disabled while movie playback is in progress). Press the **DISP/BACK** button again to resume normal operation.

## Camera Displays

The following types of indicator may be displayed during shooting and playback. In the description that follows, all available indicators are shown for illustrative purposes; the indicators actually displayed vary with camera settings.

### Shooting: Optical Viewfinder

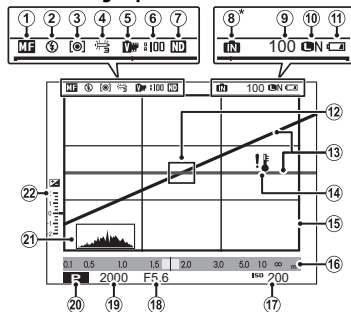

<b>1</b> Manual focus indicator.....	46	<b>13</b> Virtual horizon .....	75
<b>2</b> Flash mode .....	29	<b>14</b> Temperature warning.....	117
<b>3</b> Metering .....	52	<b>15</b> Bright frame	
<b>4</b> White balance .....	42	<b>16</b> Distance indicator .....	46
<b>5</b> Film simulation .....	55	<b>17</b> Sensitivity .....	44
<b>6</b> Dynamic range.....	73	<b>18</b> Aperture.....	36, 38, 39, 71
<b>7</b> ND (Neutral Density) filter indicator.....	65	<b>19</b> Shutter speed.....	36, 37, 39
<b>8</b> Internal memory indicator*		<b>20</b> Shooting mode .....	36
<b>9</b> Number of available frames .....	119	<b>21</b> Histogram .....	22
<b>10</b> Image quality and size .....	72, 73	<b>22</b> Exposure compensation/ exposure indicator.....	39, 51
<b>11</b> Battery level.....	16		
<b>12</b> Focus frame.....	49, 111		

\* **IN**: indicates that no memory card is inserted and that pictures will be stored in the camera's internal memory (13).

## Shooting: Electronic Viewfinder

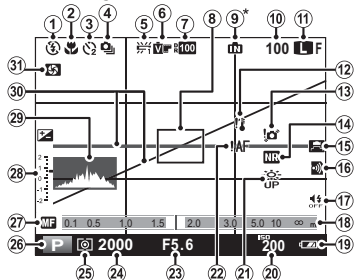

\* **MF**: indicates that no memory card is inserted and that pictures will be stored in the camera's internal memory (13).

1	Flash mode	29	17	Silent mode indicator	5, 88
2	Macro (close-up) mode	31	18	Distance indicator	46
3	Self-timer indicator	53	19	Battery level	16
4	Continuous mode	58	20	Sensitivity	44
5	White balance	42	21	Monitor sunlight mode	19
6	Film simulation	55	22	Focus warning	3, 113, 115
7	Dynamic range	73	23	Aperture	36, 38, 39, 71
8	Focus frame	24, 49	24	Shutter speed	36, 37, 39
9	Internal memory indicator*		25	Metering	52
10	Number of available frames	119	26	Shooting mode	36
11	Image quality and size	72, 73	27	Manual focus indicator	46
12	Temperature warning	117	28	Exposure compensation/ exposure indicator	39, 51
13	Blur warning	3, 113, 115	29	Histogram	22
14	ND (Neutral Density) filter indicator	65	30	Virtual horizon	75
15	Wide converter lens	108	31	Depth-of-field preview	38
16	Eye-Fi upload	92			

## Playback: Electronic Viewfinder

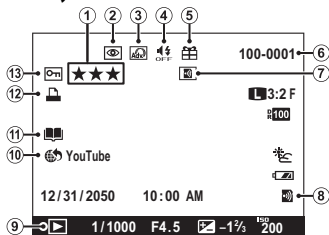

1	Rating	25	8	Eye-Fi upload	92
2	Red-eye removal indicator	84	9	Playback mode indicator	25
3	Advanced filter	77	10	Mark for upload to	85
4	Silent mode indicator	5, 88	11	Photobook assist indicator	67
5	Gift image	25	12	DPOF print indicator	101
6	Frame number	89	13	Protected image	82
7	Eye-Fi upload complete	92			

## Shooting: LCD Monitor

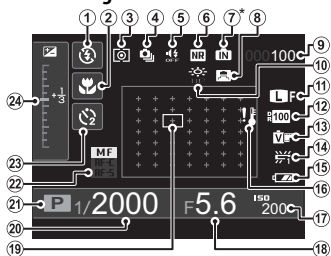

\* : indicates that no memory card is inserted and that pictures will be stored in the camera's internal memory (page 13).

1	Flash mode .....	46	14	White balance .....	42
2	Macro (close-up) mode .....	31	15	Battery level .....	16
3	Metering .....	52	16	Temperature warning .....	117
4	Continuous mode .....	58	17	Sensitivity .....	44
5	Silent mode indicator .....	5, 88	18	Aperture .....	36, 38, 39, 71
6	ND (Neutral Density) filter indicator .....	65	19	Focus frame/focus point .....	48
7	Internal memory indicator *		20	Shutter speed .....	36, 37, 39
8	Wide converter lens .....	108	21	Shooting mode .....	36
9	Number of available frames .....	119	22	Focus mode .....	46
10	Monitor sunlight mode .....	19	23	Self-timer indicator .....	53
11	Image quality and size .....	72, 73	24	Exposure compensation/ exposure indicator .....	39, 51
12	Dynamic range .....	73			
13	Film simulation .....	55			

## Playback: LCD Monitor

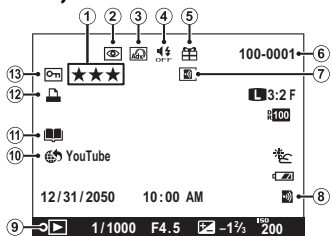

1	Rating .....	25	8	Eye-Fi upload .....	92
2	Red-eye removal indicator .....	84	9	Eye-Fi upload indicator .....	25
3	Advanced filter .....	77	10	Mark for upload to .....	85
4	Silent mode indicator .....	5, 88	11	Photobook assist indicator .....	67
5	Gift image .....	25	12	DPOF print indicator .....	101
6	Frame number .....	89	13	Protected image .....	82
7	Eye-Fi upload complete .....	92			

# First Steps

## Attaching the Strap

Attach the strap clips to the camera and then attach the strap.

### 1 Open a strap clip.

Use the clip attaching tool to open a strap clip, making sure that the tool and clip are in the orientations shown.

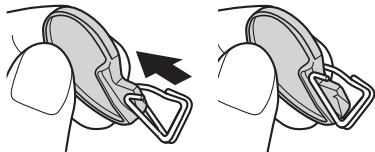

① Keep the tool in a safe place. You will need it to open the strap clips when removing the strap.

### 2 Place the strap clip on an eyelet.

Hook the strap eyelet in the clip opening. Remove the tool, using the other hand to keep the clip in place.

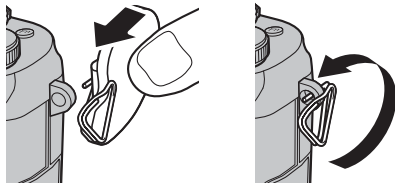

### 3 Pass the clip through the eyelet.

Rotate the clip fully through the eyelet until it clicks closed.

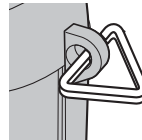

### 4 Attach a protective cover.

Place a protective cover over the eyelet as shown, with the black side of the cover toward the camera. Repeat Steps 1–4 for the second eyelet.

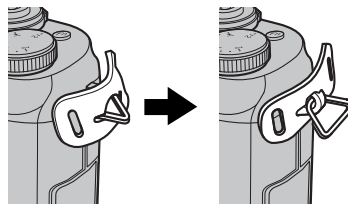

## 5 Insert the strap.

Insert the strap through a protective cover and strap clip.

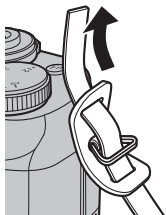

## 6 Fasten the strap.

Fasten the strap as shown. Repeat Steps 5–6 for the second eyelet.

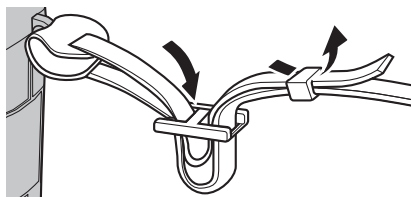

- ⓘ To avoid dropping the camera, be sure the strap is correctly secured.



## Charging the Battery

The battery is not charged at shipment. Charge the battery before use.

### 1 Place the battery in the charger.

Insert the battery in the orientation indicated by the  $\ominus \uparrow \oplus$  labels.

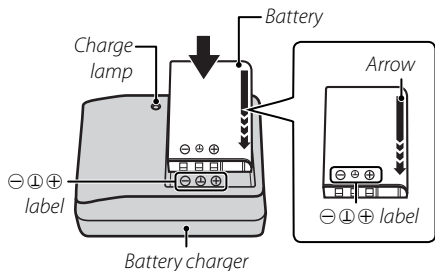

The camera uses an NP-95 rechargeable battery.

- ◆ Attach the supplied adapter before charging the battery (the adapter is attached at shipment).

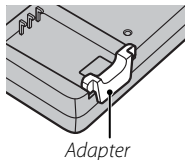

### 2 Plug the charger in.

Plug the charger into a power outlet. The charging indicator will light.

#### The Charging Indicator

The charging indicator shows battery charge status as follows:

Charging indicator	Battery status	Action
Off	Battery not inserted.	Insert the battery.
	Battery fully charged.	Remove the battery.
On	Battery charging.	—
Blinks	Battery fault.	Unplug the charger and remove the battery.

### 3 Charge the battery.

Remove the battery when charging is complete. See the specifications (📖 123) for charging times (note that charging times increase at low temperatures).

- ① Unplug the charger when it is not in use.

## Inserting the Battery and a Memory Card

Although the camera can store pictures in internal memory, optional SD, SDHC, and SDXC memory cards (sold separately) can be used to store additional pictures. After charging the battery, insert the battery and memory card as described below.

### 1 Open the battery-chamber cover.

Slide the battery-chamber latch as shown and open the battery-chamber cover.

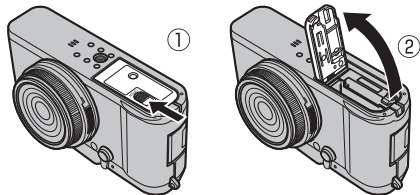

- Ⓛ Do not open the battery-chamber cover when the camera is on. Failure to observe this precaution could damage image files or memory cards.
- Ⓛ Do not use excessive force when handling the battery-chamber cover.

### 2 Insert the battery.

Align the orange stripe on the battery with the orange battery latch and slide the battery into the camera, keeping the battery latch pressed to one side. Confirm that the battery is securely latched.

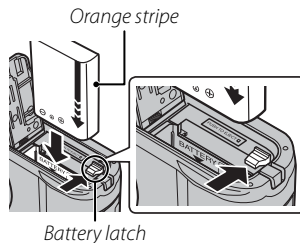

- Ⓛ Insert the battery in the correct orientation. **Do not use force or attempt to insert the battery upside down or backwards.** The battery will slide in easily in the correct orientation.

**3 Insert the memory card.**

Holding the memory card in the orientation shown at right, slide it in until it clicks into place at the back of the slot.

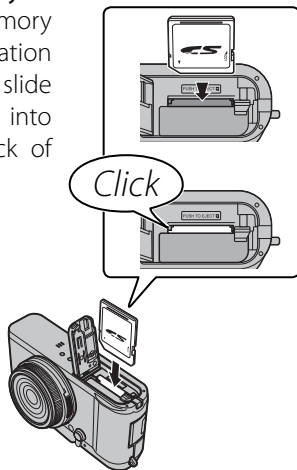

① Be sure card is in the correct orientation; do not insert at an angle or use force. If the memory card is not correctly inserted or no memory card is inserted, **IN** will appear in the display and internal memory will be used for recording and playback.

① SD/SDHC/SDXC memory cards can be locked, making it impossible to format the card or to record or delete images.

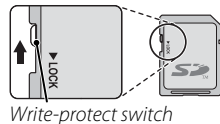

*Write-protect switch*

Before inserting a memory card, slide the write-protect switch to the unlocked position.

**4 Close the battery-chamber cover.**

Slide the battery-chamber latch as shown and close the battery-chamber cover.

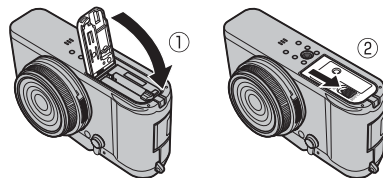

### Removing the Battery and Memory Card

Before removing the battery or memory card, **turn the camera off** and open the battery-chamber cover.

To remove the battery, press the battery latch to the side, and slide the battery out of the camera as shown.

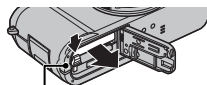

Battery latch

To remove the memory card, press it in and release it slowly. The card can then be removed by hand. When a memory card is removed, the card could be ejected too quickly. Use your finger to hold it and gently release the card.

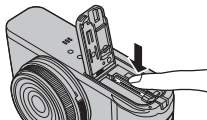

### Batteries

- Remove dirt from the battery terminals with a clean, dry cloth. Failure to observe this precaution could prevent the battery from charging.
- Do not affix stickers or other objects to the battery. Failure to observe this precaution could make it impossible to remove the battery from the camera.
- Do not short the battery terminals. The battery could overheat.
- Read the cautions in “The Battery and Power Supply” (iv).
- Use only battery chargers designated for use with the battery. Failure to observe this precaution could result in product malfunction.
- Do not remove the labels from the battery or attempt to split or peel the outer casing.
- The battery gradually loses its charge when not in use. Charge the battery one or two days before use.

## ■ Compatible Memory Cards

FUJIFILM and SanDisk SD, SDHC, and SDXC memory cards have been approved for use in the camera. A complete list of approved memory cards is available at [http://www.fujifilm.com/support/digital\\_cameras/compatibility/](http://www.fujifilm.com/support/digital_cameras/compatibility/). Operation is not guaranteed with other cards. The camera can not be used with *xD-Picture Cards* or **MultiMediaCard** (MMC) devices.



### ⓘ Memory Cards

- **Do not turn the camera off or remove the memory card while the memory card is being formatted or data are being recorded to or deleted from the card.** Failure to observe this precaution could damage the card.
- Format memory cards before first use, and be sure to reformat all memory cards after using them in a computer or other device. For more information on formatting memory cards, see page 92.
- Memory cards are small and can be swallowed; keep out of reach of children. If a child swallows a memory card, seek medical assistance immediately.
- miniSD or microSD adapters that are larger or smaller than the standard dimensions of an SD/SDHC/SDXC card may not eject normally; if the card does not eject, take the camera to an authorized service representative. Do not forcibly remove the card.
- Do not affix labels to memory cards. Peeling labels can cause camera malfunction.
- Movie recording may be interrupted with some types of SD/SDHC/SDXC memory card. Use a **CLASS10** card or better when shooting HD movies.
- The data in internal memory may be erased or corrupted when the camera is repaired. Please note that the repairer will be able to view pictures in internal memory.
- Formatting a memory card in the camera creates a folder in which pictures are stored. Do not rename or delete this folder or use a computer or other device to edit, delete, or rename image files. Always use the camera to delete pictures; before editing or renaming files, copy them to a computer and edit or rename the copies, not the originals. Renaming the files on the camera can cause problems during playback.

## Turning the Camera on and Off

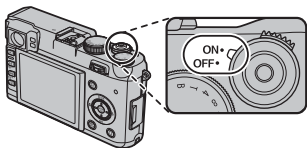



Rotate the **ON/OFF** switch to **ON** to turn the camera on. Select **OFF** to turn the camera off.



- ◆ Press the  button to start playback. Press the shutter button halfway to return to shooting mode.
- ◆ The camera will turn off automatically if no operations are performed for the length of time selected for  **POWER MANAGEMENT** > **AUTO POWER OFF** (📖 91). To reactivate the camera after it has turned off automatically, press the shutter button halfway or turn the **ON/OFF** switch to **OFF** and then back to **ON**.
- ◆ For information on other power saving and startup options, see page 91.
- ⚠ Fingerprints and other marks on the lens or viewfinder can affect pictures or the view through the viewfinder. Keep the lens and viewfinder clean.



### Battery Level

After turning the camera on, check the battery level in the display.

Indicator	Description
 (white)	Battery partially discharged.
 (white)	Battery more than half discharged
 (red)	Low battery. Charge as soon as possible.
 (blinks red)	Battery exhausted. Turn camera off and recharge battery.



## Basic Setup

A language-selection dialog is displayed the first time the camera is turned on. Set up the camera as described below (you can reset the clock or change languages at any time using the  **DATE/TIME** or  **言語/LANG.** options in the setup menu; for information on displaying the setup menu, see page 88).

### 1 Choose a language.



Highlight a language and press **MENU/OK**.

◆ Press **DISP/BACK** to skip the current step. Any steps you skip will be displayed the next time the camera is turned on.



### 2 Set the date and time.

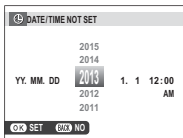

Press the command dial left or right to highlight the year, month, day, hour, or minute and press up or down to change. To change the order in which the year, month, and day are displayed, highlight the date format and press the command dial up or down. Press **MENU/OK** to exit to shooting mode when settings are complete.



◆ If the battery is removed for an extended period, the camera clock will be reset and the language-selection dialog will be displayed when the camera is turned on.

## Choosing a Display

The camera is equipped with a hybrid optical/electronic viewfinder (OVF/EVF) and an LCD monitor (LCD). Press **VIEW MODE** to choose a display.

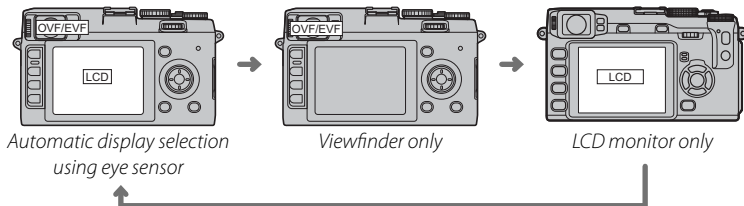
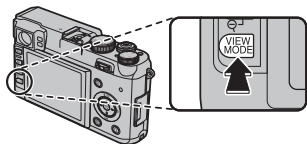

### Automatic Display Selection

The viewfinder turns on automatically when you put your eye to the viewfinder, and the LCD monitor turns on when you take your eye away (note that the eye sensor may respond to objects other than your eye or to light shining directly on the sensor).

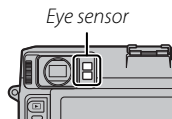



### **Focusing the Viewfinder**

The camera is equipped with diopter adjustment in the range  $-2$  to  $+1$  m<sup>-1</sup> to accommodate individual differences in vision. Rotate the diopter adjustment control until the viewfinder display is in sharp focus.

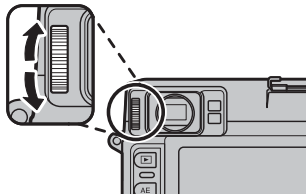

*Diopter adjustment control*

### **Adjusting Display Brightness**

The brightness of the viewfinder and LCD monitor can be adjusted using the  **SCREEN SET-UP** > **EVF/LCD BRIGHTNESS** option in the setup menu (📖 90).

### **Bright Ambient Lighting**

Reflections and glare caused by bright ambient lighting may make it hard to see the display in the monitor, particularly when the camera is used outdoors. This can be addressed by holding the **Q** button to trigger outdoor mode. Outdoor mode can also be enabled using the  **SCREEN SET-UP** > **MONITOR SUNLIGHT MODE** option in the setup menu (📖 90).

### **Using the Hybrid Viewfinder**

Use the viewfinder selector to choose between optical and electronic viewfinders.

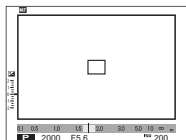

*Optical viewfinder display*

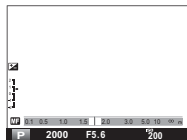

*Electronic viewfinder display*

### **Choosing a Display**

Choose a display according to the task.

Display	Description
Optical viewfinder (OVF)	This display is immune from digital video effects and allows the subject to be viewed directly with no display lag. Subjects are always in focus, allowing you to check their expression at any time, while a field of view slightly larger than that of the lens makes it easier to locate your subject without removing your eye from the viewfinder. The viewfinder window is however at a slight distance from the lens, with the result that the display in the viewfinder may differ slightly from the final photograph due to parallax.
Electronic viewfinder (EVF)	This display shows the view through the lens and has exactly the same field of view, allowing you to frame your subjects precisely and preview focus, depth of field, exposure, and white balance (although there may be a slight display lag). It can also be used to view photographs after shooting.
LCD monitor	This display is identical to the electronic viewfinder, except that its large size makes it easier to view shooting indicators and the view through the lens. It may however be difficult to see in bright light.

## The DISP/BACK Button

The **DISP/BACK** button controls the display of indicators in the viewfinder and LCD monitor.

### Optical Viewfinder: Shooting

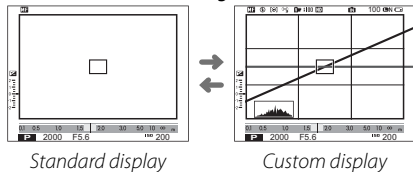

Standard display

Custom display

### Electronic Viewfinder: Shooting

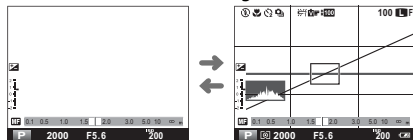

Standard display

Custom display

### LCD Monitor: Shooting

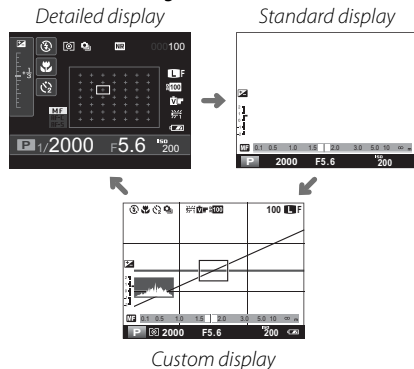

Detailed display

Standard display

Custom display

### Custom Display

Choose items for display using **DISP. CUSTOM SETTING** in the shooting menu (75):

Framing grid	Exposure (shutter speed, aperture, and sensitivity)	Film simulation
Virtual horizon	Exposure compensation	Dynamic range
Focus distance (autofocus)	Metering	Number of exposures remaining/media
Focus distance (manual focus)	Flash mode	Image quality and size
Histogram	White balance	Battery level

See pages 6–8 for the locations of these items in the displays.

## ■ Viewfinder/LCD Monitor: Playback

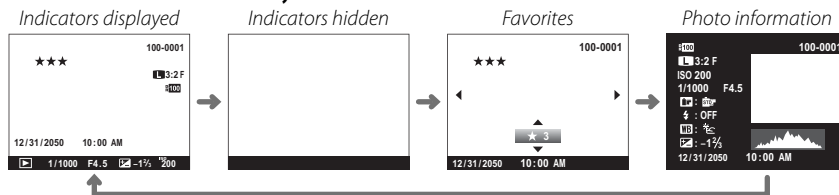

ⓘ The optical viewfinder can not be used for playback.

### ● Histograms

Histograms show the distribution of tones in the image. Brightness is shown by the horizontal axis, the number of pixels by the vertical axis.

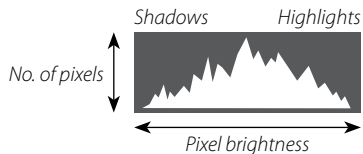

**Optimal exposure:** Pixels are distributed in an even curve throughout the tone range.



**Overexposed:** Pixels are clustered on the right side of the graph.



**Underexposed:** Pixels are clustered on the left side of the graph.



# Basic Photography and Playback

## Taking Photographs

This section describes how to take pictures using program AE (mode **P**). For information on **S**, **A**, and **M** modes, see page 36.

### 1 Select program AE.

Set shutter speed and aperture to **A** (shutter speed is set by rotating the shutter speed dial). **P** will appear in the display.

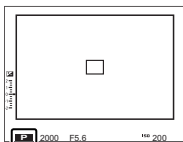
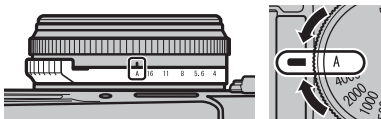

Optical viewfinder

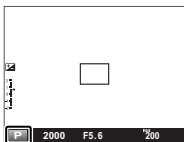

EVF/LCD

### The Q Button

The **Q** button can be used to view and adjust camera settings (page 34).

### 2 Select single AF.

Rotate the focus mode selector to **AF-S** (page 46).

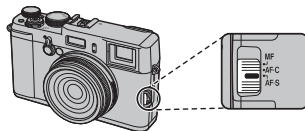

### 3 Ready the camera.

Hold the camera steady with both hands and brace your elbows against your sides. Shaking or unsteady hands can blur your shots.



To prevent pictures that are out of focus or too dark (underexposed), keep your fingers and other objects away from the lens, flash, and AF-assist illuminator.



## 4 Focus.

Frame the picture with your subject in the center of the display and press the shutter button halfway to focus.

◆ If the subject is poorly lit, the AF-assist illuminator may light (📖 78).

**If the camera is able to focus**, it will beep twice and focus area will glow green. Focus and exposure will lock while the shutter button is pressed halfway.

**If the camera is unable to focus**, the focus frame will turn red, and **!AF** will be displayed. If the subject is close to the camera, select macro mode and try again (📖 31).



## 5 Shoot.

Smoothly press the shutter button the rest of the way down to take the picture.



## Viewing Pictures

### Viewing Pictures Full Frame

Pictures can be viewed in the viewfinder or LCD monitor. When taking important pictures, take a test shot and check the results.

To view pictures full frame, press .

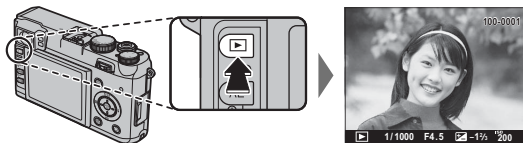

Additional pictures can be viewed by rotating the command dial or pressing it left or right. Press or rotate right to view pictures in the order recorded, left to view pictures in reverse order. Keep the dial pressed to scroll rapidly to the desired frame.



◆ Pictures taken using other cameras are indicated by a  (“gift image”) icon during playback.

### Favorites: Rating Pictures

To rate the current picture, press **DISP/BACK** and press the command dial up and down to select from zero to five stars.

## Viewing Photo Information

Photo information can be viewed by pressing the command control right.

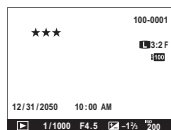

Basic data

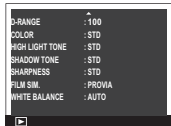

Details, page 1



Active focus point ("+")

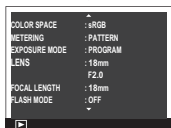

Details, page 2

- Rotate the command dial to view other images.

### Zooming in on the Focus Point

Press the center of the command control to zoom in on the focus point. Press the center of the command control again to return to full-frame playback.



## Playback Zoom

Press to zoom in on the current picture, to zoom out. When the picture is zoomed in, the command dial can be used to view areas of the image not currently visible in the display. Press **DISP/BACK** or **MENU/OK** to exit zoom.



Zoom indicator



Navigation window shows portion of image currently displayed

- The maximum zoom ratio varies with image size ( 72). Playback zoom is not available with cropped or resized copies saved at a size of 640.



## **Multi-Frame Playback**

To change the number of images displayed, press  when a picture is displayed full frame.





Use the command dial to highlight images and press **MENU/OK** to view the highlighted image full frame. In the nine- and hundred-frame displays, press the command dial up or down to view more pictures.

## Deleting Pictures

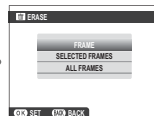
To delete individual pictures, multiple selected pictures, or all pictures, press the command dial up () and choose from the options below. *Note that deleted pictures can not be recovered. Copy important pictures to a computer or other storage device before proceeding.*



Option	Description
<b>FRAME</b>	Press the command dial left or right to scroll through pictures and press <b>MENU/OK</b> to delete the current picture (a confirmation dialog is not displayed).
<b>SELECTED FRAMES</b>	Highlight pictures and press <b>MENU/OK</b> to select or deselect (pictures in photobooks or print orders are shown by  ). When the operation is complete, press <b>DISP/BACK</b> to display a confirmation dialog, then highlight <b>OK</b> and press <b>MENU/OK</b> to delete the selected pictures.
<b>ALL FRAMES</b>	A confirmation dialog will be displayed; highlight <b>OK</b> and press <b>MENU/OK</b> to delete all unprotected pictures (if a memory card is inserted, only the pictures on the memory card will be affected; the pictures in internal memory are only deleted if no memory card is inserted). Pressing <b>DISP/BACK</b> cancels deletion; note that any pictures deleted before the button was pressed can not be recovered.

- ◆ Protected pictures can not be deleted. Remove protection from any pictures you wish to delete ( 82).
- ◆ Pictures can also be deleted by  **ERASE** from playback menu.
- ◆ If a message appears stating that the selected images are part of a DPOF print order, press **MENU/OK** to delete the pictures.

## Using the Flash

Use the built-in flash for additional lighting when shooting at night or indoors under low light.

To choose a flash mode, press the command dial right (➡) to display the following options, then rotate the dial or press it left or right to highlight an option and press **MENU/OK** to select.

Mode	Description
<b>AUTO</b> (AUTO FLASH)/ 👁️ (RED EYE REDUCTION)*	The flash fires when required. Recommended in most situations.
⚡ (FORCED FLASH)/ 👁️⚡ (FORCED FLASH)*	The flash fires whenever a picture is taken. Use for backlit subjects or for natural coloration when shooting in bright light.
🔇 (SUPPRESSED FLASH)	The flash does not fire even when the subject is poorly lit. Use of a tripod is recommended.
⚡📷 (SLOW SYNCHRO)/ 👁️📷 (RED EYE & SLOW)*	Capture both the main subject and the background under low light (note that brightly lit scenes may be overexposed).
📷 (COMMANDER)	The built-in flash can be used to control optional remote flash units.
📷 (EXTERNAL FLASH)	Select when using optional third-party flash units.

\* **Red-eye removal** (👁️, 👁️⚡, or 👁️📷) is available in these modes when **ON** is selected for **RED EYE REMOVAL** in the shooting menu (📖 79). Red-eye removal minimizes “red-eye” caused when light from the flash is reflected from the subject’s retinas as shown in the illustration at right.

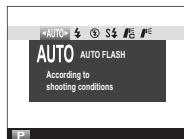

- ❖ If  is displayed when the shutter button is pressed halfway, the flash will fire when the photo is taken.
- ❖ Except in commander mode, the flash may fire several times with each shot. Do not move the camera until shooting is complete.
- ❖ Remove lens hoods to prevent shadows in photos taken with the flash.
- ⓘ Flash is not fired in silent mode.

### Flash Sync Speed

The flash will synchronize with the shutter at shutter speeds of  $\frac{1}{2000}$  s or slower.

### Optional Flash Units

The camera can also be used with optional FUJIFILM shoe-mounted flash units. Do not use third-party flash units that apply over high voltages to the camera hot shoe.

### Aperture, Sensitivity, and Flash Range

Flash range varies with sensitivity and aperture.

Aperture at sensitivity of						Range	
200	400	800	1600	3200	6400	m	ft.
—	—	—	—	—	2	0.5–18	1.6–59
—	—	—	—	2	2.8	0.5–13	1.6–42
—	—	—	2	2.8	4	0.5–9.0	1.6–29
—	—	2	2.8	4	5.6	0.5–6.4	1.6–20
—	2	2.8	4	5.6	8	0.5–4.5	1.6–14
2	2.8	4	5.6	8	11	0.5–3.2	1.6–10
2.8	4	5.6	8	11	16	0.5–2.3	1.6–7.5
4	5.6	8	11	16	—	0.5–1.6	1.6–5.2
5.6	8	11	16	—	—	0.5–1.1	1.6–3.6
8	11	16	—	—	—	0.5–0.8	1.6–2.6

## Macro Mode (Close-ups)

To focus at distances as close as 10 cm/4 in., press the command dial left (👉) and select 🌸. If the optical viewfinder is on, the camera will automatically switch to the electronic viewfinder (because of parallax, the camera will not focus at distances of less than 80 cm/2.6 ft. when the optical viewfinder is used). To exit macro mode, press the command dial left and select **OFF**.

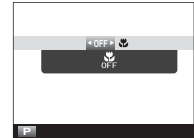

- ❖ The LCD monitor and electronic viewfinder can be used to focus at short ranges when macro mode is not selected, but the time needed to focus increases.
- ❖ The shadow cast by the lens may appear in photographs taken with the flash at distances under 50 cm/19.6 in. Turn the flash off or increase the distance to the subject.

# Basic Movie Recording and Playback

## Recording High-Definition (HD) Movies

The camera can be used to record short high-definition movies. Sound is recorded in stereo via the built-in microphone; during recording, do not cover the microphone or use the viewfinder selector, which is located next to the microphone.

1 Set aperture to **A**.

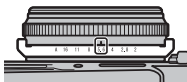

2 Press the **DRIVE** button to display drive options. Press the command dial up or down to high-light  (MOVIE) and press **MENU/OK**.

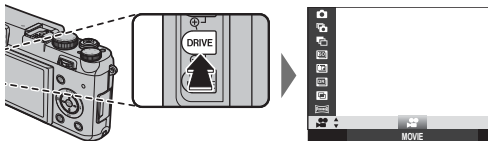

3 Press the shutter button all the way down to start recording.



4 Press the shutter button all the way down again to end recording. Recording ends automatically or when memory is full.





- ◆ Exposure and white balance are adjusted automatically throughout recording. The color and brightness of the image may vary from those displayed before recording begins.
- ◆ The indicator lamp lights while movies are being recorded.
- ① The microphone may pick up lens noise and other sounds made by the camera during recording.
- ① Vertical or horizontal streaks may appear in movies containing very bright subjects. This is normal and does not indicate a malfunction.
- ① If the optical viewfinder is on, the camera will automatically switch to the electronic viewfinder.

### The Q Button

The **Q** button can be used to view and adjust camera settings (📖 34).

## Viewing Movies

During playback, movies are displayed as shown at right. The following operations can be performed while a movie is displayed:

Operation	Description
Start/pause playback	<b>Press the command dial down</b> to start playback. Press again to pause. While playback is paused, you can press the command dial left or right to rewind or advance one frame at a time.
End playback	<b>Press the command dial up</b> to end playback.
Adjust speed	<b>Press the command dial left or right</b> to adjust playback speed during playback.
Adjust volume	<b>Press MENU/OK</b> to pause playback and display volume controls. Press the command dial up or down to adjust the volume; press <b>MENU/OK</b> again to resume playback. Volume can also be adjusted using the  <b>PLAYBACK VOLUME</b> option in the playback menu (  86).

Movie icon

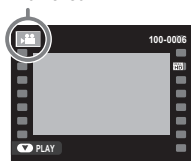

Progress is shown in the display during playback.

- ⓘ Do not cover the speaker during playback.
- ⓘ Sound is not played back in silent mode.

Progress bar

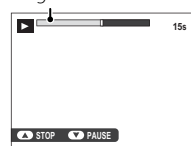

### Playback Speed

**Press the command dial left or right** to adjust playback speed during playback. Speed is shown by the number of arrows (▶ or ◀).

Arrow

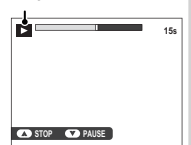

# The Q (Quick Menu) Button

## Using the Q (Quick Menu) Button

Press **Q** for quick access to the following items. For more information on the options available, see the pages listed below.

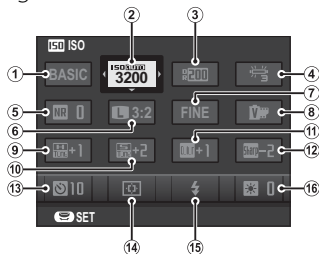

1	SELECT CUSTOM SETTING.....	70	9	HIGHLIGHT TONE.....	74
2	ISO ISO.....	44	10	SHADOW TONE.....	74
3	DYNAMIC RANGE.....	73	11	COLOR.....	74
4	WB WHITE BALANCE.....	42	12	SHARPNESS.....	74
5	NR NOISE REDUCTION.....	74	13	SELF-TIMER.....	53
6	IMAGE SIZE.....	72	14	AF MODE.....	77
7	IMAGE QUALITY.....	73	15	FLASH MODE.....	29
8	FILM SIMULATION.....	55	16	EVF/LCD BRIGHTNESS.....	90

1 Press **Q** to display the quick menu during shooting.

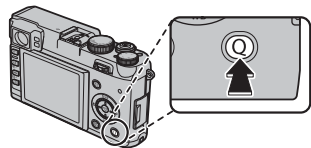

2 Use the command dial to highlight items and rotate the command control to change.







3 Press **Q** to exit when settings are complete.

◆ For quick access to custom settings banks, press and hold the **Q** button while the quick menu is displayed.



## Movie Mode

In movie mode, the quick menu contains the following items:

 <b>MOVIE MODE</b> .....	80	 <b>WB WHITE BALANCE</b> .....	42
 <b>FILM SIMULATION</b> .....	55	 <b>EVF/LCD BRIGHTNESS</b> .....	90



## More on Photography and Playback

### Choosing an Exposure Mode

The camera offers a choice of program AE (**P**), shutter-priority AE (**S**), aperture-priority AE (**A**), and manual exposure (**M**) modes.

#### Program AE (P)

To allow the camera to adjust both shutter speed and aperture for optimal exposure, rotate the aperture ring and shutter speed dial to **A**. **P** will appear in the display.

- ① If the subject is outside the metering range of the camera, the shutter speed and aperture displays will show “---”.

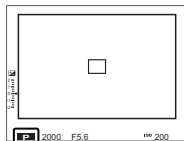
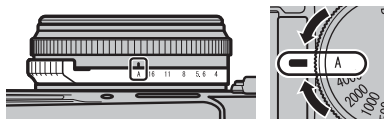

Optical viewfinder

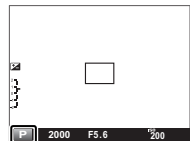

EVF/LCD

#### Program Shift

If desired, you can rotate the command dial or press the command control left or right to choose other combinations of shutter speed and aperture without altering exposure (program shift). Program shift is not available when a flash is used, **AUTO** is selected for **D-Ring DYNAMIC RANGE** in the shooting menu (☰ 73), or an auto option is selected for **ISO ISO** in the shooting menu (☰ 44).

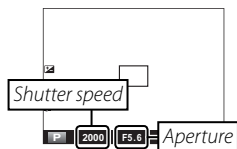

**Shutter-Priority AE (S)**

To adjust shutter speed manually while letting the camera select aperture for optimal exposure, rotate the aperture ring to **A** and use the shutter speed dial. **S** will appear in the display.

- ① If the correct exposure can not be achieved at the selected shutter speed, aperture will be displayed in red when the shutter button is pressed halfway. Adjust shutter speed until the correct exposure is achieved.
  - ① If the subject is outside the metering range of the camera, the aperture display will show “---”.
- ◆ Shutter speed can also be adjusted in increments of  $\frac{1}{3}$ EV by rotating the command dial.

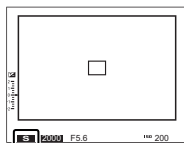
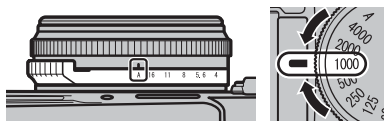

Optical viewfinder

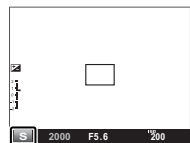

EVF/LCD



### **Aperture-Priority AE (A)**

To adjust aperture manually while letting the camera select shutter speed for optimal exposure, rotate the shutter speed dial to **A** and adjust aperture. **A** will appear in the display.

- ① If the correct exposure can not be achieved at the selected aperture, the shutter speed will be displayed in red when the shutter button is pressed halfway. Adjust aperture until the correct exposure is achieved.
- ① If the subject is outside the metering range of the camera, the shutter speed display will show “---”.
- ① The slowest shutter speed available when **ON** is selected for **OVF** **POWER SAVE MODE** is  $\frac{1}{4}$  s (📖 91).
- ❖ Aperture can also be adjusted in increments of  $\frac{1}{3}$  EV by pressing the command control left or right.

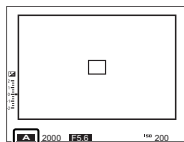
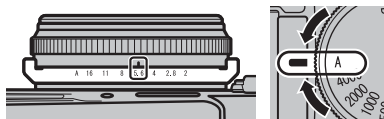

Optical viewfinder

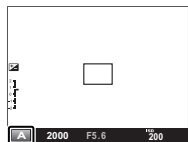

EVF/LCD



### **🔍 Previewing Depth of Field**

When **PREVIEW DEPTH OF FIELD** is selected for **Fn** **FN BUTTON** (📖 69) in the shooting menu, pressing the **Fn** button stops aperture down to the selected setting, allowing depth of field to be previewed in the viewfinder or LCD monitor.

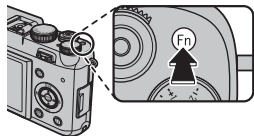

**Manual Exposure (M)**

Exposure can be altered from the value suggested by the camera by rotating both the shutter speed dial and aperture ring to settings other than **A**. **M** will appear in the display.

- The command dial and command control can be used to adjust shutter speed and aperture by  $\pm\frac{2}{3}$ EV from the selected value in steps of  $\frac{1}{3}$ EV. Use the command dial to adjust shutter speed, the command control to adjust aperture.



Command dial



Command control

- The manual exposure display includes an exposure indicator that shows the amount the picture would be under- or over-exposed at current settings.

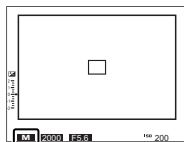
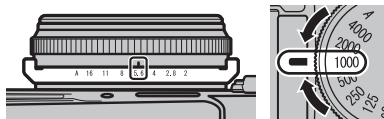

Optical viewfinder

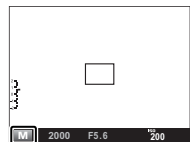

EVF/LCD

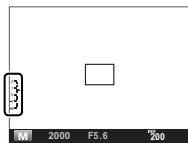

**Shutter Speed and Aperture**

Because the camera uses a lens-internal shutter, fast shutter speeds may not be available at large apertures. If the selected combination of shutter speed and aperture is unavailable, shutter speed or aperture will be displayed in red and the desired exposure may not be achieved.

Aperture	Shutter speed		
	$\frac{1}{4000}$ S	$\frac{1}{2000}$ S	$\frac{1}{1000}$ S or slower
F2	Not available	Not available	Available
F2.8			
F4		Available	
F5.6			
F8 or above	Available		

## Long Time-Exposures (T/B)

Select a shutter speed of **T** (time) or **B** (bulb) for long time-exposures.

- Use of a tripod is recommended to prevent the camera from moving during the exposure.
- To reduce “noise” (mottling) in long time-exposures, select **ON** for **LONG EXPOSURE NR** in the shooting menu (74). Note that this may increase the time needed to record images after shooting.

### Time (T)

1 Rotate the shutter speed dial to **T**.



2 Rotate the command dial to choose a shutter speed between 1/2 s and 30 s in steps of 1/3 EV.

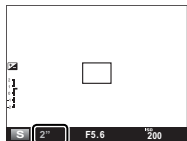

3 Press the shutter button all the way down to take a picture at the selected shutter speed. A count-down timer will be displayed while the exposure is in progress.



### Bulb (B)

1 Rotate the shutter speed dial to **B**.



2 Press the shutter button all the way down. The shutter will remain open for up to 60 minutes while the shutter button is pressed; the display shows the time elapsed since the exposure started.



- Selecting an aperture of **A** fixes shutter speed at 30 s.

### Third-Party Remote Releases

Third-party remote releases (available from third-party suppliers) can be connected as shown below.

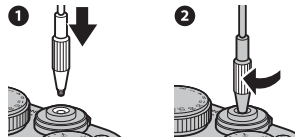

## White Balance

Press the command dial down (**WB**) to display the following options, then rotate the dial or press it left or right to highlight an option that matches the light source and press **MENU/OK**. The dialog shown at bottom right will be displayed; use the command dial to fine-tune white balance or press **DISP/BACK** to exit without fine-tuning (for an explanation of “white balance,” see the Glossary on page 118).



Option	Description
<b>AUTO</b>	White balance adjusted automatically.
	Measure a value for white balance (📖 43).
<b>K</b>	Selecting this option displays a list of color temperatures (📖 43); highlight a temperature and press <b>MENU/OK</b> to select the highlighted option and display the fine-tuning dialog.
	For subjects in direct sunlight.

Option	Description
	For subjects in the shade.
	Use under “daylight” fluorescent lights.
	Use under “warm white” fluorescent lights.
	Use under “cool white” fluorescent lights.
	Use under incandescent lighting.
	Reduces the blue cast typically associated with underwater lighting.

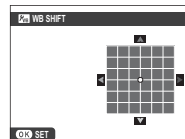
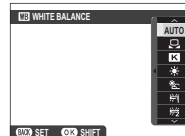



- White balance is adjusted for flash lighting only in **AUTO** and modes. Turn the flash off using other white balance options.
- Results vary with shooting conditions. Play pictures back after shooting to check colors.
- White balance can also be adjusted using the **Q** button.



### Custom White Balance

Choose  to adjust white balance for unusual lighting conditions. White balance measurement options will be displayed; frame a white object so that it fills the display and press the shutter button all the way down to measure white balance (to select the most recent custom value and exit without measuring white balance, press **DISP/BACK**, or press **MENU/OK** to select the most recent value and display the fine-tuning dialog).

- If **"COMPLETED!"** is displayed, press **MENU/OK** to set white balance to the measured value.
- If **"UNDER"** is displayed, raise exposure compensation ( 51) and try again.
- If **"OVER"** is displayed, lower exposure compensation ( 51) and try again.

### Color Temperature

Color temperature is an objective measure of the color of a light source, expressed in Kelvin (K). Light sources with a color temperature close to that of direct sunlight appear white; light sources with a lower color temperature have a yellow or red cast, while those with a higher color temperature are tinged with blue. You can match color temperature to the light source as shown in the following table, or choose options that differ sharply from the color of the light source to make pictures "warmer" or "colder."

◀ Choose for redder light sources  
or "colder" pictures

Choose for bluer light sources  
or "warmer" pictures ▶

2,000 K

Candlelight

Sunset/sunrise

5,000 K

Direct sunlight

Shade

15,000 K

Blue sky

## Sensitivity

“Sensitivity” refers to the camera’s sensitivity to light. Choose from values between 200 and 6400, or select **L (100)**, **H (12800)**, or **H (25600)** for special situations. Higher values can be used to reduce blur when lighting is poor, while lower values allow slower shutter speeds or wider apertures in bright light; note, however, that mottling may appear in pictures taken at high sensitivities, particularly at **H (25600)**, while choosing **L (100)** reduces dynamic range. Values of from ISO 200 to ISO 6400 are recommended in most situations. If an **AUTO** option is selected, the camera will adjust sensitivity automatically in response to shooting conditions; the value in parentheses is the maximum sensitivity that will be selected when the subject is poorly lit.

**1** Press **MENU/OK** in shooting mode to display the shooting menu. Press the command dial up or down to highlight **ISO ISO** and press **MENU/OK**.

◆ At default settings, ISO options can also be displayed by pressing the **Fn** button.

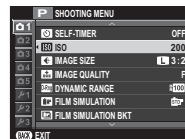

**2** Press the command dial up or down to highlight the desired option and press **MENU/OK** to select.

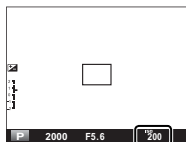

- ◆ Sensitivity is not reset when the camera is turned off.
- ◆ **L (100)** is reset to ISO 200 and **H (12800)** and **H (25600)** are reset to ISO 6400 when **RAW**, **FINE+RAW**, or **NORMAL+RAW** is selected for image quality (📖 73). For more information on the settings available with **L (100)**, **H (12800)**, and **H (25600)**, see page 125.

## ■ AUTO

The following options are available when **AUTO** is selected:

Option	Default
<b>DEFAULT SENSITIVITY</b>	200
<b>MAX. SENSITIVITY</b>	800
<b>MIN. SHUTTER SPEED</b>	1/60

The camera automatically chooses a sensitivity between the default and maximum values. Sensitivity is only raised above the default value if the shutter speed required for optimal exposure would be slower than the value selected for **MIN. SHUTTER SPEED**.



- ◆ If the value selected for **DEFAULT SENSITIVITY** is higher than that selected for **MAX. SENSITIVITY**, **DEFAULT SENSITIVITY** will be set to the value selected for **MAX. SENSITIVITY**.
- ◆ The camera may select shutter speeds slower than **MIN. SHUTTER SPEED** if pictures would still be underexposed at the value selected for **MAX. SENSITIVITY**.

## Focus Mode

Use the focus mode selector to choose how the camera focuses.

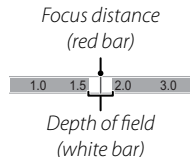
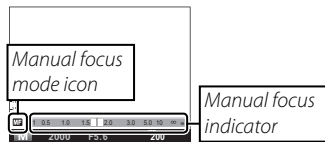
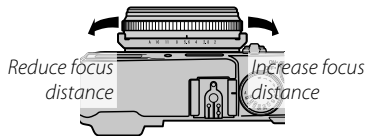
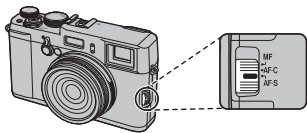
- **AF-S** (single AF): Focus locks while the shutter button is pressed halfway. Choose for stationary subjects.
- **AF-C** (continuous AF): Focus is continually adjusted to reflect changes in the distance to the subject even when the shutter button is not pressed halfway (note that this increases the drain on the battery).
- **MF** (manual): Focus manually using the lens focus ring. Rotate the ring left to reduce the focus distance, right to increase. The manual focus indicator indicates how closely the focus distance matches the distance to the subject in the focus brackets (the red bar indicates the focus distance, the white bar the depth of field, or in other words the distance in front of and behind the focus point that appears to be in focus); you can also check focus visually in the viewfinder or LCD monitor. Choose for manual control of focus or in situations in which the camera is unable to focus using autofocus (📖 50).



- 🔧 Use the  **FOCUS RING** option in the setup menu (📖 89) to reverse the direction of rotation of the focus ring.
- 🔧 The camera will not focus if the focus ring is rotated past infinity.
- 🔧 To focus using autofocus, press the **AFL/AEL** button. This can be used to quickly focus on a chosen subject in manual focus mode.
- 🔧 The camera can show focus distance in meters or feet. Use the  **FOCUS SCALE UNITS** option in the setup menu (📖 89) to choose the units used.

## MF Assist

The **MF ASSIST** option in the setup menu can be used to check focus when pictures are framed in the LCD monitor or electronic viewfinder.

◆ The **MF ASSIST** menu can be displayed by pressing and holding the center of the command control.

The following options are available:

- **FOCUS PEAK HIGHLIGHT:** Highlights high-contrast outlines. Rotate the focus ring until the subject is highlighted.
- **DIGITAL SPLIT IMAGE:** Displays a split, black-and-white image in the center of the frame. Frame the subject in the split-image area and rotate the focus ring until the three parts of the split image are correctly aligned.

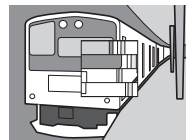



### Manual Focus: Checking Focus

If **ON** is selected for **MF FOCUS CHECK** in the setup menu (89), rotating the focus ring automatically magnifies the view in the electronic viewfinder or LCD monitor for precise focus. To scroll to other areas of the frame, press the **AF** button and rotate the command dial.



◆ The magnification varies depending on whether **STANDARD** or **FOCUS PEAK HIGHLIGHT/DIGITAL SPLIT IMAGE** is selected for **MF ASSIST**.

**Focus Frame Selection**

When  **AREA** is selected for  **AF MODE** in the shooting menu and **AF-S** is selected for focus mode, the electronic viewfinder and LCD monitor offer a choice of 49 focus points and the optical viewfinder a choice of 25, allowing photographs to be composed with the main subject positioned almost anywhere in the frame. To position the focus frame, press the **AF** button and then use the command dial (the focus frame can be returned to the center by pressing **DISP/BACK**). Press **MENU/OK** when the focus frame is in the desired position.

- ① When you switch to the optical viewfinder, the camera will select the focus frame closest to that selected in the electronic viewfinder or LCD monitor.

When framing pictures in the electronic viewfinder or LCD monitor, you can choose the size of the focus frame for **AF-S** by pressing the **AF** button and then pressing the command control left or right. Press the control left to reduce the frame by up to 50%, right to enlarge it by up to 150%. Press **MENU/OK** when the frame is the desired size.

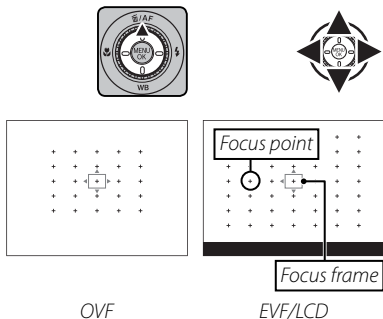

OVF

EVF/LCD

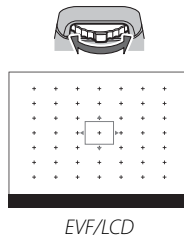

EVF/LCD

## Focus/Exposure Lock

To compose photographs with off-center subjects:

**1 Focus:** Position the subject in the focus frame and press the shutter button halfway to lock focus and exposure. Focus and exposure will remain locked while the shutter button is pressed halfway (AF/AE lock).

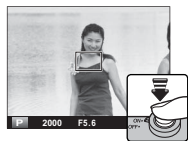

Depending on the option selected for **AE/AF-LOCK BUTTON** in the shooting menu (☰ 78), focus and/or exposure can also be locked by pressing the **AFL/AEL** button; focus and/or exposure will remain locked even when the shutter button is pressed halfway. Choose **AE LOCK ONLY** to lock exposure but not focus, **AF LOCK ONLY** to lock focus but not exposure, or **AE/AF LOCK** to lock both focus and exposure. Regardless of the option selected, the **AFL/AEL** button can not be used to lock exposure in manual focus mode (☰ 46).

**2 Recompose:** Keep the shutter button pressed halfway or keep the **AFL/AEL** button pressed.

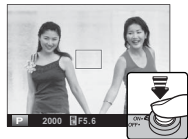

If **AE&AF ON/OFF SWITCH** is selected for **AE/AF-LOCK MODE** (☰ 78), focus and/or exposure lock when the **AFL/AEL** button is pressed and remain locked until the button is pressed again.

**3 Shoot:** Press the button all the way down.



## Autofocus

Although the camera boasts a high-precision autofocus system, it may be unable to focus on the subjects listed below.

- Very shiny subjects such as mirrors or car bodies.
- Fast-moving subjects.
- Subjects photographed through a window or other reflective object.
- Dark subjects and subjects that absorb rather than reflect light, such as hair or fur.
- Insubstantial subjects, such as smoke or flame.
- Subjects that show little contrast with the background (for example, subjects in clothing that is the same color as the background).
- Subjects positioned in front of or behind a high-contrast object that is also in the focus frame (for example, a subject photographed against a backdrop of highly contrasting elements).

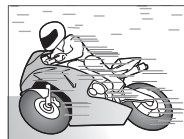



## Exposure Compensation

Rotate the exposure compensation dial to adjust exposure when photographing very bright, very dark, or high-contrast subjects. The effect is visible in the LCD monitor and electronic viewfinder; when using the optical viewfinder, use the exposure indicator to check exposure.



Exposure compensation indicator

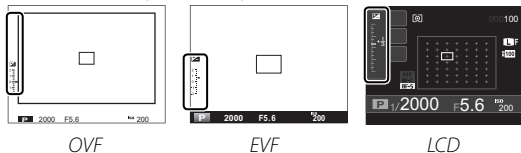

Choose positive values (+) to increase exposure



Choose negative values (-) to reduce exposure



### Exposure Value (EV)

The exposure value is determined by the sensitivity of the image sensor and the amount of light to which the sensor is exposed. Doubling the amount increases EV by one, while halving it reduces EV by one. The amount of light entering the camera can be controlled by adjusting aperture and shutter speed.

### Choosing an Exposure Compensation Value

- **Backlit subjects:** Choose values from  $+2/3$  EV to  $+1 2/3$  EV.



- **Highly reflective subjects or very bright scenes** (e.g., snowfields): +1 EV





- **Scenes that are mostly sky:** +1 EV

- **Spotlit subjects** (particularly if photographed against dark backgrounds):  $-2/3$  EV

- **Subjects with low reflectivity** (pine trees or dark-colored foliage):  $-2/3$  EV

## Metering

To choose how the camera meters exposure, press the **AE** button to display metering options. Use the command dial to highlight an option and press **AE** to select.

Mode	Description
 (MULTI)	The camera instantly determines exposure based on an analysis of composition, color, and brightness distribution. Recommended in most situations.
 (SPOT)	The camera meters lighting conditions in an area at the center of the frame equivalent to 2% of the total. Recommended with backlit subjects and in other cases in which the background is much brighter or darker than the main subject.
 (AVERAGE)	Exposure is set to the average for the entire frame. Provides consistent exposure across multiple shots with the same lighting, and is particularly effective for landscapes and portraits of subjects dressed in black or white.

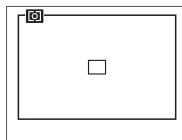
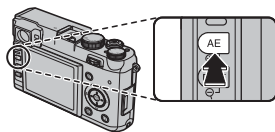

*OVF*

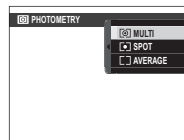

*EVF/LCD*

## Using the Self-Timer

Use the timer for self-portraits or to prevent blur caused by camera shake.

- 1 Press **MENU/OK** in shooting mode to display the shooting menu. Press the command dial up or down to highlight **SELF-TIMER** and press **MENU/OK**.



- 2 Press the command dial up or down to highlight one of the following options and press **MENU/OK** to select.

Option	Description
<b>2 SEC</b>	The shutter is released two seconds after the shutter button is pressed. Use to reduce blur caused by the camera moving when the shutter button is pressed.
<b>10 SEC</b>	The shutter is released ten seconds after the shutter button is pressed. Use for photographs in which you wish to appear yourself.
<b>OFF</b>	Self-timer off.



- 3 Press the shutter button halfway to focus.

- 1 Stand behind the camera when using the shutter button. Standing in front of the lens can interfere with focus and exposure.



- 4** Press the shutter button the rest of the way down to start the timer. The display in the monitor shows the number of seconds remaining until the shutter is released. To stop the timer before the picture is taken, press **DISP/BACK**.



The self-timer lamp on the front of the camera will blink immediately before the picture is taken. If the two-second timer is selected, the self-timer lamp will blink as the timer counts down.

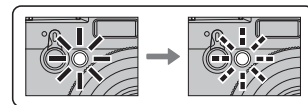

- ◆ The self-timer turns off automatically when the camera is turned off.

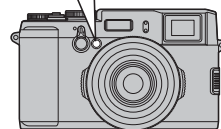

## Film Simulation

Simulate the effects of different kinds of film, including black-and-white (with or without color filters).

- 1 Press **MENU/OK** in shooting mode to display the shooting menu. Press the command dial up or down to highlight **F** **FILM SIMULATION** and press **MENU/OK**.

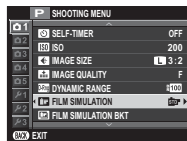

- 2 Press the command dial up or down to highlight one of the following options and press **MENU/OK** to select.

Option	Description
<b>STD</b> (PROVIA/STANDARD)	Standard color reproduction. Suited to a wide range of subjects, from portraits to landscapes.
<b>VIVID</b> (Velvia/VIVID)	A high-contrast palette of saturated colors, suited to nature photos.
<b>ASTIA</b> (ASTIA/SOFT)	Enhances the range of hues available for skin tones in portraits while preserving the bright blues of daylight skies. Recommended for outdoor portrait photography.
<b>PRO Neg. Hi</b>	Offers slightly more contrast than <b>PRO Neg. Std</b> . Recommended for outdoor portrait photography.
<b>PRO Neg. Std</b>	A soft-toned palette. The range of hues available for skin tones is enhanced, making this a good choice for studio portrait photography.
<b>MONOCHROME</b>	Take pictures in standard black and white.
<b>MONOCHROME + Ye FILTER</b>	Take black-and-white pictures with slightly increased contrast. This setting also slightly tones down the brightness of the sky.
<b>MONOCHROME + R FILTER</b>	Take black-and-white pictures with increased contrast. This setting also tones down the brightness of the sky.
<b>MONOCHROME + G FILTER</b>	Soften skin tones in black-and-white portraits.
<b>SEPIA</b>	Take pictures in sepia.

- ◆ Film simulation options can be combined with tone and sharpness settings (74).

## Bracketing

Automatically vary settings over a series of pictures.

- 1 Press the **DRIVE** button to display drive options and rotate the dial or press it up or down to highlight one of the following:

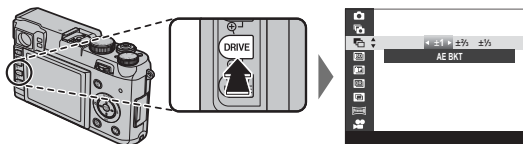

Option	Description
<b>AE BKT</b>	Press the command dial left or right to highlight a bracketing amount. Each time the shutter button is pressed, the camera will take three shots: one using the metered value for exposure, the second overexposed by the selected amount, and the third underexposed by the same amount (regardless of the amount selected, exposure will not exceed the limits of the exposure metering system).
<b>ISO BKT</b>	Press the command dial left or right to highlight a bracketing amount. Each time the shutter is released, the camera will take a picture at the current sensitivity (☰ 44) and process it to create two additional copies, one with sensitivity raised and the other with sensitivity lowered by the selected amount (regardless of the amount selected, sensitivity will not exceed ISO 6400 or fall below ISO 200).
<b>FILM SIMULATION BKT</b>	Each time the shutter is released, the camera takes one shot and processes it to create copies with the film simulation settings selected for <b>FILM SIMULATION BKT</b> in the shooting menu (☰ 73).
<b>DYNAMIC RANGE BKT</b>	Each time the shutter button is pressed, the camera takes three shots with different dynamic ranges (☰ 73): 100% for the first, 200% for the second, and 400% for the third. While dynamic range bracketing is in effect, sensitivity will be restricted to a minimum of ISO 800; the sensitivity previously in effect is restored when bracketing ends.

Press **MENU/OK** to select the highlighted option.

- 2 Take photographs.

## Multiple Exposures

Create a photograph that combines two exposures.



1 Press the **DRIVE** button to display drive options.

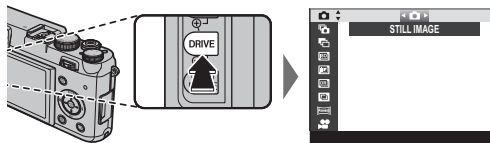

2 Press the command dial up or down to highlight **MULTIPLE EXPOSURE** and press **MENU/OK**.



3 Take the first shot.

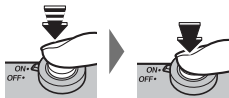

4 Press **MENU/OK**. You will be prompted to take the second shot.



◆ To return to Step 2 and retake the first shot, press the command dial left. To save the first shot and exit without creating a multiple exposure, press **DISP/BACK**.

5 Take the second shot.



6 Press **MENU/OK** to create the multiple exposure, or press the command dial left to return to Step 4 and re-take the second shot.



## Continuous Shooting (Burst Mode)

Capture motion in a series of pictures.

- 1 Press the **DRIVE** button to display drive options. Press the command dial up or down to highlight  (CONTINUOUS), and the options shown below will be displayed.

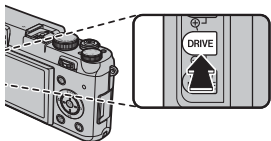

- 2 Press the command dial right or left to choose from frame rates of approximately **6.0 fps** (frames per second) and **3.0 fps**. Press **MENU/OK** to proceed when settings are complete.



- 3 Press the shutter button halfway to focus.



- 4 Press the shutter button the rest of the way down to start shooting. Shooting ends when the shutter button is released, the selected number of pictures has been taken, or the memory card is full.



- ◆ Focus and exposure are determined by the first frame in each series. The flash turns off automatically; the previously-selected flash mode is restored when burst shooting is turned off.
- ◆ Frame rate varies with shutter speed and may slow as more shots are taken.
- ◆ Additional time may be required to record pictures when shooting ends.
- ◆ If file numbering reaches 999 before shooting is complete, the remaining pictures will be recorded to a new folder (89).
- ◆ In some drive modes, shooting may not begin if the space available on the memory card is insufficient.



**Viewing Pictures Taken in a Single Burst**

When a picture taken in continuous shooting mode is displayed full-frame, the first picture in the current burst can be viewed by pressing the command dial down (burst mode playback). Press the command dial right to view pictures in the order recorded, left to view pictures in reverse order. Keep the command dial pressed to scroll rapidly to the desired frame. To exit, press **DISP/BACK**.

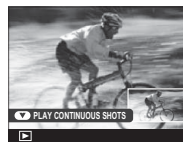

Position in burst/total number  
of pictures in burst



First picture in burst

- ◆ Pressing the command dial right when the last picture in the burst is displayed displays the first picture in the burst; similarly, pressing the command dial left when the first picture is displayed displays the last picture.
- ◆ Deletion (📖 81), rotation (📖 83), and protect (📖 82) operations applied during burst mode playback apply only to the current picture. In contrast, if these operations are performed when a picture taken in continuous shooting mode is displayed in full-frame playback, all images in the same burst will be affected.

### Bursts That Cross Folders

If a single burst is spread across multiple folders, the pictures in each folder will be treated as separate bursts.

## Panoramas

Follow an on-screen guide to create a panorama.

- 1 Press the **DRIVE** button to display drive options. Press the command dial up or down to highlight  (MOTION PANORAMA) and press **MENU/OK**.

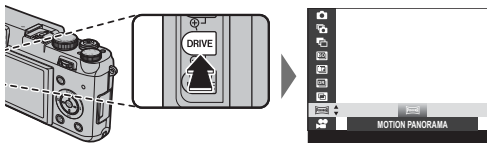

- 2 To select the size of the angle through which you will pan the camera while shooting, press the command dial left. Highlight a size and press **MENU/OK**.



- 3 Press the command dial right to view a choice of pan directions. Highlight a pan direction and press **MENU/OK**.



- 4 Press the shutter button all the way down to start recording. There is no need to keep the shutter button pressed during recording.

- 5 Pan the camera in the direction shown by the arrow. Shooting ends automatically when the camera is panned to the end of the guides and the panorama is complete.

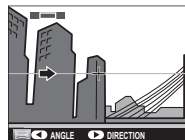

- ◆ Shooting ends if the shutter button is pressed all the way down during shooting. No panorama may be recorded if the shutter button is pressed before the panorama is complete.

The size of the completed panorama varies with the angle and pan direction.

Angle	Pan direction	Size (W × H)
120°	Horizontal	6,440 × 1,440
	Vertical	2,160 × 6,440
180°	Horizontal	9,600 × 1,440
	Vertical	2,160 × 9,600

- ① Panoramas are created from multiple frames; exposure for the entire panorama is determined by the first frame. The camera may in some cases record a greater or lesser angle than selected or be unable to stitch the frames together perfectly. The last part of the panorama may not be recorded if shooting ends before the panorama is complete.
- ① Shooting may be interrupted if the camera is panned too quickly or too slowly. Panning the camera in a direction other than that shown cancels shooting.
- ① The desired results may not be achieved with moving subjects, subjects close to the camera, unvarying subjects such as the sky or a field of grass, subjects that are in constant motion, such as waves and waterfalls, or subjects that undergo marked changes in brightness. Panoramas may be blurred if the subject is poorly lit.

 **For Best Results**

For best results, prop your elbows against your sides and move the camera slowly in a small circle at a steady speed, keeping the camera horizontal and being careful only to pan in the direction shown by the guides. Use a tripod for best results. If the desired results are not achieved, try panning at a different speed.

### **Viewing Panoramas**

In full-frame playback, panoramas can be played back using the command dial. Press the command dial down to start playback and press again to pause. While playback is paused, you can scroll the panorama manually by pressing the command dial left or right. To exit to full-frame playback, press the command dial up.

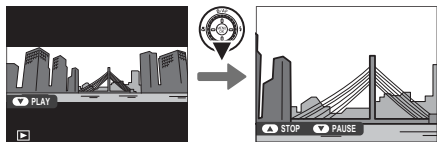

## Recording Pictures in RAW Format

To toggle RAW image quality on or off for a single shot, assign **RAW** to the **Fn** button (📖 69). If a JPEG option is currently selected for image quality, pressing the **Fn** button temporarily selects the equivalent JPEG+RAW option. If a JPEG+RAW option is currently selected, pressing the **Fn** button temporarily selects the equivalent JPEG option, while if **RAW** is selected, pressing the **Fn** button temporarily selects **FINE**. Taking a picture or pressing the **Fn** button again restores the previous setting.

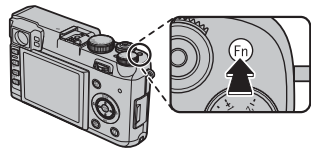

- ◆ RAW images record raw, unprocessed data from the camera image sensor. JPEG copies of RAW images can be created using the **RAW RAW CONVERSION** option in the playback menu, or RAW images can be viewed on a computer using the RAW FILE CONVERTER application that is installed with the software on the supplied CD (📖 94, 95).
- ◆ Sensitivities of **L (100)**, **H (12800)**, and **H (25600)** are not available when RAW image quality is on (📖 44).

## **Creating JPEG Copies of RAW Pictures**

RAW pictures store information on camera settings separately from the data captured by the camera image sensor. Using the **RAW RAW CONVERSION** option in the playback menu, you can create JPEG copies of RAW pictures using different options for the settings listed below. The original image data are unaffected, allowing a single RAW image to be processed in a multitude of different ways.

- 1 Press **MENU/OK** during playback to display the playback menu, then press the command dial up or down to highlight **RAW RAW CONVERSION** and press **MENU/OK** to display the settings listed in the table at right.

◆ These options can also be displayed by pressing **Q** during playback.

- 2 Press the command dial up or down to highlight a setting and press the command dial right to select. Press the command dial up or down to highlight the desired option and press **MENU/OK** to select and return to the settings list. Repeat this step to adjust additional settings.

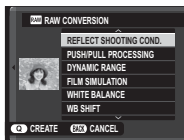

- 3 Press the **Q** button to preview the JPEG copy and press **MENU/OK** to save.

Setting	Description
<b>REFLECT SHOOTING COND.</b>	Create a JPEG copy using the settings in effect at the time the photo was taken.
<b>PUSH/PULL PROCESSING</b>	Adjust exposure by $-1$ EV to $+3$ EV in increments of $\frac{1}{2}$ EV (📖 51).
<b>DYNAMIC RANGE</b>	Enhance details in highlights for natural contrast (📖 73).
<b>FILM SIMULATION</b>	Simulate the effects of different types of film (📖 55).
<b>WHITE BALANCE</b>	Adjust white balance (📖 42).
<b>WB SHIFT</b>	Fine-tune white balance (📖 42).
<b>COLOR</b>	Adjust color density (📖 74).
<b>SHARPNESS</b>	Sharpen or soften outlines (📖 74).
<b>HIGHLIGHT TONE</b>	Adjust highlights (📖 74).
<b>SHADOW TONE</b>	Adjust shadows (📖 74).
<b>NOISE REDUCTION</b>	Process the copy to reduce mottling (📖 74).
<b>COLOR SPACE</b>	Choose the color space used for color reproduction (📖 91).

## The ND Filter

The camera is equipped with a **N**eutral **D**ensity (ND) filter that reduces exposure by the equivalent of 3 EV. This allows slower shutter speeds or wider apertures to be used with brightly lit subjects, making it possible to blur motion or soften background details without risk of overexposure.

- 1 Press **MENU/OK** in shooting mode to display the shooting menu. Press the command dial up or down to highlight **ND ND FILTER** and press **MENU/OK**.

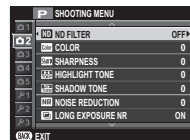

- 2 Press the command dial up or down to highlight **ON** and press **MENU/OK** to select.

## Image Search



Follow the steps below to search for pictures.

**1** Press **MENU/OK** during playback to display the playback menu. Press the command dial up or down to highlight  **IMAGE SEARCH** and press **MENU/OK**.

**2** Highlight an option and press **MENU/OK**.

Option	Description
<b>BY DATE</b>	Search by date.
<b>BY FACE</b>	Search for pictures that include faces.
<b>BY ★ FAVORITES</b>	Search by rating (📖 25).
<b>BY TYPE OF DATA</b>	Find all still pictures, all movies, all pictures taken in burst mode, or all RAW pictures.
<b>BY UPLOAD MARK</b>	Find all pictures selected for upload to a specified destination.

**3** Select a search condition. Only pictures that match the search condition will be displayed. To delete or protect selected pictures or to view the selected pictures in a slide show, press **MENU/OK** and choose from the options at right.

Option	See page
 <b>ERASE</b>	81
 <b>PROTECT</b>	82
 <b>SLIDE SHOW</b>	84



**4** To end the search, select **EXIT SEARCH**.





## PhotoBook Assist

Create books from your favorite photos.

### ***Creating a PhotoBook***

**1** Select **NEW BOOK** for  **PHOTOBOOK ASSIST** in the playback menu ( 85) and choose from the following options:

- **SELECT FROM ALL:** Choose from all available pictures.
- **SELECT BY IMAGE SEARCH:** Choose from pictures matching selected search conditions ( 66).
- ◆ Neither photographs  640 or smaller nor movies can be selected for photobooks.

**2** Scroll through the images and press the command dial up to select or deselect. To display the current image on the cover, press the command dial down. Press **MENU/OK** to exit when the book is complete.

- ◆ The first picture selected becomes the cover image. Press the command dial down to select a different image for the cover.

**3** Highlight **COMPLETE PHOTOBOOK** and press **MENU/OK** (to select all photos or all photos matching the specified search conditions for the book, choose **SELECT ALL**). The new book will be added to the list in the photobook assist menu.

- ⓘ Books can contain up to 300 pictures.
- ⓘ Books that contain no photos are automatically deleted.

### **Viewing Photobooks**

Highlight a book in the photobook assist menu and press **MENU/OK** to display the book, then press the command dial left or right to scroll through the pictures.

### **Editing and Deleting Photobooks**

Display the photobook and press **MENU/OK**. The following options will be displayed; select the desired option and follow the on-screen instructions.

- **EDIT:** Edit the book as described in “Creating a PhotoBook” (📖 67).
- **ERASE:** Delete the book.

#### **Photobooks**

Photobooks can be copied to a computer using the supplied MyFinePix Studio software (📖 93).

## The Fn Button

The role played by the **Fn** button can be selected using the **Fn Fn BUTTON** option in the shooting menu (📖 74). The options available include multiple exposure (📖 57), depth-of-field preview (📖 38), sensitivity (📖 44), the self-timer (📖 53), image size (📖 72), image quality (📖 73), dynamic range (📖 73), film simulation (📖 55), ND filter (📖 65), AF mode (📖 77), custom settings (📖 70), movie recording (📖 32), advanced filter (📖 77), RAW/JPEG toggle (📖 63), and wide conversion lens (📖 108).

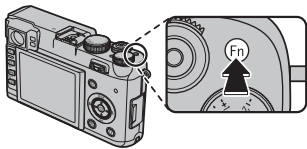

◆ The **Fn Fn BUTTON** menu can also be displayed by pressing and holding the **Fn** button.

## Saving Settings

Save up to 3 sets of custom camera settings for commonly-encountered situations. Saved settings can be recalled using the **SELECT CUSTOM SETTING** option in the shooting menu.

- 1 Press **MENU/OK** in shooting mode to display the shooting menu. Press the command dial up or down to highlight **EDIT/SAVE CUSTOM SETTING** and press **MENU/OK**.



- 2 Highlight a custom settings bank and press **MENU/OK** to select. Adjust the following as desired and press **DISP/BACK** when adjustments are complete: **ISO**, **D-Ring DYNAMIC RANGE**, **Film SIMULATION**, **WB WHITE BALANCE**, **Color COLOR**, **Sharp SHARPNESS**, **Highlight TONE**, **Shadow TONE**, **NR NOISE REDUCTION**, and **RESET**.

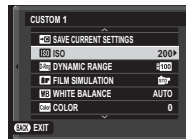

- ◆ To replace the settings in the selected bank with the settings currently selected with the camera, select **SAVE CURRENT SETTINGS** and press **MENU/OK**.
- ◆ To reset settings for the current bank, highlight **RESET** and press **MENU/OK**.

- 3 A confirmation dialog will be displayed; highlight **OK** and press **MENU/OK**.

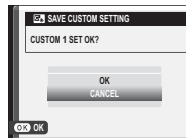

## Advanced Movie Recording

### **Depth of Field**

Aperture can be set manually for movie recording by selecting an aperture other than **A** for aperture-priority AE. Adjust aperture before recording begins. Choose low f-numbers to soften background details. The effect can be heightened by increasing the distance between your subject and the background.

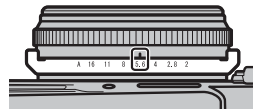

ⓘ Movies recorded when the aperture is displayed in red will not be correctly exposed.

### **Before Recording**

Before recording, adjust movie settings (📖 80), aperture (📖 38), and exposure compensation (📖 51) and select a focus mode (📖 46). These settings can not be adjusted during recording.

### **Using an External Microphone**

The camera can be used with optional MIC-ST1 stereo microphones using the cable supplied with the MIC-ST1. See the microphone manual for details.

◆ Recording level can be adjusted using  **MIC LEVEL ADJUSTMENT** (📖 80).

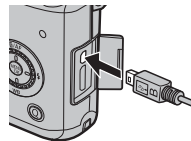

# Menus

## Using the Menus: Shooting Mode

The shooting menu is used to adjust settings for a wide range of shooting conditions. To display the shooting menu, press **MENU/OK** in shooting mode. Highlight items and press the command dial right to view options, then highlight an option and press **MENU/OK**. Press **DISP/BACK** to exit when settings are complete.

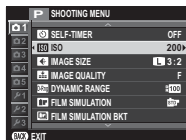

### Shooting Menu Options (Photographs)

#### SELF-TIMER

(default: **OFF**)

Take pictures with the self-timer (📖 53).

#### ISO

(default: **200**)

Control the camera's sensitivity to light (📖 44).

#### IMAGE SIZE

(default: **L 3:2**)

Choose the size and aspect ratio at which still pictures are recorded.

##### Aspect Ratio

Pictures with an aspect ratio of 3:2 have the same proportions as a frame of 35 mm film, while an aspect ratio of 16:9 is suited to display on **High Definition (HD)** devices. Pictures with an aspect ratio of 1:1 are square.

Option	Prints at sizes up to	Option	Prints at sizes up to
<b>L 3:2</b>	41 × 28 cm (16 × 11 in.)	<b>S 3:2</b>	21 × 14 cm (8 × 5 in.)
<b>L 16:9</b>	41 × 23 cm (16 × 9 in.)	<b>S 16:9</b>	21 × 12 cm (8 × 4 in.)
<b>L 1:1</b>	28 × 28 cm (11 × 11 in.)	<b>S 1:1</b>	14 × 14 cm (5 × 5 in.)
<b>M 3:2</b>	29 × 20 cm (11 × 7 in.)		
<b>M 16:9</b>	29 × 16 cm (11 × 6 in.)		
<b>M 1:1</b>	20 × 20 cm (7 × 7 in.)		

**IMAGE SIZE** is not reset when the camera is turned off or another shooting mode is selected.

**IMAGE QUALITY**(default: **FINE**)

Choose a file format and compression ratio. Select **FINE** or **NORMAL** to record JPEG images, **RAW** to record RAW images, or **FINE+RAW** or **NORMAL+RAW** to record both JPEG and RAW images. **FINE** and **FINE+RAW** use lower JPEG compression ratios for higher-quality JPEG images, while **NORMAL** and **NORMAL+RAW** use higher JPEG compression ratios to increase the number of images that can be stored.

**DYNAMIC RANGE**(default: **100**)

Control contrast. Choose lower values to increase contrast when shooting indoors or under overcast skies, higher values to reduce loss of detail in highlights and shadows when photographing high-contrast scenes. Higher values are recommended for scenes that include both sunlight and deep shade, for such high-contrast subjects as sunlight on water, brightly-lit autumn leaves, and portraits taken against a blue sky, and for white objects or people wearing white; note, however, that mottling may appear in pictures taken at higher values.

- ◆ If **AUTO** is selected, shutter speed and aperture will be displayed when the shutter button is pressed halfway.
- ◆ **200%** is available at sensitivities of ISO 400 and above, **400%** at sensitivities of ISO 800 and above.

**FILM SIMULATION**(default: **PROVIA/STANDARD**)

Simulate the effects of different types of film (📖 55).

**FILM SIMULATION BKT**

Choose film types for film simulation bracketing (📖 56).

**ND FILTER**(default: **OFF**)

Turn the ND filter on or off (📖 65).

 **COLOR** (default: **MID**)

Adjust color density.

 **SHARPNESS** (default: **STANDARD**)

Sharpen or soften outlines.

 **HIGHLIGHT TONE** (default: **STANDARD**)

Adjust the appearance of highlights.

 **SHADOW TONE** (default: **STANDARD**)

Adjust the appearance of shadows.

 **NOISE REDUCTION** (default: **STANDARD**)

Reduce noise in pictures taken at high sensitivities.

 **LONG EXPOSURE NR** (default: **ON**)

Select **ON** to reduce mottling in long time-exposures (📖 41).

 **SELECT CUSTOM SETTING**

Recall settings saved with  **EDIT/SAVE CUSTOM SETTING**.

 **EDIT/SAVE CUSTOM SETTING**

Save settings (📖 70).

 **Fn BUTTON** (default: **ISO ISO**)

Choose the role played by the **Fn** button (📖 69).

---



**DISP. CUSTOM SETTING**

Choose the items displayed in the viewfinder and LCD monitor (📖 21). The following items can be displayed: framing grid (you can also select the grid type as described on page 76), virtual horizon, focus distance (auto or manual), histogram, exposure (shutter speed, aperture, and sensitivity), exposure compensation/exposure indicator, metering, flash mode, white balance, film simulation, dynamic range, number of exposures remaining, image size and quality, and battery level. See pages 6–8 for the locations of these items in the displays. Press the command dial up or down to highlight items and press **MENU/OK** to select or deselect. Press **DISP/BACK** to exit when settings are complete.

**Virtual Horizon**

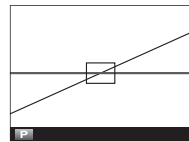

Selecting **ELECTRONIC LEVEL** displays a virtual horizon. The camera is level when the two lines overlap.

◆ The virtual horizon may not be displayed if the camera lens is pointed up or down.



**FRAMING GUIDELINE**(default: **GRID 9**)

Choose the type of framing grid available in shooting mode.

GRID 9	GRID 24	HD FRAMING
 <p data-bbox="132 342 405 366"><i>For “rule of thirds” composition.</i></p>	 <p data-bbox="580 342 734 366"><i>A six-by-four grid.</i></p>	 <p data-bbox="856 342 1233 394"><i>Frame HD pictures in the crop shown by the lines at the top and bottom of the display.</i></p>













**WIDE CONVERSION LENS**(default: **OFF**)Select **ON** when using the an optional wide conversion lens (📖 108).**MF ASSIST**(default: **STANDARD**)

Choose how focus is displayed in manual focus mode (📖 47).

Option	Description
<b>STANDARD</b>	Focus is displayed normally (focus peaking and digital split image are not available).
<b>DIGITAL SPLIT IMAGE</b>	A black-and-white split-image display.
<b>FOCUS PEAK HIGHLIGHT</b>	The camera heightens high-contrast outlines. Choose from <b>LOW</b> and <b>HIGH</b> .

**ADVANCED FILTER**(default: **OFF**)



Take photos with filter effects. Choose from the following filters.

Filter	Description
 <b>TOY CAMERA</b>	Choose for a retro toy camera effect.
 <b>MINIATURE</b>	The tops and bottoms of pictures are blurred for a diorama effect.
 <b>POP COLOR</b>	Create high-contrast images with saturated colors.
 <b>HIGH-KEY</b>	Create bright, low-contrast images.
 <b>LOW-KEY</b>	Create uniformly dark tones with few areas of emphasized highlights.
 <b>DYNAMIC TONE</b>	Dynamic tone expression is used for a fantasy effect.
 <b>SOFT FOCUS</b>	Create a look that is evenly soft throughout the whole image.
 <b>PARTIAL COLOR (RED)</b>	Areas of the image that are the selected color are recorded in that color. All others areas of the image are recorded in black-and-white.
 <b>PARTIAL COLOR (ORANGE)</b>	
 <b>PARTIAL COLOR (YELLOW)</b>	
 <b>PARTIAL COLOR (GREEN)</b>	
 <b>PARTIAL COLOR (BLUE)</b>	
 <b>PARTIAL COLOR (PURPLE)</b>	

Depending on the subject and camera settings, images may in some cases be grainy or vary in brightness and hue.

**AF MODE**(default:  **AREA**)

Choose how the camera selects the focus area when in focus mode **AF-S**.

-  **MULTI**: When the shutter button is pressed halfway, the camera detects high-contrast subjects and selects the focus area automatically.
-  **AREA**: Choose the focus area manually ( 48).

**AF- AF ILLUMINATOR**(default: **ON**)

If **ON** is selected, the AF-assist illuminator will light to assist autofocus.

◆ The AF-assist illuminator turns off automatically in silent mode.

① The camera may be unable to focus using the AF-assist illuminator in some cases. If the camera is unable to focus in macro mode, try increasing the distance to the subject.

① Avoid shining the AF-assist illuminator directly into your subject's eyes.

**AEL AE/AF-LOCK MODE**(default: **AE & AF ON WHEN PRESSING**)

If **AE & AF ON WHEN PRESSING** is selected, exposure and/or focus will lock while the **AFL/AEL** button is pressed. If **AE & AF ON/OFF SWITCH** is selected, exposure and/or focus will lock while the **AFL/AEL** button is pressed and remain locked until the button is pressed again.

**AEL AE/AF-LOCK BUTTON**(default: **AE LOCK ONLY**)

Choose the role played by the **AFL/AEL** button (📖 49).

**AF CORRECTED AF FRAME**(default: **OFF**)

If **ON** is selected, a second focus frame for focus distances of about 50 cm (1.6 ft.) will be added to the display in the optical viewfinder. The focus frame for the current focus distance is displayed in green when the shutter button is pressed halfway.

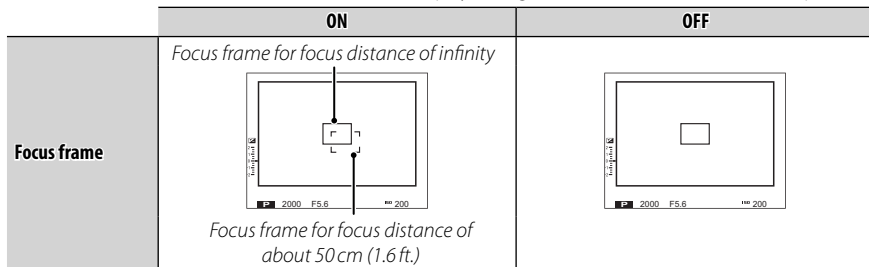

**FLASH**(default: **±0**)

Adjust flash brightness. Choose from values between  $+2/3$ EV and  $-2/3$ EV. Note that the desired results may not be achieved depending on shooting conditions and the distance to the subject.

**RED EYE REMOVAL**(default: **OFF**)

Choose **ON** to remove red-eye effects caused by the flash.

- ◆ Red-eye reduction is performed only when a face is detected.
- ◆ Red-eye removal is not available with RAW images.

**SAVE ORG IMAGE**(default: **OFF**)

Choose **ON** to save unprocessed copies of pictures taken using **RED EYE REMOVAL**.

### **Shooting Menu Options (Movie Mode)**

The following options are available in movie mode (📖 32).

#### **MOVIE MODE**

(default:  **1920×1080 (30fps)**)

Select a frame rate for movie recording. Choose from rates of 30 and 60 fps; frame size is fixed at 1920 × 1080 (Full HD).

#### **FILM SIMULATION**

(default:  **PROVIA/STANDARD**)

Simulate the effects of different types of film (📖 55).

#### **MIC LEVEL ADJUSTMENT**

(default: **3**)

Adjust the microphone recording level.

#### **DISP. CUSTOM SETTING**

Choose the items displayed in the viewfinder and LCD monitor (📖 75).

#### **WIDE CONVERSION LENS**

(default: **OFF**)

Select **ON** when using an optional wide conversion lens (📖 108).

---

## Using the Menus: Playback Mode

To display the playback menu, press **MENU/OK** in playback mode. Highlight items and press the command dial right to view options, then highlight an option and press **MENU/OK**. Press **DISP/BACK** to exit when settings are complete.

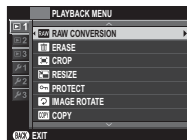

### Playback Menu Options

#### **RAW** RAW CONVERSION

Create JPEG copies of RAW pictures (📖 64).

#### **ERASE**

Delete all or selected pictures (📖 28).

#### **CROP**

Create a cropped copy of the current picture.

- 1 Display the desired picture.
  - 2 Select **CROP** in the playback menu.
  - 3 Use the **Q** and **Q** buttons to zoom in and out and press the command dial up, down, left, or right to scroll the picture until the desired portion is displayed.
  - 4 Press **MENU/OK** to display a confirmation dialog.
  - 5 Press **MENU/OK** again to save the cropped copy to a separate file.
- 🔍 Larger crops produce larger copies; all copies have an aspect ratio of 3:2. If the size of the final copy will be **640**, **OK** will be displayed in yellow.

## RESIZE

Create a cropped copy of the current picture.

- 1 Display the desired picture.
- 2 Select  **RESIZE** in the playback menu.
- 3 Highlight a size and press **MENU/OK** to display a confirmation dialog.
- 4 Press **MENU/OK** again to save the resized copy to a separate file.

◆ The sizes available vary with the size of the original image.

## PROTECT

Protect pictures from accidental deletion. Highlight one of the following options and press **MENU/OK**.

- **FRAME**: Protect selected pictures. Press the command dial left or right to view pictures and press **MENU/OK** to select or deselect. Press **DISP/BACK** when the operation is complete.
- **SET ALL**: Protect all pictures.
- **RESET ALL**: Remove protection from all pictures.

ⓘ Protected pictures will be deleted when the memory card is formatted ( 92).

---



**IMAGE ROTATE**

Rotate pictures.

- 1 Display the desired picture.
  - 2 Select **IMAGE ROTATE** in the playback menu.
  - 3 Press the command dial down to rotate the picture 90° clockwise, up to rotate it 90° counterclockwise.
  - 4 Press **MENU/OK**. The picture automatically be displayed in the selected orientation whenever it is played back on the camera.
- ◆ Protected pictures can not be rotated. Remove protection before rotating pictures.
  - ◆ The camera may not be able to rotate pictures created with other devices. Pictures rotated on the camera will not be rotated when viewed on a computer or on other cameras.
  - ◆ Pictures taken with **SCREEN SET-UP > AUTOROTATE PB** are automatically displayed in the correct orientation during playback (100).

**COPY**

Copy pictures from internal memory to a memory card.

- 1 Select **COPY** in the playback menu.
  - 2 Highlight one of the following options and press the command dial right:
    - **INTERNAL MEMORY → SD CARD**: Copy pictures from internal memory to a memory card.
    - **SD CARD → INTERNAL MEMORY**: Copy pictures from a memory card to internal memory.
  - 3 Highlight one of the following options and press **MENU/OK**:
    - **FRAME**: Copy selected pictures. Press the command dial left or right to view pictures and press **MENU/OK** to copy the current picture.
    - **ALL FRAMES**: Copy all pictures.
- ◆ Copying ends when the destination is full.
  - ◆ DPOF print information is not copied (101).







 **RED EYE REMOVAL**

Remove red-eye from portraits. The camera will analyze the image; if red-eye is detected, the image will be processed to create a copy with reduced red-eye.

**1** Display the desired picture.



**2** Select  **RED EYE REMOVAL** in the playback menu.

**3** Press **MENU/OK**.

-  Red eye may not be removed if the camera is unable to detect a face or the face is in profile. Results may differ depending on the scene. Red eye can not be removed from pictures that have already been processed using red-eye removal or pictures created with other devices.
-  The amount of time needed to process the image varies with the number of faces detected.
-  Copies created with  **RED EYE REMOVAL** are indicated by a  icon during playback.
-  Red eye removal can not be performed on RAW images.

 **SLIDE SHOW**

View pictures in an automated slide show. Choose the type of show and press **MENU/OK** to start. Press **DISP/BACK** at any time during the show to view on-screen help. The show can be ended at any time by pressing **MENU/OK**.

Option	Description
<b>NORMAL</b>	Press the command dial left or right to go back or skip ahead one frame. Select <b>FADE-IN</b> for fade transitions between frames.
<b>FADE-IN</b>	
<b>NORMAL</b> 	As above, except that camera automatically zooms in on faces.
<b>FADE-IN</b> 	
<b>MULTIPLE</b>	Display several pictures at once.

-  The camera will not turn off automatically while a slide show is in progress.

**PHOTOBOOK ASSIST**

Create books from your favorite photos (📖 67).

**MARK FOR UPLOAD TO**

Select pictures for upload to YouTube, Facebook or MyFinePix.com using MyFinePix Studio (Windows only).

- 1 Highlight an option and press **MENU/OK**. Select **YouTube** to choose movies for upload to YouTube, **FACEBOOK** to choose photos and movies for upload to Facebook, or **MyFinePix.com** to choose photos for upload to MyFinePix.com.
  - 2 Press the command dial left or right to display pictures and press **MENU/OK** to select or deselect. Press **DISP/BACK** to exit when all the desired pictures are selected.
- ❖ Only movies can be selected for upload to YouTube.
  - ❖ Only photos can be selected for upload to MyFinePix.com.
  - ❖ During playback, selected pictures are indicated by 📺 **YouTube**, 📘 **FACEBOOK** or 🌐 **MyFinepix.com** icons.
  - ❖ Choose **RESET ALL** to deselect all pictures. If the number of pictures affected is very large, some time may be required to complete the operation. Press **DISP/BACK** to exit before the operation is complete.

**Uploading Pictures (Windows Only)**

Selected pictures can be uploaded using the **YouTube/Facebook/MyFinePix.com Upload** option in MyFinePix Studio. For information on installing MyFinePix Studio and connecting the camera to a computer, see "Viewing Pictures on a Computer" (📖 93).

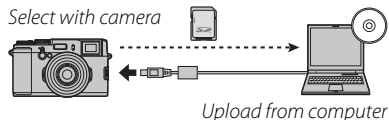
**IMAGE SEARCH**

Search for pictures (📖 66).

### PRINT ORDER (DPOF)

Select pictures for printing on DPOF- and PictBridge-compatible devices ( 101).

### DISP ASPECT

Choose how **H**igh **D**efinition (HD) devices display pictures with an aspect ratio of 3:2 (this option is available only when an HDMI cable is connected). Select 16:9 to display the image so that it fills the screen with its top and bottom cropped out, 3:2 to display the entire image with black bands at either side.

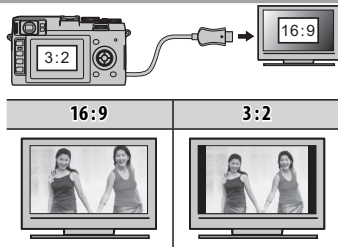

### PLAYBACK VOLUME

Control the volume for movie playback.

(default: 7)

# The Setup Menu

## Using the Setup Menu

### 1 Display the setup menu.

1.1 Press **MENU/OK** to display the menu for the current mode.



1.2 Press the command dial left to highlight the tab for the current menu.



1.3 Press the command dial down to highlight .

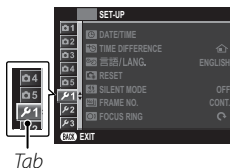

1.4 Press the command dial right to place the cursor in the setup menu.



### 2 Adjust settings.

Highlight items and press the command dial right to view options, then highlight an option and press **MENU/OK**. Press **DISP/BACK** to exit when settings are complete.

## **Setup Menu Options**

### **DATE/TIME**





Set the camera clock (🗨 17).

### **TIME DIFFERENCE**

(default: )

Switch the camera clock instantly from your home time zone to the local time at your destination when traveling. To specify the difference between local time and your home time zone:





- 1 Highlight  **LOCAL** and press **MENU/OK**.
- 2 Use the command dial to choose the time difference between local time and your home time zone. Press **MENU/OK** when settings are complete.

To set the camera clock to local time, highlight  **LOCAL** and press **MENU/OK**. To set the clock to the time in your home time zone, select  **HOME**. If  **LOCAL** is selected,  will be displayed for three seconds when the camera is turned on.

### **言語/LANG.**

Choose a language (🗨 17).

### **RESET**

Reset shooting or setup menu options to default values.  **DATE/TIME**,  **TIME DIFFERENCE**,  **SCREEN SETUP** > **BACKGROUND COLOR**, and  **SHUTTER COUNT** are not affected.

- 1 Highlight the desired option and press the command dial right.
- 2 A confirmation dialog will be displayed; highlight **OK** and press **MENU/OK**.

### **SILENT MODE**

(default: **OFF**)

Select **ON** to disable the speaker, flash, and illuminator in situations in which camera sounds or lights may be unwelcome (note that silent mode can not be enabled or disabled during movie playback). Silent mode can also be turned on or off using the **DISP/BACK** button as described on page 5.

**FRAME NO.**(default: **CONTINUOUS**)

New pictures are stored in image files named using a four-digit file number assigned by adding one to the last file number used. The file number is displayed during playback as shown at right. **FRAME NO.** controls whether file numbering is reset to 0001 when a new memory card is inserted or the current memory card is formatted.

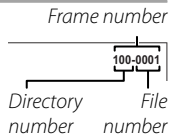

Option	Description
<b>CONTINUOUS</b>	Numbering continues from the last file number used or the first available file number, whichever is higher. Choose this option to reduce the number of pictures with duplicate file names.
<b>RENEW</b>	Numbering is reset to 0001 after formatting or when a new memory card is inserted.

- ◆ If the frame number reaches 999-9999, the shutter release will be disabled (📖 116).
- ◆ Selecting **RESET** (📖 88) sets **FRAME NO.** to **CONTINUOUS** but does not reset the file number.
- ◆ Frame numbers for pictures taken with other cameras may differ.

**FOCUS RING**(default: **CW**)

Choose the direction in which the focus ring is rotated to increase the focus distance.

**FOCUS CHECK**(default: **OFF**)



If **ON** is selected, view through the lens will automatically be magnified in the display to assist focus when the focus ring is rotated in manual focus mode (📖 47).

**FOCUS SCALE UNITS**(default: **METERS**)

Choose the units used for the focus distance indicator (📖 46).

 **SOUND SET-UP**

Adjust sound settings.

Option	Description
<b>OPERATION VOL.</b>	Adjust the volume of the sounds produced when camera controls are operated. Choose  <b>OFF</b> (mute) to disable control sounds.
<b>SHUTTER VOLUME</b>	Adjust the volume of the sounds produced when the shutter is released. Choose  <b>OFF</b> (mute) to disable the shutter sound.
<b>SHUTTER SOUND</b>	Choose the sound made by the shutter.

 **SCREEN SET-UP**

Adjust display settings.

Option	Description
<b>IMAGE DISP.</b>	<p>Choose how long images are displayed after shooting. Colors may differ slightly from those in the final image and “noise” mottling may be visible at high sensitivities.</p> <ul style="list-style-type: none"> <li>• <b>CONTINUOUS</b>: Pictures are displayed until the <b>MENU/OK</b> button is pressed or the shutter button is pressed halfway. To zoom in on the active focus point, press the center of the command control; press again to cancel zoom.</li> <li>• <b>1.5 SEC, 0.5 SEC</b>: Pictures are displayed for 1.5 seconds (<b>1.5 SEC</b>) or 0.5 seconds (<b>0.5 SEC</b>) or until the shutter button is pressed halfway.</li> <li>• <b>OFF</b>: Pictures are not displayed after shooting.</li> </ul>
<b>EVF/LCD BRIGHTNESS</b>	Control the brightness of the display.
<b>MONITOR SUNLIGHT MODE</b>	Select <b>ON</b> to make the display in the monitor easier to read in bright light (  119).
<b>AUTOROTATE PB</b>	Choose <b>ON</b> to automatically rotate “tall” (portrait-orientation) pictures during playback.
<b>BACKGROUND COLOR</b>	Choose a color scheme.



**⚡ POWER MANAGEMENT**

Adjust power management settings.

Option	Description
<b>AUTO POWER OFF</b>	Choose the length of time before the camera turns off automatically when no operations are performed. Shorter times reduce the drain on the battery; if <b>OFF</b> is selected, the camera must be turned off manually. Note that in some situations the camera turns off automatically even when <b>OFF</b> is selected.
<b>HIGH PERFORMANCE</b>	Select <b>ON</b> for faster focus and to reduce the time needed to restart the camera after it has been turned off (16).

**📷 OVF POWER SAVE MODE**(default: **OFF**)

Select **ON** to reduce power consumption and increase the number of pictures that can be taken on a single charge when pictures are framed in the optical viewfinder.

- When **ON** is selected, the histogram in the optical viewfinder is shown only by a frame.

**📷 SHUTTER COUNT**

View the approximate number of times the shutter has been released.

- The count is also incremented each time the camera is turned off, playback mode is selected, or the optical viewfinder is activated.

**🎨 COLOR SPACE**(default: **sRGB**)

Choose the gamut of colors available for color reproduction.

Option	Description
<b>sRGB</b>	Recommended in most situations.
<b>Adobe RGB</b>	For commercial printing.





**Eye-Fi TRANSFER**(default: **ON**)

The camera can be used with third-party Eye-Fi cards; for more information see the manual provided with the card or contact the manufacturer.

Option	Description
<b>ON</b>	Pictures taken with the camera are uploaded to a pre-selected destination.
<b>OFF</b>	Pictures are not uploaded automatically.

- ⓘ Observe local regulations regarding the use of wireless devices when using Eye-Fi cards. Select **OFF** in aircraft, hospitals, and other locations where the use of wireless devices is prohibited.

**The Eye-Fi Icon**

Icon	Status
	Standby/no connection
 (blinks)	Connecting
  (animated)	Upload in progress
 (red)	Error

**FORMAT**

Select **OK** to format the memory card.

- ⓘ All data—including protected pictures—will be deleted from the memory card. Be sure important files have been copied to a computer or other storage device.
- ⓘ Do not open the battery-chamber cover during formatting.

## Viewing Pictures on a Computer

The supplied software can be used to copy pictures to a computer, where they can be stored, viewed, organized, and printed. Before proceeding, install the software as described below. *Do not connect the camera to the computer until installation is complete.*

### **Windows: Installing MyFinePix Studio**

1 Confirm that the computer meets the following system requirements:

	Windows 8 / Windows 7 (Service Pack 1) / Windows Vista (Service Pack 2) <sup>1</sup>	Windows XP (Service Pack 3) <sup>1</sup>
<b>CPU</b>	3 GHz Pentium 4 or better (2.4 GHz Core 2 Duo or better <sup>2</sup> )	2 GHz Pentium 4 or better (2.4 GHz Core 2 Duo or better <sup>2</sup> )
<b>RAM</b>	1 GB or more	512 MB or more (1 GB or more <sup>2</sup> )
<b>Free disk space</b>	2 GB or more	
<b>GPU</b>	Supports DirectX 9 or later (recommended)	Supports DirectX 7 or later (required; performance not guaranteed with other GPUs)
<b>Video</b>	1024×768 pixels or more with 24-bit color or better	
<b>Other</b>	<ul style="list-style-type: none"><li>• Built-in USB port recommended. Operation is not guaranteed with other USB ports.</li><li>• .NET Framework 3.5 Service Pack 1 required when uploading images or using Map Viewer.</li><li>• Internet connection (broadband recommended) required to install .NET Framework (if necessary), to use auto update feature, and when performing such tasks as sharing pictures on-line or via e-mail.</li></ul>	

<sup>1</sup> Other versions of Windows are not supported. Only pre-installed operating systems are supported; operation is not guaranteed on home-built computers or computers that have been upgraded from earlier versions of Windows.

<sup>2</sup> Recommended when displaying HD movies.

2 Start the computer. Log in to an account with administrator privileges before proceeding.

**3** Exit any applications that may be running and insert the installer CD in a CD-ROM drive.

**Windows 8/Windows 7/Windows Vista**

If an AutoPlay dialog is displayed, click **SETUP.EXE**. A “User Account Control” dialog will then be displayed; click **Yes** (Windows 8/Windows 7) or **Allow** (Windows Vista).

The installer will start automatically; click **Install MyFinePix Studio** and follow the on-screen instructions to install MyFinePix Studio and RAW FILE CONVERTER.

**If the Installer Does Not Start Automatically (Windows 7/Windows Vista)**

If the installer does not start automatically, select **Computer** or **My Computer** from the **Start** menu, then double-click the **FINEPIX** CD icon to open the FINEPIX CD window and double-click **setup** or **SETUP.EXE**.

**If the Installer Does Not Start Automatically (Windows 8)**

- 1** Select **Desktop** on the Start screen.
- 2** Select **File Explorer** on the taskbar.
- 3** Select **Computer** in the navigation pane.
- 4** Double-click the drive icon inserting the **FINEPIX** CD and follow the on-screen instructions to install.

**4** If prompted to install Windows Media Player or DirectX, follow the on-screen instructions to complete installation.

**5** Remove the installer CD from the CD-ROM drive when installation is complete. Store the installer CD in a dry location out of direct sunlight in case you need to re-install the software.

Installation is now complete. Proceed to “Connecting the Camera” (📖 97).

**Macintosh: Installing RAW FILE CONVERTER**

RAW FILE CONVERTER is used to view RAW images on your computer.

- 1 Confirm that the computer meets the following system requirements:

<b>CPU</b>	Intel (Core 2 Duo or better)
<b>OS</b>	Pre-installed copies of Mac OS X version 10.6–10.8 (visit <a href="http://www.fujifilm.com/support/digital_cameras/compatibility/">http://www.fujifilm.com/support/digital_cameras/compatibility/</a> for more information).
<b>RAM</b>	1 GB or more
<b>Free disk space</b>	A minimum of 200 MB required for installation with 400 MB available when RAW FILE CONVERTER is running
<b>Video</b>	1024 × 768 pixels or more with 24-bit color or better

- 2 After starting the computer and quitting any applications that may be running, insert the installer CD in a CD-ROM drive and double-click **SILKYRFXEXInstaller**.
- 3 Enter an administrator name and password when prompted and click **OK**, then follow the on-screen instructions to install. Click **Exit** to quit the installer when installation is complete.
- 4 Remove the installer CD from the CD-ROM drive. Note that you may be unable to remove the CD if Safari is running; if necessary, quit Safari before removing the CD. Store the installer CD in a dry location out of direct sunlight in case you need to re-install the software.

Installation is now complete. Proceed to “Connecting the Camera” (📖 97).

**Importing Pictures or Movies to Mac (Macintosh)**

Use a standard application in Mac OS such as Image Capture to import pictures or movies to Mac.

## **Connecting the Camera**

- 1 If the pictures you wish to copy are stored on a memory card, insert the card into the camera (📖 12).
  - ◆ Windows users may require the Windows CD when starting the software for the first time.
  - ⓘ Loss of power during transfer could result in loss of data or damage to internal memory or the memory card. Charge the battery before connecting the camera.
- 2 Turn the camera off and connect the supplied USB cable as shown, making sure the connectors are fully inserted. Connect the camera directly to the computer; do not use a USB hub or keyboard.
- 3 Turn the camera on and follow the on-screen instructions to copy pictures to the computer. To exit without copying pictures, click **Cancel**.

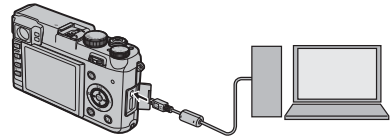

For more information on using the supplied software, start the application and select the appropriate option from the **Help** menu.

- ❗ If a memory card containing a large number of images is inserted, there may be a delay before the software starts and you may be unable to import or save images. Use a memory card reader to transfer pictures.
- ❗ Make sure that the computer does not display a message stating that copying is in progress and that the indicator lamp is out before turning the camera off or disconnecting the USB cable (if the number of images copied is very large, the indicator lamp may remain lit after the message has cleared from the computer display). Failure to observe this precaution could result in loss of data or damage to internal memory or the memory card.
- ❗ Disconnect the camera before inserting or removing memory cards.
- ❗ In some cases, it may not be possible to access pictures saved to a network server using the supplied software in the same way as on a standalone computer.
- ❗ The user bears all applicable fees charged by the phone company or Internet service provider when using services that require an Internet connection.

### **Disconnecting the Camera**

After confirming that the indicator lamp is out, turn the camera off and disconnect the USB cable.

### **Uninstalling the Supplied Software**

Only uninstall the supplied software when it is no longer required or before beginning reinstallation. After quitting the software and disconnecting the camera, drag “RAW FILE CONVERTER EX powered by SILKYPIX” from “Applications” into the Trash and select **Empty Trash** in the **Finder** menu (Macintosh), or open the control panel and use “Programs and Features” (Windows 8/Windows 7/Windows Vista) or “Add or Remove Programs” (Windows XP) to uninstall MyFinePix Studio. Under Windows, one or more confirmation dialogs may be displayed; read the contents carefully before clicking **OK**.



## Printing Pictures via USB

If the printer supports PictBridge, the camera can be connected directly to the printer and pictures can be printed without first being copied to a computer. Note that depending on the printer, not all the functions described below may be supported.



### Connecting the Camera

- 1 Connect the supplied USB cable as shown and turn the printer on.

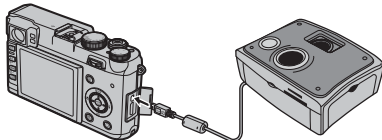

- 2 Turn the camera on.  **USB** will be displayed in the monitor, followed by the PictBridge display shown below at right.

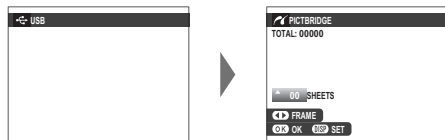

- ◆ Pictures can be printed from internal memory or a memory card that has been formatted in the camera.
- ◆ Page size, print quality, and border selections are made using the printer.

### Printing Selected Pictures

- 1 Press the command dial left or right to display a picture you wish to print. 

◆ To print one copy of the current picture, proceed directly to Step 3.

- 2 Press the command dial up or down to choose the number of copies (up to 99). Repeat steps 1–2 to select additional pictures. 

- 3 Press **MENU/OK** to display a confirmation dialog. 

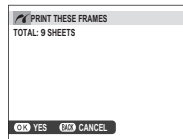



- 4 Press **MENU/OK** to start printing. 

### **Printing the Date of Recording**

To print the date of recording on pictures, press **DISP/BACK** in the PictBridge display and select **PRINT WITH DATE**  (to print pictures without the date of recording, select **PRINT WITHOUT DATE**). To ensure that the date is correct, set the camera clock before taking pictures. Some printers do not support date printing. See the printer manual for details.

### **Printing the DPOF Print Order**

To print the print order created with  **PRINT ORDER (DPOF)** in the playback menu ( 86):

- 1 In the PictBridge display, press **DISP/BACK** to open the PictBridge menu.
- 2 Press the command dial up or down to highlight  **PRINT DPOF**.

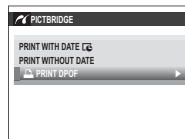

- 3 Press **MENU/OK** to display a confirmation dialog.

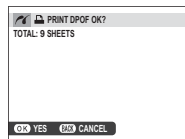

- 4 Press **MENU/OK** to start printing.



### **During Printing**

The message shown at right is displayed during printing. Press **DISP/BACK** to cancel before all pictures are printed (depending on the printer, printing may end before the current picture has printed).

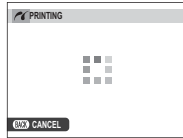

If printing is interrupted, turn the camera off and then on again.

### **Disconnecting the Camera**

Confirm that the above message is not displayed and turn the camera off. Disconnect the USB cable.

### **Creating a DPOF Print Order**

The  **PRINT ORDER (DPOF)** option in the playback menu can be used to create a digital “print order” for PictBridge-compatible printers or devices that support DPOF.

### **DPOF**

DPOF (**D**igital **P**rint **O**rder **F**ormat) is standard that allows pictures to be printed from “print orders” stored on the memory card.  The information in the order includes the pictures to be printed and the number of copies of each picture.

■ **WITH DATE**  / **WITHOUT DATE**

To modify the DPOF print order, select **PRINT ORDER (DPOF)** in the playback menu and press the command dial up or down to highlight **WITH DATE**  or **WITHOUT DATE**.



**WITH DATE** : Print date of recording on pictures.

**WITHOUT DATE**: Print pictures without date.

Press **MENU/OK** and follow the steps below.

- 1 Press the command dial left or right to display a picture you wish to include in or remove from the print order.



- 2 Press the command dial up or down to choose the number of copies (up to 99). To remove a picture from the order, press the command dial down until the number of copies is 0.

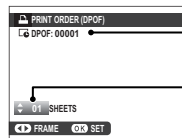

Total number of prints

Number of copies

- 3 Repeat steps 1–2 to complete the print order. Press **MENU/OK** to save the print order when settings are complete, or **DISP/BACK** to exit without changing the print order.



- 4 The total number of prints is displayed in the monitor. Press **MENU/OK** to exit.



The pictures in the current print order are indicated by a  icon during playback.



## ■ RESET ALL

To cancel the current print order, select **RESET ALL** for  **PRINT ORDER (DPOF)**. The confirmation shown at right will be displayed; press **MENU/OK** to remove all pictures from the order.

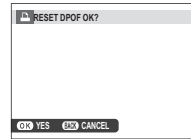

- ◆ Print orders can contain a maximum of 999 pictures.
- ◆ If a memory card is inserted containing a print order created by another camera, the message shown at right will be displayed. Pressing **MENU/OK** cancels the print order; a new print order must be created as described above.

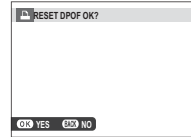

## Viewing Pictures on TV

To show pictures to a group, connect the camera to a TV using an HDMI cable (available separately from third-party suppliers; note that the TV can only be used for playback, not shooting).

- 1 Turn the camera off.
- 2 Connect the cable as shown below.

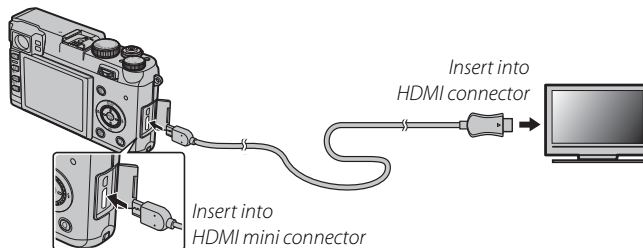

- ◆ Be sure the connectors are fully inserted.
- 3 Tune the television to the HDMI input channel. See the documentation supplied with the television for details.
  - 4 Turn the camera on and press  button. The camera monitor turns off and pictures and movies are played back on the TV. Note that the camera volume controls have no effect on sounds played on the TV; use the television volume controls to adjust the volume.
    - ◆ The USB cable can not be used while an HDMI cable is connected.
    - ◆ Some televisions may briefly display a black screen when movie playback begins.

# Technical Notes

## Optional Accessories

The camera supports a wide range of accessories from FUJIFILM and other manufacturers.

### Accessories from FUJIFILM

The following optional accessories are available from FUJIFILM. For the latest information on the accessories available in your region, check with your local FUJIFILM representative or visit [http://www.fujifilm.com/products/digital\\_cameras/index.html](http://www.fujifilm.com/products/digital_cameras/index.html).

#### Rechargeable Li-ion batteries

**NP-95:** Additional large-capacity NP-95 rechargeable batteries can be purchased as required.



#### Battery chargers

**BC-65N:** Replacement battery chargers can be purchased as required. At +20°C/+68°F, the BC-65N charges an NP-95 in about 210 minutes.

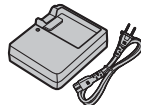

#### Shoe-mounted flash units

**EF-20:** This clip-on flash unit (powered by two AA batteries) has a Guide Number of 20/65 (ISO 100, m/ft.) and supports TTL flash control. The flash head can be rotated upwards 90° for bounce lighting.



**EF-42:** This clip-on flash unit (powered by four AA batteries) has a Guide Number of 42/137 (ISO 100, m/ft.) and supports TTL flash control and auto power zoom in the range 24–105 mm (35 mm format equivalent). The flash head can be rotated 90° up, 180° left, or 120° right for bounce lighting.



**EF-X20:** This clip-on flash unit has a Guide Number of 20/65 (ISO 100, m/ft.).



### Leather cases

**LC-X100S:** This leather case, exclusively for use with the X100S/X100, combines practicality with the luxury of leather and comes with a shoulder strap made of the same material. Pictures can be taken and batteries and memory cards inserted or removed with the camera still in its case.

### Adapter rings

**AR-X100:** An aluminum adapter ring exclusively for use with the X100S/X100. It is used when attaching the LH-X100 lens hood or  $\phi$ 49 mm filters available from third-party suppliers.



### Lens hoods

**LH-X100:** This aluminum lens hood, exclusively for use with the X100S/X100, comes with an AR-X100 adapter ring made of the same material. The adapter ring is required when attaching the hood.



### Protector filters

**PRF-49S:** A protective filter exclusively for use with the X100S/X100. Requires AR-X100 adapter ring.



### Wide conversion lenses

**WCL-X100:** A conversion lens that increases picture angle.



### Stereo microphones

**MIC-ST1:** An external microphone for movie recording.





**Attaching Adapter Rings**

**1** Remove the front ring.

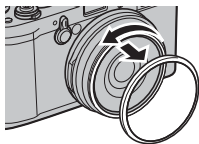

◆ If you have trouble removing the front ring, grip the entire ring and rotate it as shown.

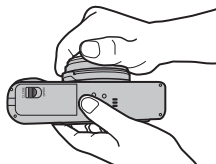

**2** Attach the adapter ring as shown, with the projections facing out.

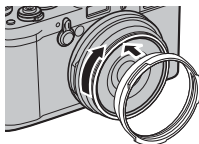

- ① Keep the front ring and lens cap in a safe place when not in use.
- ① Attach the adapter ring before attaching LH-X100 lens hood, PRF-49S protector filter, or third-party filters.

**Attaching Lens Hoods**

Attach the adapter ring before attaching the lens hood.

◆ Align the indentations and rotate as shown.

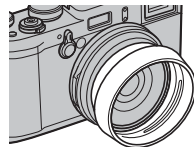
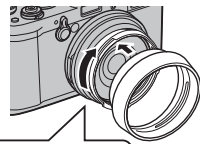
**Attaching Protector Filters**

Attach the adapter ring before attaching the filter.

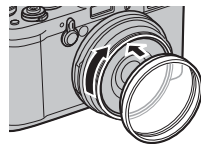



### **The WCL-X100 Wide Conversion Lens**

A  **WIDE CONVERSION LENS** option has been added to the shooting menu for use with the optional WCL-X100 wide conversion lens. Select **ON** when using the WCL-X100.

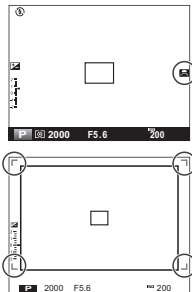
- ◆ A  icon is displayed when **ON** is selected.



- ◆ Because the optical viewfinder does not cover the full field of view of the conversion lens, the bright frame is replaced by brackets showing approximately 80% of the field of view. For accurate framing, compose pictures using the electronic viewfinder or LCD monitor.
- ◆ The WCL-X100 may cast shadows in pictures taken with the built-in flash. Use an optional external flash approved for the X100.
- ◆  **WIDE CONVERSION LENS** can be assigned to the **Fn** button.
- ◆ Be sure to select **OFF** for  **WIDE CONVERSION LENS** when the WCL-X100 is not in use.

### ■ Attaching the WCL-X100

- 1 Remove the front ring.

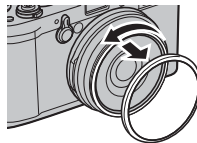

- ◆ If you have trouble removing the front ring, grip the entire ring and rotate it as shown.

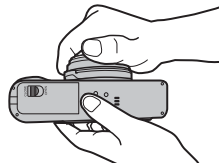

- 2 Attach the wide conversion lens.

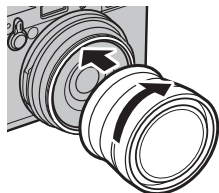

- ① Keep the front ring and lens cap in a safe place when not in use.

## Connecting the Camera to Other Devices

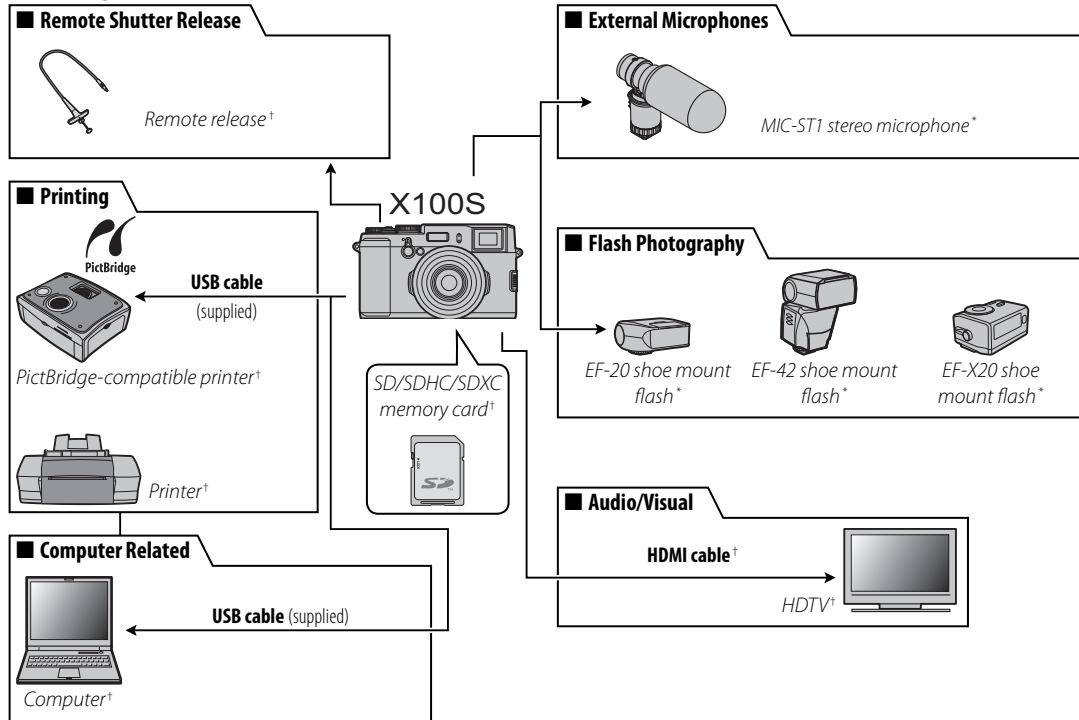

\* Available separately from FUJIFILM.

† Available separately from third-party suppliers.

## **Caring for the Camera**

---

To ensure continued enjoyment of the product, observe the following precautions.

### **Storage and Use**

If the camera will not be used for an extended period, remove the battery and memory card. Do not store or use the camera in locations that are:

- exposed to rain, steam, or smoke
- very humid or extremely dusty
- exposed to direct sunlight or very high temperatures, such as in a closed vehicle on a sunny day
- extremely cold
- subject to strong vibration
- exposed to strong magnetic fields, such as near a broadcasting antenna, power line, radar emitter, motor, transformer, or magnet
- in contact with volatile chemicals such as pesticides
- next to rubber or vinyl products

### **■ Water and Sand**

Exposure to water and sand can also damage the camera and its internal circuitry and mechanisms. When using the camera at the beach or seaside, avoid exposing the camera to water or sand. Do not place the camera on a wet surface.

### **■ Condensation**

Sudden increases in temperature, such as occur when entering a heated building on a cold day, can cause condensation inside the camera. If this occurs, turn the camera off and wait an hour before turning it on again. If condensation forms on the memory card, remove the card and wait for the condensation to dissipate.

### **Traveling**

Keep the camera in your carry-on baggage. Checked baggage may suffer violent shocks that could damage the camera.

## Problems and Solutions

### ■ Power and Battery

Problem	Solution
The camera does not turn on.	<ul style="list-style-type: none"><li>• <b>The battery is exhausted:</b> Charge the battery (📖 11) or insert a fully-charged spare battery (📖 12).</li><li>• <b>The battery is inserted incorrectly:</b> Reinsert in the correct orientation (📖 12).</li><li>• <b>The battery-chamber cover is not latched:</b> Latch the battery-chamber cover (📖 13).</li></ul>
The monitor does not turn on.	The monitor may not turn on if the camera is turned off and then on again very quickly. Press the shutter button halfway to activate the monitor.
The battery runs down quickly.	<ul style="list-style-type: none"><li>• <b>The battery is cold:</b> Warm the battery by placing it in a pocket or other warm place and reinsert it in the camera immediately before taking a picture.</li><li>• <b>There is dirt on the battery terminals:</b> Clean the terminals with a soft, dry cloth.</li><li>• <b>C is selected for focus mode:</b> Select a different focus mode (📖 46).</li><li>• <b>The battery has been charged many times:</b> The battery has reached the end of its charging life. Purchase a new battery.</li></ul>
The camera turns off suddenly.	<b>The battery is exhausted:</b> Charge the battery (📖 11) or insert a fully-charged spare battery (📖 12).
Charging does not start.	Reinsert the battery in the correct orientation and make sure that the charger is plugged in (📖 11).
Charging is slow.	Charge the battery at room temperature (📖 iv).
The charging lamp blinks, but the battery does not charge.	<ul style="list-style-type: none"><li>• <b>There is dirt on the battery terminals:</b> Clean the terminals with a soft, dry cloth.</li><li>• <b>The battery has been charged many times:</b> The battery has reached the end of its charging life. Purchase a new battery. If the battery still fails to charge, contact your FUJIFILM dealer.</li></ul>

### ■ Menus and Displays

Problem	Solution
Display is not in English.	Select <b>ENGLISH</b> for  言語/LANG. (📖 88).

## ■ Shooting

Problem	Solution
No picture is taken when the shutter button is pressed.	<ul style="list-style-type: none"> <li>• <b>Memory is full:</b> Insert a new memory card or delete pictures (📖 12, 28).</li> <li>• <b>Memory is not formatted:</b> Format the memory card or internal memory (📖 92).</li> <li>• <b>There is dirt on the memory card contacts:</b> Clean the contacts with a soft, dry cloth.</li> <li>• <b>The memory card is damaged:</b> Insert a new memory card (📖 12).</li> <li>• <b>The battery is exhausted:</b> Charge the battery (📖 11) or insert a fully-charged spare battery (📖 12).</li> <li>• <b>The camera has turned off automatically:</b> Turn the camera on (📖 16).</li> <li>• <b>The indicator lamp was orange when you attempted to record a panorama:</b> Wait until the indicator lamps turns off (📖 3).</li> </ul>
Mottling (“noise”) appears in the monitor or electronic viewfinder when the shutter button is pressed halfway.	Gain is increased to aid composition when the subject is poorly lit and aperture is stopped down, which may result in noticeable mottling when images are previewed in the displays. Images taken with the camera are unaffected.
The display goes dark after shooting.	The display may darken while the flash charges. Wait for the flash to charge.
The camera does not focus.	<ul style="list-style-type: none"> <li>• <b>The subject is close to the camera:</b> Select macro mode (📖 31).</li> <li>• <b>The subject is far away from the camera:</b> Cancel macro mode (📖 31).</li> <li>• <b>The subject is not suited to autofocus:</b> Use focus lock (📖 49) or manual focus (📖 46).</li> </ul>
The flash does not fire.	<ul style="list-style-type: none"> <li>• <b>The flash can not be used at current settings:</b> See the list of the settings that can be used with the flash (📖 127).</li> <li>• <b>The flash is off (🔇):</b> Choose a different flash mode (📖 29).</li> <li>• <b>The battery is exhausted:</b> Charge the battery (📖 11) or insert a fully-charged spare battery (📖 12).</li> <li>• <b>The camera is in bracketing or continuous mode:</b> Select single frame mode (📖 56, 58).</li> <li>• <b>The camera is in silent mode:</b> Turn silent mode off (📖 5).</li> </ul>

Problem	Solution
Some flash modes are not available.	The camera is in silent mode. Turn silent mode off (📖 5).
The flash does not fully light the subject.	<ul style="list-style-type: none"> <li>• <b>The subject is not in range of the flash:</b> Position the subject in range of the flash (📖 121).</li> <li>• <b>The flash window is obstructed:</b> Hold the camera correctly (📖 23).</li> <li>• <b>Shutter speed is faster than <math>\frac{1}{2000}</math> s:</b> Choose a slower shutter speed (📖 30, 37, 39).</li> </ul>
Pictures are blurred.	<ul style="list-style-type: none"> <li>• <b>The lens is dirty:</b> Clean the lens (📖 ix).</li> <li>• <b>The lens is blocked:</b> Keep objects away from the lens.</li> <li>• <b>!AF is displayed during shooting and the focus frame is displayed in red:</b> Check focus before shooting (📖 24).</li> <li>• <b>!📷 is displayed during shooting:</b> Use the flash or mount the camera on a tripod (📖 29).</li> </ul>
Pictures are mottled.	<ul style="list-style-type: none"> <li>• <b>Shutter speed is slow and the ambient temperature is high:</b> This is normal and does not indicate a malfunction.</li> <li>• <b>The camera has been used continuously at high temperatures or a temperature warning is displayed:</b> Turn the camera off and wait for it to cool down.</li> </ul>

## ■ Playback

Problem	Solution
Pictures are grainy.	The pictures were taken with a different make or model of camera.
Playback zoom is unavailable.	The pictures were created using  RESIZE or with a different make or model of camera.
No sound in movie playback.	<ul style="list-style-type: none"> <li>• <b>Playback volume is too low:</b> Adjust playback volume (📖 86).</li> <li>• <b>The microphone was obstructed:</b> Hold the camera correctly during recording (📖 2, 32).</li> <li>• <b>The speaker is obstructed:</b> Hold the camera correctly during playback (📖 2, 33).</li> <li>• <b>The camera is in silent mode:</b> Turn silent mode off (📖 5).</li> </ul>
Selected pictures are not deleted.	Some of the pictures selected for deletion are protected. Remove protection using the device with which it was originally applied (📖 82).
File numbering is unexpectedly reset.	The battery-chamber cover was opened while the camera was on. Turn the camera off before opening the battery-chamber cover (📖 12, 16).





## ■ Connections/Miscellaneous

Problem	Solution
No picture or sound.	<ul style="list-style-type: none"> <li>• <b>The camera is not properly connected:</b> Connect the camera properly (📖 104). Note that once the camera is connected, pictures will be displayed on the TV instead of in the camera monitor.</li> <li>• <b>Input on the television is set to “TV”:</b> Set input to “HDMI”.</li> <li>• <b>The volume on the TV is too low:</b> Use the controls on the television to adjust the volume.</li> </ul>
The computer does not recognize the camera.	Be sure the camera and computer are correctly connected (📖 97).
Can not transfer RAW or JPEG files to computer.	Use the bundled software to transfer pictures (📖 93).
Pictures can not be printed.	<ul style="list-style-type: none"> <li>• <b>The camera is not properly connected:</b> Connect the camera correctly (📖 99).</li> <li>• <b>The printer is off:</b> Turn the printer on.</li> </ul>
Only one copy is printed/ the date is not printed.	The printer is not PictBridge compatible.
The camera is unresponsive.	<ul style="list-style-type: none"> <li>• <b>Temporary camera malfunction:</b> Remove and reinsert the battery (📖 12, 14).</li> <li>• <b>The battery is exhausted:</b> Charge the battery (📖 11) or insert a fully-charged spare battery (📖 12).</li> </ul>
The camera does not function as expected.	Remove and reinsert the battery (📖 12, 14). If the problem persists, contact your FUJIFILM dealer.
No sound.	Turn silent mode off (📖 5).



## Warning Messages and Displays

The following warnings appear in the display.

Warning	Description
 (red)	Low battery. Charge the battery (📖 11) or insert a fully-charged spare battery (📖 12).
 (blinks red)	Battery exhausted. Charge the battery (📖 11) or insert a fully-charged spare battery (📖 12).
	Slow shutter speed. Pictures may be blurred; use the flash or a tripod.
<b>!AF</b> (displayed in red with red focus frame)	The camera can not focus. Try one of the following solutions: <ul style="list-style-type: none"><li>• Use focus lock to focus on another subject at the same distance, then recompose the picture (📖 49).</li><li>• Use macro mode to focus when taking close-ups (📖 31).</li></ul>
Aperture or shutter speed displayed in red	The subject is too bright or too dark and the picture will be over- or under-exposed. Use the flash for additional lighting when taking photographs of poorly-lit subjects (📖 29).
<b>FOCUS ERROR</b>	
<b>TURN OFF THE CAMERA AND TURN ON AGAIN</b>	Camera malfunction. Turn the camera off and then on again. If the message persists, contact a FUJIFILM dealer.
<b>LENS CONTROL ERROR</b>	
<b>BUSY</b>	The memory card is incorrectly formatted. Use the camera to format the card (📖 92).
<b>CARD NOT INITIALIZED</b>	<ul style="list-style-type: none"><li>• <b>The memory card or internal memory is not formatted or the memory card has been formatted in a computer or other device:</b> Format the memory card or internal memory using the  <b>FORMAT</b> option in the camera setup menu (📖 92).</li><li>• <b>The memory card contacts require cleaning:</b> Clean the contacts with a soft, dry cloth. If the message is repeated, format the card (📖 92). If the message persists, replace the card.</li><li>• <b>Camera malfunction:</b> Contact a FUJIFILM dealer.</li></ul>
<b>PROTECTED CARD</b>	The memory card is locked. Unlock the card (📖 13).

Warning	Description
CARD ERROR	<ul style="list-style-type: none"> <li>• <b>The memory card is not formatted for use in the camera:</b> Format the card (📖 92).</li> <li>• <b>The memory card contacts require cleaning or the memory card is damaged:</b> Clean the contacts with a soft, dry cloth. If the message is repeated, format the card (📖 92). If the message persists, replace the card.</li> <li>• <b>Incompatible memory card:</b> Use a compatible card (📖 15).</li> <li>• <b>Camera malfunction:</b> Contact a FUJIFILM dealer.</li> </ul>
SD MEMORY FULL	The memory card or internal memory is full and pictures can not be recorded or copied. Delete pictures (📖 28) or insert a memory card with more free space (📖 12).
INTERNAL MEMORY FULL	
INTERNAL MEMORY IS FULL INSERT A NEW CARD	
NO CARD	No memory card inserted when <b>COPY</b> is selected. Insert a memory card.
WRITE ERROR	<ul style="list-style-type: none"> <li>• <b>Memory card error or connection error:</b> Reinsert the card or turn the camera off and then on again. If the message persists, contact a FUJIFILM dealer.</li> <li>• <b>Not enough memory remaining to record additional pictures:</b> Delete pictures (📖 28) or insert a memory card with more free space (📖 12).</li> <li>• <b>The memory card or internal memory is not formatted:</b> Format the memory card or internal memory (📖 92).</li> </ul>
READ ERROR	<ul style="list-style-type: none"> <li>• <b>The file is corrupt or was not created with the camera:</b> The file can not be viewed.</li> <li>• <b>The memory card contacts require cleaning:</b> Clean the contacts with a soft, dry cloth. If the message is repeated, format the card (📖 92). If the message persists, replace the card.</li> <li>• <b>Camera malfunction:</b> Contact a FUJIFILM dealer.</li> </ul>
FRAME NO. FULL	The camera has run out of frame numbers (current frame number is 999-9999). Format the memory card and select <b>RENEW</b> for <b>FRAME NO.</b> Take a picture to reset frame numbering to 100-0001, then select <b>CONTINUOUS</b> for <b>FRAME NO.</b> (📖 89).
PRESS AND HOLD THE DISP BUTTON TO DEACTIVATE SILENT MODE	An attempt was made to choose a flash mode or adjust the volume with the camera in silent mode. Exit silent mode before choosing a flash mode or adjusting the volume (📖 5).

Warning	Description
TOO MANY FRAMES	<ul style="list-style-type: none"> <li>• <b>A search has returned more than 30,000 results:</b> Choose a search that returns fewer results.</li> <li>• <b>More than 999 images are selected for deletion:</b> Choose fewer images.</li> </ul>
PROTECTED FRAME	An attempt was made to delete or rotate to a protected picture. Remove protection and try again (🗨 82).
CAN NOT CROP	The picture is damaged or was not created with the camera.
🗨 CANNOT EXECUTE	Red-eye removal can not be applied to pictures created with other devices.
🗨 CANNOT EXECUTE	Red-eye removal can not be applied to movies.
CAN NOT ROTATE	The selected picture can not be rotated.
🗨 CAN NOT ROTATE	Movies can not be rotated.
🗨 NO IMAGE	The source selected for <b>🗨 COPY</b> contains no images. Select a different source.
🗨 NO IMAGE	
DPOF FILE ERROR	The DPOF print order on the current memory card contains more than 999 images. Copy the pictures to a computer and create a new print order.
CAN NOT SET DPOF	The picture can not be printed using DPOF.
🗨 CAN NOT SET DPOF	Movies can not be printed using DPOF.
COMMUNICATION ERROR	A connection error occurred while pictures were being printed or copied to a computer or other device. Confirm that the device is turned on and that the USB cable is connected.
PRINTER ERROR	Printer out of paper or ink, or other printer error. Check printer (see printer manual for details). To resume printing, turn the printer off and then turn it back on.
PRINTER ERROR RESUME?	Printer out of paper or ink, or other printer error. Check printer (see printer manual for details). If printing does not resume automatically, press <b>MENU/OK</b> to resume.
CANNOT BE PRINTED	An attempt was made to print a movie, a picture not created with the camera, or a picture in a format not supported by the printer. Movies, RAW images, and some pictures created with other devices can not be printed; if the picture is a still picture created with the camera, check the printer manual to confirm that the printer supports the JFIF-JPEG or Exif-JPEG format. If it does not, the pictures can not be printed.
!⚠	Turn the camera off and wait for it to cool. Mottling may increase in pictures taken when this warning is displayed.

# Appendix

## Glossary

---

**Exif Print:** A standard for storing information with pictures for optimal color reproduction during printing.

**HDMI (High-Definition Multimedia Interface):** An interface standard for the transmission of images and sound that adds audio input to the DVI interface used to connect computers to displays.

**JPEG (Joint Photographic Experts Group):** A compressed file format for color images. The higher the compression rate, the greater the loss of information and more noticeable drop in quality when the picture is displayed.

**MOV:** A movie file format (extension “.mov”) developed by Apple, Inc., and viewed using QuickTime Player. This format is popular on the Internet.

**White balance:** The human brain automatically adapts to changes in the color of light, with the result that objects that appear white under one light source still appear white when the color of the light source changes. Digital cameras can mimic this adjustment by processing images according to the color of the light source. This process is known as “white balance.”

## Memory Card Capacity

The following table shows the recording time or number of pictures available at different image sizes. All figures are approximate; file size varies with the scene recorded, producing wide variations in the number of files that can be stored. The number of exposures or length remaining may not diminish at an even rate. A limited number of test pictures can be taken when no memory card is inserted.

Capacity		4 GB		8 GB	
		FINE	NORMAL	FINE	NORMAL
Photographs	<b>L</b> 3:2	600	960	1210	1910
	<b>L</b> 16:9	710	1130	1420	2260
	<b>L</b> 1:1	900	1410	1800	2810
	<b>M</b> 3:2	960	1880	1910	3740
	<b>M</b> 16:9	1130	2230	2260	4430
	<b>M</b> 1:1	1430	2740	2850	5440
	<b>S</b> 3:2	1790	3440	3570	6840
	<b>S</b> 16:9	2110	4020	4200	7990
	<b>S</b> 1:1	2670	5020	5320	9980
RAW		120		230	
Movies	1920×1080 (60 fps)/ 1920×1080 (30 fps)	13 min.		26 min.	

\* Use a CLASS10 card or better. Individual movies can not exceed 10 minutes in length.

## Specifications

System	
Model	FUJIFILM X100S digital camera
Effective pixels	16.3 million
Image sensor	23.6×15.6 mm (APS-C), X-Trans CMOS II sensor with square pixels and primary color filter
Storage media	• Internal memory (approx. 24 MB) • SD/SDHC/SDXC memory cards
File system	Compliant with Design Rule for Camera File System (DCF), Exif 2.3, and Digital Print Order Format (DPOF)
File format	• <b>Still pictures:</b> Exif 2.3 JPEG (compressed); RAW (original RAF format, special-purpose software required); RAW+JPG available • <b>Movies:</b> H.264 standard with linear PCM stereo sound (MOV)
Image size	• <b>L 3:2:</b> 4,896×3,264 • <b>L 16:9:</b> 4,896×2,760 • <b>L 1:1:</b> 3,264×3,264 • <b>M 3:2:</b> 3,456×2,304 • <b>M 16:9:</b> 3,456×1,944 • <b>M 1:1:</b> 2,304×2,304 • <b>S 3:2:</b> 2,496×1,664 • <b>S 16:9:</b> 2,496×1,408 • <b>S 1:1:</b> 1,664×1,664 • <b>180 panorama:</b> 2,160×9,600 (vertical) / 9,600×1,440 (horizontal) • <b>120 panorama:</b> 2,160×6,440 (vertical) / 6,400×1,440 (horizontal)
Lens	FUJINON fixed focal length lens
Focal length	f=23 mm (35 mm format equivalent: 35 mm)
Maximum aperture	F2.0
Aperture	F2.0–F16 in steps of 1/3 EV (9-blade diaphragm)
Focus range (distance from front of lens)	Approx. 50 cm (2.6 ft.)–∞ • <b>Macro (🌸) mode:</b> Approx. 10 cm (3.9 in.)–2.0 m (6.6 ft.)
Sensitivity	Standard output sensitivity equivalent to ISO 200–6400 in increments of 1/3 EV; AUTO (400), AUTO (800), AUTO (1600), AUTO (3200), AUTO (6400); extended output sensitivity equivalent to ISO 100, 12800, or 25600
Metering	256-segment through-the-lens (TTL) metering; MULTI, SPOT, AVERAGE
Exposure control	Programmed AE (with program shift); shutter-priority AE; aperture-priority AE; manual exposure
Exposure compensation	–2 EV – +2 EV in increments of 1/3 EV

System	
<b>Shutter speed</b> (mechanical shutter)	<ul style="list-style-type: none"> <li>• <b>P mode:</b> 1/4 sec. to 1/4,000 sec.</li> <li>• <b>Bulb:</b> Max. 60 min.</li> <li>• <b>Time:</b> 30 sec. to 1/2 sec.</li> <li>• <b>All other modes:</b> 60 min. to 1/4,000 sec.</li> </ul>
<b>Continuous</b>	Choose from frame rates of 3.0 or 6.0 fps (JPEG); max. number of frames is respectively about 44 and 31
<b>Focus</b>	<ul style="list-style-type: none"> <li>• <b>Mode:</b> Single or continuous AF; manual focus with focus ring</li> <li>• <b>Focus-area selection:</b> Multi, area with focus area size selection and choice of 49 (7 × 7) frames (electronic viewfinder and LCD monitor) or 25 (5 × 5) frames (optical viewfinder)</li> <li>• <b>Autofocus system:</b> Intelligent hybrid AF (TTL contrast-detect/phase-detection AF) with AF-assist illuminator</li> </ul>
<b>White balance</b>	Custom, color temperature selection, auto, direct sunlight, shade, daylight fluorescent, warm white fluorescent, cool white fluorescent, incandescent, underwater
<b>Self-timer</b>	Off, 2 sec., 10 sec.
<b>Flash</b>	<ul style="list-style-type: none"> <li>• <b>Type:</b> Auto flash</li> <li>• <b>Guide number:</b> Approx. 4.6/15 (ISO 100, m/ft.)</li> </ul>
<b>Mode</b>	Auto, fill flash, off, slow sync, commander, external flash (red-eye removal off); auto with red-eye removal, fill flash with red-eye removal, off, slow sync with red-eye removal, commander, external flash (red-eye removal on)
<b>Hot shoe</b>	Accessory shoe with TTL contacts
<b>Hybrid viewfinder</b>	<ul style="list-style-type: none"> <li>• <b>Optical viewfinder:</b> Reverse Galilean viewfinder with electronic bright frame display and approx. 0.5 × magnifications; frame coverage approx. 90%</li> <li>• <b>Electronic viewfinder:</b> 0.48-in., 2,360k-dot color LCD viewfinder; diopter adjustment -2 – +1 m<sup>-1</sup> (dpt); eye point approx. 15 mm; frame coverage approx. 100%</li> </ul>
<b>LCD monitor</b>	2.8-in/7.1 cm., 460k-dot color LCD monitor; frame coverage approx. 100%
<b>Movies</b>	 <b>1920 × 1080:</b> 1080p; 60 fps/30 fps; stereo sound; maximum length 10 minutes

**Input/output terminals****HDMI output** HDMI mini connector**Digital input/output** USB 2.0 High-Speed**Power supply/other****Power supply** NP-95 rechargeable battery**Battery life** (approximate number of frames that can be taken with a fully-charged battery)

Battery type	Approximate number of frames
NP-95 (type supplied with camera)	330

CIPA standard, measured using battery supplied with camera and SD memory card.

**Note:** Number of shots that can be taken with battery varies with battery charge level and will decline at low temperatures.**Camera size** (W × H × D) 126.5 mm × 74.4 mm × 53.9 (31.0") mm / 5.0 in. × 2.9 in. × 2.1 (1.2") in.

\* Excluding projecting parts, measured at the thinnest part

**Camera weight** Approx. 405 g / 14.3 oz., excluding battery, accessories, and memory card**Shooting weight** Approx. 445 g / 15.7 oz., including battery and memory card**Operating conditions** • **Temperature:** 0°C to +40°C / +32°F to +104°F • **Humidity:** 10% – 80% (no condensation)



**NP-95 rechargeable battery**

<b>Nominal voltage</b>	DC 3.6V
<b>Nominal capacity</b>	1,800 mAh
<b>Operating temperature</b>	0°C to +40°C/+32°F to +104°F
<b>Dimensions (W×H×D)</b>	35.2 mm×49.5 mm×10.8 mm / 1.3 in.×1.9 in.×0.4 in.
<b>Weight</b>	Approx. 39 g / 1.3 oz.

**BC-65N battery charger**

<b>Rated input</b>	100V – 240V AC, 50/60Hz
<b>Input capacity</b>	15VA
<b>Rated output</b>	4.2V DC, 650 mA
<b>Supported batteries</b>	NP-95 rechargeable batteries
<b>Charging time</b>	Approx. 210 minutes (+20°C/+68°F)
<b>Operating temperature</b>	0°C to +40°C/+32°F to +104°F
<b>Dimensions (W×H×D)</b>	65 mm×25.3 mm×80 mm/2.5 in.×0.9 in.×3.1 in., excluding projections
<b>Weight</b>	Approx. 59 g/2.0 oz., excluding battery

Weight and dimensions vary with the country or region of sale. Labels, menus, and other displays may differ from those on the actual camera.

■ **Notices**

- Specifications subject to change without notice; for the latest information, visit [http://www.fujifilm.com/products/digital\\_cameras/index.html](http://www.fujifilm.com/products/digital_cameras/index.html). FUJIFILM shall not be held liable for damages resulting from errors in this manual.
- Although the viewfinder and LCD monitor are manufactured using advanced high-precision technology, small bright points and anomalous colors may appear, particularly in the vicinity of text. This is normal for this type of LCD display and does not indicate a malfunction; images recorded with the camera are unaffected.
- Digital cameras may malfunction when exposed to strong radio interference (e.g., electric fields, static electricity, or line noise).
- Due to the type of lens used, some distortion may occur at the periphery of images. This is normal.

## Restrictions on Camera Settings

The options available in each shooting mode are listed below.

Option		P	S	A	M			
(macro mode)	OFF	✓	✓	✓	✓	✓	✓	✓ <sup>1</sup>
		✓	✓	✓	✓	✓		
DRIVE	(continuous)	6.0 fps	✓	✓	✓	✓		
		3.0 fps	✓	✓	✓	✓		
	Bracketing		✓	✓	✓	✓		
			✓	✓	✓	✓		
			✓	✓	✓	✓		
			✓	✓	✓	✓		
Metering		✓	✓	✓	✓	✓	✓ <sup>2</sup>	✓ <sup>2</sup>
		✓	✓	✓	✓	✓		
		✓	✓	✓	✓	✓		
Focus mode	AF-C	✓	✓	✓	✓	✓	✓	✓
	AF-S	✓	✓	✓	✓	✓	✓	✓
	MF	✓	✓	✓	✓	✓	✓	✓
Exposure compensation		✓	✓	✓		✓ <sup>5</sup>	✓	✓
WB WHITE BALANCE		✓	✓	✓	✓	✓	✓	✓
SELF-TIMER		✓	✓	✓	✓	✓		

Option		P	S	A	M			
ISO	H (25600)	✓	✓	✓	✓	✓		
	H (12800)	✓	✓	✓	✓	✓		
	6400	✓	✓	✓	✓	✓	✓	
	5000	✓	✓	✓	✓	✓	✓	
	4000	✓	✓	✓	✓	✓	✓	
	3200	✓	✓	✓	✓	✓	✓	
	2500	✓	✓	✓	✓	✓	✓	
	2000	✓	✓	✓	✓	✓	✓	
	1600	✓	✓	✓	✓	✓	✓	
	1250	✓	✓	✓	✓	✓	✓	
	1000	✓	✓	✓	✓	✓	✓	
	800	✓	✓	✓	✓	✓	✓	
	640	✓	✓	✓	✓	✓	✓	
	500	✓	✓	✓	✓	✓	✓	
	400	✓	✓	✓	✓	✓	✓	
	320	✓	✓	✓	✓	✓	✓	
	250	✓	✓	✓	✓	✓	✓	
	200	✓	✓	✓	✓	✓	✓	
	L (100)	✓	✓	✓	✓	✓		
	AUTO (6400)	✓	✓	✓	✓	✓	✓	
AUTO (3200)	✓	✓	✓	✓	✓	✓		
AUTO (1600)	✓	✓	✓	✓	✓	✓		
AUTO (800)	✓	✓	✓	✓	✓	✓		
AUTO (400)	✓	✓	✓	✓	✓	✓		











## Restrictions on Camera Settings



Option		P	S	A	M			
IMAGE SIZE	L	✓	✓	✓	✓	✓		
	M	✓	✓	✓	✓	✓		
	S	✓	✓	✓	✓	✓	✓ <sup>3</sup>	
IMAGE QUALITY	FINE	✓	✓	✓	✓	✓	✓	
	NORMAL	✓	✓	✓	✓	✓	✓	
	FINE+RAW	✓	✓	✓	✓			
	NORMAL+RAW	✓	✓	✓	✓			
DYNAMIC RANGE	AUTO	✓	✓	✓			✓	
	R100	✓	✓	✓	✓	✓	✓	
	R200	✓	✓	✓	✓	✓	✓	
	R400	✓	✓	✓	✓	✓	✓	
FILM SIMULATION	STD	✓	✓	✓	✓	✓	✓	✓
	VF	✓	✓	✓	✓	✓	✓	✓
	S	✓	✓	✓	✓	✓	✓	✓
	NF	✓	✓	✓	✓	✓	✓	✓
	NE	✓	✓	✓	✓	✓	✓	✓
	B	✓	✓	✓	✓	✓	✓	✓
	BY	✓	✓	✓	✓	✓	✓	✓
	BR	✓	✓	✓	✓	✓	✓	✓
	BG	✓	✓	✓	✓	✓	✓	✓
SEPA	✓	✓	✓	✓	✓	✓	✓	

Option		P	S	A	M			
ND FILTER		✓	✓	✓	✓	✓	✓	
COLOR		✓	✓	✓	✓	✓		
SHARPNESS		✓	✓	✓	✓	✓		
HIGHLIGHT TONE		✓	✓	✓	✓	✓		
SHADOW TONE		✓	✓	✓	✓	✓		
NOISE REDUCTION		✓	✓	✓	✓	✓		
LONG EXPOSURE NR		✓	✓	✓	✓	✓		
SELECT CUSTOM SETTING		✓	✓	✓	✓	✓		
EDIT/SAVE CUSTOM SETTING		✓	✓	✓	✓	✓		
Fn BUTTON		✓	✓	✓	✓	✓	✓	✓

Option		P	S	A	M			
DISP. CUSTOM SETTING	FRAMING GUIDELINE	✓	✓	✓	✓	✓		✓
	ELECTRONIC LEVEL	✓	✓	✓	✓	✓		✓
	AF DISTANCE INDICATOR	✓	✓	✓	✓	✓		
	MF DISTANCE INDICATOR	✓	✓	✓	✓	✓		
	HISTOGRAM	✓	✓	✓	✓	✓		✓
	APERTURE/S-SPEED/ISO	✓	✓	✓	✓	✓		
	EXP. COMPENSATION	✓	✓	✓	✓	✓		✓
	PHOTOMETRY	✓	✓	✓	✓	✓		
	FLASH	✓	✓	✓	✓	✓		
	WHITE BALANCE	✓	✓	✓	✓	✓		✓
	FILM SIMULATION	✓	✓	✓	✓	✓		✓
	DYNAMIC RANGE	✓	✓	✓	✓	✓		
	FRAMES REMAINING	✓	✓	✓	✓	✓		
	IMAGE SIZE/QUALITY	✓	✓	✓	✓	✓		
	BATTERY LEVEL	✓	✓	✓	✓	✓		✓

Option		P	S	A	M			
	FRAMING GUIDELINE	✓	✓	✓	✓	✓		✓
	WIDE CONVERSION LENS	✓	✓	✓	✓	✓		✓
	MF ASSIST	✓	✓	✓	✓			
	ADVANCED FILTER	✓	✓	✓	✓			
	AF MODE		✓	✓	✓	✓	✓	✓ <sup>5</sup>
			✓	✓	✓	✓	✓	✓ <sup>5</sup>
	AF ILLUMINATOR	✓	✓	✓	✓	✓		✓
	AE/AF-LOCK MODE	✓	✓	✓	✓	✓	✓	
	AE/AF-LOCK BUTTON	✓	✓	✓	✓	✓	✓	
	CORRECTED AF FRAME	✓	✓	✓	✓	✓		
	FLASH MODE	AUTO	✓				✓ <sup>5</sup>	
			✓	✓	✓	✓	✓	
			✓		✓		✓ <sup>5</sup>	
			✓	✓	✓	✓	✓	
			✓	✓	✓	✓	✓	
			✓	✓	✓	✓	✓	
		AUTO	✓					
			✓	✓	✓	✓		
			✓		✓			
			✓	✓	✓	✓		
	✓	✓	✓	✓				
	✓	✓	✓	✓	✓			

Option	P	S	A	M			
 FLASH	✓	✓	✓	✓	✓		
 RED EYE REMOVAL	✓	✓	✓	✓			
 SAVE ORG IMAGE	✓	✓	✓	✓			
 FOCUS RING	✓	✓	✓	✓	✓	✓	✓
 FOCUS CHECK	✓	✓	✓	✓	✓		
 POWER MANAGEMENT	✓	✓	✓	✓	✓	✓	✓
 COLOR SPACE	✓	✓	✓	✓	✓	✓	

- 1 Fixed at **OFF**.
- 2 Fixed at  (multi).
- 3 Fixed at .
- 4 Center focus area selected automatically.
- 5 Options available vary with shooting mode.



# FUJIFILM

---

**FUJIFILM Corporation**

7-3, AKASAKA 9-CHOME, MINATO-KU, TOKYO 107-0052, JAPAN

[http://www.fujifilm.com/products/digital\\_cameras/index.html](http://www.fujifilm.com/products/digital_cameras/index.html)