

FUJIFILM

SHOE MOUNT FLASH

EF-X500



Owner's Manual

About This Manual

This manual contains instructions for the EF-X500, a powerful, multi-functional flash unit from FUJIFILM. When using the flash, refer to both this guide and the camera manual.

Symbols

The following symbols are used in this manual:

-  Information that should be read to prevent damage to the product.
-  Additional information that may be helpful when using the product.
-  Pages on which related information may be found.

Using the Flash

Do not pick up the camera by the flash. The flash may slip from the hot shoe, causing the camera to fall.

The LED video light is intended only to provide lighting for the camera and should not be used for other purposes.

Remove the batteries immediately after immersion in water or in the event that water or metal objects find their way into the product. Failure to observe this precaution could result in fire or electric shock.

For information on compatible cameras, visit our website at <http://www.fujifilm.com/sd/>

Supplied Accessories

Check that the following items are supplied with your EF-X500 shoe mount flash. Please contact your retailer should anything be missing.

- EF-X500 shoe-mount flash
- Diffuser
- Mini stand
- *Quick Start Guide*
- Soft case



Chapter Index

First-time users should read the Introduction and Chapter 1 for basic information on using the flash.

Introduction	ii
1 Getting Started	12
2 Flash Controls	22
3 Single Flash Mode	28
4 Wireless Flash Photography	46
5 Slave Mode	76
6 Setup	80
7 Setting Save, Load, and Reset	86
8 Appendix	90

Table of Contents

About This Manual	ii
Symbols.....	ii
Using the Flash.....	ii
Supplied Accessories.....	ii
The EF-X500.....	1
Flash Placement.....	2
Parts of the Flash.....	3
The LCD Display	4
Single Flash Mode	4
Remote Mode	6
Master Mode.....	7
Adjusting Settings.....	10

1 Getting Started 12

Inserting Batteries	13
Battery Life and Recycling Time.....	14
Attachment and Removal	15
Attaching the Flash.....	15
Detaching the Flash	16
Turning the Flash On and Off.....	17
Turning the Flash On	17
Charging.....	18
Standby.....	18
The LCD Backlight.....	19
The  (Lock) Button	19
Turning the Flash Off.....	19
Taking Photographs	20

2	Flash Controls	22
	Bounce Lighting.....	23
	Using the Wide Panel	24
	Catchlight Photography.....	25
	The Diffuser	26
3	Single Flash Mode	28
	Flash Control Mode.....	29
	TTL Mode	29
	Manual Mode	31
	Repeating Flash Mode.....	33
	Camera Controls	37
	Flash Setup.....	37
	Other Settings.....	38
	Lighting.....	38
	Coverage	39
	LED Video Light On/Off.....	40
	LED Video Light Brightness.....	41
	LED AF-Assist Lamp/Catchlight	42
	Single Flash Mode Options.....	44

4	Wireless Flash Photography	46
	Wireless Flash Control.....	47
	Placement and Range.....	48
	Remote Flash Units	49
	Group.....	50
	Flash Compensation/Output.....	51
	Channel.....	52
	Remote Mode Options: Summary	53
	The Master Flash	54
	Group.....	55
	Channel.....	56
	Master Mode Options: Summary	57
	Camera Controls	59
	Flash Setup.....	59
	Taking Photographs	60
	TTL Mode	60
	TTL Output Ratio Selection.....	64
	Manual Mode	68
	Repeating Flash.....	71
5	Slave Mode	76
	P and N (Slave) Modes	77
	Flash Output.....	79

6 Setup	80
The Setup Menu.....	81
TEST BUTTON.....	82
TTL TEST POWER.....	82
SCALE UNITS	82
LCD DENSITY.....	82
LCD ILLUMINATION.....	83
BEEP	83
REMOTE READY INDICATOR.....	83
SENSOR FORMAT	84
CUSTOM SENSOR FORMAT	84
STANDBY.....	84
REMOTE STANDBY	85
AUTO POWER OFF	85
7 Setting Save, Load, and Reset	86
Saving Settings.....	87
Loading Settings.....	88
Restoring Default Settings	89
8 Appendix	90
Troubleshooting/FAQ.....	91
Temperature/Battery Warnings.....	95
Specifications.....	96
Guide Number (ISO 100/m).....	98

The EF-X500

This powerful, multi-functional flash unit features support for i-TTL flash control, FP (high-speed sync), and optical wireless remote control.

The EF-X500 can be controlled remotely via optical wireless flash control or mounted on the camera hot shoe for use as a stand-alone flash unit or as a master flash controlling remote FUJIFILM flash units via optical wireless control.

The following features are available when the unit is mounted on an X-series camera with a hot shoe.

Feature			Camera with full EF-X500 support?	
			Yes	No
Single flash	TTL flash control	Normal	✓	✓
		FP	✓	—
	Manual flash control	Normal	✓	✓
		FP	✓	—
Repeating flash		✓	✓	
Master flash (optical remote control)			✓	—
LED AF-assist lamp			✓	—
LED catchlight			✓	—

The EF-X500 can also function as a remote flash unit (either full manual or with optical remote control) or LED video light.

 For more information, visit <http://www.fujifilm.com/sd/>

Flash Placement

When using the FUJIFILM optical wireless remote flash control system, orient the remote units with their optical receivers facing the master unit and rotate the flash heads to the desired angles.

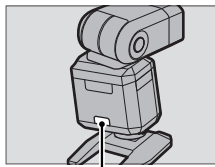

Receiver

The flash can control remote flash units in up to three groups (A, B, and C), each of which may contain multiple flash units.

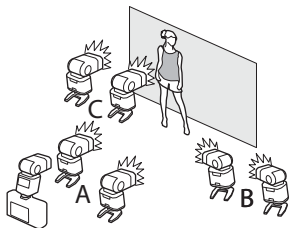

The approximate maximum ranges for remote flash control are as shown. Range may be reduced by obstacles or interference from sunlight or other light sources.

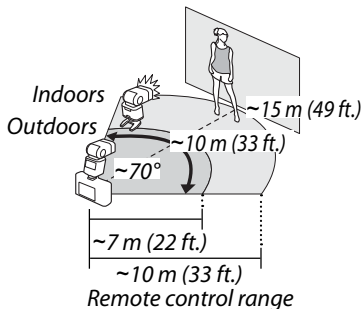

Parts of the Flash

See the page numbers to the right of each item for more information.

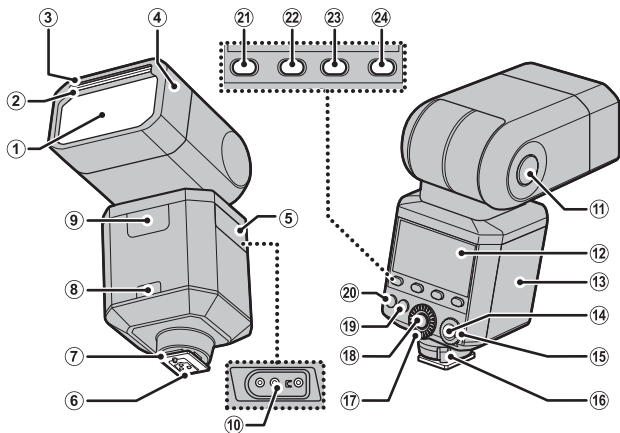

① Fresnel lens (flash window).....	23	⑮ Power switch.....	17
② Wide panel.....	24	⑯ Latch.....	15
③ Catchlight panel.....	25	⑰ Command dial	
④ Accessory mount (cover).....	26	⑱ OK button	
⑤ Power connector cover		⑲ SETUP / ⏏ (lock) button.....	19, 81
⑥ Hot shoe contacts.....	15	⑳ Ready lamp/ test button.....	18, 82, 83
⑦ Mount.....	15	㉑ Page button.....	10, 44, 53, 57
⑧ Optical receiver.....	2, 48, 49	㉒ Function button 1	
⑨ LED video light.....	40, 41, 42	10, 44, 53, 57
⑩ Power connector		㉓ Function button 2	
⑪ Bounce latch.....	23	10, 44, 53, 57
⑫ LCD display.....	4	㉔ Function button 3	
⑬ Battery-chamber cover.....	13	10, 44, 53, 57
⑭ Power-switch latch.....	17		

The LCD Display

The display varies according to the mode selected with the power switch (📖 17).

Single Flash Mode

The following indicators are displayed when the power switch is rotated to **ON**. The display varies with the flash control mode (📖 29).

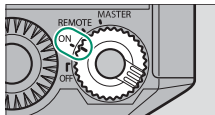

TTL

📖 20, 29

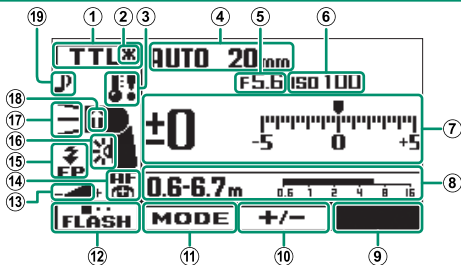

- | | |
|-----------------------|--|
| ① Flash control mode | ⑪ Function button 1 |
| ② TTL lock | ⑫ Function button page |
| ③ Temperature warning | ⑬ LED video light brightness |
| ④ Coverage | ⑭ LED AF-assist lamp/catchlight setting |
| ⑤ Aperture | ⑮ Sync mode (front curtain, rear curtain, FP auto) |
| ⑥ ISO sensitivity | ⑯ LED video light on/off |
| ⑦ Flash compensation | ⑰ Lighting |
| ⑧ Range | ⑱ Bounce status |
| ⑨ Function button 3 | |
| ⑩ Function button 2 | ⑲ Beep |

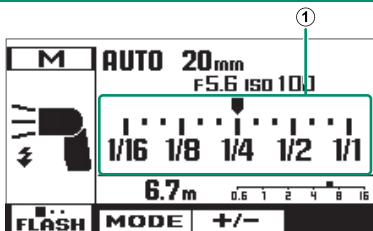

① Flash output

Repeating

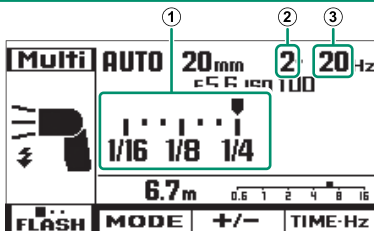

① Flash output

③ Frequency

② Number of flashes

ⓘ The display is shown with all indicators lit for illustrative purposes. The page and function button icons at the bottom of the display vary with the page selected.

The display backlight turns on when flash controls are used.

Remote Mode

The following indicators are displayed when the power switch is rotated to **REMOTE**. The display varies according to whether the flash is in normal or slave mode (📖 50, 77).

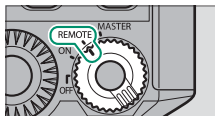

Normal Mode (Group A, B, or C)

📖 50

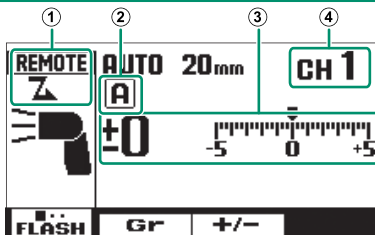

- ① Remote mode indicator
- ② Group
- ③ Flash compensation (TTL)/flash output (manual/repeating)
- ④ Channel

Slave (P and N) Mode

📖 77

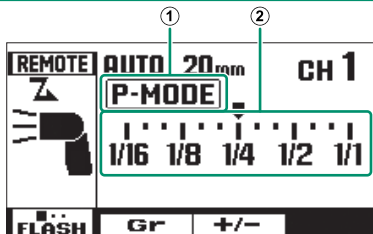

- ① Full manual (slave) mode indicator
- ② Flash output

Master Mode

The following indicators are displayed when the power switch is rotated to **MASTER**. The display varies with the flash control mode (📖 60, 64, 68, 71).

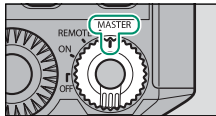

TTL

📖 60

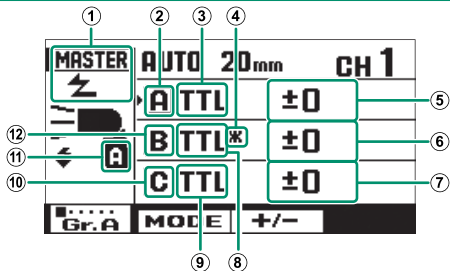

- ① Master mode indicator
- ② Group (group A)
- ③ TTL mode (group A)
- ④ TTL lock
- ⑤ Flash compensation (group A)
- ⑥ Flash compensation (group B)
- ⑦ Flash compensation (group C)
- ⑧ TTL mode (group B)
- ⑨ TTL mode (group C)
- ⑩ Group (group C)
- ⑪ Master group
- ⑫ Group (group B)

TTL Output Ratio Selection

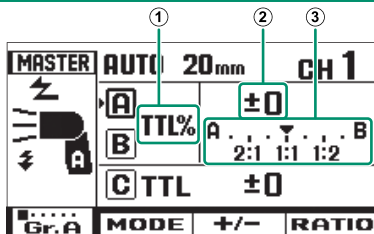

- ① TTL output ratio selection mode
 ② Flash compensation (groups A and B)
 ③ Output ratio (groups A and B)

Manual

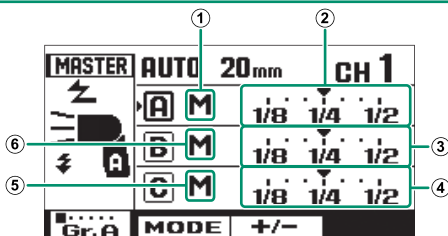

- ① Manual mode (group A)
 ② Flash output (group A)
 ③ Flash output (group B)
 ④ Flash output (group C)
 ⑤ Manual mode (group C)
 ⑥ Manual mode (group B)

Repeating

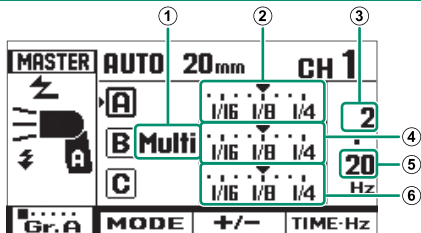

- ① Repeating mode
- ② Flash output (group A)
- ③ Number of flashes
- ④ Flash output (group B)
- ⑤ Frequency
- ⑥ Flash output (group C)

Master Mode Not Supported

The display at right appears in the flash LCD if master mode is not supported by the camera to which the unit is attached.



Adjusting Settings

Flash settings can be adjusted as described below.

To adjust settings, press the page button (①) to reach the page (②) with the desired item (③). You can then press the function button (④) immediately below the item to highlight it, rotate the command dial (⑤) to display the desired option, and press **OK** (⑥).

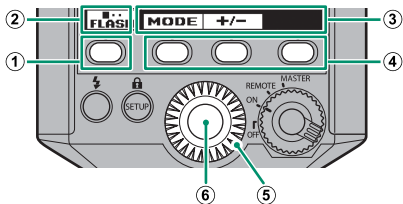

The makeup of each page and the items associated with the function buttons vary according to whether the power switch is in the **ON**, **REMOTE**, or **MASTER** position. For more information, see pages 44 (single flash mode), 53 (remote mode), and 57 (master mode).

FP mode (high-speed flash sync)

At high shutter speeds, the first and second curtains in the camera's focal-plane shutter pass over the sensor simultaneously with a small time gap, exposing only a narrow slit, with the result that the light from a normally-timed flash reaches only a small section of the sensor. Flash photography consequently requires slower shutter speeds, severely limiting the range of speeds available. The EF-X500 supports FP (high-speed sync), in which the flash fires continuously while the first and second curtains travel across the sensor, allowing the flash to be used at any shutter speed.

Getting Started



This chapter describes how to ready the flash for shooting and the basic procedure for taking pictures using the flash.

Inserting Batteries

The flash takes four AA alkaline or nickel-metal hydride (NiMH) batteries (Ni-MH batteries are recommended for increased endurance and shorter charging times).

- ❗ Replace all four batteries at the same time, using fresh or fully-charged batteries of the same brand and type. The rubber gasket inside the cover prevents water entry; if the unit is wet, dry it thoroughly before opening the cover and remove any droplets on or around the gasket.

- 1 Press the area around the top of the cover down slightly and then continue sliding the cover down to open it.

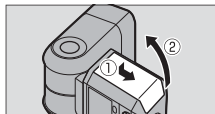

- ❗ Before opening the cover, be sure the power switch is in the **OFF** position.

- 2 Insert four AA batteries in the orientation shown on the inside of the cover.

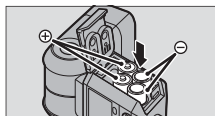

- ❗ Failure to insert the batteries in the correct orientation could result in malfunction.

- 3 Close the cover.

- ❗ Be careful that the cover does not catch the black dust-/water-resistant gasket.

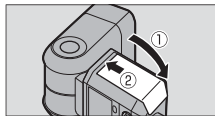

- !** Remove the batteries if the product will not be used for an extended period. The batteries may be hot immediately after the flash has fired a number of times in succession; observe caution when removing the batteries.

Battery Life and Recycling Time

Battery life and recycling time vary with battery type, as is shown in the table below (in-house measurements). Choose a type that matches your needs.

Size, type, and number	Number of uses (approx.)*	Recycling time (approx.)†
AA alkaline × 4	130	3.9 s
AA Ni-MH × 4	170	2.5 s

* Number of times flash can be fired at intervals of 30 seconds; count ends when ready lamp takes over 30 seconds to light. Measured using fresh batteries manufactured within last three months.

† Minimum time needed for ready lamp to light after flash fires, as measured under conditions described above.

Attachment and Removal

Turn the flash off before mounting it on or removing it from the hot shoe. If the flash is on, it may short the hot shoe contacts, causing the flash to fire unexpectedly or other product malfunction. Remove any water from the mount and the hot shoe before attaching the flash.

Attaching the Flash

- 1 Release the latch by sliding it as shown.

 Be sure to release the latch before attaching the flash. Failure to observe this precaution could damage the hot shoe.

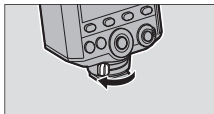

- 2 Slide the mount all the way into the camera hot shoe.

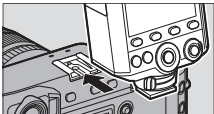

- 3 Latch the unit in place by sliding the latch in the direction shown.

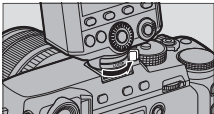

Detaching the Flash

Unlatch and detach the unit as shown. Do not attempt to remove the unit without first unlatching it, as this could damage the hot shoe.

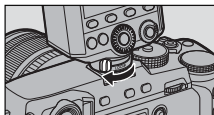

Turning the Flash On and Off

Use the power switch to turn the flash on or off.

Turning the Flash On

To turn the flash on, rotate the power switch to **ON**, or hold the power switch latch and rotate the switch to **REMOTE** or **MASTER**.

- **Choose ON** to use the unit as a stand-alone flash mounted on the camera hot shoe.

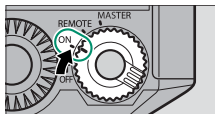

- **Choose REMOTE** to use the unit as a remote flash controlled via FUJIFILM optical remote flash control. Use the supplied mini stand to orient the unit with the receiver facing the master flash.

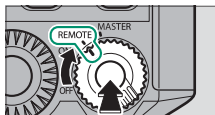

- **Choose MASTER** if the unit will be mounted on the camera hot shoe for use as a master flash controlling remote flash units via FUJIFILM optical remote flash control.

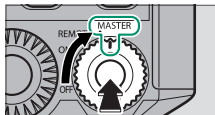

Charging

The ready lamp blinks while the flash charges. The lamp stops blinking when the flash is ready to fire at full power; if the flash is fired before the lamp stops blinking, flash output will be less than the value indicated by the guide number (if desired, the flash can be configured not to beep when charging is complete;  83). Except when camera menus are displayed, you can test-fire the flash (or at some settings, emit a modeling flash) by pressing the ready lamp (test button).

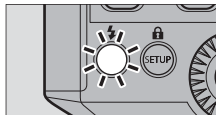

Standby

If no operations are performed for about two minutes, the flash will enter standby mode to reduce the drain on the batteries and the ready lamp will blink slowly. Normal operation can be restored by pressing the ready lamp (test button).

You can disable this feature or change the time before the flash enters standby mode ( 84, 85).

The LCD Backlight

The LCD display backlight turns on when controls are used, and remains on for about 15 seconds. The backlight lights green in single flash and master modes, amber in remote mode, and red when a temperature warning (📖 95) is displayed.

You can adjust display contrast (📖 82), disable the backlight, or choose how long the backlight remains on (📖 83).

The 🔒 (Lock) Button

To disable all controls other than the power switch and power switch latch, press and hold the **SETUP/🔒** (lock) button. To re-enable the controls, press and hold the button again.

Turning the Flash Off

To turn the flash off, rotate the power switch to **OFF**. The ready lamp will turn off. Settings are stored while the flash is off.

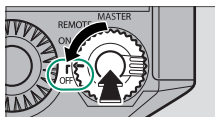

Taking Photographs

For automatic through-the-lens (TTL) flash control, use the camera in mode **P** (program AE).

- 1 Rotate the power switch to **ON**.

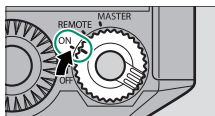

- 2 Press the page button until the **FLASH** page is displayed.

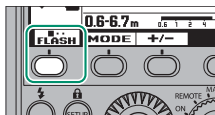

- 3 Press the **MODE** function button to highlight flash control mode.

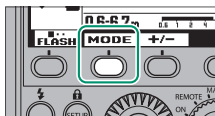

- 4 Rotate the command dial to select **TTL** (TTL mode) and press **OK**.

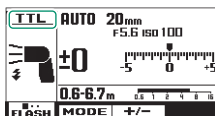
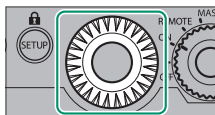
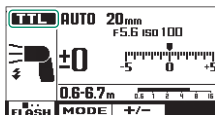

- 5** After confirming that the ready lamp is lit, take pictures using the camera shutter button.

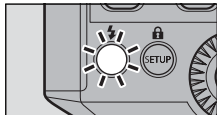

-  The flash will not fire if you release the shutter before the ready lamp lights. If you release the shutter while the lamp is flashing, the flash will fire but not at full power.

If the subject appears underexposed when the photograph is played back, try taking the shot again after moving closer to your subject or choosing a higher value for ISO sensitivity.

Flash Controls

2

Read this chapter for information on bounce lighting, the wide and catchlight panels, and the diffuser.

Bounce Lighting

The flash head can be tilted so that the light from the flash is reflected from a ceiling or wall for softer, more natural lighting or to illuminate the area behind your subject.

The flash head can be tilted by as much as 90° up, 10° down, 135° left, and 180° right. The head locks at 0° and 90° up; when moving it up or down from these positions, keep the bounce latches on the sides of the flash head pressed. The bounce status indicator (↑ or ↓) is displayed while bounce lighting is in effect.

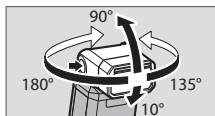

! The flash may not adequately light the subject if the distance between the unit and the reflective surface is too great. If the image is underexposed, try choosing a lower f-number (larger aperture) or higher ISO sensitivity.

The light from the flash may take on the color of the surface from which it is reflected.

Photographing Nearby Subjects

Tilt the flash head down 10° when photographing nearby subjects.

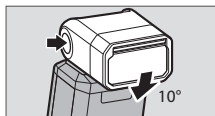

Using the Wide Panel

The wide panel offers coverage for focal lengths as short as about 20 mm (35 mm format equivalent).

- 1 Slide the wide panel out and down to cover the fresnel lens.

! *Do not use force.* The panel could pull free of the flash head.



Catchlight panel
Wide Panel

- 2 Return the catchlight panel to its housing above the flash window.

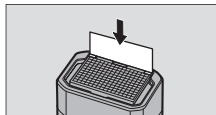

- 3 Press the shutter button all the way down to fire the flash and take a photograph. Confirm that the subject is within the effective range of the flash.

! Flash coverage can not be adjusted while the wide panel is in use. In addition, care should be used to avoid underexposure when using the wide panel with bounce lighting.

Return the panel to its housing when it is not in use, as it could otherwise be damaged during transport.

Catchlight Photography

The catchlight panel can be used in combination with bounce lighting to add catchlights to your subjects' eyes.

- 1 Raise the catchlight panel as shown.

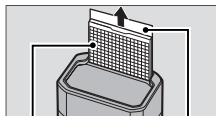

Catchlight panel
Wide panel

- 2 Return the wide panel to its housing.

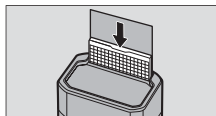

For best results, stay close to your subject and rotate the flash head up 90° and 0° horizontally. The desired results may not be achieved if the head is rotated left or right.

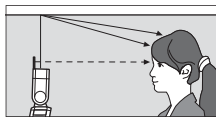

The Diffuser

The diffuser diffuses and softens the light from the flash.

- 1 Remove the accessory mount cover. When attaching or removing the cover, cup your hand around it as shown. Do not use force.



- 2 Attach the diffuser as shown.

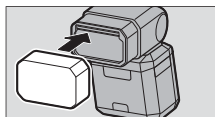

-  When attaching or removing the diffuser, observe caution to prevent injury due to your fingers getting caught between the diffuser and the flash unit.

Single Flash Mode

3

Read this chapter for more information on using the EF-X500 as a standalone flash unit.

Flash Control Mode

When the power switch is rotated to **ON** (single flash mode), you can choose the flash control mode from TTL, manual (📖 31), and repeating flash (📖 33).

TTL Mode

In TTL mode (📖 20), automatic flash control is available when the camera is in mode **P** (program AE).

🔑 The flash display shows the approximate range when the camera shutter button is pressed halfway.

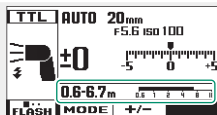

+/- Flash Compensation

Although in TTL mode flash output is automatically adjusted for optimal exposure, you also have the option of manually adjusting output up or down to make the subject brighter or darker. Choose from values between ± 5 EV in steps of $\frac{1}{3}$ EV (note that depending on shooting conditions, output may be less than selected if the limits of the camera exposure metering system are reached).

- 1 Press the page button until the **FLASH** page is displayed.



- 2 Press the **+/-** function button to highlight flash compensation.

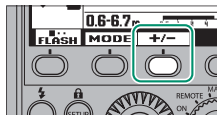

- 3 Rotate the command dial to choose the desired value, or select ± 0 to turn flash compensation off.

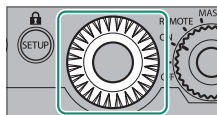
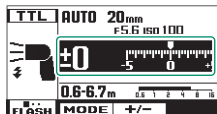

- 4 Press **OK**.

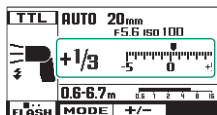
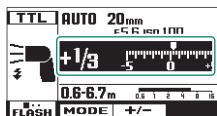

Manual Mode

In manual mode, you can choose the flash output in fractions of full power, from $\frac{1}{4}$ (full power) to $\frac{1}{512}$, in steps of $\frac{1}{3}$ EV (note that depending on shooting conditions, output may be less than selected if the limits of the camera exposure metering system are reached).

- 1 Rotate the power switch to **ON**.

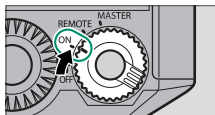

- 2 Press the page button until the **FLASH** page is displayed.

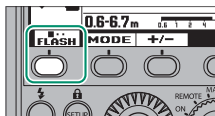

- 3 Press the **MODE** function button to highlight the flash control mode.

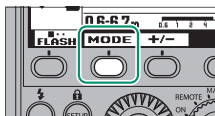

- 4 Rotate the command dial to select **M** (manual) and press **OK**.

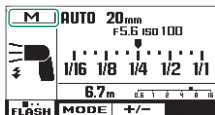
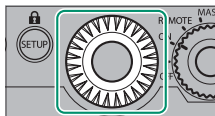
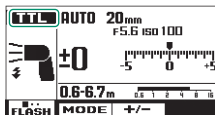

- 5 Press the **+/-** function button and rotate the command dial to adjust flash output.

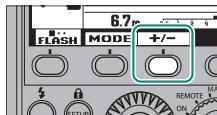

- 6 Press **OK**.

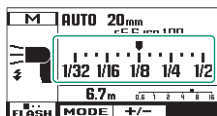
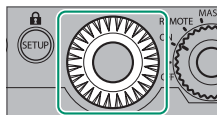
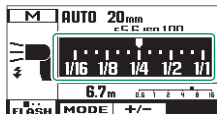

The flash display shows the approximate range when the camera shutter button is pressed halfway.

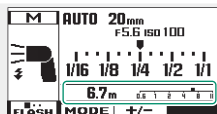

Repeating Flash Mode

In this mode, the flash fires multiple times. This can be combined with slow shutter speeds for a stroboscopic flash that records moving subjects at multiple positions within the frame. You can adjust flash output and choose the flash frequency (the interval between flashes) and the number of times the flash fires with each shot.

- 1 Rotate the power switch to **ON**.

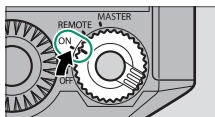

- 2 Press the page button until the **FLASH** page is displayed.

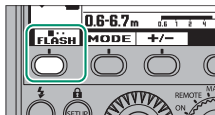

- 3 Press the **MODE** function button to highlight the flash control mode.

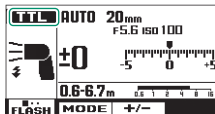
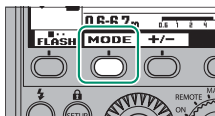

- 4 Rotate the command dial to select **Multi** (repeating flash) and press **OK**.

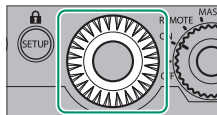

- 5 Press the **+/-** function button and rotate the command dial to adjust flash output. Press **OK** to proceed.

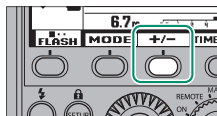
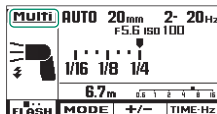

- 6 Press the **TIME-Hz** function button and rotate the command dial to choose the number of the times the flash will fire.

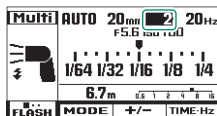
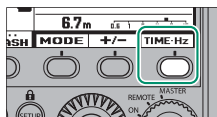
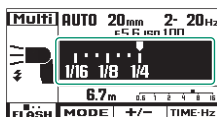

- 7 Press the **TIME-Hz** function button again and rotate the command dial to choose the flash frequency.

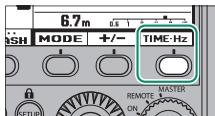

- 8 Press **OK**.

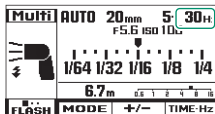
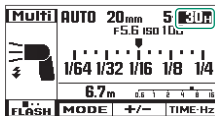



Shutter Speed

For best result, shutter speed should approximately equal the time it takes for the flash to fire the selected number of times. Shutter speed can be calculated as follows:

$$\text{Shutter speed} = \text{number of flashes} \div \text{frequency}$$

For example, if the flash is set to fire 20 times at a frequency of 4 Hz, choose a shutter speed around 5 s.

 Note that the flash may display a temperature warning and temporarily suspend operation after being fired multiple times in succession ( 95).

 For best results, use a tripod, a remote release, and an EF-BP1 battery pack.

Maximum Number of Flashes

The maximum values that can be selected for the number of flashes is shown below.

		Output							
		$\frac{1}{4}$	$\frac{1}{8}$	$\frac{1}{16}$	$\frac{1}{32}$	$\frac{1}{64}$	$\frac{1}{128}$	$\frac{1}{256}$	$\frac{1}{512}$
Frequency	1	6	12	30	60	90	100	100	100
	2	4	10	30	60	90	100	100	100
	3	3	8	30	60	90	100	100	100
	4	3	7	25	50	90	100	100	100
	5	3	6	20	50	90	100	100	100
	6-7	3	5	13	40	80	90	100	100
	8-9	3	5	12	30	70	80	100	100
	10	2	5	11	30	60	70	100	100
	11	2	5	11	25	50	70	90	100
	12-14	2	5	10	20	50	60	90	100
	15-19	2	5	9	20	45	60	90	100
	20-50	2	4	9	15	30	50	90	90
	60-200	2	4	8	15	30	45	80	90
250-500	2	4	8	14	25	40	70	90	

Camera Controls

If the camera offers full support for the EF-X500 (📖 96), flash settings can be adjusted using camera controls.

Flash Setup

Flash settings can be adjusted using the **⚡ FLASH SETTING > FLASH FUNCTION SETTING** option in the camera shooting menu. See the camera manual for more information.

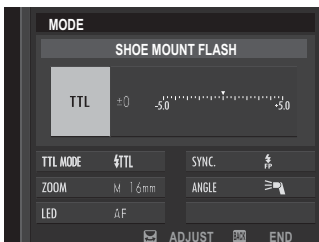

The FLASH FUNCTION SETTING menu for the X-T2

Other Settings

This section lists the other settings that can be accessed via the page and function buttons in single flash mode.

Lighting

Give priority to range or flash coverage.

- 1 Press the page button until the **FLASH** page is displayed.

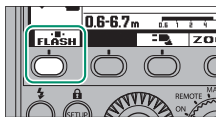

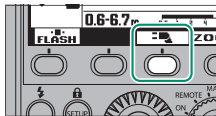

- 2 Press the  function button to highlight lighting.

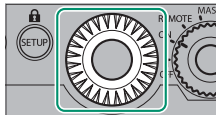
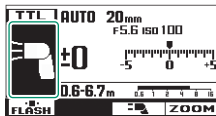

- 3 Rotate the command dial to highlight one of the following options and press **OK** to select.



-  (**output priority**): Gain range by slightly reducing coverage.
-  (**normal**): Match coverage to picture angle.
-  (**coverage priority**): Slightly increase coverage for more even lighting.

Coverage

Adjust the angle of illumination (flash coverage), or choose **AUTO** to automatically match coverage to lens focal length.

- 1 Press the page button until the **FLASH** page is displayed.

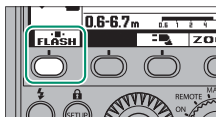

- 2 Press the **ZOOM** function button to highlight coverage.

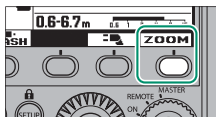

- 3 Rotate the command dial to select the desired option and press **OK**.

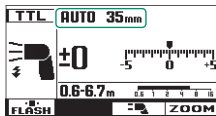
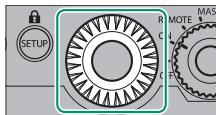
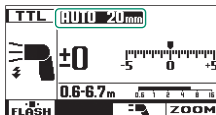

 This setting has no effect when the wide panel is used.

LED Video Light On/Off

Turn the LED on the front of the flash unit on or off.

- 1 Press the page button until the **LED** page is displayed.

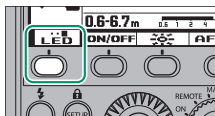

- 2 Press the **ON/OFF** function button to turn the video light on (☀️) or off.

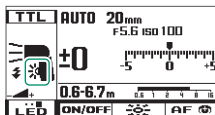
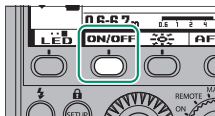

LED Video Light Brightness

Adjust the brightness of the LED video light.

- 1 Press the page button until the **LED** page is displayed.

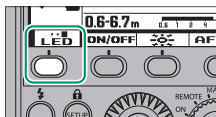

- 2 Press the  function button to display the current video light brightness.

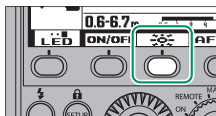

- 3 Rotate the command dial to select the desired brightness and press **OK**.

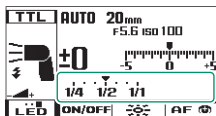
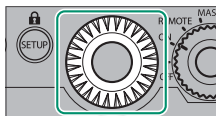
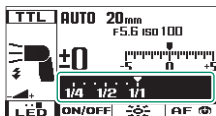

LED AF-Assist Lamp/Catchlight

The LED video light on the front of the flash unit can also be used to add a catchlight or as an AF-assist lamp for still photography. Unlike the catchlight panel, the LED catchlight can be used when shooting with the camera rotated to take pictures in portrait (“tall”) orientation or when the flash head is at an angle other than 90°.

- 1 Press the page button until the **LED** page is displayed.

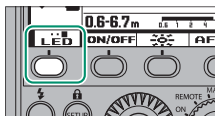

- 2 Press the **AF**  function button to highlight the LED AF-assist lamp/catchlight setting.

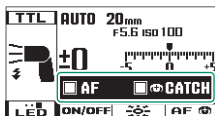
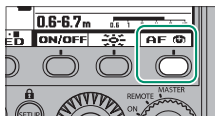

- 3 Rotate the command dial to highlight one of the following options and press **OK** to select.

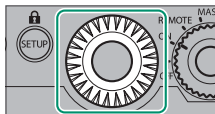





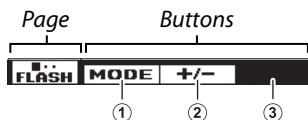

- AF CATCH : AF-assist lamp and catchlight off.
- AF CATCH : AF-assist lamp on, catchlight off.
- AF CATCH : AF-assist lamp off, catchlight on.
- AF CATCH : AF-assist lamp and catchlight on.

Single Flash Mode Options

Single flash mode options are summarized below.



Page	Button	Function	Options	
	①	MODE (flash control mode)	TTL, M, Multi	20, 31, 33
	②	+/- (flash compensation/output)	-5 – +5 in 1/3 EV steps (TTL mode), 1/1 – 1/512 in 1/3 EV steps (mode M), or 1/4 – 1/512 in 1/3 EV steps (Multi mode)	29, 32, 34
	③	TIME-Hz (number of flashes/frequency)	2 – 100 flashes, 1 – 500 Hz (Multi only)	34
	①	None	—	—
	②	(lighting)	(output priority), (normal), (coverage priority)	38
	③	ZOOM (coverage)	AUTO (coverage is automatically adjusted according to lens focal length), M (choose focal length between 24 and 105 mm in 35 mm - format equivalent; varies with camera)	39

Page	Button	Function	Options	
LED	①	ON/OFF (LED video light on/off)	On, off	40
	②	 (LED video light brightness)	$\frac{1}{4}$ – $\frac{1}{128}$	41
	③	AF  (LED AF-assist lamp/catchlight)	<input type="checkbox"/> AF <input type="checkbox"/>  CATCH <input checked="" type="checkbox"/> AF <input type="checkbox"/>  CATCH <input type="checkbox"/> AF <input checked="" type="checkbox"/>  CATCH <input checked="" type="checkbox"/> AF <input checked="" type="checkbox"/>  CATCH	42

Wireless Flash Photography

4

This chapter describes how to use the FUJIFILM optical wireless remote flash control system.

Wireless Flash Control

The EF-X500 can act as a master flash using optical pulses to control flash mode and output for remote flash units in up to three groups (A, B, and C). Wireless flash control is available in TTL (📖 60), TTL output ratio selection (📖 64), manual (📖 68), and repeating flash (📖 71) modes.

The flash can control remote flash units in up to three groups (Figure 1), each of which can contain multiple flash units (Figure 2). The master flash can be included in any of the groups or set not to fire (📖 55). The channel for remote flash control can be chosen from channels 1–4. Separate channels can be used for different flash systems or to prevent interference when multiple systems are operating in close proximity.

Figure 1

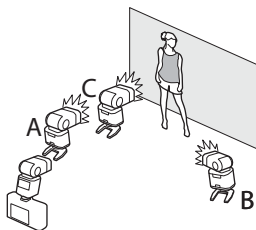
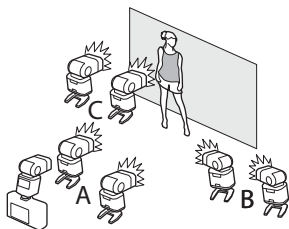

Figure 2



⚠️ Test-fire the flash or take a test shot before the main photo and add flash units if lighting is insufficient. Avoid placing objects where they might interfere with optical control between the master and remote units.

Placement and Range

Place the remote units within communications range of the master flash, which is shorter outdoors than indoors.

The example below shows a single remote unit with TTL flash control.

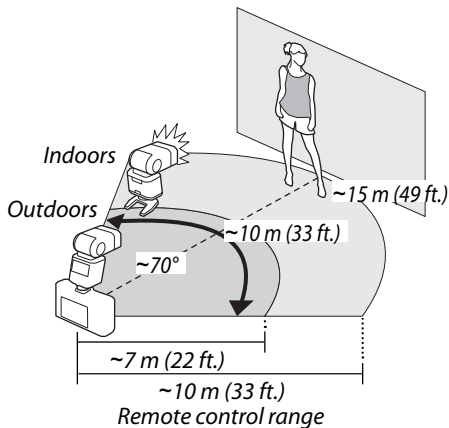

Use the supplied mini stand and rotate the flash heads to orient the remote units with the receivers facing the master flash. This may not be necessary indoors, where signals reflected from the walls may reach the receivers regardless of their orientation.

When placing remote units on stands or other metal objects, ensure that the metal does not touch the left side of the flash head. You may hear a loud report when the flash fires, but this does not indicate a malfunction.

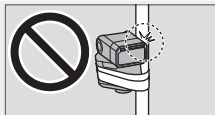

Remote Flash Units

Follow the steps below to configure the unit for use as a remote flash. You can use controls on remote units to choose the group (📖 50) and channel (📖 52) and make individual adjustments to flash compensation or output (📖 51).

- 1 Hold the power switch latch and rotate the switch to **REMOTE**.

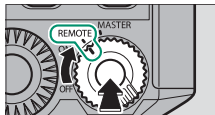

- 2 Use the supplied mini stand to orient the unit with the receiver facing the master flash.

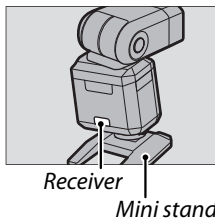

 Remote flash units are automatically set to the same flash mode as the master flash.

Group

Assign remote units to group A (**A**), B (**B**), or C (**C**). The flash mode and flash compensation or output for the units in each group can be selected using the master flash.

- 1 Press the page button until the **FLASH** page is displayed.

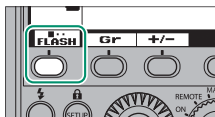

- 2 Press the **Gr** function button to highlight the group.

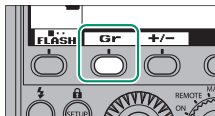

- 3 Rotate the command dial to choose a group and press **OK**. You can also select **P-MODE** or **N-MODE** to use the unit as a slave flash in full manual mode (📖 77).

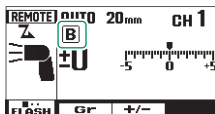
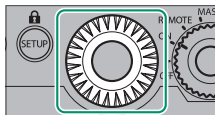
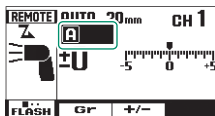

Flash Compensation/Output

Adjust flash compensation or flash output (units in group A, B, or C). The value for the current flash unit is added to that selected for the group as a whole and applies regardless of the flash control mode selected with the master flash, but note that only whole values can be selected with the master flash if individual adjustments are made to flash compensation on remote flash units.

- 1 Press the page button until the **FLASH** page is displayed.

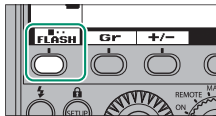

- 2 Press the **+/-** function button to highlight flash compensation/output.

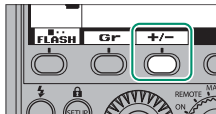

- 3 Rotate the command dial to choose the desired option and press **OK**.

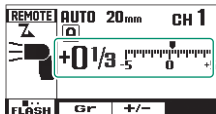
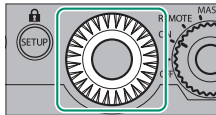
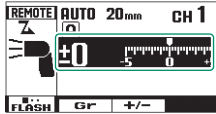

Channel

Choose the optical wireless channel (1, 2, 3, or 4) used for communication between the master and remote flash units. Separate channels can be used for different flash systems or to prevent interference when multiple systems are operating in close proximity; be sure the master flash is set to the same channel as the units you wish to control.

- 1 Press the page button until the **FLASH** page is displayed.

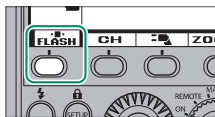

- 2 Press the **CH** function button to highlight the channel.

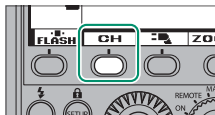

- 3 Rotate the command dial to choose the desired option and press **OK**.

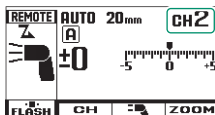
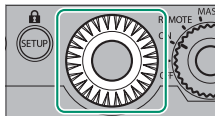
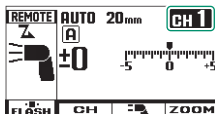

Remote Mode Options: Summary

Remote mode options are summarized below.

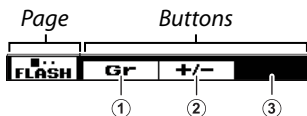

Page	Button	Function	Options	
	①	Gr (group)	A (group A), B (group B), C (group C), P-MODE (no pre-flash), N-MODE (normal)	50
	②	+/- (flash compensation/output)	-5 – +5 in 1/3 EV steps	51
	③	None	—	—
	①	CH (channel)	1–4	52
	②	(lighting)	(output priority), (normal), (coverage priority)	38
	③	ZOOM (coverage)	AUTO (coverage is automatically adjusted according to lens focal length), M (choose focal length between 24 and 105 mm in 35 mm-format equivalent; varies with camera)	39
	①	ON/OFF (LED video light on/off)	On, off	40
	②	(LED video light brightness)	1/4–1/28	41
	③	None	—	—

The Master Flash

The unit can be configured for use as a master flash as described below. You can choose the channel (📖 56) and whether to assign the master flash to a group or turn it off (📖 55).

To configure the unit for use as a master flash, hold the power switch latch and rotate the switch to **MASTER**.

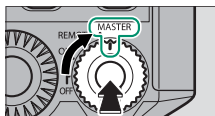

Group

Choose whether the master flash remains off or fires as part of group A, group B, or group C.

- 1 Press the page button until the **FLASH** page is displayed.

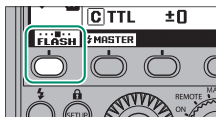

- 2 Press the **MASTER** function button to highlight the master group.

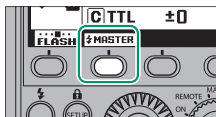

- 3 Rotate the command dial to choose the desired option and press **OK**. Choose **A**, **B**, or **C** to have the master flash fire as part of group A, B, or C, respectively, or **OFF** to turn the master flash off.

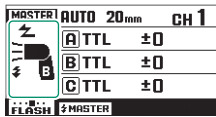
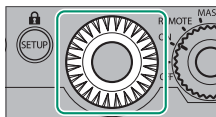
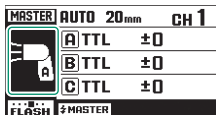

! Even when off, the master flash fires to control the remote flash units (optical flash control). The light used to control the remote units may be visible in the final picture under some conditions.

The master flash lighting icon (📖 38) is displayed with solid rather than dotted lines even when the master flash is off.

Channel

Choose the optical wireless channel (1, 2, 3, or 4) used for communication between the master and remote flash units. Separate channels can be used for different flash systems or to prevent interference when multiple systems are operating in close proximity; be sure the master flash is set to the same channel as the units you wish to control.

- 1 Press the page button until the **FLASH** page is displayed.

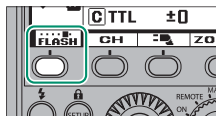

- 2 Press the **CH** function button to highlight the channel.

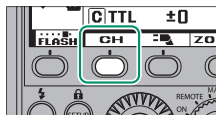

- 3 Rotate the command dial to choose the desired option and press **OK**.

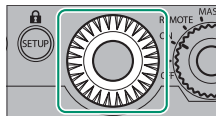





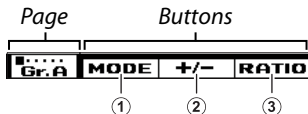







Master Mode Options: Summary

Master mode options are summarized below.



Page	Button	Function	Options	
■■■■■ Gr.A ■■■■■ Gr.B ■■■■■ Gr.C	①	MODE (flash control mode)	TTL, TTL%, M, Multi, OFF	60, 64, 68, 71
	②	+/- (flash compensation/output)	-5 – +5 in 1/3 EV steps (TTL and TTL% modes), 1/4 – 1/512 in 1/3 EV steps (mode M), or off or 1/4 – 1/512 in 1/3 EV steps (Multi mode)	61, 66, 69, 72
	③	RATIO (output ratio selection)	8:1 – 1:8 (TTL% only)	65
		TIME-Hz (number of flashes/frequency)	2 – 100 flashes, 1 – 500 Hz (Multi only)	73
■■■■■ FLASH	①	MASTER (group)	(group A), (group B) (group C), (off)	55
	②	None	—	—
	③	None	—	—

Page	Button	Function	Options	
	①	CH (channel)	1–4	56
	②	 (lighting)	 ,  (normal),  (coverage priority)	38
	③	ZOOM (coverage)	AUTO (coverage is automatically adjusted according to lens focal length), M (choose focal length between 24 and 105 mm in 35 mm-format equivalent; varies with camera)	39
	①	ON/OFF (LED video light on/off)	On, off	40
	②	 (LED video light brightness)	$\frac{1}{4}$ – $\frac{1}{128}$	41
	③	AF  (LED AF-assist lamp/catchlight)	   	42

Camera Controls

If the camera offers full support for the EF-X500 (📖 96), flash settings can be adjusted using camera controls. Camera controls can not be used to adjust flash settings when the unit is in remote mode.

Flash Setup

Flash settings can be adjusted using the **⚡ FLASH SETTING > FLASH FUNCTION SETTING** option in the camera shooting menu. See the camera manual for more information.

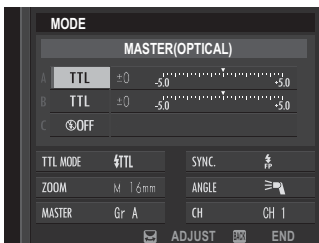

The **FLASH FUNCTION SETTING** menu for the X-T2

Taking Photographs

After configuring the remote (📖 49) and master (📖 54) units, use the master flash to choose a flash control mode and adjust settings.

TTL Mode

In TTL mode, overall flash output is automatically adjusted for optimal exposure.

- 1 After confirming that the master and remote units are set to the same channel (📖 52, 56), position the camera (master flash) and remote flash units (📖 48).
- 2 Press the page button to display the page for a group you want to fire in TTL mode.
- 3 Press the **MODE** function button to highlight the flash control mode.

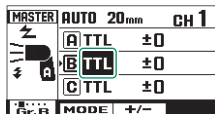
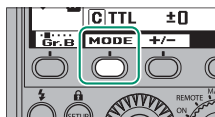
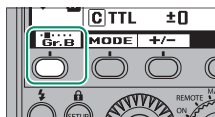
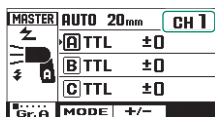

- 4 Rotate the command dial to select **TTL** and press **OK** to set all the units in the current group to TTL.

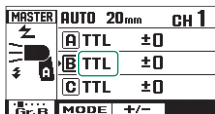
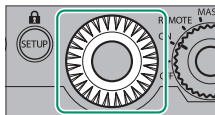

If you want the master flash to fire, assign it to a group (📖 55).

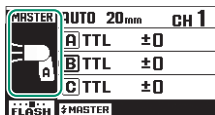

- 5 Press the **+/-** function button to highlight flash compensation.

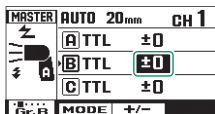
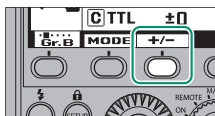

- 6 Rotate the command dial to choose the desired option and press **OK**.

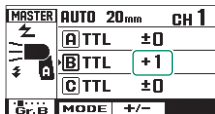
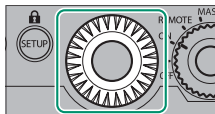

- 7 Confirm that the ready lamps on the master and remote units are lit. If desired, the LED video lights on the remote units can be set to light at the same time as the ready lamps (📖 83).

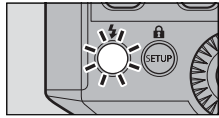

- 8 Press the ready lamp to test-fire the remote units. If the remote units do not fire, check that they are correctly positioned (📖 48).

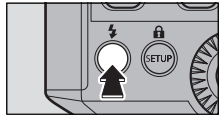



- 9 Press the camera shutter button to fire the flash units and take the picture. Add flash units if lighting is insufficient.

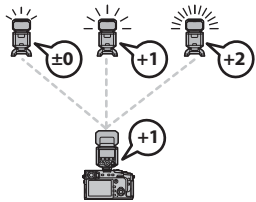

Remote Flash Compensation/Output

The flash compensation/output selected for the individual remote units in groups A, B, or C (📖 50) will be added to the amount selected for the group using the master flash (📖 51).



 When placing remote units, note that external light sources may interfere with their operation.

 You can test-fire the flash to preview the effects of the current flash setup (modeling flash). For information on choosing the role of the test button, see page 82 or the camera manual.

Units will enter standby mode if no operations are performed for a set period ( 84). Normal operation can be restored by pressing the test button; to reactivate all units, press the test-button on the master flash. If no operations are performed for an additional period after the units have entered standby mode, the units will turn off automatically, and can only be re-activated by rotating the power switch to **OFF** and then back again. The delay before the remote units enter standby mode or turn off automatically can be selected in the setup menu ( 85).

TTL Output Ratio Selection

In this mode, the flash units are divided into two groups (A and B), with the output of each group set as a percentage of the overall output, which is automatically adjusted for optimal exposure.

- 1 After confirming that the master and remote units are set to the same channel (📖 52, 56), position the camera (master flash) and remote flash units (📖 48).
- 2 Press the page button to display the page for group A or B.
- 3 Press the **MODE** function button to highlight the flash control mode.

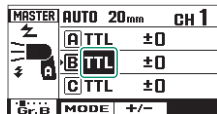
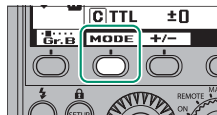
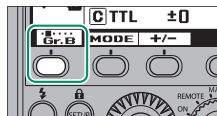
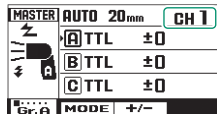

- 4 Rotate the command dial to choose **TTL%** and press **OK** to set all units in groups A and B to output ratio selection mode.

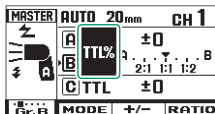
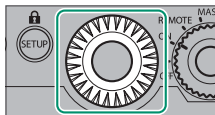

If you want the master flash to fire, assign it to a group (📖 55).

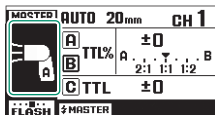

If you want to fire the units in group C, repeat Steps 2–4 to choose the flash control mode for group C, which can be either **TTL** or **M** (manual).

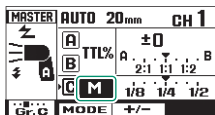
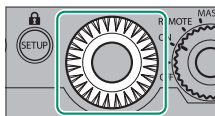

- 5 Press the **RATIO** function button to highlight the output ratio (if the group C page is displayed, first press the page button to return to the page for group A or B).

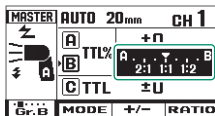
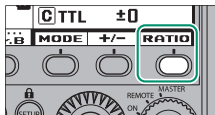

- 6 Rotate the command dial to choose the output ratio and press **OK**.

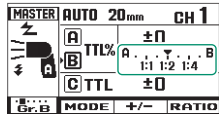
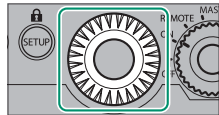

- 7 Press the **+/-** function button to highlight flash compensation.

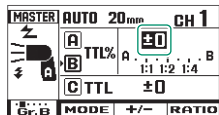
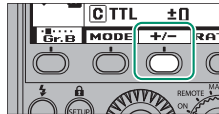

- 8 Rotate the command dial to choose the desired option and press **OK**.

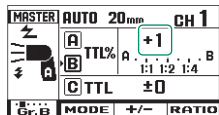
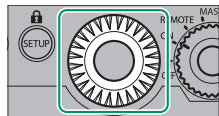

- 9 Confirm that the ready lamps on the master and remote units are lit. If desired, the LED video lights on the remote units can be set to light at the same time as the ready lamps (📖 83).

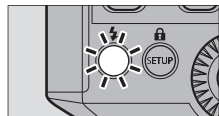

- 10** Press the ready lamp to test-fire the remote units. If the remote units do not fire, check that they are correctly positioned (📖 48).

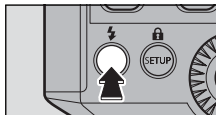

- 11** Press the camera shutter button to fire the flash units at the selected output ratio and take the picture. Add flash units if lighting is insufficient.

Remote Flash Compensation/Output

The flash compensation/output selected for the individual remote units in groups A, B, or C (📖 50) will be added to the amount selected for the group using the master flash (📖 51).

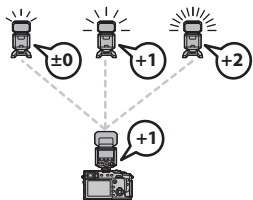

Manual Mode

Manually adjust flash output for one or more groups.

- 1 After confirming that the master and remote units are set to the same channel (📖 52, 56), position the camera (master flash) and remote flash units (📖 48).
- 2 Press the page button to display the page for a group you want to fire in manual mode.
- 3 Press the **MODE** function button to highlight the flash control mode.

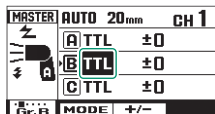
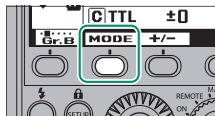
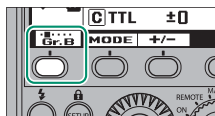
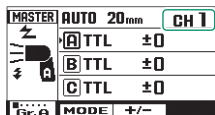

- 4 Rotate the command dial to choose **M** and press **OK** to set all the units in the current group to manual.

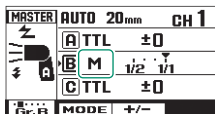
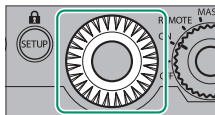

If you want the master flash to fire, assign it to a group (📖 55).

- 5 Press the **+/-** function button to highlight flash output.

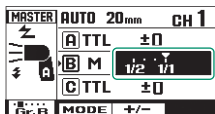
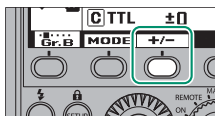
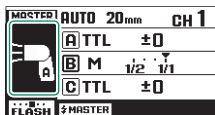

- 6 Rotate the command dial to adjust flash output and press **OK**.

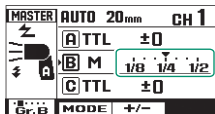
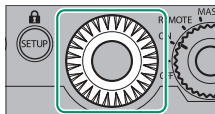

- 7 Confirm that the ready lamps on the master and remote units are lit. If desired, the LED video lights on the remote units can be set to light at the same time as the ready lamps (📖 83).

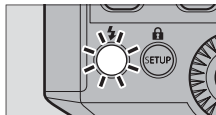

- 8 Press the ready lamp to test-fire the remote units. If the remote units do not fire, check that they are correctly positioned (📖 48).

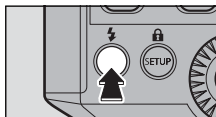

- 9 Press the camera shutter button to fire the flash units at the selected flash output and take the picture. Add flash units if lighting is insufficient.

Remote Flash Compensation/Output

The flash compensation/output selected for the individual remote units in groups A, B, or C (📖 50) will be added to the amount selected for the group using the master flash (📖 51).

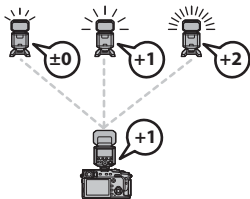

Repeating Flash

To use repeating flash (📖 33) with one or more groups:

- 1 After confirming that the master and remote units are set to the same channel (📖 52, 56), position the camera (master flash) and remote flash units (📖 48).
- 2 Press the page button to display the page for a group you want to fire in repeating flash mode.
- 3 Press the **MODE** function button to highlight the flash control mode.

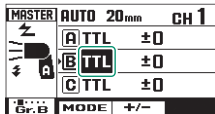
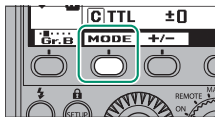
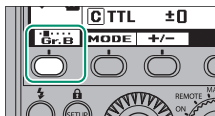
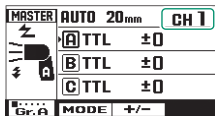

- 4 Rotate the command dial to choose **Multi** and press **OK** to set all the units in the current group to repeating flash mode.

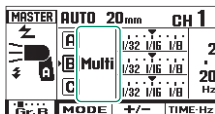
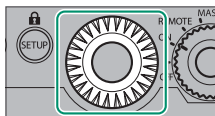

If you want the master flash to fire, assign it to a group (📖 55).

- 5 Press the **+/-** function button to highlight flash output.

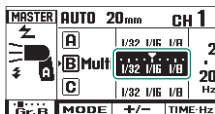
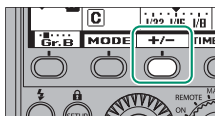
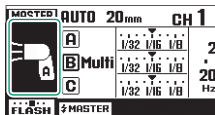

- 6 Rotate the command dial to adjust flash output and press **OK**.

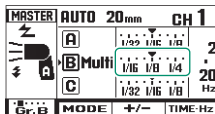
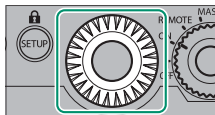

- 7 Press the **TIME-Hz** function button and rotate the command dial to choose the number of the times the flash will fire.

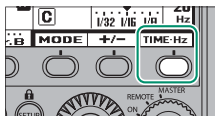

- 8 Press the **TIME-Hz** function button again and rotate the command dial to choose the flash frequency.

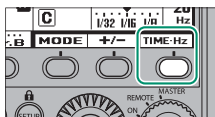
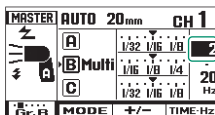

- 9 Press **OK** to proceed.

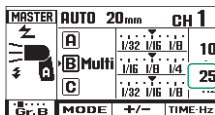
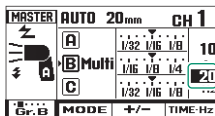

- 10 Confirm that the ready lamps on the master and remote units are lit. If desired, the LED video lights on the remote units can be set to light at the same time as the ready lamps (📖 83).

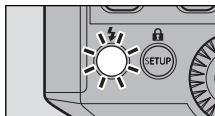

- 11** Press the ready lamp to test-fire the remote units. If the remote units do not fire, check that they are correctly positioned (📖 48).

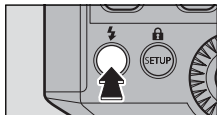

- 12** Press the camera shutter button to fire the flash units at the selected settings and take the picture. Add flash units if lighting is insufficient.

Remote Flash Compensation/Output

The flash compensation/output selected for the individual remote units in groups A, B, or C (📖 50) will be added to the amount selected for the group using the master flash (📖 51).

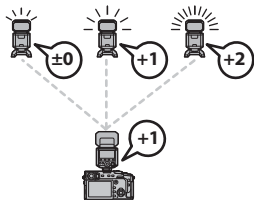

5

Slave Mode

This chapter describes how to use the flash with units that do not support the optical wireless control.

P and N (Slave) Modes

Setting the flash to a full manual remote slave mode (P or N) allows it to be slaved to an on-camera unit that does not support optical wireless control.

- 1 Hold the power switch latch and rotate the power switch to **REMOTE**.

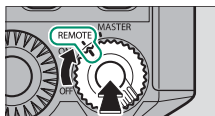

- 2 Press the page button until the **FLASH** page is displayed.

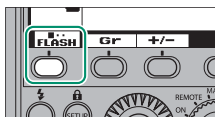

- 3 Press the **Gr** function button to highlight the group.

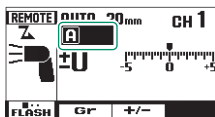
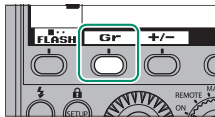

- 4 Rotate the command dial to choose a slave mode and press **OK**.

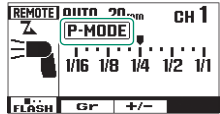
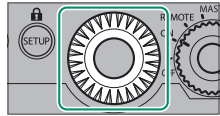

- **P-MODE** (no pre-flash): The unit ignores monitoring “pre-flash” pulses and fires only in response to the main flash. Choose this option if the master unit uses pre-flash pulses.
- **N-MODE** (normal): The unit fires in response to the first flash from the master unit. Choose this option if the master unit does not use pre-flash pulses.

Flash Output

To adjust the output of the slave unit:

- 1 Press the page button until the **FLASH** page is displayed.
- 2 Press the **+/-** function button to highlight flash output.
- 3 Rotate the command dial to choose the desired option and press **OK**.

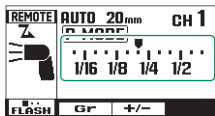
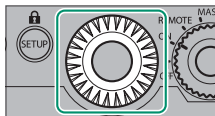
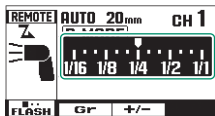
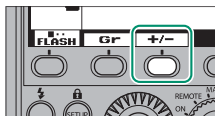
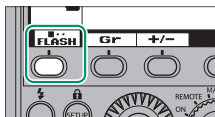

Setup 6

Read this chapter for information on the options in the flash setup menu.

The Setup Menu

The setup menu offers display options and other basic settings. It is available in all modes: single flash, master, and remote.

- 1 Press **SETUP**.

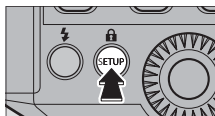

- 2 Rotate the command dial to highlight the desired item and press **OK**.

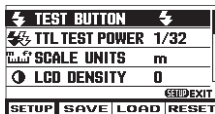
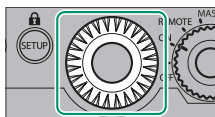

- 3 Rotate the command dial to highlight the desired option and press **OK**.

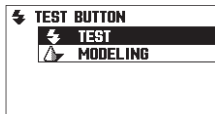
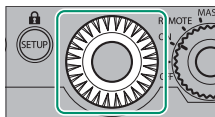



- 4 Press **SETUP** to exit the setup menu.

Asterisks (“*”) indicate default settings.



TEST BUTTON

Choose the role of the test button ( 18).

Option	Description
 TEST*	The test button test-fires the flash.
 MODELING	The test button fires a modeling flash.

TTL TEST POWER

Adjust test flash output in TTL mode.

Option	Description
 1/1	The flash fires at full power.
1/32*	The flash fires at $\frac{1}{32}$ nd of full power.
 1/128	The flash fires at $\frac{1}{128}$ th of full power.

SCALE UNITS

Choose whether distances are shown in meters or feet.

Option	Description
m METER*	Distances are shown in meters.
ft FEET	Distances are shown in feet.



LCD DENSITY

Adjust display contrast. Choose from five options between –2 and +2; the default setting is 0.

Asterisks (“*”) indicate default settings.



LCD ILLUMINATION

Adjust settings for the LCD backlight.

Option	Description
 ON	The backlight does not turn off while the flash is on.
15 15 SEC.*	The backlight remains on for 15 seconds after a control is used.
 OFF	Backlight off.



BEEP

Turn the beep speaker on or off.

Option	Description
 ON*	Beep speaker on. Examples of when a beep may sound include when charging is complete, a temperature warning is displayed, or a remote flash has fired at full power.
 OFF	Beep speaker off.

REMOTE READY INDICATOR



Choose how the unit shows charging status in remote mode.

Option	Description
 REAR+FRONT*	The LED video light and ready lamp light when charging is complete.
 REAR	The ready lamp lights when charging is complete.

Asterisks (“*”) indicate default settings.

SENSOR FORMAT

Choose the base camera sensor size used to calculate the focal lengths shown in the flash display.



Option	Description
 35 mm	Focal lengths are calculated in 35 mm format.
 AUTO*	Focal lengths are based on the size of the sensor for the camera to which the flash is currently attached.
 CUSTOM	Choose the sensor size manually.

CUSTOM SENSOR FORMAT

Choose the multiplier used to convert to 35 mm format when **CUSTOM** is selected for **SENSOR FORMAT**. The default is 1.00.

STANDBY

Choose the delay before the unit goes on standby ( 18) when used as a standalone flash.

Option	Description
2 2 min.	The unit goes on standby after 2 minutes of inactivity.
 SYSTEM AUTO*	The unit goes on standby at the same time as the camera, or after 2 minutes of inactivity if the unit is not mounted on a camera.
 DISABLED	The unit does not go on standby.

Asterisks (“*”) indicate default settings.

REMOTE STANDBY

Choose the delay before the unit goes on standby (📖 18) when functioning as a remote flash.

Option	Description
60 60 min.*	The unit goes on standby after 60 minutes of inactivity.
10 10 min.	The unit goes on standby after 10 minutes of inactivity.
🚫 DISABLED	The unit does not go on standby.

AUTO POWER OFF

Choose the delay before the unit turns off (📖 63) when functioning as a remote flash.

Option	Description
🔌 8 8h.*	The unit turns off after 8 hours.
🔌 1 1h.	The unit turns off after 1 hour.

Setting Save, Load, and Reset

7

This section describes how to save, load, and reset flash settings, including setup menu settings and the settings selected in **ON**, **REMOTE**, and **MASTER** modes.

Saving Settings

Changes to settings can be saved for later recall.

- 1 Adjust settings as desired (📖 81).
- 2 Press the **SETUP** button to display the setup menu.
- 3 Press the **SAVE** function button.

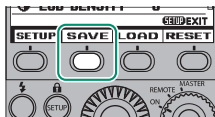

- 4 Rotate the command dial to highlight a slot and press **OK** to select (to exit to the setup menu without saving settings, select **CANCEL**).

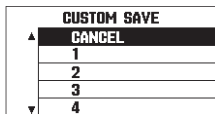
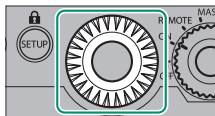

- 5 A confirmation dialog will be displayed; rotate the command dial to highlight **OK** and press the **OK** button. A progress dialog will be displayed, followed by the setup menu with current settings saved.

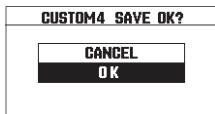
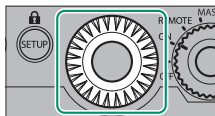

To change settings already saved to a given slot, repeat Steps 1–5, taking care in Step 4 to choose the slot to which the settings were saved.

Loading Settings

To recall saved settings:

- 1 Press the **SETUP** button to display the setup menu.
- 2 In the setup menu, press the **LOAD** function button.

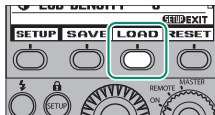

- 3 Rotate the command dial to highlight a slot and press **OK** to select (to exit to the setup menu without loading settings, select **CANCEL**).

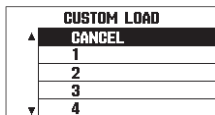
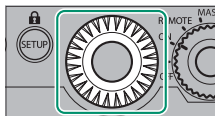

- 4 A confirmation dialog will be displayed; rotate the command dial to highlight **OK** and press the **OK** button. A progress dialog will be displayed, followed by the setup menu with the selected settings restored.

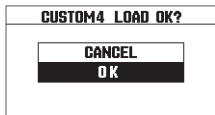
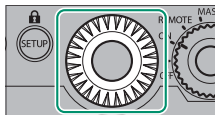

Restoring Default Settings

To restore settings to default values:

- 1 Press the **SETUP** button to display the setup menu.
- 2 In the setup menu, press the **RESET** function button.



- 3 A confirmation dialog will be displayed; rotate the command dial to highlight **OK** and press the **OK** button (to exit to the setup menu without performing a reset, select **CANCEL**). A progress dialog will be displayed, followed by the set-up menu with settings reset.

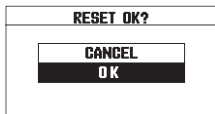
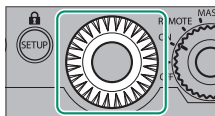

 Settings saved as described on page 87 are not affected and can be restored after settings have been reset.

Appendix 8

This chapter covers such topics as troubleshooting and specifications.

Troubleshooting/FAQ







Consult the table below should you encounter problems using your flash. If you don't find the solution here, contact your local FUJIFILM distributor.

Power and Battery

Problem	Solution
The flash does not turn on.	<ul style="list-style-type: none">• Reinsert the batteries in the correct orientation (📖 13).• Replace or recharge the batteries (📖 13).
The flash turns off unexpectedly.	<ul style="list-style-type: none">• The flash may be in standby mode (📖 18). Press the test button.• Check the battery level and replace or recharge the batteries if necessary (📖 13).





Single Flash Mode







Problem	Solution
The flash does not fire.	<ul style="list-style-type: none">• Confirm that the camera supports the EF-X500 (📖 96).• Confirm that the ready lamp is on or blinking (📖 18).• Confirm that the flash is correctly mounted and latched (📖 15).• If the flash or hot shoe contacts are dirty, clean them with a soft, dry cloth (📖 15).• Check camera settings. The flash will not fire if "off" is selected for flash mode, while if auto is selected it will fire only as required. Other settings may also prevent the flash firing. See the camera manual for details.

Problem	Solution
Pictures are too bright.	<ul style="list-style-type: none"> • Check camera exposure settings, including whether the limits of the camera exposure system have been exceeded. See the camera manual for details. • Reduce flash compensation (TTL mode;  29) or flash output (manual mode;  32). Note that in TTL mode, some subjects may appear bright due to their reflectivity or color. If reducing flash compensation does not have the desired effect, try moving away from the subject, reducing ISO sensitivity, or reducing aperture by choosing a higher f-number. See the camera manual for details.
Pictures are too dark.	<ul style="list-style-type: none"> • Check camera exposure settings, including whether the limits of the camera exposure system have been exceeded. See the camera manual for details. • Increase flash compensation (TTL mode;  29) or flash output (manual mode;  32). Note that in TTL mode, some subjects may appear dark due to their reflectivity or color. If increasing flash compensation does not have the desired effect, try moving closer to the subject or increasing ISO sensitivity. See the camera manual for details. • Pictures taken with the flash at shutter speeds faster than the camera flash sync speed may be underexposed. Choose a slower shutter speed as described in the camera manual.
Some areas of the frame are dark.	<ul style="list-style-type: none"> • When using the flash at shutter speeds faster than the camera flash sync speed, set the flash sync mode to FP auto as described in the camera manual. • Check whether shadows are being cast by the lens or lens hood. • Increase coverage ( 39). • For nearby subjects, tilt the flash head down 10° ( 23).

Problem	Solution
A loud noise is heard when the flash fires.	Ensure that the left side of the flash head does not touch metal objects, as otherwise a loud report may be heard when the flash is fired (📖 48). This does not indicate a malfunction.

Wireless Flash Photography

Problem	Solution
The camera does not display the flash setup menu.	<ul style="list-style-type: none"> • Confirm that the camera supports the EF-X500 (📖 96). • Confirm that the master flash is correctly mounted and latched (📖 15). • If the flash or hot shoe contacts are dirty, clean them with a soft, dry cloth (📖 15). • Check that the master flash power switch is rotated to MASTER (📖 17).
The flash displays  and settings can not be adjusted.	Use a camera that supports master mode.
Remote units do not fire.	<ul style="list-style-type: none"> • Confirm that the remote units are positioned where they can receive signals from the master flash (📖 48) and that their receivers are facing the master flash (📖 49). • Check battery levels and replace or recharge batteries as necessary (📖 13). • Check that the power switches on the remote units are rotated to REMOTE (📖 17). • Check group settings (📖 50). • The units may be in standby mode (📖 18). Press the test button on the master flash. • Confirm that the master and remote units are set to the same channel (📖 52, 56).
The master flash does not fire.	Select  (group A),  (group B), or  (group C) for MASTER (📖 55).

Problem	Solution
The master flash fires when off.	Even when  (off) is selected for  MASTER, the master flash still fires at low intensity to control the remote flash units ( 55).
Pictures are too bright.	<ul style="list-style-type: none"> • Check camera exposure settings, including whether the limits of the camera exposure system have been exceeded. See the camera manual for details. • Reduce flash compensation (TTL mode;  61) or flash output (manual mode;  69). Note that in TTL mode, some subjects may appear bright due to their reflectivity or color. If reducing flash compensation does not have the desired effect, try moving away from the subject, reducing ISO sensitivity, or reducing aperture by choosing a higher f-number. See the camera manual for details.
Pictures are too dark.	<ul style="list-style-type: none"> • Check camera exposure settings, including whether the limits of the camera exposure system have been exceeded. See the camera manual for details. • Increase flash compensation (TTL mode;  61) or flash output (manual mode;  69). Note that in TTL mode, some subjects may appear dark due to their reflectivity or color. If increasing flash compensation does not have the desired effect, try moving closer to the subject or increasing ISO sensitivity. See the camera manual for details. • Pictures taken with the flash at shutter speeds faster than the camera flash sync speed may be underexposed. Choose a slower shutter speed as described in the camera manual.

Battery Packs

Problem	Solution
The flash does not turn on.	<ul style="list-style-type: none"> • If the battery-pack ready lamp does not light, check that the batteries are fresh and correctly inserted. • Confirm that there are batteries in the flash unit and that they are fresh and correctly inserted ( 13).

Temperature/Battery Warnings

The following appear when the temperature of the unit rises:



The flash may be disabled to prevent overheating if it is fired multiple times in quick succession. Wait for the flash to cool or increase the interval between shots.



The flash has been disabled to prevent overheating. Wait until the indicator clears from the display before proceeding. Be sure not to resume use too soon: if you immediately proceed to fire the flash multiple times in quick succession, the warning will be displayed again and the flash will be disabled.



The temperature of the flash will rise more quickly if it is fired multiple times in quick succession.

The following indicates that the batteries are exhausted:



Batteries exhausted. Insert fresh or fully-charged batteries.

Specifications

System	
Type	
Type	Shoe-mounted external flash
Model	EF-X500
Supported cameras ¹	FUJIFILM X-T1, X-T2, X-Pro2; other X-series cameras with hot shoes and FinePix HS20EXR, HS30EXR, and HS50EXR support some functions
Flash head	
Max. guide number (ISO 100)	Approx. 50/164 (m/ft, 105 mm coverage) ²
Coverage	24 mm–105 mm with auto zoom, approx. 20 mm with built-in wide panel ²
Bounce angle	90° up, 10° down, 135° left, 180° right
Color temperature	Approx. 5,600 K when fired at full power
FP (high-speed sync)	Available with compatible cameras only
Exposure control	
Flash control modes	TTL, manual, repeating (manual)
Flash compensation	Up to ±5 EV in steps of 1/3 EV
Manual flash control	1/4–1/512 of full power in steps of 1/3 EV ³ ; combining low values with FP may result in output exceeding value selected
Repeating flash	1/4–1/512 of full power in steps of 1/3 EV ³
Charging (flash fired at full power with fresh NiMH batteries)	
Recycling time	Approx. 2.5 s
Number of uses	Approx. 170
Wireless flash control	
Type	Optical pulses
Wireless options	Master (TTL, manual, repeating, off), remote (TTL, manual, repeating, off)
Channels	1–4
Remote groups	Maximum 3 (A, B, and C)

System

Other features

Slave flash	Supported (P-MODE, N-MODE)
LED video light	Built-in
LED AF-assist/catchlight	Built-in
Catchlight panel	Built-in
Diffuser	Supplied

1. X-T1 and X-Pro2 require firmware update. Visit <http://www.fujifilm.com/sd/> for more information.
2. 35 mm format equivalent.
3. Selected value may not be reached depending on shooting conditions.

Other

Power source

On board	Four AA alkaline or NiMH batteries
External	Compatible with optional EF-BP1

Operating temperature –10 °C to +40 °C/+14 °F to +104 °F

Dimensions (H × W × D) Approx. 124.0 mm × 67.2 mm × 107.3 mm/
4.9 in. × 2.7 in. × 4.3 in.

Weight Approx. 380 g/13.5 oz., excluding batteries



Specifications subject to change without notice.

Guide Number (ISO 100/m)

Normal

Flash Output Level	Coverage (lens focal length in mm, 35 mm format/APS-C)									
	Wide Panel	24/16	28/18	35/23	50/33	70/46	80/53	85/56	90/59	105/69
1/1	14.9	25.0	27.1	33.1	42.8	46.7	48.0	48.8	49.5	50.5
1/2	10.6	17.7	19.1	23.4	30.3	33.0	33.9	34.5	35.0	35.7
1/4	7.5	12.5	13.5	16.5	21.4	23.4	24.0	24.4	24.8	25.3
1/8	5.3	8.8	9.6	11.7	15.1	16.5	17.0	17.3	17.5	17.9
1/16	3.7	6.2	6.8	8.3	10.7	11.7	12.0	12.2	12.4	12.6
1/32	2.6	4.4	4.8	5.9	7.6	8.3	8.5	8.6	8.8	8.9
1/64	1.9	3.1	3.4	4.1	5.4	5.8	6.0	6.1	6.2	6.3
1/128	1.3	2.2	2.4	2.9	3.8	4.1	4.2	4.3	4.4	4.5
1/256	0.9	1.6	1.7	2.1	2.7	2.9	3.0	3.1	3.1	3.2
1/512	0.7	1.1	1.2	1.5	1.9	2.1	2.1	2.2	2.2	2.2

FP

Flash Output Level	Coverage (lens focal length in mm, 35 mm format/APS-C)									
	Wide Panel	24/16	28/18	35/23	50/33	70/46	80/53	85/56	90/59	105/69
1/1	4.9	8.2	8.9	10.9	14.1	15.4	15.8	16.1	16.3	16.7
1/2	3.5	5.8	6.3	7.7	10.0	10.9	11.2	11.4	11.5	11.8
1/4	2.5	4.1	4.5	5.5	7.1	7.7	7.9	8.1	8.2	8.3
1/8	1.7	2.9	3.2	3.9	5.0	5.4	5.6	5.7	5.8	5.9
1/16	1.2	2.1	2.2	2.7	3.5	3.9	4.0	4.0	4.1	4.2
1/32	0.9	1.5	1.6	1.9	2.5	2.7	2.8	2.8	2.9	2.9

Guide numbers in the above tables are for when the EF-X500 is used with a X-Pro2 camera with a 1/500 sec. shutter speed.

FUJIFILM

FUJIFILM Corporation

7-3, AKASAKA 9-CHOME, MINATO-KU, TOKYO 107-0052, JAPAN

http://www.fujifilm.com/products/digital_cameras/index.html