

# Solutions to the 3D Model Problem of Pressure Measurement in the Area of Maxillary Sinus Anastomosis

Alina Nechyporenko<sup>a,b</sup>, Viktor Reshetnik<sup>b</sup>, Denys Shyian<sup>c</sup>, Victoriia Alekseeva<sup>c</sup>, Radiy Radutny<sup>d</sup> and Vitaliy Gargin<sup>c</sup>

<sup>a</sup> *Technical University of Applied Sciences University Technische Hochschule Wildau Hochschulring 1, Wildau 115745 Germany*

<sup>b</sup> *Kharkiv National University of Radio Electronics, 14 Nauky Ave., Kharkiv, 61166, Ukraine*

<sup>c</sup> *Kharkiv National Medical University, 4 Nauky Ave., Kharkiv, 61022, Ukraine*

<sup>d</sup> *National Aviation University 1 Liubomyra Huzara Ave., Kyiv 03058, Ukraine*

## Abstract

The ostiomeatal complex (OMC) is a key area that determines the occurrence of inflammatory processes in the paranasal sinuses (PNSs). The aim of our work was to develop a procedure for studying the OMC components in the preoperative period that allows for identification the impact of anatomical peculiarities on change of physiological pressure in the maxillary sinus. **Materials and methods:** The study was carried out on the basis of the otorhinolaryngological department of Kharkiv Regional Clinical Hospital in 2019-2020. It involved 100 patients of both sexes aged 20-59 years with chronic non-polyposis maxillary sinusitis. **Results:** The sizes of the uncinat process, the middle turbinate and the natural anastomosis were determined using the calculation of uncertainty. Basing on the data obtained, all the patients were divided into **three groups**. **Conclusions:** Changes in the size of the natural anastomosis (both an increase and its narrowing) lead to changes in pressure in the area of the anastomosis, and a decrease in ventilation in the paranasal sinuses. SCT study with subsequent 3D modeling is an informative, accurate and effective method for assessment of OMC and PNSs condition. It allows surgeons to presume the method and volume of surgery as early as at the preoperative stage, without resorting to invasive research methods.

## Keywords 1

Ostiomeatal complex, pressure, 3D Model

## 1. Introduction

The ostiomeatal complex (OMC) is a key area that determines the possibility of inflammatory processes in the paranasal sinuses (PNSs) [1, 2]. The anatomical features of this area determine aerodynamic disturbances, decreased ventilation of the sinuses and, consequently, stagnation with subsequent involvement of bacterial, fungal or mixed microflora [3, 4]. Since the OMC components are difficult to access for examination, the main method for assessing their condition is spiral computed tomography (SCT) [5, 6]. Taking into account the variety of options for the location of the OMC components, the complexity of their spatial configuration, use SCT images without further construction of a 3D model can lead to diagnostic errors due to the assessment of objects located in the same plane [7, 8]. It was defined that 3D modeling with the construction of a 3D model of the specified anatomical region gives scientists more information. This method can accurately, quickly, effectively and correctly describe all the variants of the location of the OMC components, namely, the uncinat process [9, 10].

---

IDDM'2020: 3rd International Conference on Informatics & Data-Driven Medicine, November 19–21, 2020, Växjö, Sweden  
EMAIL: nechyporenko@th-wildau.de (A. Nechyporenko); viktor.reshetnik@nure.ua (V. Reshetnik); den.shyian@gmail.com (D. Shyian); vik13052130@i.ua (V. Alekseeva); radiy@yahoo.com (R. Radutny); vitgarg@ukr.net (V. Gargin). Month October, 2020, Kharkiv, Ukraine  
ORCID: 0000-0002-4501-7426 (A. Nechyporenko); 0000-0002-8021-4310 (V. Reshetnik); 0000-0002-3755-7051 (D. Shyian); 0000-0001-5272-8704 (V. Alekseeva); 0000-0001-6339-5909 (R. Radutny); 0000-0001-8194-4019 (V. Gargin).



© 2020 Copyright for this paper by its authors.  
Use permitted under Creative Commons License Attribution 4.0 International (CC BY 4.0).  
CEUR Workshop Proceedings (CEUR-WS.org)

In addition, there are invasive methods to determine the ventilation efficiency of the PNSs [11, 12]. In particular, one of the methods involves intraoperative placement of a sensor in the area of the natural anastomosis of the maxillary sinus, which allows surgeons to measure the pressure in this area and make a conclusion about the risk of developing inflammatory processes [13, 14]. Despite all the information content and accuracy, this assessment method has some significant drawbacks. Since the sensor is installed intraoperatively, it is impossible to calculate the indicators characterizing the efficiency of sinus ventilation in the preoperative period and hence to predict the volume of the operation. Alternatively, there is a need for additional intervention in order to install the sensor, which is associated with inconveniences for both the doctor and the patient [15, 16]. The second important disadvantage is the invasiveness of the procedure.

Nowadays, there are a large number of studies devoted to 3D modeling both by SCT [17], and MRI [18]. There are even comparative characteristics between the 3D model and SCT images [19] or 3D images and examination with endoscopic surgery [20, 21].

Compared with the others, the current study makes use of approach based on the calculation of uncertainty. Moreover, the pattern of pressure in the maxillary sinus has been studied by many researchers. In most cases it was associated with the study of the patency of the maxillary fistula in determining the indications for surgery or was a criterion for the time course of treatment [10].

Our study involves a unique approach due to calculation of parameters with uncertainty, which enables to perform all the measurements of OMC components in a more effective way as well as decrease the amount of errors.

**The aim** of current work was the development of a procedure for studying the characteristics of OMC components in the preoperative period that enable to determine the influence of anatomical peculiarities on alteration of physiological pressure in the maxillary sinus.

## 2. Materials and Methods

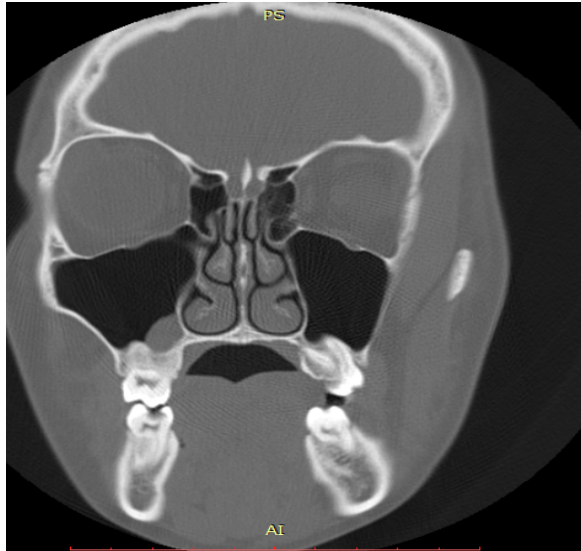
The study was conducted at the otorhinolaryngological department of Kharkiv Regional Clinical Hospital in 2019-2020. 100 patients of both sexes aged 20-59 years (see Table 1) with chronic non-polyposis maxillary sinusitis (cyst of the maxillary sinus) participated in the experiment.

**Table 1** Distribution of patients under investigation by age and sex

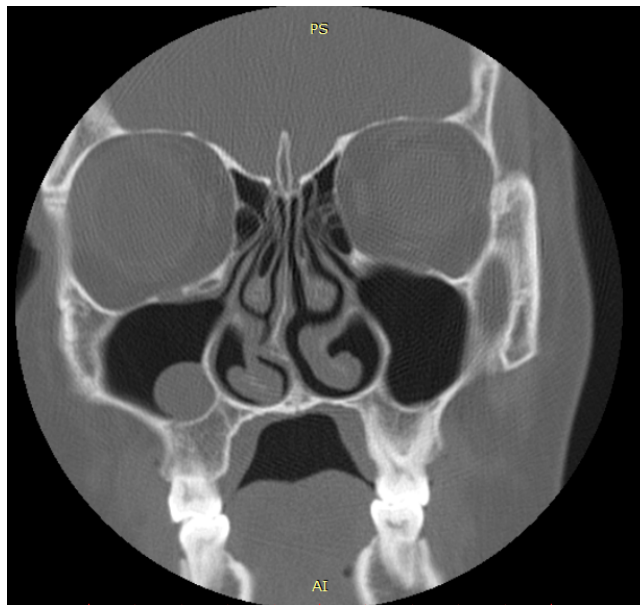
Patient Group	Male	Female
20-44	19	29
45-59	22	30
Total	41	59

In order to exclude the odontogenic origin of inflammatory process, the patients were consulted by a maxillofacial surgeon. All patients in the preoperative period underwent a CT scanning. This implied application of a spiral computed tomograph Toshiba Aquilion 64 CT Scanner, a multi-slice CT scanner with the ability to simultaneously collect data from 64 slices 0.5 mm thick and featuring high performance characteristics with a full turnover time of up to 0.4 s.

The data obtained were studied using the RadiAnt DICOM Viewer software. 3D models were built in the Artec Studio 14 application, which characterized by high accuracy, fast image quality control, improved color reproduction and automatic glare removal. After examination of the SCTs (see Fig. 1-3). 3D models of all the examined patients were rendered (see Fig. 4). Attention was paid to such basic OMC parameters as the middle turbinate, the uncinat process and the size of the natural anastomosis (see Figure 1). Due to the diversity of the data obtained, some difficulties are presented by the choice of reference points for measuring the width of the indicated anatomical structures. In this regard, the same technique which was successfully used in our previous studies to measure both the OMC structures and the indicators of the length and density of the walls of the PNSs was applied. [11, 12]. This technique implies calculating the uncertainty of these indicators.

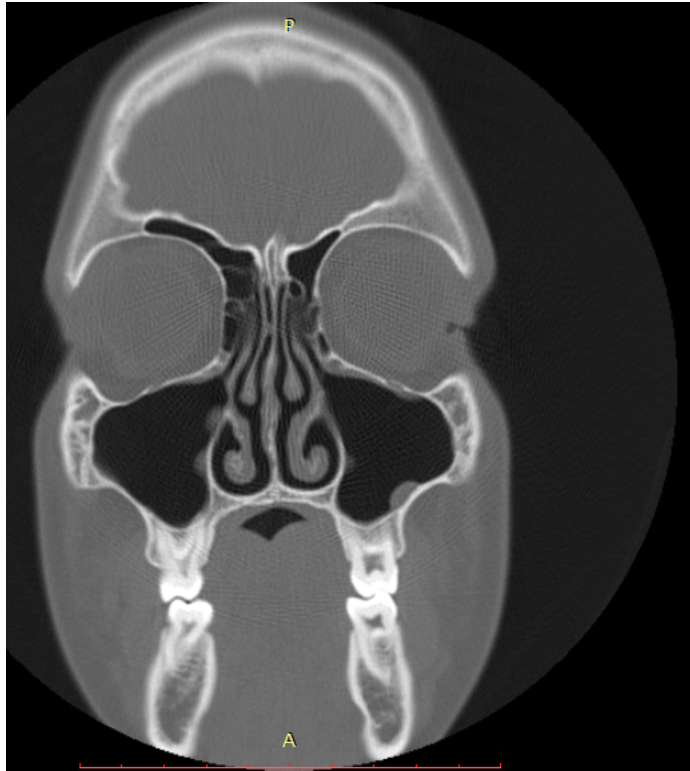


**Figure 1:** Group 1 patient SCT. Coronary section. OMC

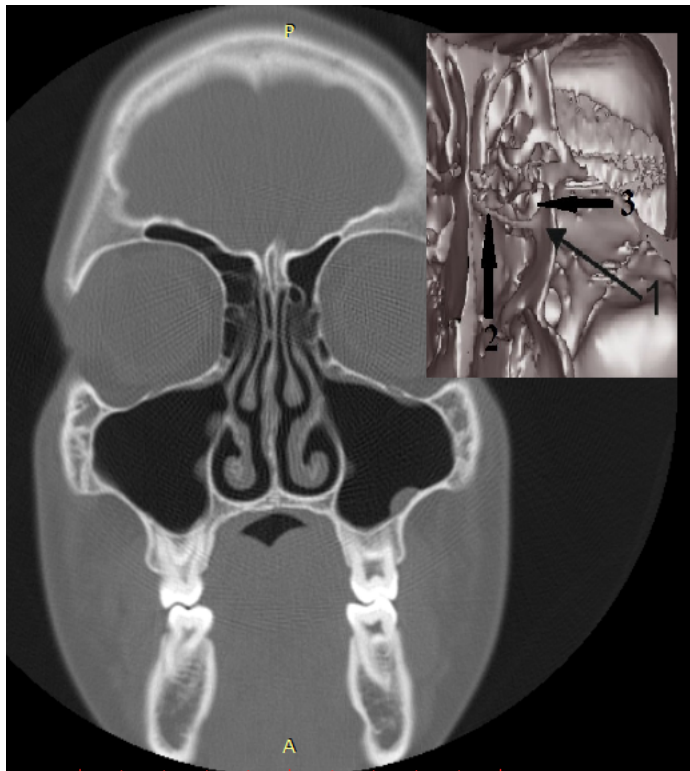


**Figure 2:** Group 1 patient SCT. Coronary section. OMC

Measurement uncertainty is an internationally recognized feature of measurement inaccuracy [13], pertaining to the measurement result and identifying the set of values which can be logically assigned to the measured quantity [14]. All constituents of the uncertainty of the input quantities are classified into two categories according to the method of their assessment: category A involves constituents that are assessed using statistical methods (according to the results of multiple measurements), and category B implies constituents that are evaluated otherwise (in agreement with features stated in the specification of the measuring instrument, the calibration certificate, the measurement methodology, the preliminary tests, etc.).



**Figure 3:** Group 3 patient SCT. Coronary section. OMC



**Figure 4:** Group 3 patient with 3 D OMC modeling (1 – uncinated process, 2 – middle nasal concha, 3 – anastomosis)

### 3. Results

The results of calculation using the basic algorithm developed in our previous works [11-12] are presented in Tables 2-4.

**Table 2** OMC components dimensions in the first group of patients

Uncertainty indicator	Parameter under study					
	Uncinated process		Middle nasal concha		Natural anastomosis	
	Max	Min	Max	Min	Max	Min
$U_A$	0.084	0.079	0.258	0.119	0.065	0.101
$U_B$	0.000003	0.0000012	0.0000039	0.000001	0.0000022	0,0000016
$U_s$	0.0843	0.079	0.2584	0.1195	0.065	0.1008
$U_{ex}$	0.1687	0.1584	0.5168	0.2389	0.1301	0.2015

**Table 3** OMC components dimensions in the second group of patients

Uncertainty indicator	Parameter under study					
	Uncinated process		Middle nasal concha		Natural anastomosis	
	Max	Min	Max	Min	Max	Min
$U_A$	0.065	0.121	0.089	0.099	0.117	0.090
$U_B$	0.0000021	0.0000012	0.0000023	0,0000013	0,0000034	0,0000027
$U_s$	0.065	0.1212	0.0891	0.0991	0.1170	0.0904
$U_{ex}$	0.13	0.2424	0.1781	0.1982	0.2339	0.1809

**Table 4** OMC components dimensions in the third group of patients

Uncertainty indicator	Parameter under study					
	Uncinated process		Middle nasal concha		Natural anastomosis	
	Max	Min	Max	Min	Max	Min
$U_A$	0.055	0.126	0.075	0.121	0.058	0.132
$U_B$	0.0000026	0.0000013	0.0000028	0.0000016	0.0000029	0.0000020
$U_s$	0.0549	0.1264	0.0747	0.1211	0.0577	0.1320
$U_{ex}$	0.1098	0.2528	0.1494	0.2423	0.1153	0.2641

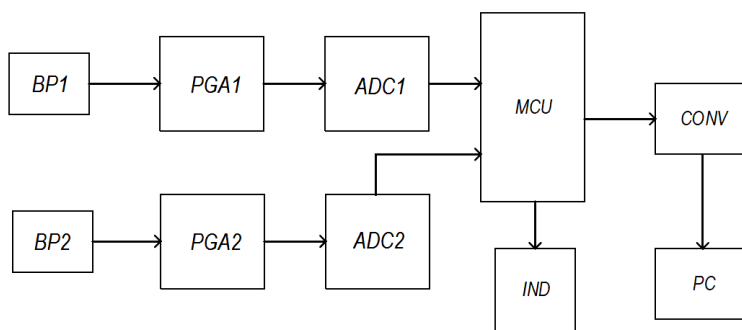
After a preliminary investigation of the SCT, patients were recommended to undergo surgical treatment in the volume of endoscopic removal of the maxillary sinus cyst, during which the pressure in the maxillary sinus area was measured

Pressure measurements were carried out using the developed hardware-software system "Imed". Functionally, the hardware-software system consists of a measuring and software modules. It is shown in Fig. 5.

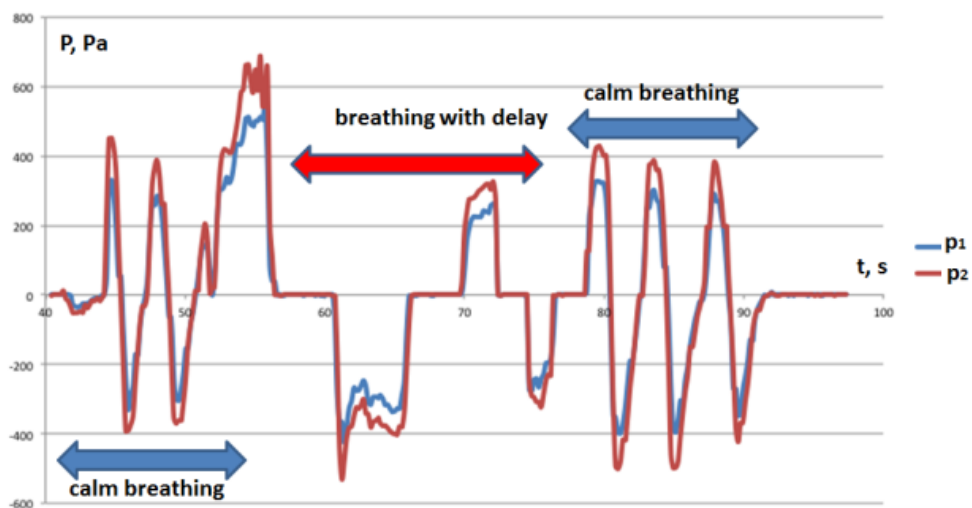
Differential pressure measurement range  $\pm 7000$  Pa, displayed range  $\pm 1200$  Pa, sampling frequency of measuring channels scanning 200 Hz, bandwidth 1 kHz, limits of permissible reduced error when measuring pressure do not exceed  $\pm 0.25\%$ , supply voltage 5 V, power consumption less 2 W, protection class IP20. The measured values during the study are the air flow pressure in the maxillary sinus and nasopharynx. The measured signals are recorded synchronously. The block diagram of the measuring module is shown in Fig. 6. Graphs of the average pressure are presented in Fig. 7-9.



**Figure 5:** Measuring module of the hardware-software complex "Imed"

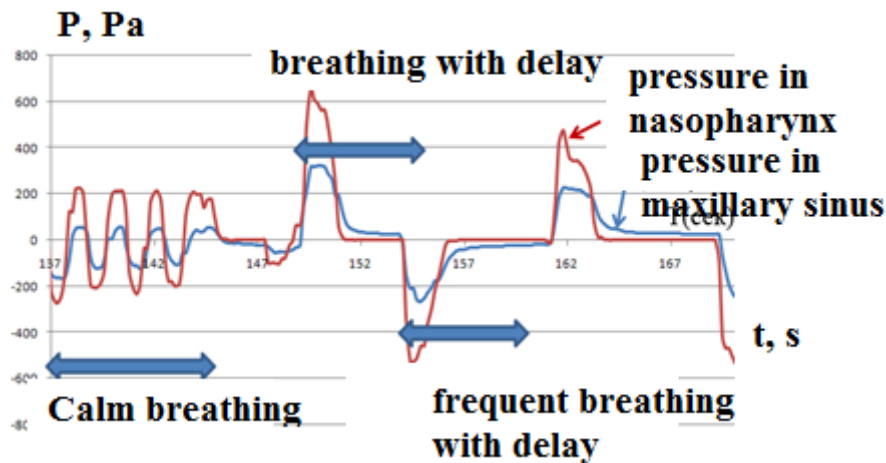


**Figure 6:** Block diagram of the measuring module of the hardware-software complex "Imed"

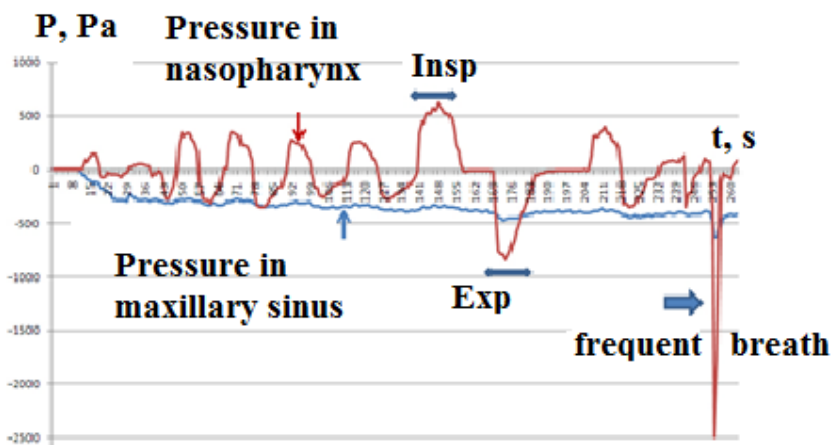


**Figure 7:** Graph of the average pressure in the anastomosis in Group 1 patients





**Figure 8:** Graph of the average pressure in the anastomosis in Group 2 patients



**Figure 9:** Graph of the average pressure in the anastomosis in Group 3 patients

Morphometry is crucial for obtaining correct data in contemporary medicine [15] with adequate mathematical support [16]. It could be used for the description of morphological images [17] with compound simulation [18,19] in paranasal area [20,21].

Thus, the data obtained in the experiment allow us, as early as at the preoperative stage, to assume the features of sinus ventilation of every patient without additional examination. It means that the volume of the surgery and possible postoperative risks can be determined in advance. [22].

Until recently, the pressure indicator in the maxillary sinus has been taken into account mainly during implantation [23, 24] due to the employment of hydraulic pressure for these purposes.

This study for the first time has involved a simultaneous estimation of the pressure in the maxillary sinus and the anatomical structure of the OMC, caused by it. A group of patients (Group 3) has been found to have “critical” indicators of the size of the middle turbinate, the uncinat process and the natural anastomosis with decreased pressure in the sinus, entailing hypoventilation with the possible development of an inflammatory process.

In addition, it should be noted that the pressure indicator is very sensitive to the size of the anastomosis. Even a slight expansion or narrowing of the natural communication between the sinus and the nasal cavity leads to changes in pressure in the sinus. This fact should be taken into account during surgical interventions.

An interesting fact is that the large anastomosis also does not provide adequate ventilation of the sinus. Most likely, this can be explained by the absence of a turbulent air flow in the sinus, which also leads to its hypoventilation and increases the risk of bacterial or fungal microflora attachment.

Moreover, for the first time, 3D modeling has been used to calculate the values of indicators, which most accurately reflect not only the main parameters of the structure, but also the entire complexity of their spatial configuration. In addition, the creation of a 3D model will be useful for training medical personnel. They will be able to perform surgical interventions with different variants of the structure of the BMC as well as various manipulations on its components (resections, plastic, reconstructive operations on the uncinate process, middle turbinate). Further perspectives of current study are the development of multifunctional and user-friendly system for image assessment [25], as well as augmentation model for training [26] and web-application for decision-making in ENT surgery [27].

Thus, the research supplemented and combined our previous studies and new data which were obtained [28, 29,30] with processing in patients of different age and gender [31].

#### 4. Conclusion

Alterations in dimensions of the natural anastomosis (both an increase and its narrowing) lead to oscillations in pressure in the area of the anastomosis, and decrease in ventilation in the paranasal sinuses. It is recommended to integrate the SCT study based on 3D modeling to a medical practice as an informative, accurate and effective method for assessment of OMC and PNSs condition. It will enable medical doctors to optimize the surgical planning and avoid the invasive examination.

#### 5. References

- [1] S. Johnson, A. Honeybrook, V. Ramprasad, R. Abi Hachem, D. Jang, Radiodensity of the Ostiomeatal Complex in Recurrent Acute Rhinosinusitis, *Otolaryngol Head Neck Surg* 157(5) (2017) 887-890. doi: 10.1177/0194599817717682.
- [2] G. Güngör, N. Okur, E. Okur, Uncinate Process Variations and Their Relationship with Ostiomeatal Complex: A Pictorial Essay of Multidetector Computed Tomography (MDCT) Findings, *Pol J Radiol* 81 (2016) 173-80. doi: 10.12659/PJR.895885.
- [3] G. Minenkov, V. Nasyrov, I. Islamov, N. Solodchenko, O. Skorobogatova, The modern possibilities for the application of multispiral computed tomography in diagnostics of paranasal sinuses mycetomas, *Vestn Otorinolaringol.* 82(3) (2017) 22-24. doi: 10.17116/otorino201782322-24.
- [4] A. Alrasheed, L. Nguyen, L. Mongeau, R. Funnell, M. Tewfik, Development and validation of a 3D-printed model of the ostiomeatal complex and frontal sinus for endoscopic sinus surgery training, *Int Forum Allergy Rhinol*, 7(8) (2017) 837-841 doi: 10.1002/alr.21960.
- [5] T. Hsieh, B. Cervenka, R. Dedhia, R., et al, Assessment of a Patient-Specific, 3-Dimensionally Printed Endoscopic Sinus and Skull Base Surgical Model. *JAMA, Otolaryngol Head Neck Surg.*144(7) (2018) 574-579.
- [6] J. Chen, A. Prem, G. Yang, D. Cui, Use Stereoscopic Model in Interventional and Surgical Procedures, *Adv Exp Med Biol.* 1205 (2019) 11-24. DOI: 10.1007/978-3-030-31904-5\_2.
- [7] X. Zhang, Z. Li, Z. Wu, W Lin, J. Lin, L Zhuang,. A novel three-dimensional-printed paranasal sinus-skull base anatomical model, *Eur Arch Otorhinolaryngol* 275(8) (2018) 2045-2049. doi: 10.1007/s00405-018-5051-z. Epub 2018 Jun 29
- [8] S. Barber, S. Jain, Y. Son, E. Chang, Virtual Functional Endoscopic Sinus Surgery Simulation with 3D-Printed Models for Mixed-Reality Nasal Endoscopy, *Otolaryngol Head Neck Surg.* 159(5) (2018) 933-937. doi: 10.1177/0194599818797586.
- [9] D Chumachenko, V. Balitskii, T. Chumachenko, V. Makarova, M. Railian, Intelligent expert system of knowledge examination of medical staff regarding infections associated with the provision of medical care, *CEUR Workshop Proceedings.* 2386 (2018) 321-330.



- [10] S. Coemert, L. Veith, G. Strauss, P. Schmitz, T. Lueth, Anatomical Characterization of Frontal Sinus and Development of Representative Models, in: Proc Conf Proc IEEE Eng Med Biol Soc, 2019, pp. 6113-6117.
- [11] A. Nechyporenko, V. Reshetnik, V. Alekseeva, N. Yurevych, R. Nazaryan, V. Gargin, Implementation and analysis of uncertainty of measurement results for lower walls of maxillary and frontal sinuses, in: Proc. IEEE 40th International Conference on Electronics and Nanotechnology (ELNANO), Kyiv, Ukraine, 2020, pp. 460-463. doi: 10.1109/ELNANO50318.2020.9088916.
- [12] A. Nechyporenko, V. Reshetnik, V. Alekseeva, N. Yurevych, R. Nazaryan, V. Gargin, Assessment of Measurement Uncertainty of the Uncinated Process and Middle Nasal Concha in Spiral Computed Tomography Data, in: Proc. Problems of Incommunications Science and Technology (PIC S and T), Kyiv, Ukraine, 2019, pp. 584-587. doi: 10.1109/PICST47496.2019.9061557.
- [13] Guidance for the use of repeatability, reproducibility and trueness estimates in measurement uncertainty evaluation, ISO Standard 21748 (2017).
- [14] D. Chumachenko, I. Meniailov, K. Bazilevych, T. Chumachenko, On intelligent decision making in multiagent systems in conditions of uncertainty, in: Proc 11th International Scientific and Practical Conference on Electronics and Information Technologies, ELIT 2019 - Proceedings, Kyiv, Ukraine, 2019, pp.150-153. doi:10.1109/ELIT.2019.8892307.
- [15] Y. Kuzmina, G. Hubina-Vakulik, G. Burton, Placental morphometry and doppler flow velocimetry in cases of chronic human fetal hypoxia, European Journal of Obstetrics and Gynecology and Reproductive Biology 120(2) (2005) 139-145. doi:10.1016/j.ejogrb.2004.09.001
- [16] A. Schenström, S. Rönberg, O. Bodlund, Mindfulness-based cognitive attitude training for primary care staff: A pilot study, Complement Health Pract Rev 11(3) (2006) 144-52.
- [17] M. Lyndin, N. Gluschenko, V. Sikora, Yu. Lyndina, N. Hyryavenko, G. Tkach, V Kurochkina, A Romaniuk, Morphofunctional features of articular cartilage structure, *Folia Medica Cracoviensia* 59(3) (2019) 81-93.
- [18] Y. Polyvianna, D. Chumachenko, T. Chumachenko, Computer aided system of time series analysis methods for forecasting the epidemics outbreaks, Paper presented at the 2019 15th International Conference on the Experience of Designing and Application of CAD Systems, CADSM 2019 - (2019) Proceedings doi:10.1109/CADSM.2019.8779344.
- [19] D. Chumachenko, T. Chumachenko, Intelligent agent-based simulation of HIV epidemic process, Adv Intell Sys Comput 1020 (2020) 175-188. doi: 443.webvpn.fjmu.edu.cn/10.1007/978-3-030-26474-1\_13.
- [20] R. Nazaryan, L. Kryvenko, Salivary oxidative analysis and periodontal status in children with atopy, Intervent. Med Appl Sci 9(4) (2017) 199-203. doi: 10.1556/1646.9.2017.32.
- [21] S. Krivenko, A. Pulavskiy, S. Krivenko, L. Kryvenko, Many-To-Many Linear-Feedback Shift Model for Training of Artificial Neural Network in Dentistry, in: 2019 IEEE 39th International Conference on Electronics and Nanotechnology, ELNANO, Proceedings 8783543, 2019, pp. 429-434. doi: 10.1109/ELNANO.2019.8783543..
- [22] D. Avetikov, O. Bukhanchenko, I. Ivanytskyi, V. Aipert, D. Steblovskiy, Perspectives for applying the additional study methods for diagnostics optimization of postoperative hypertrophic scars of the head and neck, *Wiad Lek.* 71(3 pt 1) (2018) 470-473.
- [23] Bhandari, S., Thomas, R., Kumar, T., Shah, R., Mehta D. Maxillary Sinus Augmentation Using Hydraulic Pressure by Lateral Approach and Simultaneous Implant Placement: Clinicoradiographic Study. *Implant Dent* 28(5):514-519 (2019). doi: 10.1097/ID.0000000000000911.
- [24] Gatti, F., Gatti, C., Tallarico, M., Tommasato, G., Meloni, S., Chiapasco, M. Maxillary Sinus Membrane Elevation Using a Special Drilling System and Hydraulic Pressure: A 2-Year Prospective Cohort Study 38(4):593-599 (2018). doi: 10.11607/prd.3403.
- [25] S. Wienert, D. Heim, M. Kotani, B. Lindequist, A. Stenzinger, M. Ishii, P. Hufnagl, M. Beil, M. Dietel, C. Denkert, C. Klauschen, CognitionMaster: an object-based image analysis framework. *Diagn Pathol* 8 (2013) 34.
- [26] V.M Bezruk., S.A Krivenko., L.S Kryvenko, T. Radivilova, D. Ageyev, N Kryvinska, (2021) Galois Field Augmentation Model for Training of Artificial Neural Network in Dentistry, in:

Data-Centric Business and Applications. Lecture Notes on Data Engineering and Communications Technologies, volume 48. Springer, Cham 2021. doi:10.1007/978-3-030-43070-2\_16

- [27] M. Mazorchuk, V. Dobriak, D. Chumachenko, Web-application development for tasks of prediction in medical domain, Paper presented at the 2018 IEEE 13th International Scientific and Technical Conference on Computer Sciences and Information Technologies, CSIT 2018 - Proceedings, 1, (2018) 5-8. doi:10.1109/STC-CSIT.2018.8526684.
- [28] A. Yerokhin, A. Nechyporenko, A. in: IEEE 36th International Conference on Electronics and Nanotechnology (ELNANO), Kiev, 2016, pp. 198-201, doi: 10.1109/ELNANO.2016.7493047.
- [29] A. Yerokhin, A. Nechyporenko, E. Linnyk, D. Suverov, A software and hardware system for studying the function of ostiomeatal complex, *East. European J. of Enterprise Technologies* 59(77) (2015) 9-13. doi: 10.15587/1729-4061.2015.51217.
- [30] R. Radutny, A. S.Nechyporenko, V. Alekseeva, G. Titova, D. Bibik, V. Gargin, "Automated measurement of bone thickness on sct sections and other images", Proceedings of the 2020 IEEE 3rd International Conference on Data Stream Mining and Processing, DSMP 2020, 222-226. doi: 10.1109/DSMP47368.2020.9204289.
- [31] V.V. Gargin, V.V. Alekseeva, A.V. Lupyr, N.O. Urevich, R.S. Nazaryan, V.M. Cheverda, "Correlation between the bone density of the maxillary sinus and body mass index in women during the menopause", *J. Problemi Endokrinnoi Patologii*, vol 2 (68), pp. 20-26, 2019. (in Russian). doi:10.21856/j-PEP.2019.2.03.