

MAX-PLANCK-INSTITUT FÜR PHYSIK
WERNER-HEISENBERG-INSTITUT

MPI-PhE/2000-11

19 May 2000

**Construction and Test of MDT Chambers for
the ATLAS Muon Spectrometer***

F. Bauer, U. Bratzler, H. Dietl, H. Kroha, Th. Lagouri,
A. Manz, A. Ostapchuk, R. Richter, S. Schael

Max-Planck-Institut für Physik, Föhringer Ring 6, D-80805 Munich, Germany

S. Chouridou, M. Deile, O. Kortner, A. Staude,
R. Ströhmer and T. Trefzger

Ludwig-Maximilians-Universität, Schellingstraße 4, D-80799 Munich, Germany

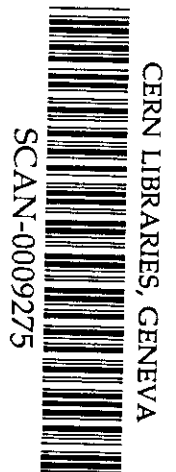

* Proceedings of the 8th Pisa Meeting on Advanced Detectors, May 21-27, 2000, Isola d'Elba, Italy, to be published in Nucl. Instr.&Methods.

Construction and Test of MDT Chambers for the ATLAS Muon Spectrometer^{*}

F. Bauer, U. Bratzler, H. Dietl, H. Kroha¹, Th. Lagouri,
A. Manz, A. Ostapchuk, R. Richter, S. Schael

Max-Planck-Institut für Physik, Föhringer Ring 6, D-80805 Munich, Germany

S. Chouridou, M. Deile, O. Kortner, A. Staude,
R. Ströhmer and T. Trefzger

Ludwig-Maximilians-Universität, Schellingstraße 4, D-80799 Munich, Germany

Abstract

The Monitored Drift Tube (MDT) chambers for the muon spectrometer of the ATLAS detector at the Large Hadron Collider (LHC) consist of 3–4 layers of pressurized drift tubes on either side of a space frame carrying an optical monitoring system to correct for deformations. The full-scale prototype of a large MDT chamber has been constructed with methods suitable for large-scale production. X-ray measurements at CERN showed a positioning accuracy of the sense wires in the chamber of better than the required 20 μm (rms). The performance of the chamber was studied in a muon beam at CERN. Chamber production for ATLAS now has started.

^{*} Proceedings of the 8th Pisa Meeting on Advanced Detectors, May 21–27, 2000. Isola d'Elba, Italy, to be published in Nucl. Instr.&Methods.

¹ Corresponding author. e-mail: kroha@mppmu.mpg.de

Construction and Test of MDT Chambers for the ATLAS Muon Spectrometer

F. Bauer, U. Bratzler, H. Dietl, H. Kroha¹, Th. Lagouri,
A. Manz, A. Ostapchuk, R. Richter, S. Schael

Max-Planck-Institut für Physik, Föhringer Ring 6, D-80805 Munich, Germany

S. Chouridou, M. Deile, O. Kortner, A. Staude,
R. Ströhmer and T. Trefzger

Ludwig-Maximilians-Universität, Schellingstraße 4, D-80799 Munich, Germany

Abstract

The Monitored Drift Tube (MDT) chambers for the muon spectrometer of the ATLAS detector at the Large Hadron Collider (LHC) consist of 3–4 layers of pressurized drift tubes on either side of a space frame carrying an optical monitoring system to correct for deformations. The full-scale prototype of a large MDT chamber has been constructed with methods suitable for large-scale production. X-ray measurements at CERN showed a positioning accuracy of the sense wires in the chamber of better than the required 20 μm (rms). The performance of the chamber was studied in a muon beam at CERN. Chamber production for ATLAS now has started.

The ATLAS muon spectrometer [1] is designed to provide stand-alone muon momentum resolution of $\Delta p_T/p_T = 2 - 10\%$ for transverse momenta between 6 GeV and 1 TeV over a pseudo-rapidity range of $|\eta| \leq 2.7$. This requires very accurate track sagitta measurement with three layers of muon chambers in a superconducting air-core toroid magnet and high-precision optical monitoring systems to correct for chamber misalignment. Precision drift chambers, the Monitored Drift Tube (MDT) chambers, have been developed to provide a track position resolution of 40 μm over an active area of 5500 m^2 .

The MDT chambers (see Fig. 1) consist of 3–4 layers of precision aluminum drift tubes with 29.970 ± 0.015 mm outer diameter and 400 μm wall thickness on either side of a space frame carrying an optical monitoring system to correct

¹ Corresponding author, e-mail: kroha@mppmu.mpg.de

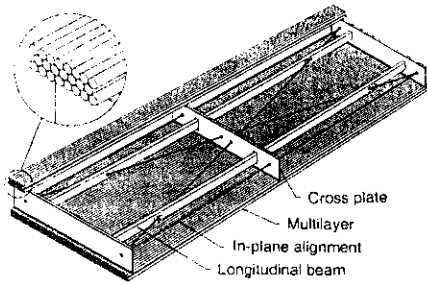

Fig. 1. MDT chamber for the ATLAS muon spectrometer.

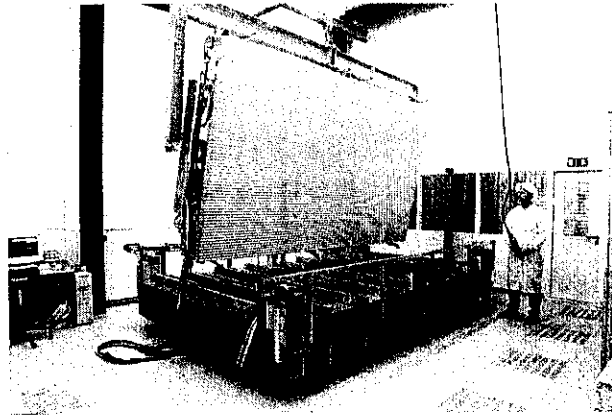

Fig. 2. The MDT prototype chamber during assembly.

for chamber deformations. The drift tubes are operated at a gas pressure of 3 bar to provide a single-tube position resolution of at least $80 \mu\text{m}$ (rms) at the low gas gain of 2×10^4 used to minimize ageing effects. The sense wires of the drift tubes have to be positioned in the chamber with an accuracy of $20 \mu\text{m}$ (rms) for a chamber position resolution of $40 \mu\text{m}$ (rms).

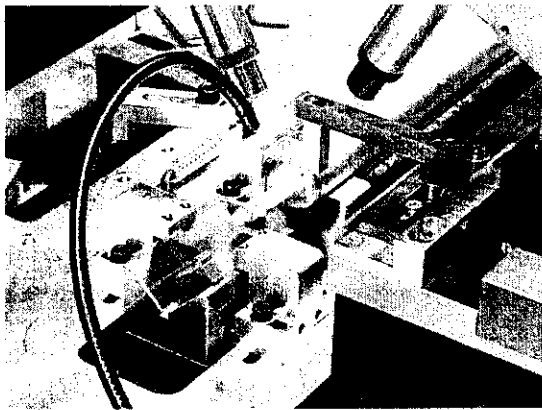

Fig. 3. Precise wire positioning using glue curing under UV illumination.

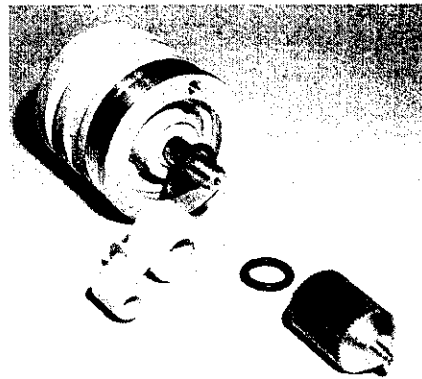

Fig. 4. Endplug design for the wire glueing technique.

For the ATLAS muon spectrometer, 1200 MDT chambers containing about 400000 tubes of 1-6 m length have to be built at 12 construction sites over a period of 4 years. With the construction of a full-scale prototype chamber with 432 tubes of 3.8 m length and a width of 2 m in 1998 (see Fig. 2) it has been demonstrated that the high mechanical precision can be achieved with assembly methods [1] suitable for large-scale production.

The construction of a MDT chamber consists of two major steps, the fabrication of the drift tubes with accurately positioned sense wires and the precise assembly of the tubes in the chamber. For the prototype chamber, a drift tube fabrication method was used which allowed to position the wires in the precise aluminum tubes with an accuracy of $\sigma \approx 10 \mu\text{m}$ in each coordinate by

means of external references and fast-curing glue (see Fig. 3). The glue has been shown to cause no ageing of the drift tubes with Ar:CO₂ gas mixtures. The wire locations in the tubes have been measured with stereo microscopes during assembly and with an X-ray method after assembly.

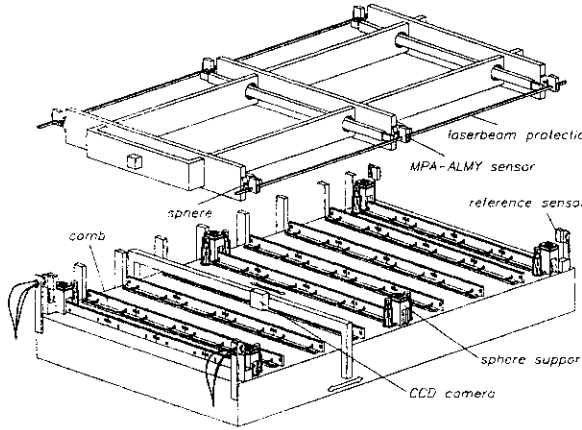

Fig. 5. MDT chamber assembly table with MDT space frame and optical monitoring devices.

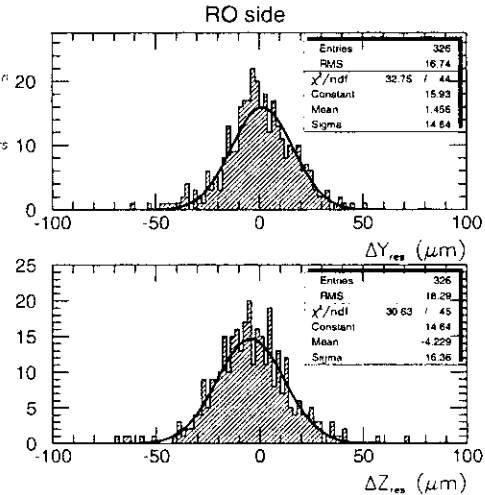

Fig. 6. Residuals of measured wire coordinates w.r.t. the expected grid.

An improved version of the tube endplug designed for this method is shown in Fig. 4. The wire is glued in a brass tube embedded in the insulating plastic (Noryl) body of the endplug to protect the wire against high voltage discharges. For long-term wire fixation, the wire is crimped in a small copper tubelet at the end of the brass tube. Reliable ground contact to the aluminum tubes is provided by spot welds to an aluminum ring on the endplug using a specially developed laser welding technique. For the large-scale production, the wires are positioned in the tubes using precisely machined endplugs. A wire positioning accuracy of better than 9 μm (rms) with respect to the endplug center has been achieved. The drift tubes are assembled semi-automatically in a temperature-controlled clean room.

All drift tubes assembled in the chamber have to fulfil stringent quality criteria, including a gas leak rate at 3 bar below 10^{-8} bar · l/s, a wire tension within 2% of the nominal value and HV stability requirements.

For the assembly of the chamber [1], the tubes of each layer are positioned with a precision of 4 μm (rms) on combs installed on a granite table in a climatized clean room (see Figs. 2 and 5). Subsequent tube layers are glued to the space frame which is positioned above the combs with an accuracy of $\pm 5 \mu\text{m}$ monitored by optical measuring devices (see Fig. 5).

The wire positions in the prototype chamber have been measured at CERN [2] with an accuracy of about $5 \mu\text{m}$ (rms) by scanning the tube ends with stereo X-ray sources. The distributions of the residuals of the measured wire coordinates y and z with respect to the expected wire grid are shown in Fig. 6. A wire positioning accuracy of better than $18 \mu\text{m}$ (rms) has been achieved for one of the largest chambers in the ATLAS muon spectrometer.

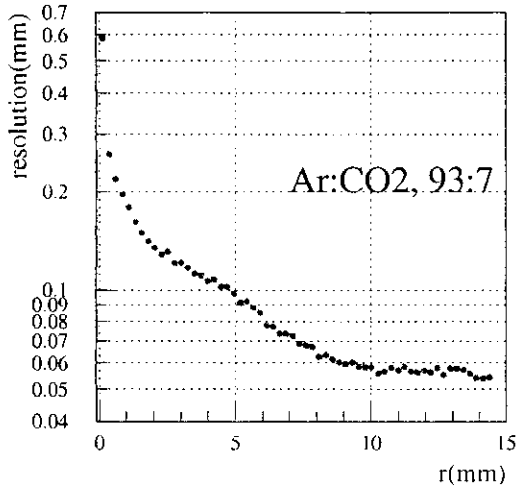

Fig. 7. Single-tube resolution as a function of drift distance for Ar:CO₂ gas at 3 bar.

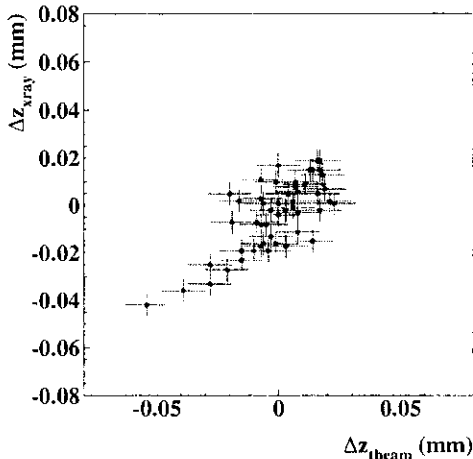

Fig. 8. Correlation of wire coordinate measurements with X-rays and with tracks in the test beam.

The prototype chamber has been tested in a 300 GeV muon beam at CERN fully equipped with readout electronics using as drift gas Ar:CO₂ (93 : 7) at 3 bar chosen to prevent ageing of the drift tubes under LHC conditions. Using a silicon strip detector telescope [3] as external reference, the space to drift-time relationship and the position resolution as a function of the drift distance were determined (see Fig. 7) giving an average single-tube resolution of $70 \mu\text{m}$ (rms). This r - t -relation was applied to the other drift tubes in the beam adjusting only the maximum drift time. Requiring the track residual distributions as function of the drift distance to be symmetric left and right of the wires provides information about displacements of the wires from their nominal positions. Comparison with the X-ray measurements of the wire coordinates perpendicular to the beam (z) shows a good correlation (see Fig. 8) and agreement within $10 \mu\text{m}$ (rms). The tests showed that using Ar:CO₂ with only 7% CO₂ as gas mixture requires great care in the fabrication and operation of the large number of drift tubes in order to maintain high precision and reliability.

After the demonstration of the mechanical precision of the chamber construction and experience with the chamber operation in the beam showing the required performance, the production of MDT chambers for the ATLAS experiment has now started.

References

- [1] *ATLAS Muon Spectrometer Technical Design Report*, A. Airapetian et al., CERN/LHCC/97-22, May 1997.
- [2] D. Drakoulakos et al., CERN-OPEN-97-023, July 1997.
- [3] M. Deile, J. Dubbert, N.P. Hessey, A. Staude, ATLAS Note, ATL-COM-99-015, April 1999.