



STATE RESEARCH CENTER OF RUSSIA
INSTITUTE FOR HIGH ENERGY PHYSICS

IHEP 2001-48

A.G. Kholodenko, V.N. Riadovikov
Institute for High Energy Physics, Protvino, Russia

H.-G. Moser
Max-Planck Institut für Physik, Munich, Germany

A.A. Antonov, I.G. Grigorieva, A.S. Kotosonov, G.G. Sazonov, D.V. Shilo
NIIGraphite, Moscow, Russia

**COMPARISON OF THE IN-PLANE THERMAL AND
ELECTRICAL CONDUCTIVITIES AND
TRANSVERSE PULL STRENGTHS OF
VARIOUS PYROLYTIC GRAPHITE MATERIALS**

Protvino 2001

Abstract

Kholodenko A.G., Riadovikov V.N., Moser H.-G. et al. Comparison of the In-plane Thermal and Electrical Conductivities and Transverse Pull Strengths of Various Pyrolytic Graphite Materials: ИИЭР Preprint 2001-48. – Protvino, 2001. – p. 8, figs. 7, tables 1, refs.: 3.

Different pyrolytic graphite materials were produced varying the annealing parameters such as temperature, pressure and time. These variations should alter the product properties in a systematic way. The coefficient of in-plane thermal conductivity, C_{KT} , the coefficient of electrical conductivity, σ and the pull strength S of these samples were measured. Results for the different materials and correlations are reported.

Аннотация

Холоденко А.Г., Рядовиков В.Н., Мозер Г.-Г. и др. Сравнение тепловых, электрических и механических характеристик различных образцов пиролитического графита: Препринт ИФВЭ 2001-48. – Протвино, 2001. – 8 с., 7 рис., 1 табл., библиогр.: 3.

Была изготовлена серия образцов пиролитического графита при различных условиях проведения процедуры вторичного отжига. При отжиге варьировались температура, время и дополнительное внешнее давление. У полученных образцов были измерены коэффициенты продольной тепло- и электропроводности (C_{KT} и σ) и значение поперечного усилия на разрыв S . Представлены полученные в ходе измерений значения и их взаимосвязь.

Introduction

As already indicated in [1] different samples of Thermal Pyrolytic Graphite (TPG) show a negative correlation of the thermal conductivity and the mechanical pull strength. Material with higher thermal conductivity has worse mechanical properties. This correlation can be understood as follows: Imperfections in the layer structure of TPG increase the bonding of adjacent layers and improve the mechanical properties of the material. However, such imperfections have an adverse effect on the thermal conductivity. The quality of the layer structure can be controlled to some extent using different annealing parameters in preparing the TPG material. In order to study this correlation in a more systematic way we performed a series of measurements of differently annealed samples of Pyrolytic Graphite to correlate mechanical, electrical and thermal properties. These tests should allow to select the optimal annealing procedure for the material to be used as baseboard of the SCT end cap modules.

Sample Preparation

Pyrolytic graphite is made using deposition of carbon at high temperature (1900-2200 °C) from natural propane at low pressure. During the deposition the temperature varies resulting in a rather inhomogeneous material with internal tensions. Hence high temperature annealing and eventually high pressure annealing is performed afterwards. Annealing under pressure is done using the setup shown in Fig. 1. The setup is an inductively heated block and a special external piston. All heated elements of the press are made using pressed graphite. The temperature of the sample during the annealing process is monitored by sensors through a small window.

All samples were manufactured by Atomgraph (Moscow). The following samples were prepared¹:

¹We introduced the following labeling scheme to characterize the different samples: *aaannmmmk*; “aaa” describes the initial material, either raw pyrolytic graphite as described above (“PG”) or pre-annealed material like “TPG” or “HOPG” as explained below. “nn” indicates the temperature of the annealing, “29” stands for 2900 °C. “mmm” is the pressure in kg/cm² and “k” indicates the time in hours the sample is kept at the temperature indicated.

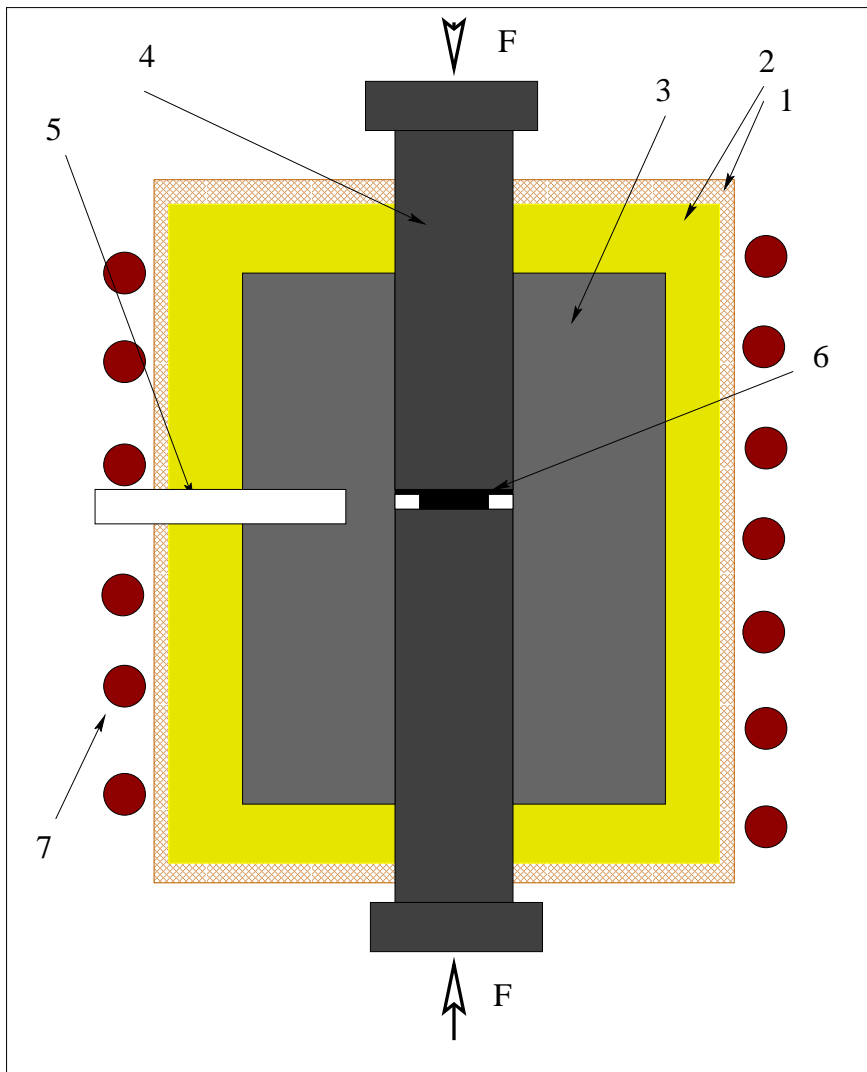

Fig. 1. Schematic view of the setup used for annealing of TPG under pressure: 1,2 — thermal insulation; 3 — heated graphite blocks; 4 — graphite piston; 5 — window; 6 — sample; 7 — inductor coil.

- **PG290001**: Raw PG annealed at 2900 °C for 1 hour. This material is commercialized under the name “**TPG**”.
- **PC292000**: PG annealed for a short time at 2900 °C under a pressure of 200 kg/cm². This material is commercialized under the name “**HOPG**”.
- **TPG290100**: TPG additionally short time annealed at 2900 °C and under pressure 10 kg/cm².
- **TPG320003**: TPG annealed at a temperature of 3200 °C, without pressure (in fact, there is a small contact pressure of about 1 kg/cm²) during 3 hours.
- **TPG320000**: TPG short time annealed at 3200 °C without pressure.
- **HOPG320003**: HOPG annealed at a temperature of 3200 °C for 3 hours without pressure.
- **HOPG320000**: HOPG short time annealed at a temperature of 3200 °C without pressure.

Two series of each type were prepared: Series 1 consists of 9 samples (three kinds of materials, and three samples of each material), series 2 consists of 18 samples (five kinds of each material). Both series include standard TPG (PG290001), hence the total number of the tested structures is seven.

For comparison we measured also a sample of TPG (with unknown annealing parameters) purchased from Advanced Ceramics Cooperation.

Measurements

First the coefficient of the thermal conductivity of every sample was measured. Then each TPG sample was divided into 5 small samples (for Series 1), or into 2 samples (for Series 2). These small samples were used for pull tests measurements. In addition the electrical conductivity of the samples of series 2 was measured.

Thermal Conductivity

The setup used to measure the coefficient of the in-plane thermal conductivity is very close to the one described in [3]. A detailed description is also given in [2]. A schematic view of the setup is shown in Fig. 2. The coefficient is derived from the measured temperature gradient along the heat path under stationary conditions using the distance between the temperature sensors, the cross section of the sample and the heat flow. The measurements were done inside of a vacuum vessel at residual pressure near 10^{-1} mbar and the averaged temperature of the samples was varied from -6 °C up to $+7$ °C for the series 1 and from $+5$ °C up to $+16$ °C for series 2. The results are listed in table 1. All measurements from the same material were averaged. The statistical error indicates the spread within the samples of one type. It is interesting to note that the high pressure annealed materials (PG292000, TPG290100) show a substantial larger spread. This could be understood in terms of an inhomogeneous pressure distribution in the setup. A second annealing step (as done for HOPG320003 and HOPG320000) reduces this spread. In Fig. 5 the average and spread of the thermal conductivity of TPG and high pressure annealed HOPG is shown for the original material and after further high temperature annealing. For standard TPG the conductivity improves while the spread is reduced, whereas for HOPG the conductivity decreases slightly while the spread is reduced as well.

Transverse Pull Strength

Transverse pull Strength measurements were performed using the method described in [1]. The structure of the samples is shown in Fig. 3. Two metal bars are glued back to back on the TPG sample. The upper bar is suspended by a support. A plastic vessel is clamped to the lower bar. A stream of water slowly fills the vessel up to the moment of disruption of the TPG insertion. The pull strength can then be deduced from the weight of the vessel.

Electrical Conductivity

In order to measure the electrical conductivity four contacts were put on the sample using conductive silver loaded grease from EPOTEK as shown in Fig. 4. The positions of the contacts and the geometrical dimensions of the sample were measured using a microscope.

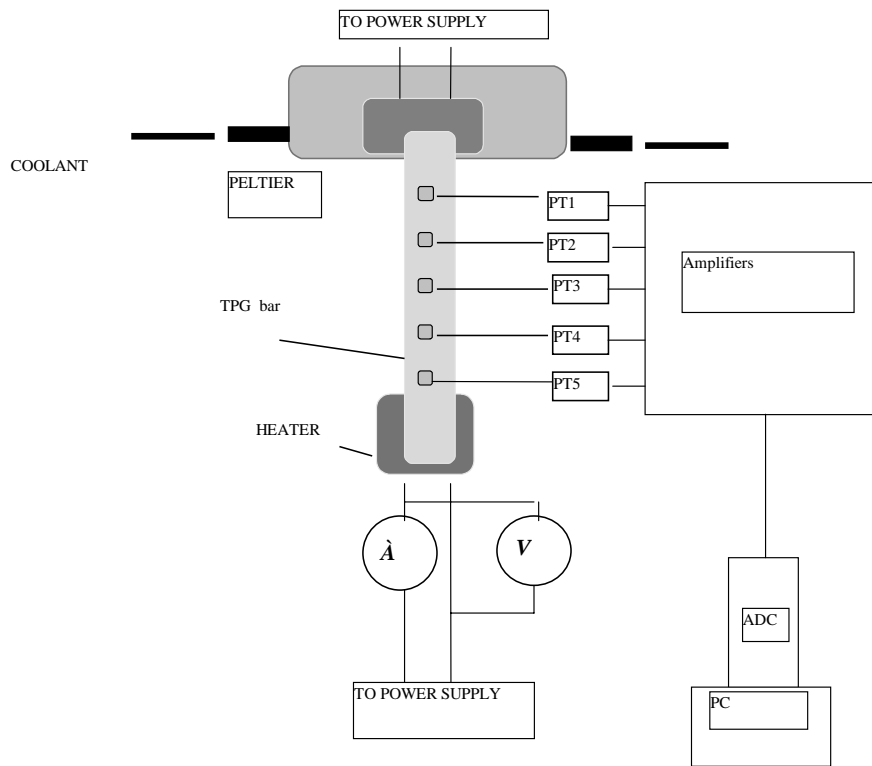

Fig. 2. Schematic view of the setups used for the measurement of the thermal conductivity.

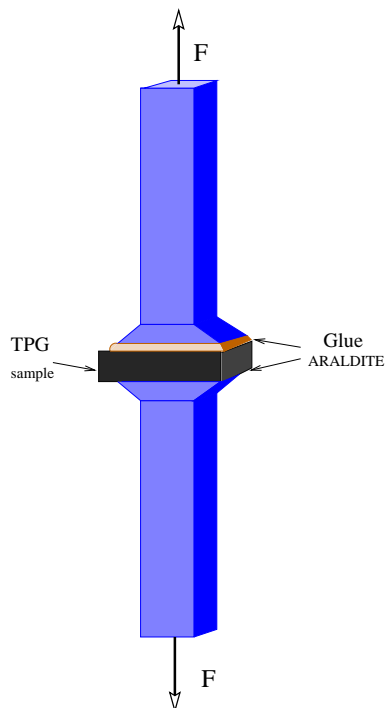

Fig. 3. Schematic view of the setup used for measuring the pull strength.

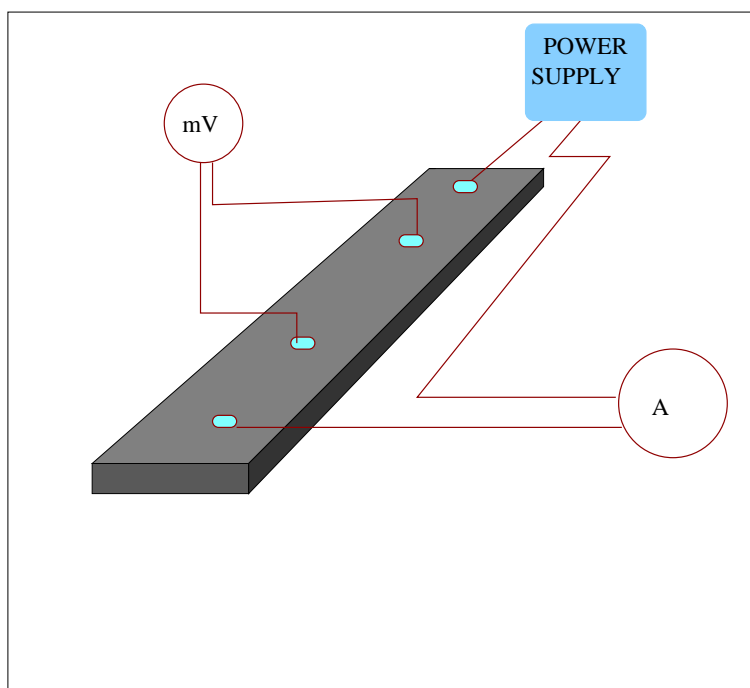

Fig. 4. Schematic view of the setups used for the measurement of the electrical conductivity.

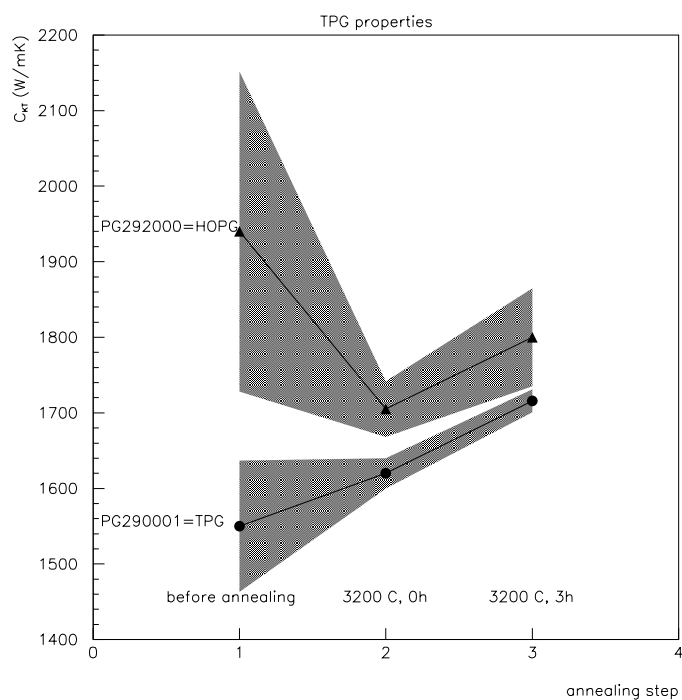

Fig. 5. In plane thermal conductivity of TPG and HOPG before and after high temperature annealing (without pressure). The central lines indicate the average of all samples, the shaded area the RMS spread.

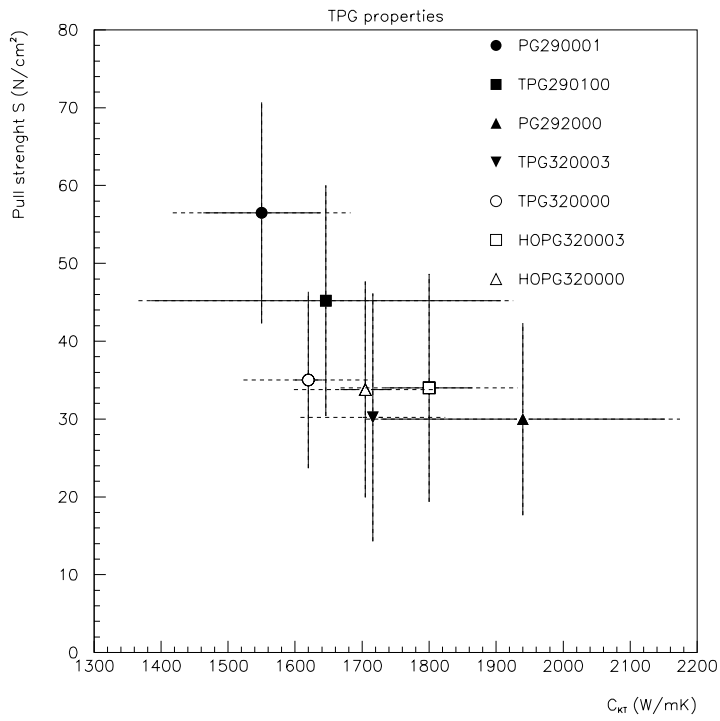

Fig. 6. Pull strength as function of the thermal conductivity. Average of all samples of a specific type of TPG. Solid line: statistical error. Dashed line: total error

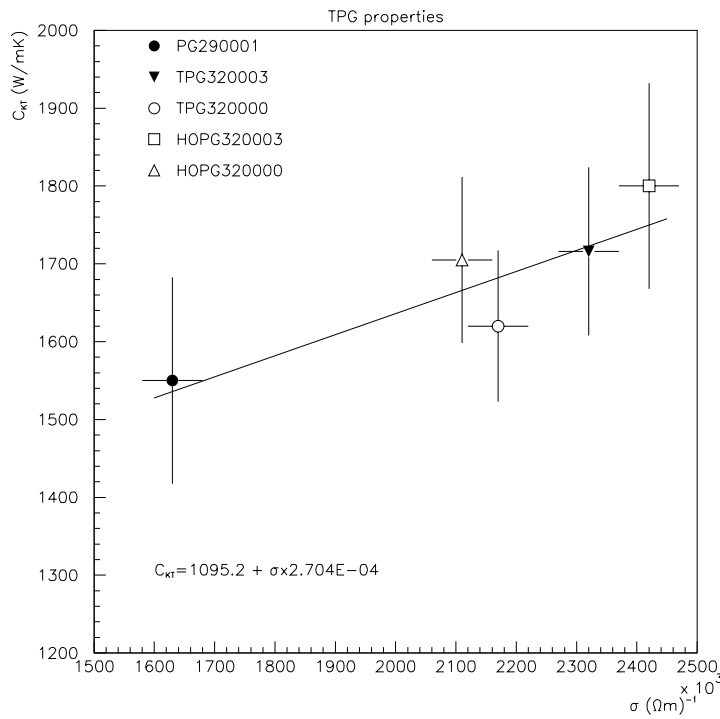

Fig. 7. Thermal and electrical conductivity. Average of all samples of a specific type of TPG from series 2.

The value of the electrical conductivity σ is calculated using:

$$\sigma = 1/\rho,$$

where

$$\rho = \frac{(U_+ + U_-) \cdot a \cdot b}{2 \cdot I \cdot d},$$

a is the width of the sample, b its thickness, d the distance between potential contacts, I the current through the sample and U_+ , U_- the potential difference at the contacts for direct and reverse current directions. The accuracy of the measurement is about 5%.

The coefficient of the in-plane thermal conductivity, C_{KT} and the transverse pull strength, S .

The measured values of the transverse pull strength as function of C_{KT} for all samples of Series 1 and Series 2 are shown in Fig. 6. The results of all measurements from the same kind of the graphite material were averaged.

Thermal and Electrical Conductivity

The values of the thermal conductivity coefficient, specific resistance ρ and electrical conductivity σ for the samples of series 2 are given in Table 1.

Table 1. Properties of pyrolytic graphite samples: Pull strength S , in-plane thermal conductivity C_{KT} , and electric conductivity σ . A sample from Advanced Ceramics was measured for comparison (AAC).

Material	S [N/cm ²]	$C_{KT,stat,sys}$ [W/mK]	σ [Ω m] ⁻¹
PG290001	56.5 ± 14.20	1550 ± 87 ±100	1.63 × 10 ⁶
TPG290100	45.2 ± 14.80	1646 ± 261±100	
PG292000	30.0 ± 12.35	1940 ± 212±100	
TPG320003	30.2 ± 15.91	1716 ± 15±107	2.32 × 10 ⁶
TPG320000	35.0 ± 11.33	1620 ± 20 ±95	2.17 × 10 ⁶
HOPG320003	34.0 ± 14.62	1800 ± 65±115	2.47 × 10 ⁶
HOPG320000	33.8 ± 13.87	1705 ± 37±100	2.11 × 10 ⁶
AAC	11.4 ± 1.4	1844 ± 114	

The thermal conductivity coefficient, as function of the electrical conductivity for samples is plotted in Fig. 7.

Conclusions

- High pressure annealed material has on average the best thermal conductivity. However, large variations from sample to sample are observed. For practical applications it is important that the material has constant, reproducible properties. Therefore high pressure annealed material such as HOPG should not be used. A second high temperature annealing step without pressure reduces this spread with a moderate reduction of thermal conductivity. Standard TPG, especially after annealing has very low variations and an almost equally good thermal conductivity.

- For TPG material a negative correlation of the transverse pull strength and the in-plane thermal conductivity is observed, material of higher thermal conductivity delaminates easier. The correlation coefficient S is in the order of -0.73 . Although the pull strength is reduced by almost a factor of two due to annealing the values of 30 N/cm^2 can be considered good enough for our applications.
- Electrical and thermal conductivity are correlated. The correlation coefficient is 0.87 . Since the measurement of the in-plane electrical conductivity is easier than thermal measurements this can be used for quality control of TPG material in the series production of SCT spines.

Acknowledgments

This work has been supported by CERN/INTAS grant 99-249.

References

- [1] A.G. Kholodenko, H.G.Moser. Comparison of the thermal and mechanical properties of the TPG used for ATLAS SCT modules, ATL-COM-INDET-2000-006.
- [2] E.N.Ardashev et al. Thermal Conductivity Measurements of Mechanical Structure Materials for ATLAS SCT modules (Contact Method). — IHEP Preprint 2000-16, Protvino, 2000 (Sub. to PTE).
- [3] C.Heusch, A.Kholodenko, H.-G.Moser. Direct Measurements of the Thermal Conductivity of Various Pyrolytic Graphite Samples (PG, TPG) Used as Thermal Dissipation Agents in Detector Applications, Accepted by NIM, MPI-PhE/2001-06.

Received November 05, 2001

Препринт отпечатан с оригинала-макета, подготовленного авторами.

А.Г. Холоденко, В.Н. Рядовиков, Г.-Г. Мозер и др.
Сравнение тепловых, электрических и механических характеристик
различных образцов пиролитического графита.

Оригинал-макет подготовлен с помощью системы L^AT_EX.

Подписано к печати 05.11.2001. Формат 60 × 84/8.
Офсетная печать. Печ.л. 1. Уч.-изд.л. 0.8. Тираж 160. Заказ 188.
Индекс 3649. ЛР №020498 17.04.97.

ГНЦ РФ Институт физики высоких энергий
142284, Протвино Московской обл.

