

СООБЩЕНИЯ  
ОБЪЕДИНЕННОГО  
ИНСТИТУТА  
ЯДЕРНЫХ  
ИССЛЕДОВАНИЙ

Дубна

E1-99-79

ATLAS BARREL HADRON TILE CALORIMETER:  
SPACERS PLATES MASS PRODUCTION

SCAN-9911093



CERN LIBRARIES, GENEVA

1999

A.M.Artikov<sup>1</sup>, J.A.Budagov, J.Khubua<sup>2</sup>, A.I.Lebedev, M.V.Lyablin,  
Yu.F.Lomakin, N.A.Russakovich, D.E.Shabalin, A.S.Shchelchkov,  
A.N.Sissakian, N.D.Topilin

*Joint Institute for Nuclear Research, Dubna, Russia*

S.Dubnicka

*Institute of Physics Slovak Academy of Sciences, Bratislava, Slovakia*

M.Nessi

*European Organization for Nuclear Research, Geneva, Switzerland*

S.Tokar

*Comenius University, Bratislava, Slovakia*

N.M.Choumeiko, A.S.Kurilin, P.P.Kuzhir

*National Scientific and Educational Center of Particle  
and High Energy Physics Attached to BSU, Minsk, Belarus*

A.I.Klimovich, I.I.Zhikh

*Minsk Tractor Plant, Minsk, Belarus*

---

<sup>1</sup>On leave from NPL, Samarkand State University, Samarkand, Uzbekistan  
<sup>2</sup>On leave from IHEP, Tbilisi State University, Tbilisi, Georgia

## 1.Introduction

In this article we would like to expound the experience we have accumulated in connection with mass production of so-called “spacer absorber plates” for the ATLAS Barrel Hadron Tile Calorimeter.

We remind that original task was to manufacture 20400 full sets of spacer plates or totally-244800 plates of 12 types which differ by their dimensions (Fig.1 and Fig.2). All the plates are flat. Production material is cold-rolled steel of Fe-360 type,  $4.05\pm 0.03$ mm thickness. Typical spacers manufacturing precision is  $\pm 100$  microns. We were limited (for plates production) by not more than 20400 steel sheets (1620mm long, 400-410 mm wide).

By the moment we began to search for the firm for spacers mass production and to the manufacturing technology we already had the experience of spacer plates production in 1996 by laser cutting for the MODULE-0 [1].

Because of some unstable of work of relatively cheap laser cutting machines and due to high production price on the high precision laser set-ups, we have decided to consider another option of spacer plates manufacturing, - by blanking stamping technology.

But for the final accepting of this technology one had to solve 2 main technical problems:

- 1 – to find such scheme of steel sheets cutting when our “allowed” quantity of 20400 sheets ( $400\times 1620\text{mm}^2$ ) will be enough for production of 20400 spacer sets;
- 2 – to be convinced that blanking stamping based on relatively simple stamp will definitely give the desirable manufacturing accuracy for the produced plates.

To solve the first problem we have undertaken the set of consultations with stamping experts. We received different technical proposals, but no one of them had fit our demands.

At this starting stage of work it was highly important to determine the minimal allowed dimension of the straight arch between neighboring details when steel sheet cutting. To find the solution we have proposed and performed an experiment to determine the minimal size of straight arch. When spacer # 12 stamping on the Slovakia plant in Belusha-town each 6<sup>th</sup> spacer from one plate was stamped with the different size “S” of the straight arch (Fig.3) between sample # 5 and sample # 6. Before the 6<sup>th</sup> sample stamping the “1 mm” long “extra steel” strip was cutting out by guillotine.

In the result of this experiment we found that for our steel type would be enough to have the minimal guaranteed straight arch of 6mm width. Starting from this result we have developed our own final theoretical scheme of the steel sheets cutting (Fig.4).

Following to this scheme we planned to cut 20221 steel sheets (1620mm long, 400 and 410mm wide) to produce 20400 full sets of spacers. To run ahead we would like to say, that our cutting scheme was used efficiently when designing and constructing of punching dies both on Minsk Plant ( Belarus ) and on Dubnica- nad- Vahom Plant (Slovakia) to produce spacers for Barrel and Extended Barrel respectively. At Minsk, due to some technical reasons, our layout scheme was slightly modified (Fig.5), but the changing were not of principal character.

To solve the second problem we signed contracts with Minsk Tractor Plant (Minsk, Belarus) and with ZTS-plant (Dubnica n/V, Slovakia) to produce experimental dies. Both stamping dies produced have demonstrated satisfactory results when experimental stamping [2].

Finally, taking into account all the factors [2], we have signed contract with MTP (Minsk, Belarus) to manufacture there the spacer plates for ATLAS Barrel Hadron Tile Calorimeter.

## 2. Spacers production in Minsk

Spacer plates stamping in Minsk was essentially completed for 5 months period of "middle of July – middle of December", 1998. During this time 99% of total amount of plates was produced at Minsk not less than 100% of each spacer type were manufactured. At the moment of this article preparing we need to stamp the remaining 2270 units of spacers # 11. Their production was stopped because of the temporary lack of steel.

Our analysis shows that there are different reasons for the lack of steel. It looks instructive to list the reasons:

- use part of steel sheets for the experimental stamping when stamping dies qualifying;
- mistakable manufacturing of more than necessary details when stamping;
- discrepancy between the originally ordered amount of steel and the really needed amount. Discrepancy appears because we received the steel sheet **by weight, although some steel sheets length** was sometimes (1-1,5%) larger than expected (plant nominal)...This is why quite possible to expect that the arrived to us quantity of steel sheets can be about (1-1,5%) less than necessary for spacers production;
- others.

### 2.1. Steel storage in the plant

The Prague steel was unloaded and moved for storage directly on the territory of press-working shop. To reduce the occupied storage area for the pallets the last ones were positional in two layers. Each pallet had 3 wooden supports. It allowed us to avoid the deformations of the steel sheets when storage.

### 2.2. Preliminary cutting of steel

The steel cutting into strips was made on the guillotine. Before the start of work the guillotine was tested. The attention was paid to the quality of the edges of the cutted strips and to the cutting precision ( $\pm 1$ mm).

After we obtained the satisfactory preliminary results the steel sheets cutting was carried out following to the cutting scheme (Fig. 5). The steel sheets for spacers ##4, 5, 6, 10, 11, 12 were cut out on two equal parts to reduce the weight of billets (Note: all the personal involved are women...). The cutting scheme for spacer #9 was changed what was caused by the stamp design.

No technical problems were met when cutting.

### **2.3. Stamping of spacers**

Before the individual spacer mass production the corresponding stamping couple was certified. Stamp certification was based on the results of measurements of six spacers. As a rule all stamps had needed the corrections just after the first inspection. The only exception was the stamp for spacer #7.

The spacers mass production has began on July, 10<sup>th</sup>, -practically immediately after the master plates production was successfully completed.

When spacer plates manufacturing we took into account that the master plates in reality came out narrower than it was planned at the very beginning of the earlier designing stage.

By our PROTOCOL №1 on July 01, 1998 we have changed the tolerance field for A and B dimensions of the spacer plates from  $\pm 0,1$  (old ones) to  $+0,1/-0,2$ mm (new ones).

The new tolerance field for these dimensions allowed us to speed up noticeably the attestation of stamps.

### **2.4. Quality control program performance for spacers**

In accordance to QC program we have carried out the necessary control measurements of spacers:

- each 30<sup>th</sup> – on the go-caliper;
- each 600<sup>th</sup> - following the full scheme of the measurement with using of the digital height gauge.

As the part of the main dimensions (A and B) and also the asymmetry of the spacer elements positioning cannot be measured directly, we have developed the corresponding measurement scheme for the each spacer type. Based on these measurements data we then calculated the A and B dimensions and determined the non-symmetry of the spacer elements.

The measurement scheme presented below was obtained as a result of our experience evolution and differs from our earlier procedures.

The very original measurement schemes were based on the idea to use – as a basic tool – the calipers to measure all the dimensions of spacers [1]. When they MODULE-0 spacers manufacturing just these scheme were used, and were quite acceptable for small series production (about 650 spacer sets).

However when we overcame to the large scale manufacturing our measurement schemes had to be changed as they became to be fully inconvenient, unpractical. Besides that when using the calipers the high level experts were needed, as in opposite case the subjective factors (brase) were unavoidable. And finally: to measure the necessary “starting” of spacer dimensions one needed about 30 minutes (and for spacer # 12 some 90 minutes).

When spacers mass production one needed to perform quite a fast “geometric parameters” measurements. Also when stamps attestation we had to fast (for some 30-40 minutes) measure 5-6 plates to obtain fast solution if stamping process can be continued or stamps are to be taken out of press for further modifications... All these circumstances forced us to critically revise the scheme and methods of measurements.

As a result we have developed and used the measurement scheme presented on the Fig's 6-9. Here the basic idea is: all the dimensions we needed were measured with the digital height gauge. The following positive features were reached:

- the objectivity of the results obtained by moderate qualification personnel; the data obtained were less subjected to personal origin brase due to variations in measurement tool positioning relative to the spacer measured.
- convenience in use of the tool and in manipulating with spacer during the measurement steps.
- one plate measurement time was noticeably reduced and reached 7-15 minutes depending on the spacer complexity.

To guarantee the production quality (remember: we used the very large tractor plant!) we permanently had in the MINSK TRACTOR PLANT one representative of Dubna Institute. His duty was the direct participation in spacer geometry measurements and the very general accompanying of the all the production stages with no exceptions. All conflict questions were solved only with Dubna representative person participation ("last word" right).

During the 5 months of spacers production period we changed our representatives (totally 4 persons were involved). But their overlapping it was foreseen to transfer the experience and guarantee the succession. All actions were framed into the "Instruction to carry out the spacers measurements on MTP".

The "Instruction" had included the measurement technology and some important practical advice's significant for correct measurements performing.

Fig.6 gives the measurement scheme for the spacers ## 1-5, 8-11.

All the measurement data entered to the protocol and after that one calculated the corresponding parameters:

$$A = (a_1 + a_2 - d_1) \times 1,0012 + 1,57;$$

$$B = (b_1 + b_2 - d_2) \times 1,0012 - 1,57;$$

$(G_1 - G_2)/2$  is the non-symmetry of the positioning of the of the "E" dimension relative to the "H" dimension;

$(a_1 - a_2)/2$  is the non-symmetry of the hole axis positioning "d<sub>1</sub>" relative to the "A" dimension;

$[(a_1 - a_2)/2 \pm F]$  is the non-symmetry of hole axis positioning "d<sub>2</sub>" relative to the "A" dimension;

$[(a_1 - a_2)/2 \pm F - (b_1 - b_2)/2]$  is the non-symmetry of the positioning "B" relative to the "A" dimension;

The sign “+” or “-“ in front of “F” is determined by plotting of the real location scheme of the axis of holes  $d_1$  and  $d_2$  relative to sides A and B of the spacer under measurement.

The  $d_1$  and  $d_2$  diameters were determined by calibrated pins.

On the Fig.7 we present the measurement scheme for spacer #6. Here:

$$A=K+l_1+l_2+0,2;$$

$$B = E + \left( b_1 + b_2 - \frac{d_1 + d_2}{2} \right) \times 1,0012 - 1,57$$

On the Fig.8 we present the measurement scheme for spacer # 7. Here:

$$A = (a_1 + a_2 - d_1) \times 1,0012 + 1,57;$$

$$B = (b_1 + b_2 - d_2) \times 1,0012 - 1,72.$$

All other as for spacer #1.

On the Fig.9 we presented the measurement scheme for spacer # 12. Here:

$$A = (a_1 + a_2 - d_1) \times 1,0012 + 5,36;$$

$$B = (b_1 + b_2 - d_2) \times 1,0012 - 1,57.$$

All other parameters are as for spacer # 1.

From the large variety of different parameters the most essential ones are the measured values  $a_1$ ,  $a_2$ ,  $b_1$ ,  $b_2$  as these parameters form the overall dimensions A and B. These two last ones will affect – later on – on the dimension of the channel for fibers.

On the Fig's 10-21 we presented the deviations of  $a_1$ ,  $a_2$ ,  $b_1$ ,  $b_2$  parameters from their nominal values for spacers ## 1-12. The histograms show that practically all of the deviation values are to the left from the “+50 $\mu$ ” point. It corresponds to shop-drawing .

For informing we present on the Fig.22 the calculated values of the deviations from nominal figures for A and B dimensions of all the spacers.

Real deviations for A and B in some insolated cases reach up to +150 $\mu$ . All other deviations are situated to the left of the “+100 $\mu$ ” point. Non-significant quantity of deviations are situated within (-300) – (-200) microns interval and do not correspond to the shop-drawing, but they are acceptable for submodule assembling. Such a wide deviations diapason tells about the realistic stamping possibilities.

Hard observance of the shop-drawing conditions would demand a rather significant rise in price of stamping and a significant increase of the quantity of stamped plates... We found it unreasonable.

When measuring of each 600<sup>th</sup> spacer we also made a visual inspection of the edges of spacers\* and determined the non-flatness of spacers. About 20% of the spacers measured had the non-flatness on the level of 0,5-1,0mm.

---

\*During stamping the workers were checking the edges quality visually

When applying of about 3-5 Kg load to the spacer it was tightly pressed to the control table surface. It manifests that we will not meet the problems with spacers after they were glued into submodules.

It is known that when blanking stamping the flatness of billets and of ready unit do not change.

Accordingly to the steel specification we have the steel sheets with the transversal billet non-flatness up to 2mm. When spacers stamping of such a sheets we obtain the spacers with the non-flatness more than 0,2mm.

During spacers production (of each individual type) each stamp has 2-4 times needed to be corrected or resharpened. The necessity of dimensions correction was determined on the base of the measurement results of the 600<sup>th</sup> unit. As a rule the divergence of the values measured in 2 "neighboring measurements" never exceeds 0,08mm. If we detected the tendency of precession of one of dimensions out of the tolerance limits, we stopped the production of this particular spacer and the stamp had been sent for the corrections.

The necessity of stamping resharpening was determined by the value of the burrs on the spacers edges. At the times before appearing on the MTP of the GRINDING machine the stamping was stopped if the burr's size was 0,3-0,4mm. GRINDING machine tests demonstrated that one can allow the burrs sizes up to 0,6-0,7mm. Following this rule we decreased the frequency of resharpening repetition.

Practice shows: the stamp resharpening **does not change** the dimensions of the unit. Therefore after the resharpening we measured not 6, but 1-2 spacers only.

### **2.5. Deburring. Packing. Transportation**

The GRINDING machine was positioned on the place in press-working shop near the end of Sept'98. Its working elements have been adjusted to the case of metal removing up to 0,01mm from both sides.

For one working shift through this machine passed about 200-220 full sets of spacers. Before that all spacers were washed in special set-up. This set-up is positioned in the same shop-area, - 50m away of the deburring machine.

In parallel, on the neighboring area all the "Dubna-spacers" were oiled by DAMINOL and packed into boxes.

Following the requests of our collaboration colleagues we have ordered on the MTP special wooden boxes we designed for spacers packing by full sets (see Fig.23.). The internal height of boxes is 300mm. These boxes can be repeatedly used for sending of the ready submodules to Dubna (2 submodules per 1 box).

In accordance with the spacers packing scheme in box and with maximum permissible weight of one loaded box the MTP has sent to Pisa and Prague 1,5t heavy 53 boxes (to each lab); to Dubna and to Protvino were delivered 40x2 boxes 2 tons heavy each. Boxes transporting was performed by cars.



GENERAL VIEW

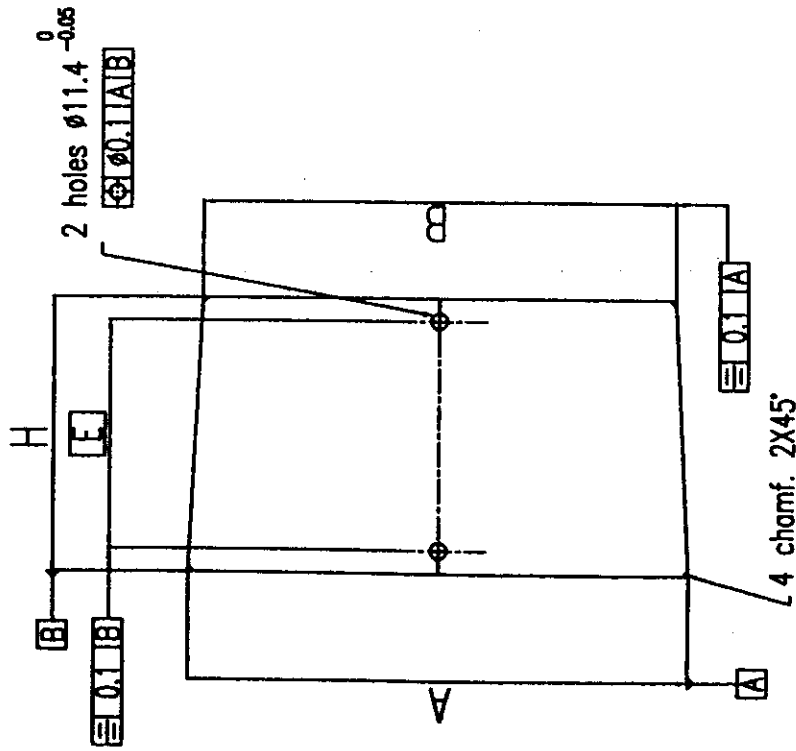

POS.	A	B	H	E
1	238.4	228.4	102	70
2	261	248.1	132	100
3	286.6	273.6	132	100
4	316.1	301.1	152	120
5	349.5	330.6	192	160
8	248.3	238.2	102	70
9	273.8	260.8	132	100
10	301.3	286.4	152	120
11	330.8	315.9	152	120

THICKNESS OF ALL SHEETS IS  $4.05 \pm 0.03$   
 GENERAL TOLERANCES  $\pm 0.1$

Fig.1. Spacer plates #1-5, 8-11.

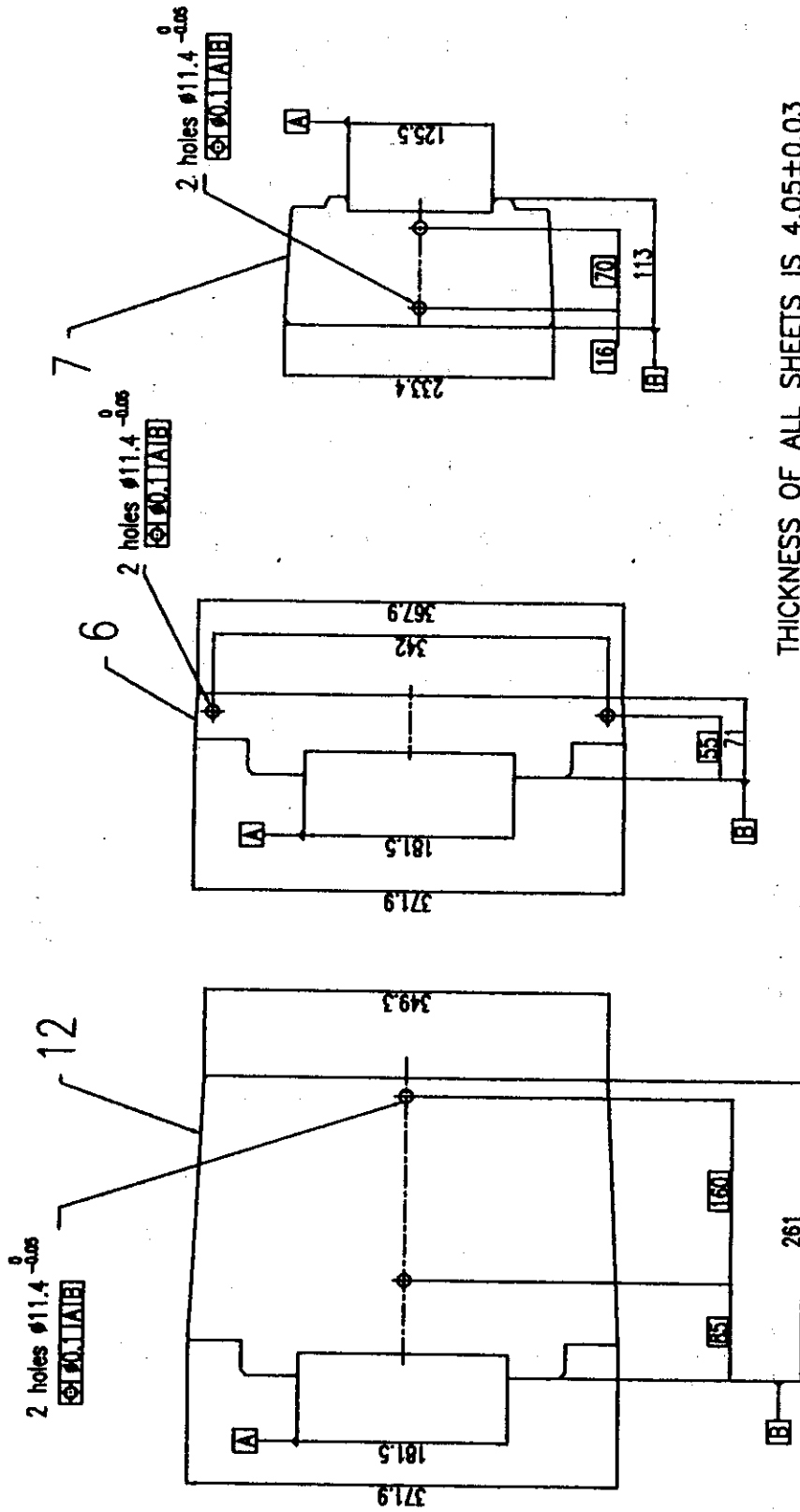

THICKNESS OF ALL SHEETS IS  $4.05 \pm 0.03$   
 GENERAL TOLERANCES  $\pm 0.1$

Fig.2. Spacer plates ## 6, 7, 12.

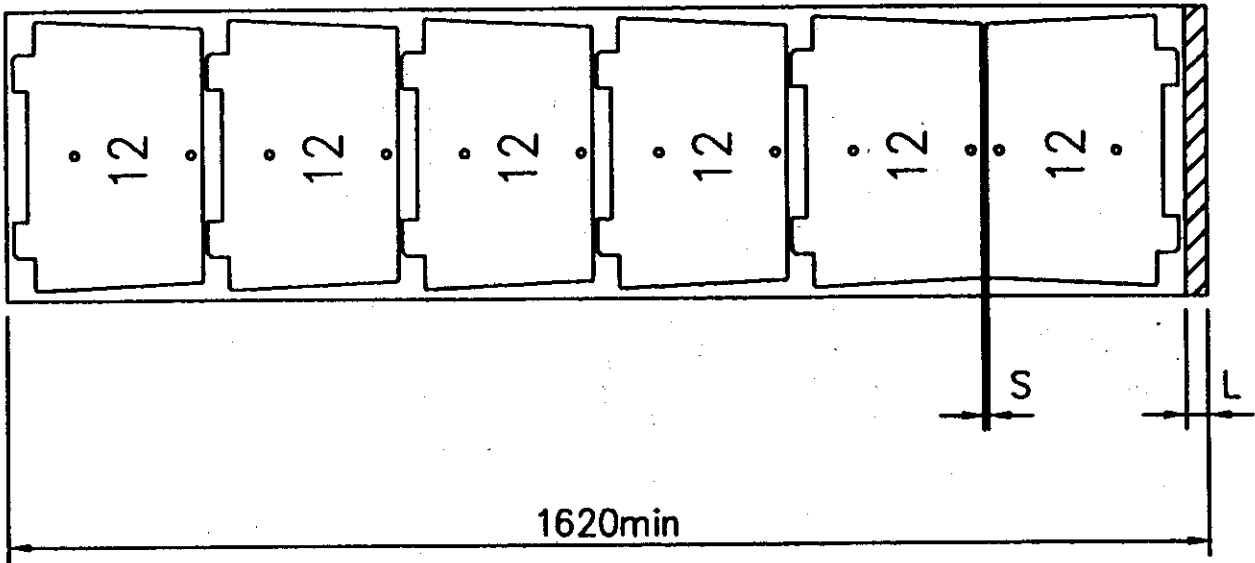

Sheet #	S, mm	Result
1	6.5	Good
2	4.5–5.5	On a boundary of adequacy

Fig.3. The layout of spacer #12 for cutting test.

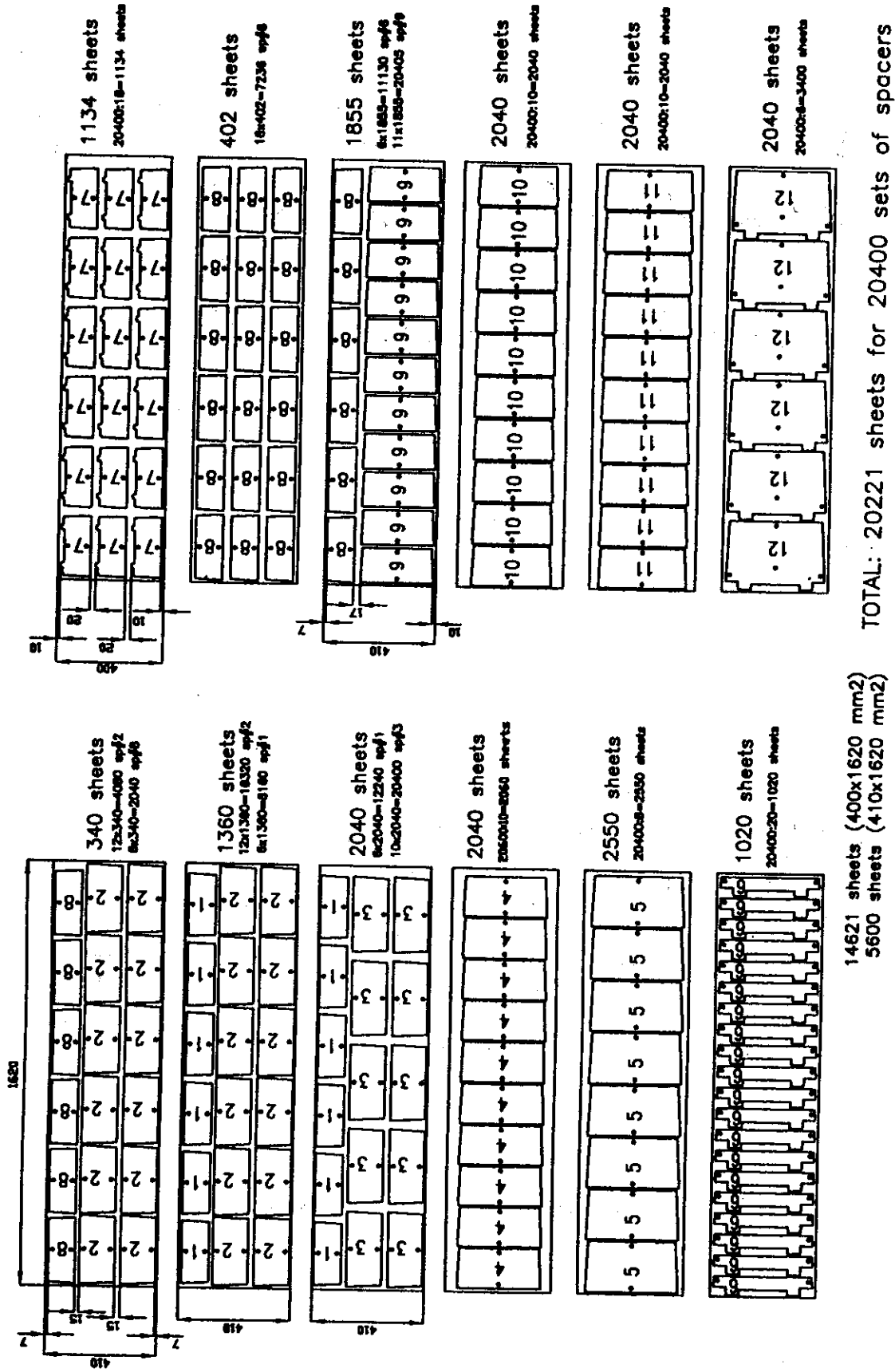
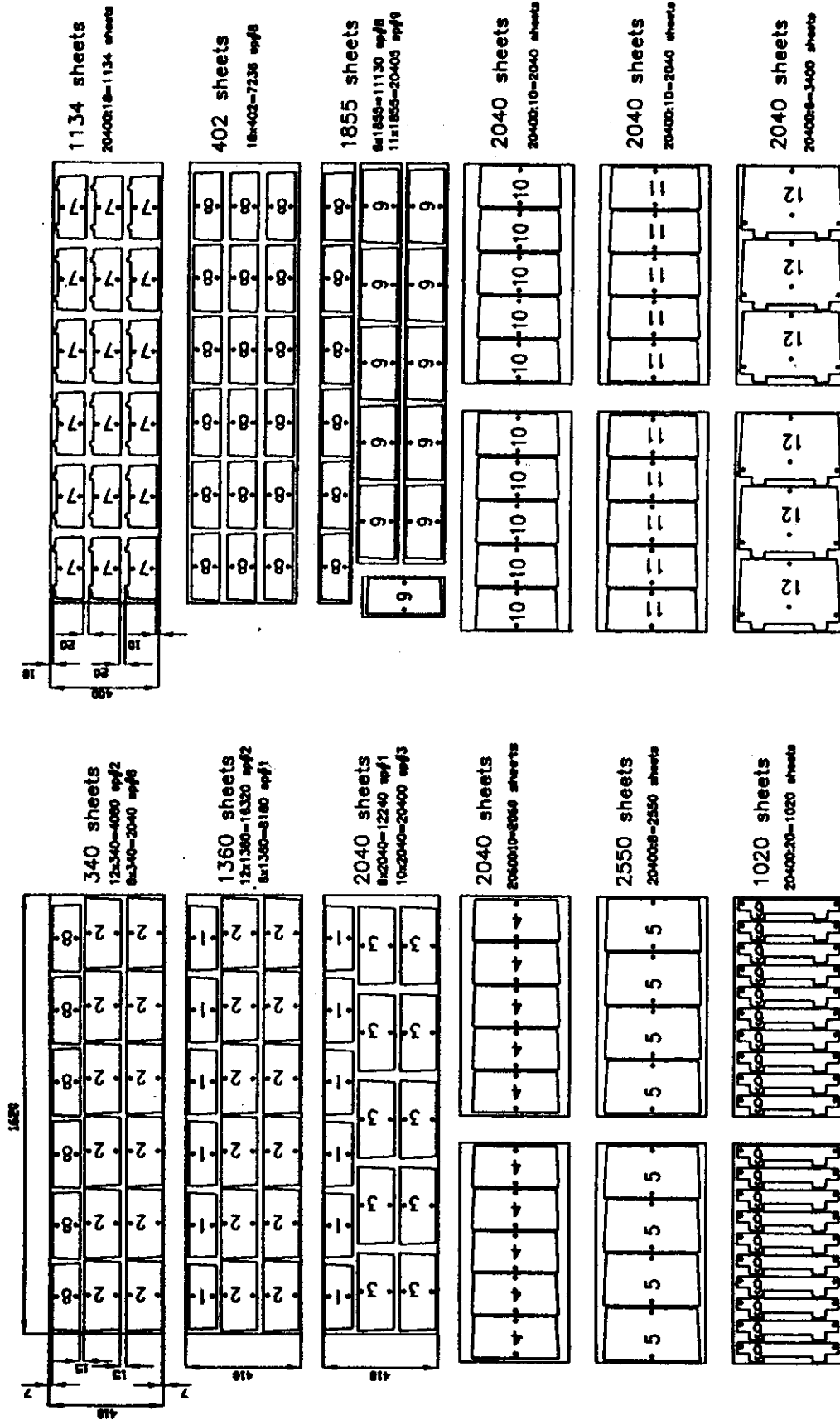

Fig.4. The theoretical variant of spacer layout.



14621 sheets (400x1620 mm<sup>2</sup>)  
 5600 sheets (410x1620 mm<sup>2</sup>)

TOTAL: 20221 sheets for 20400 sets of spacers

Fig.5. The real variant of spacers layout.

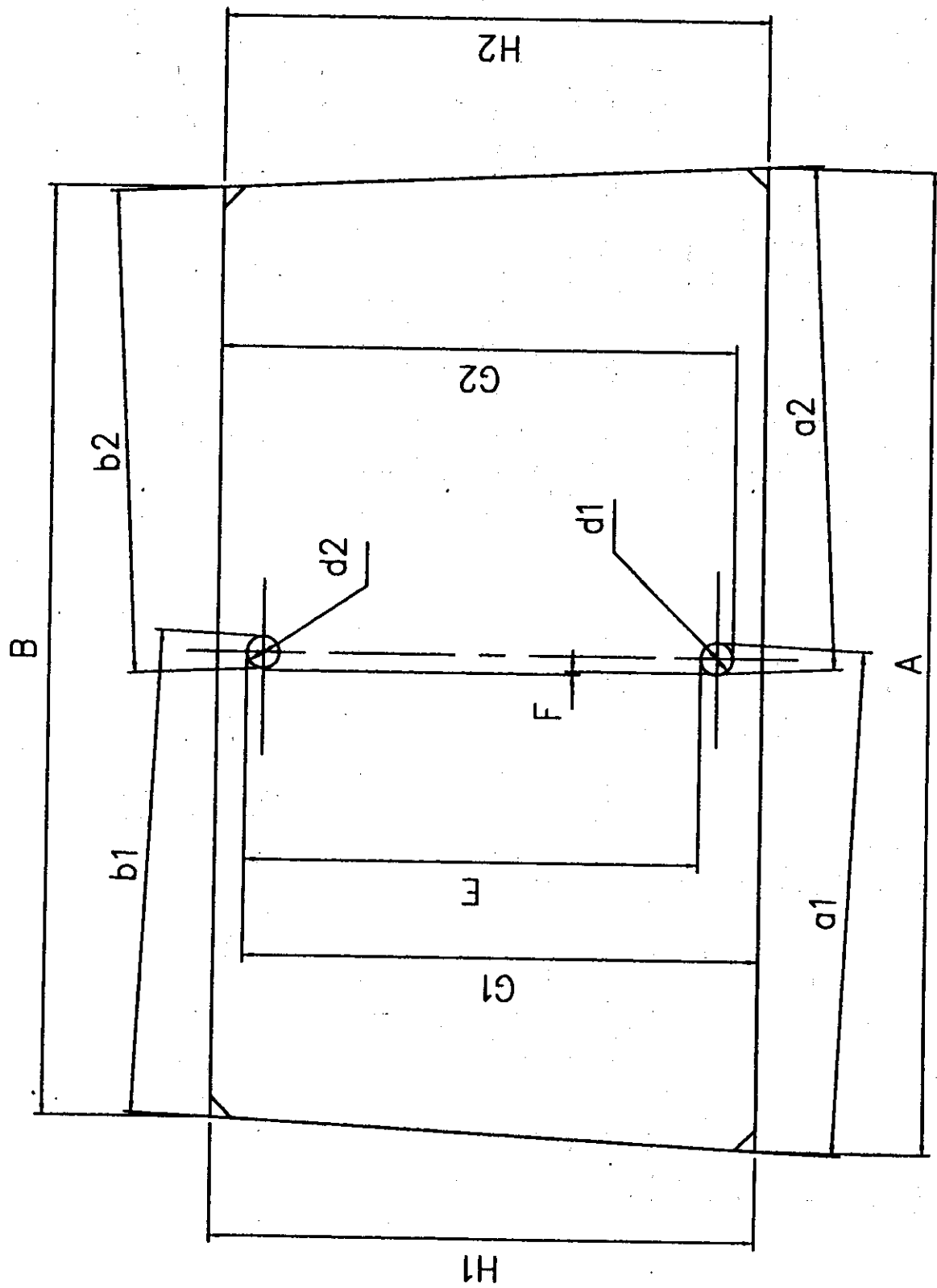

Fig.6. The scheme of spacers measurements.

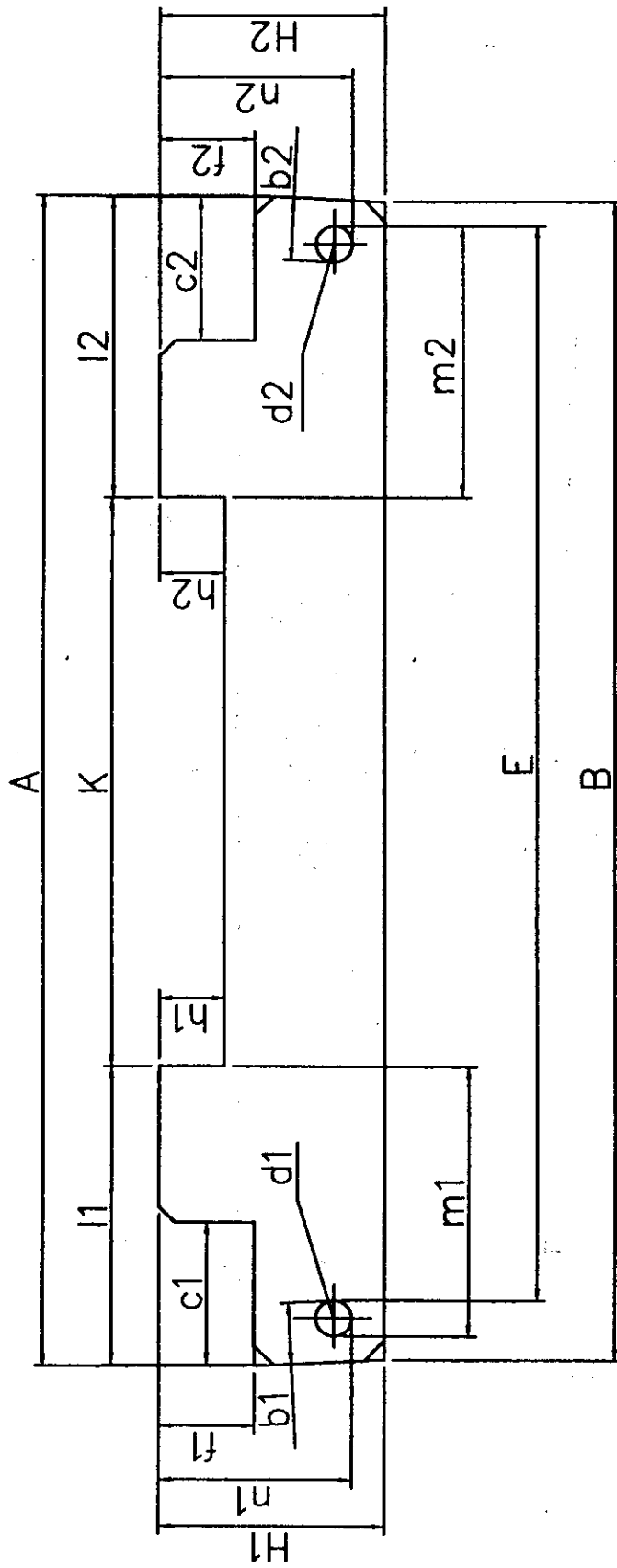

Fig.7. The scheme of spacer #6 measurements.

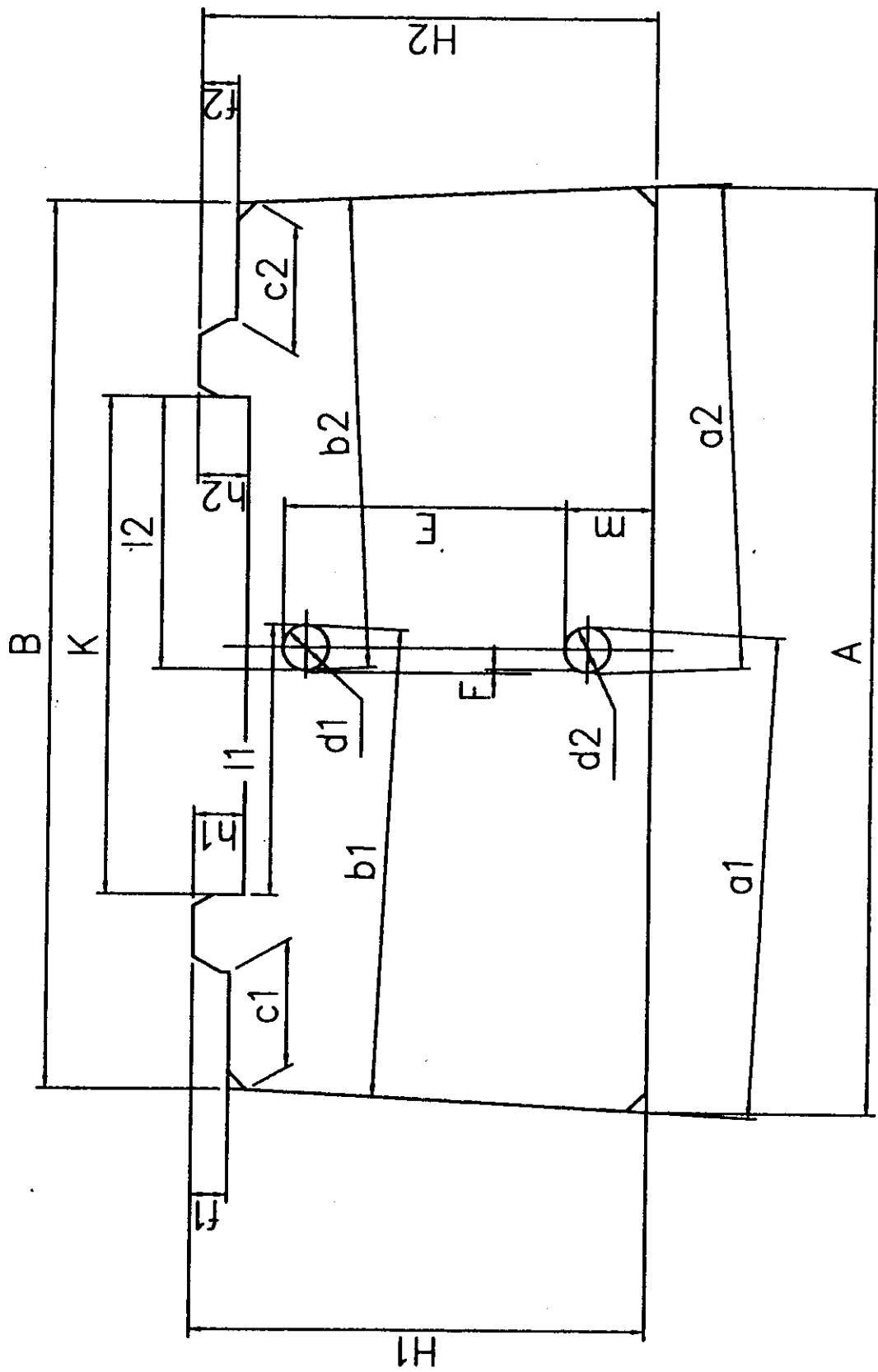

Fig. 8. The scheme of spacer #7 measurements.



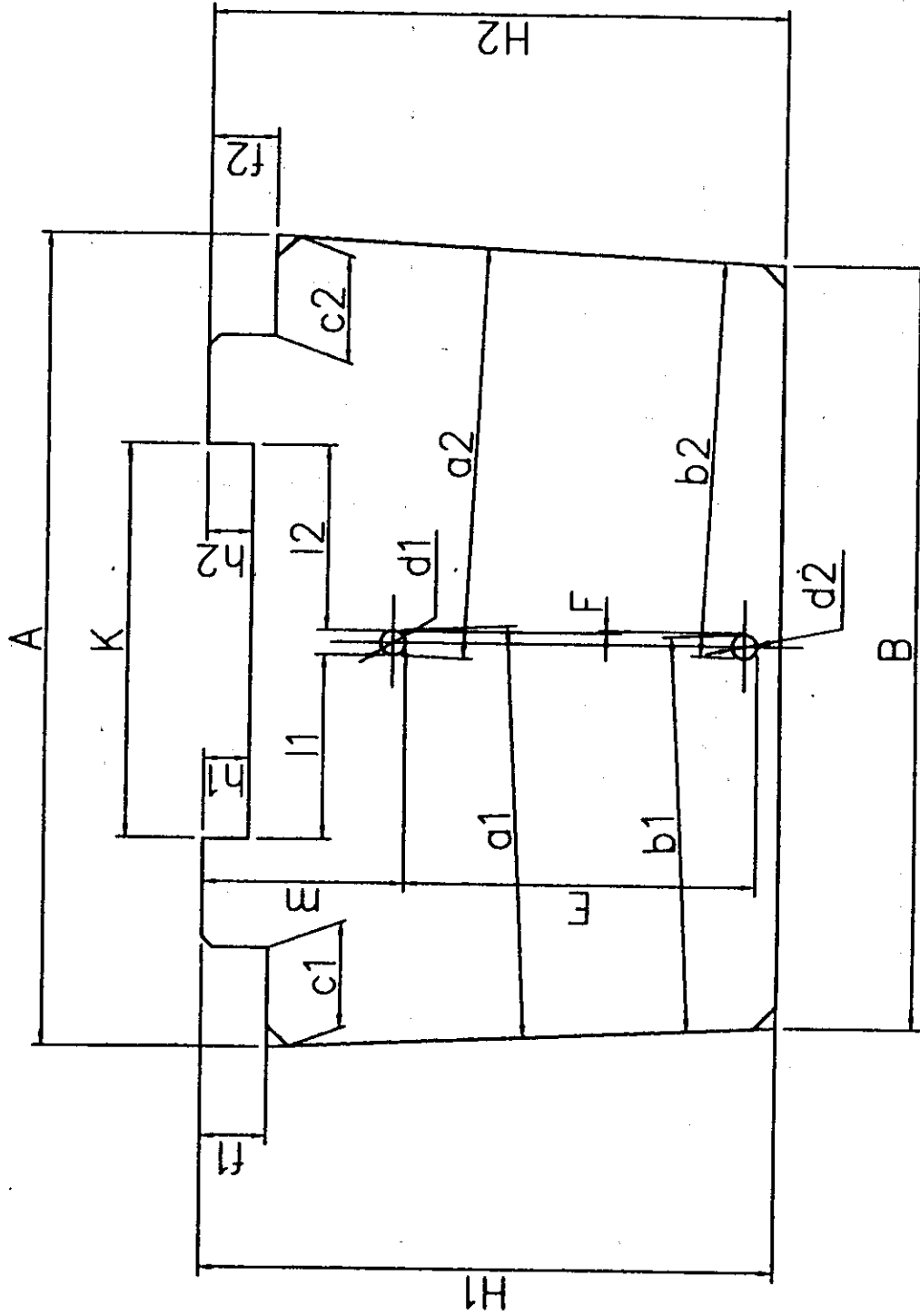
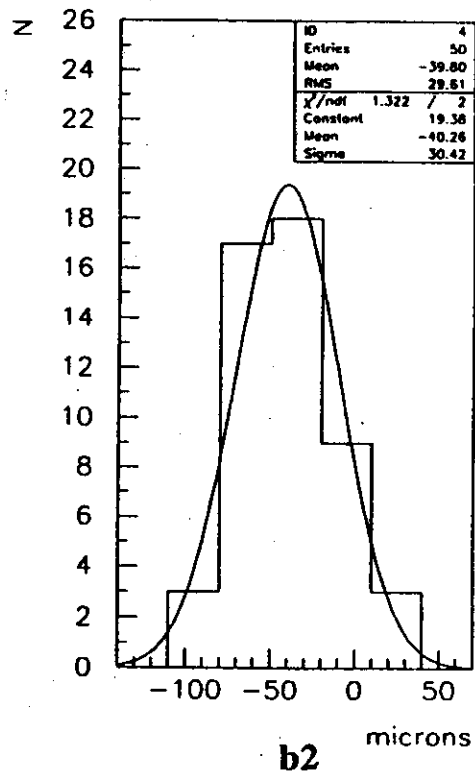
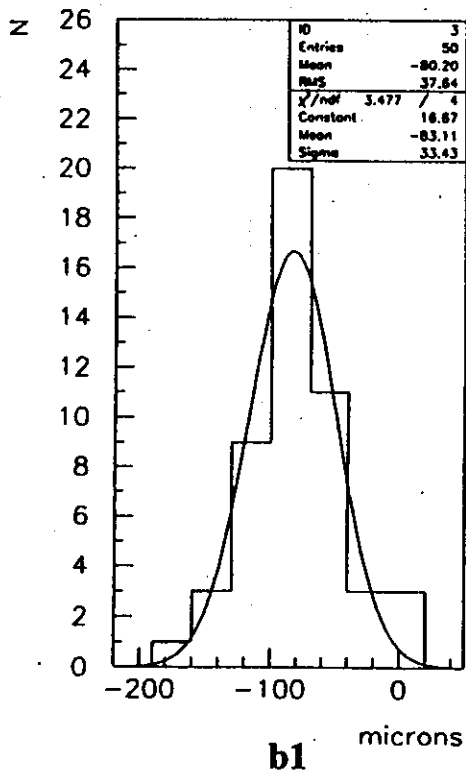
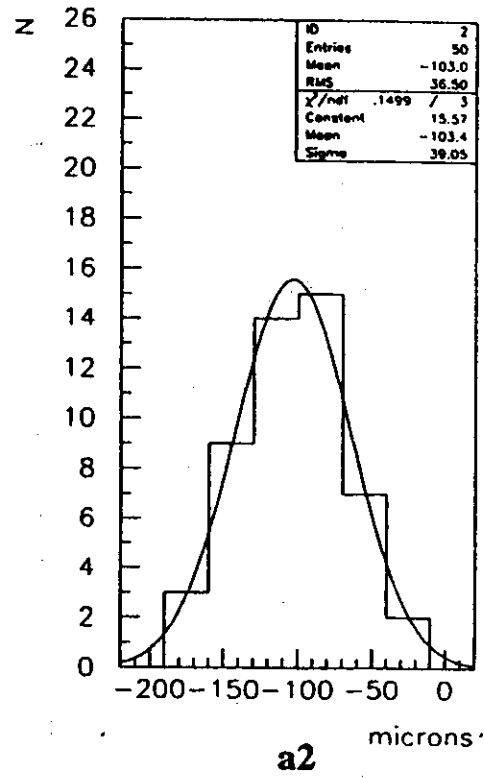
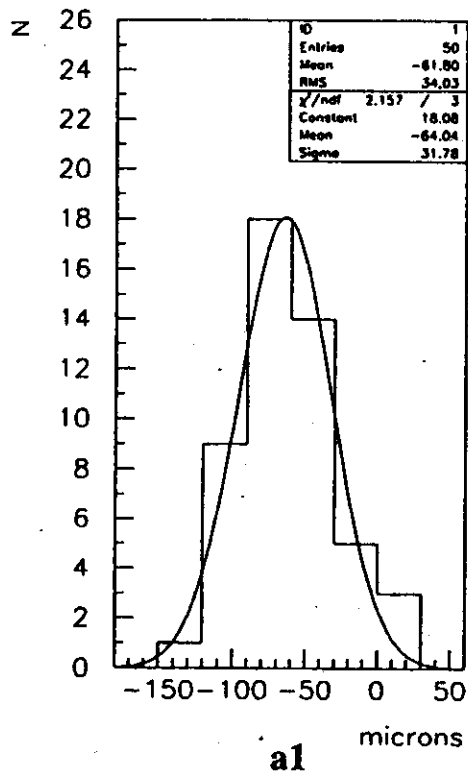
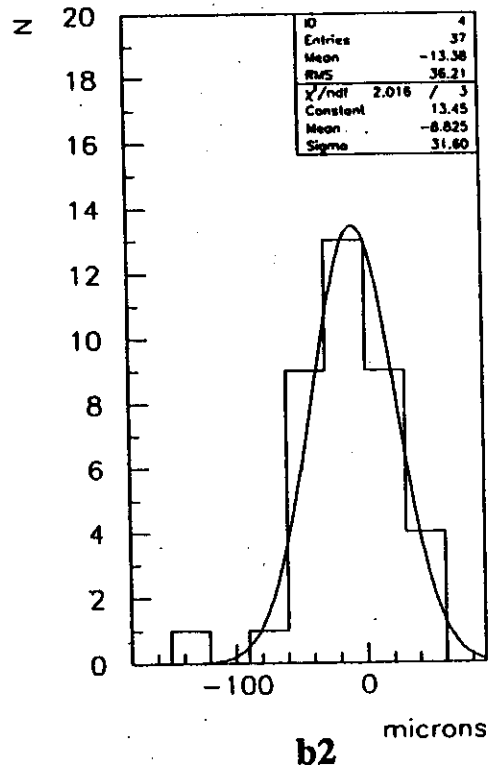
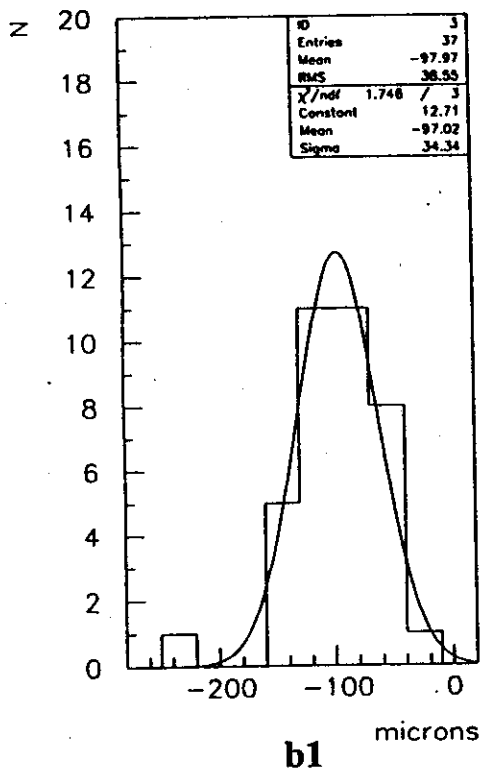
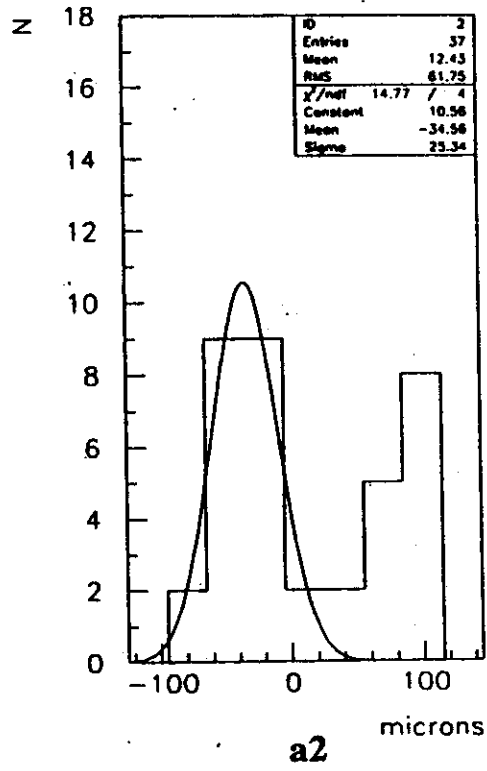
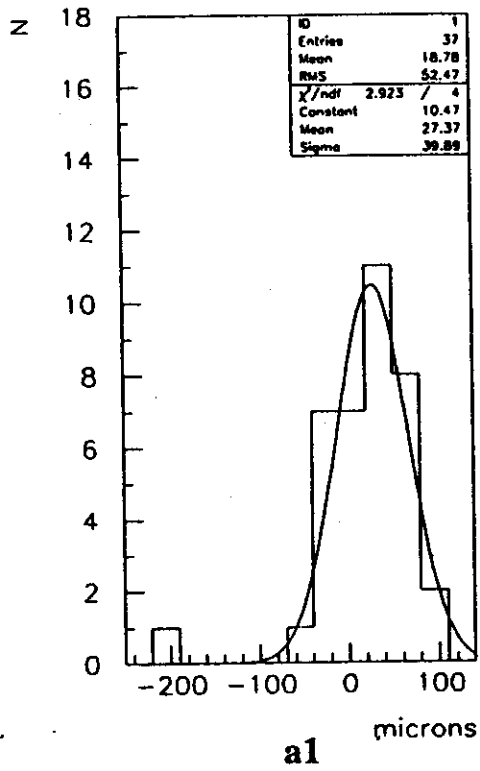

Fig.9. The scheme of spacer #12 measurements.



**Fig.10. Deviations measured data from nominal dimensions for spacer 1.**



**Fig.11. Deviations measured data from nominal dimensions for spacer 2.**

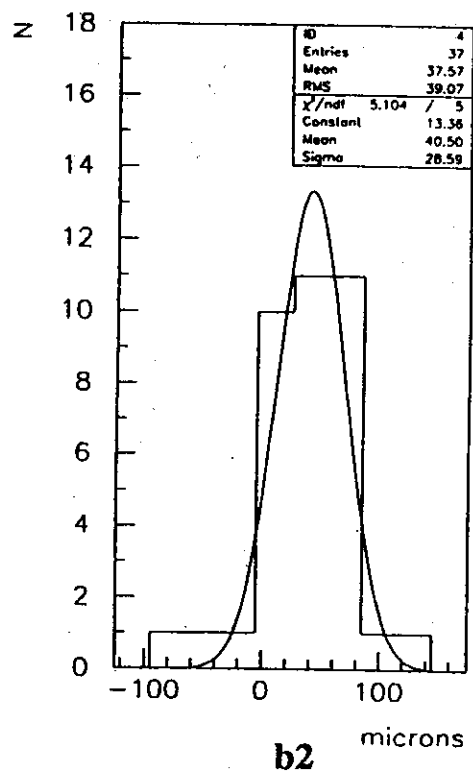
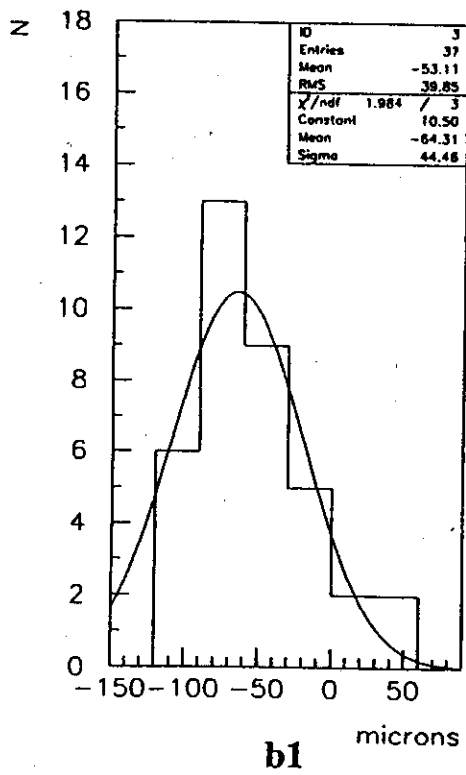
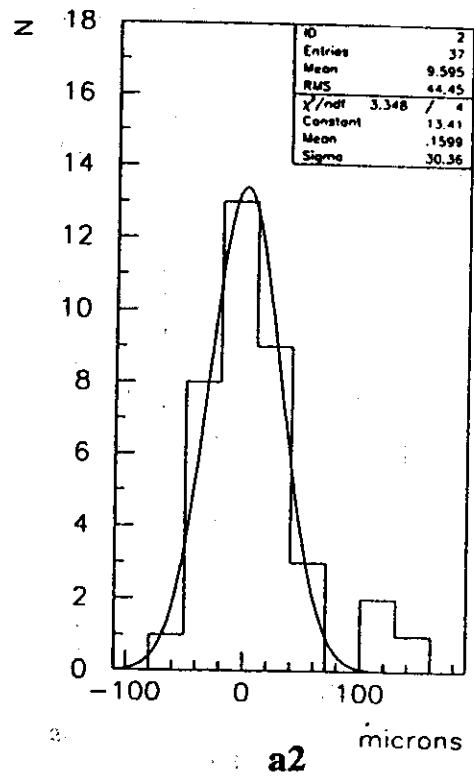
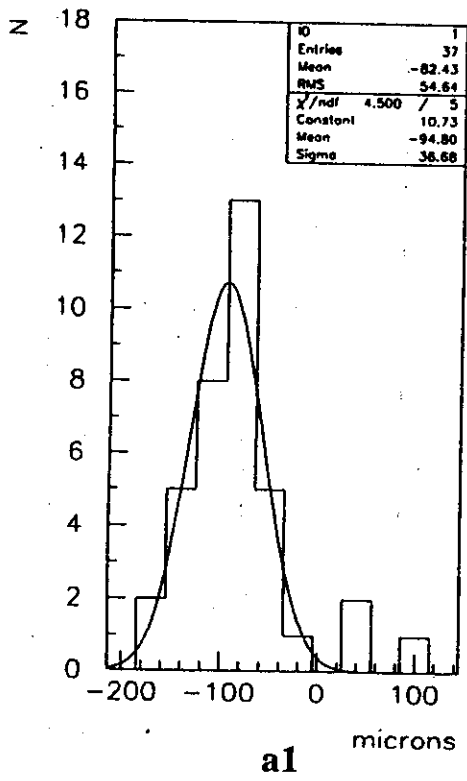

**Fig.12. Deviations measured data from nominal dimensions for spacer 3.**

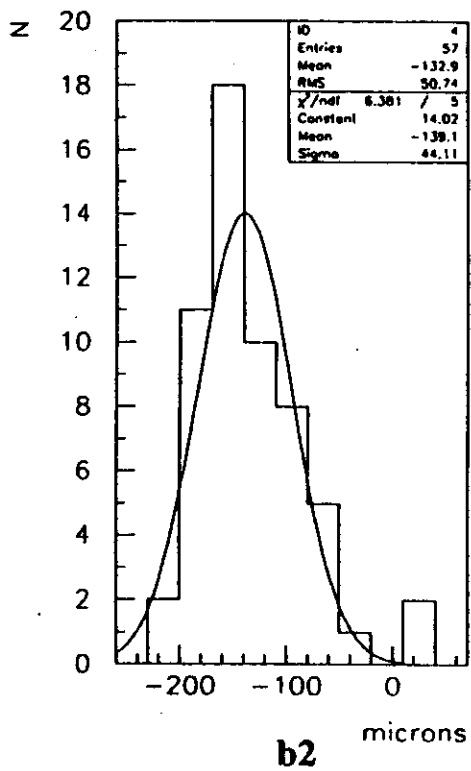
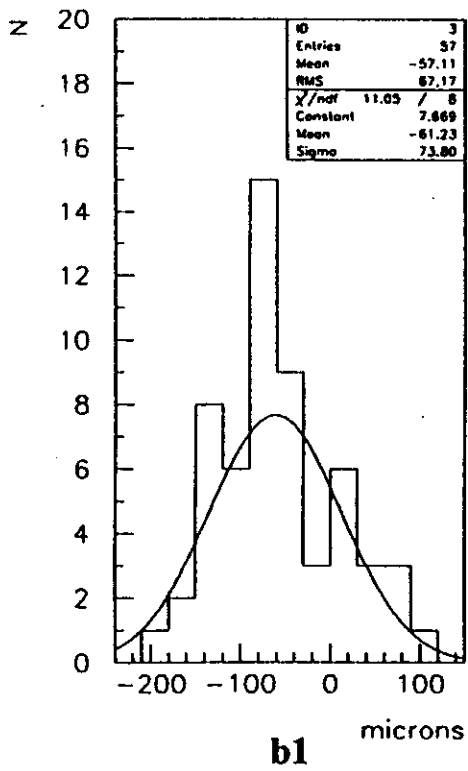
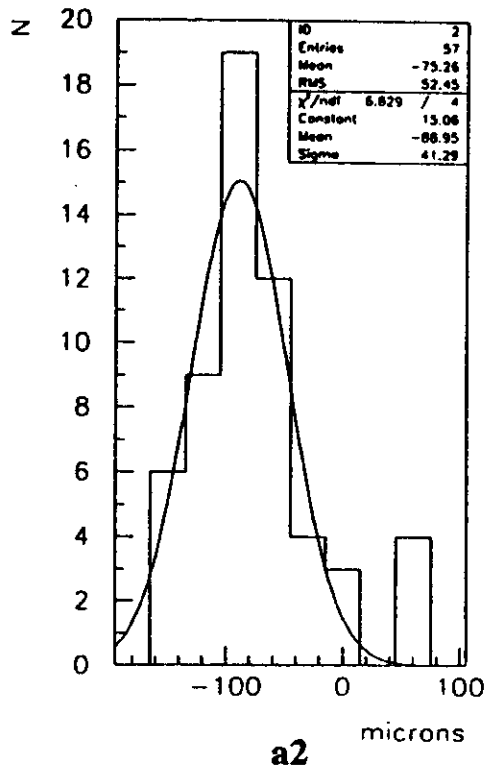
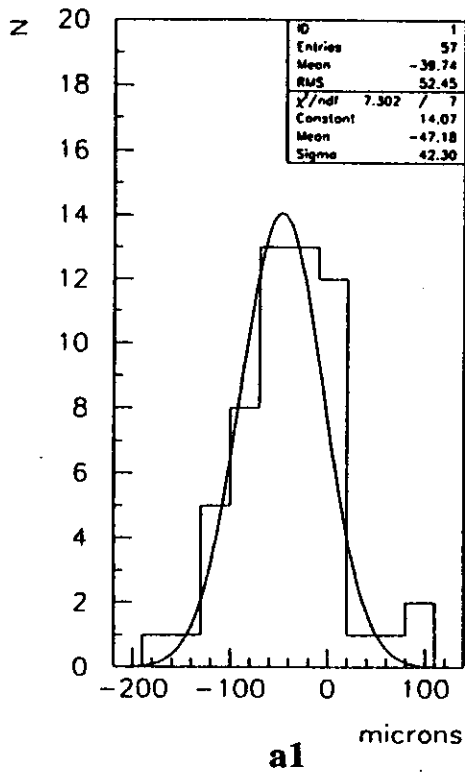

**Fig.13. Deviations measured data from nominal dimensions for spacer 4.**

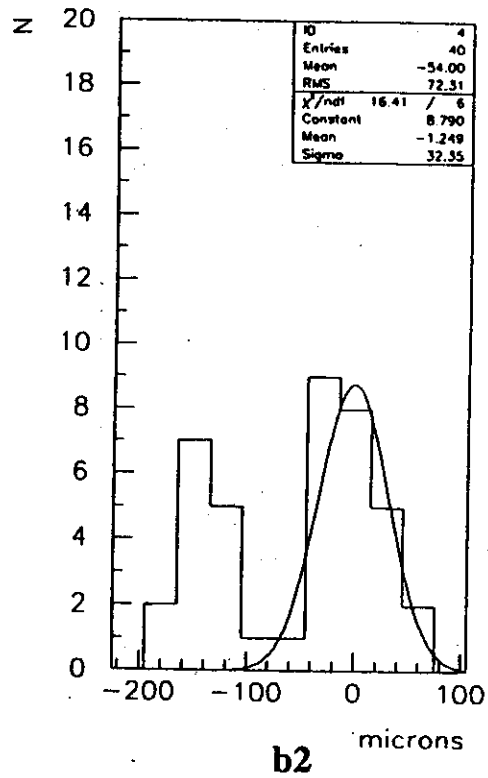
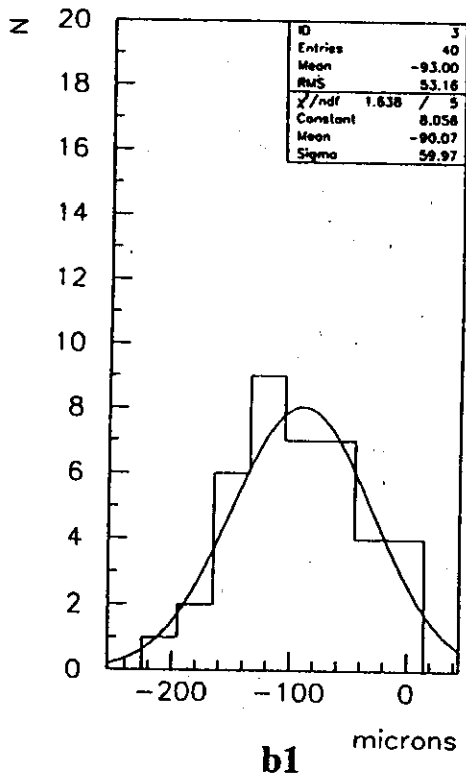
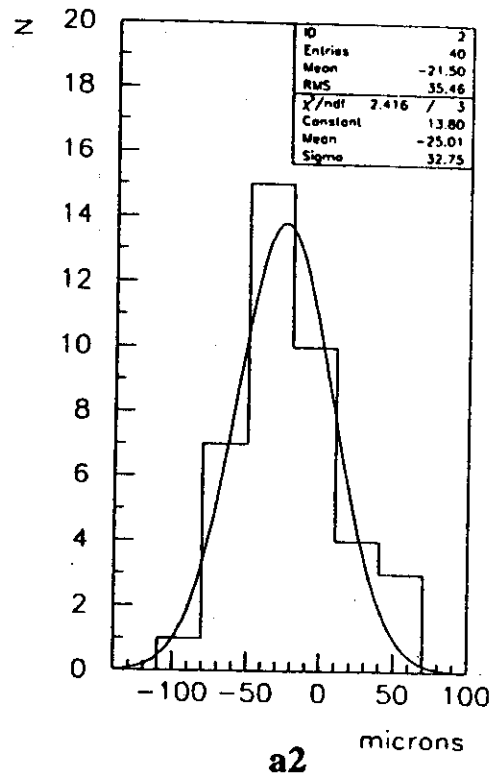
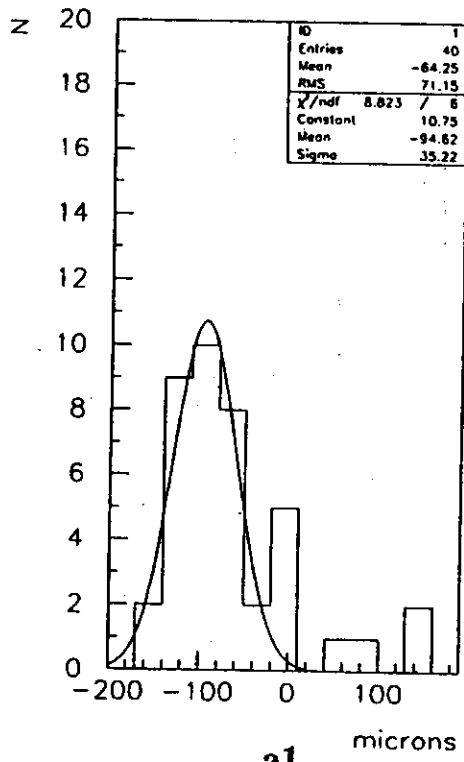
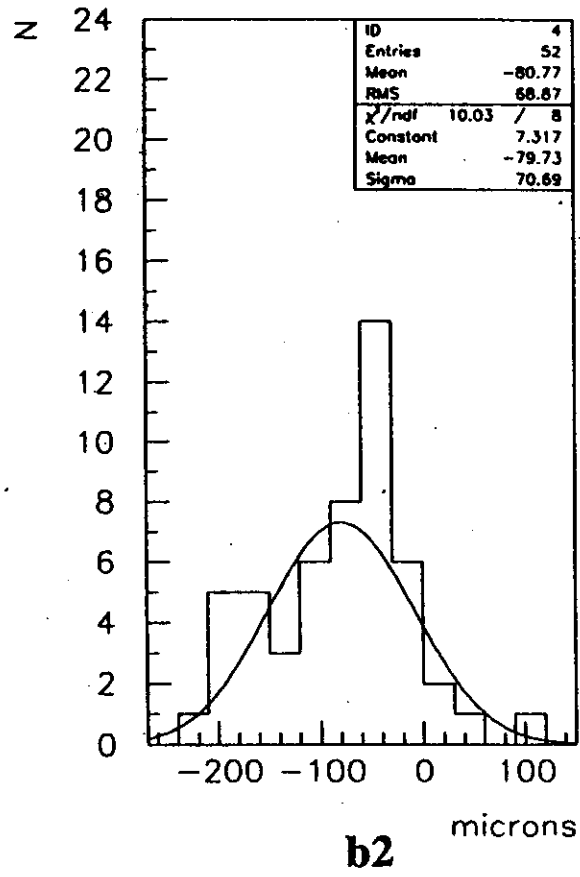
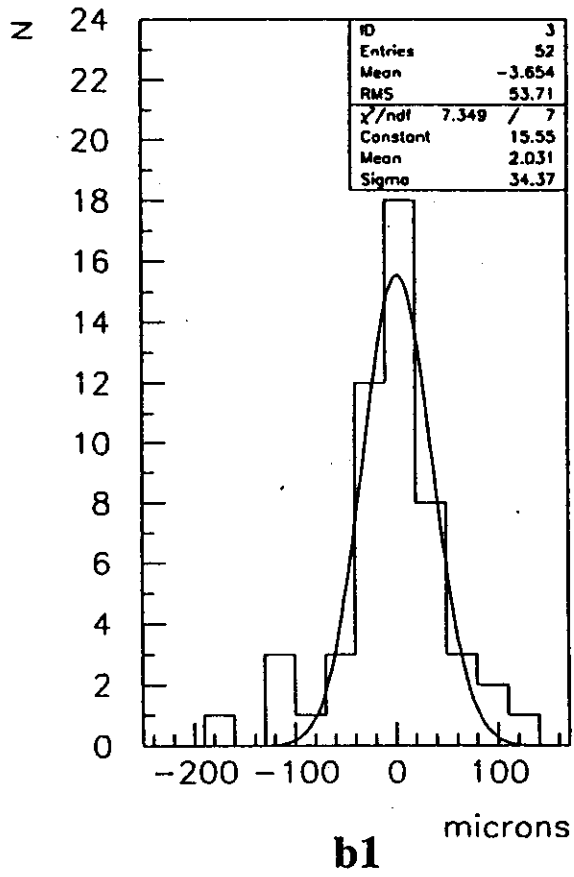
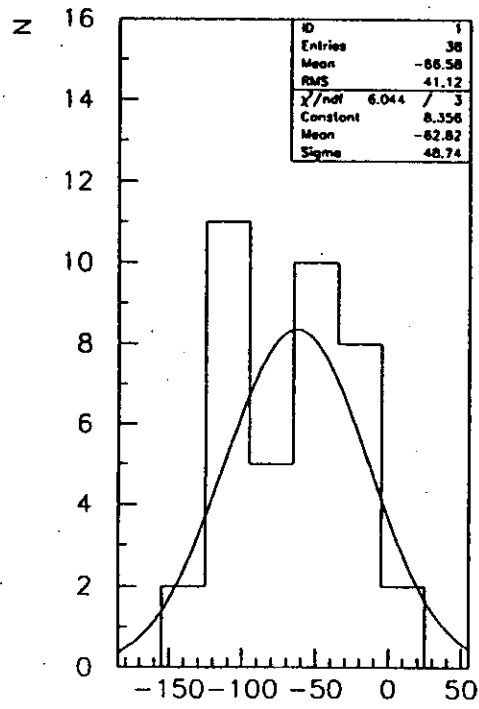

Fig.14. Deviations measured data from nominal dimensions for spacer 5.



**Fig.15. Deviations measured data from nominal dimensions for spacer 6.**



**a1**

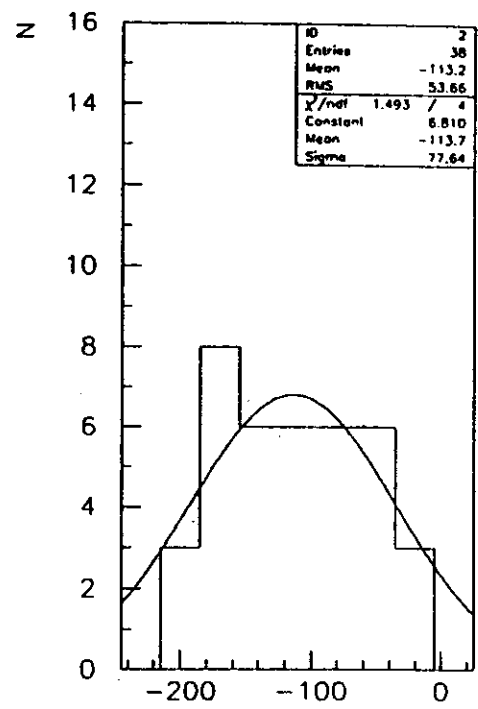

**a2**

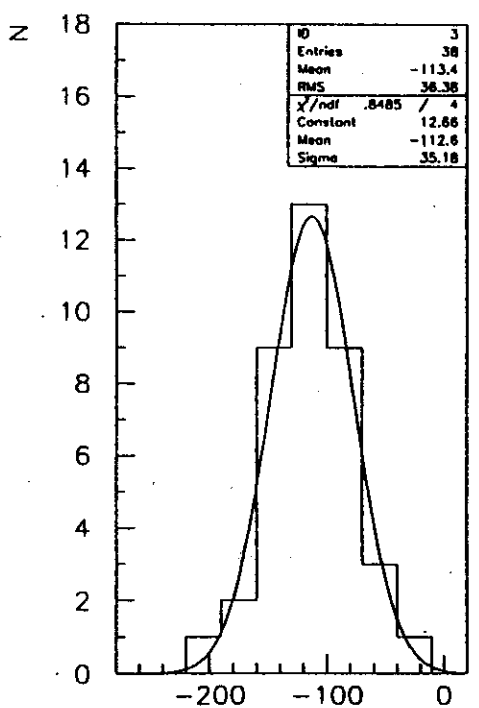

**b1**

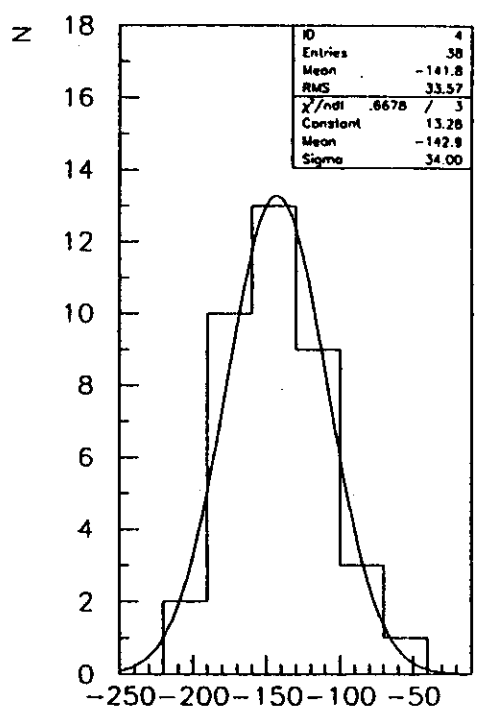

**b2**

**Fig.16. Deviations measured data from nominal dimensions for spacer 7.**



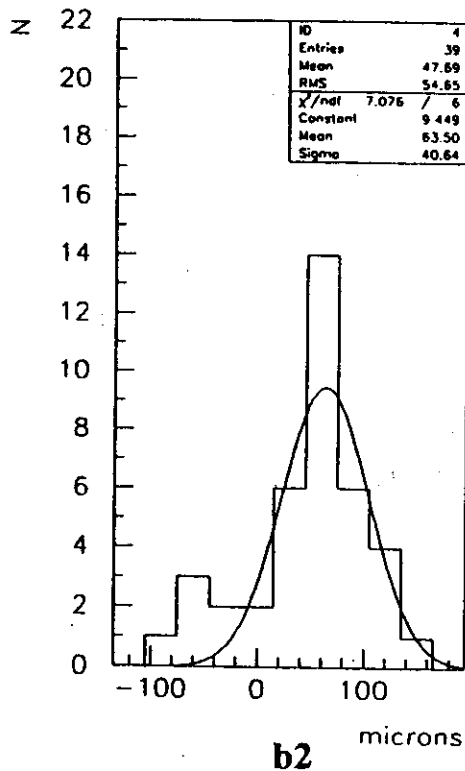
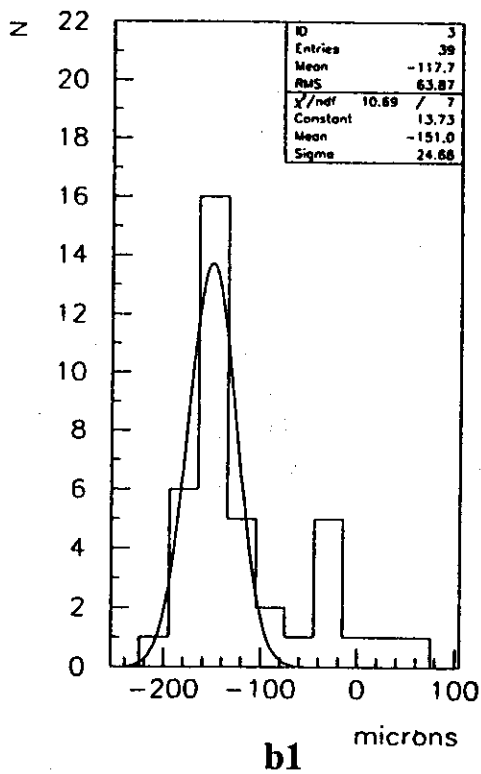
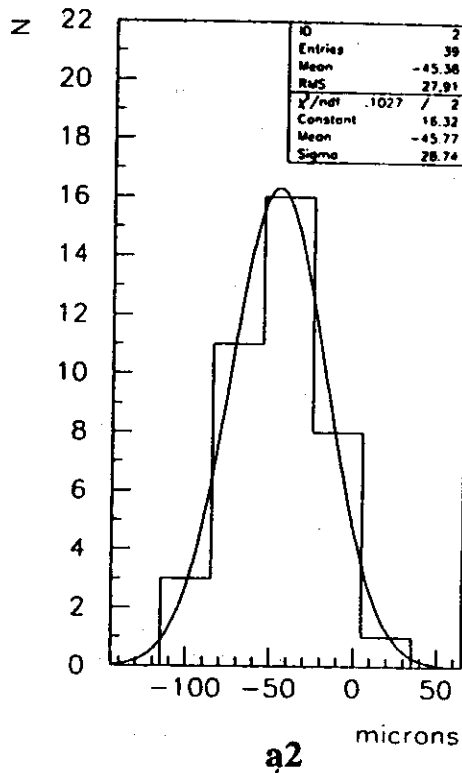
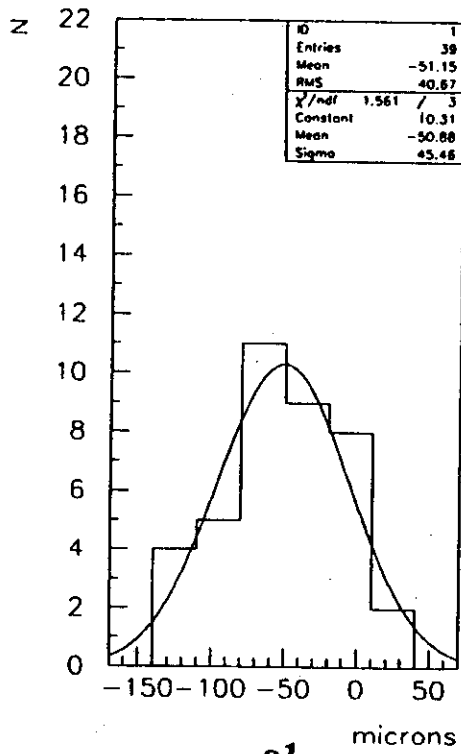
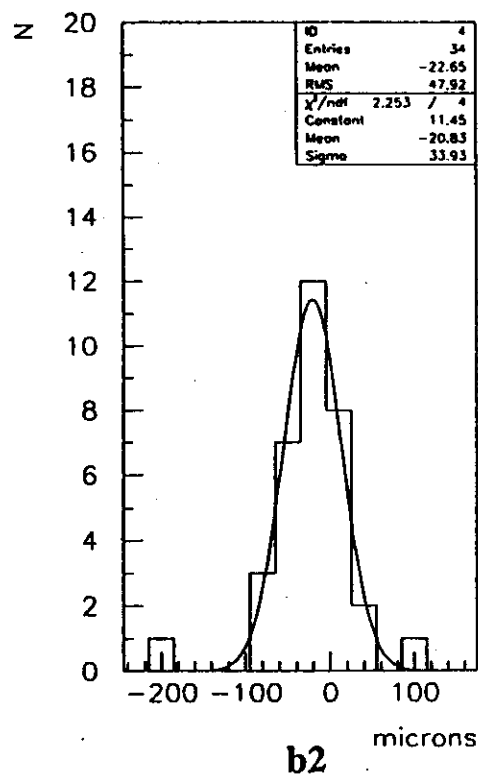
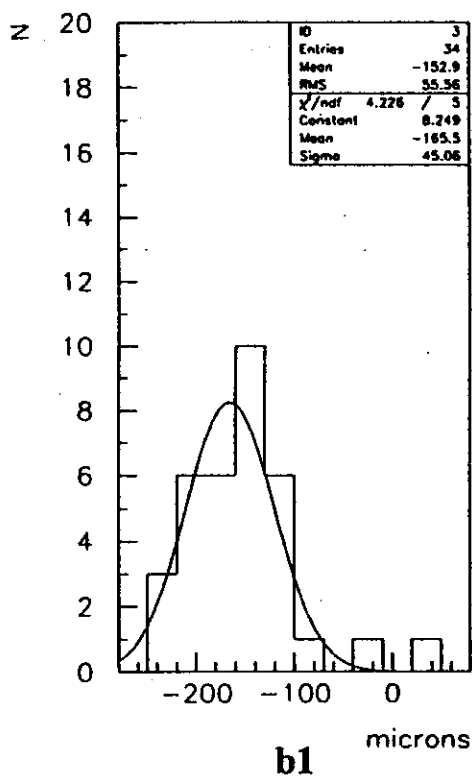
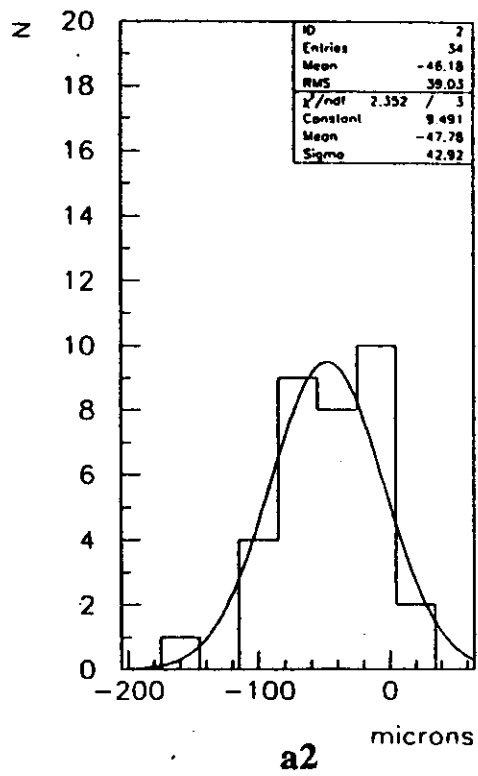
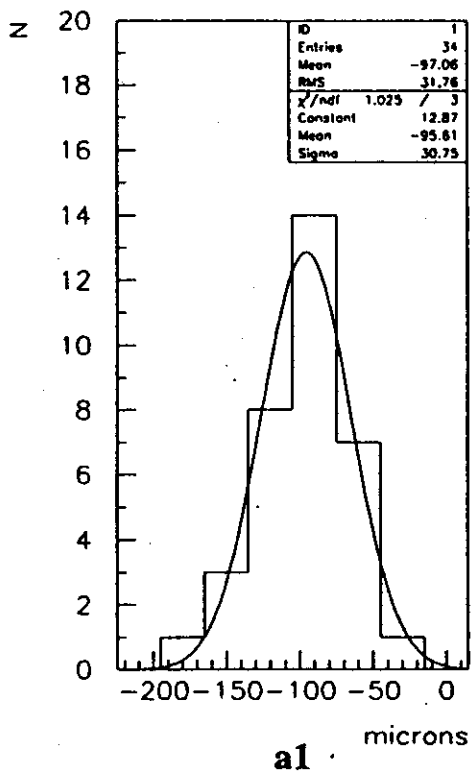

Fig.17. Deviations measured data from nominal dimensions for spacer 8.



**Fig.18. Deviations measured data from nominal dimensions for spacer 9.**

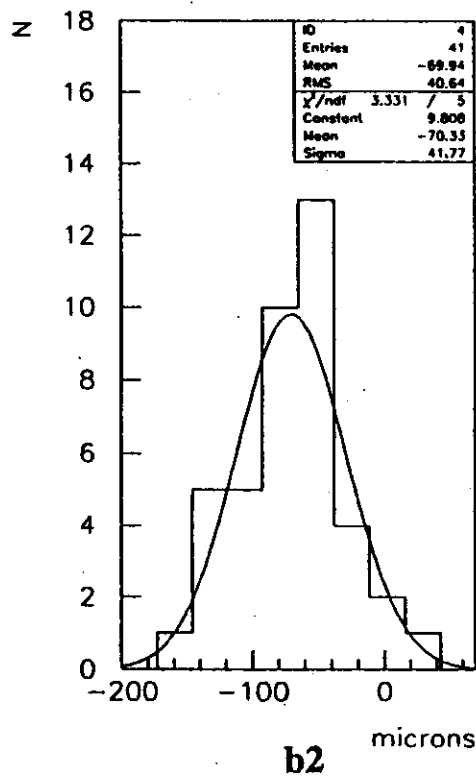
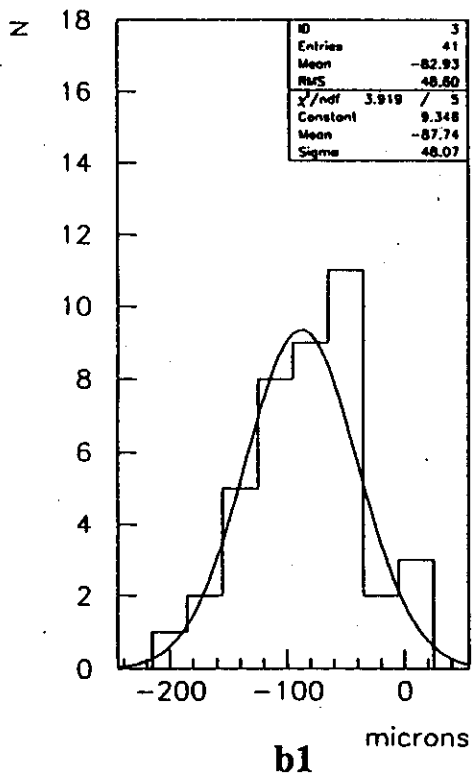
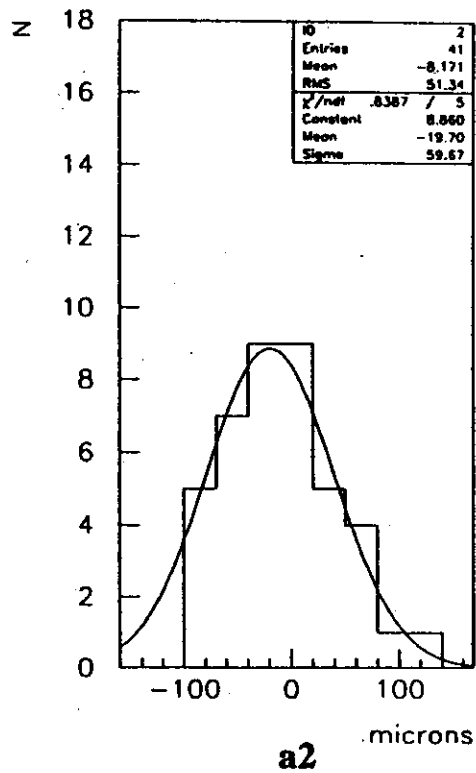
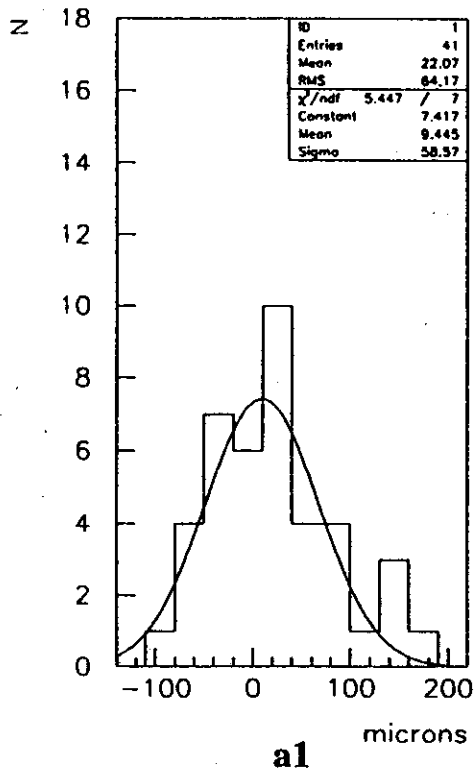

Fig.19. Deviations measured data from nominal dimensions for spacer 10.

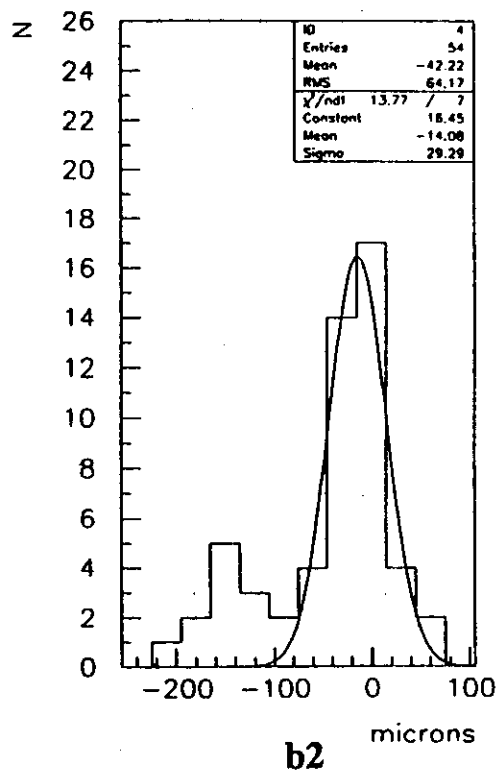
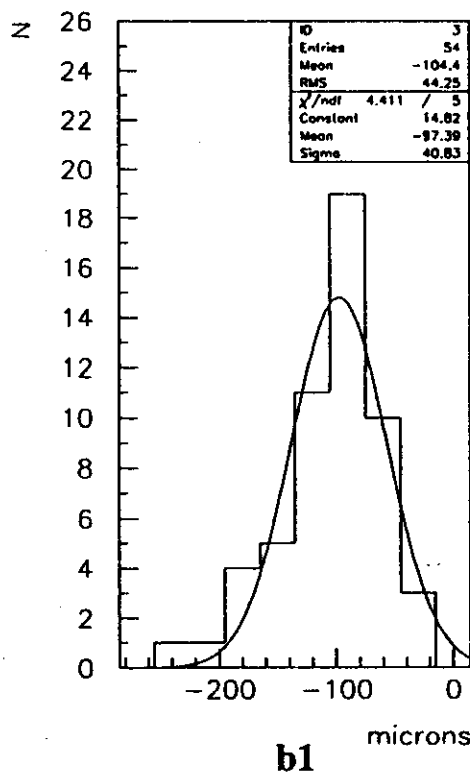
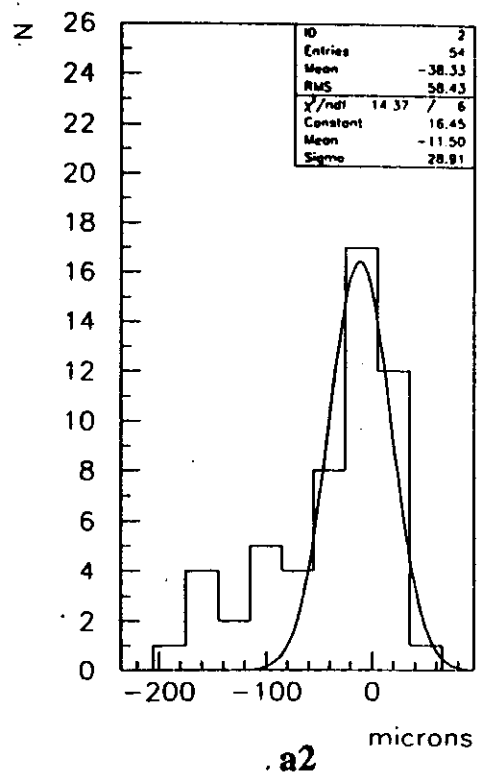
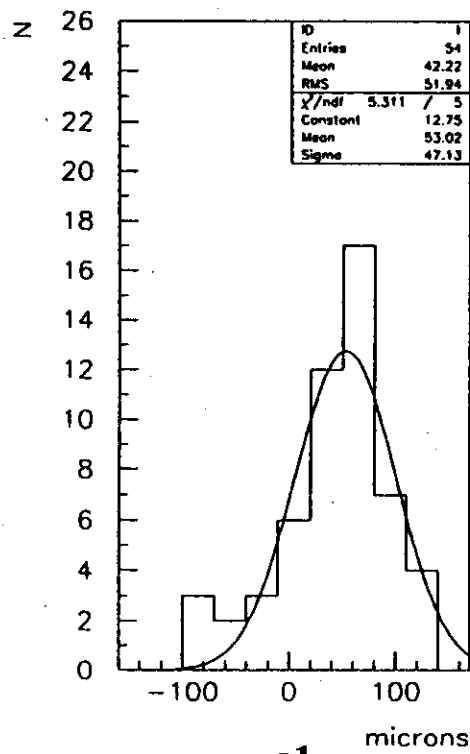
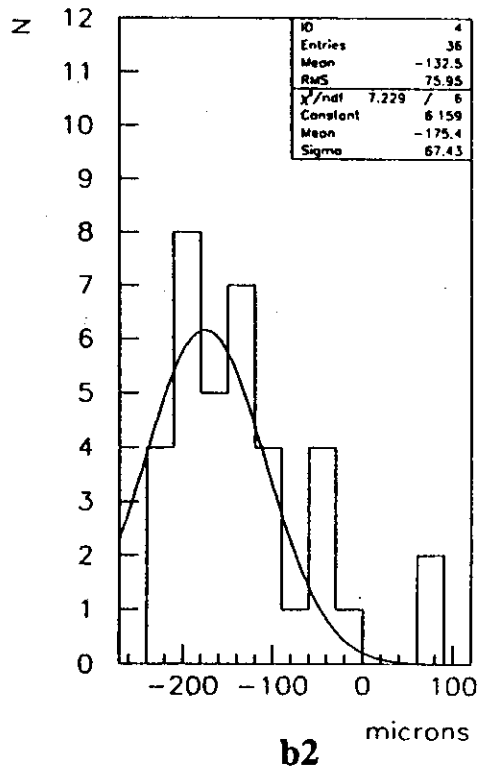
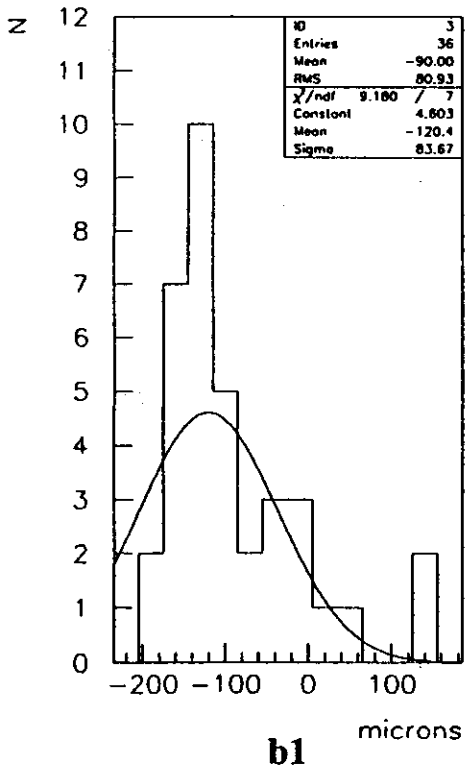
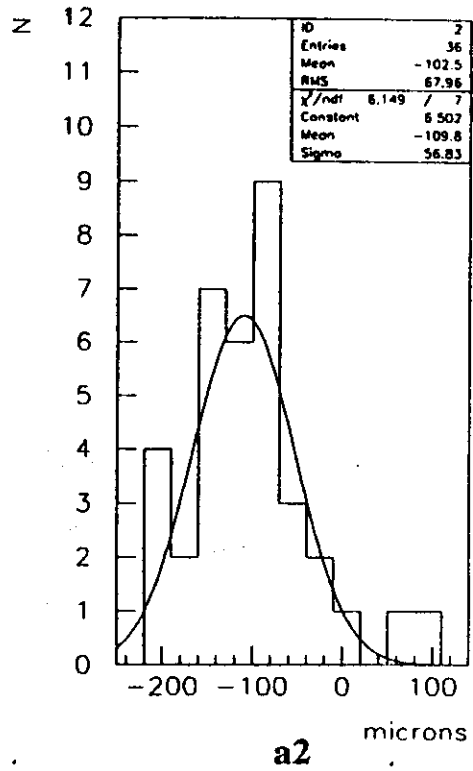
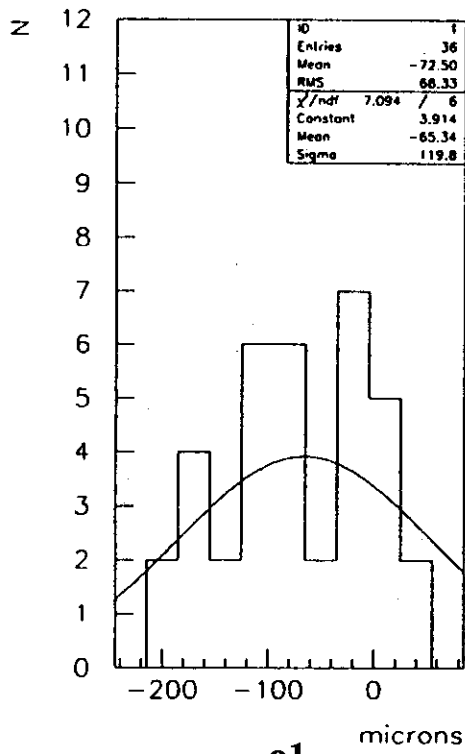
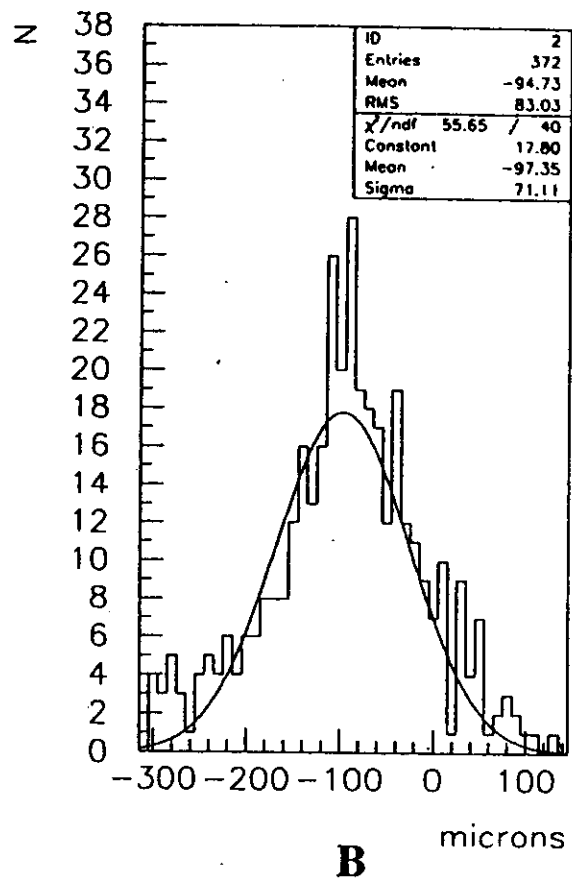
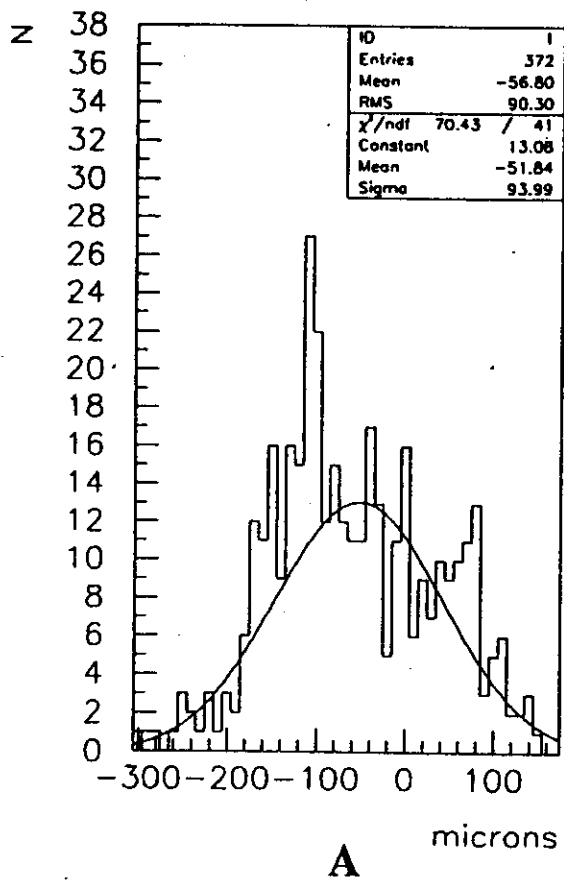

Fig.20. Deviations measured data from nominal dimensions for spacer 11.



**Fig.21. Deviations measured data from nominal dimensions for spacer 12.**



**Fig.22. Deviations measured data from nominal dimensions for spacers 1-12.**

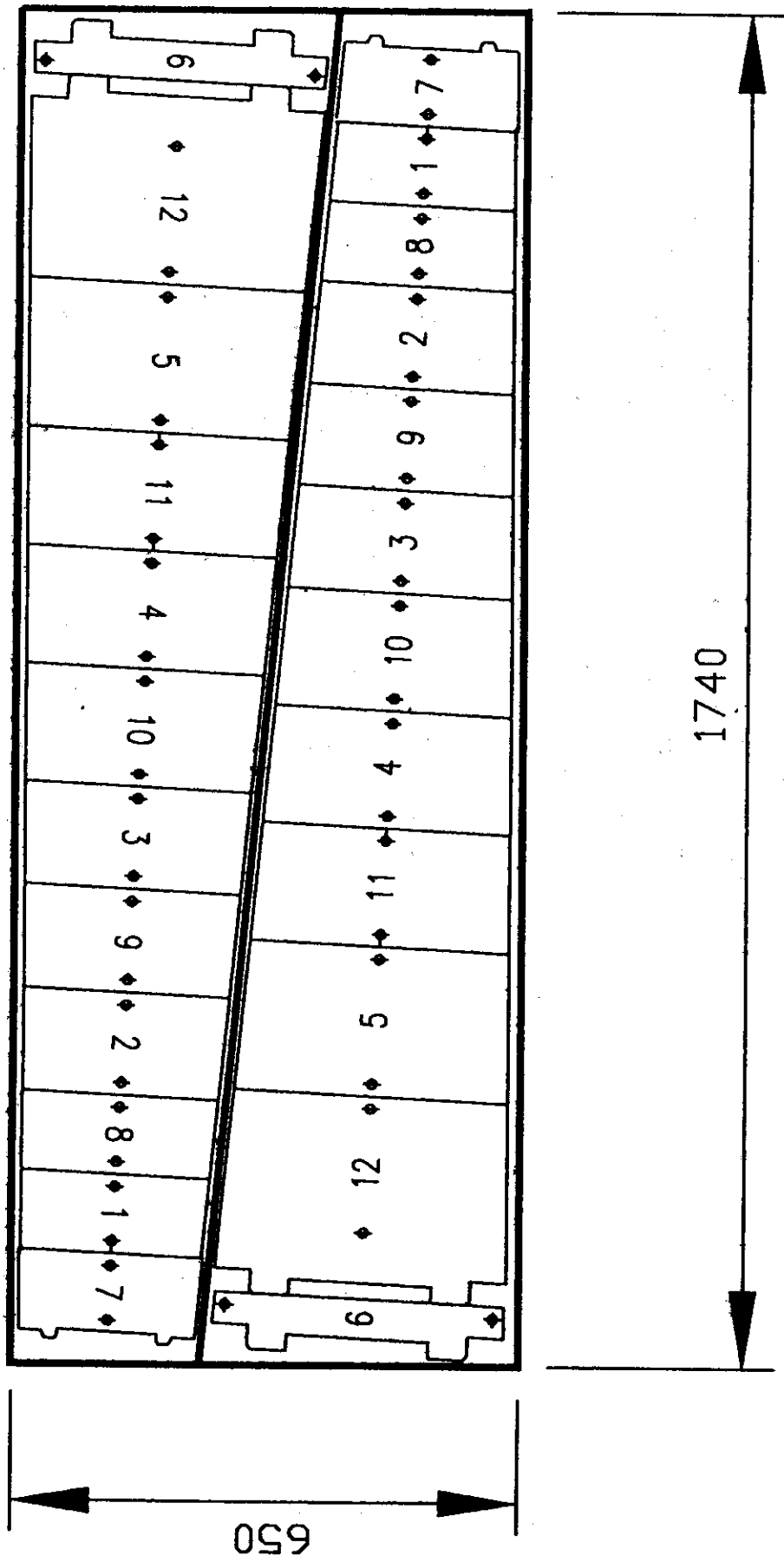

Fig.23. The scheme of packing of spacers sets into boxes.

### **3. Conclusion**

Quite a complex technical task to produce nearly 300000 units of absorber plates with a high mechanic precision was severely complicated by the huge amount of custom problem.

Additional to that on the course of our relatively short spacers plates production period the custom laws both in Russia and Belarus were changing. This painful situation was aggravated by national currencies unstable what made very complicated practically all the payment/transfer actions.

All the above mentioned (and many others) difficulties were finally solved but it took for us the outstanding management efforts.

Successful completion of master plates manufacturing (first half of 1998) and of spacer plates manufacturing (second half of 1998) opened for ATLAS collaboration the way for submodules production start already in December, 1998.

### **References**

1. B.Alikov et al. Recent advances in precision laser cutting for the ATLAS Hadron Calorimeter absorbers production. Preprint of the Joint Institute for Nuclear Research. Dubna, 1995. E13-95-515.
2. B.Alikov et al. ATLAS BARREL HADRON CALORIMETER: General manufacturing concepts for 300000 absorber plates mass production. Communication of the Joint Institute for Nuclear Research. Dubna, 1998. E13-98-135.

Received by Publishing Department  
on March 30, 1999.



**The Publishing Department  
of the Joint Institute for Nuclear Research  
offers you to acquire the following books:**

Index	Title
94-55	Proceedings of the International Bogoliubov Memorial Meeting. Dubna, 1993 (216 p. in Russian and English)
D3,14-95-323	VII School on Neutron Physics. Lectures. Vol.1. Dubna, 1995 (356 p. in Russian and English)
E10,11-95-387	Proceedings of the ESONE International Conference 'RTD'94 on REAL TIME DATA 1994 with Emphasis on Distributed Front-End Processing. Dubna, 1994 (358 p. in English)
D15-96-18	Proceedings of the International Workshop Charge and Nucleon Radii of Exotic Nuclei. Poznan, 1995 (172 p. in Russian and English)
E9-96-21	Proceedings of Vii ICFA Beam Dynamics Workshop on «Beam Issues for Multibunch, High Luminosity Circular Colliders». Dubna, 1995 (198 p. in English)
E2-96-100	Proceedings of the 3rd International Symposium «Dubna Deuteron-95». Dubna, 1995 (374 p. in English)
E2-96-224	Proceedings of the VII International Conference «Symmetry Methods in Physics». Dubna, 1996 (2 volumes, 630 p., in English)
E-96-321	Proceedings of the International Conference «Path Integrals: Dubna'96». Dubna, 1996 (392 p. in English)
E3-96-336	Proceedings of the IV International Seminar on Interaction of Neutrons with Nuclei. Dubna, 1996 (396 p. in English)
E3-96-369	Proceedings of the X International Conference «Problems of Quantum Field Theory». Dubna, 1996 (437 p. in English)
E3-96-507	Proceedings of the International Workshop «Polarized Neutrons for Condensed Matter Investigations». Dubna, 1996 (154 p. in English)
D1,2-97-6	Proceedings of the International Workshop «Relativistic Nuclear Physics: from MeV to TeV». Dubna, 1996 (2 volumes 418 p. and 412 p. in English and Russian)
E7-97-49	Proceedings of the 3rd International Conferense «Dynamical Aspects of Nuclear Fission». Slovakia, 1996 (426 p. in English)
E1,2-97-79	Proceedings of the XIII International Seminar on High Energy Physics Problems. Relativistic Nuclear Physics and Quantum Chromodynamics. Dubna, 1996 (2 volumes, 364 p. and 370 p. in English)
D5,11-97-112	Proceedings of the 9th International Conference «Computational Modelling and Computing in Physics». Dubna, 1996 (378 p. in English)

Index	Title
E2-97-213	Proceedings of the V International Seminar on Interaction of Neutron with Nuclei «Neutron Spectroscopy, Nuclear Structure, Related Topics». Dubna, 1997 (446 p. in English)
E2,4-97-263	Proceedings of the Third International Conference «Renormalization Group'96». Dubna, 1996 (436 p. in English)
E10-97-272	Proceedings of the Data Acquisition Systems of Neutron Experimental Facilities (DANEF'97). Dubna, 1997 (325 p. in English)
D19-97-284	Proceedings of the International Symposium «Problems of Biochemistry. Radiation and Space Biology». Dubna, 1997 (2 volumes 284 p. and 405 p. in Russian and English)
E2-97-413	Proceedings of the VII Workshop on High Energy Spin Physics (SPIN'97). Dubna, 1997 (398 p. in English)

Please apply to the Publishing Department of the Joint Institute for Nuclear Research for extra information. Our address is:

Publishing Department  
 Joint Institute for Nuclear Research  
 Dubna, Moscow Region  
 141980 Russia  
 E-mail: [publish@pds.jinr.dubna.su](mailto:publish@pds.jinr.dubna.su).

Артиков А.М. и др.

E1-99-79

Баррель адронного тайл-калориметра АТЛАС:  
производство спейсерных пластин

Изложены основные проблемы массового производства спейсерных пластин для барреля адронного калориметра установки АТЛАС. Описаны практические решения этих проблем. В частности, представлены схемы измерения спейсеров и методика вычислений их теоретических размеров. Приведены данные этих измерений.

Работа выполнена в Лаборатории ядерных проблем ОИЯИ.

Сообщение Объединенного института ядерных исследований. Дубна, 1999

Artikov A.M. et al.

E1-99-79

ATLAS Barrel Hadron Tile Calorimeter:  
Spacers Plates Mass Production

In this article we expose the main problems of the mass production of the so-called «spacer plates» for the ATLAS Barrel Hadron Tile Calorimeter. We describe all practical solutions of these problems. Particularly we present the measurement procedures and calculation schemes we used for the spacers dimensions determination. The results of the calculations are presented.

The investigation has been performed at the Laboratory of Nuclear Problems, JINR.

Communication of the Joint Institute for Nuclear Research. Dubna, 1999

Макет Т.Е.Попеко

Подписано в печать 22.04.99  
Формат 60 × 90/16. Офсетная печать. Уч.-изд. листов 3,15  
Тираж 410. Заказ 51332. Цена 3 р. 78 к.

Издательский отдел Объединенного института ядерных исследований  
Дубна Московской области