

E1-95-506

ONE SPIN PION ASYMMETRY
IN $d\uparrow + A \rightarrow \pi^{\pm} + X$ PROCESSES
NEAR $\theta_{\pi} = 90^{\circ}$

DISK Collaboration

Submitted to «Ядерная физика»

SCAN-9605070



CERN LIBRARIES, GENEVA

SW 9620

G.S.Averichev, G.Agakishiev, Yu.T.Borzunov, L.G.Efimov, N.Ghiordanescu¹,
L.B.Golovanov, Ja.G.Guseinaliev², Yu.I.Minaev, N.S.Moroz, A.S.Nikiforov,
Yu.A.Panebratsev, E.V.Potrebenikova, M.Pentia³, S.V.Razin, N.Saveljic⁴, G.Škoro⁵,
E.I.Shahaliev, S.S.Shimanskiy, M.K.Suleimanov⁶, M.V.Tokarev, I.Tsvetkov,
V.V.Trofimov, V.I.Yurevich, I.Zborovsky⁷, A.P.Zvinev

¹Bucharest University, Romania

²Azerbaijan National Aero-Cosmic Agency

³Bucharest IEA, Romania

⁴University of Montenegro, Podgorica, Yugoslavia

⁵INS «Vinca», Belgrade, Yugoslavia

⁶PI, Academy of Sciences of the Azerbaijan Republic

⁷NPI, Academy of Sciences of the Czech Republic

1. Introduction

In the beam energy range from pion production threshold up to 1 GeV the single pion production channel in the $N\uparrow + N \rightarrow N + N + \pi^{\pm,0}$ were extensively studied [1]. The discovery of dramatic structure in the spin dependent proton-proton observables just above pion threshold has aroused interest in the spin effects in pion production mechanisms. In these experiments the large value of the vector analyzing power A_y for backward pion production was observed. They provided accurate data to understand the reaction mechanisms and to constrain the models of strong interactions at intermediate energies.

The studies of polarization phenomena in $p - p$ [2, 3, 4] and $p - A$ [5] reactions at high energies show that one spin pion asymmetry (or analyzing power) does not vanish with increasing transverse momentum p_T and scaling variable x_F . Asymmetry measurements in the $p\uparrow + p \rightarrow \pi^{\pm,0} + X$ inclusive processes performed at CERN [2], BNL [3] and Fermilab [4] show that asymmetry is similar to zero up to $x_F \simeq 0.3$ and then increase linearly up to the absolute value of 40 % near $x_F \simeq 1$. It was, also, observed the correlation between the asymmetry sign and pions charge [4]. Large one spin asymmetries have been also measured in $p\uparrow + d \rightarrow \pi, K + X$ reactions at proton momentum of 11.75 GeV/c [5].

In order to explain these results and asymmetry mechanism, considerable theoretical work has been undertaken. The large number of theoretical models based on spin-dependent mechanisms of the quark interactions [6, 7, 8] has been developed. Results of these studies indicate that the asymmetry could be a consequence of orbital motion of the valence quarks in a polarized proton [6]. In the frame of the parton model, asymmetry is related to the spin-dependent parton distributions [9], parton cross-sections [10] and parton fragmentation functions [11].

In [12] the mechanism, based on the quark interaction with the nonperturbative vacuum fluctuations of gluon field, was proposed [13]. As a result of such an interaction, the spin of polarized quark flips and simultaneously $q\bar{q}$ -pair is produced. The spins of the sea partons are directed opposite to the spin direction of the valence quark. The sign of the orbital momentum of the $q\bar{q}$ -pair is defined according to the total momentum conservation law. It is proposed that in pp interactions this mechanism contribute at high energies and for high p_T ($x_F \rightarrow 1$, $p_T > 1$ GeV/c). By using relativistic nuclei beams these conditions can be reached kinematically. Because of this, the significant effects in the "cumulative" region (the region kinematically forbidden for secondary particle from nucleon - nucleon collision) are expected. Relativistic beam of polarized deuterons at the LHE JINR Dubna Synchrophasotron opens the possibility to answer the questions about the spin effects in the transition region from nucleon to quark degrees of freedom and to investigate the behaviour of asymmetry in the cumulative region.

The main goal of this experiment is to study of the vector analyzing power (A_y) in the energy region where we are expected the transition from nucleons to quarks degrees of freedom. In the following sections we discuss the experimental method and present the results of measurements of one spin asymmetries in the $d\uparrow + H \rightarrow \pi^{\pm} + X$ and $d\uparrow + C \rightarrow \pi^{\pm} + X$ reactions near the 90° in the laboratory frame at incident beam momenta from 3 to 9 GeV/c.

2. Experimental method

The experiments were carried out at the Laboratory of High Energies (JINR). Figure

1 shows the experimental setup for measurement of analyzing power A_y . We used the magnetic spectrometer DISK and a polarized deuteron beam in the momentum range from 3 to 9 GeV/c delivered by the Dubna SYNHROPHASOTRON.

2.1. Beam

Polarized deuterons were produced by the source "POLARIS" [14]. The intensity of the beam was in the range $10^8 \div 5 \cdot 10^9$ particles per spill. The beam width of about 7 mm full width at half maximum (FWHM) was determined by the coordinate detector placed in front of the target. We have used three spin state method (no rotation of apparatus) where the beam polarization direction was changed after every spill in order to minimize the systematic errors in the experiment.

The measurements of the polarization of the deuteron beam have been performed by the ALPHA setup [15]. The typical values of the parameters for the "up" (+) and "down" (-) states of the beam polarization are given in the Table 1.

Table 1. The parameters of beam polarization: states.

tensor	$p_Z^+ = 0.210 \pm 0.010$	$p_{ZZ}^+ = -0.712 \pm 0.028$
polarization	$p_Z^- = 0.202 \pm 0.018$	$p_{ZZ}^- = 0.686 \pm 0.021$
vector	$p_Z^+ = 0.43 \pm 0.03$	$p_{ZZ}^+ \simeq 0$
polarization	$p_Z^- = -0.47 \pm 0.03$	$p_{ZZ}^- \simeq 0$

2.2. Target region

A schematic view of the target, magnetic spectrometer "DISK" and the monitoring system is shown in Fig.1. During the experiment we used carbon ^{12}C target with effective thickness of 5.6 g/cm^2 and liquid hydrogen target. The flask of the liquid hydrogen target was built using a thin (0.35 mm) Mylar and measuring 70 mm in diameter. The flask was surrounded by low density insulation and kept in vacuum.

A relative intensity of the secondary particles has been measured by the scintillator telescopes (M+10, M-10, MPB) while the ionization chamber (NT) monitored an intensity of the primary beam.

2.3. Spectrometer

The detailed description of the magnetic spectrometer "DISK" is given in [16], so only a brief description follows. The angle, at which the measurements have been performed (78° and 90° in our case), was defined by the position of the magneto-optical channel of the spectrometer consisted of the analyzing magnet (M1) and the doublet of quadrupole lenses (Q1, Q2). Input angle acceptance of the spectrometer was $\Omega(p) = 6 \cdot 10^{-4} sr$. The momentum of the secondary particles was determined using the value of magnetic field in the gap of the analyzing magnet. The momentum resolution was $\Delta p/p = 0.086$. An identification of secondary particles have been carried out using : a) the time of flight (TOF) informations on two bases - between scintillator counters S1 and S3 (length of 3.8 m) and between S2 and S4 (0.97 m); b) the ionization losses in scintillators S2, S3, S4 and c) intensity of Cherenkov radiation of particles in two hard radiators (Č1 and Č2). The typical TOF spectra of positively charged particles having momentum of 400 MeV/c on the 3.8 m base length are shown in Fig.2.

2.4. Asymmetry determination

In accordance with the usual conventions [17], a Cartesian coordinate system was assumed with **z**-axis along the incident beam momentum, **y**-axis was defined to be normal to the scattering plane and parallel to the direction of incident deuteron spin and **x**-axis to define a right-handed coordinate system. Then, the pion production cross-section may be written in the form:

$$\sigma(\theta)^\pm = \sigma_0(\theta) \cdot \left(1 + \frac{3}{2}p_Z^\pm A_y(\theta) + \frac{1}{2}p_{ZZ}^\pm A_{yy}(\theta)\right), \quad (1)$$

where "+", "-", "0" denote the corresponding beam spin states. $\sigma_0(\theta)$ is the pion production cross-section for the unpolarized beam, $A_y(\theta)$ and $A_{yy}(\theta)$ are the vector and tensor analyzing powers of the reaction, respectively and θ is the angle at which the measurement is performed. A Cartesian description of the beam polarization states p_Z^\pm and p_{ZZ}^\pm was also used where Z was related to the deuteron source coordinate system. For tensor polarization of the beam (see eq.(1)) can be solved for $A_y(\theta)$:

$$A_y(\theta) = \frac{2}{3} \cdot \left\{ \frac{p_{ZZ}^-}{p_Z^+ p_{ZZ}^- - p_Z^- p_{ZZ}^+} \left(\frac{\sigma(\theta)^+}{\sigma_0(\theta)} - 1 \right) - \frac{p_{ZZ}^+}{p_Z^+ p_{ZZ}^- - p_Z^- p_{ZZ}^+} \left(\frac{\sigma(\theta)^-}{\sigma_0(\theta)} - 1 \right) \right\}, \quad (2)$$

while for the vector beam polarization, where $p_{ZZ}^\pm \simeq 0$, we have:

$$A_y(\theta) = \frac{2}{3} \cdot \left(\frac{\sigma(\theta)^+ - \sigma(\theta)^-}{\sigma_0(\theta)} \right) / (p_Z^+ - p_Z^-). \quad (3)$$

Because the asymmetry is measured by means of ratios of pion production cross-sections, it is not necessary to perform the measurement of absolute value of beam intensity. However, in order to avoid influences of "false asymmetries" and others possible systematic uncertainties, the accuracy and stability of the beam and secondary particles relative intensity monitoring are essential. It is estimated that the systematic error on asymmetry in our experiment does not exceed (2-5)% . In particular this conclusion is based on the direct high accuracy measurements of asymmetry of the protons production. In the region where expected value should be zero we have got the value of "one spin asymmetry" equal to 0.005 ± 0.026 .

3. Experimental results and discussion

3.1. One spin pion asymmetry in the $d^\dagger + H \rightarrow \pi^\pm + X$ processes

The asymmetries of positively and negatively charged pions with momenta in the range $300 \div 350 \text{ MeV}/c$ as a function of incident beam momentum are shown in Fig.3a. The measurements were performed at angle of 90° in the laboratory system. The large value of A_y at the level of about 40 % has been observed at relatively low beam momenta. The asymmetry sign is a function of pion charge and asymmetry values decrease with increasing beam momentum.

Figs.3b and 3c show the Monte Carlo (MC) calculated relative contribution of different channels of pion production in the reaction $d + H \rightarrow \pi^- + X$, for $\theta_\pi = 90^\circ$ at two beam momenta - 4 and 9 GeV/c. We have used MC code [18] which very well describes the

experimental results (multiplicities, p_T spectra, cross-sections) in the hadron-nucleus and nucleus-nucleus interactions at intermediate and high energies [19]. As can be seen in Figs.3b and 3c, the behaviour of one spin pion asymmetry could be connected with the mechanisms of pion production. At 4 GeV/c beam momentum, where large asymmetry has been observed in the experiment (Fig.3a), the negatively charged pions are produced mostly through the Δ^0 -"resonance" channels. At 9 GeV/c beam momentum (small asymmetry region) pions predominantly originate from the "direct" processes. The similar picture can be drawn up for positively charged pions where, at low beam momenta, dominate Δ^{++} -channel of π^+ -meson production. In short, the results of MC simulations indicate that the pion analyzing power is strongly affected by the contribution of the intermediate Δ -resonance states.

Fig.4a shows the one spin π^- -meson asymmetry, measured at beam momentum of 6.5 GeV/c , as a function of pion momentum. The asymmetry sign is negative. Absolute value of π^- -meson asymmetry reaches $\simeq 50\%$ at $p_\pi = 200$ MeV/c and decreases with increasing pion momentum. Such a behaviour of one spin asymmetry coincides with suppression of "resonance" channels of π^- -meson production (Fig.4b).

The next set of the data, taken at 8.9 GeV/c beam momentum, is shown in Fig.5. The vector analyzing power of inclusive pions is similar to zero at low pion momenta. Especially interesting is the behaviour of asymmetry at higher pion momenta. It exists theoretical arguments [20], based on relativistic deuteron model [21], that for the pion momentum of about 600 MeV/c the one spin pion asymmetry should starts changing the sign as a result of the influence of the deuteron D -wave. Moreover, these kinematical conditions correspond to the "cumulative" region where, due to nonperturbative quark interactions, the rise of the absolute value of asymmetry is expected. Neglecting the some indication of such a behaviour, to answer this very important question better experimental information is needed.

3.2. One spin pion asymmetry in the $d\uparrow + C \rightarrow \pi^\pm + X$ processes

In the case of carbon target at beam momentum of 3.8 GeV/c , the positive π^+ -meson asymmetry was observed and its value is about few percents (Fig.6a). Comparing the results of MC simulations presented in the Fig.6b with the corresponding results for a hydrogen target, one could expect the similar effect (large asymmetry) because the Δ^{++} -channel of pion production dominates in both cases. However, high background produced by the target fragmentation in the $d\uparrow - C$ collision, in addition to the significant pion rescattering in nucleus, hardly suppress the observation of the effect.

At beam momentum of 6.5 GeV/c , one spin π^+ -meson asymmetry is close to zero in the pion momentum range from 200 to 400 MeV/c (Fig.7a). One spin π^- -meson asymmetry for 300 MeV/c pion momentum has the value $A_y = (2.2 \pm 1.1)\%$. In this kinematical region the Δ^- -channel of π^- -meson production dominate (Fig.7b). It should be noted that the sign of the one spin π^- -meson asymmetry differs from the corresponding one observed in the hydrogen target case. This could indicate that the type of the intermediate Δ -resonance state involved is essential for the sign of the pion analyzing power.

The signs of the one spin pion asymmetry observed in the experiment and MC calculated most important pions "sources" in the corresponding kinematical regions are presented in Table 2.

Table 2. Signs of asymmetry in the $d\uparrow + A \rightarrow \pi(90^\circ) + X$ process.

reaction	$A_y^{\pi^+}$	$A_y^{\pi^-}$
$d\uparrow + H$	$+(\Delta^{++})$	$-(\Delta^0)$
$d\uparrow + C$	$+(\Delta^{++})$	$+(\Delta^-)$

As can be seen, the one spin pion asymmetry sign is strongly correlated with the type of the resonance involved.

4. Conclusions

The one spin asymmetry in the $d\uparrow + H \rightarrow \pi^\pm + X$ and $d\uparrow + C \rightarrow \pi^\pm + X$ processes has been measured for the first time. The experiment was performed at JINR Dubna Synchrotron using the polarized deuteron beam with momenta in the range from 3 to 9 GeV/c. The results can be summarized as follows:

1) Large one spin pion asymmetry (up to 50 %) in the $d\uparrow + H \rightarrow \pi^\pm + X$ processes at deuteron momenta $p_d = 3.5 \div 6.5$ GeV/c and for $p_\pi = 300 \div 350$ MeV/c has been measured. The different asymmetry signs, positive for π^+ and negative for π^- , were observed. The absolute value of asymmetry decreases with increasing beam momentum p_d and pion momentum p_π ;

2) Positive sign and non zero values ($\simeq 5$ %) of the one spin pion asymmetry in the $d\uparrow + C \rightarrow \pi^+ + X$ process at beam momentum $p_d = 3.8$ GeV/c were found;

3) The results of simulation show that resonance channels of pion productions play an important role in kinematical regions where measured one spin pion asymmetry has a significant value.

Acknowledgments

The authors would like to thank the members of the ALPHA group, the staff of the LHE accelerator complex and the "POLARIS" source. Special thanks go to our colleague D. Salihagić for help during the MC simulations. This work was supported in part by the Russian Foundation for Fundamental Research, Grant No. 95-02-05061.

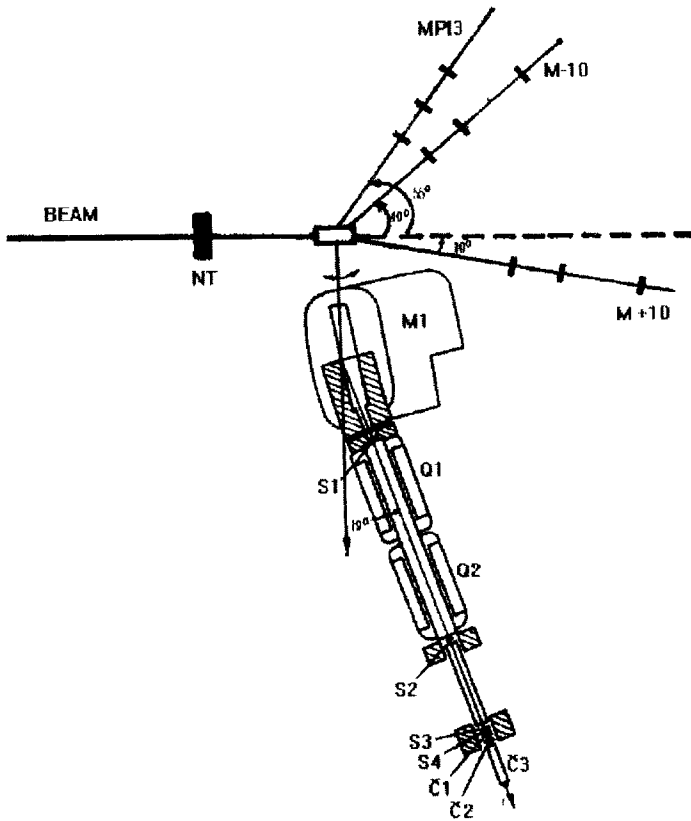

Figure 1. Experimental layout.

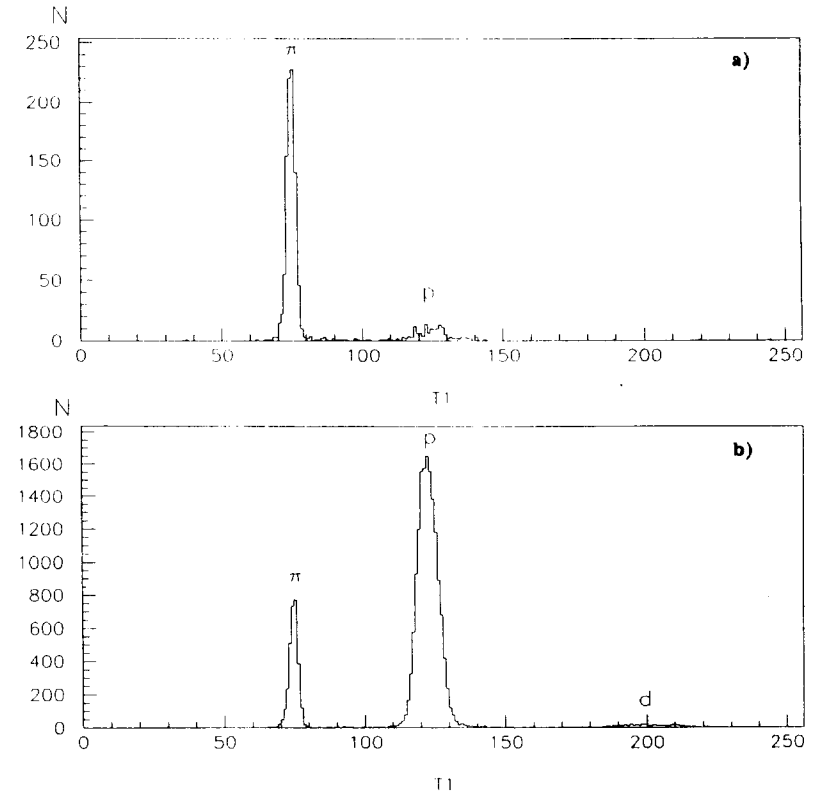

Figure 2. The TOF spectra of positively charged particles ($p = 400 \text{ MeV}/c$) from a) $d\uparrow - H$ and b) $d\uparrow - C$ collisions on the 3.8 m base length.

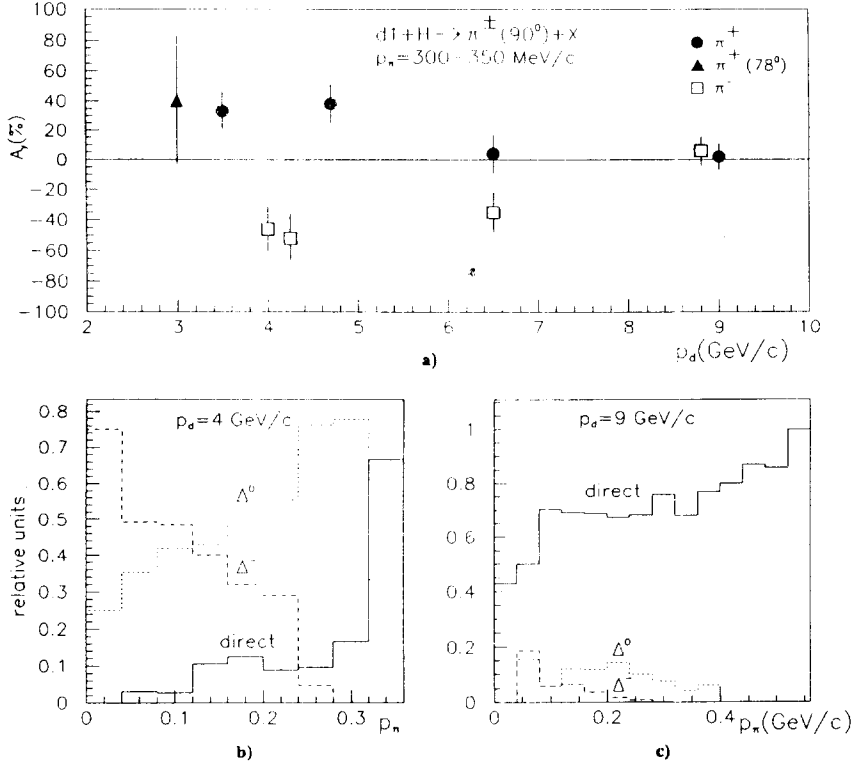

Figure 3. a) The dependence of the asymmetries of positively and negatively charged pions from the reactions $d + H \rightarrow \pi^\pm + X$, ($p_\pi = 300 \div 350 \text{ MeV}/c$), as a function of incident beam momentum; b) MC calculated relative contribution of different channels of pion production in the $d + H \rightarrow \pi^- + X$ process, ($p_d = 4 \text{ GeV}/c$), as a function of pion momentum; c) the same as in b) but for $p_d = 9 \text{ GeV}/c$.

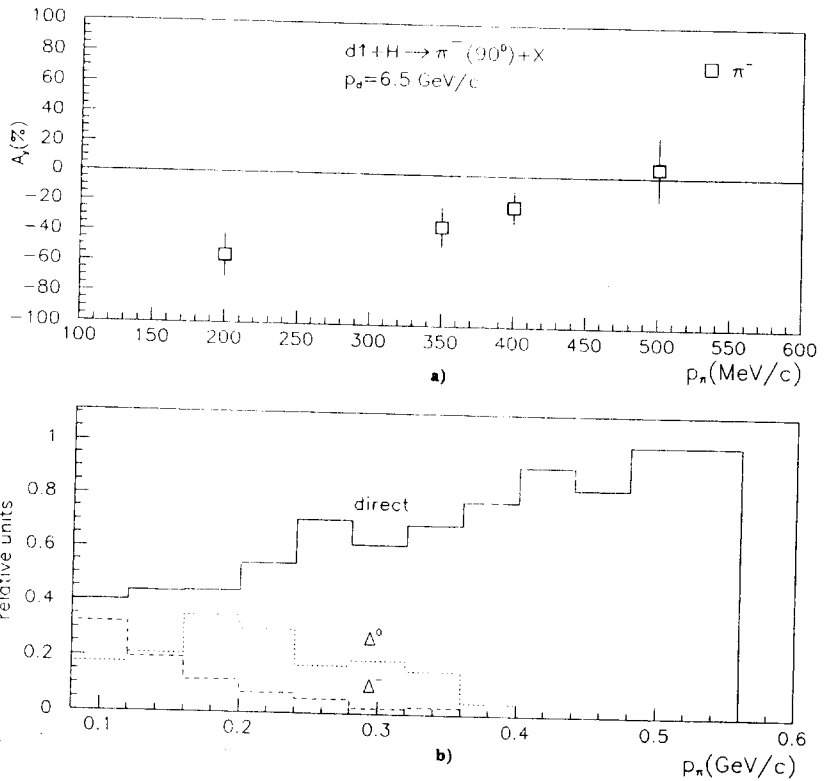

Figure 4. a) The dependence of the one spin asymmetry in the reaction $d^\uparrow + H \rightarrow \pi^- + X$, ($p_d = 6.5$ GeV/c), as a function of pion momentum; b) the same as in Fig. 3b but for $p_d = 6.5$ GeV/c.

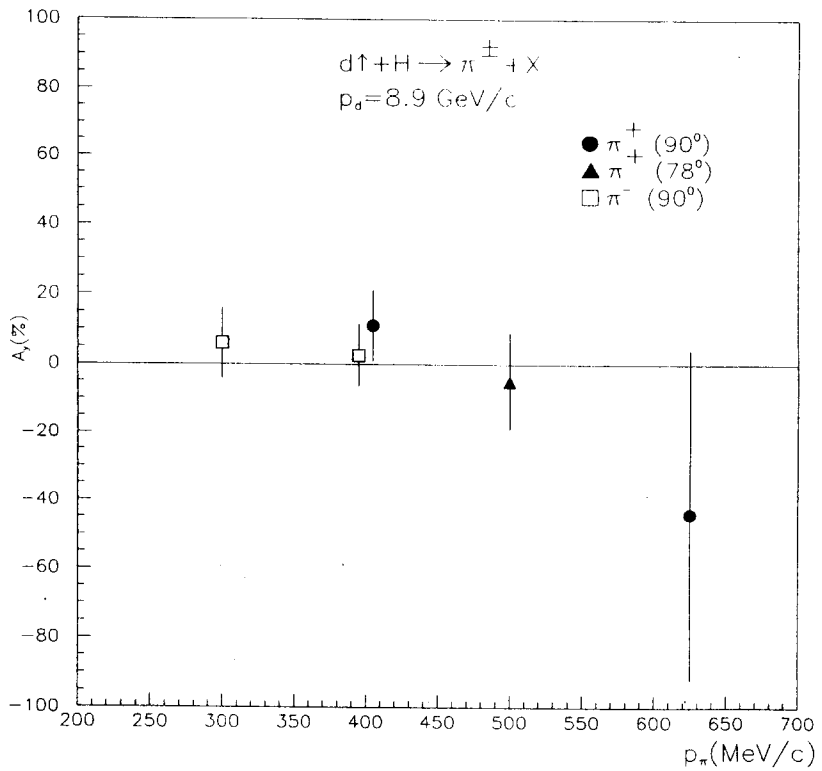

Figure 5. The dependence of the one spin asymmetry in the $d\uparrow + H \rightarrow \pi^\pm + X$ reactions on pion momentum at beam momentum of $8.9 \text{ GeV}/c$.

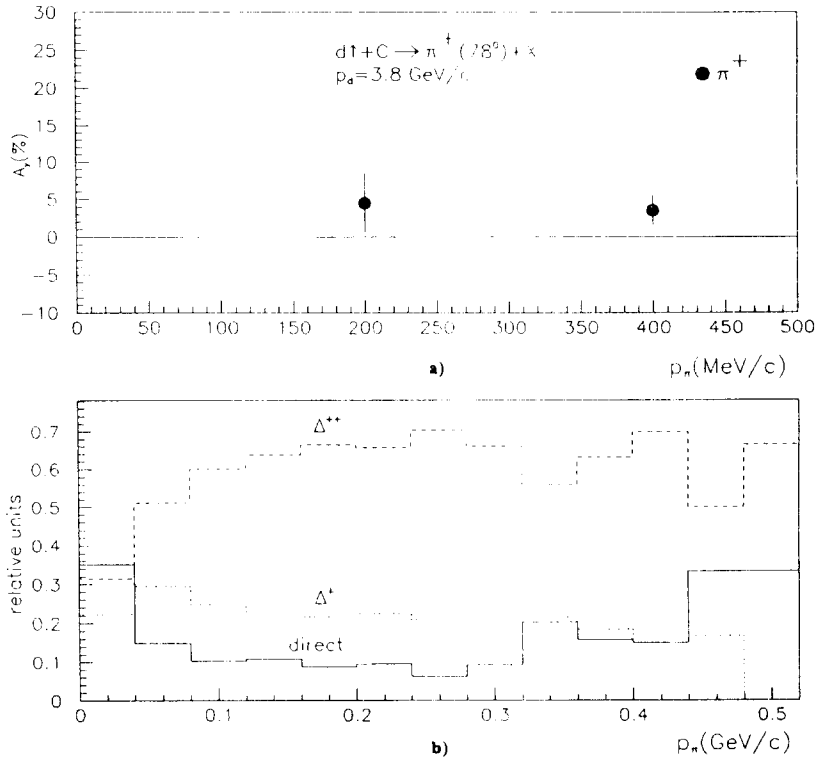

Figure 6. a) The dependence of the one spin asymmetry in the $d^\dagger + C \rightarrow \pi^\dagger + X$ reaction as a function of pion momentum at $p_d = 3.8$ GeV/c; b) MC calculated relative contribution of different channels of pion production in the $d + C \rightarrow \pi + X$ reaction as a function of pion momentum at $p_d = 3.8$ GeV/c.

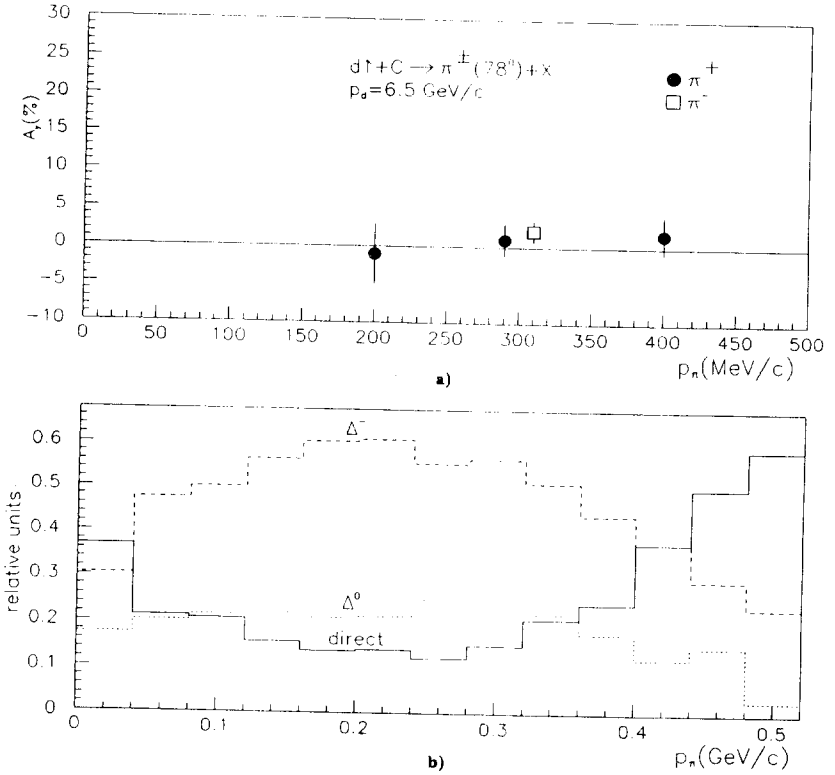

Figure 7. a) The dependence of the one spin asymmetry in the $d^\dagger + C \rightarrow \pi^\pm + X$ reactions as a function of pion momentum at $p_d = 6.5$ GeV/c; b) the same as in Fig.6b but for π^- -meson and at 6.5 GeV/c beam momentum.

References

- [1] A.D. Hancock et al., Phys. Rev. C, **27** (1983) 2742; T.S. Bhatia et al., Phys. Rev. C, **28** (1983) 2071; Y. Terrien et al., Phys. Lett. **B294** (1992) 40; C. Comptour, DAPNIA/SPhN 94 05, Saclay, 1994.
- [2] J. Antille et al., Phys. Lett. **B94** (1980) 523.
- [3] B. E. Bonner et al., Phys. Rev. **D41** (1990) 13; S. Saroff et al., Phys. Rev. Lett. **64** (1990) 995.
- [4] D. L. Adams et al., Phys. Lett. **B261** (1991) 201; D. L. Adams et al., Phys. Lett. **B264** (1991) 462; D. L. Adams et al., Z. Phys. **C56** (1992) 181; D. L. Adams et al., Phys. Lett. **B276** (1992) 531.
- [5] W.H. Dragoset et al., Phys. Rev. **D18** (1978) 3939.
- [6] Liang Zuo-tang, Meng Ta-chung, Phys. Rev. **D42** (1990) 2380; FU Berlin preprint, FUB-HEP/91-8; C.Boros,Liang Zuo-tang, Meng Ta-chung, Phys. Rev. Lett. **70** (1993) 1751.
- [7] X.Artru, H.Yabuki, J.Czyzewski, Preprint LYCEN/9423, TPJU 12/94, May 1994.
- [8] J. Antille et al., Phys. Rev. **D23** (1981) 1227; Phys. Rev.**D24** (1981) 2419.
- [9] D.Sivers, Phys. Rev. **D41** (1990) 83; Phys. Rev.**D43** (1991) 261.
- [10] J. Szwed, Phys. Lett.**B105** (1981) 403.
- [11] J. Collins, Nucl. Phys **B396** (1993) 161.
- [12] N.I. Kochelev, M.V. Tokarev, Phys. Lett. **B309** (1993) 416.
- [13] A.E. Dorokhov, N.I. Kochelev, Phys. Lett. **B259** (1991) 335; A.E. Dorokhov, N.I. Kochelev, Yu.A. Zubov, Int. J. Mod. Phys. **A8** (1993) 603.
- [14] A.A. Belushkina et al., JINR, E13-80-500, (1980), Dubna
- [15] V.G. Ableev et al., Nucl. Instr. and Meth. **A306** (1991) 73.
- [16] G.S. Averichev et al., JINR Rapid Communication N4-[37]-89 (1989), Dubna.
- [17] G. G. Ohlsen, P. W. Keaton Jr, Nucl. Instr. and Meth. **109** (1973) 41.
- [18] N.S. Amelin et al., Yad. Fiz. **52** (1990) 272.
- [19] S. Backović et al., Phys. Rev. **C46** (1992) 1501.
- [20] M.V. Tokarev, G.Škoro, JINR Preprint, E2-95-501, Dubna, 1995.

- [21] M.A. Braun, M.V. Tokarev, *Particles and Nuclei* **22** (1991) 1238.
- [22] G. Agakishiev et al., *Proc. Int. Symp. "DUBNA DEUTERON - 93"*, Dubna (1994) 354.
- [23] V. Flaminio et al., *Preprint CERN-HERA 84-01*, Geneva(1984).

Received by Publishing Department
on December 8, 1995.

Принимается подписка на препринты, сообщения Объединенного института ядерных исследований и «Краткие сообщения ОИЯИ».

Установлена следующая стоимость подписки на 12 месяцев на издания ОИЯИ, включая пересылку, по отдельным тематическим категориям:

Индекс	Тематика	Цена подписки на год
1.	Экспериментальная физика высоких энергий	22600 р.
2.	Теоретическая физика высоких энергий	59200 р.
3.	Экспериментальная нейтронная физика	7800 р.
4.	Теоретическая физика низких энергий	23400 р.
5.	Математика	14800 р.
6.	Ядерная спектроскопия и радиохимия	12000 р.
7.	Физика тяжелых ионов	2200 р.
8.	Криогеника	1400 р.
9.	Ускорители	12200 р.
10.	Автоматизация обработки экспериментальных данных	12200 р.
11.	Вычислительная математика и техника	14300 р.
12.	Химия	1200 р.
13.	Техника физического эксперимента	21300 р.
14.	Исследования твердых тел и жидкостей ядерными методами	7200 р.
15.	Экспериментальная физика ядерных реакций при низких энергиях	2600 р.
16.	Дозиметрия и физика защиты	2200 р.
17.	Теория конденсированного состояния	12200 р.
18.	Использование результатов и методов фундаментальных физических исследований в смежных областях науки и техники	1800 р.
19.	Биофизика	1800 р.
	«Краткие сообщения ОИЯИ» (5—6 выпусков)	15000 р.

Подписка может быть оформлена с любого месяца года.

Организациям и лицам, заинтересованным в получении изданий ОИЯИ, следует перевести (или отправить по почте) необходимую сумму на расчетный счет 000608905 Дубненского филиала ММКБ, г.Дубна Московской области, п/инд. 141980 МФО 211844, указав: «За подписку на издания ОИЯИ».

Во избежание недоразумений необходимо уведомить издательский отдел о произведенной оплате и вернуть «Карточку подписчика», отметив в ней номера и названия тематических категорий, на которые оформляется подписка, по адресу:

141980 г. Дубна Московской обл.
ул.Жолио Кюри, 6
ОИЯИ, издательский отдел

**SUBJECT CATEGORIES
OF THE JINR PUBLICATIONS**

Index	Subject
1.	High energy experimental physics
2.	High energy theoretical physics
3.	Low energy experimental physics
4.	Low energy theoretical physics
5.	Mathematics
6.	Nuclear spectroscopy and radiochemistry
7.	Heavy ion physics
8.	Cryogenics
9.	Accelerators
10.	Automatization of data processing
11.	Computing mathematics and technique
12.	Chemistry
13.	Experimental techniques and methods
14.	Solid state physics. Liquids
15.	Experimental physics of nuclear reactions at low energies
16.	Health physics. Shieldings
17.	Theory of condensed matter
18.	Applied researches
19.	Biophysics

Односпиновая асимметрия пионов в реакции $d\uparrow + A \rightarrow \pi^\pm + X$
при $\theta_\pi = 90^\circ$

Представлены результаты первых измерений векторной анализирующей способности в реакции инклюзивного рождения пионов поляризованными дейтронами на водородной (H) и углеродной (C) мишенях при углах регистрации вторичных частиц $\theta_\pi \sim 90^\circ$ и импульсах дейтронного пучка 3—9 ГэВ/с. Измерения выполнены на синхрофазотроне ЛВЭ ОИЯИ. Установлена большая величина асимметрии и различие в знаках для π^+ - и π^- -мезонов в реакции $d\uparrow + H \rightarrow \pi^\pm + X$ при относительно малых импульсах пучка и импульсах пионов 300÷350 МэВ/с. Ненулевая асимметрия пионов наблюдается в реакции $d\uparrow + C \rightarrow \pi^\pm + X$. Проведено МС моделирование и показано, что в исследуемой кинематической области вклад механизма с рождением Δ -изобары существен по сравнению с прямым механизмом и может заметно влиять на величину и знак асимметрии.

Работа выполнена в Лаборатории высоких энергий ОИЯИ.

Препринт Объединенного института ядерных исследований. Дубна, 1995

One Spin Pion Asymmetry in $d\uparrow + A \rightarrow \pi^\pm + X$ Processes
Near $\theta_\pi = 90^\circ$

We report the results of the first measurements of the vector analyzing power of inclusive pions produced in the reactions of polarized deuterons with different (H and C) targets near the 90° in the laboratory system at incident beam momenta from 3 to 9 GeV/c. The measurements were performed at JINR Dubna synchrophasotron. The large values of one spin pion asymmetry and the different signs of the π^+ and π^- asymmetries have been observed in the $d\uparrow + H \rightarrow \pi^\pm + X$ reactions at relatively low beam momenta and for a pion momentum in the range 300÷350 MeV/c. The non-zero values of asymmetry were also obtained in the $d\uparrow + C \rightarrow \pi^\pm + X$ reactions. The results of Monte Carlo simulations indicate the strong influence of the intermediate Δ -resonances on the one spin pion asymmetry.

The investigation has been performed at the Laboratory of High Energies, JINR.

Макет Т.Е.Попеко

Подписано в печать 6.03.96
Формат 60 × 90/16. Офсетная печать. Уч.-изд.листов 1,8
Тираж 420. Заказ 48944. Цена 1080 р.

Издательский отдел Объединенного института ядерных исследований
Дубна Московской области