

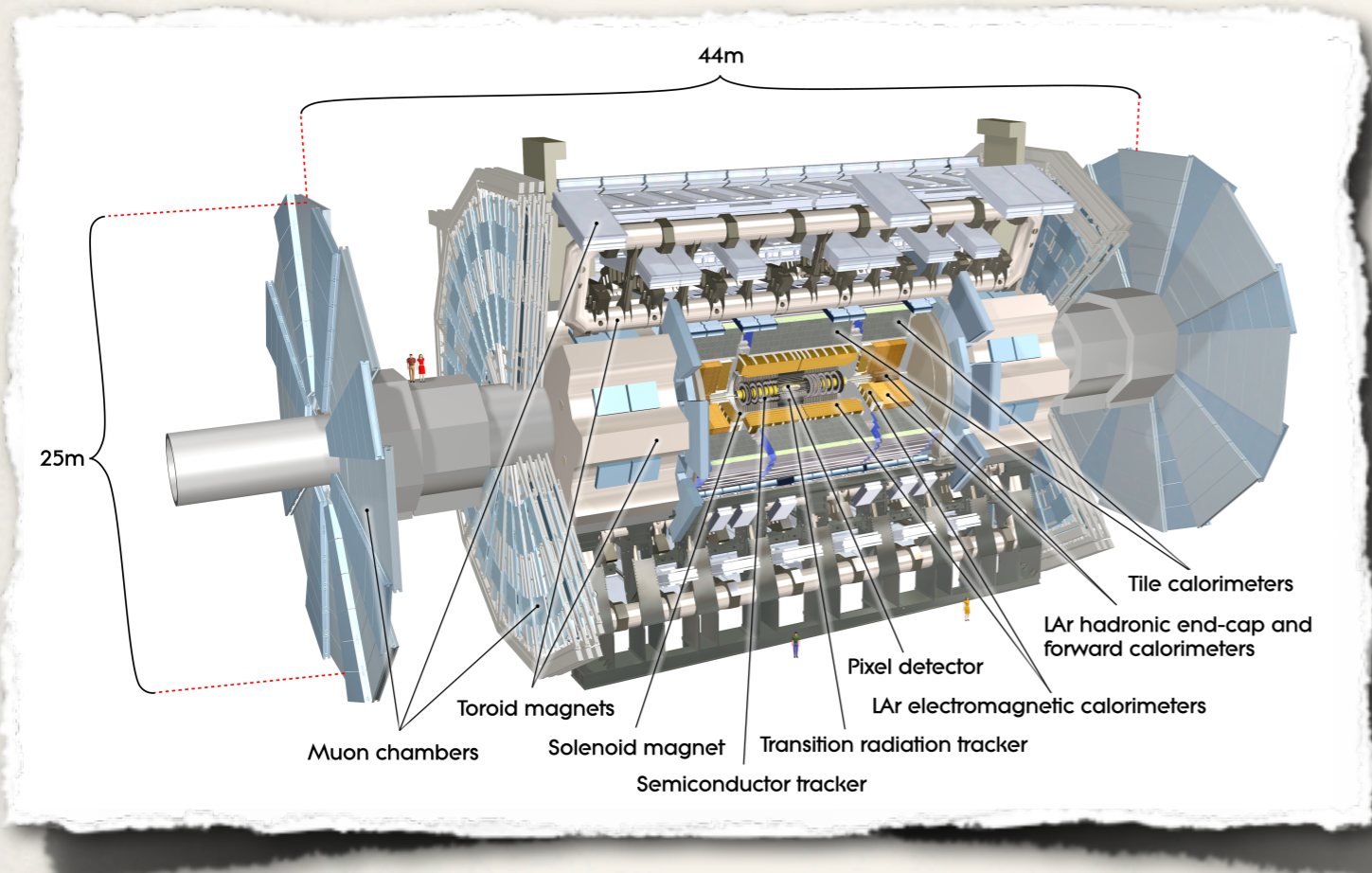

Status of the ATLAS Liquid Argon Calorimeter and its performance after one year of LHC operation

Dr. Julia Hoffman (CERN/SMU)
on behalf of the ATLAS Liquid Argon Calorimeter Group

The ATLAS detector



Structure

- Tracking: Pixel, Silicon detector, Transition Radiation Tracker; in a solenoidal magnetic field
- Calorimetry: Liquid Argon + Scintillators
- Muon Spectrometer: Drift Chambers, Resistive Plate Chambers; in a toroidal magnetic field

Physics goals

- Standard Model, Higgs, SUSY, ...
- Signatures: leptons, jets, missing transverse energy

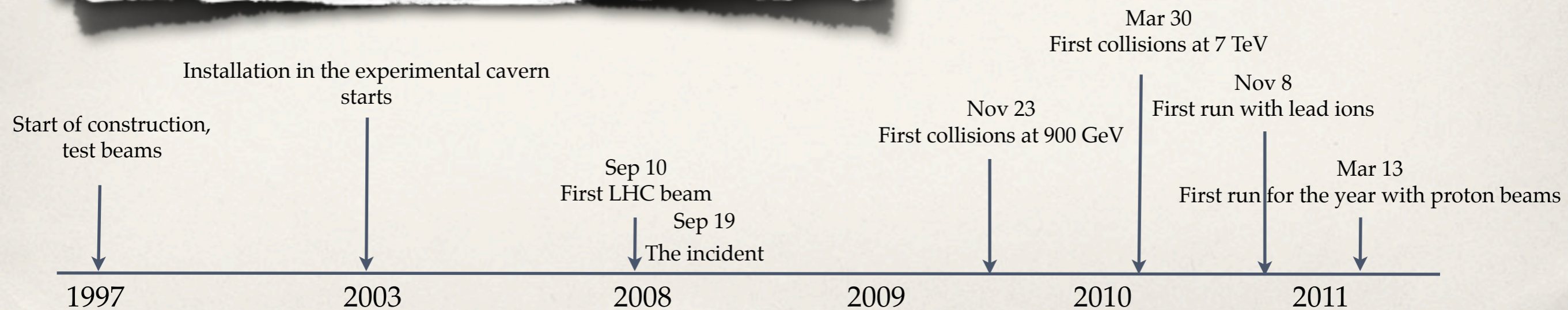

Luminosity

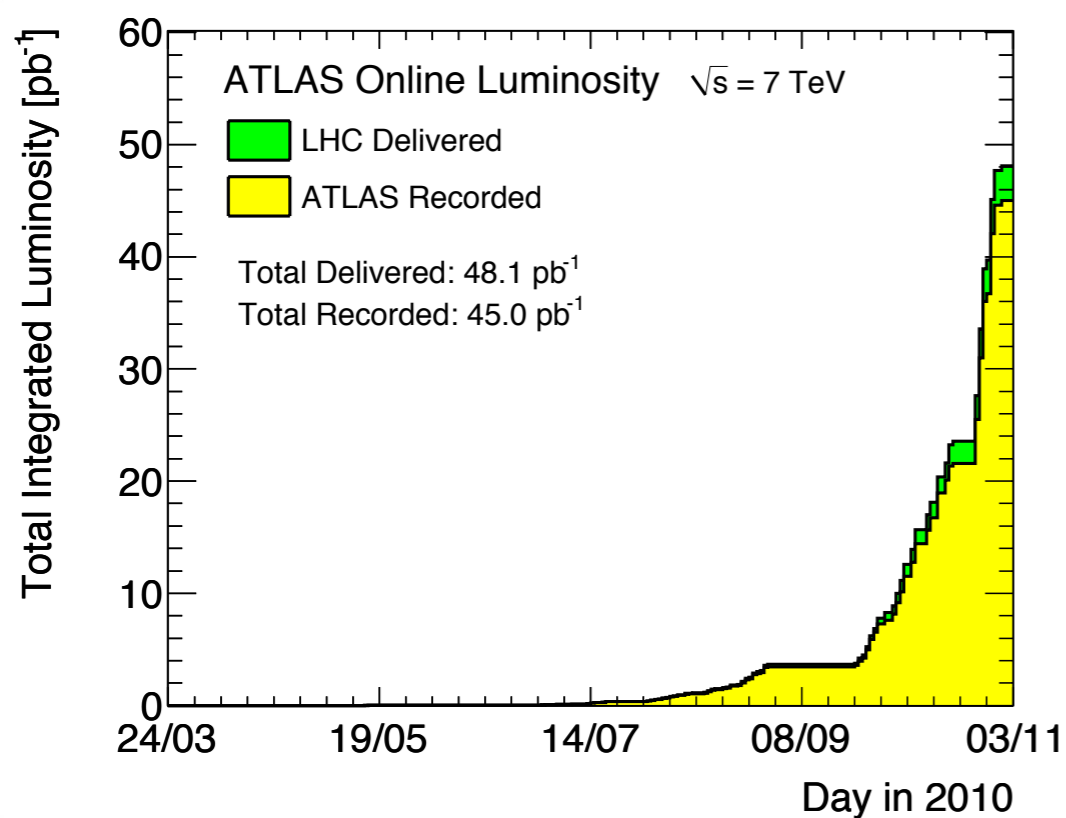

2010

Total luminosity delivered: 48.1 pb⁻¹
Total luminosity recorded by ATLAS: 45.0 pb⁻¹

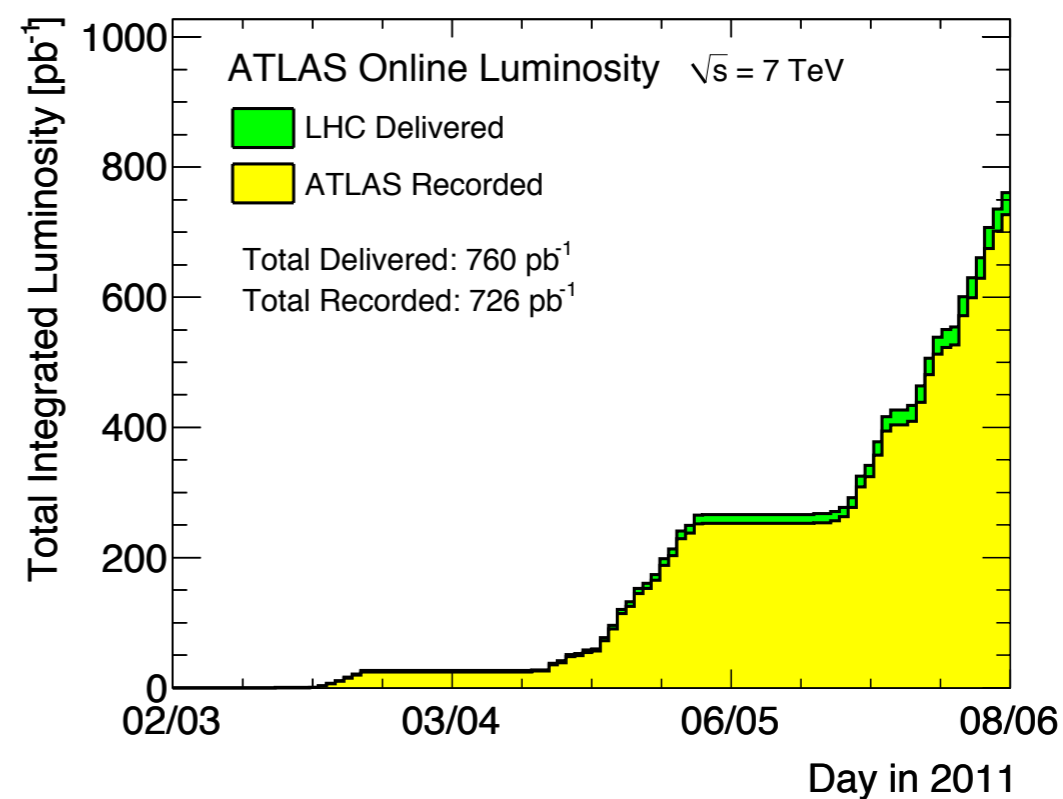

2011

Total luminosity delivered: 427.0 pb⁻¹
Total luminosity recorded by ATLAS: 403.9 pb⁻¹

The ATLAS LAr Calorimeter (1/2)

LAr Calorimeters play a central role in ATLAS detector. They measure energies of electrons and photons with high resolution and detect hadronic jets and missing energy signatures

Electromagnetic Calorimeter (EM)

- * Absorber: Pb
- * Active Medium: LAr
- * Accordion Geometry: full ϕ coverage
- * Coverage: $|\eta| < 3.2$
- * High segmentation in η , ϕ and in depth
- * 3 layers up to $|\eta| = 2.5$; 2 up to $|\eta| = 3.2$
 - * Layer 1: $\Delta\eta \times \Delta\phi = 0.0031 \times 0.1$
 - * Layer 2: $\Delta\eta \times \Delta\phi = 0.025 \times 0.025$
 - * Layer 3: $\Delta\eta \times \Delta\phi = 0.05 \times 0.025$
- * Presampler up to $|\eta| = 1.8$
- * Design resolution: $\frac{\Delta E}{E} = \frac{10\%}{\sqrt{E(\text{GeV})}} \oplus 0.7\%$
- * Photon angular resolution: $\approx \frac{50\text{mrad}}{E(\text{GeV})}$

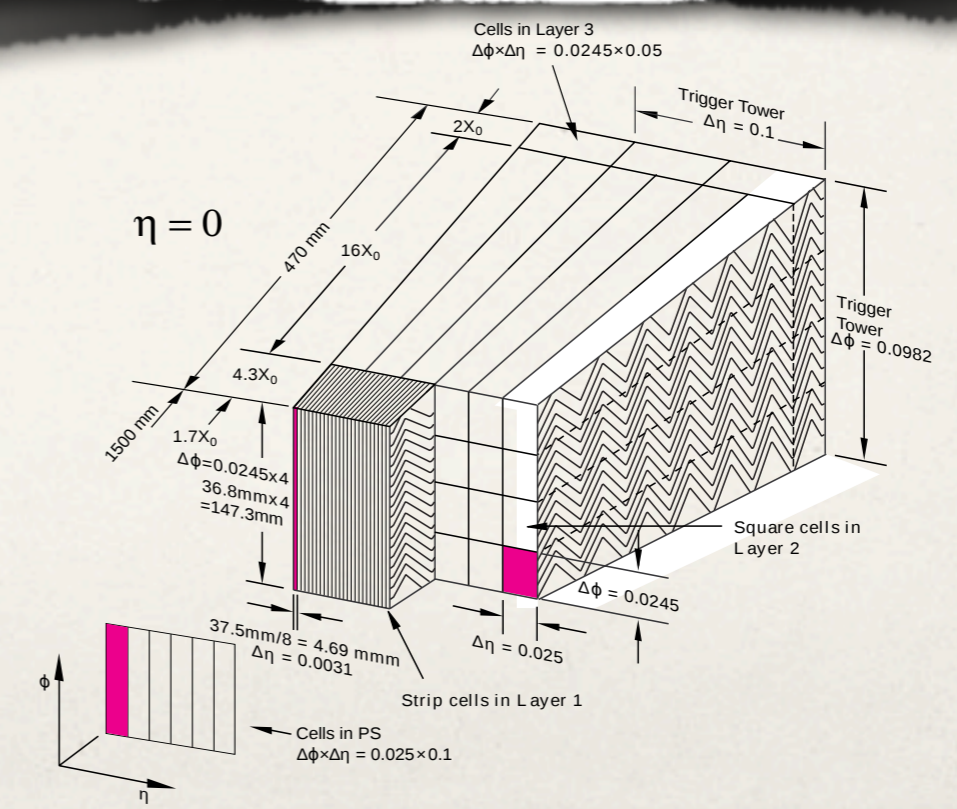
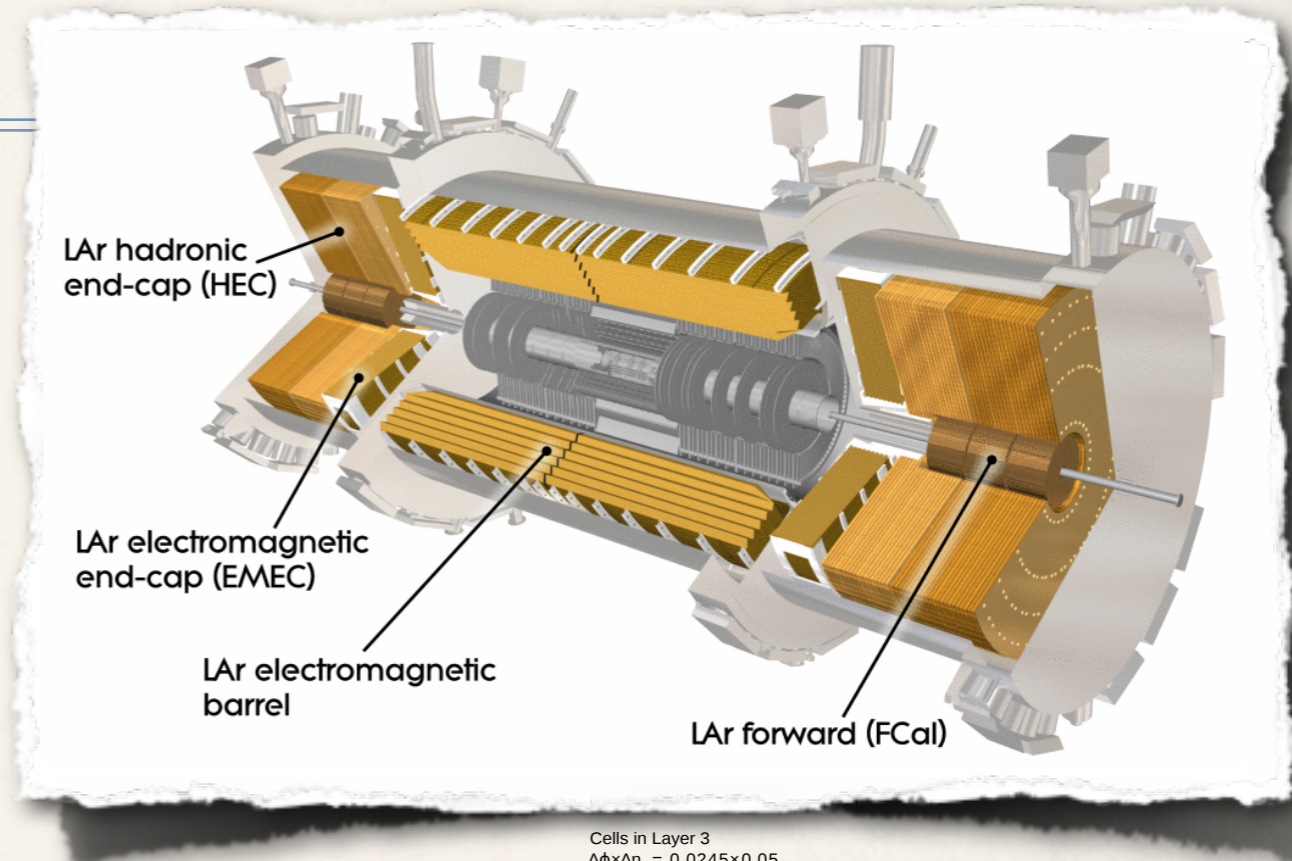

The ATLAS LAr Calorimeter (2/2)

Hadronic Endcap (HEC)

- ❖ Absorber: Cu
- ❖ Active Medium: LAr
- ❖ Coverage: $1.5 < |\eta| < 3.2$
- ❖ 4 layers ($\Delta\eta \times \Delta\phi = 0.1 \times 0.1$ or 0.2×0.2)
- ❖ Design resolution (jets): $\frac{\Delta E}{E} = \frac{50\%}{\sqrt{E(\text{GeV})}} \oplus 3\%$

Forward Calorimeter (FCal)

- ❖ Absorber: Cu/W
- ❖ Active Medium: LAr
- ❖ Coverage: $3.1 < |\eta| < 4.9$
- ❖ 1 Electromagnetic + 2 Hadronic layers
- ❖ Design resolution: $\frac{\Delta E}{E} = \frac{100\%}{\sqrt{E(\text{GeV})}} \oplus 10\%$

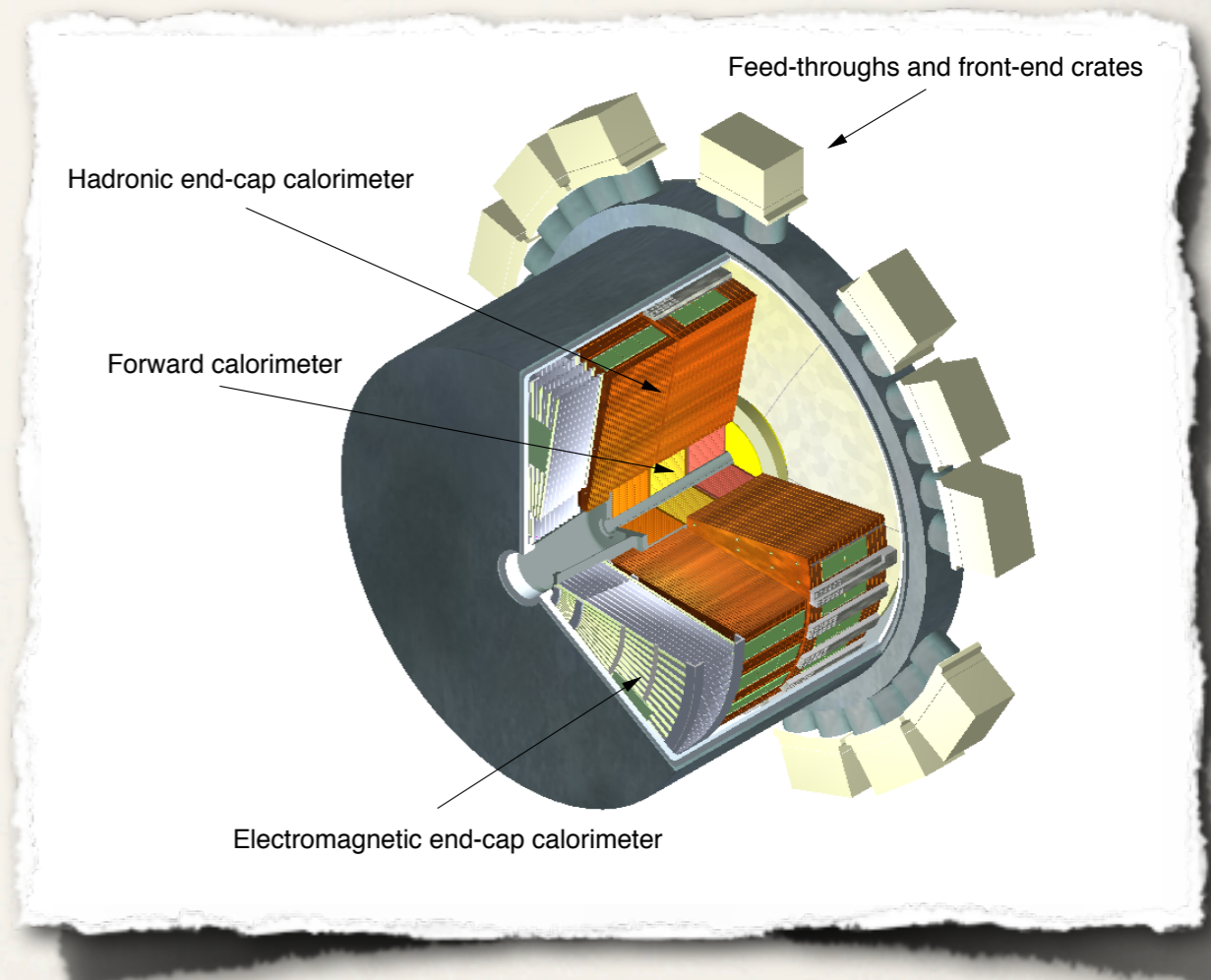

Signal reconstruction

$$E = \sum_{i=1}^{N_{samples}} a_i (s_i - p) \quad \tau = \frac{1}{E} \sum_{i=1}^{N_{samples}} b_i (s_i - p)$$

s_i - sample ADC counts
 a_i, b_i - Optimal Filtering Coefficients
 p - pedestal

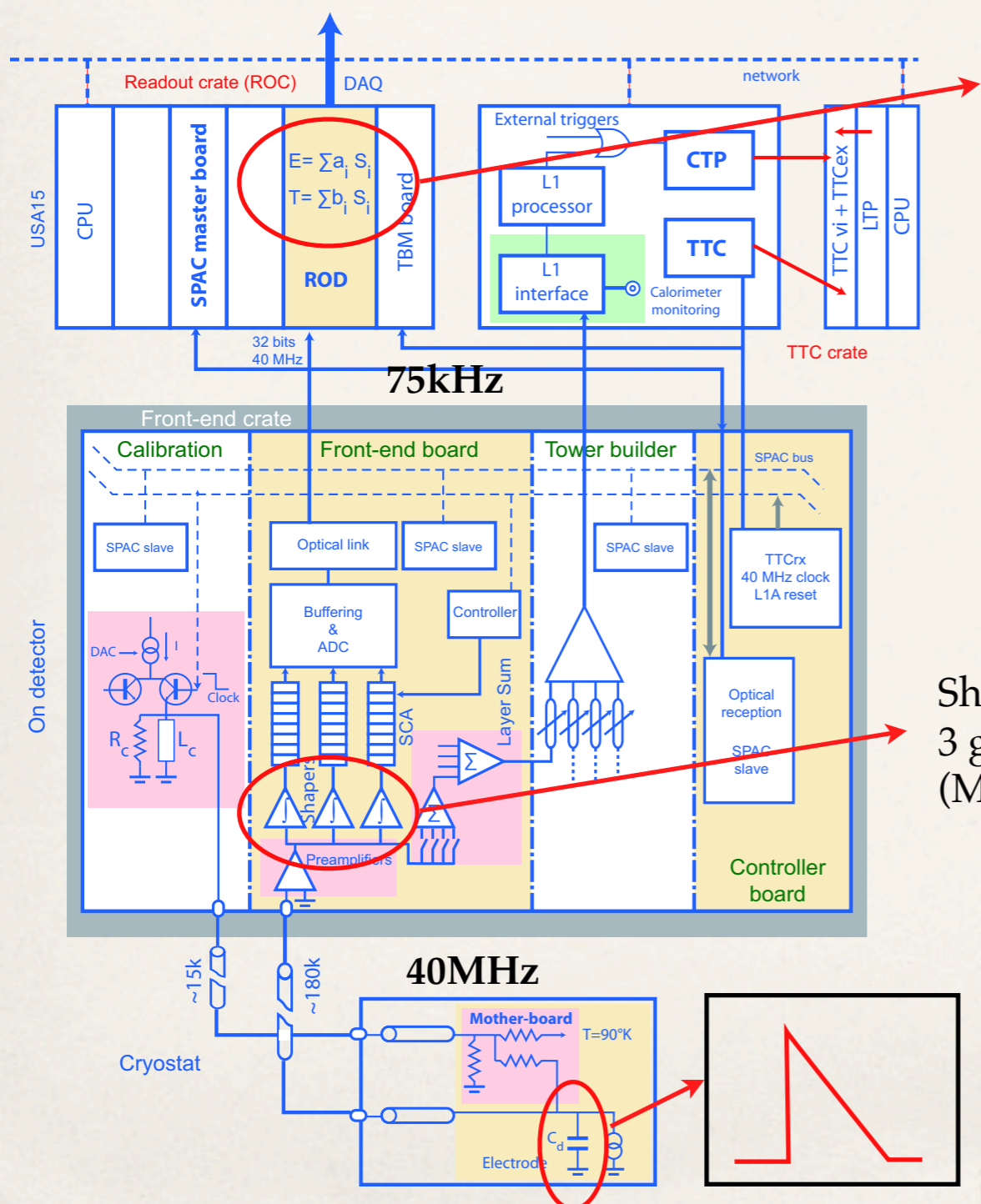

Shaping
3 gains
(MeV to TeV)

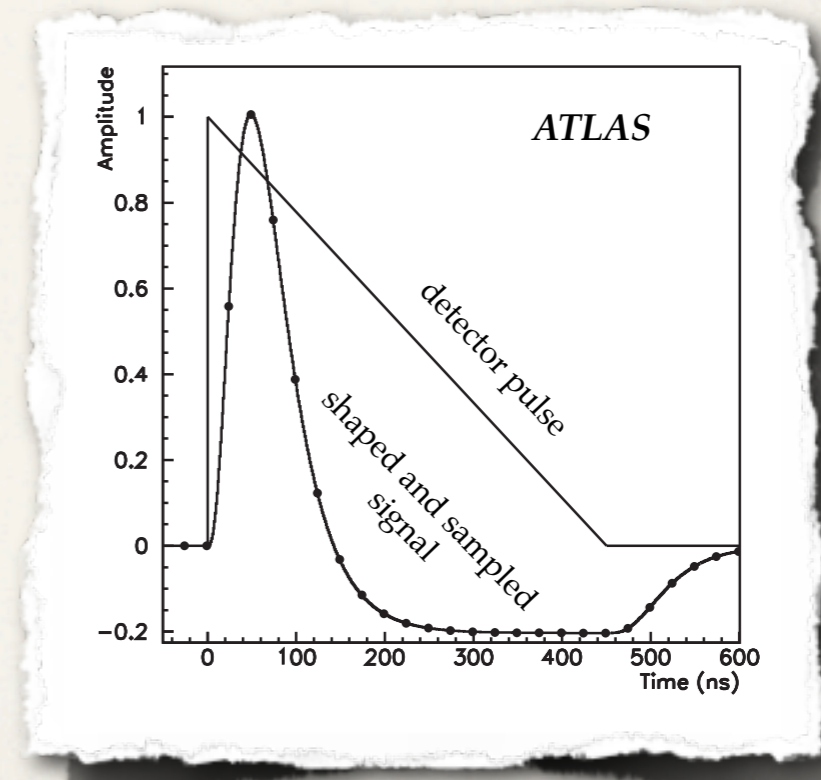

Shaped signal, digitized
Sampled at 40MHz

Trigger performance

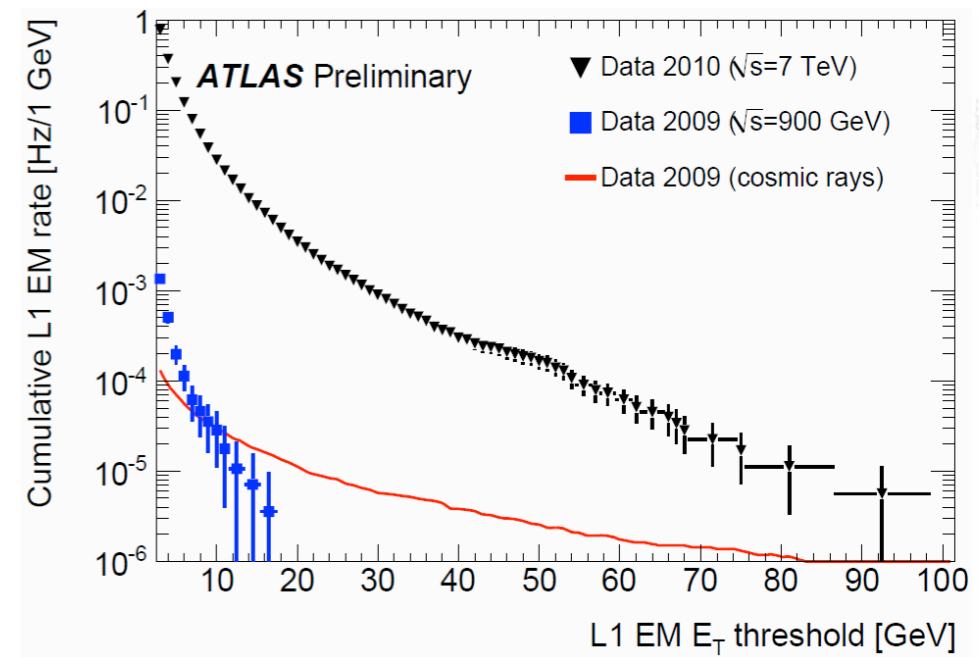
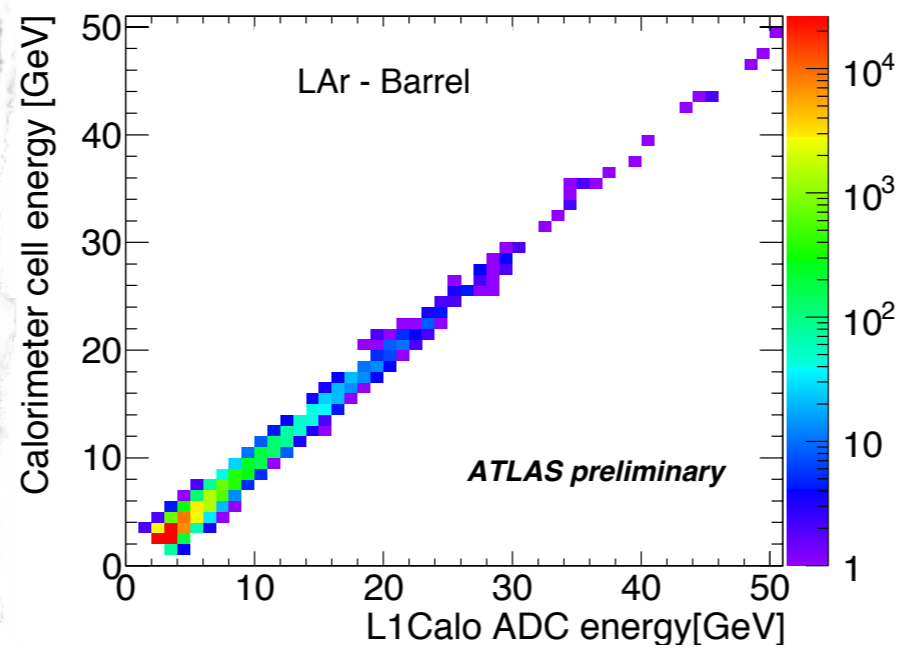
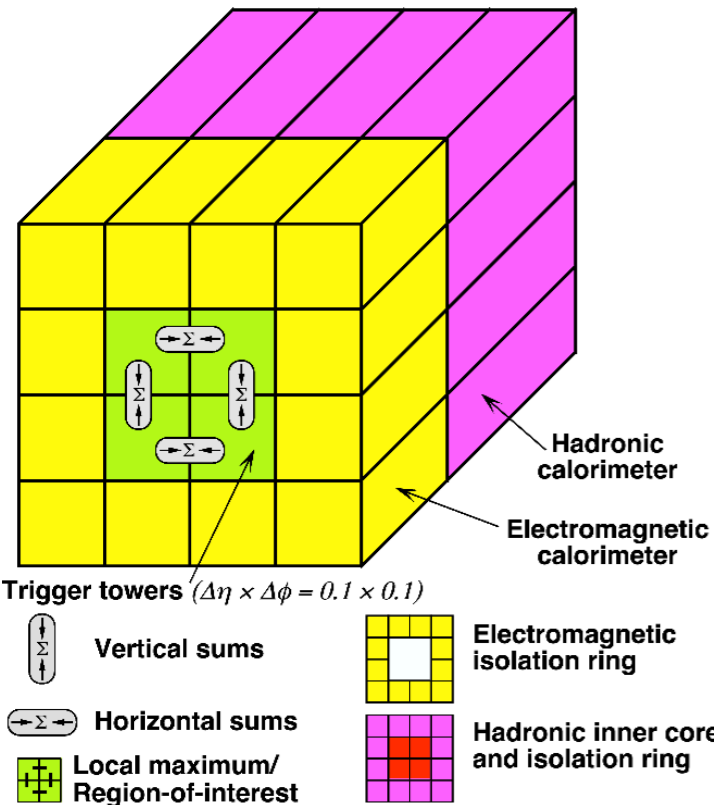

Energy is summed over neighboring cells in trigger tower

Typical size: $\Delta\eta \times \Delta\phi = 0.1 \times 0.1$
(approx. 60 readout channels)

Trigger energy can be used to correct energy when digital readout is missing

Resolution of $E_T(\text{L1Calo}) < 5\%$ for $E_T(\text{LAr}) > 10\text{GeV}$

Calibration

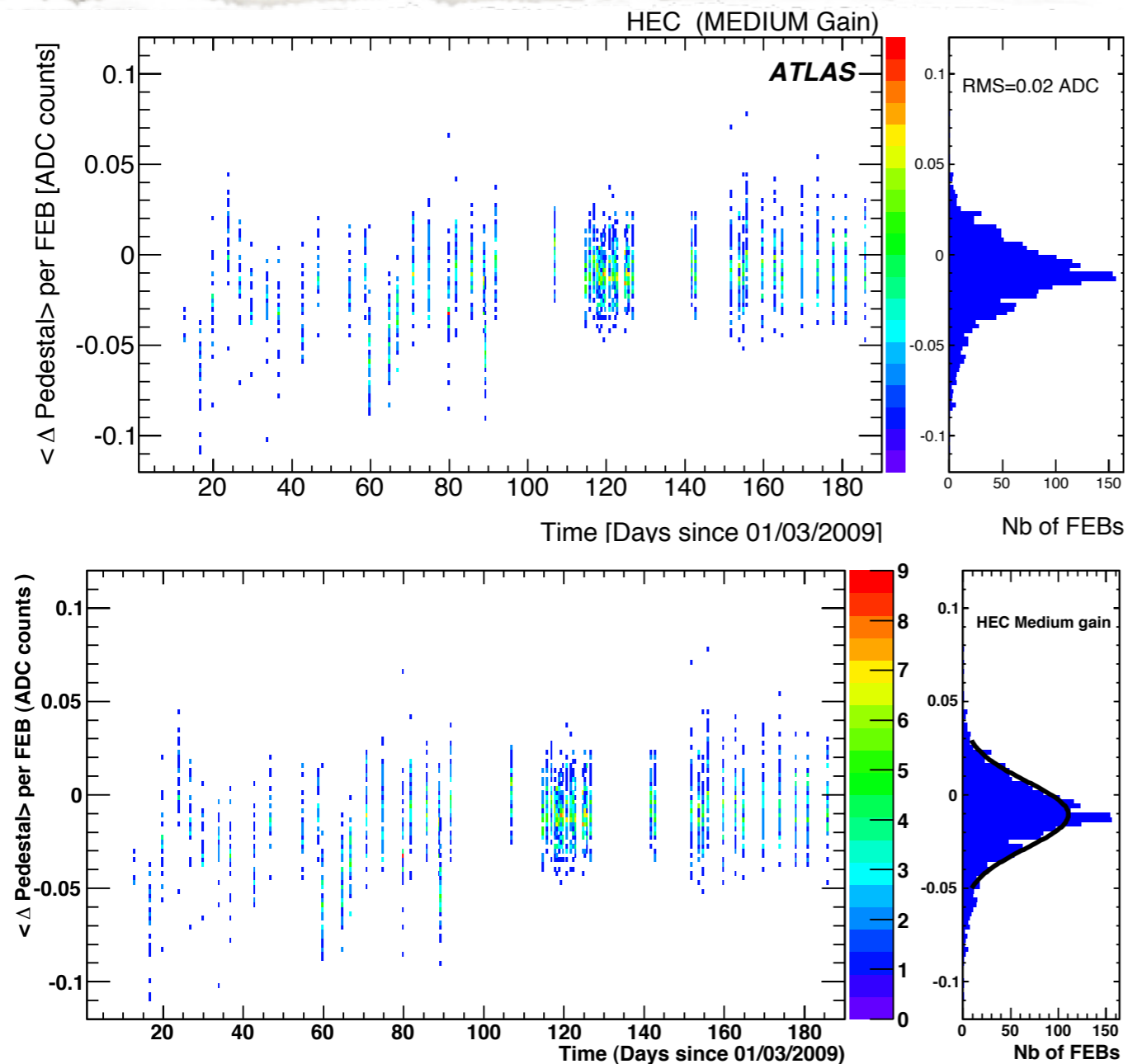

Stability of calibration constants

- * Calibration runs are taken between every LHC fill.
- * Calibration constants are updated every few weeks.
- * Stability of constants is monitored over long periods (here: 6 months in 2009).
- * Pedestal change by ADC counts: < 0.03 for all calorimeters.
- * Gains change: $< 0.1\%$ for all calorimeters.

Timing

The LAr timing measurement

- ❖ Good understanding of the timing helps distinguish between energy deposited from triggered events and those from neighboring bunch crossings.
- ❖ Used to veto cosmics against collision events.
- ❖ The depth segmentation and timing can also be used together to identify non-pointing photons.

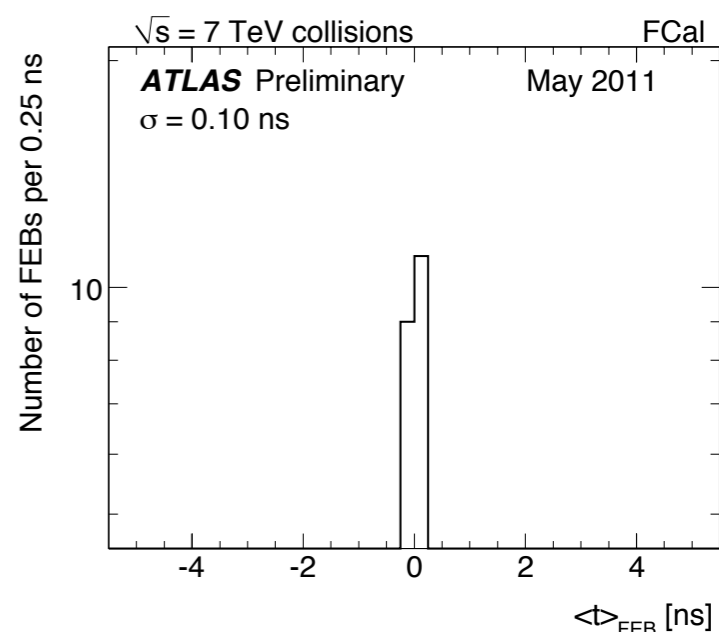
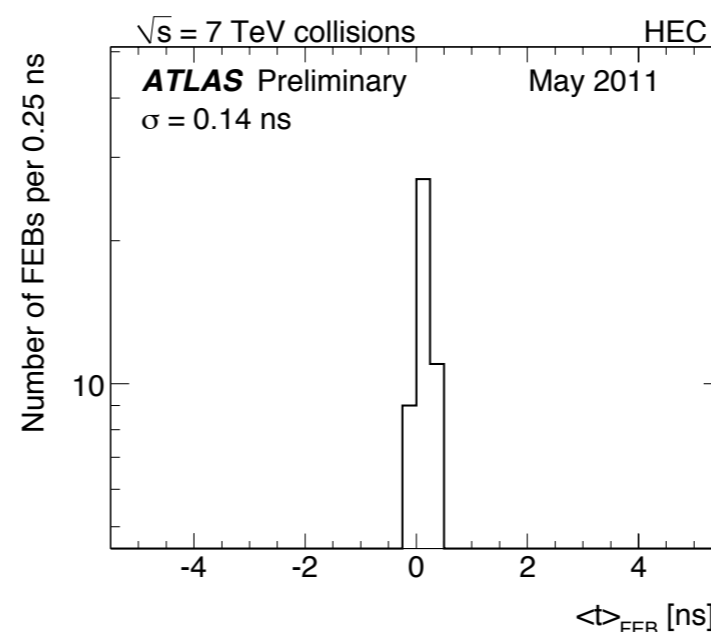
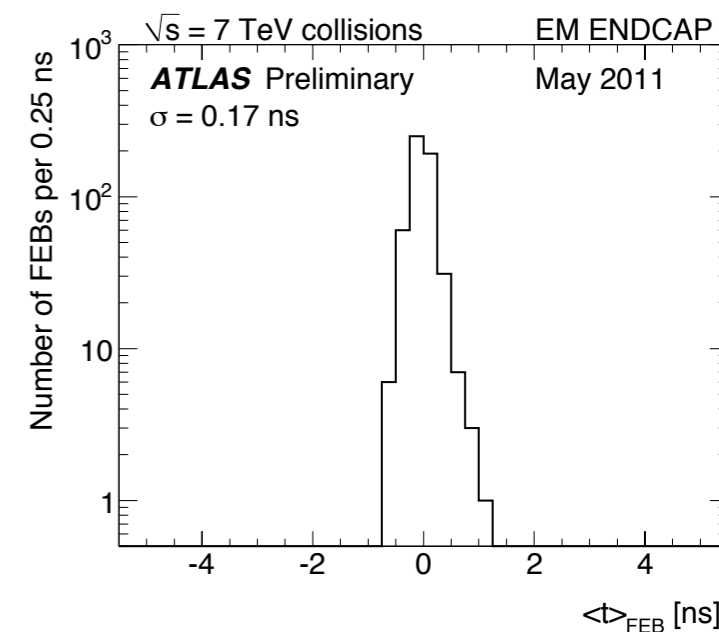
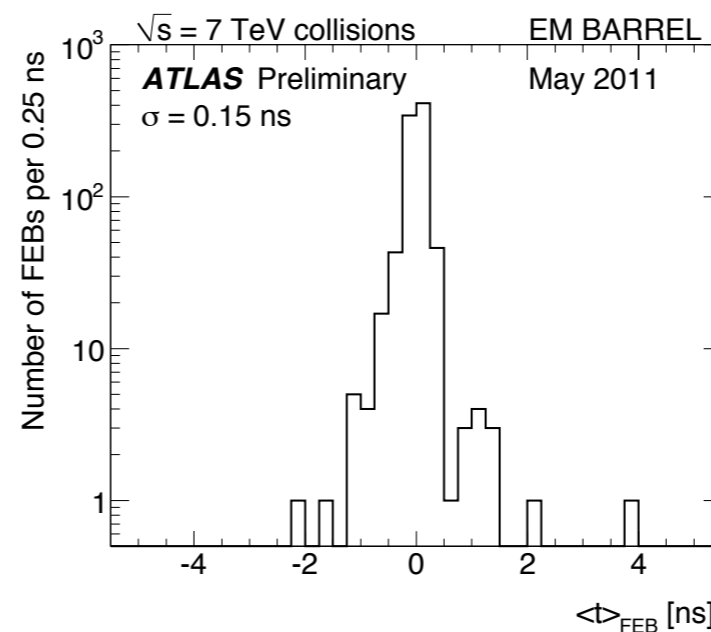

- ❖ Coarse adjustment achieved with configurable delays on the Front-End Boards.
- ❖ Finer adjustments can be made channel-by-channel with optimal filtering coefficients
- ❖ The ultimate goal is a timing resolution of ~ 100 ps



Performance studies with data

- ❖ Physics analysis is done by comparing MC and data.
- ❖ Discrepancies between data and Monte Carlo can be caused by new (unmodeled) physics or inadequacies in the detector simulation.
- ❖ Electromagnetic energy scale and uniformity:
 - ❖ Calibration signals and physics signals
 - ❖ $Z \rightarrow ee$ events for high- p_T electrons;
 - ❖ $J/\Psi \rightarrow ee$ for low- p_T electron, π^0 decays.
- ❖ γ/π^0 separation based on the width of the shower.

Performance studies with data (1/2)

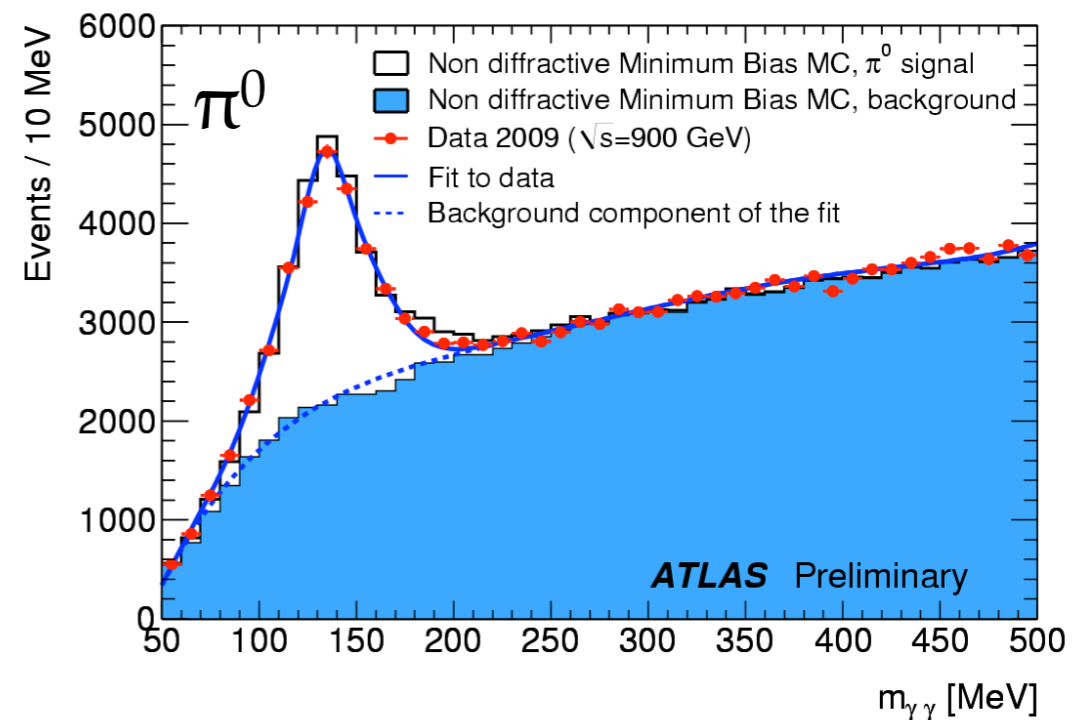
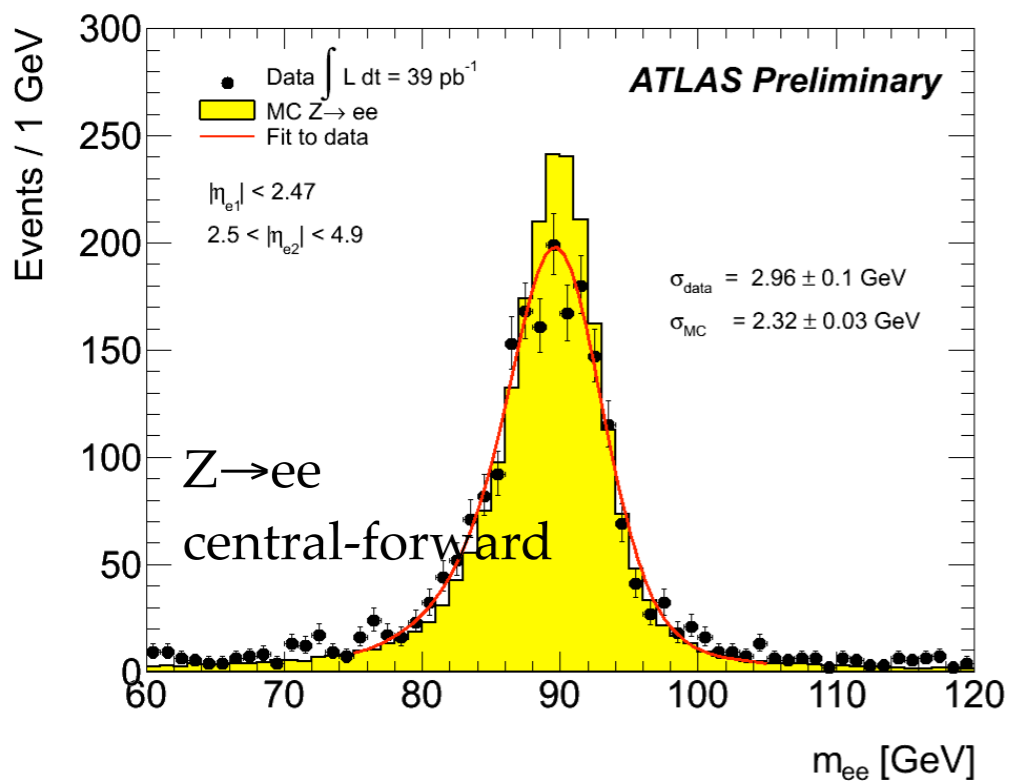
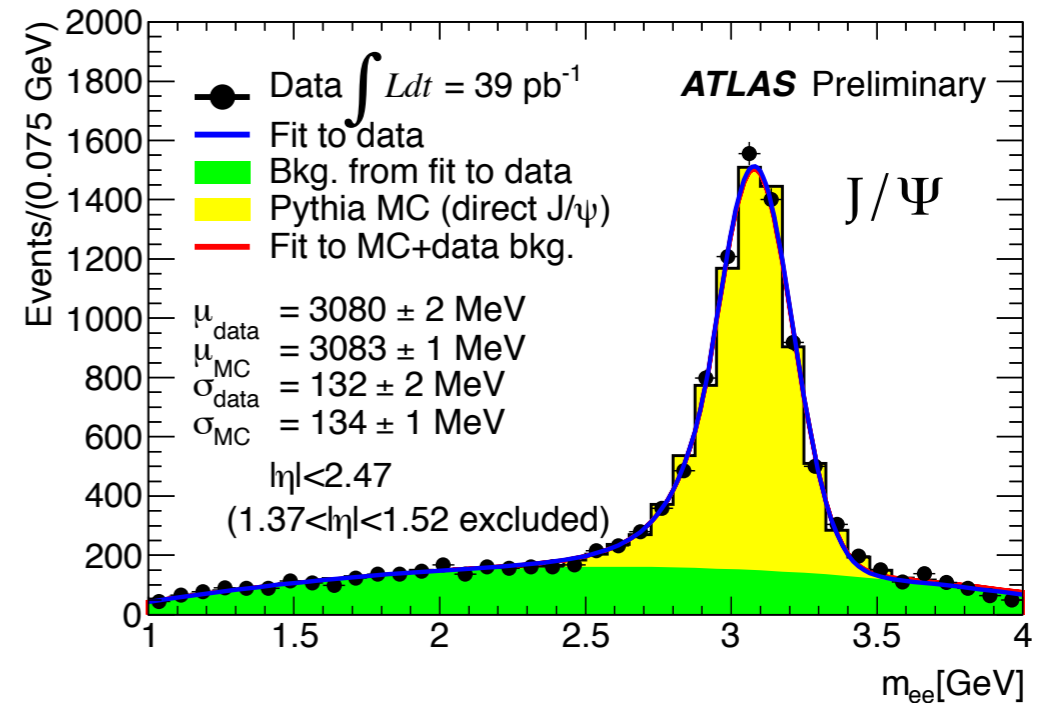
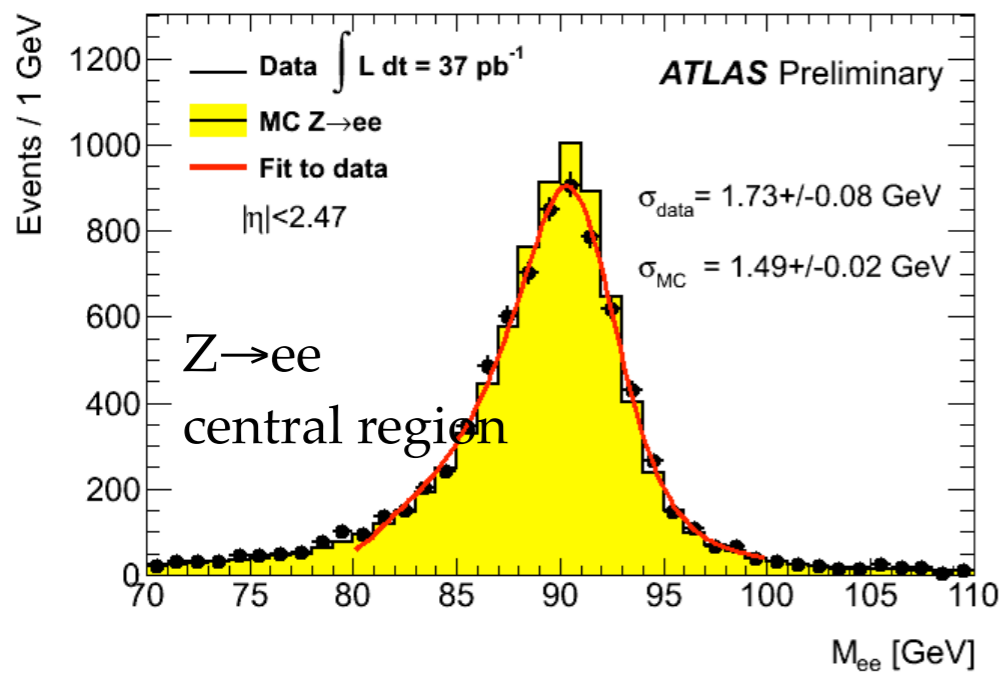

Performance studies with data (2/2)

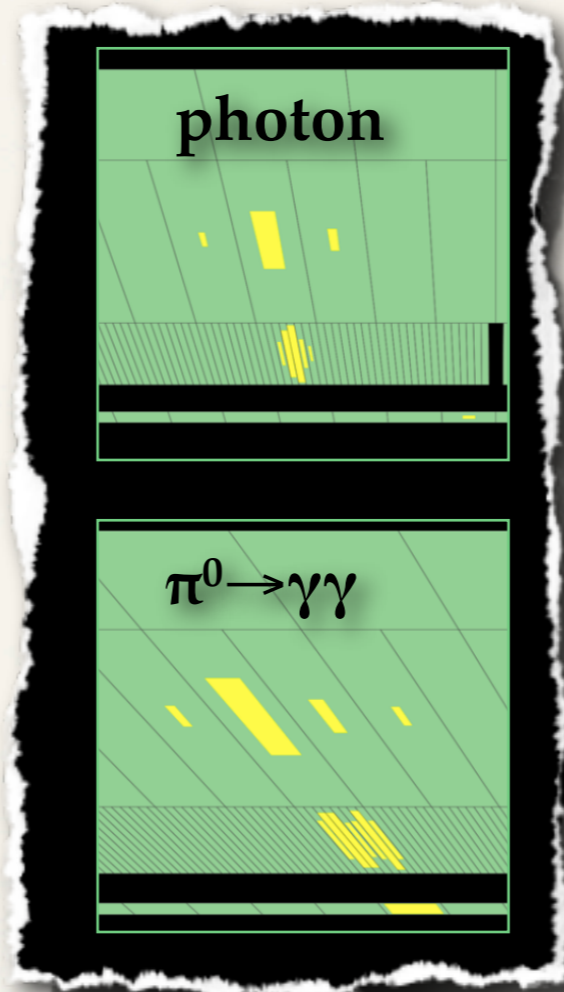
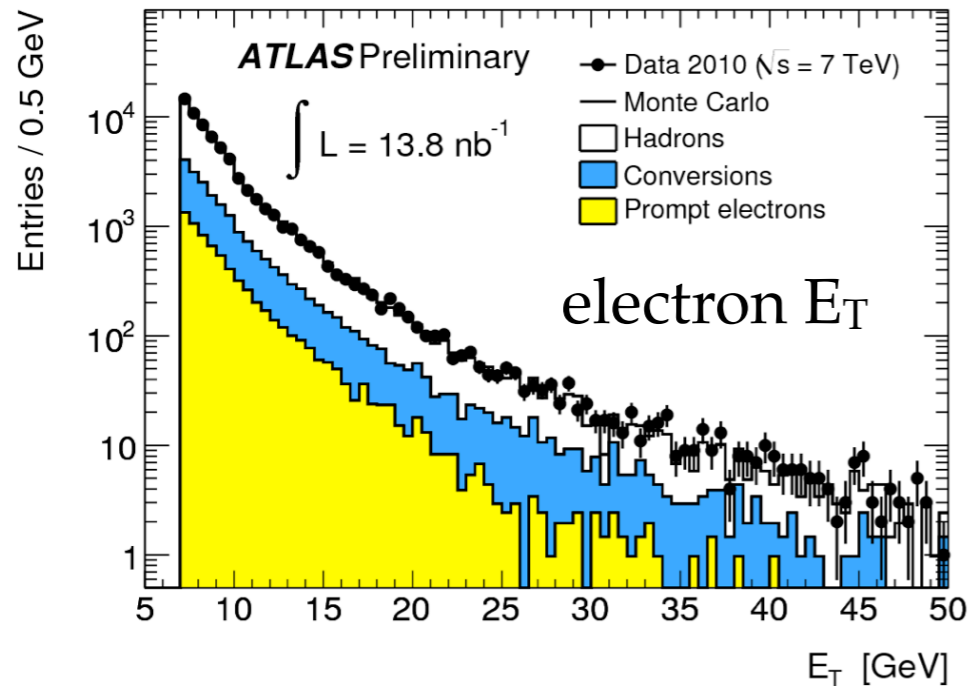
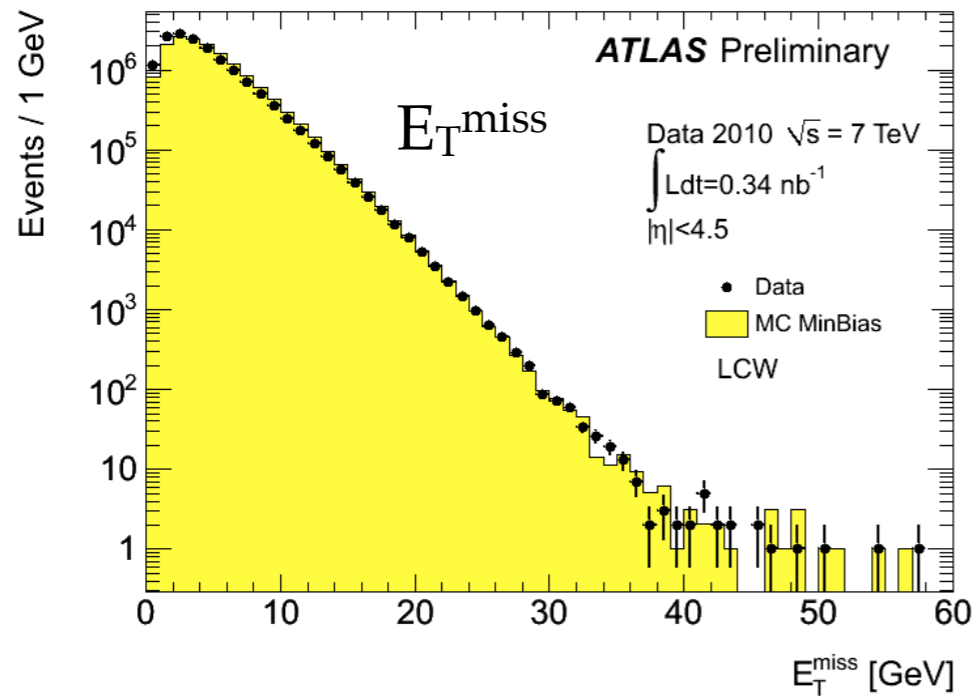

Excellent performance of LAr calorimeter for physics. 😊

Detector operation

- ❖ LAr calorimeters have been operating at nominal high voltage since 2006.
- ❖ The performance of the detector is very good.
- ❖ Excellent homogeneity and stability for LAr temperature within each cryostat .
 - ❖ Designed for less than 100mK, 59mK achieved
- ❖ LAr purity in each cryostat is well within required limits
 - ❖ O₂ can capture electrons and reduce signal collection; impurity level better than 1000ppb O₂ equivalent is required
 - ❖ Impurity level in LAr is in the range of 200±100ppb O₂ equivalent.
- ❖ Problems encountered:
 - ❖ Optical Transmitter (OTx) deaths;
 - ❖ High Voltage trips;
 - ❖ Noise bursts.

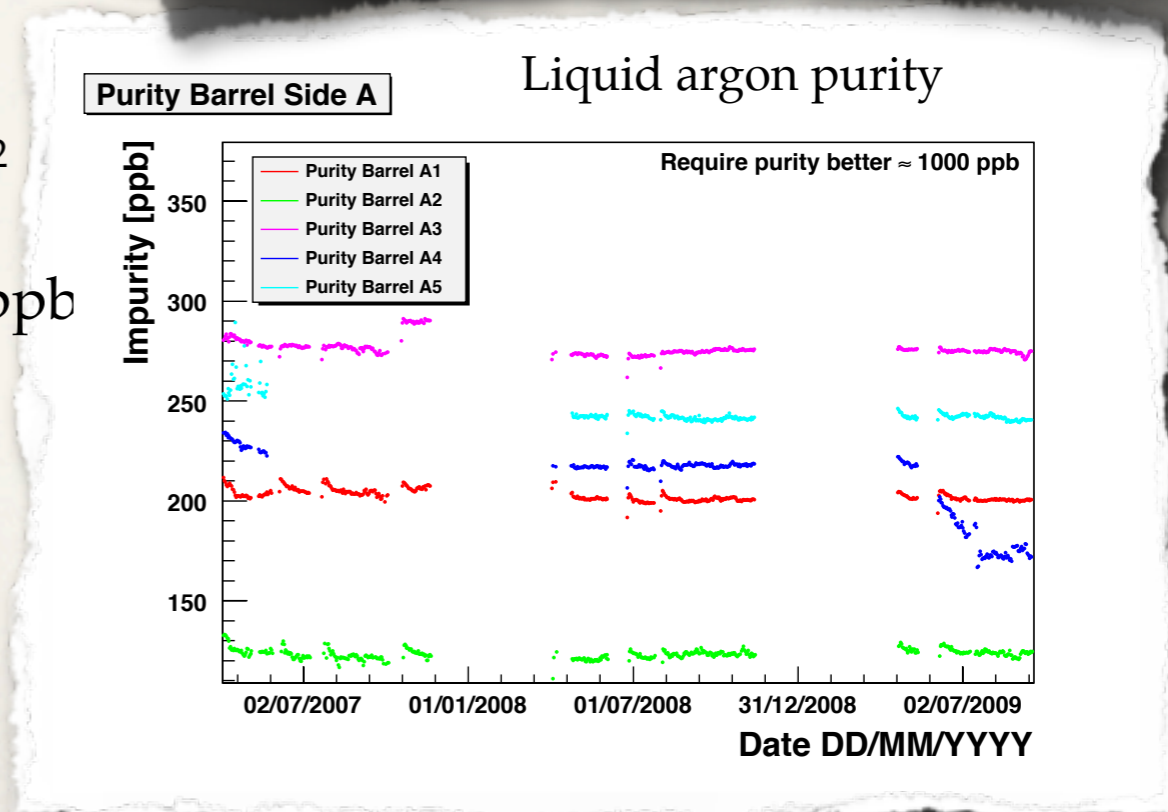
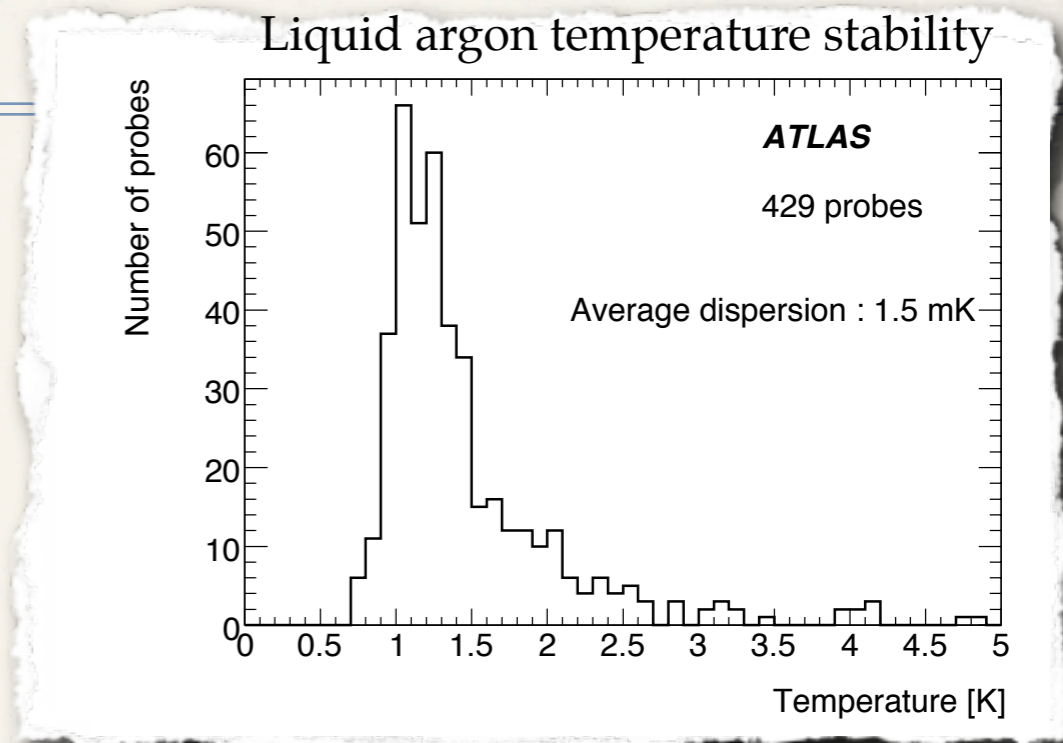

LAr Front-End Board Optical Transmitters (OTx)

- * 1 OTx per Front-End Board = 128 channels (180k channels in total).
- * OTx failure means no data is transmitted for entire FEB → still have analog readout through L1Calo trigger connection.
- * On-detector electronics - in the experimental cavern → access not possible except in periods of extended shutdown.
- * Became an issue in 2008, with 1 failure a week; Failure of OTx not definitely understood.
- * OTx failures not fatal to the experiment; data analyses excluded affected regions (small detector acceptance loss: few % per electron).
- * No failures were reported since 2010-2011 shutdown exchange.

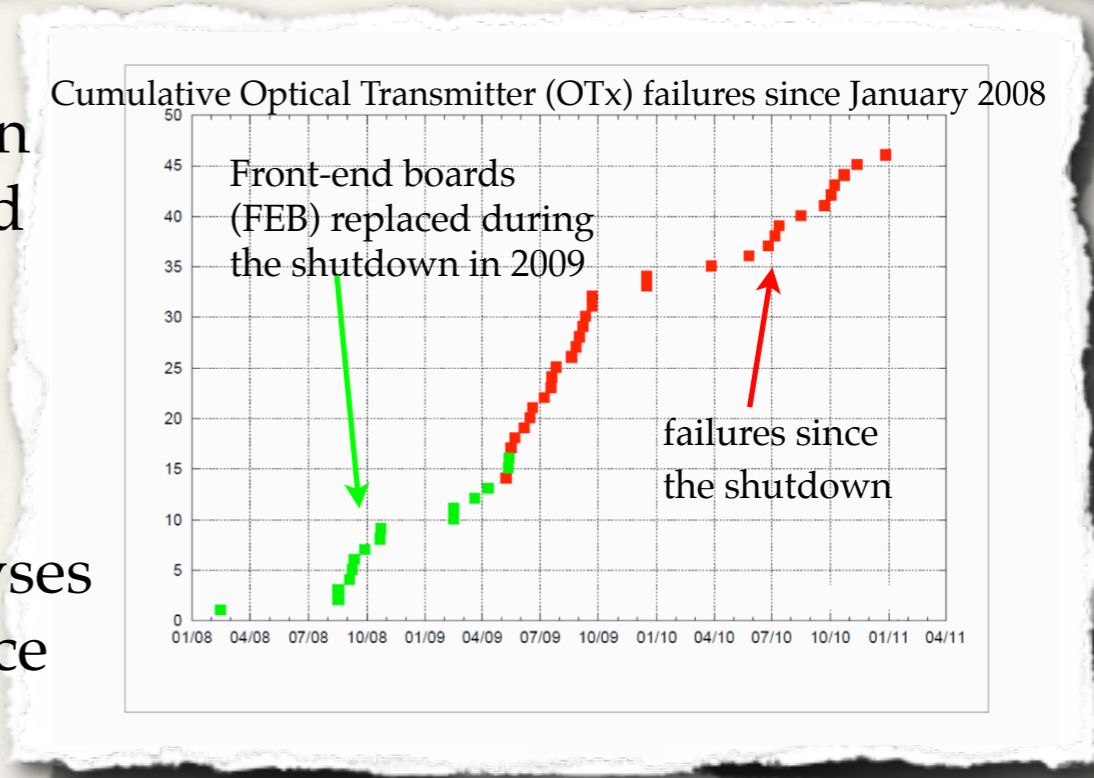
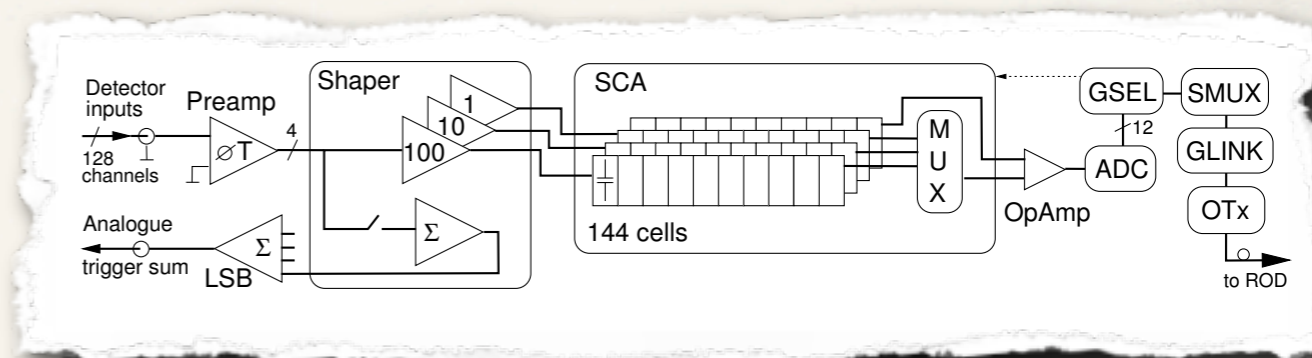

LAr High Voltage, noise bursts

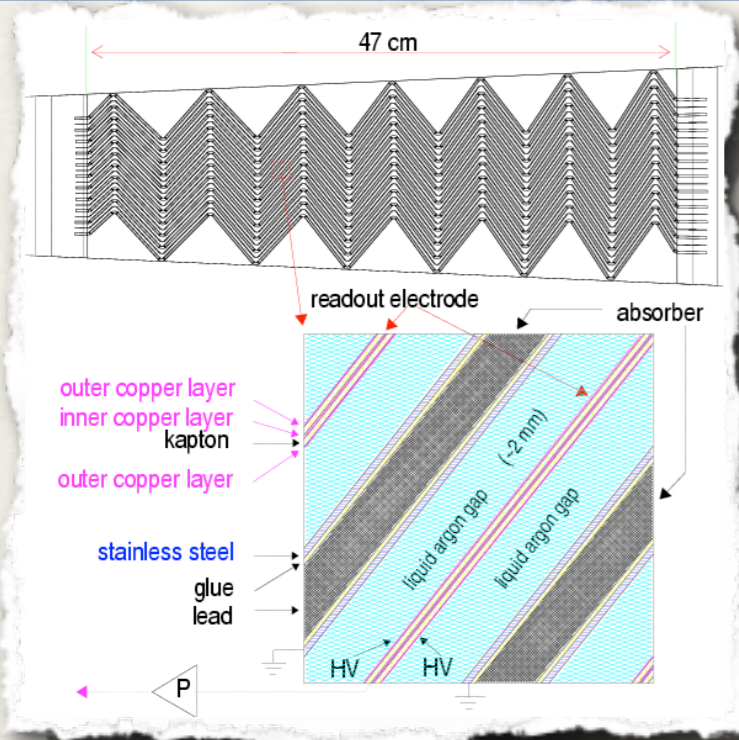

The HV power supply system provides drift voltage across gaps in the calorimeter from back of the electrodes.

- ❖ Each HV channel individually controlled (on/off, voltage, trip current, voltage ramp speed) by software.
- ❖ HV trips are observed and correlated with the presence of collisions.
 - ❖ In a sequence of steady fills with the same luminosity / number of bunches, number of trips decreases with each fill.
- ❖ Automatic recovery procedure has been in use (data corrected for reduced HV during recovery, offline)
- ❖ Noise bursts - noise affecting a large number of channels in the same detector partition - are masked in data analysis

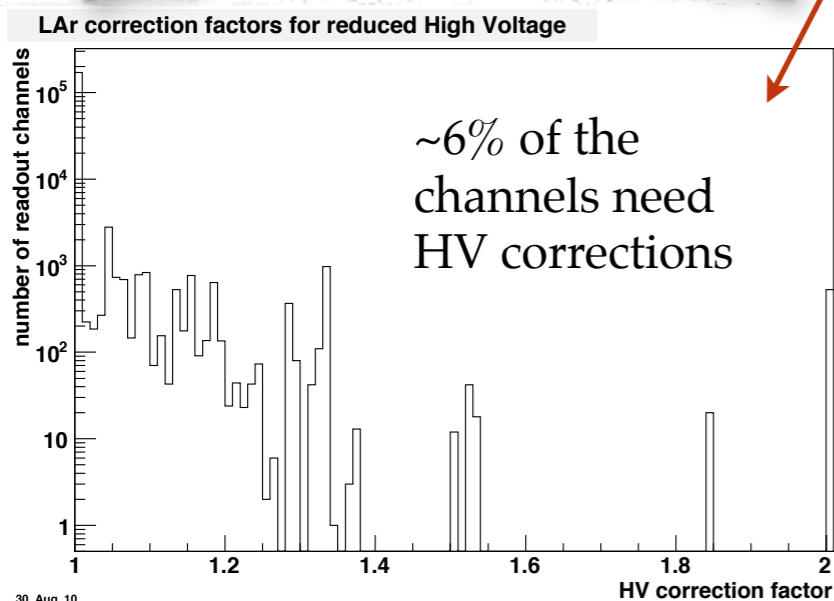



Summary

- ❖ ATLAS LAr Calorimeter is fully instrumented and has been operated at nominal high voltage since 2006.
- ❖ It measures the energy and direction of electrons, photons, jets, E_T^{miss} of events with high precision.
- ❖ LAr Calorimeter is well understood, the performance of the calorimeter is excellent, near design expectations.
- ❖ Few occasional problems encountered in the past year (failures of optical transmitters, and High-Voltage power supply trips) do not affect the quality of detector operations.
 - ❖ Problems resolved or worked on.
- ❖ We are entering an exciting period and are prepared for a large amount of data and increased luminosity.

Backup

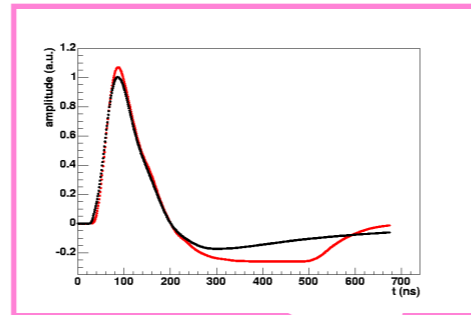

Energy reconstruction

$$E_{\text{cell}} = F_{\mu\text{A} \rightarrow \text{MeV}} \cdot F_{\text{DAC} \rightarrow \mu\text{A}} \cdot \frac{1}{\frac{M_{\text{phys}}}{M_{\text{cali}}}} \sum_{i=1}^{M_{\text{ramps}}} R_i \left[\sum_{j=1}^{N_{\text{samples}}} a_j (s_j - p) \right]^i$$

Cell energy
Sampling fraction
Calibration board
ADC to DAC (Ramps)
Pulse Samples
Optimal Filtering Coefficients
Pedestals

The above formula describe the LAr electronic calibration chain (from the signal ADC samples to the raw energy in the cell). Note that this version of the formula uses the general M_{ramps} -order polynomial fit of the ramps. Actually we just use a linear fit (electronic is very linear, and additionally we only want to apply a linear gain in the DSP in order to be able to undo it offline, and apply a more refined calibration). In this case, the formula is simply:

$$E_{\text{cell}} = F_{\mu\text{A} \rightarrow \text{MeV}} \cdot F_{\text{DAC} \rightarrow \mu\text{A}} \cdot \frac{1}{\frac{M_{\text{phys}}}{M_{\text{cali}}}} \cdot R \left[\sum_{j=1}^{N_{\text{samples}}} a_j (s_j - p) \right]$$