



CLIC – Note – 866

HIGH POWER EVALUATION OF X-BAND HIGH POWER LOADS

S. Matsumoto, T. Higo, KEK, Ibaraki, Japan
I. Syratcev, G. Riddone, W. Wuensch, CERN, Geneva, Switzerland

Abstract

Several types of X-band high power loads developed for several tens of MW range were designed, fabricated and used for high power tests at X-band facility of KEK. Some of them have been used for many years and few units showed possible deterioration of RF performance. Recently revised-design loads were made by CERN and the high power evaluation was performed at KEK. In this paper, the main requirements are recalled, together with the design features. The high power test results are analysed and presented.

Presented at: LINAC 10, Tsukuba-Japan, September 12-17, 2010

Geneva, Switzerland
September 2010



HIGH POWER EVALUATION OF X-BAND HIGH POWER LOADS

S. Matsumoto[#], T. Higo, KEK, Tsukuba, Ibaraki, Japan,
I. Syratchev, G. Riddone, W. Wuensch, CERN, Geneva, Switzerland.

Abstract

Several types of X-band high power loads developed for several tens of MW range were designed, fabricated and used for high power tests at X-band facility of KEK. Some of them have been used for many years and few units showed possible deterioration of RF performance. Recently revised-design loads were made by CERN and the high power evaluation was performed at KEK. In this paper, the main requirements are recalled, together with the design features. The high power test results are analysed and presented.

INTRODUCTION

Since CLIC frequency has been changed from 30 GHz to 12 GHz [1], there is a need to prepare various RF components which work at the latter frequency for CLIC R&D studies. An RF dummy load is one of them. Its design was based on the loads designed and fabricated at BINP (Protvino, Russia) in 1997. Two such BINP-made loads have been working at the X-band RF stations in KEK where the operation frequency is 11.424 GHz. The whole structure of these loads is made from magnetic stainless steel SS430. The BINP load has the grooved H-plane surface where the RF wall current is efficiently damped.

The design was improved with respect to RF matching and a vacuum port was added at the end of the load for better vacuum performance. A careful design was made to evaluate the temperature raise on the inner surface of the load due to the RF pulse heating. These loads were fabricated at CERN and one of them was sent to KEK in 2009 for high power testing.

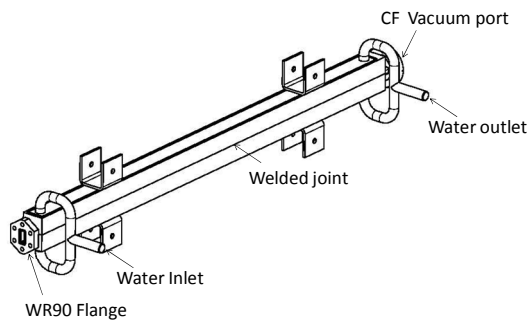

Figure 1: CERN Double Band SS430 Dry RF Load.

The CERN X-band Load consists of five functional parts as shown in Fig. 2 (Top). The length of the regular part was chosen so that the load can work at frequencies of 11.994 GHz and 11.424 GHz respectively. The former frequency is adopted by CERN while the latter by KEK and SLAC. Therefore, the load is compatible with these laboratories. We call them “double-band SS430 dry RF

load” or simply “double-band load” in this text. The design and measured S11 parameters are given in Fig.3.

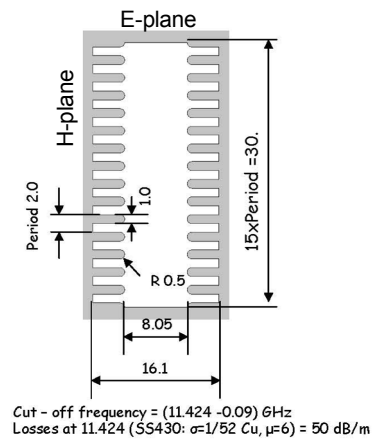
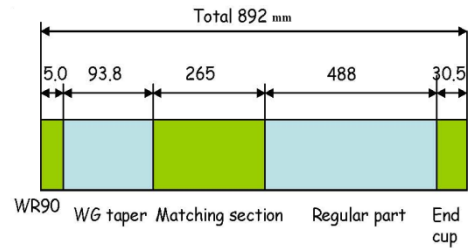

Figure 2: Five functional sections with their lengths (Top) and cross section of regular section (bottom).

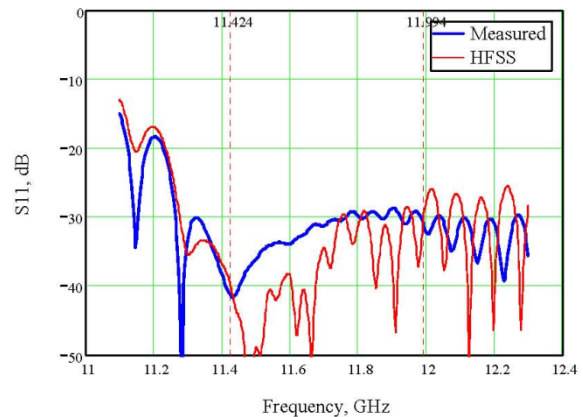

Figure 3: S11 parameters of double-band load.

The cross section view of the regular section where the RF power is actually damped is shown in Fig. 2 (bottom). By those wedges on H-plane the RF field is efficiently damped up to 50 dB/m.

[#]shuji.matsumoto@kek.jp

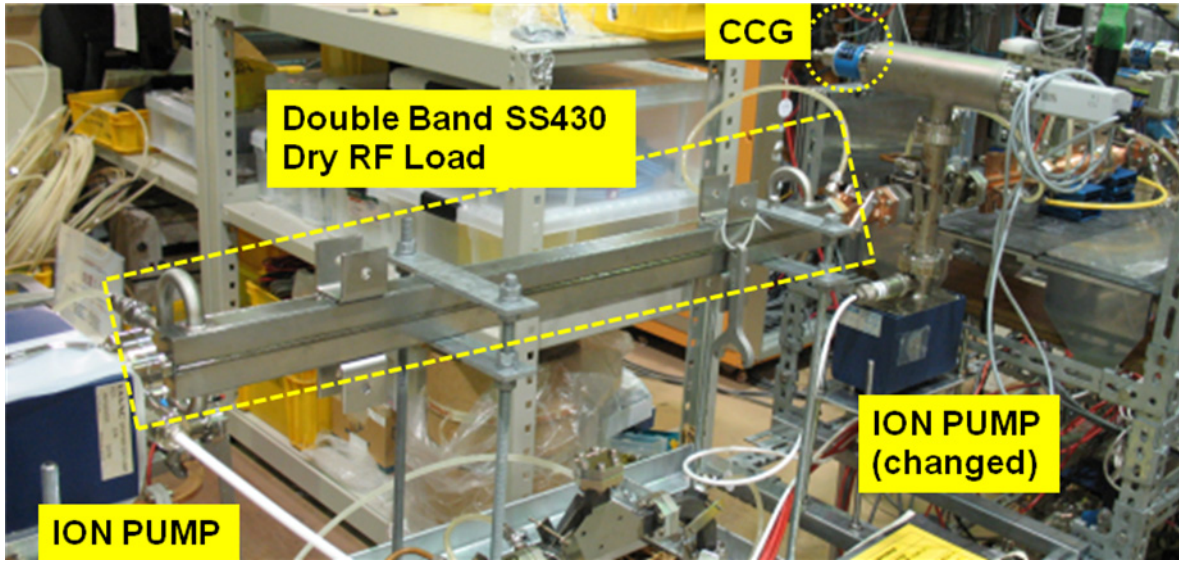

Figure 4: Double-band Load under test at KT-1 50 MW X-band (11.424GHz) station in KEK.

HIGH POWER TEST

The high power test of the load was done at KT-1, KEK's 50 MW X-band RF station [2]. The maximum available power depends on the pulse width (larger power available with shorter pulse width). The typical power and width of the station is 50 MW/400 ns. The maximum repetition rate is 50 pps.

The load was sent to KEK under atmosphere. The load was not baked before installing it to KT-1. Two 30 l/s ion pumps were set both upstream and downstream the load. The vacuum pressure was monitored by a cold cathode gauge (CCG) near the pump upstream, as shown in Fig. 4.

The high power test was started on Oct. 28, 2009. Lots of gas bursts occurred on this day and the ion pump, which was closest to the load, was replaced. The test restarted on Nov. 6 and the gas bursts disappeared. After a normal conditioning process, we measured the trip rate under fixed RF power/width as shown in Table 1.

Table 1: Trip Count Results

Power/width	Duration(Hours)	Number of Trips
60 MW / 200 ns	42.7	8
50 MW / 300 ns	104.5	4
40 MW / 500 ns	24.9	0

The observed trip rates were small and it was verified that the load can work fine. Note that the typical vacuum pressure observed by the CCG stayed around 10^{-6} Pa during the trip rate measurements.

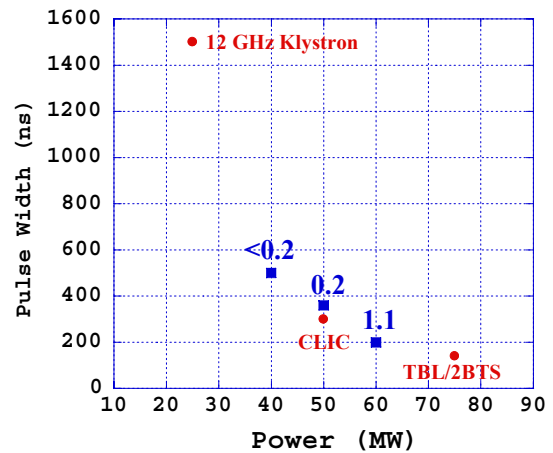

Figure 5: Load measurement results (blue dots show the points that were actually tested and the associated numbers are observed trip rates per 10^6 RF pulses).

DISCUSSION

The double-band loads will be used in various CLIC R&D programs [3, 4] and the corresponding working points (the power and the pulse width) are shown in Fig. 5 by the red points. One of these, "CLIC", verified in the high power test, showed that the load can work with very low trip rate, while the other two points were not explicitly tested due to the performance limit of KT-1.

The highest temperature raise due to the pulse heating appears at the tips of the wedges (Fig. 2, bottom). The operating temperature at these working points is summarized in Table 2. There is no significant difference in pulsed dT among the compared three points while T steady and Emax vary from each other and the difference is at most a factor of two. Since the load works successfully for the CLIC working point, we expect the load will also work for the other two cases without any serious problem.

Table 2: Pulsed Temperature Raises and Maximum E Fields of the Inside Surface of the Load

	Power (MW)	T pulse (ns)	Rep rate (Hz)	dT pulsed (°C)	T steady at wedge tip (°C)	E _{max} (MV/m)
CLIC	50	300	50	64	40.5	17
12 GHz klystron [2]	25	1500	50	72	60	12
TBL/2BTS [3]	75	140	5/25	66	28/32	20.8

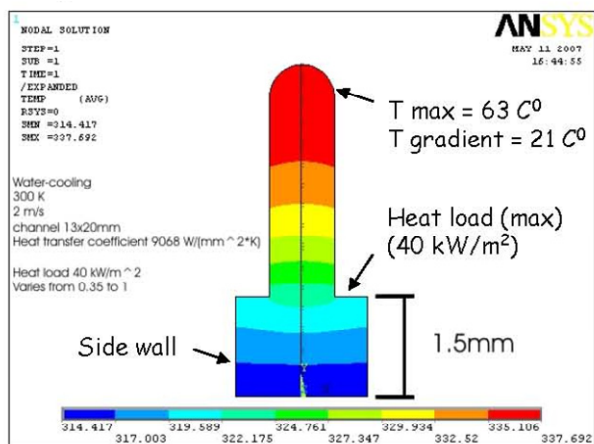

Figure 6: The temperature distribution of the wedge.

Heat deposit on the inner surface of an RF load should cause outgassing from the load. An RF load can be a source of gas if a multipactor process occurs inside. We did not observe significant outgassing from the double-band load during the normal operation while we sometimes observed the increase of the pressure when the power was very low (the input power into the load being a few MW). Note that the base vacuum pressure (the pressure when RF power is off) of KT-1 stays slightly lower than 10^{-6} Pa.

The RF loss along the load is not really uniform. From the profile of the H field on the surface along the load (Fig. 7, top), the power loss is evaluated -4 dB in the matching section. The absolute power dissipation in this section is larger than that in other sections. Simple measurement of the outer surface temperature suggests that the point of maximum heat production is indeed in the matching section (see Fig. 7, bottom). This also explains the observed outer surface temperature.

The minimum cooling water needed for this load is about 10 l/min to obtain a turbulent water flow. For the purpose of CLIC R&D programs, the net heat deposit to the load is not so large; therefore the cross section of the water channel of this load can be reduced.

CONCLUSIONS

We have evaluated the performance of an X-band RF load made by CERN, the double-band SS430 dry RF load, at high power testing at KT-1 station, 50 MW X-band RF station in KEK. The load, which was newly designed for the planned tests within the CLIC R&D programs, shows very good performance at high power testing. As far as

tested at KT-1, the measured trip rates are found to be small and we conclude there is no fundamental problem and that the load works very fine.

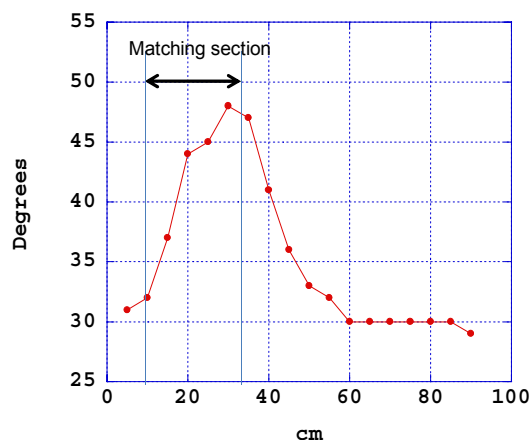
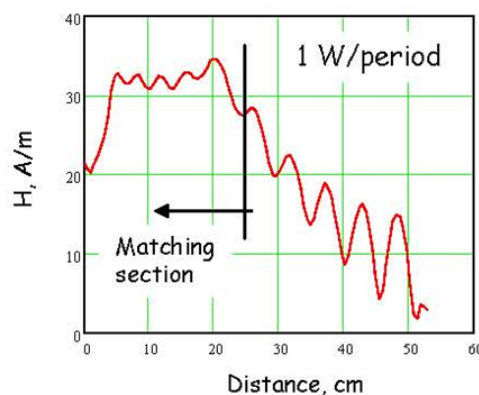

Figure 7: H field on the surface (Top) and measured temperature of outer surface along the welded joint (40 MW, 460 ns, 50 pps).

REFERENCES

- [1] H. Braun et al., "CLIC 2008 Parameters", CERN-OPEN-2008-021; CLIC-Note-764.
- [2] T. Higo et al., "Nextef: The 100 MW X-band Test Facility in KEK"; 11th European Particle Accelerator Conference, Genoa, Italy, 23 - 27 Jun 2008.
- [3] K. M. Shirm, et. al., "A 12 GHz RF Power Test Facility for the CLIC Study", THPEB053, IPAC10, Kyoto, Japan, May 2010.
- [4] R. Ruber et al., "CLIC Feasibility Demonstration at CTF3", LINAC'10, Tsukuba, Japan