

EUROPEAN ORGANIZATION FOR NUCLEAR RESEARCH

CERN/ISRC/71 - 4  
18 January, 1971

INTERSECTING STORAGE RINGS COMMITTEE

PREPARATION AND INSTALLATION OF THE ISR PHYSICS PROGRAMME

January 1971

F. Bonauđi and J.C. Sens

(DRAFT)

CERN LIBRARIES, GENEVA



CM-P00066428

## INTRODUCTION

In this report we present the status of preparation of the ISR experimental programme, as of January 1971, together with a provisional schedule for installation of the various set-ups around the rings. It was felt useful to compile the necessary data at this time firstly because decisions will be required as to how to match the start-up of the physics programme, which necessitates extended periods of access to the rings, to the programme of running-in of the ISR itself; and secondly because the experiments are now in an advanced design or construction stage and hence a useful summary can now be made as to what equipment will in fact be installed in the first phase of experimentation.

Apart from the performance of the ISR itself, four major factors influence the start-up of the experiments:

- 1) The time-table for manufacturing, delivery, assembly, testing and installation of detectors and heavy equipment, such as rectifiers, magnets, cooling, floorwork, etc.
- 2) The test runs scheduled at the PS for most experiments.
- 3) The installation of counting rooms, controls, connection with the control room, etc.
- 4) The time-table for delivery and installation of cables and connectors, mostly between the counting rooms and the tunnel

From the data in this report it follows that the installation activities could start in April, would reach a peak in June and July, and may well continue until ~ end 1971. Most of the work can be done intermittently with running the ISR. It is proposed to concentrate a number of activities which require the ISR to be off for more extended periods of time in one shut-down of ~ 3-4 weeks in April/May, and keep an option on a second shut-down in August 1971.

A list of accepted experiments is attached (Table 1).

The general layout of the ISR is shown on Fig. 1.

EXPERIMENTS IN I-1

Three experiments have been accepted for I-1 (see table 1)

R101: Angular and momentum distribution of secondaries with nuclear emulsions

Emulsions are placed in trolleys which are transported electrically via a rail between the area behind the shielding wall and the tunnel. Near the crossing point the rail forms part of a circle with  $\sim 2$  m radius. The emulsions are placed side by side over part of this circle and exposed for the order of several hours to days, to obtain data on angular and momentum distributions of the secondaries produced.

The rail and trolleys have arrived at CERN. The set-up will be ready by  $\sim$  February 1971.

It is intended to have a first exposure as early as possible after installation, at the outside side of the rings. A second exposure is intended, again at the outside side of the rings, just before the installation of experiment R103. For further exposures the rail will run from behind the inside shielding wall to the inside of the crossing region. The two positions for the rail are indicated in Fig. 2.

R102: Study of interactions in which gamma rays and electrons with large transverse momentum are emitted

This is a "survey" experiment for the detection of electromagnetic radiation at large transverse momenta:  $\gamma$ -rays and electrons from  $\pi$ , K, and possibly charged W decays.

The experiment is shown in Fig. 3 and consists of a magnet, a gas Cerenkov counter (nitrogen or iso-butane, 1 atm) to discriminate against charged pions and kaons, wire chambers and a shower detector for the identification of electrons;  $\gamma$ -rays are recognized by an additional anti counter and a converter. The magnet is a later addition to the original proposal; with the magnet the distinction between  $\gamma$ -events and electron events improves, and the energy resolution goes from  $\sim 25\%$  to  $\sim 10\%$  (See ISRC/70-11)

Table 4 gives some data on the time schedule for preparations of experiments in I-1.

The chambers and counters are presently under construction; the magnet exists. A magnetic shield, required to shield the ISR beams against the stray field of the magnet, has been designed; this shield is compatible with experiment R103 and will be removed in part for experiment R101. Optical chambers are used in the shower detector, they are photographed through a duct in the shielding wall. The group is provisionally scheduled for a run at the PS in May/June in the  $m_0$  beam (See table 2) in order to test the shower detector. The group has recently considered the detection of quarks and other massive particles with the same equipment. As a result a counter hodoscope has been added at the far end of the detector to measure  $dE/dX$  and time of flight. The overall layout remains essentially unchanged.

The data handling is done with a CII 9010 computer (Disc and tapes) on-line. The analysis and Monte-Carlo calculation will be done at Saclay.

Power and cooling requirements in Table 3.

#### R103: Search for massive dileptons

The equipment consists of wire chambers, scintillators and lead glass cells with which the energies of two electrons and their opening angle is measured, See Fig. 4. A significant change with respect to the original proposal is the use of heavy liquid scintillator cells to reject pions of low energy instead of a gas Cerenkov counter. There are two triggers: a large angle trigger, covering opening angles  $100^\circ < \Theta < 180^\circ$ , to be used when detectors are placed at both sides of the crossing point; a small angle trigger,  $\Theta < 80^\circ$ , for two particles in the same detector.

Some delivery dates are:

Lead glass :  $1/2$  of order arrival at CERN end April, mounting April-August.  
Spark chambers: Prototype end January, SC test February, modules ready April/May.  
Heavy liquid cells: under construction at BNL.

The group is scheduled for tests of the lead glass detector in beam  $p_4$  at the PS in August (see Table 2). The experiment thus cannot start until Sept.

Data handling is done with a small computer on-line (HP 2116 B).

### I-1 MONITOR

The monitor consists of 12 scintillators, 3 above and below each downstream pipe, at 5-6 m from the crossing point. It monitors time stability and beam/beam to beam/gas ratios under various conditions.

The monitor is under construction by the R103 group and is available for all users in I-1. It will be ready in March.

### I-1 GENERAL

#### Vacuum chamber

The present vacuum chamber consists of two intersecting cylinders  $\phi_{in} = 161$  mm,  $t = 2.0$  mm, with strengthening plates running along the top and bottom parts of the X-region.

For the future it is envisaged to replace the chambers in I-1, I-2 and possibly I-6 by a "corrugated cone" chamber (thin walled, axial symmetry, no strengthening bars). This chamber is presently under development (see Fig. 5).

#### Counting rooms, power, cooling, etc.

Intersection I-1 is housed under the demountable section of shielding covering the ring in this region. Due to the special nature of this area, it is not necessary to build a counting room. The electronics of the experiments will be located on the floor of the experimental hall surrounding this region (Hall I-1). With reference to Fig. 2 the relative locations will be bottom right for R102 and bottom left for R103. The signal and control cables will traverse the shield through two penetrations (to be added in the shielding wall); the same penetrations will be used also for some other connections, like magnet cables, etc. The rectifier power supply for experiment R102 will also be located on the floor of the hall (AC power for it can be made available in the hall); similarly a pressure boosting pump required for the cooling will be placed in the hall.

Compatibility and installation problems

The three experiments accepted for I-1 are mutually incompatible to some extent and alternating between them will be required. The overall layout of the 3 experiments is shown in Fig. 2. The assembly shown on the crossing point is typically a set-up allowing simultaneous running by experiment R102 with complete apparatus, and by experiment R103 with one side of the detector only (the side external to the rings). The inset in the lower left corner of the drawing shows the complete set-up of experiment R103 running alone. Two possible (but not unique) alternative storage positions for the magnet of experiment R102 in the "off" phase are shown.

As for the alternations required between the experiments, it is estimated that it will be possible to change from one set-up to another (e.g. R101 + R102 to R103; or R103 to R101; or R101 to R102, etc.) during one week of ISR off-time.

EXPERIMENTS IN I-2

Four experiments have been accepted for I-2 (See table 1).

R201 Production of stable particles at small angles

In this experiment particles produced between  $\sim 15$  and  $150$  mrad and with momenta between  $\sim 0.5$  and  $25$  GeV/c are detected in a  $28$  m long spectrometer, mounted in the vertical plane.

The layout is shown in Figs. 6 and 7: 2 septum magnets, 3 bending magnets, 3 Cerenkov counters, chambers and scintillators. The septum magnets and the first two Cerenkov counters are on movable supports, to cover the angular range.

The time-table for manufacturing, assembly, tests, installation of the heavy items is given in Table 5.

Some other delivery dates are:

- Spark chambers : prototype end January, full set  $\sim$  April.
- Electronics : being assembled, several items not before May.
- Scintillators, etc.: ready in February/March.

The group is scheduled (see table 2) for tests of the Cerenkov counters and scintillators in beam  $d_{30a}$  at the PS; for spark chamber tests in beam  $t_1$ . Both tests will run until end April.

Inspection of table 5 shows that installation of the major items could start in April and extend to September.

The data handling is done by a IBM 1800 computer (24 K, 1 Disc, 2 tapes), connected to the CDC computers through FOCUS. Installation of IBM 1800: 1 May.

Power and cooling requirements are given in table 3.

R 202: Study of particle production in high energy proton-proton collisions at medium angles

The experiment measures particle spectra between  $\sim 80$  and  $250$  mrad and in the momentum range  $1.5$  to  $10$  GeV/c. Threshold Cerenkov counters and time of flight resolve  $\pi$ , K and p. The measurement is done by holding  $p_{\perp}^*$  constant. The general layout is shown in Fig. 6 and consists of a septum magnet followed by two bending magnets. Behind the first bending magnet particles with different angles of production follow the same trajectory. Their momentum is then analysed in the second bending magnet, which bends the particles vertically. A detailed layout is shown in Fig. 8.

The septum magnet has been constructed at ANL and has arrived at CERN. The time-table for installation of the major items is indicated in table 5.

Testing of electronics and Cerenkov counters has been scheduled in  $d_{30a}$  at the PS between February and  $\sim 15$  April (see table 2).

The equipment can be installed in the tunnel from the beginning of April onwards. The electronics is installed in a trailer which has been at CERN since some time.

Power and cooling requirements are shown in table 3.

R203: Experiment to determine low-energy production spectra of  $\pi^{\pm}$ ,  $K^{\pm}$ , p,  $\bar{d}$ , etc. at large angles

A wide angle spectrometer is under construction with which the angular and momentum distribution of secondaries is measured between  $\sim 30^{\circ}$  and  $\sim 90^{\circ}$  (see Fig. 6). The spectrometer consists of a rotating platform on which magnets, chambers and counters can be placed in two configurations: a "high" momentum configuration for the measurement of particle spectra  $< 8$  GeV/c (as part of experiment R204) and a "low" momentum configuration for particles below  $\sim 2.0$  GeV/c, down to  $\sim 200$  MeV/c. The two configurations are indicated in Fig. 9.

The time-table for the manufacturing, testing and installation of the platform, magnets, Cerenkov counters and auxiliary equipment is indicated in table 5.

Some delivery dates are (for counters, chambers and electronics):

Wire chambers (RHEL)	:	1 June
Hodoscopes (Copenhagen)	:	1 March
Cerenkov counters (Liverpool):		1 July
Scintillator/lead sandwich:		June
Electronics (NIM)	:	1 February
(CAMAC) (RHEL):		1 March.

The group is scheduled for tests at the PS until the end of April, see table 2. Data handling is done with a DDP 516 computer (Disc, tape), which the group intends to connect through FOCUS to the CDC's. The DDP 516 will not arrive at CERN before the end of May. Power and cooling requirements are given in table 3.

Power and cooling requirements are given in table 3.

A rearrangement of detectors on the platform of the wide-angle spectrometer is presently being considered in view of a search for quarks. The platform would then be put at some intermediate angle and left there:



R 204 Measurements of particles with large transverse momentum as a search  
for the intermediate boson

The purpose of this experiment is to identify high energy, large angle muons as the decay product of the intermediate boson. It consists of a detector which identifies muons by momentum and range and a wide angle spectrometer to measure muon spectra from  $\pi$  and K decay.

The muon detector is indicated in Fig. 6. The bulk of the detector is composed of optical spark chambers sandwiched between magnetized iron plates. A Pb absorber is placed in front of the detector to reduce the rate of  $\mu$ 's from  $\pi$ , K, decay. Chambers and a solid Cerenkov counter are placed close to the crossing point to suppress cosmic ray events. The high momentum version of the spectrometer of experiment R 203 (see Fig. 9) will be used to measure the  $\pi$ , K spectra from which the muon background can be calculated.

The time-table for construction, etc. of the heavy items is in table 5. Some additional delivery dates for counters etc. are:

Thick plate chambers:  $\frac{1}{2}$  by Mid-May,  $\frac{1}{2}$  by August.

Multi gap chambers: 1 September

Wire chambers:  $\frac{1}{2}$  in May

Counters: 15 April - 1 August

Cerenkov counters: part 1 August, all 1 September

Optical system:  $\frac{1}{2}$  by 15 May, all by 15 June

Light tight housing: 1 May

Electronics (CAMAC): 1 February.

No test runs at the PS are foreseen.

Data handling through PDP 8 (Deck tapes,  $\frac{1}{2}$  " 7 track tapes, 8 K); films to CYCLOPS at RHEL. Programme development and Monte Carlo at CERN.

Power and cooling requirements in table 3.

## I-2 MONITOR

The horizontal (HM) and vertical (VM) monitors are sketched in Fig. 10. HM is at  $55^\circ$  from the bisector, VM is at  $90^\circ$  downwards. They serve to record the projected density distributions of collisions as a function of time under various ISR conditions.

HM and VM consist of nearly identical arrangements of scintillators, chambers, liquid Cerenkov counters and absorbers.

The time-table for manufacturing, etc. of the frames is indicated in table 5. The installation can begin in May 1971.

A relative monitor using scintillators at the entrance of the first septum of experiment R 201 and others downstream along the other pipe is also foreseen.

PS tests for scintillators in beam  $d_{30a}$  : February - end April.

Data are handled through CAMAC and read into the DDP 516 of experiment R 203 and the IBM 1800 of experiment R 201 in parallel.

The I-2 monitors are constructed by the group of experiment R 201, with contributions from experiment R 202. They are available to all users of I-2.

## I-2 GENERAL

### Vacuum chamber

The present chamber consists of two intersecting cylinders  $\phi_{in} = 161$  mm and  $t = 2.0$  mm with strengthening plates along the top and bottom part of the crossing region. The strengthening plates are "open", such that, seen from above and below, they follow the contour of the region of interactions. At 1.50 m from the crossing point there is a transition from the cylindrical to the standard elliptical cross section.

It is intended to replace the present chamber by a "corrugated cone", similar to the one discussed for I-1, if such a chamber turns out to be feasible. The design is shown in Fig. 5.

Counting room, power, cooling, etc.

The counting room for I-2, under construction, is located above the earth shielding of the ring. It is about 35 m long and 10 m wide: it will house the electronics of experiments R201, R203 and R204. Experiment R202 will use their own trailer, parked close to the counting room.

The 11 conventional rectifier power supplies required will be housed in the existing auxiliary building A2, while the two high current (20 kA) supplies for the two septum magnets of experiment R201 will be located inside the ring.

The necessary extensions of the AC power network have been foreseen and are under construction; the cooling will be provided by extensions of the ISR machine cooling system, in the form of one low pressure and one high pressure system to cover the wide range of pressures required (see table 3). The time-schedule of this work is shown in Table 5.

Compatibilities and installation problems

The installation of the experiments at I-2 will present problems, as this crossing point is densely packed with equipment. Some work will require a shut-down of 3 to 4 weeks (civil engineering work for the foundation of the rotating platform of experiment R203, and for the 20 kA busbars of experiment R201). Several large pieces of bulky equipment have to be brought into the ring in a well studied sequence: this equipment includes the rotating platform for R203, the magnetic plates and igloo for R204, the two 20 kA rectifiers for R201 (not appearing on Fig. 6). It is expected that this assembly work can all be done without a shut-down, but for reasons of efficiency and safety, it is preferable to lump together the free-access-to-ring periods each week, rather than having some hours each day, separated by ISR runs. The foreseen installation periods are shown on table 5.

Concerning the running of the 4 experiments and the monitor in I-2 there are incompatibilities:

- 1) between the "low" and the "high" momentum version of experiment R203.
- 2) between the "low" momentum version of experiment R203 (in its large angle position) and the I-2 monitor (horizontal part).

- 3) possibly between the I-2 monitor (horizontal part) and part of the angular range covered by experiment R202. The design of supports, etc. is not yet sufficiently advanced to clear this point.

It seems likely that during the running-in and early data taking period all 4 experiments in I-2 can run simultaneously, but that in order to complete them some scheduling will be required.

#### EXPERIMENTS IN I-4

The split field magnet (SFM) project group has requested tests in I-4. One experiment has been accepted for I-4 (see table 1).

#### I-4 S.F.M. Facility

4 test chambers are under construction. The group intends to test them in I4 as of July 1971.

Construction chambers	up to ~ 15 April
Construction supports	up to 1 July
Cables and tubes	up to 1 July
Installation chambers	up to 15 July
Survey	up to 1 August
Installation EMR 6130	June.

The data will be handled by a EMR 6130 computer. This computer will be linked to a CII 10070 (Omega) computer at a later date.

R401 Measurement of energy dependence of isobar excitation in proton-proton collisions

The purpose of this experiment is to measure differential and total cross sections for reactions in which  $N^* \rightarrow n + \pi^+$  and  $\Delta^{++} \rightarrow p + n^+$  are produced. The equipment consists of proportional chambers, Cerenkov counters, and neutron detectors (proportional chambers, anti counter, Pb plates) placed in the S.F.M. and the downstream compensators.

Apart from the chambers in SFM, 6 full size (or 12 half size) chambers will be mounted in the compensator. These chambers are being developed in Vienna.

A set of large neutron detectors ( $1.10 \times 1.10$  m) or  $2 \times (0.5 \times 1.1$  m) will be manufactured at Orsay. This set and a Cerenkov counter is to be placed at the exit of SFM at 5 m downstream.

A set of small neutron detectors ( $0.5 \times 0.5$  m) has been tested in the  $b_{16}$  beam at the PS and is presently under test in Saclay.

The experiment will not start until end 1972, hence no installation details need be given now.

I-4 Monitors

It is intended (subject to approval by the ISRC) to set up several counter hodoscopes, proportional chambers, and several other counters, in order to measure the height of each circulating beam, the luminosity and to collect various background data.

The counter hodoscopes with associated electronics are ready for installation.

The chambers are presently being tested at Saclay and will be available in February/March. Data handling of the chamber data will be done with a Varian computer.

I-4 GENERAL

Vacuum chamber

The present chamber consists of two intersecting elliptical pipes, with strengthening plates along the top and bottom part of the section. There are no transitions.

For the future (S.F.M. shown in Fig. 11) several options are under study, e.g. a movable, 0.15 mm thick, corrugated, 50 x 150 mm titanium pipe.

Counting room, power, cooling, etc.

A counting room for I-4, located above the earth shield, is under construction (about 32 m long, 10 m wide). It should be available in May 1971, and it will be used first of all by the groups testing the chambers for the S.F.M; later on, it will cover the needs of the experimentation with the S.F.M.

Magnet power and cooling will be required when the SFM is available (testing in 1972, experimentation from end 1972 onwards), the rectifiers required are on order, as part of the SFM project. For the cooling system, a limited extension of the ISR machine cooling plant has been decided upon, allowing full running of the Phase I experimental programme + SFM at top ISR energy for most of the year, but requiring some load limitation in hot summer conditions.

### EXPERIMENTS IN I-6

Three experiments have been accepted for I-6 (see table 1)

#### R601: The measurement of the proton-proton differential cross section in the Coulomb interference region

In this experiment small scintillators are placed near the circulating beams at both downstream ends of the intersection in order to measure coincidences between scattered protons at small angles in the vertical plane.

In each downstream arm 2 special vacuum sections are installed, each containing 2 movable reentrant pots. In the definitive version of the experiment half the pots will contain 12 scintillators each, the other half less, all movable with respect to the pots. The layout is shown in Fig. 12, details of one pot are shown in Fig. 13.

The "front" pots accept the range 1.7 to 11.3 mrad, the "rear" pots 1.4 to 1.9 mrad. When running together with experiment R602 the accepted range of angles of the "front" pots in the semi space occupied by R602 is from 1.7 to 2.8 mrad.

The design of the pots and of the movable counter supports has been completed. Construction has started and a prototype pot will be ready in March. 4 pots will be ready in May. Remote control equipment is on order. The prototype counter assembly has been completed and a full set of counters will be ready in February/March (outside CERN)(see table 6 for time-table).

The group has made tests at the PS to examine background from beam/gas events. No further tests are foreseen for 1971.

Data handling is done through CAMAC and HP 2116 B.

The group is designing additional counters for quark detection.

#### R602 Measurement of the elastic scattering cross section beyond the Coulomb interference region

In this experiment elastically scattered protons are detected in coincidence by a counter hodoscope, 3 sets of proportional chambers and a steel septum magnet, at each side of the intersection, in the vertical plane. In the present version the counter hodoscope consists of 5 counters, side by side in the horizontal plane. The chambers are in front of, inside and at the end of the septum magnets.

The group has proposed two additions to the apparatus: a proportional counter hodoscope (ISRC/69-13/Add.3), consisting of 64 layers of 2 cm deep by 4 cm wide counters, in order to measure  $dE/dX$  also for events in which several particles traverse the detector (quarks), and two gas Cerenkov counters (ISRC/69-19/Add.2) to recognize events due to inelastic processes.

The layout is shown in Figs. 12 (bottom) and 13. Fig. 13 also shows chambers above and below, which serve to measure the luminosity and to calibrate the elastic scattering equipment by recording coincidences between tracks in the forward direction with tracks at large angles, due to beam/gas collisions. Both Figs. 12 and 13 show the definitive vacuum chamber (see below).

Some delivery dates are:

Steel septum magnet # 1	:	delivery ~ 1 September, field mapped, ready for installation ~ 1 Oct.
Steel septum magnet # 2	:	delivery ~ 1 October, field mapped, ready for installation ~ 1 Nov.
Counters	:	February/March
Proportional chambers	:	~ April
Stand for luminosity telescope:	:	design finished.

The group is scheduled for test runs at the PS in beam  $b_{17}$  from February to April.

Data handling is done by an IBM 1800 (24 K, Disc, tapes) connected to FOCUS.

The group proposes to do the small angle part of the experiment ( $\sim 12$  mrad to  $\sim 30$  mrad) without the steel septum magnets and extend the range to  $\sim 100$  mrad when they become available.

Power and cooling requirements are shown on table 3.



R603 Measurement of the p-p total cross section

In this experiment the total cross section is measured by recording coincidences between one or more elements of counter hodoscopes placed along one downstream arm with one or more elements placed along the other arm. The hodoscopes cover angles up to 500 mrad over nearly the full azimuth and from 500 mrad to 90° over 10% of full azimuth. This covers an estimated 90% of the events to be detected.

The central part of the detector covers angles between 40 mrad and ~ 30°. The outer detectors cover the smaller angles ( $\geq 10$  mrad).

The group has proposed an additional hodoscope (with dE/dX counters and absorbers) to detect quarks eventually in coincidence with events of specific topology in the main hodoscopes.

The hodoscopes near the upstream pipes measure beam/gas interactions over several meters, together with spark chambers placed along these pipes (not shown in Fig. 12).

The layout is shown in Fig. 12 (top).

Some delivery dates are:

Stands for the central part (< 5 m from crossing point)	:April
Stands for outer part	:July/August
Spark chambers	:June
Central hodoscopes ready	:May
Electronics (CAMAC, interface)	:uncertain.
Computer	:uncertain.

PS tests are scheduled in February (counters) and June-August (counters and chambers).

Data handling by a small computer and FOCUS

I-6 MENTORS

For experiment R601 no special monitor is foreseen.

For experiment R602 the monitoring is done with coincidences between small and large angle tracks, due to beam/gas interactions.

For experiment R603 chambers are foreseen along the upstream pipes and at 90°.

## I-6 GENERAL

### Vacuum chamber

The present vacuum chamber consists of two crossing cylindrical pipes strengthened by 6 "wheels" (with axis parallel to the bisector of the rings. At 2.5 m along the downstream arms the cylindrical cross section changes to a half cylindrical/half elliptical cross section. This compromise has been chosen in order to enable all groups in I-6 to run in their experiments, while remaining within the norms set by the ISR.

For the future different solutions are required for the different experiments. For experiment R601, if run alone, crossing cylindrical pipes, plus the reentrant pots would be adequate. For experiment R602 a central box with two cones attached, shown in Fig. 12 and 14 is presently under construction. For experiment R603 a corrugated cone similar to the one for I-4 and I-2 is under study (see Fig. 5).

### Counting room, power, cooling, etc.

A counting room (about 32 m long, 10 m wide) located above the earth shielding is under construction and will house the 3 experiments. The eight rectifier power supplies required by experiment R602 will be housed inside the existing auxiliary building A7, to which the necessary extra AC power is being added.

The cooling will be provided by tapping spare capacity of the ISR machine cooling system and adding a pressure boosting pump. The timetable of these preparations is shown on table 6.

### Installation problems

One of the two steel septum magnets will require a pit: this work will be possible only at the end of 1971 (probably during the next long PS shut-down).

Concerning the running of the three experiments there are evident incompatibilities:

- 1) With R601 and R602 installed at the same time the range of accepted angles in R601 below and above the median plane are different. R601 therefore loses important cross checks on the data.
- 2) With R601 and R603 installed at the same time, R601 becomes symmetric, although limited in angular range by the requirement of R603 that the vacuum pipe be small in diameter.
- 3) R602 and R603 are fully incompatible and require different definitive vacuum chambers.

Even if all groups start simultaneously (as they propose) scheduling will be necessary soon after start-up. Since the criterium of "maximum results in minimum time" implies more than a rapid installation, the scheduling will depend on factors outside the scope of this report (development of soft ware, feedback between results and measurements, etc.) as well.

Table 1

EUROPEAN ORGANIZATION FOR NUCLEAR RESEARCH

PROGRAMME OF ACCEPTED EXPERIMENTS

CERN INTERSECTING STORAGE RINGS

December 1970

J.C. Sens  
ISR Co-ordinator

ACCEPTED CERN ISR EXPERIMENTS

Area	Expt. Code	Reference Number	Description of Experiment	Present composition of group	Date of NPRC Acceptance	Status
1-1	R101	CERN/ISR/69-6, and Add.1,2,3 CERN/ISR/69-37, and Add. 1 CERN/ISR/69-41 CERN/ISR/69-50, and Add.1	Angular and momentum distribution of secondaries with nuclear emulsions	CERN-Cracow-Bucharest-Tata emulsion collaboration: Herz, Cordaillat, Friedländer, Marin, Vicky, Haiduc, Gierula, Annoni	NPRC 85, 5.11.1969	
1-1	R102	CERN/ISR/69-11/Rev. and Add. 1, 2, 3	Study of interactions in which gamma rays and electrons with large transverse momentum are emitted	Saclay-Strasbourg collaboration: Cheze, Hamel, Stirling, Teiger, Thevenet, Zaccone, Zsembery; Chatlus, Croissiaux, Morand, Pahin	NPRC 85 5.11.1969	
1-1	R103	CERN/ISR/69-43, and Add.1	Search for Massive Dileptons	CERN-Columbia-Rockefeller Collaboration: Di Lella, Placci, Pope, Smith, Zavattini; Lederman, Blumenfeld, Cool, Segler	NPRC 85 5.11.1969	

ACCEPTED CERN ISR EXPERIMENTS

Area	Expt. Code	Reference Number	Description of Experiment	Present composition of group	Date of NPRC Acceptance	Status
1-2	R201	CERN/ISR/69-5, and Add.1, 2 CERN/ISR/69-9	Production of stable particles at small angles	CERN-Holland-Lancaster-Manchester Collaboration: Albrow, Barber, Boggaerts, Bošnjaković, Clegg, Erné, Kanaris, Locke, Murphy, <u>Sens</u>	NPRC 83 4.7.1969	
1-2	R202	CERN/ISR/69-7, and Add.1	Study of particle production in high energy proton-proton collisions at medium angles	Argonne-Bologna-Michigan Collaboration: Ratner; Ellis, Giacomelli; Babcock, <u>Krisch</u> , Roberts, Maroni, Vannini	NPRC 83 4.7.1969	
1-2	R203	CERN/ISR/69-48	Experiment to determine low-energy production spectra of $\pi^+$ , $K^+$ , $p$ , $\bar{d}$ ,... etc. at large angles	The collaboration mentioned below and the Scandinavian Collaboration: Almehed, Carlson, Von Dardel, Gjesdal, Jarlskog, Klovning, Lillethun <u>-----</u>	NPRC 83 4.7.1969	
1-2	R204	CERN/ISR/69-3	Measurement of particles with large transverse momentum as a search for the intermediate boson	British Universities Collaboration: Booth, Carrol, Gibson, Hanna, Alper, Jackson, Heyman, Malos, Manning, <u>Potter</u> , Sharp, Sharrock	NPRC 83 4.7.1969	

ACCEPTED CERN ISR EXPERIMENTS

Area	Expt. Code	Reference Number	Description of Experiment	Present composition of group	Date of NPRC Acceptance	Status
I-4	R40E	CERN/ISRC/69-14	Measurement of energy dependence of isobar excitation in proton-proton collisions	CERN-Hamburg-Orsay-Vienna Collaboration: Schmidt-Parzefall, Winter; Flüge, Niebergall, <u>Schubert</u> ; Broll, Coignet, Favier, Vivargent; Dibon, Gottfried, Oberparleiter, <u>Regler</u>	NPRC 83 4.7.1969	

ACCEPTED CERN ISR EXPERIMENTS

Area	Expt. Code	Reference Number	Description of Experiment	Present composition of group	Date of NPRC Acceptance	Status
1-6	R601	CERN/ISRC/69-20, and Add.1, 2 CERN/ISRC/70-7, and Add.2	The measurement of proton-proton differential cross section in the Coulomb interference region	CERN-Rome Collaboration: Allaby, Amaldi, Biancastelli, Bosio, Cocconi, Diddens, Dobinson, Litt, <u>Matthiae</u> , Rochester, Schlüpmann, Schneider, Stahlbrandt, <u>Strolin</u> , <u>Wetherell</u>	NPRC 83 4.7.1969	
1-6	R602	CERN/ISRC/69-19, and Add.1	Measurement of the elastic scattering cross section beyond the Coulomb interference region	CERN-Aachen-Genova-Torino Collaboration: Darriulat, Pilcher, Rubbia, <u>Strolin</u> , Tittel; Holder, Rademacher, Staude; Diambri, Giannini, Ottonello, Santroni, Sette; Bisi, Fainberg, Ferrero, Sciré	NPRC 83 4.7.1969	
1-6	R603	CERN/ISRC/69-12	Measurement of the p-p total cross section	Pisa-Stony Brook Collaboration: <u>Bellettini</u> , Braccini, Bradaschia, Castaldi, Cerri, Ciancaglini, Del Prete, Foà, Giromini, Menzione, Sanguinetti, Valdata, <u>Finocchiaro</u> , Good, Blieden, Grannis, Kirz	NPRC 83 4.7.1969	



v = allocated time  
 T = Test  
 p = either target 1 or 8 operate in parasitic mode  
 R = test facilities for ISR experiments  
 ( ) = not included in allocated time

1/2 = one pulse in two  
 | = end of allocated time

PROPOSED PS DRAFT SCHEDULE FOR 1971  
 (Weeks 19 onwards are most tentative)

Table 2

PS/Coord/231  
 14.12.1970

Date	Start / End	Nr. wks.	Code	7/1 14/1	21/1 5/2	11/2 26/2	4/3 19/3	25/3 8/4	15/4 30/4	6/5 21/5	27/5 11/6	17/6 2/7	8/7 23/7	29/7 13/8	19/8 3/9	9/9 24/9	30/9 15/10	21/10 5/11	11/11 26/11	2/12 17/12	
Weeks				2-3	4-6	7-9	10-12	13-15	16-18	19-21	22-24	25-27	28-30	31-33	34-36	37-39	40-42	43-45	46-48	49-51	
Flat-top energies				19.2	21	24	24	24	24	24	24	24	24	24	24	24	24	24	24	24	
Target 1	b <sub>16</sub>	n p charge exchange scattering	6	S108	(T)	R-401		R-401	(p) R401	S108 1/2 v	v v v			v v		v					
	d <sub>30</sub>	K <sup>+</sup> p scattering	2-6	S 91	(T)	T T		v v		1/2 v	v v v			v							
	d <sub>30a</sub>	Δ <sub>0</sub> missing mass	?	S104	(T)	R-201 R-202	R-201 (p) R-202	R-201 (p) R-202	R-201 (p) R-202					S104, Δ <sup>0</sup>	No	time	allocation	yet			
	m <sub>7</sub>	ΔS/ΔQ rule; K <sup>0</sup> → π <sup>+</sup> π <sup>-</sup> π <sup>0</sup>	2	S 74	(v)	v v	S100 K <sup>-</sup> n			1/2 T	T T	T v			v v		v v		v		
	m <sub>7a</sub>	K <sup>-</sup> n elastic scattering	6	S100																	
	m <sub>11</sub>	p̄p → p̄p, π <sup>+</sup> π <sup>-</sup> , K <sup>+</sup> K <sup>-</sup>	6	S 99	(T)	T T		T T				v			v v		v v		v		
	t <sub>1</sub>	Test beam			(T)	R-603	R-203 (p) R-201	R-203 R-201	R-203 (p) R-201	R-203 (p) R-201	S104 T 1/2 T	T S104 T	(p) R-603	R-603 (p)	R-603						
Target 8	q <sub>10</sub>	π <sup>+</sup> p <sub>T</sub> → p π <sup>+</sup> , π <sup>+</sup> p <sub>T</sub> → Σ <sup>+</sup> K <sup>+</sup> , K <sup>+</sup> p <sub>T</sub> → K <sup>+</sup> p	10	S105	(T)	T T		v v			1/2 v	v v v			v v		v v		v		
	m <sub>9</sub>	p̄p → π <sup>+</sup> π <sup>-</sup>	4	S 86	(v)	v v		v v		(p) R-102	R-102	(p) S84	S84 T T	S84 T T	S84 T T						
SE 62	b <sub>17</sub>	Determination of ratio η <sub>00</sub> /η <sub>+</sub>	4	S 82			R-602		R-602					S109 T T							
	k <sub>12</sub> , k <sub>12a</sub>	K-mesic atoms Hypernuclear gamma rays	4 8	P7 P6 S109			v v	v v	v v					v v	S109 8 wks. k <sub>12a</sub>		v v		4/5 v v	v v	
	p <sub>4</sub>	Reserve																	R-103		
	p <sub>5</sub> , p <sub>7</sub>	π <sup>-</sup> p → π <sup>+</sup> π <sup>-</sup> n, K <sup>+</sup> K <sup>-</sup> n K <sup>-</sup> p → K <sup>0</sup> n; K <sup>-</sup> p → K <sup>0</sup> n	6 8	S94 S102			v v	v v	v v	v v	S102 P7		v v			v v		v 4/5 v v		v v	
	e <sub>9N</sub>	Hyperon beam	4	S103		(v)	v		v v v												
	e <sub>9S</sub>	Measurement of φ <sub>η±</sub>	6	S 93			v v		v v v												
	Target 6	k <sub>13</sub>	HBC 81				v v v v v v	Reserve		Install. HyBUC			T T			T T			4/5 T T		T T
FE 58	u <sub>5</sub>	HBC 200		(T)	v v	v v v v v v		v v v v v v		v v v v v v		m <sub>6</sub> v v	v v v v v v	v v v v v v	v v v v v v	v v v v v v	v v v v v v	v v v v v v	v v v v v v	v v v v v v	
FE 74	ν <sub>p6</sub> , m <sub>12</sub>	Gargamelle		(T)	T T		T T		T T	Neutrino 1/2 v			Neutrino v v	← m <sub>12</sub> →		m <sub>12</sub> v v	P10, exotic nuclei	v v			

No allocated time for neutrino and m<sub>12</sub>.

TABLE 3

Power and Cooling Requirements for ISR Experiments of Phase I

Location and components to be cooled	Power dissipation kW	$\Delta p$ kg/cm <sup>2</sup>
<u>Intersection I 1</u>		
Saclay magnet (R 102)	250	12 <sup>1)</sup>
<u>Intersection I 2</u>		
<u>Small angle spectrometer (R 201)</u>		
1st Septum magnet	540	10
2nd Septum magnet	480	10
Three MC 2m, 160 kW each	480	8
<u>Medium angle spectrometer (R 202)</u>		
Septum magnet	190	15
Septum magnet correction coils	3	15
MC 1 m	145	12
MH 2 m	140	4
<u>Large angle spectrometer (R 203)</u>		
Main magnet	400	27 <sup>1)</sup>
Auxiliary magnet	80	5
<u>Muon detector (R 204)</u>	25	5
(R 201) (Two 20 kA bus bar systems, 50 kW each)	100	<5 <sup>2)</sup>
(Two 20 kA rectifiers, 260 kW each)	500 <sup>3)</sup>	5
Other rectifiers (in A2 Building)	negligible	5
<u>Intersection I 6</u>		
Two magnets (steel septum type) (R 602) 600 kW each	1200	15
Approximate total power dissipation	4533	

1) Booster pump will be installed

2) Raw water. Filter will be necessary.

3) Approximate value

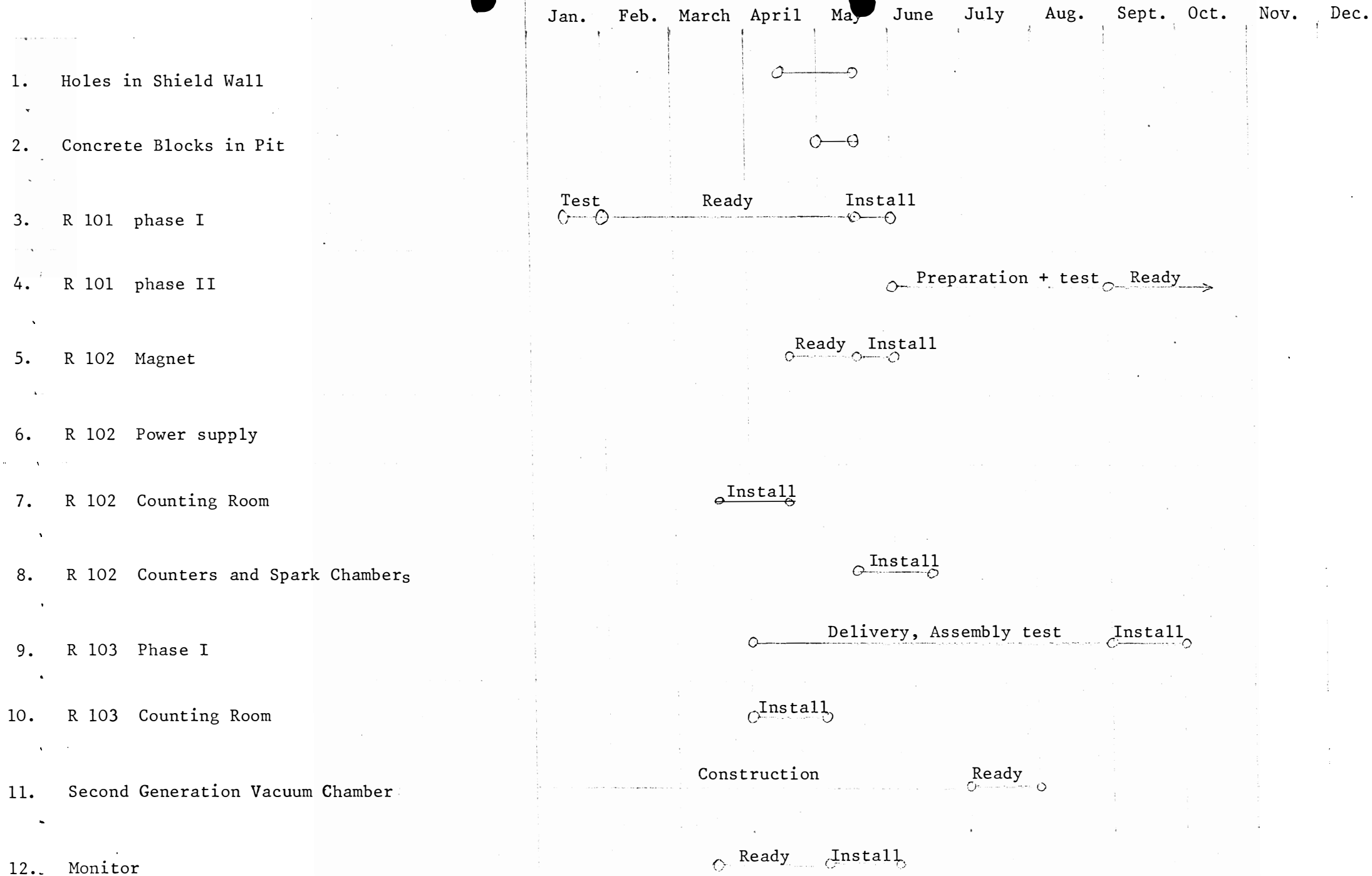

Table 4 - Draft Timetable for Experiments in I-1



Feb. Mar. Apr. May June Jul. Aug. Sept. Oct. Nov. Dec.

1. Counting Room
2. Permanent Cabling
3. R 601 Pots
4. R 601 Counters
5. R 602 Magnet 1 coil
6. R 602 Magnet 2 coil
7. R 602 Magnet 1 complete
8. R 602 Magnet 2 complete
9. R 602 Proportional chambers
0. R 602 Counters
1. R 602 Luminosity Telescope
2. R 602 Magnet Power Supplies
3. R 603 Hodoscopes  $H_1, H_2$
4. R 603 Hodoscopes  $H_3, H_4$
5. R 603 Spark Chambers
6. 2nd Generation Vacuum Chamber (R 602)

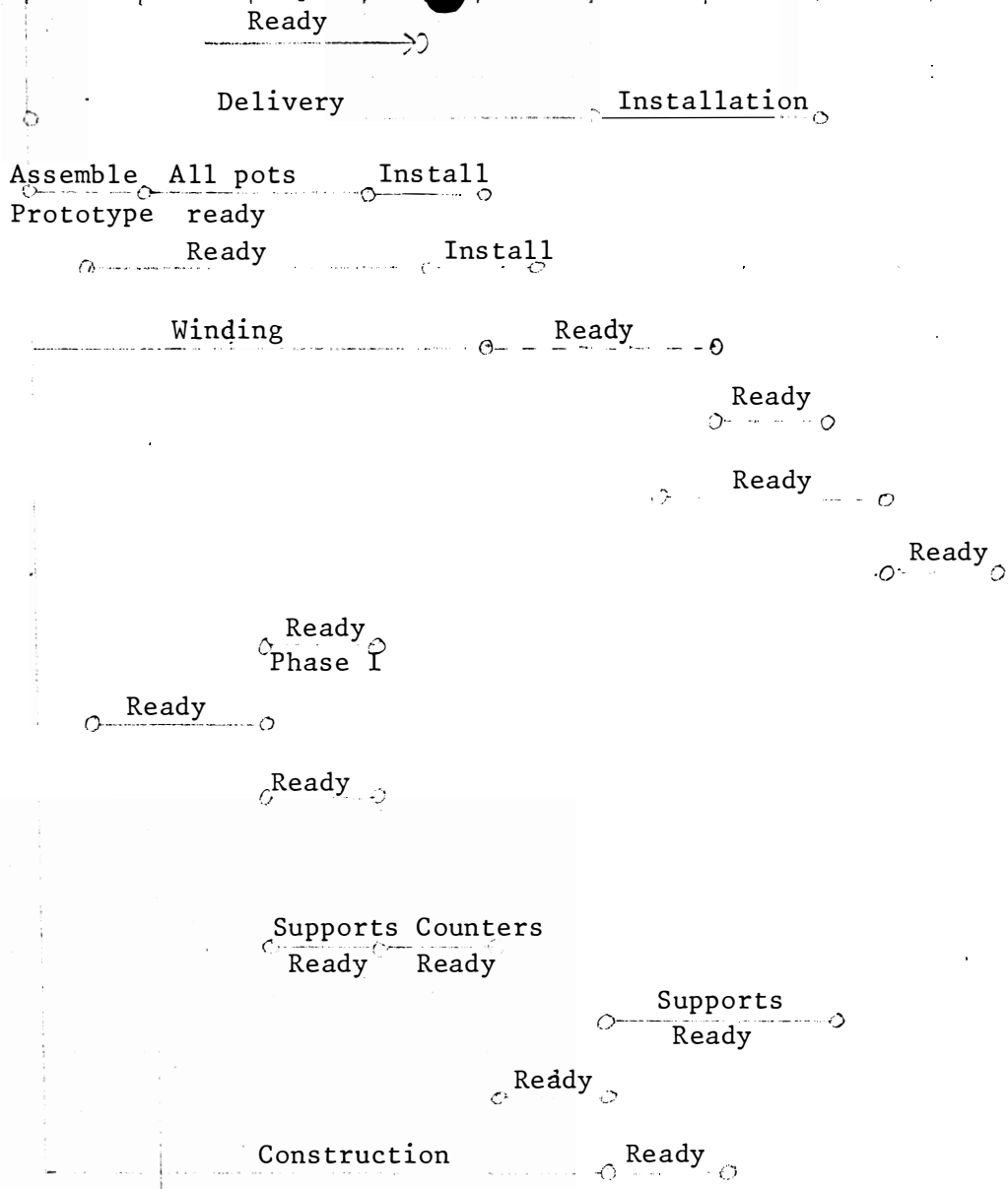

Table 6 - Draft Timetable for Experiments in I-6

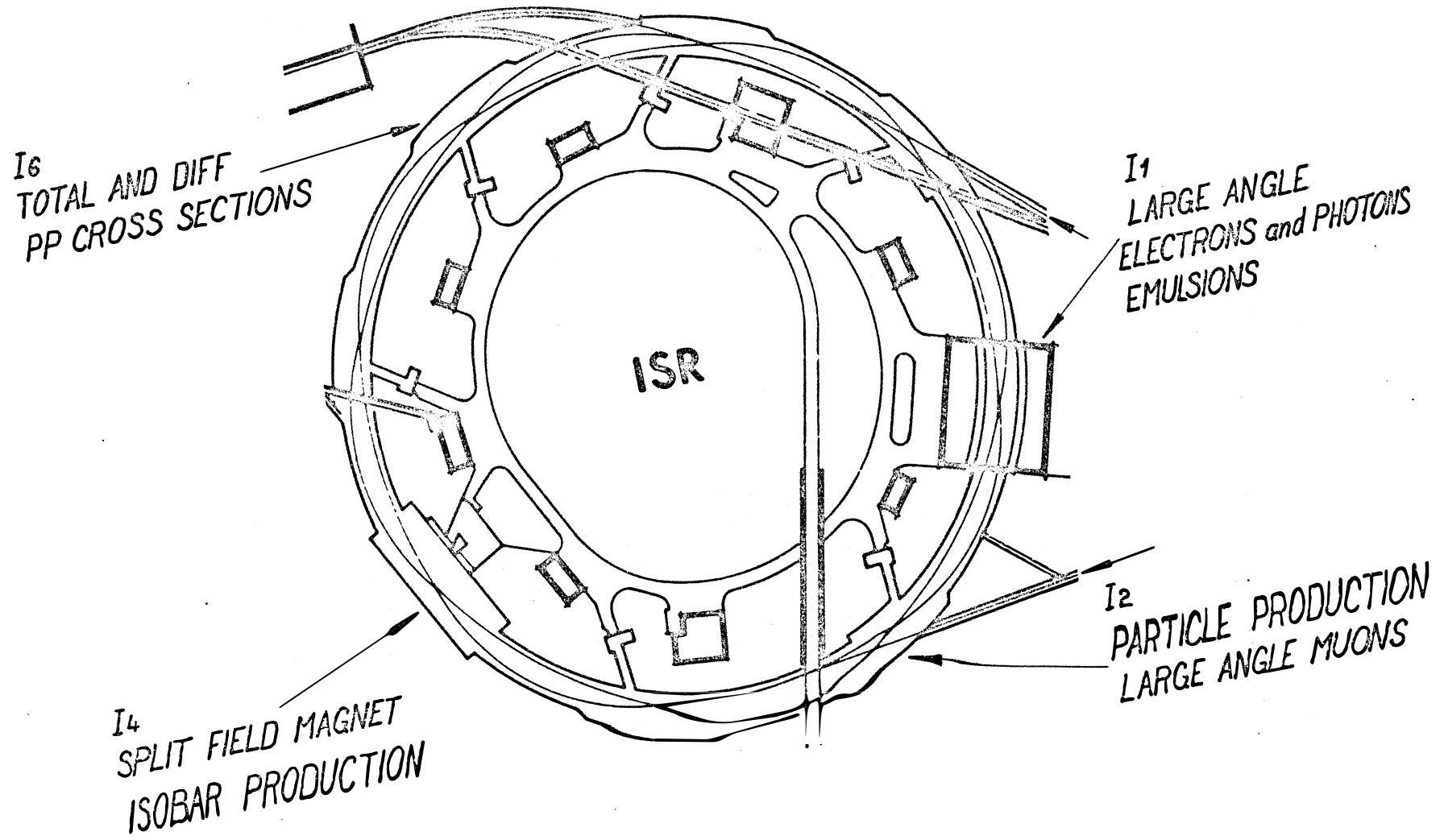
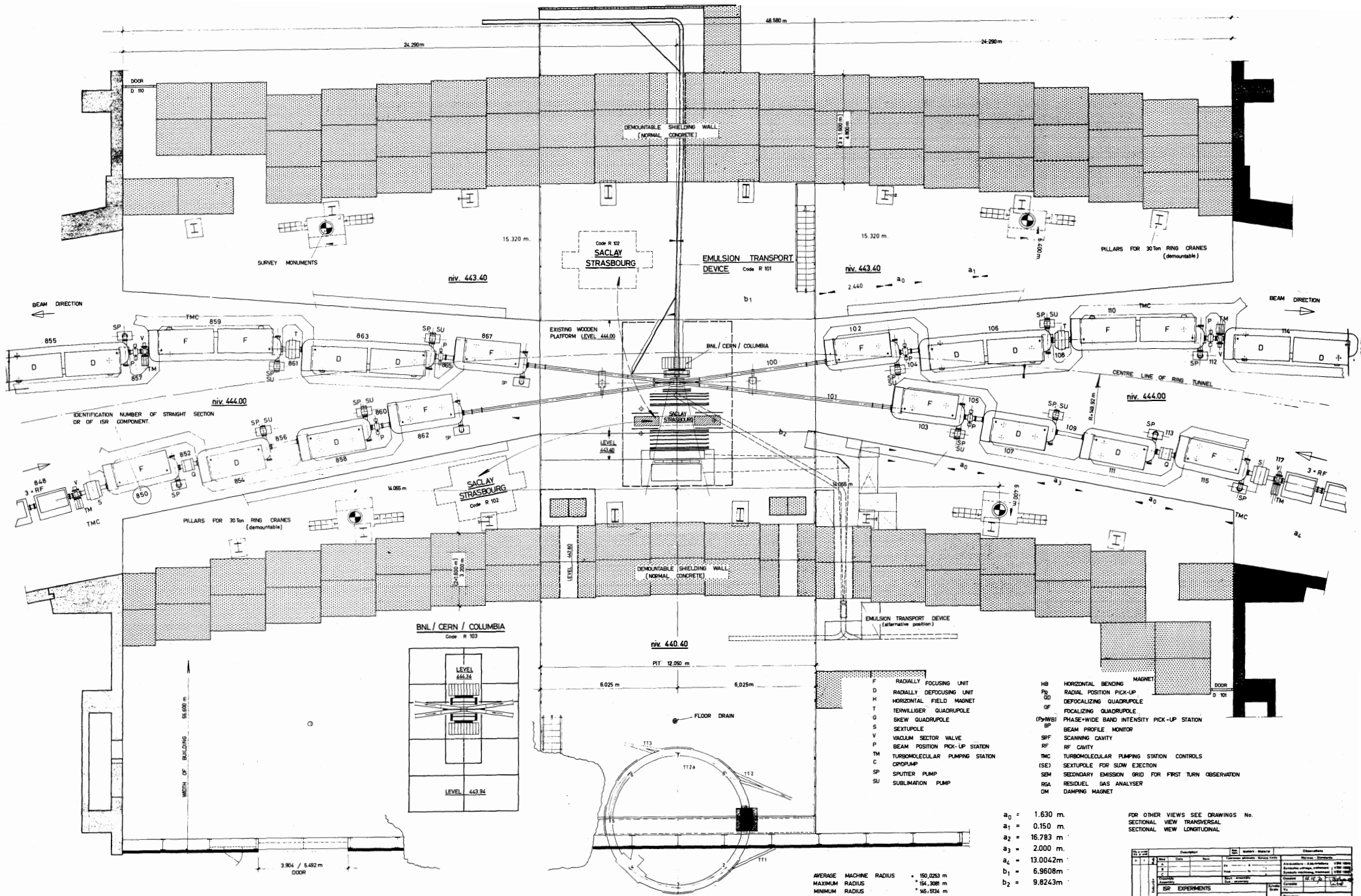

FIG. 1



AVERAGE MACHINE RADIUS = 150,023 m  
 MAXIMUM RADIUS = 154,308 m  
 MINIMUM RADIUS = 145,734 m  
 INTERSECTING RADIUS = 148,6151 m

$R_0 = 1.630$  m  
 $R_1 = 0.150$  m  
 $R_2 = 16.783$  m  
 $R_3 = 2.000$  m  
 $R_4 = 13.0042$  m  
 $d_1 = 6.9608$  m  
 $d_2 = 9.8243$  m

FOR OTHER VIEWS SEE DRAWINGS No.  
 SECTIONAL VIEW TRANSVERSAL  
 SECTIONAL VIEW LONGITUDINAL

Description		Code	Material	Comments
1	SP	SP	SP	SP
<b>INTERSECTION 1</b>				
DATA FOR IMPRESSING FOR THE REGIONAL PROJECTS				
SUPERVISOR: DIVISION FOR ISM (CERN)				
CERN CH-171 GENEVE 23 DIVISION ISM				260-247

Fig. 2

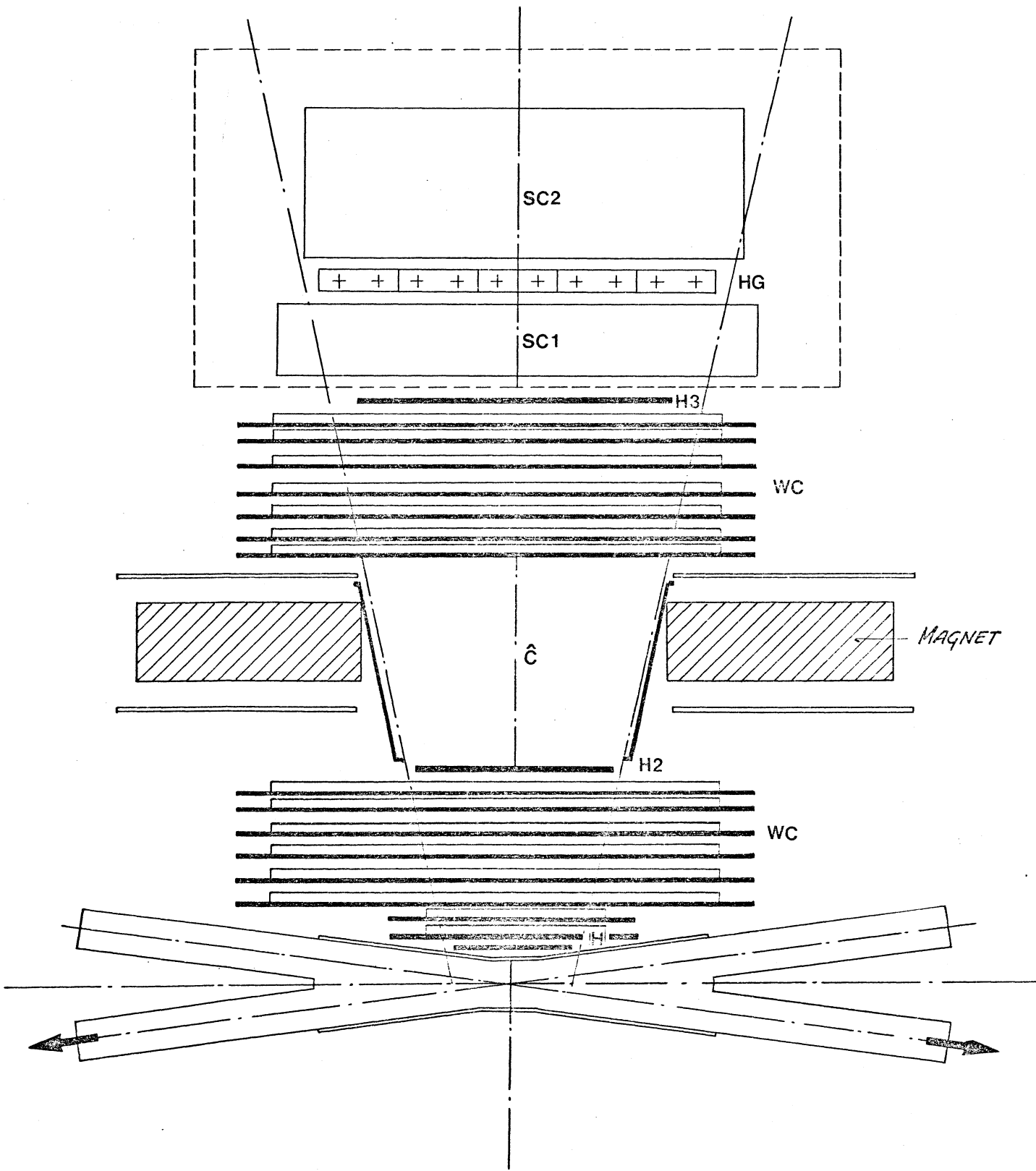

EXPERIMENT R 102

FIG. 3



# SEARCH FOR DILEPTONS

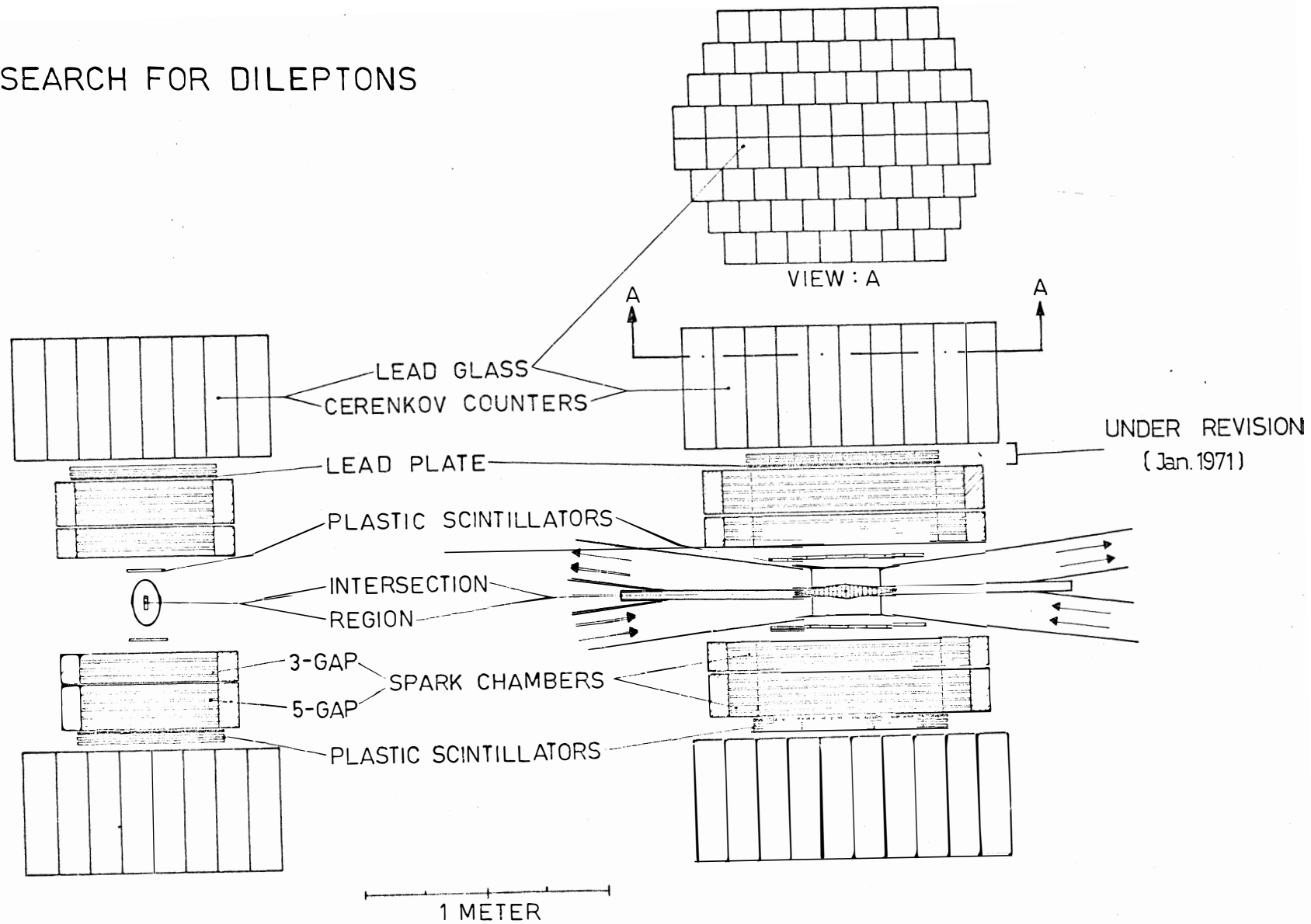

EXPERIMENT R 103  
FIG. 4

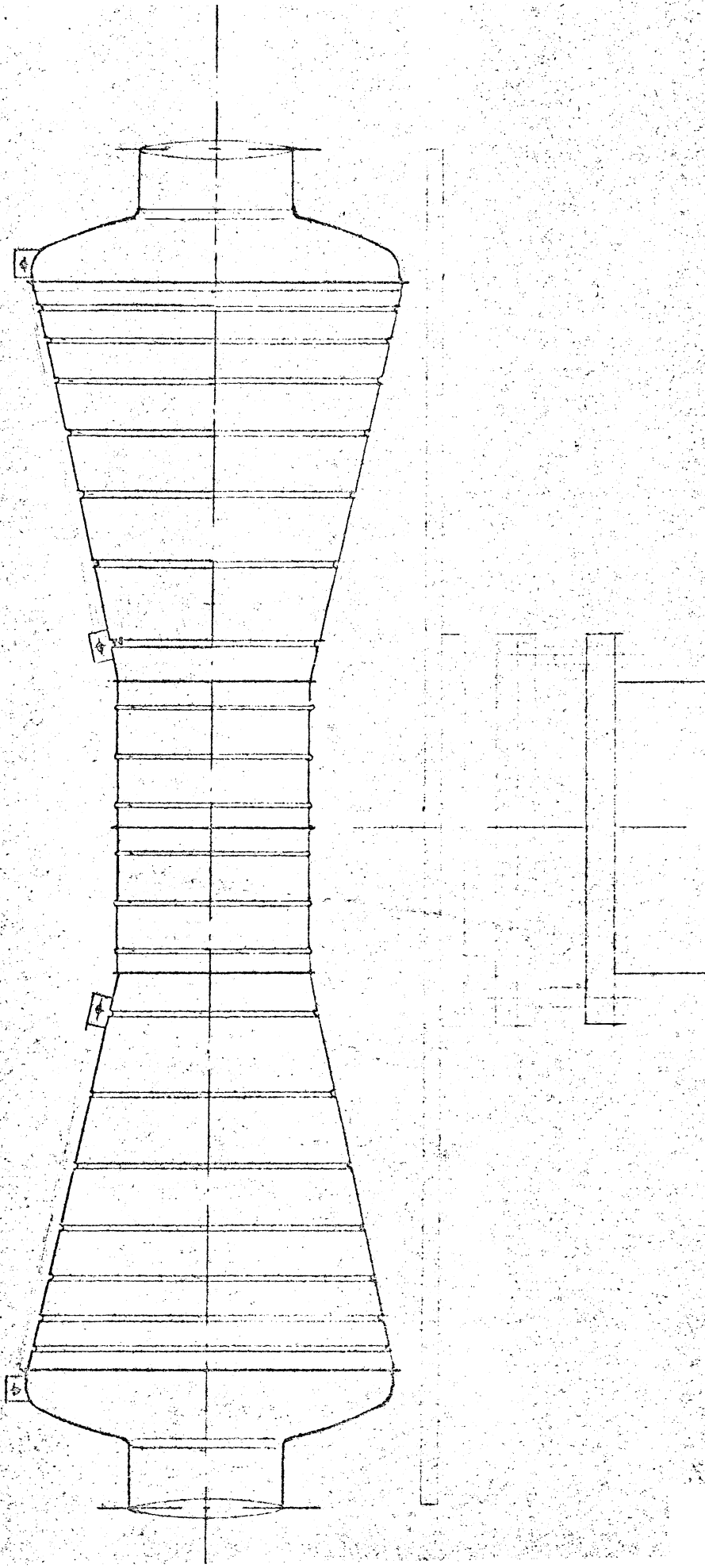

MODEL OF CORRUGATED CONE UNDER STUDY FOR  
I 1, I 2 AND I 6.

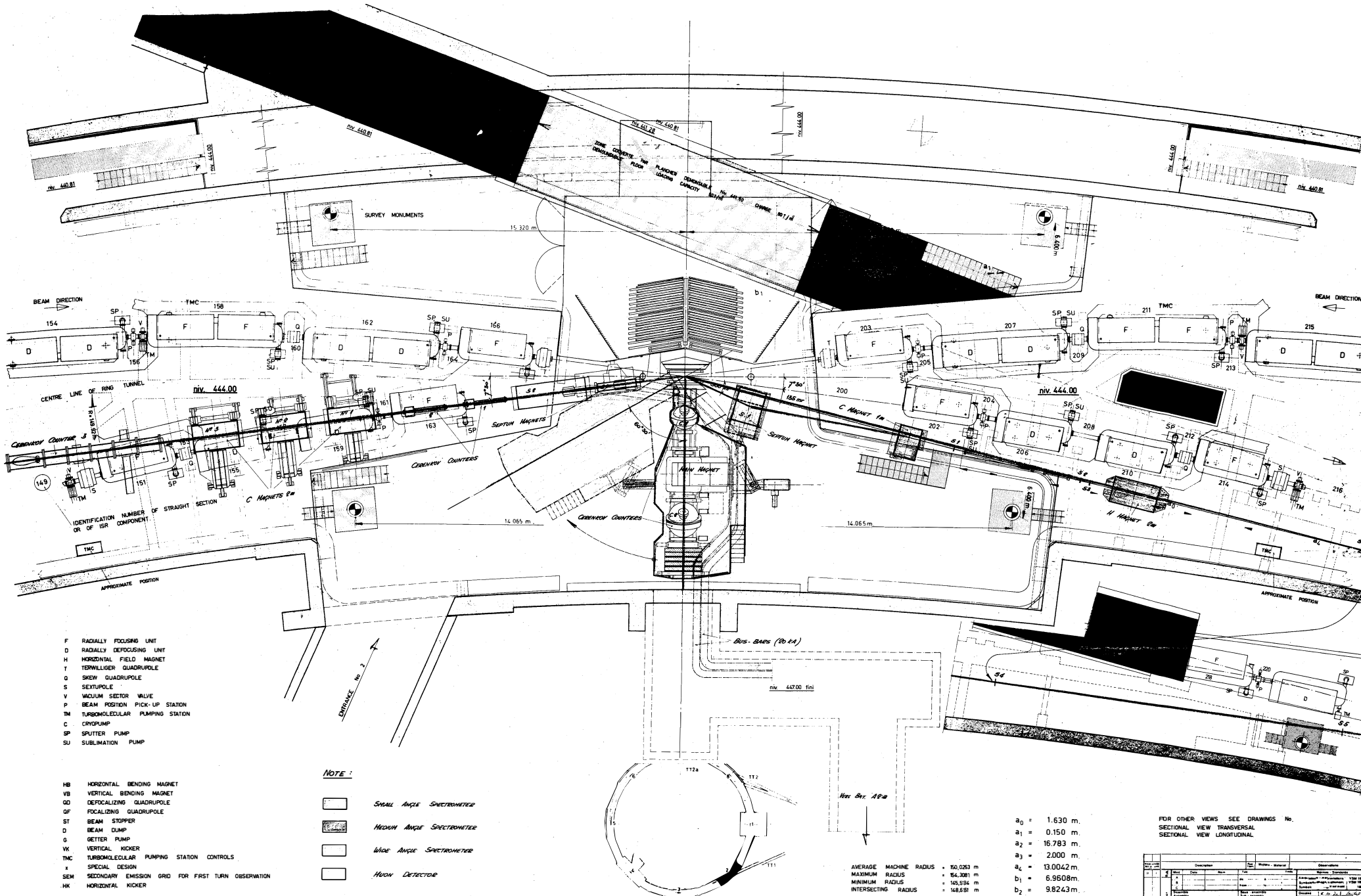
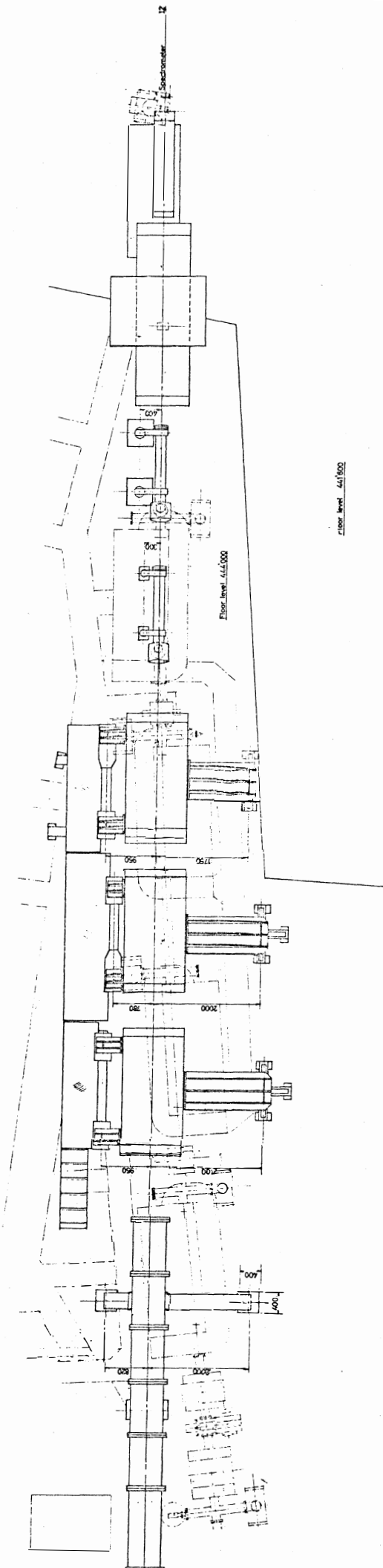
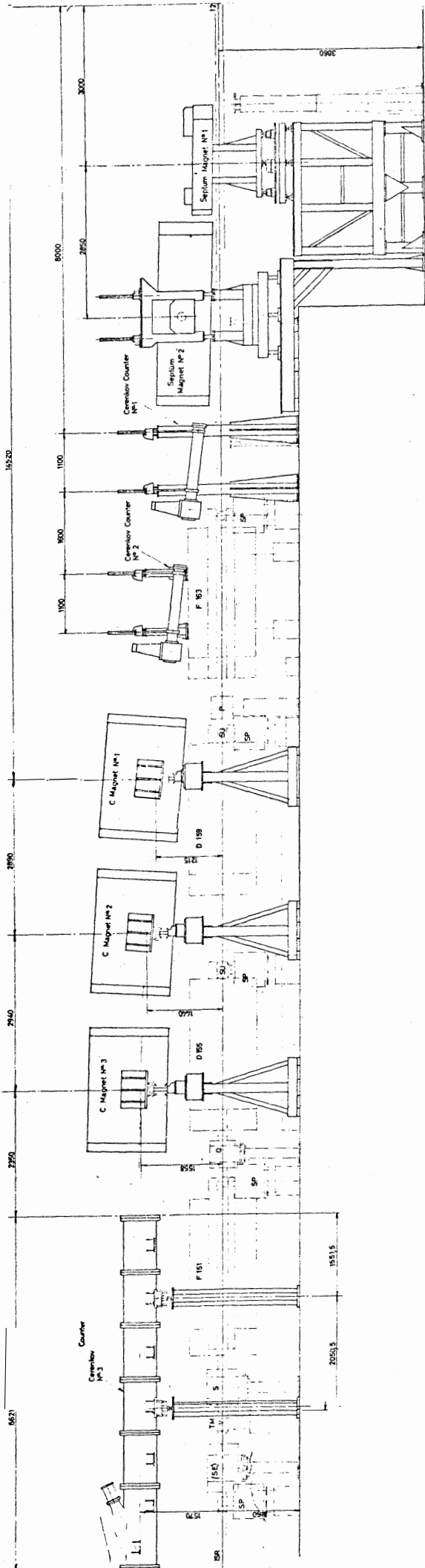

Fig. 6



Project No. 100-234	
Sheet No. 17	
Title: Layout	
Scale: 1/4" = 1'-0"	Date: 10/1/50
Author: J. H. ...	Checked: ...
Drawn: ...	Approved: ...

FIG. 7

NOT TO SCALE

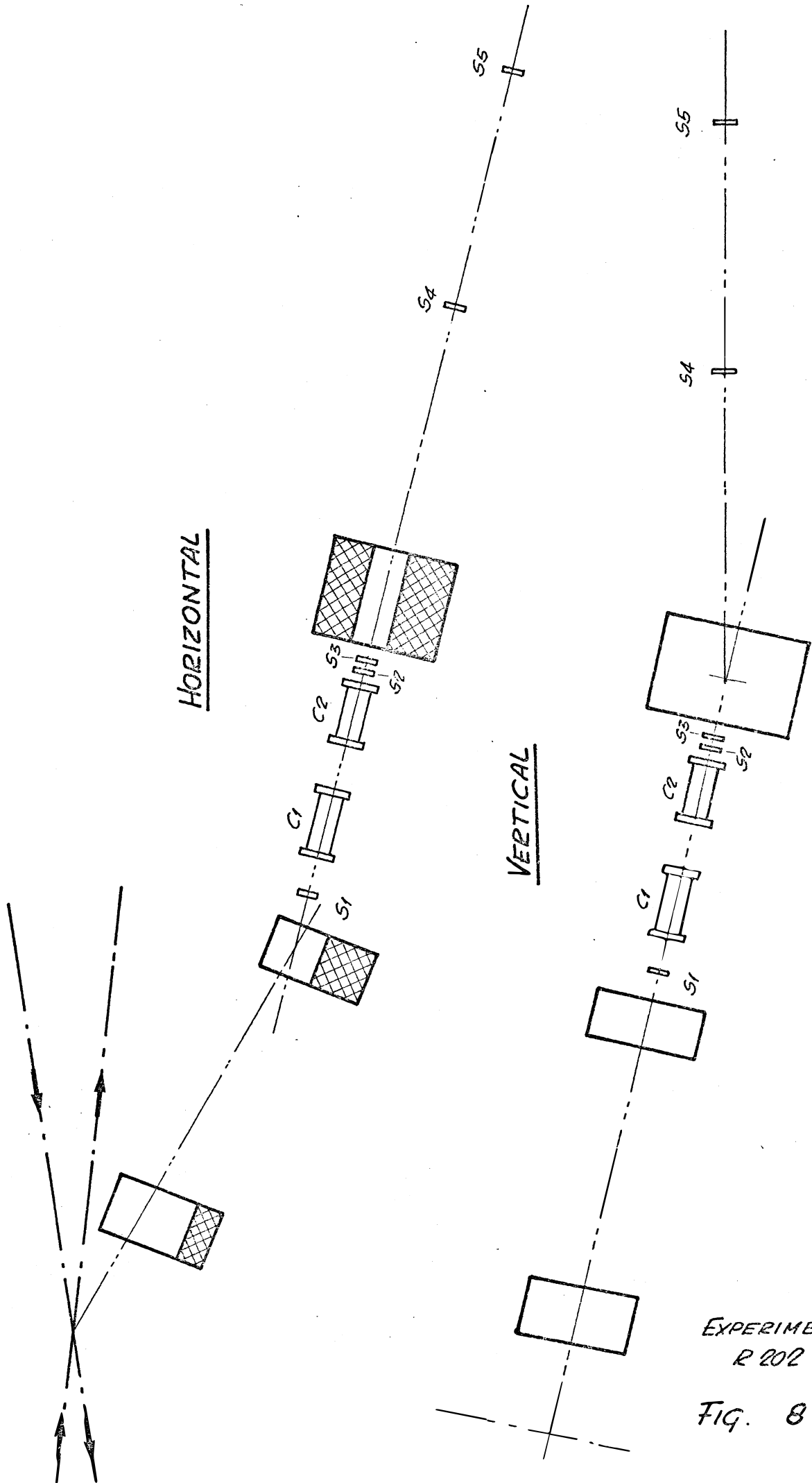

EXPERIMENT  
R 202

FIG. 8

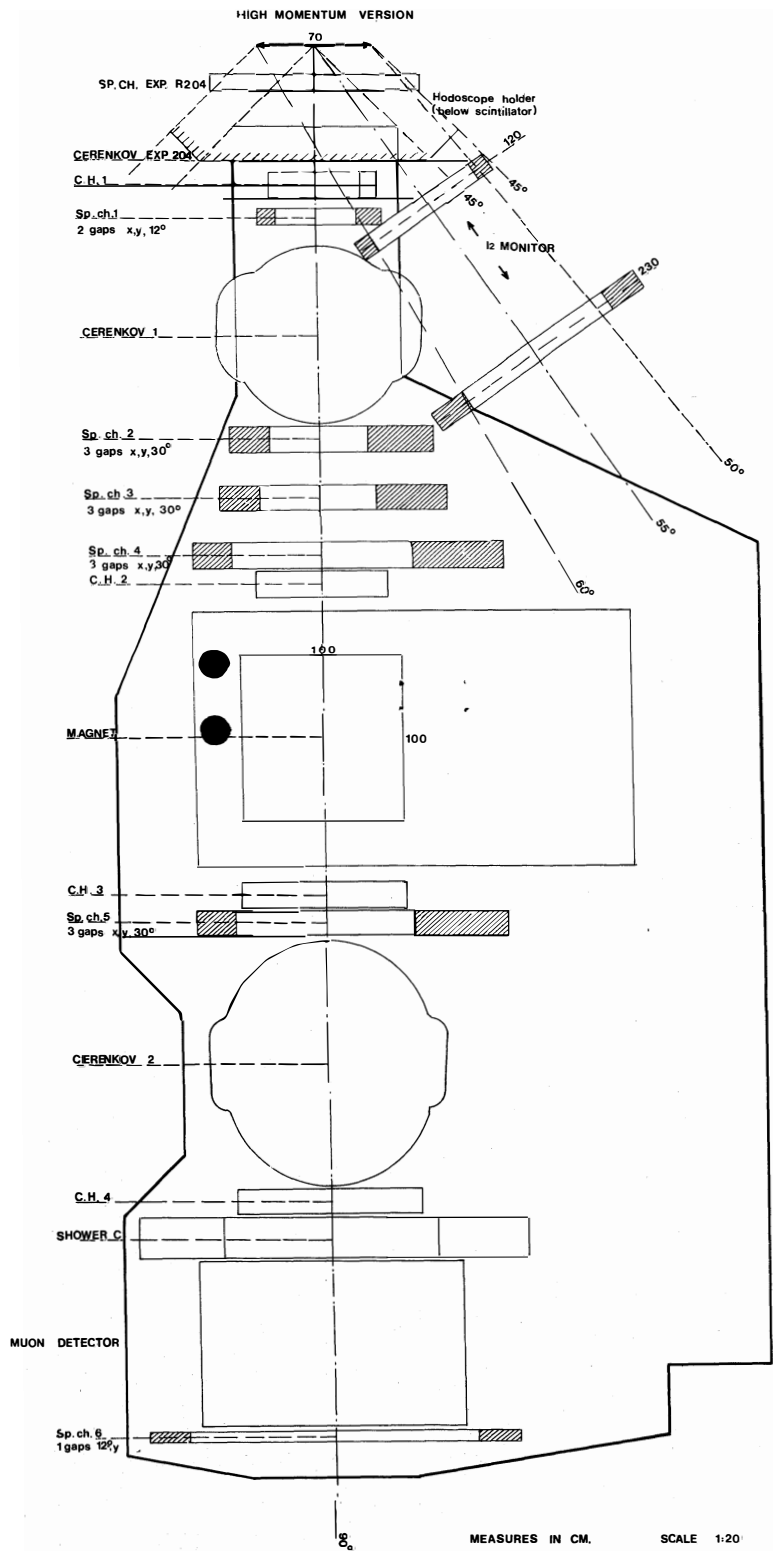
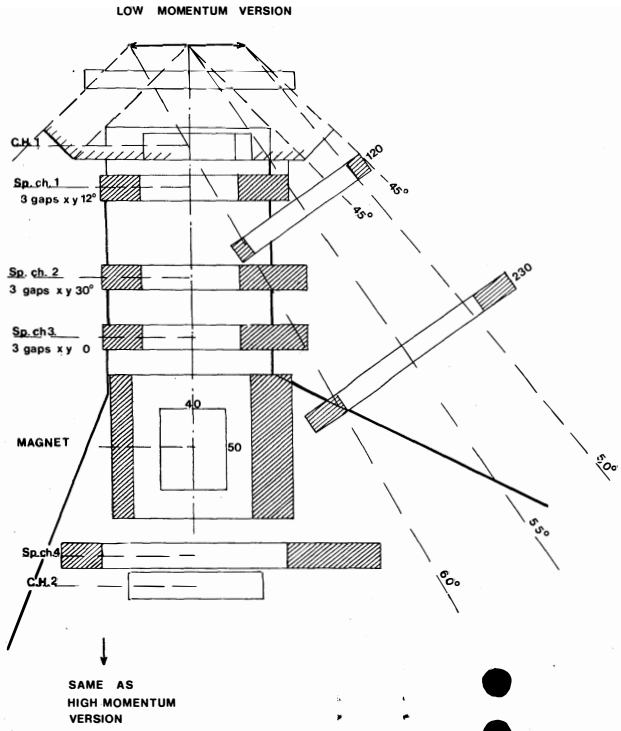
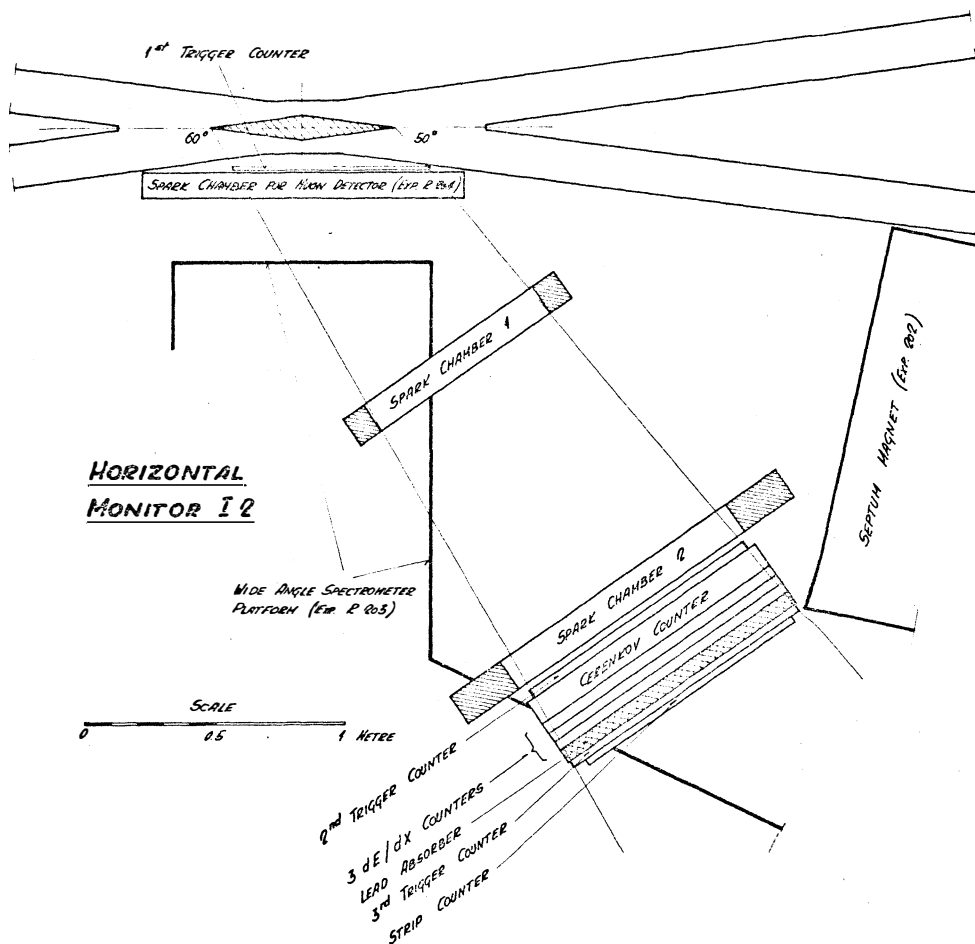

FIG. 9



**VERTICAL MONITOR I 2**

(VIEW ALONG BISECTOR)

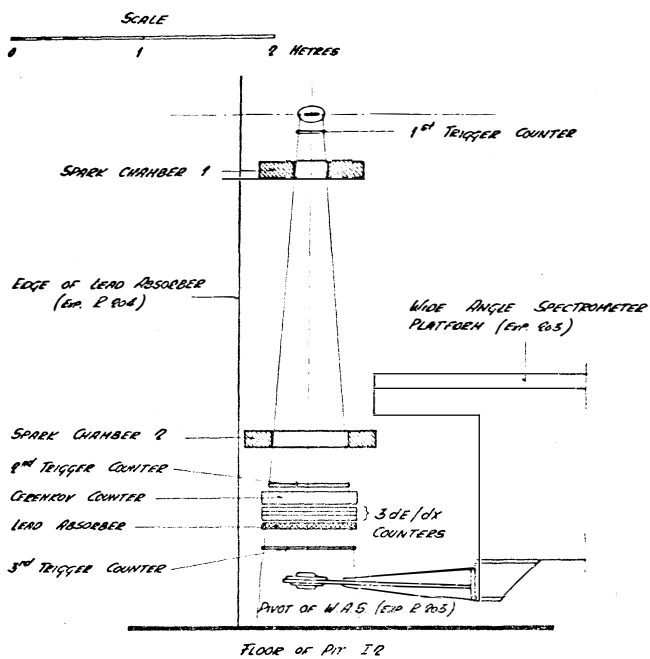
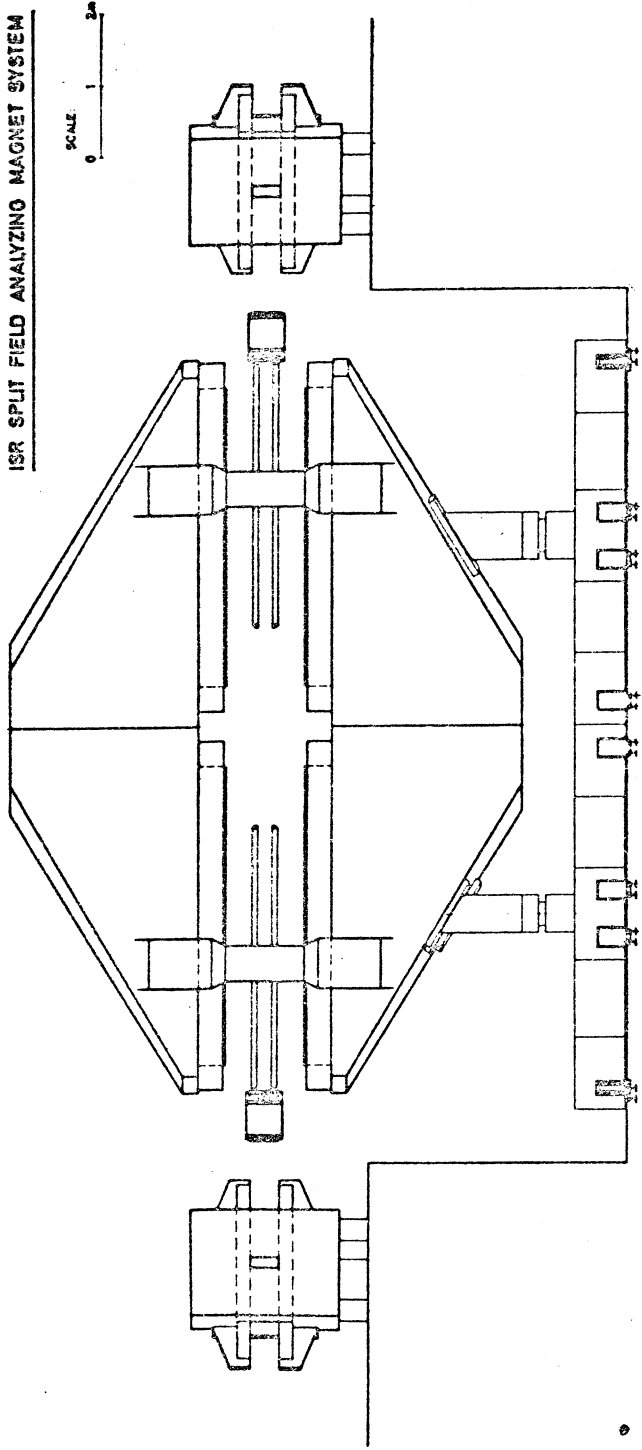

FIG. 10

ISR SPLIT FIELD ANALYZING MAGNET SYSTEM

SCALE  
0 1 2m



ISR MAGNET UNITS

COMPENSATORS

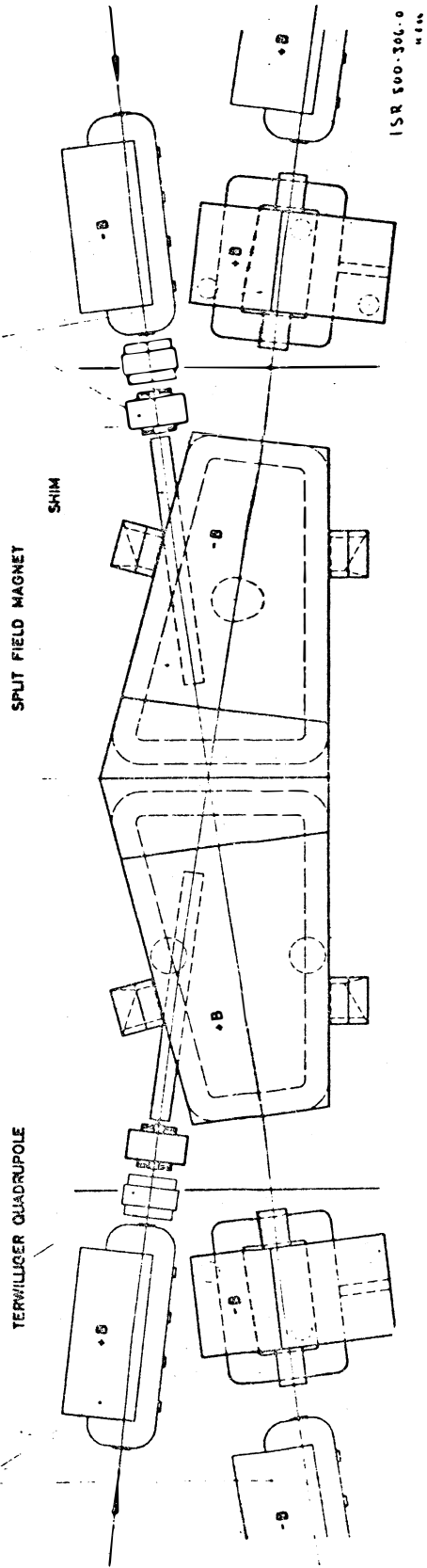

TERWILLIGER QUADRUPOLE

SPLIT FIELD MAGNET

SHIM

ISR 500-306.0  
M.I.M.

FIG. 11



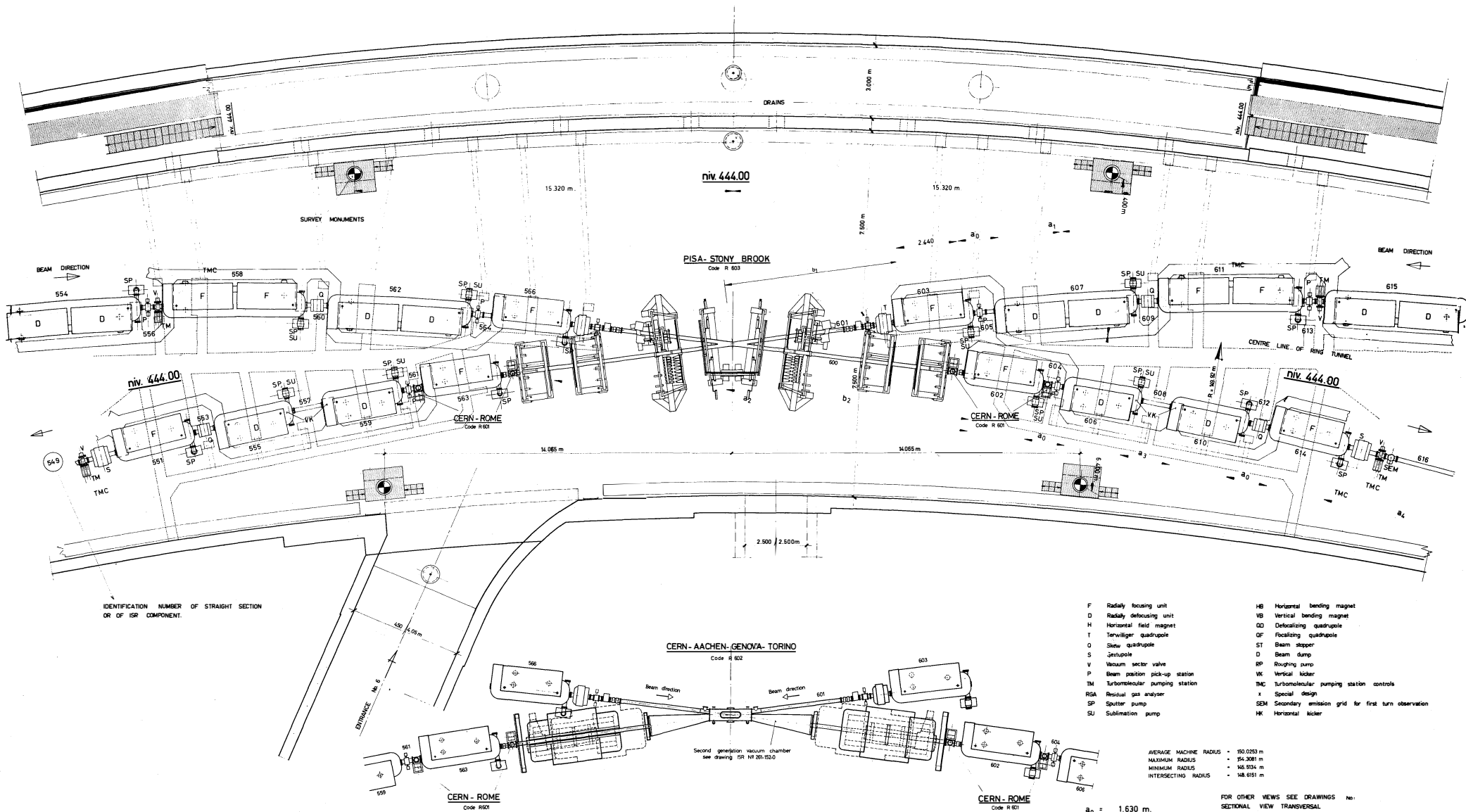

IDENTIFICATION NUMBER OF STRAIGHT SECTION OR OF ISR COMPONENT.

- F Radially focusing unit
- D Radially defocusing unit
- H Horizontal field magnet
- T Terwilliger quadrupole
- Q Skew quadrupole
- S Sextupole
- V Vacuum sector valve
- P Beam position pick-up station
- TM Turboturbomolecular pumping station
- RGA Residual gas analyser
- SP Sputter pump
- SU Sublimation pump
- H8 Horizontal bending magnet
- V8 Vertical bending magnet
- QD Defocalizing quadrupole
- QF Focalizing quadrupole
- ST Beam stopper
- D Beam dump
- RP Roughing pump
- VK Vertical kicker
- TMC Turboturbomolecular pumping station controls
- x Special design
- SEM Secondary emission grid for first turn observation
- HK Horizontal kicker

AVERAGE MACHINE RADIUS = 150.0253 m  
 MAXIMUM RADIUS = 154.3061 m  
 MINIMUM RADIUS = 145.9534 m  
 INTERSECTING RADIUS = 148.6151 m

- a<sub>0</sub> = 1.630 m.
- a<sub>1</sub> = 0.150 m.
- a<sub>2</sub> = 15.783 m.
- a<sub>3</sub> = 2.000 m.
- a<sub>4</sub> = 13.0042m.
- b<sub>1</sub> = 6.9608m.
- b<sub>2</sub> = 9.8243m.

FOR OTHER VIEWS SEE DRAWINGS NO.  
 SECTIONAL VIEW TRANSVERSAL  
 SECTIONAL VIEW LONGITUDINAL

Rev.	Chg.	Description	By	Checked	Date	Remarks
1		ISR EXPERIMENTS				
<b>INTERSECTION 6</b>						
<small>PROJEZIONE TRASPARENTE FINE LA SECONDA SEZIONE          SUPERIOR DIRECTION FOR NUCLEAR RESEARCH          CERN CH-1211 GENEVE 23 DIVISION ISR</small>						
						260-251

Fig. 10

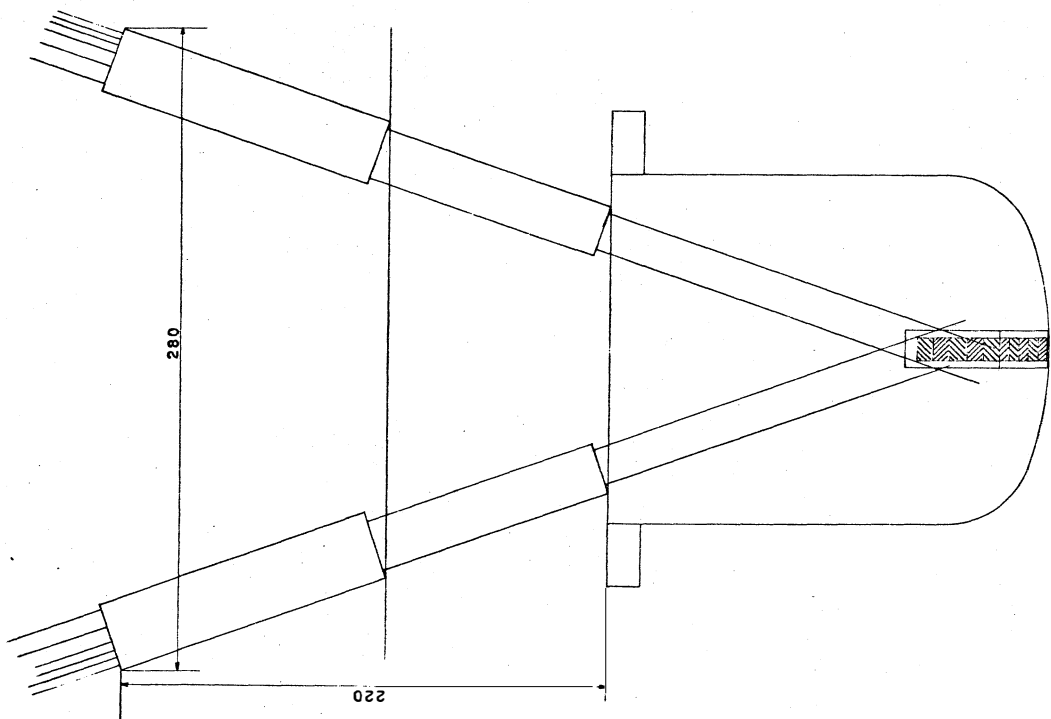
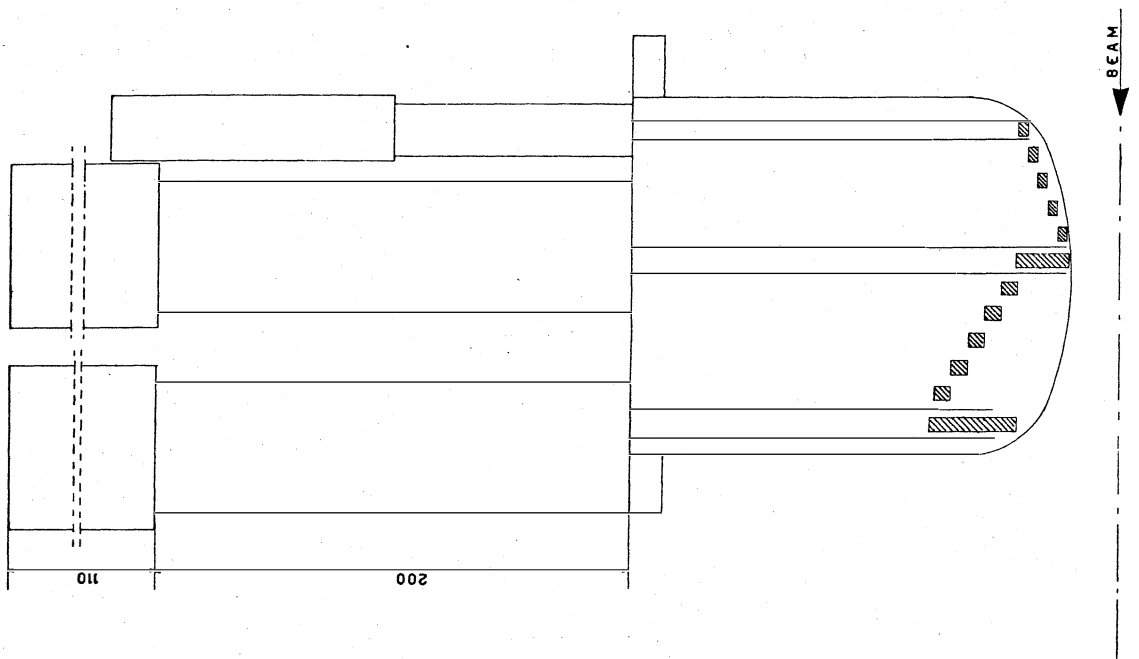

DETAIL OF  
EXPERIMENT R 601

FIG. 13

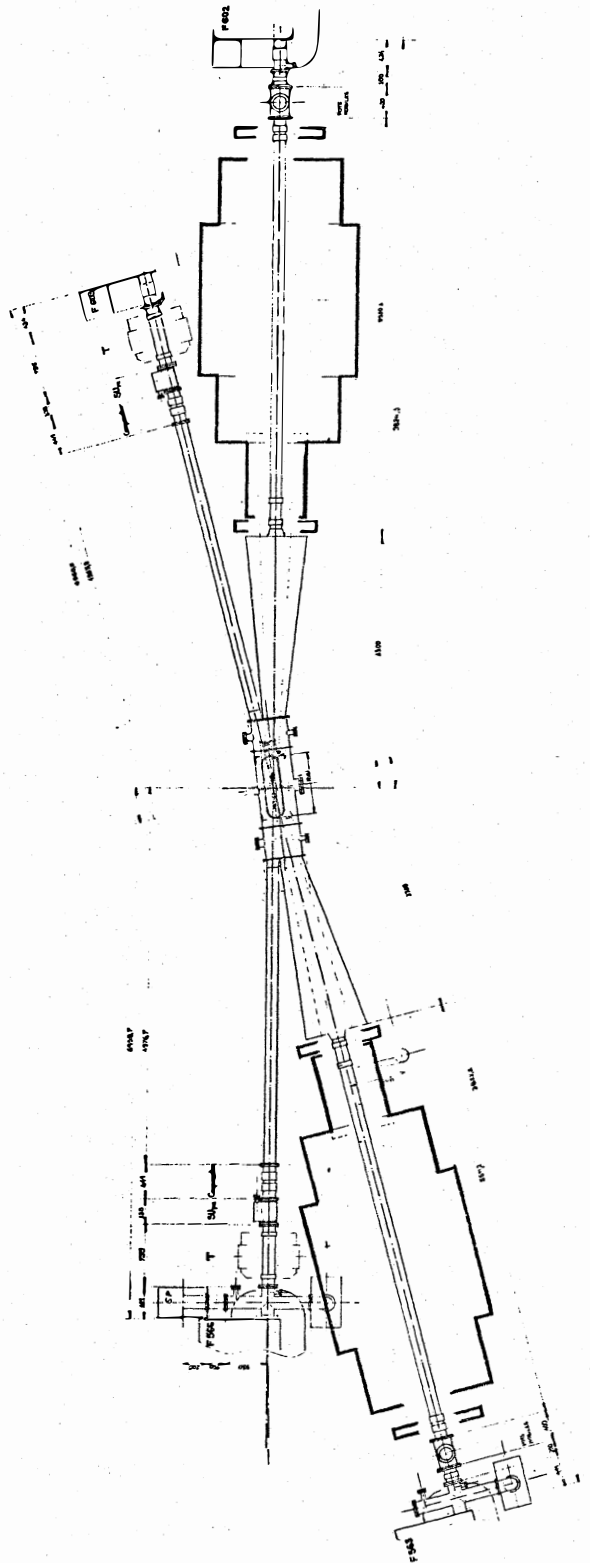
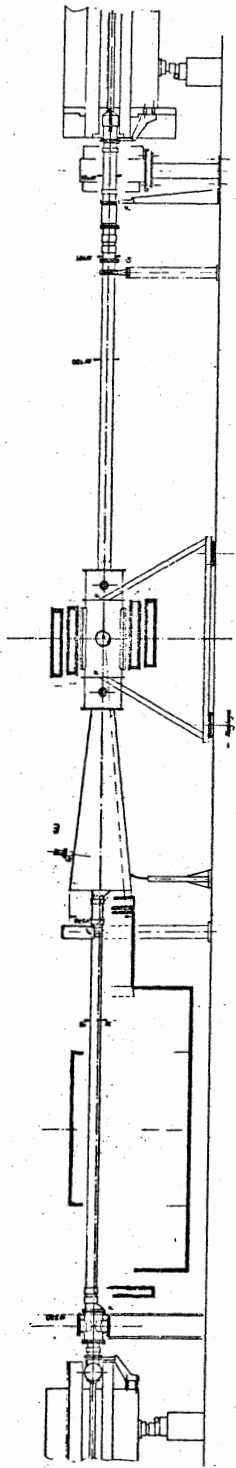
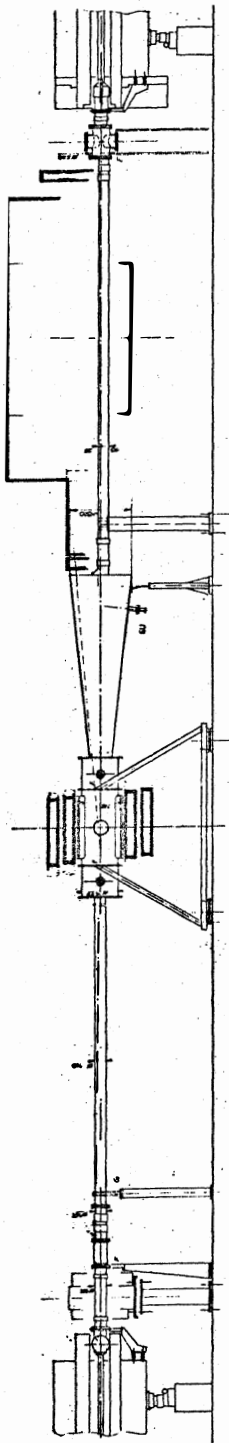

EXPERIMENT R 602

FIG. 14