

FAMSI © 2005:
Mary Pohl

OLMEC CIVILIZATION AT SAN ANDRES, TABASCO, MEXICO

With contributions by: Christopher von Nagy (Ceramics section), Desert Research Institute; Allison Perrett (Prestige artifact section), University of South Florida; and Kevin Pope, Geo Eco Arc Research.

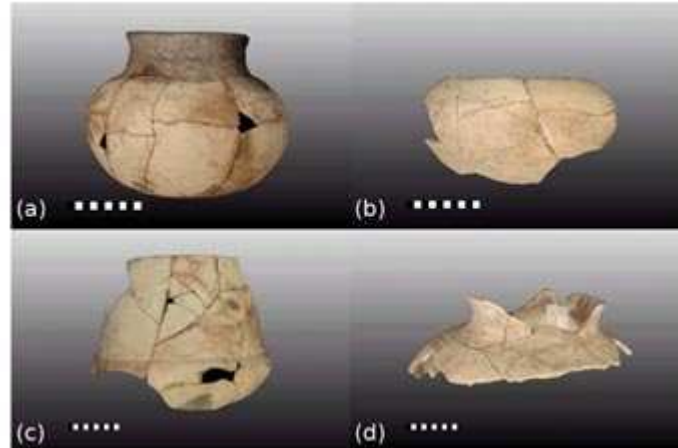

Research Year: 2002
Culture: Olmec
Chronology: Pre-Classic
Location: La Venta, Tabasco, México
Site: San Andrés

Table of Contents

[Abstract](#)
[Resumen](#)
[Introduction](#)
[San Andrés Ceramics](#)
[Chronology of occupation](#)
 [Molina Phase](#)
 [Early Puente Phase](#)
 [Late Puente Phase](#)
 [Early Franco Phase](#)
 [Late Franco Phase](#)
[Ceramics of Ritual and Presentation](#)
 [Ritual Beverage Consumption](#)
 [Didactic miniatures](#)
 [Maya and Chiapan Ceramic Imports](#)

[Greenstone artifacts](#)

[The Social Significance of the San Andrés Prestige Goods](#)

[The La Venta-San Andrés Prestige Artifact Comparison-An Overview](#)

[Olmec Writing](#)

[Conclusion](#)

[Acknowledgments](#)

[List of Figures](#)

[List of Tables](#)

[Sources Cited](#)

Submitted 09/16/2004 by:

Dr. Mary Pohl

Florida State University

mpohl@mailers.fsu.edu

Dr. Christopher von Nagy

Desert Research Institute

cvn@olmec.reno.nv.us

Dr. Kevin Pope

Geo Eco Arc Research

kpope@starband.net

Abstract

The site of San Andrés (Barí 1), located 5 km northeast of the Olmec center of La Venta in Tabasco, Mexico, provides information on a major Middle Formative period polity from the vantage point of a secondary elite site. San Andrés yielded stratified household deposits and undisturbed ritual feasting middens that provide new data on Olmec activities beyond the major center. The Foundation for the Advancement of Mesoamerican Studies, Inc. provided funding for the study of the Olmec artifacts from San Andrés. This report focuses on the ceramic analysis, which was facilitated by the well-stratified deposits, and on the prestige artifacts, including the evidence for early Olmec writing on greenstone plaques and a ceramic roller stamp.

Resumen

El sitio San Andrés (Barí 1), ubicado 5 km al noroeste del centro olmeca La Venta en Tabasco, México, está proviendo información sobre un cacicazgo mayor del Formativo mediano desde la punta de vista de un sitio de alto rango secundario. En San Andrés se encontró desperdicios caseros estratificados y basureros de comidas rituales poco alterados los cuales dan nuevos datos sobre actividades olmecas afuera de un centro mayor. La Fundación para el Advance de Estudios Mesoamericanos suministro los fondos necesarios para el estudio

de los artefactos olmecas provenientes de San Andrés. Este informe se enfoca en el análisis de la cerámica facilitada por depósitos bien estratificados y en los artefactos de prestigio, incluso evidencia de escritura olmeca temprana sobre placas de piedra verde y un rollo sellador de cerámica.

Introduction

La Venta was at the center of a complex polity that had significant influence on Mesoamerican cultural development in the Middle Formative period. Our excavations at San Andrés ([Figures 1, 2 and 3](#)), a subsidiary elite center, have yielded important new information on political, economic, and social relations within the polity. We sampled well-stratified, undisturbed deposits that have provided the basis for the refinement of the ceramic sequence of the area. The refined ceramic sequence, together with radiocarbon dating on the abundant organic materials, provides good chronological control for the artifacts recovered.

In Formative period Mesoamerica, high-status goods were significant components of cultural practice and a source of social, political, and ideological power. Centralized control over systems of elite good acquisition, production, distribution, and consumption provided the means to structure relationships, compete for prestige, and define ideological conceptions of social order. A study of prestige artifacts and ceramics from the site of San Andrés elucidates the role of prestige objects within the context of a subsidiary, residential site and within the framework of a patron-client relationship with La Venta. At San Andrés, high-status goods were embedded in social and ritual practices that mimicked patterns of prestige good consumption modeled by the La Venta elite. Prestige objects communicated the ruling ideology and maintained the structure of power, validating San Andrés' sociopolitical position within the polity hierarchy. Nevertheless, the exact nature of economic and political relationships is less clear. Differences in quality and quantity of elite status markers suggest that residents of San Andrés maintained power through the manipulation of a culturally defined subset of the kingly symbolism of sacred power manifest at the mother center.

San Andrés Ceramics

We briefly review the ceramic chronology of the San Andrés occupation then turn to discuss evidence of elite rituality and marking of power in the Early Formative phase occupation at San Andrés. Data from San Andrés allow the refinement of several components of the regional Middle Preclassic chronosequence (von Nagy 2003; von Nagy *et al.* 1998; von Nagy *et al.* 2000, 2002). Our data set is derived from eight excavation units at San Andrés ([Figure 7, 6, 8 and 9](#)). A wide variety of depositional features were sampled, including large midden deposits, sometimes associated with high volume pits, ancient sherd pavements and trash-filled storage pits and hearths, as well as floor and foundation fill, providing an exceptional sample of late Early through Middle Preclassic Grijalva delta Olmec material culture. Despite a variety of cultural and natural pre- and post-deposition

processes, including minor to intense reburning of vessel fragments by the ancient inhabitants of San Andrés, redeposition and breakage cycles related to floor construction, post-depositional *in-situ* mechanical weathering, chemical reduction of iron compounds in pottery slip and paste surface, iron staining of sherd surfaces under other circumstances, and soil flux of dissolved CaCO₃ derived from shell middens with precipitation on sherd surfaces in neighboring strata, artifactual preservation was generally good in an area where post-depositional diagenic processes can wreck havoc on, especially, ceramic artifacts. All artifacts were wet sieved allowing for gentler recovery and a higher rate of surface retention on pottery sherds. Once initially cleaned, we made extensive attempts to reconstruct smashed vessels (several are shown in [Figure 10](#)) as part of the development of an extensive catalog of vessel form and form variation.

Chronology of occupation

San Andrés is a multi-component site with one major and two minor occupations and long intervening hiatuses. The local sequence provides evidence for a series of five well-represented archaeological phases (see [Figures 4 and 5](#)). Four of these, the Early and Late Puente and Early and Late Franco, are associated with the primary Olmec occupation following the formation of the Barí paleodistributary. These follow a hiatus of occupation at the locality and an earlier fifth phase, a local manifestation of the regional Molina Phase. A still earlier Archaic period phase, which we term the Estero, is associated with solid palynological and macro-botanical evidence but equivocal artifactual evidence. Although we recovered a handful of sherds in very deep levels, we consider evidence for this pottery tradition likely the result of bioturbation. Finally, the locality saw repeated, low intensity occupations from the Late Classic through into the Early Colonial period.

Molina Phase: The earliest evidence for occupation at San Andrés is associated with a margin of an ancient pre-Barí estuary with scatters of sherds of the regional Molina complex, some of which we show in [Figures 11 and 12](#) and summarize [Table 1](#). These include plain and black-slipped tecomates and black and differentially fired serving dishes and bowls, some tempered with volcanic ash imported from the Mt. Chichón volcanic complex miles to the southeast. Current radiocarbon evidence places San Andrés Molina phase materials at roughly 1400–1200 cal B.C. During this time, the San Andrés locality was characterized by an intermittent pattern of estuary margin occupation.

Early Puente Phase: We date the Early Puente phase at San Andrés to between ca 900 and 800 cal B.C. Nacaste-like Early Puente phase pottery probably first occurs in the area around 950 cal B.C. (von Nagy 2003: 804). Pottery from the lowest levels of test pits on and nearby the Stirling Platform at La Venta (Hallinan *et al.* 1968) fits well in the Early Puente phase, although some examples fit better in the slightly later Late Puente phase. Calibrated radiocarbon

dates and high frequencies of tecomates in lower levels of Squier's (1964: UCLA-1276a) Pit C also align with the Early Puente phase, as do various calibrated radiocarbon dates from Phase I construction fill at La Venta.

[Figure 13](#) illustrates characteristic form and decorative modes and [Figure 14](#) illustrates common Early Puente phase types. [Table 2](#) summarizes sherd count and minimum number of vessel data from a characteristic levee sediment Early Puente assemblage. Typical pottery includes fine sand-tempered black and differentially fired serving dishes with flat bases and flared walls, some with exterior thickened rims, and deep bowl-like basins with thick everted rims and exterior groove incision similar to Nacaste Phase Tacamichapa Hard forms at San Lorenzo. Food preparation and storage focused on bossed and exterior scored tecomates, the latter more similar to examples from San Isidro than to the ubiquitous exterior scored tecomates of other nearby sites within the Grijalva delta and the Coatzacoalcos river area. Decorative modes are limited to circumferential lines with occasional line breaks at the rim of dishes and tecomates, sub-parallel groove-incision on the exterior of tecomates and basins, and exterior geometric groove incision at the base of dishes. White-slipped dishes are present but uncommon.

Late Puente Phase: The rather sparse Early Puente phase occupation underlies a 350-year long intensive occupation. Ceramic collections from San Andrés allowed the definition of a Late Puente phase and associated ceramic complex, dated to between 800 and 700 cal B.C., on the basis of a switch to short and tall-necked cooking *ollas* (see examples in [Figure 19](#)), a much wider range of vessel forms, a high frequency of restricted bowls and a very high frequency of volcanic ash-tempered pastes in the levels overlying Early Puente phase deposits. [Figure 15](#) shows characteristic Late Puente phase forms, and [Table 3](#) summarizes type and form data from a Late Puente phase midden sampled in Unit 3. Late Puente phase radiocarbon dates partially align with dates associated with Phase II construction at La Venta. A significant number of flat-based, flared-wall serving dishes are decorated with star-like incised motifs on interior bases, a decorative mode characteristic of initial Middle Preclassic pottery complexes such as the Manantial of the Basin of Mexico (Niederberger 1987).

Early Franco Phase: The Franco complex was originally defined on the basis of the appearance of plain and incised composite-silhouette plates (Sisson 1970), also characteristic of Palangana and Conchas phase collections elsewhere in the greater Isthmusian region. Significant distinctions between assemblages recovered from well-defined stratigraphic contexts allowed for our division of the Franco into two phases. Both phases are characterized by flat-based, flared-wall dish forms, composite-silhouette plates and by a wide range of other vessel forms, decorative modes and new types. Many of these are associated with San Andrés' distinct economic position manifest in the substantial finely made portion of the assemblage that suggest the development of specialized, workshop ceramic manufactories in the polity. Early Franco phase deposits at San Andrés represent the bulk of the excavated sample and are reflective of an elite

community engaged in a wide range of activities. Similarly, Early and Late Franco pottery represents the bulk of material recovered at La Venta associated with Phases III and IV there. Several Phase III offerings excavated by Drucker *et al.* (1959) contained pottery types and vessel forms that would easily be at home in Early Franco phase San Andrés collections. Ceramics recovered by González Lauck (1990) in the B Complex have tight parallels with Early and Late Franco pottery from San Andrés. [Figures 16, 17, 18, 19, 20, 21 and 23](#) illustrate an array of forms, decorative modes and specialized vessels. [Figure 22](#) illustrates common types. [Table 4](#) summarizes type and vessel form data from a single deposition unit at San Andrés, a pavement of intensely reburned pottery sherds sectioned in Units 7 and 8 on the northern margin of the site. Radiocarbon evidence places Early Franco deposits in the late seventh or early sixth century cal B.C., and although the precise chronological boundaries remain to be worked out, We estimate a range of 700/650–550 B.C. for the phase.

Late Franco Phase: Late Puente and Early Franco phase middens and trash pits are overlain by deposits with ceramics of the Late Franco phase ([Figure 28](#)). A good deal of this material was recovered from fill, but some trash-filled pits provided relatively unmixed samples. [Table 5](#) summarizes data from pit 3a in Unit 1. We currently estimate a range of 500–400/350 for the Late Franco Complex at San Andrés and, more generally, within the La Venta polity. The abandonment of San Andrés by 400/350 B.C. is consistent with Rebecca González Lauck's (1997) placement of the functional end of La Venta's monumental core by around 400 B.C. and the apparent collapse of settlement in large portions of the western Grijalva delta at around that time (von Nagy 2003).

Late Franco phase ceramics are differentiated from Early Franco phase ceramics on the basis of an increasing switch to composite-silhouette plates ([Figure 28l–n](#)), the presence of saddle-rimmed or cuspidor-like bowls ([Figure 28g–k](#)), the appearance of flat-based, slightly convex vases and bowls, outcurved rim vases, and the presence of dishes with widely flared, modeled rims. Decorative changes include a shift away from rim parallel circumferential lines, employment of exterior vertical flutes and broad grooves, and modifications of existing cannons of design composition. Serving vessels remain predominantly black or differentially fired, although differential firing tends to be more mottled than earlier. There is a notable shift from the Early Franco phase (and earlier) use of sharp, angular coarse silt-sized volcanic ash temper (producing a raspy textured paste) to a less tempered to temper-free fine paste recipe (producing sherds with a marked talcy texture).

Ceramics of Ritual and Presentation

Ritual Beverage Consumption: Of particular interest are a series of Early Franco phase vessels sealed with lime sizing on the interior. These vessels occur in two forms: a coarse paste, heavy walled, flat-based *cantaro* and a volcanic ash-tempered, differentially fired squat jar composed, in typical La Venta

Olmec fashion, of a flattened spheroid base and a tall, spool-shaped, possibly mold-made, neck with near standardized orifice diameters of 14–16 cm. The function of these vessels is somewhat in the realm of speculation; however, the lime sizing suggests that they were designed to contain a liquid for periods of time longer than immediate usage, perhaps a fermented beverage of some kind. The co-occurrence of occasional shell-shaped black-fired fine paste drinking cups with annular bases may be related ([Figure 21](#)). As a group this set of forms may have functioned as elements in the ritualized consumption of beverages. Very large sand-tempered bolstered rim tecomates and bolstered rim urns with thick walls (10–15mm, bases to 25mm) and capacities in the dozens of liters that recall modern Highland Maya ceremonial *Ul* mega-tecomates are also present at San Andrés together with very large serving plates and dishes. This suite of vessels — the possible *cantaro* fermenting and storage pots, high value storage jars, shell analog cups, mega-tecomates and large serving plates — has not been recovered at hamlet sites.

Didactic miniatures: Miniatures scaled to match the size of the most common figurine size class at San Andrés occur in the form of fine paste gourd analog bowls, composite-silhouette serving plates, urns, and coarse paste *ollas* ([Figure 24](#)). Vessel rim diameters range from 2–6 cm. These miniatures may have been crafted with the express purpose of composing didactic or ritual reenactments of crucial mythic or conventionalized historic events much in the same fashion as La Venta Offering 4 (Drucker *et al.* 1959) with the crucial difference that in the case of San Andrés the raw material of scenes, figurines and pottery or other props, were reused and eventually discarded. They may also have served as instructive elements of childhood play, perhaps along with some of the figurines. Whether intended for semi-sacralized play, ritual didactic scene construction or both, pottery miniatures point to a larger tradition which emerged during the last three or four centuries of the La Venta polity. Offering 4, from the very core of the polity, provides a rare glimpse at the compositional canons of this ephemeral art form.

Maya and Chiapan Ceramic Imports: Will Andrews (1986) examined evidence for Maya Joventud Red and related Flores Waxy ware pottery of the Yucatecan Nabanche complex in collections from La Venta. Strikingly, this pottery is present in fairly substantial amounts (2%) in nearly all Late Puente through Late Franco lots at San Andrés, although similar pottery is virtually absent at hamlet sites (von Nagy 2003). It is most common in Early Franco phase lots. Red, buff, and possibly differentially fired red-and-buff calcite or sand-tempered dishes, frequently with characteristic down-turned everted rims, are present at San Andrés ([Figure 25a–i](#)). Many examples are relatively large dishes ([Figure 26](#)). [Figure 27](#) illustrates the slip color and form of two example vessels. A large proportion of vessels are bichrome like the dish illustrated in [Figure 27c–d](#). Late in the Middle Preclassic occupation of San Andrés, Maya reds and buffs are complemented, perhaps replaced, by imported orange and blotchy resist Nicapa Orange Ware pottery from Chiapan sources ([Figure 25j–m](#)).

The relatively large quantities of Flores Waxy and Nicapa Orange ware pottery at San Andrés point to the privileged position of San Andrés families within the larger La Venta political economy and to their use of imported pottery to manifest their prestige and power. The presence of Flores Waxy ware at western Tabascan elite sites may reflect differential access to emerging trans-Tabasco Coastal Plain trading links or, perhaps more likely given that the actual tonnage of Maya pottery represented is fairly insignificant, elite-to-elite gifting linkages across the Tabasco Coastal Plain. Examples of Flores Waxy ware pottery are currently undergoing sourcing, however a great deal of research needs to be done along the Tabasco Coastal Plain for the exchange system represented by this pottery to be understood.

Greenstone artifacts

The prestige artifact assemblage from San Andrés is comprised of two ceramic roller stamps, a shark tooth pendant, and an assemblage of 57 greenstone items that includes objects of body or clothing adornment, celts, polishers, and raw fragments ([Figures 29 and 30](#)). These items exhibit durability, exoticness, and labor investment, attributes that are characteristic of socially valued goods cross-culturally. The San Andrés elite artifacts also embody qualities of high-status materials particular to Formative period Mesoamerica where greenstone, clay, and animal bone were mediums for imagery that both symbolized and validated political-religious authority. Within the context of the La Venta polity, the San Andrés high-status objects conform specifically to canons of elite expression appropriated by the ruling nobility, identified by sacred offering contexts in La Venta center.

The Social Significance of the San Andrés Prestige Goods Chronological and contextual evidence demonstrate that the peak of prestige good consumption at San Andrés coincides with an increase in local feasting activity and with the cultural apogee of La Venta during the Early Franco phase. At La Venta, sumptuary goods, particularly items of jade and greenstone, were vital constituents of elite activity. Prestige goods were significant components of royal regalia and ritual performance perceived to ensure prosperity. The San Andrés elite goods are a tangible expression of this subsidiary community's hierarchical position within the sociopolitical domain of the La Venta polity. Beads, pendants, earspools, spangles, and plaques, as items of ornamentation, were worn by San Andrés inhabitants as emblems of status. In local networks of exchange and in the context of community feasts, prestige good circulation was a means of negotiating status and structuring social relationships within the San Andrés community and perhaps among the hierarchical network of Barí riverine sites. Through local ritual replication, the San Andrés inhabitants ritually deposited sumptuary items, emulating ceremonial acts performed in the polity center.

The La Venta-San Andrés Prestige Artifact Comparison-An Overview Comparisons of the prestige artifact inventories from San Andrés and La Venta reveal a number of common features while also demonstrating significant

differences. San Andrés shares a number of prestige artifact types with La Venta including roller stamps, shark teeth, and greenstone celts, beads, T-shaped pendants, spangles, and plaques. Zoomorphic forms reference sharks and birds, and both collections contain representations of the quincunx symbol, a conceptualization of the cosmos in Mesoamerican thought. Within these shared artifact types, La Venta goods are more abundant, and they exhibit a substantial degree of diversity to include an array of zoomorphic and anthropomorphic forms. The abundance and variability observed in the La Venta inventory is accompanied by a greater investment in labor manifested in artifact detail and stone polish ([Figure 29b, c and d](#)). The La Venta collection of prestige goods also contains artifact types absent from San Andrés including an incised obsidian core, greenstone figures and maskettes, and ritually significant items such as iron-ore mirrors, perforators, and stingray spines. A contextual comparison suggests that, like the La Venta prestige artifacts, the San Andrés sumptuary items were significant components of ceremonial activity. More than half the San Andrés elite good collection was recovered from ritual depositions in feasting contexts and caches. Ritual deposition at La Venta, however, is significantly more conspicuous. La Venta elite items were deposited with groups of sumptuary items in elaborate contexts defined by colored clays and pigments and architectural features and tombs. In contrast, San Andrés prestige artifacts appear individually or in small quantities in midden and pits that also contain mundane materials.

Common qualities among specific greenstone artifacts in both collections suggest shared cultural practices involving intentional artifact destruction and artifact reuse and recycling. Broken greenstone artifacts from both collections may indicate deliberate artifact mutilation prior to ritual burial, a Mesoamerican practice believed to remove the life force of objects and sanctioned their removal from social circulation (Freidel *et al.* 1993: 234–235). Broken artifacts may also demonstrate the deliberate division of revered objects to use in gifting and exchange practices. The San Andrés greenstone assemblage contains specific examples of jewelry fragments with evidence of cutting. These items may have been divided and distributed as political gifts by La Venta elite to integrate hierarchical relations with San Andrés. Specific attributes of artifacts in both inventories also suggest that revered objects were being recycled, a prevalent practice among later Mesoamerican cultures. The form and design of greenstone objects from both San Andrés and La Venta appear to preserve remnants of earlier object forms or alternatively, preserve unfinished objects in the process of being recarved.

Combined, the continuities and differences observed between the San Andrés and La Venta prestige artifact collections demonstrate a close sociopolitical relationship and the powerful influence of the La Venta elite on the San Andrés inhabitants. The ruling elite of La Venta modeled standards of elite behavior, appropriating symbols of power for display and ritual practice. Avian forms, sharks, and writing were intimately associated with the cult of rulership at La Venta. At San Andrés, a shark tooth pendant, incised jewelry plaques, and the

ceramic roller stamp represent these symbols of power. These specimens as well as other items of ornamentation facilitated shared perceptions of social and cosmological order and maintained the La Venta-San Andrés hierarchical relationship. Disparities in artifact quantity and quality reflect the difference in power and wealth between a political center and subsidiary community. Differences observed among the artifact inventories in form and elaboration may also manifest the independent acquisition of sumptuary goods by San Andrés elites. Participation in regional and long-distance exchange networks provided the La Venta ruling elite with a significant source of legitimizing power. Access to exotic, sumptuary resources at the local level through participation in such networks, provided lesser, San Andrés elites with an analogous source of power to demonstrate and negotiate status.

Olmec Writing

One of the most significant findings at San Andrés was the confirmation that the Middle Formative Olmec were in the process of developing a system of writing (Pohl *et al.* 2002). Early Franco phase feasting refuse yielded two classes of objects with early writing — small, engraved greenstone plaques about the size of a fingernail and a fist-sized roller stamp shown in [Figure 30](#). The artifacts are securely dated by both radiocarbon and the site ceramic chronology to ca. 650 B.C. The fact that the artifacts with glyphs were found in the context of feasting refuse suggest that writing among the Olmec was sacred and was closely tied to ritual activities.

Conclusion

High-status objects were a significant source of power in the La Venta polity: political power, economic power, and ideological power. They were tools used by the elite to enhance and maintain rights to rulership. Crafted from exotic materials, these items provided a link to the cosmologically distant and sacred; culturally significant forms embellished with iconography embodied cultural conceptions of cosmic and social order. These ideas and the goods themselves would have been disseminated to people across the landscape, spreading and reinforcing political-religious propaganda. Across all societal levels, symbolically imbued goods provided a common understanding of the Formative period world and bound people together through shared perceptions of cultural and social identity. The San Andrés high-status objects provide evidence of this community's privileged position within La Venta's sociopolitical sphere and demonstrate the use of these symbols along with more mundane elements of material culture, figurines and miniatures, to structure and integrate the hierarchy of power. Power that was made manifest and legitimized through performative ritual, sacralized meals and rituals of destruction. Within the local community, the San Andrés prestige goods provided a source of power to demonstrate and negotiate status at the local level, and San Andrés inhabitants emulated patterns of elite behavior and prestige good consumption modeled in the political center.

Acknowledgments

Additional support was provided by a grant from the National Science Foundation (SBR-9617389). We thank Mexico's Consejo de Arqueología of the Instituto Nacional de Antropología e Historia for permission to conduct the excavations at San Andrés. We acknowledge abundant aid in the field from Dr. Rebecca González Lauck of Proyecto Arqueológico La Venta and from Dr. John E. Clark of the New World Archaeological Foundation of Brigham Young University. We thank Ron Lowe for his assistance to the project. We thank Richard Brunck for his superb photographs.

List of Figures

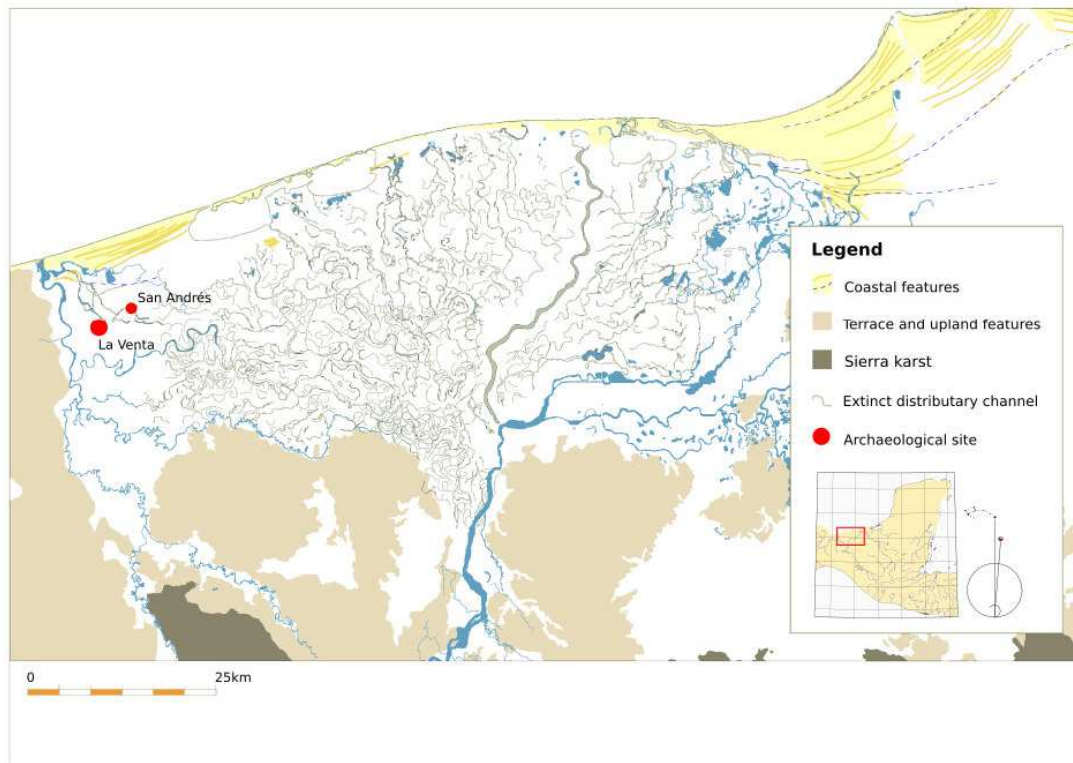

Figure 1: Location of San Andrés (Barí 1) and major geomorphological features of the Grijalva delta. After von Nagy (2003: Figure 2.5).

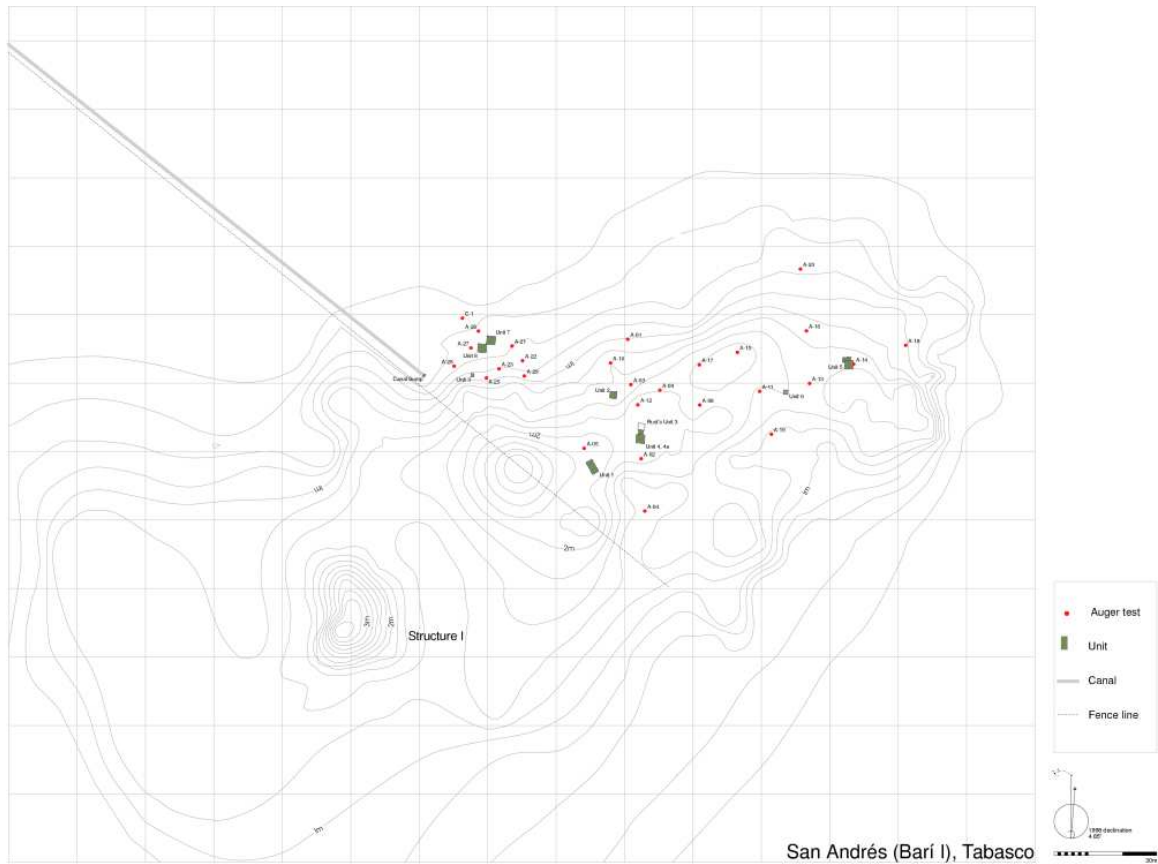
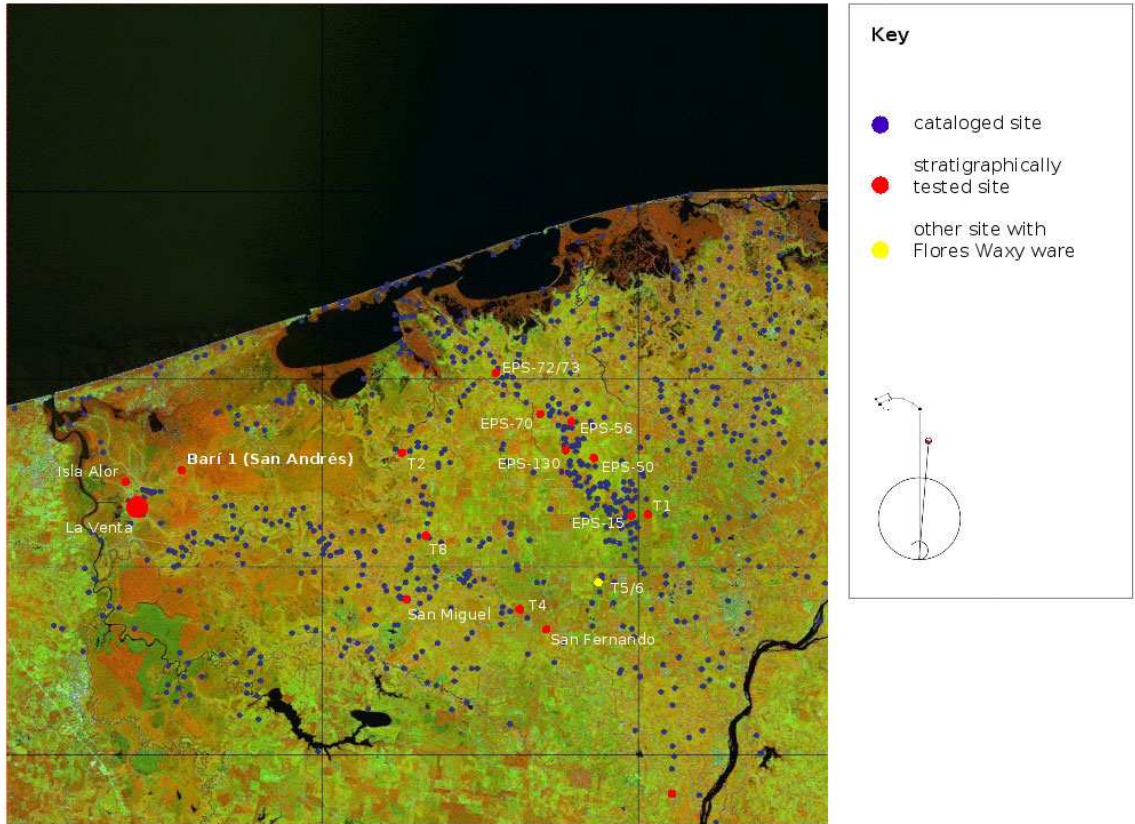

Figure 2: Topographic map of San Andrés with 20cm contour intervals. This map shows the core topographic high associated with San Andrés, however deeply buried cultural materials suggest that the actual extent of San Andrés along the course of the Barí levee may have been much larger at various points in the community's history, consistent with data from other Middle Preclassic sites in the Grijalva delta. Post Early Horizon (Palacios phase) Early Puente phase cultural deposits are intermixed within the levee body and extend approximately two meters below the overlying mass of the tell.



Base image a false color mosaic of four histogram equalized ETM scenes (bands 4 , 5, and 7)

Figure 3: La Venta region, Tabasco, Mexico and sites with published ceramics data. T sites are from Sisson (1976). EPS sites are from von Nagy (2003). Other sites from the Atlas Arqueológico de Tabasco and from Hyland (see González Lauck 1988, 1996).

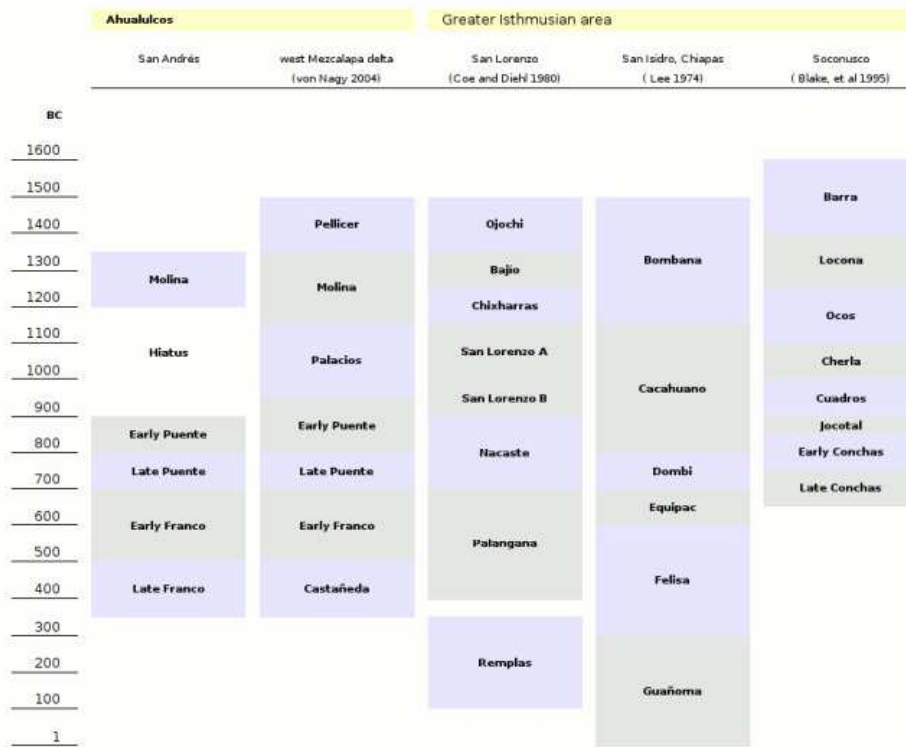

Figure 4: Comparative Preclass chronologies for the Greater Isthmusian region. After Blake *et al.* (1995); Coe and Diehl (1980); Lee (1974); Symonds *et al.* (2002); von Nagy (2003).

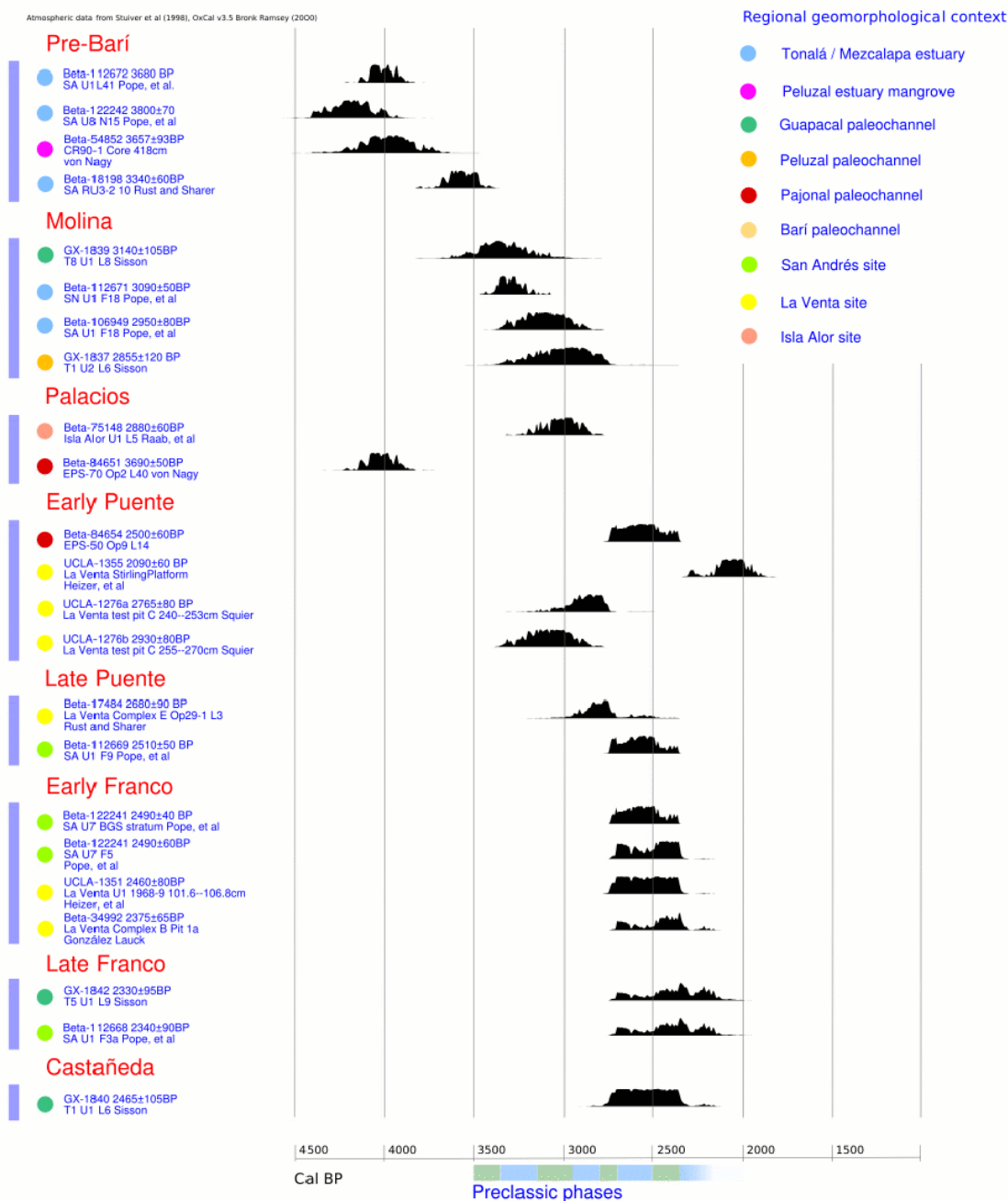

Figure 5: Selected calibrated radiocarbon age ranges for San Andrés, Tabasco and other nearby sites by archaeological phase. Uncalibrated radiocarbon dates and sources are given on the left. The regional Palacios Phase (Early Horizon) is not present at San Andrés. Calibration via OxCal version 2.18 using the Seattle curve Bronk Ramsey (1994). Sources: Heizer *et al.* (1968); Pope *et al.* (2001); Rust and Sharer (1988); Sisson (1976); Squier (1964); von Nagy (2003).

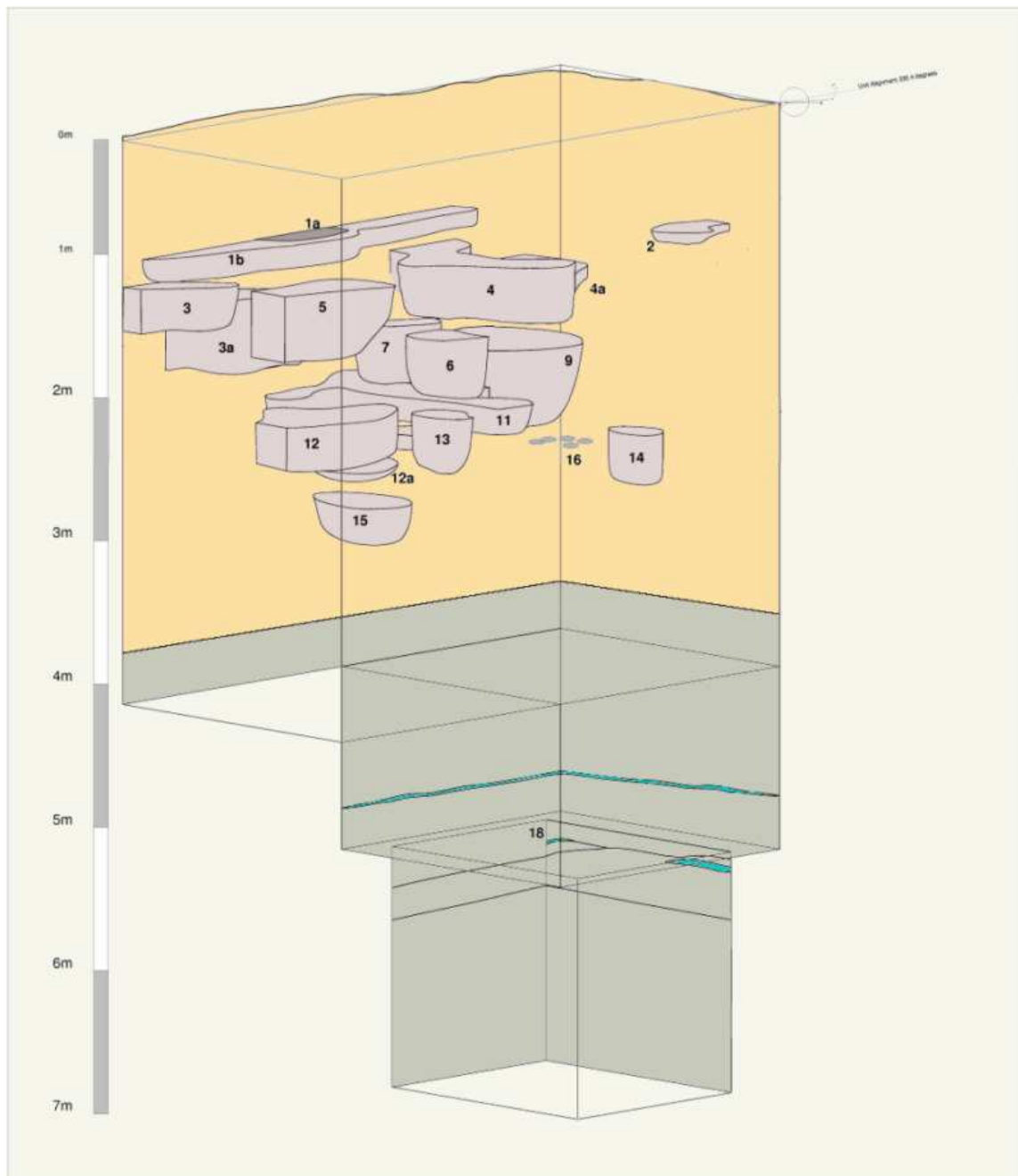

Figure 6: Three dimensional view of Unit 1 stratigraphy showing small pit features. These pits, mostly storage but also hearth pits, contain Early Puente through Late Franco phase samples. Feature 16 is an Early Puente offering/cache of a complete stone tool kit, including a small metate and mano, hammer stone and large pestle.

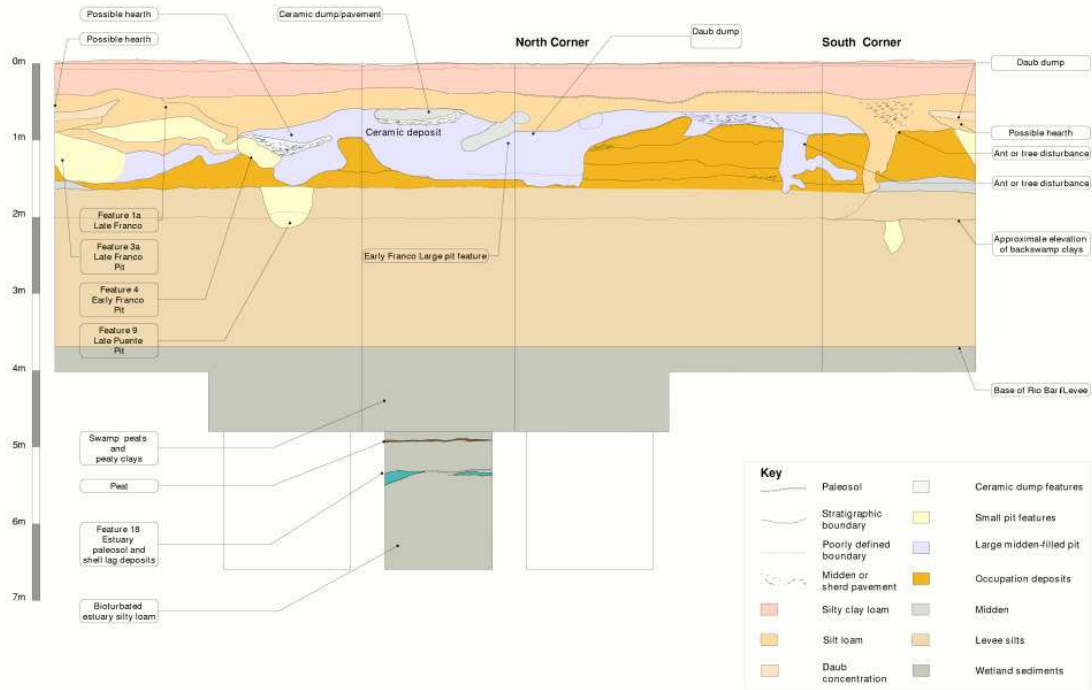

Figure 7: Unit 1 stratigraphy. Unit 1 was excavated on the crest of the site mound at the edge of a low, eroded mound. The upper levels are fill containing Late Franco complex pottery. Below this are a series of larger and smaller pits cut into earlier occupational deposits containing Early Franco phase deposits. Late Puente phase deposits occur near the junction of the zone of floors and pits, in particular the large storage pit (Feature 9, see [Figure 6](#)). The Early Puente phase occupation is associated with the Rio Bari levee. An occupational hiatus at San Andrés associated with the accumulation of the initial Bari paleodistributary levee silts and underlying fresh-water swamp clays and peats followed an estuary edge occupation at the locality in the fourteenth century B.C. with associated Molina complex ceramics (Feature 18). A peat layer overlying the estuary Paleosol is visible in [Figure 9](#) stratigraphically correlating these two units.

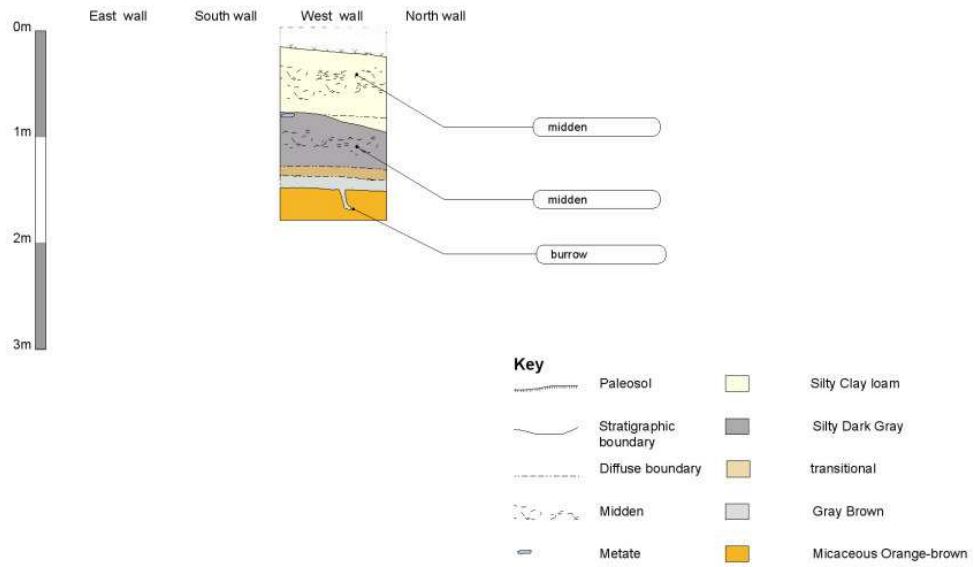

Figure 8: Unit 3 stratigraphy. The lower midden is associated with Late Puente complex pottery and overlies Barí paleodistributary levee silts with Early Puente complex materials.

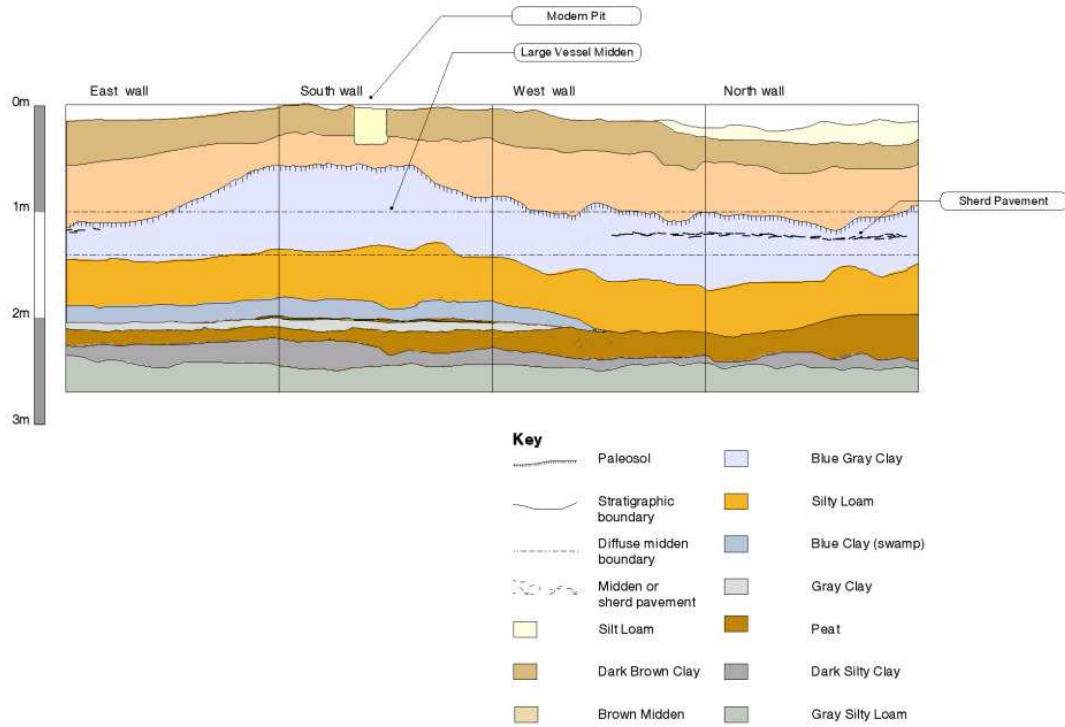

Figure 9: Unit 8 Stratigraphy. Unit 8, as well as the immediately adjacent Unit 7, sampled the modern edge of the site mound. An extensive Early Franco midden feature containing numerous partially intact vessels, jade, a cylinder seal, well-preserved large animal bones, a fragmentary human crania (possibly though not necessarily a burial located at the base of the BGS Clay Strata in Unit 7), as well as other debris is associated with both units, as is the sherd pavement composed of intensely reburied small to large sherds.

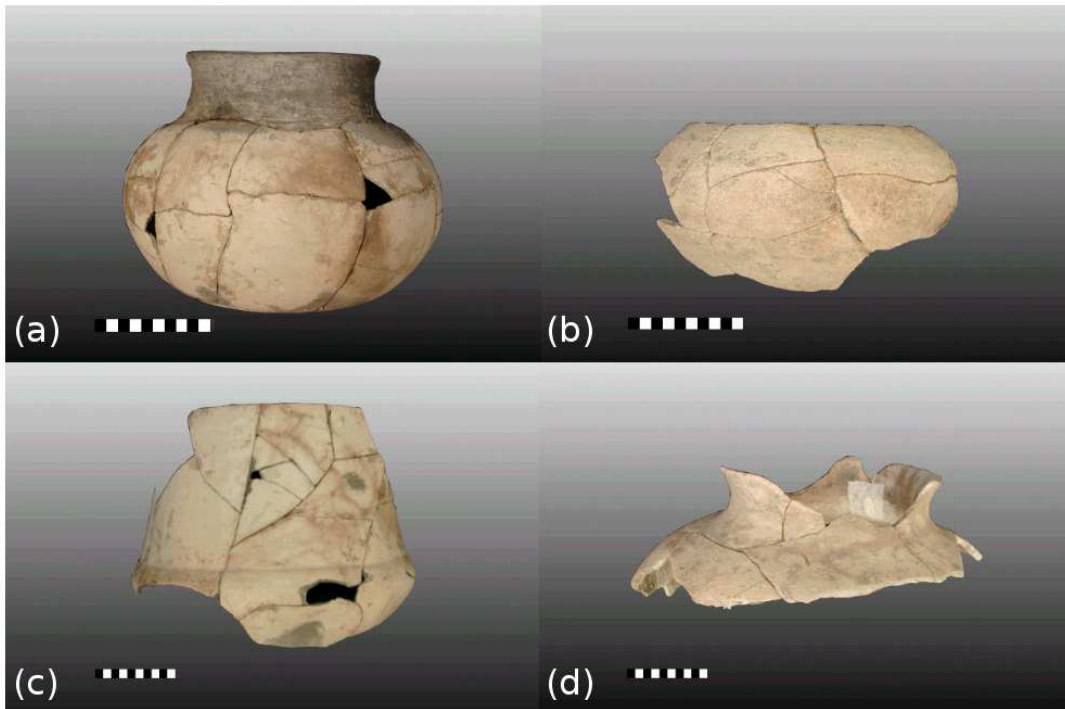

Figure 10: Four reconstructed examples of Early Franco complex ceramic vessels. A volcanic ash-tempered, differentially double-fired Desengaño Black-and-white spool-necked jar (a); a simple fine sand-tempered Gogal Plain tecomate or bowl (b); a volcanic ash-tempered large Tecolutla Incised urn (c); and a fine sand-tempered Gogal Plain jar with an outcurved rim (d). Vessel (d) is essentially a less well executed version of jar (a). Photographs by Christopher von Nagy.

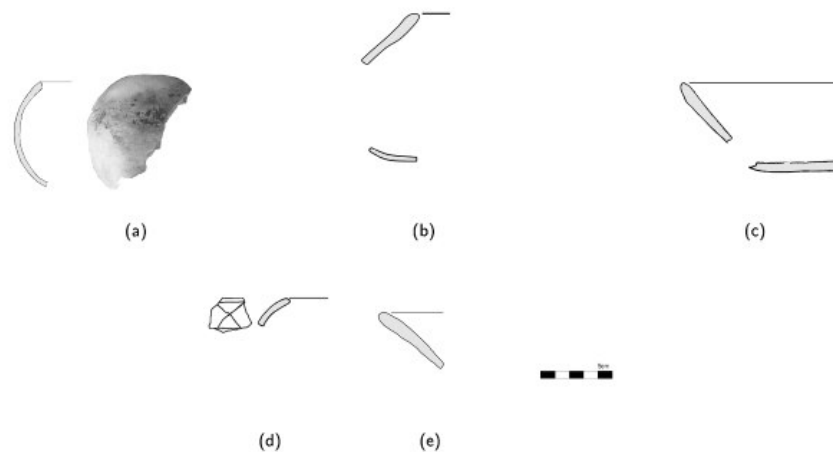

Figure 11: Molina complex vessel forms. *Tecomates* black-slipped Tocayo Black form li (a), Estero Plain (form lz) (b); *bowls* volcanic ash-tempered Andrés Incised (d) *dishes* Estero Red (form llv) (c), Bronze Unslipped (e). Tocayo Black is a fine sand tempered, plain black-slipped type. Andrés Incised is a volcanic ash-tempered type with fine-line incision fired black. Estero Plain is a fine sand tempered, gray fired type and distinctive wet-clay interior brushing. Small patches suggest the possible presence of a reduced red slip. Bronze Unslipped is a plain, medium sand-tempered utilitarian type finished with a wash and fired to a range of browns. Some eroded examples appear buff but this color is often the result of post-deposition chemical reduction with characteristic buff reduction rinds on the exterior and break surfaces and original colors preserved within the rest of the sherd. Form modes, the presence of differentially fired, ash-tempered pottery, the relatively low frequency of red-slipped pottery and the presence of black-slipped pottery similar to Mojonera Black link the Tabascan Molina complex with the Chicharras complex of the Coatzacoalcos river basin.



Figure 12: Molina complex types. Exterior and interior surfaces of an Estero Plain tecomate (a) and (b). Note the presence of bryozoa shell on the interior from the sherd's submergence in the then estuary. This is the same tecomate illustrated in Figure 12b. Black-slipped Tocayo Black tecomate (c). Also illustrated in Figure 12a. Various San Isidro Brushed examples (d).

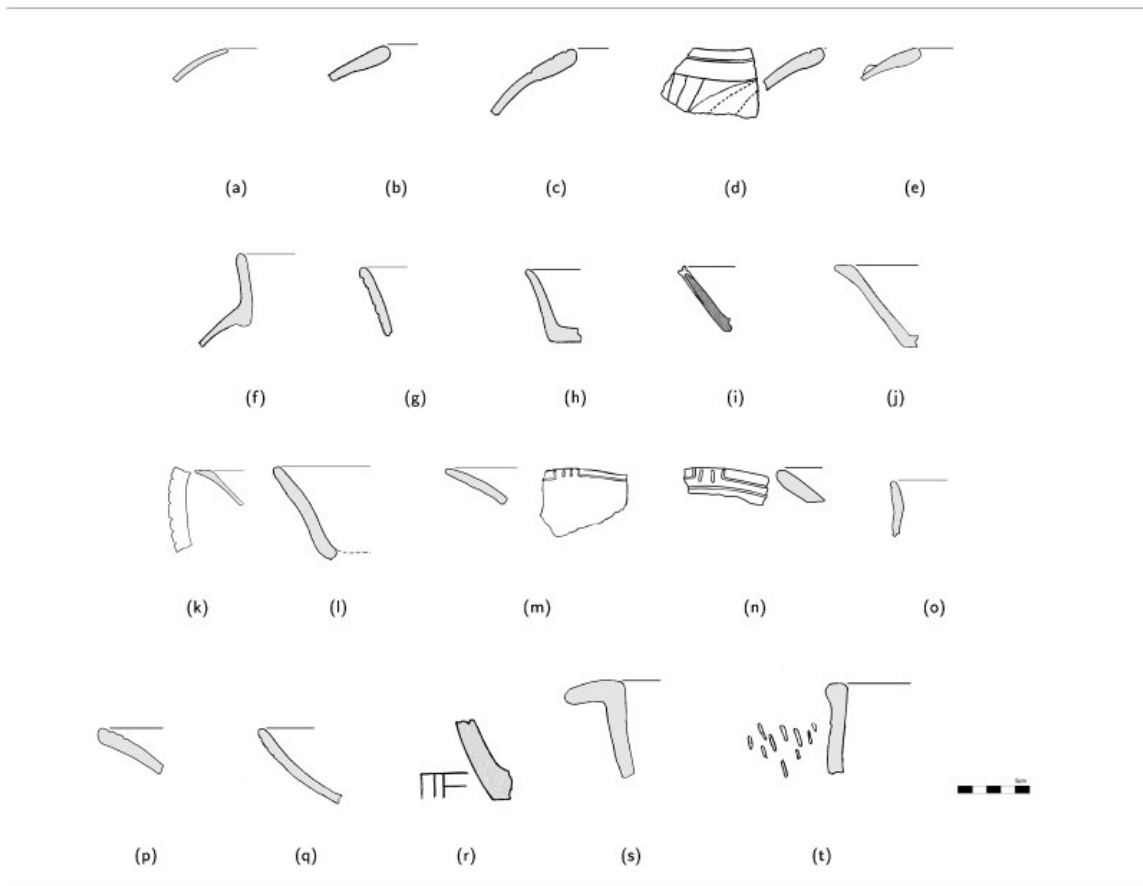

Figure 13: Selected Early Puente complex pottery vessel forms. *Tecomates* Eden Unslipped (a), Bronze Unslipped (b), Golpe Incised (c, d), Juliero Bossed (e, appliqué variety); *Jars* La Florida Black-and-white (f); *Dishes* San Andrés Scored (g), Naranjeño Black-and-white (h–k), Blasillo White (l), Santuario Incised (m), Golpe Incised (n), Guapacal Incised (p, q), Alcantarilla Incised (r); *bowls* or *basins* Guapacal Incised (o), Naranjeño Black-and-white (s), Guapacal Punctate (t). Examples j and r are from La Venta. Juliero Bossed and San Andrés Scored are decorated finger or appliqué bossed and scored variations on the common medium sand-tempered type Bronze Unslipped. Eden Unslipped and Golpe Incised are coarse sand-tempered plain and incised types fired to a range of browns. Naranjeño Black-and-white and Guapacal Incised are plain and incised fine sand-tempered, differentially fired types. La Florida Black-and-white is a medium to coarse sand-tempered analog of Naranjeño Black-and-white. Blasillo White and Santuario White are plain and incised white-slipped types. Alcantarilla Incised is a distinctive type of the fine sand-tempered, black fired ware, Pejelagartero Black, characterized by hematite filled geometric incision.



Figure 14: Examples of Early Puente complex types. Highly eroded examples of Blasillo White from Unit 1 (a); Guapacal Incised dish and bowls (b); Juliero Bossed tecomate interiors (c); various examples of Bronze Unslipped (d).

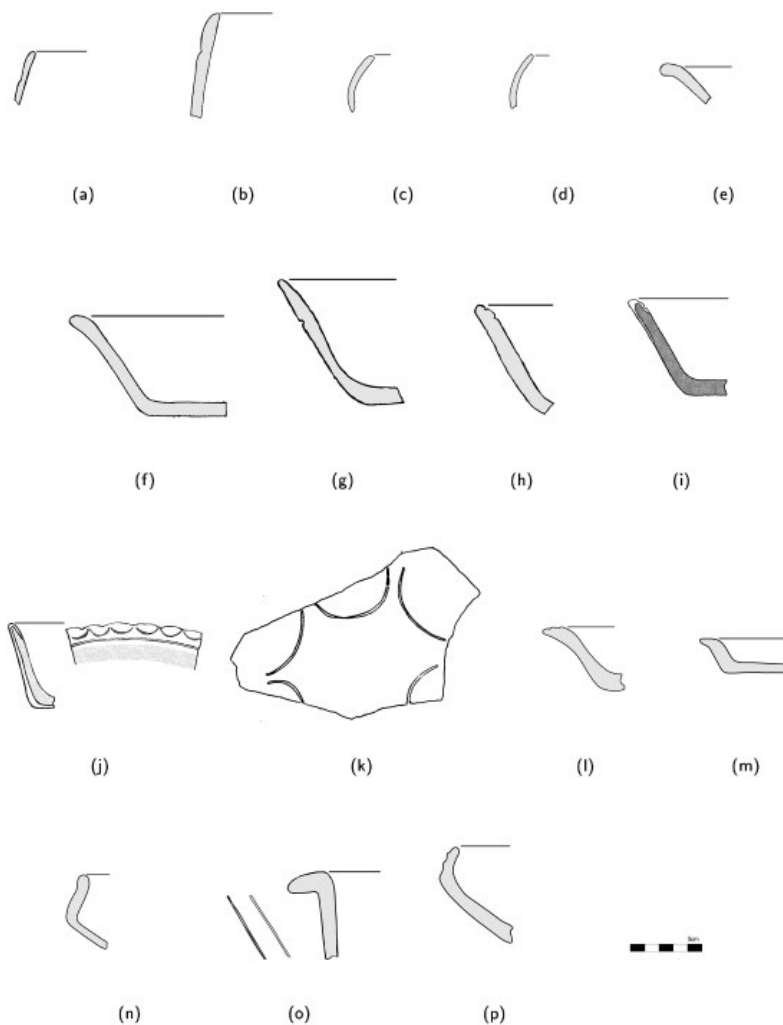

Figure 15: Selected Late Puente complex pottery forms. *Restricted bowls* Desengaño Black-and-white (a–d); *basin* Tonalá Incised (o); *dishes* Gogal Plain (e–f), Tecolutla Incised (g–k), Guapacal Incised (l), Desengaño Black-and-white (m), *restricted dishes* Palma White (n), Chichón Red-on-cream (p). Desengaño Black-and-white (plain) and Tecolutla Incised are differentially fired, volcanic ash-tempered types. Tonalá Incised is slipped white. Palma White is a fine sand-tempered, white clear through type. Chichón Red-on-cream is probably intermixed from Early Franco phase deposits, although may already occur in the Late Puente phase. Decoration constructed from arc elements is a very common aspect of Late Puente phase pottery manufacture.

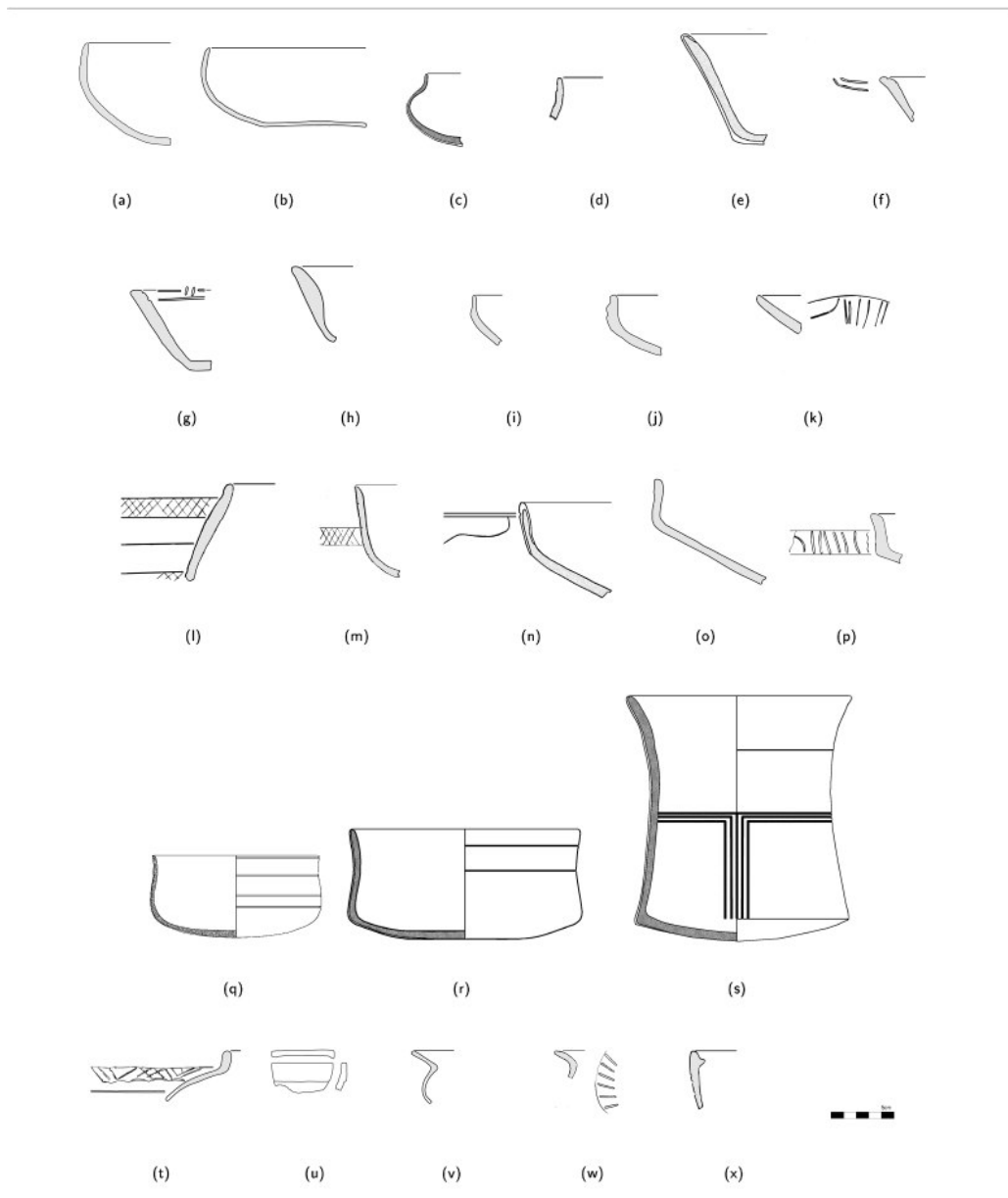

Figure 16: Selected Early Franco phase pottery forms. *Bowls* Mecatepec Fluted (a), Mecatepec Incised (x), Mecatepec Zoned-incised (m); *restricted bowls* Mecatepec Zoned-incised (l); *collared bowls* Desengaño Black-and-white (c), Tecolutla Chamfered (d), Arroyo Incised (t), Mecatepec Incised (v–w); *dishes* Tecolutla Incised (e–g), Desengaño Black-and-white (h); *restricted dishes* Tancochapa Black (b); *plates* Mecatepec Incised (k); *composite-silhouette dishes* Mecatepec Incised (i), Chichón Red-on-cream (j), Tecolutla Incised (n), Desengaño Black-and-white (o), Encrucijada Incised (p); *baggy bowls and vases* Tecolutla Incised (q–s); *rectangular vessels (canoes)* Desengaño Black-and-white (u). Tecolutla Incised and Tecolutla Chamfered are differentially fired, volcanic ash-tempered sub classes of Desengaño Black-and-white ware. Tancochapa Black, Mecatepec Incised, Mecatepec Zoned-incised and

Mecatepec Fluted are all fired black. Chichón Red-on-cream is a distinctive red or red-on-cream import with a coarse volcanic ash-tempered paste of uncertain provenience. The temper is distinct from the basaltic ash temper seen in some southern Veracruz pottery suggesting a Tabasco Coastal Plain locus of manufacture. Arroyo Incised is a medium sand-tempered, coarsely finished differentially smudged type manufactured with a firing recipe that suggests links to Chiapan differential firing traditions. All other differentially fired types are not smudged but are initially fired black clear through then fired a second time to remove paste carbon from unprotected portions of the vessel surface.

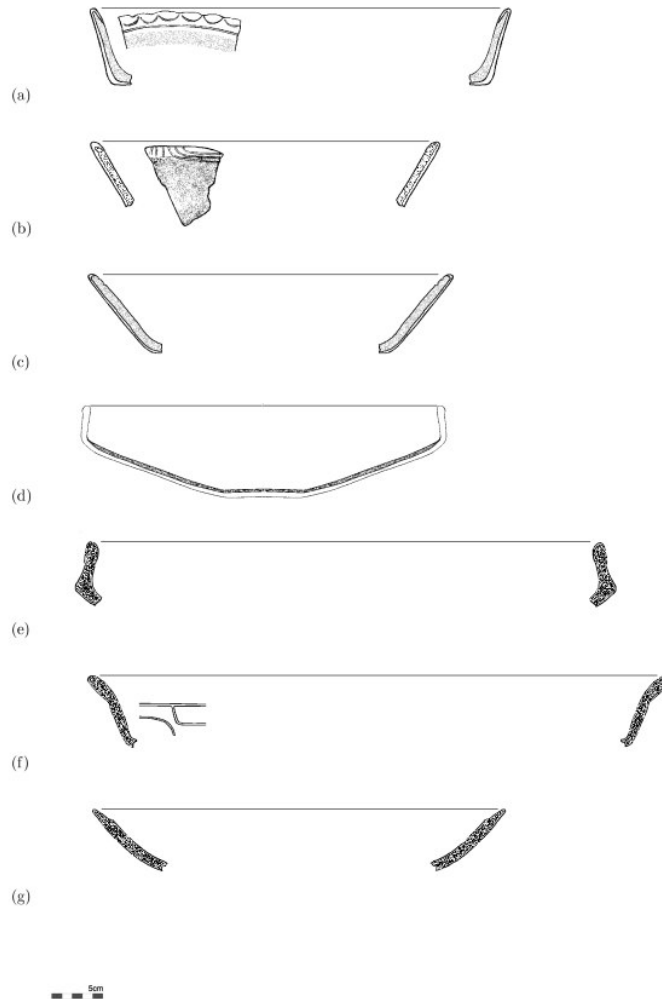

Figure 17: Selected Late Puente through Late Franco phase dish and plate forms. Vessel diameter is represented by the position of the mirrored cross-section. Frontal views of decoration are not geometrically compensated. The first three dishes (a – c) are examples of the most common form of dish, a simple flat base, flared wall vessel common from the regional Pellicer phase through the established Preclassic ceramic sequence. Dish (d) is an Early Franco complex form as is plate (e). Plates (f) and (g) are examples of Late Franco complex forms. Dishes (a) through (d) are differentially fired. The remaining dishes are fired black clear through.

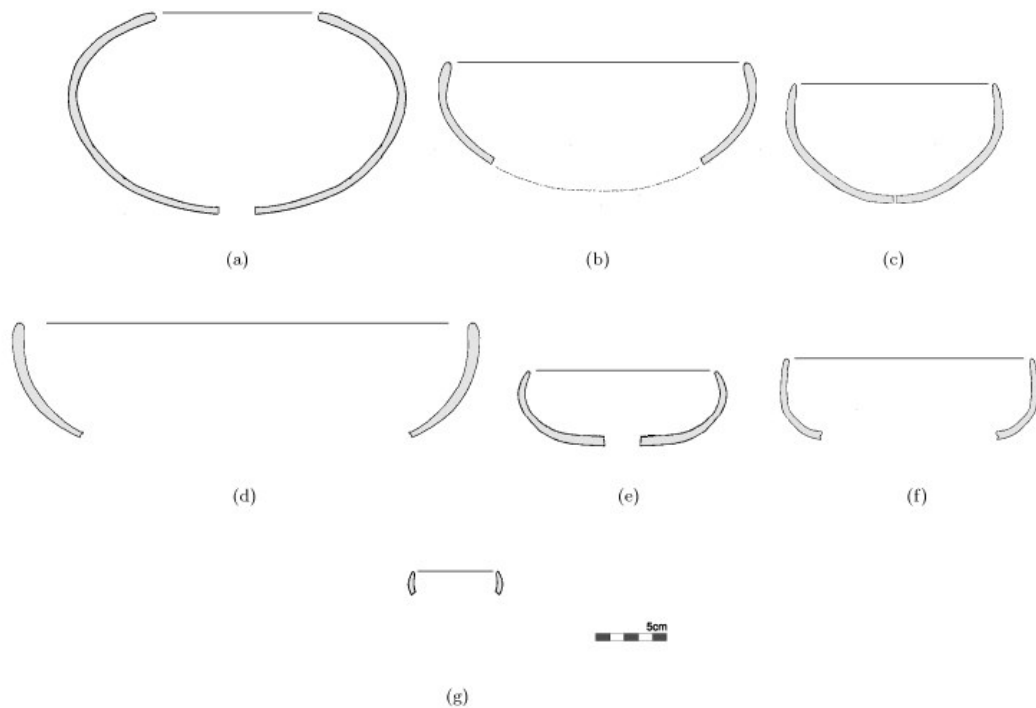

Figure 18: Selected Late Puente through Late Franco phase tecomate and bowl forms. Vessel diameter is represented by the position of the mirrored cross-section. The flattened spheroid is the basic structural unit of Preclassic pottery in western Tabasco with forms ranging from the simple tecomate (a), frequently with a structurally reinforced orifice, slightly restricted bowls (b, c and e), and more open bowls (d) and (f) are increasingly common in Early Franco phase collections. The orifice may be wider or narrower, simple or fused to a variety of neck or chimney components. Bowls range from large (d) to small (g) and even miniature with orifice diameters of 2 cm.

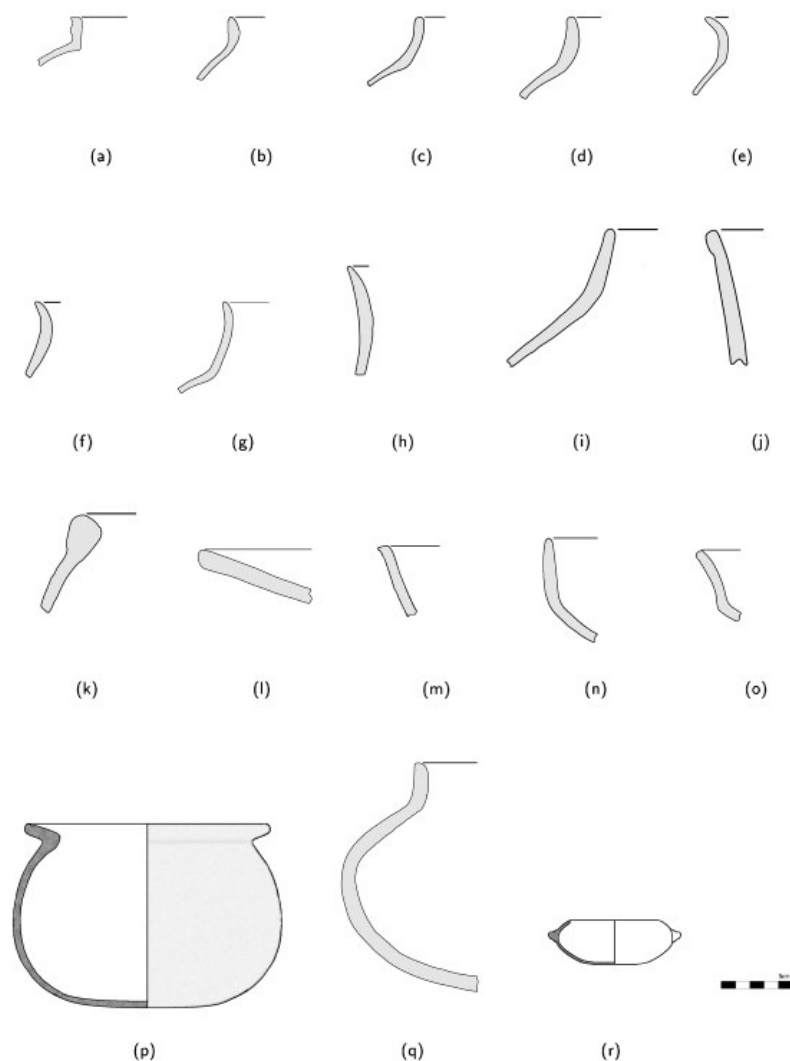

Figure 19: Selected Late Puente through Late Franco phase jar and other utilitarian forms. *Jars Golpe Fluted* (a), *Gogal Plain* (b, g, i–j), *Bronze Unslipped* (c–f, h); *mega-tecomates San Antonio Thick* (k); *Comales Fernando Coarse* (l–m); *coarse dishes Fernando Coarse* (n), *Arroyo Smudged* (o); *restricted bowls Pajalar Incised* (p), *Fernando Coarse* (q), *Reina Brown* (r). Late Puente complex (a, c–f, h), Early Franco complex (b, i–j, l–m, o, p–r), Late Franco complex (g, k, n). *Olla* body forms are generally similar to vessels (q) and (r). Golpe Fluted and Fernando Coarse are coarse sand-tempered types with varying surface treatments. Gogal Plain is a fine to medium/fine sand-tempered type fired to a range of browns and without decoration. Pajalar Incised is a medium sand tempered, incised type. San Antonio Thick is manufactured with the same paste recipe as coarse examples of Gogal Plain but has markedly thick walls.

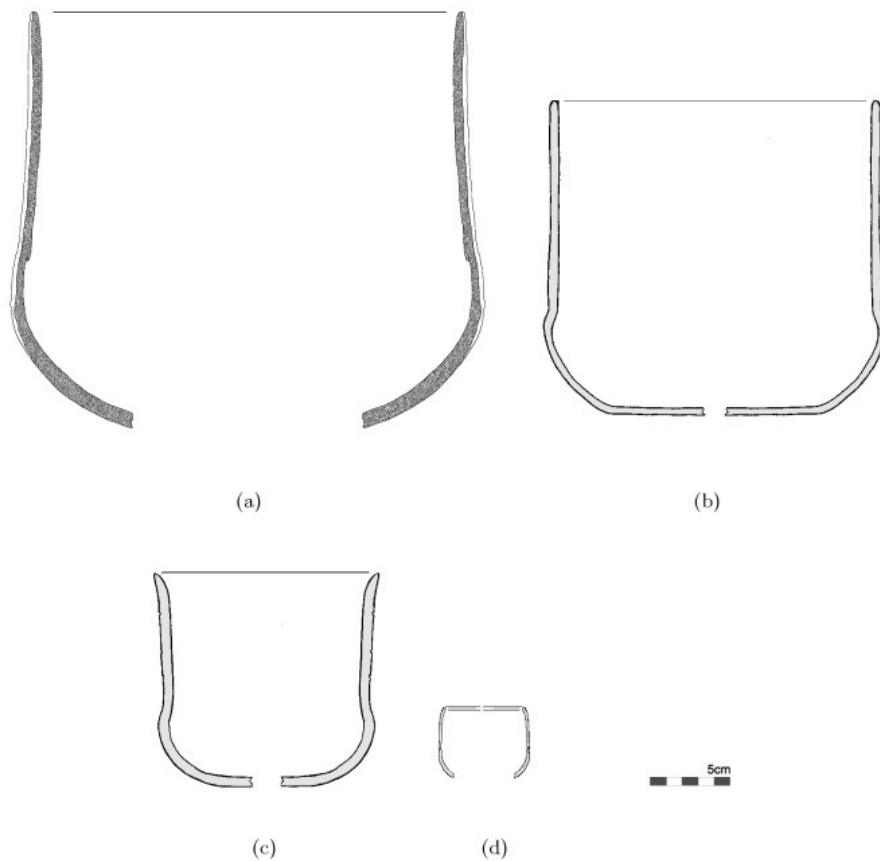

Figure 20: Selected Early Franco complex urns from San Andrés. Vessel diameter is represented by the position of the mirrored cross-section. Chimneyed bowls or urns are a common Early Franco complex form at San Andrés consisting of an open bowl base and an attached cylindrical chimney. Interior joints are usually coarsely finished in larger vessels. Smaller urns like examples (c) and (d) have better interior finishes suggesting variations in intended use. The small urn (c) has a rim diameter identical to the standardized Early Franco complex ceramic lids present at San Andrés and in northern Chiapan collections (see [Figure 21b and c](#) for an example of these lids and 21a for a picture of this urn). Small urns like (d) are also present in San Isidro collections (personal observation, NWAf ceramoteca, San Cristobál de las Casas, Chiapas). Like most differentially fired vessels at San Andrés, nearly all urns are double-fired initially black clear through then white in areas not protected during the second firing. The exterior is always white. Smaller urns may be fired white clear through.

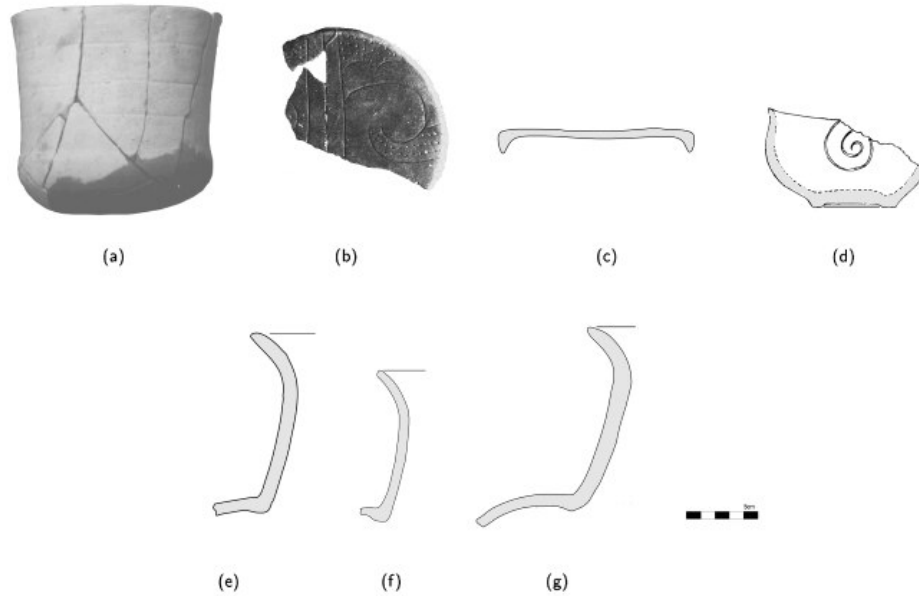

Figure 21: Elements of the beverage service sub-complex. Tecolutla Incised small urn (a); Tecolutla Incised-punctate vessel top (b, c); Concha Modeled-incised mock shell cup (d); Desengaño Black-and-white spool-necked lime-sealed jars (e–g). Concha Modeled-incised is tempered with fine volcanic ash and fired black clear through. The urn may or may not belong here, however the mock shell cup and fine, lime sealed spool-necked jars argue strongly for a beverage consumption component to La Venta Olmec public and/or private ritual. Body sherds recurved in association with jar spool necks suggest a flattened spheroid form, in essence these jars were markedly necked tecomates. The large capacity of the sealed spool-necked jar and amphora forms suggest the production and consumption of significant amounts of beverage whether alcoholic or not. Larger urns lack lime sealing and appear not to have been intended for liquid storage or manipulation although they recall much later Classic Maya cacao preparation pots.

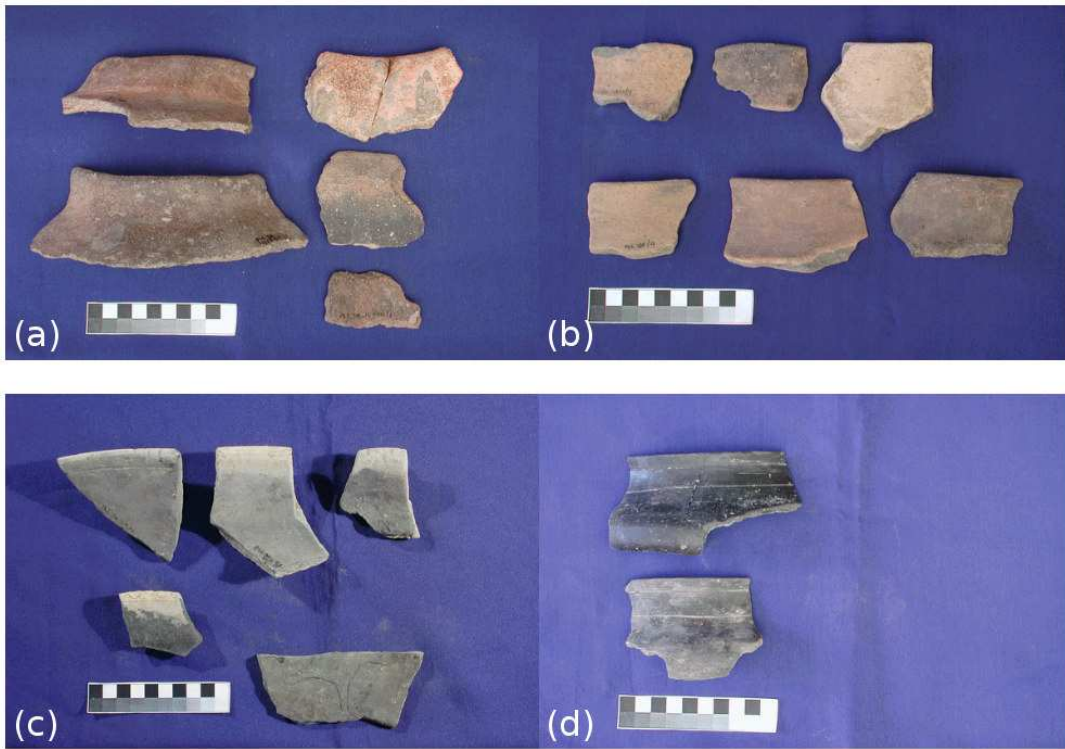

Figure 22: Common Early Franco complex types. Coarse sand-tempered Eden unslipped (a); fine sand-tempered Gogal Plain (b); differentially fired, volcanic ash-tempered Tecolutla Incised (c); and black clear through Mecatepec Incised (d).



Figure 23: Fine volcanic ash-tempered, black clear through Mecatepec Zoned-incised. In both form and decorative pattern this type recalls the basket. Together with modeled shell cups and the square-bowed ceramic canoes present at San Andrés, it reflects the playful reduplication by the La Venta Olmec of elements of their material life in different media and at varying scales.



Figure 24: Examples of Early Franco miniature vessels. Vessel orifice diameters are on the order of 2 - 6 cm. Walls are frequently egg shell thin. Bowls (a - f), composite-silhouette dishes or plates (g) and *ollas* (h) are represented. Nearly all bowl and dish forms are fired black clear through.

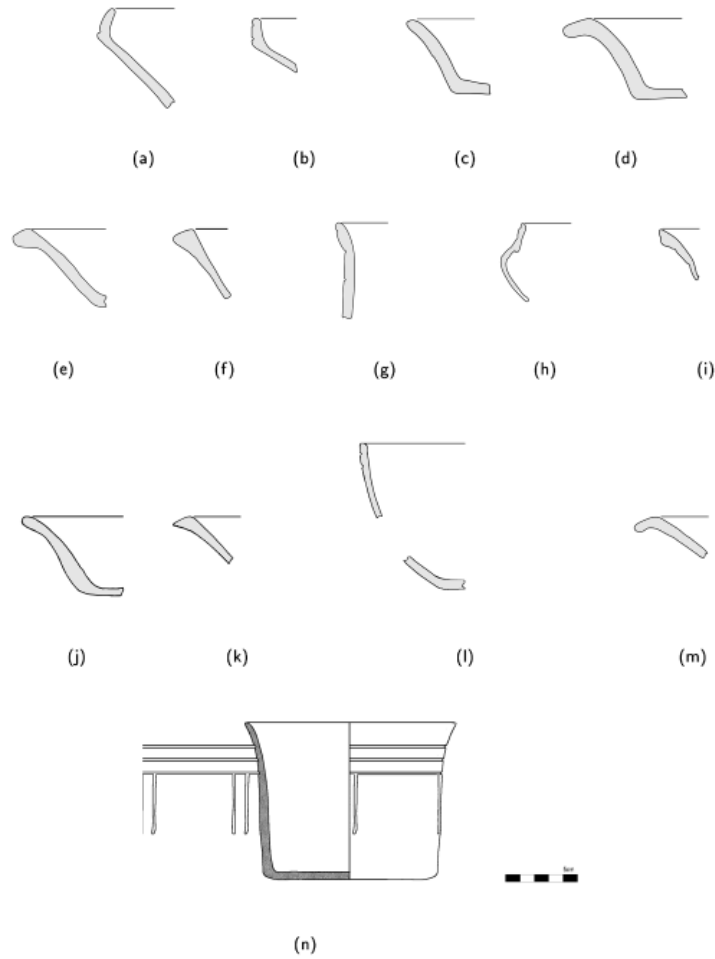

Figure 25: Imported Flores Waxy ware, Nicapa Orange and Orange-resist ware and other pottery. *Composite-silhouette dishes and bowls* Tumben Incised (a–b); *bowls* Guitara Incised (h), Reburned and eroded Flores Waxy ware (i), Mercader Orange (l); *dishes* Reburned and eroded Flores Waxy ware (c), Guitara Incised (d), Dzudzuquil Cream-to-buff (e), Joventud Red (f), Unidentified thin brown brushed-slip import (j), Mercader Orange (k), Apompo Resist (m), ; *vases* Reburned and eroded Flores Waxy ware (g), reduced crackled-brown slip import (n). Flores Waxy ware (a–i), Nicapa Orange and Orange-resist wares (k–m), unidentified imports with chemically reduced exteriors (j, n). Early Franco complex (a–e, g–n), Late Franco complex (f).

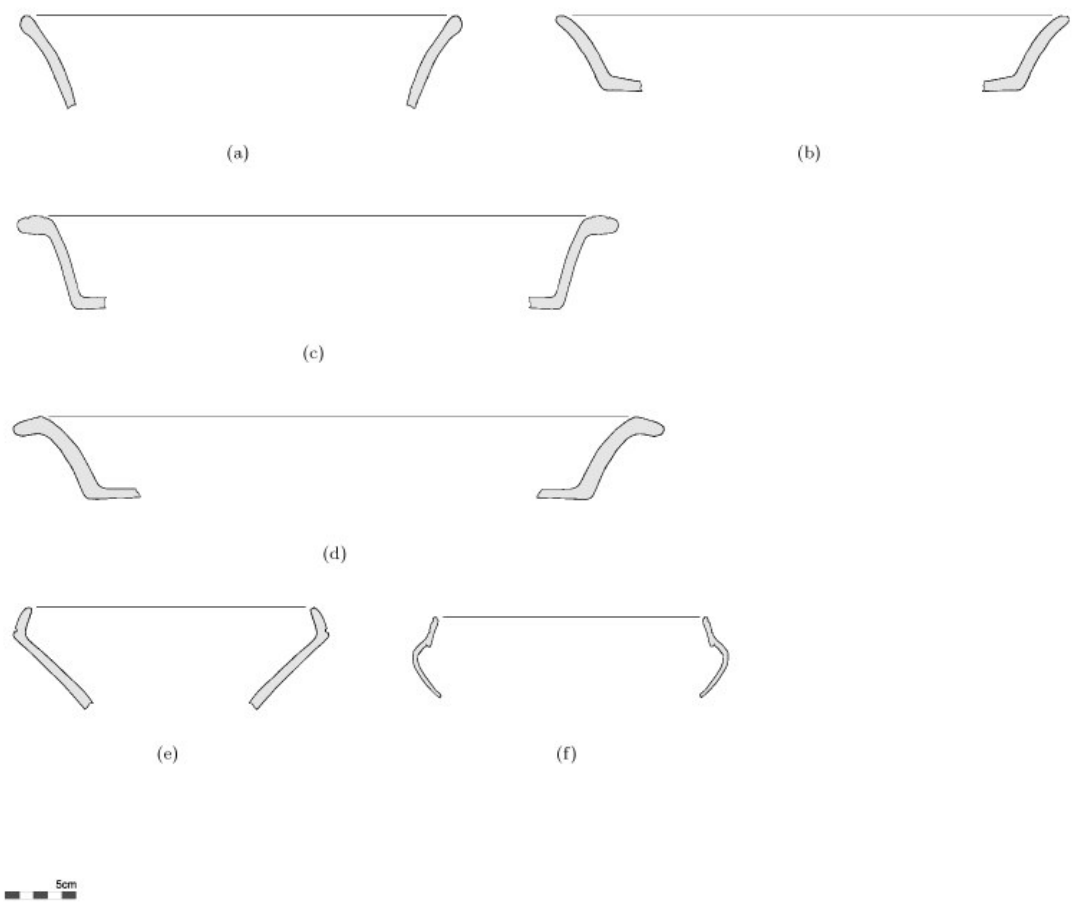

Figure 26: Selected examples of imported Flores Waxy ware dishes and bowls. Vessel diameter is represented by the position of the mirrored cross-section.

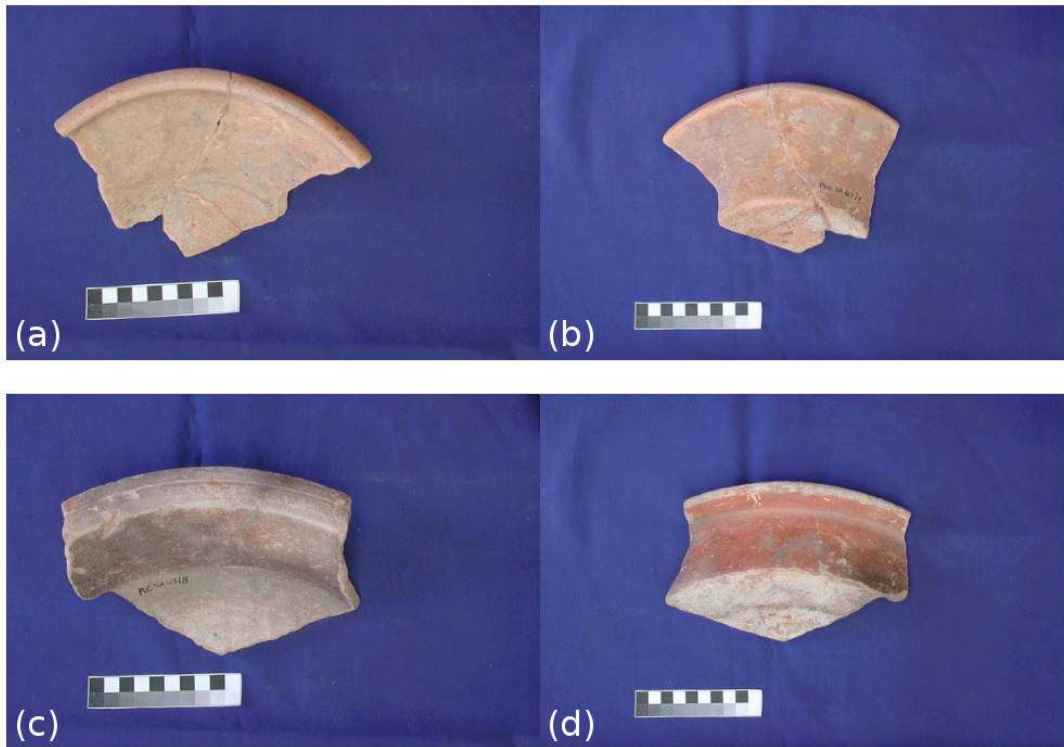

Figure 27: Selected examples of imported Flores Waxy ware types. A Dzudzuquil Cream-to-buff composite-silhouette bowl (a and b, form IIs) and a differentially fired Guitara Incised dish (c and d, form IIby). Most examples of Flores Waxy ware imports at San Andrés demonstrate a control of color analogous to that of locally produced differentially fired black-and-white pottery. Red occurs most frequently on the exterior with buff on the interior although some examples are reversed. Color differences appear to have been maintained around the entire circumference of the vessel.

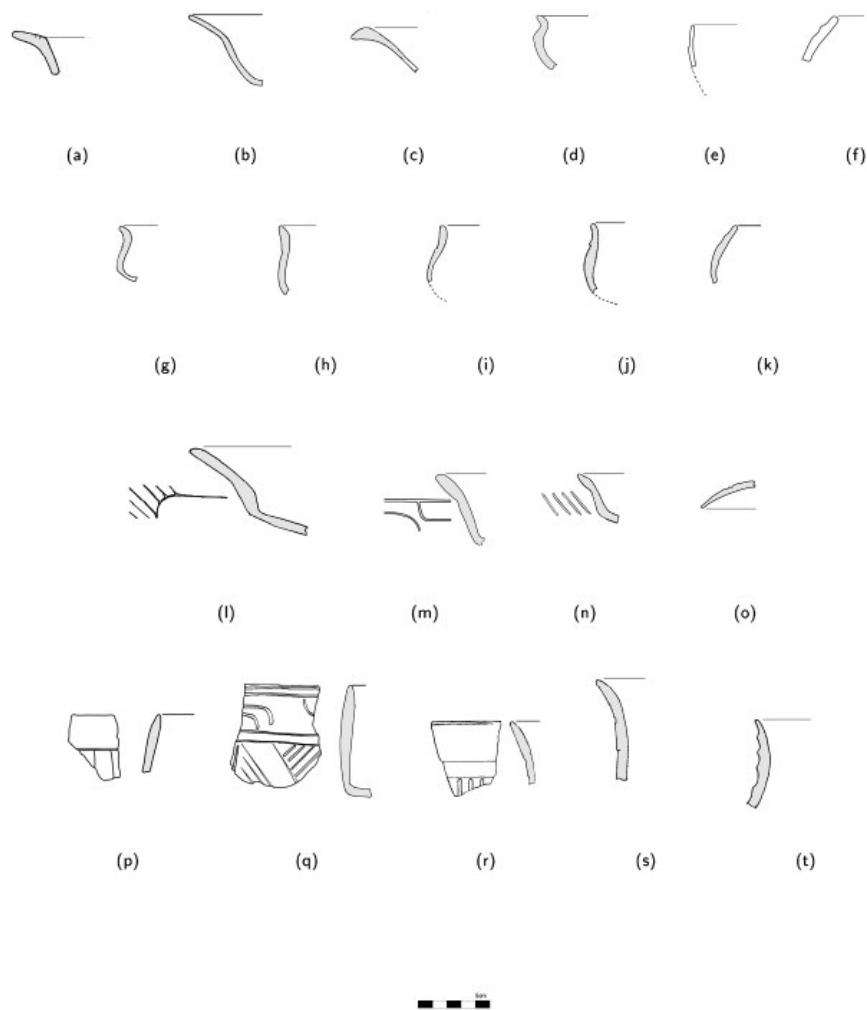

Figure 28: Selected Late Franco pottery complex forms. *Dishes* Alegre Incised (a), Moste Modeled (b, modeling is on the upper surface of the rim eversion), Encrucijada Plain (c); *restricted bowls* Carmen Plain (d–e), Encrucijada Fluted (f), Mecatepec Fluted (k); *saddle-rim bowls* Encrucijada Plain (g–j); *composite-silhouette dishes and plates* Encrucijada Incised (l–n); *vases* Mecatepec Corrugated (p), Mecatepec Zoned-incised (q), Mecatepec Incised (r); *jars* Encrucijada Fluted (t), *tops* Mecatepec Incised (o). Moste Modeled, Encrucijada Fluted, Encrucijada Plain and Encrucijada Incised are differentially fired, volcanic ash-tempered types. Carmen Plain is an undecorated temper free differentially fired type. Alegre Incised is the temper-free variant of Mecatepec Incised.

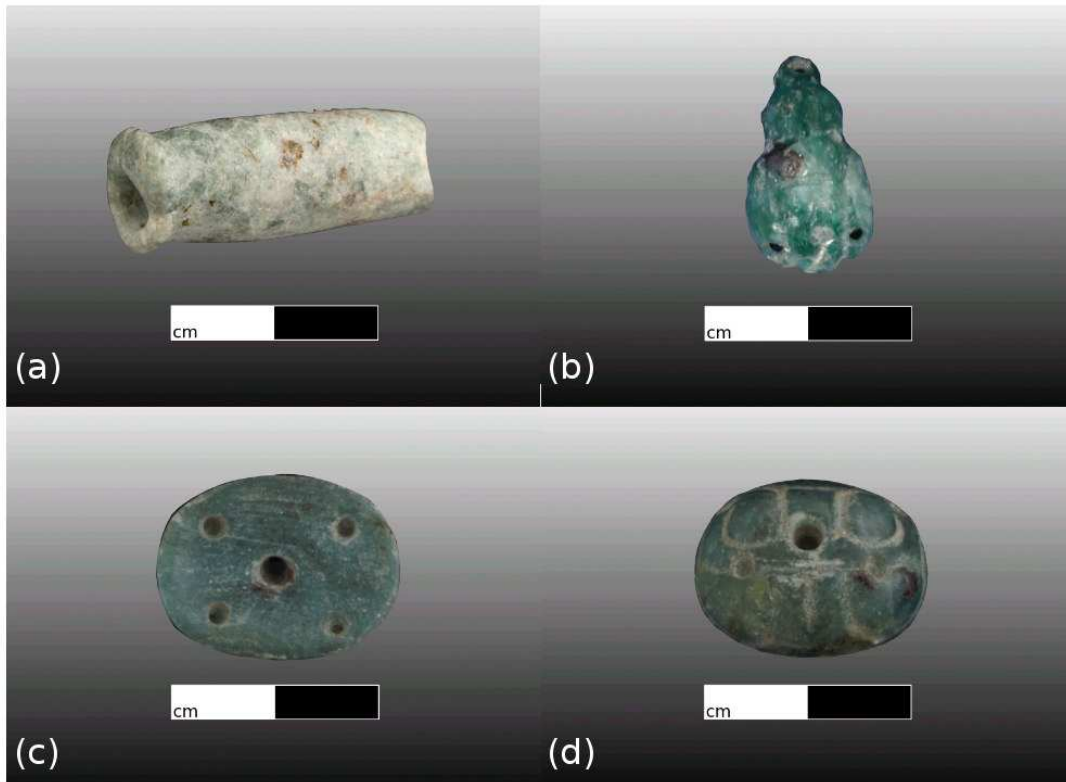

Figure 29: Greenstone jewelry from an Early Franco phase cache at San Andrés ca. 700-550/500 cal B.C. Tube bead (a); bee pendant (b); greenstone ornament from a San Andrés cache shows the quincunx design representing the center of the world and illustrating close ideological ties between the site and La Venta (c and d). Photographs by Richard Brunck.

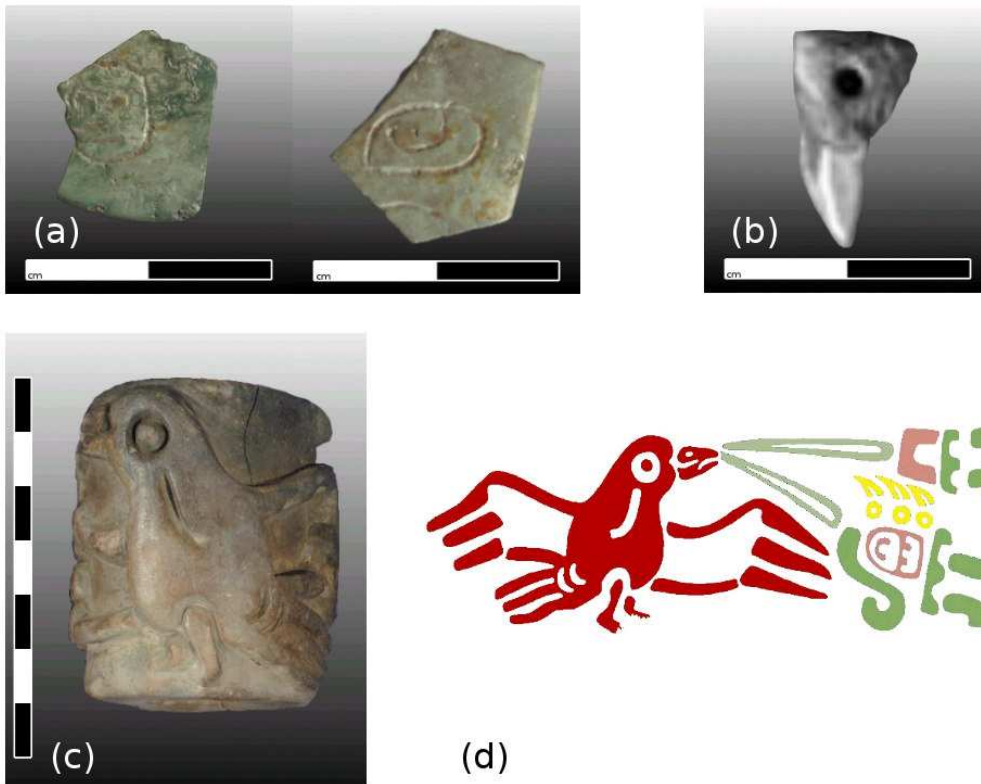

Figure 30: Symbols of power San Andrés shares with La Venta, ca. 700-550/500 cal B.C. Greenstone plaque fragments incised with glyphic elements (a), shark tooth pendant (b); photo (c) and rollout (d) of ceramic roller stamp with a bird in profile. We have colored the rollout by semantic component. Plaque photographs by Richard Brunck. Seal photograph by Christopher von Nagy and drawing by Áyax Moreno.

List of Tables

San Andrés Units 1, 7 and 8 – Peat zone and Feature 18									
Types	Forms							V	Proportion of total vessel count by type
	II	III	If	IIv	Iz	li	V		
ER	7	1	0	0	1	1	0	0	30%
DBW	14	1	0	1	0	0	0	0	20%
NBW	1	0	0	0	0	0	0	1	10%
TB	0	0	0	0	0	0	0	1	10%
BU	23	0	0	1	0	0	0	0	10%
EP	8	0	0	0	0	0	0	0	0%
PB	1	0	0	0	0	0	0	0	0%
SIB	10	0	0	0	0	0	0	0	0%
FST	51	0	2	0	0	0	0	0	20%
MST	49	0	0	0	0	0	0	0	0%
VAT	4	0	0	0	0	0	0	0	0%

Proportion of total vessel count by form							
II	20%	20%	20%	10%	10%	10%	10%

Total vessels:	10
Total sherds:	178

Table 1: Table describing a combined Molina complex ceramic assemblage from deposits interfingered with estuary margin and backlevee marsh peats underlying the Barí paleodistributary in Units 1, 7 and 8 and from Feature 18, Unit 1 (see [Figures 6, 7, 8, and 9](#)). Vessel count is a minimum number of vessels based on a rim sherd count after exhausting refitting possibilities. The left most column represents body sherd or unidentifiable rim sherd counts for each type. *Types*: ER Estero Red, DBW Desengaño Black-and-white, NBW Naranjeño Black-and-white, TB Tocayo Black, BU Bronze Unslipped, EP Estero Plain, PB Pejelagartero Black, SIB San Isidro Brushed, FST unspecified eroded fine sand-tempered, MST unspecified eroded medium sand-tempered, VAT unspecified eroded volcanic ash-tempered. The latter three categories are for otherwise unclassifiable sherds. *Forms* (in order of commonality): II an unspecified dish, III unspecified jar or tecomate, If a tecomate with a direct rim and generally rounded lip, IIv a flat base dish with flared walls and exterior thickened rims, Iz a tecomate with interior thickened rim and exterior beveled lip, li a tecomate with a direct rim and flat lip, V an unspecified vase form.

San Andrés Unit 1 Tan Brown stratum (Barí levee)																
Types	Forms															Proportion of total vessel count by type
	Im	IIc	IIv	If	II	III	IIIh	IIIc	IIj	I	IIlb	IIbl	IIld	Id	Ik	
BU	264	4	2	0	0	3	1	2	2	2	1	0	0	0	0	39.5%
NBW	34	0	3	0	0	0	1	0	0	0	0	0	1	0	0	11.6%
EU	28	2	0	0	3	0	0	0	0	0	0	0	0	0	0	11.6%
JB	6	1	0	0	0	0	0	0	0	0	0	0	0	0	0	2.3%
SIB	6	0	0	0	0	0	0	0	0	0	0	0	0	0	0	0.0%
DBW	6	0	0	0	0	0	1	0	0	0	0	0	0	1	0	4.7%
BW	1	0	0	0	0	0	0	0	0	0	0	0	0	0	0	0.0%
GP	1	0	0	3	0	0	0	0	0	0	0	0	0	0	1	9.3%
JBa	0	1	0	0	0	0	0	0	0	0	0	0	0	0	0	2.3%
JR	0	0	1	0	0	0	0	0	0	0	0	0	0	0	0	2.3%
AI	0	0	0	0	0	0	0	0	0	0	0	0	1	0	0	2.3%
Gpl	0	2	0	1	0	0	0	0	0	0	0	0	0	0	0	7.0%
FBW	0	0	0	0	0	0	0	1	0	0	0	0	0	0	0	2.3%
SI	0	0	1	0	0	0	0	0	0	0	0	0	0	0	0	2.3%
TI	0	0	0	0	1	0	0	0	0	0	0	0	0	0	0	2.3%
MST	25	0	0	0	0	0	0	0	0	0	0	0	0	0	0	0.0%
<div style="display: flex; justify-content: space-between;"> 23% 16% 9% 9% 7% 7% 7% 5% 5% 2% 0% 2% 2% 2% 2% Proportion of total vessels by form </div>																

Total vessels: 43
Total sherds: 414

Table 2: Table describing a typical Early Puente complex ceramic assemblage from deposits interfingered within Barí paleodistributary levee silts (Tan Brown stratum) in Unit 1 (see [Figure 7](#) for Unit 1 stratigraphy and von Nagy (2003) for a discussion of the regional Early Puente complex). *Types*: BU Bronze Unslipped, NBW Naranjeño Black-and-white, EU Eden Unslipped, JB Juliero Bossed, SIB San Isidro Brushed, DBW Desengaño Black-and-white, BW Blasillo White, GP Gogal Plain, JBa Juliero Bossed, appliqué variety, JR Joventud Red (probably intrusive), AI Acan Incised, Gpl Golpe Incised, FBW La Florida Black-and-white, SI Santuario Incised, TI Tonalá Incised, MST unspecified eroded medium sand-tempered. *Forms*: (in order of commonality): Im a tecomate with interior thickened rim, IIc a flat-based dish with outcurved wall and a direct rim, IIv a flat-based dish with a flared wall and a exterior thickened rim, If a tecomate with a direct rim, II unspecified dishes, III unspecified jars, IIIh a jar or collared tecomate with a short, outflared rim, IIIc a jar or collared tecomate with an outcurved rim, IIj a flat-based, concave dish, I unspecified tecomates, IIlb a jar with a short spool-like neck, IIbl a concave dish or bowl with an interior thickened rim, IIld a flat-based dish with a flared wall and direct rim, Id a bowl or dish with a slightly incurved wall, and Ik a tecomate with an inslanting collar. Form IIIc *ollas* are probably derived from overlying cultural deposits, as is the single example of a Desengaño Black-and-white bowl with an incurved wall.

San Andrés Unit 3 Dark Grey Clay stratum (levels 9 – 10)

Types	Forms											Proportion of vessels by type	
	llc	lbo	llh	lbq	ld	lllb	llle	llli	lld	lk	lm		
GI	0	0	0	0	0	1	1	0	0	1	1	0	16%
DBW	60	0	3	0	1	0	0	0	0	0	0	0	16%
TI	5	2	0	0	0	1	0	0	0	0	0	0	12%
NBW	11	0	0	2	1	0	0	0	0	0	0	0	12%
EU	2	0	0	0	0	0	0	0	0	0	0	1	4%
AF	1	0	0	0	0	0	0	0	0	0	0	0	0%
GP	62	0	0	0	0	0	0	0	0	0	0	0	0%
FW	1	0	0	0	0	0	0	0	0	0	0	0	0%
JR	3	0	0	0	0	0	0	0	0	0	0	0	0%
BU	4	0	0	0	0	0	0	0	0	0	0	0	0%
VAT	65	6	2	0	0	0	0	0	0	0	0	0	32%
FST	259	0	0	0	0	0	0	1	1	0	0	0	8%

32% 20% 8% 8% 8% 4% 4% 4% 4% 4% 4%

Proportion of vessels by form

Total vessels: 25
Total sherds: 498

Table 3: Table describing a typical Late Puente complex ceramic assemblage from levels 9 – 10, Unit 3, a midden of household debris with numerous fragments of burnt bone, charcoal, figurine fragments, and a whistle. [Figure 8](#) depicts Unit 3 stratigraphy. *Types*: GI Guapacal Incised, DBW Desengaño Black-and-white, TI Tecolutla Incised, NBW Naranjeño Black-and-white, EU Eden Unslipped, AF Acan Fluted, GP Gogal Plain, FW unspecified Flores Waxy ware, JR Joventud Red, BU Bronze Unslipped, VAT unspecified volcanic ash-tempered, FST unspecified fine sand-tempered. *Forms*: llc a flat-based dish with an outcurved wall and direct rim, lbo a tecomate or restricted bowl with an inset convex rim, llh a flat-based dish with a flared and a slightly everted and interior beveled rim, lbq a tecomate or restricted bowl with an outcurved rim, ld a simple restricted bowl or dish with an incurved side and a slightly rounded base, lllb a jar with short spool-like, outcurved rim, llle a jar with a tall outcurved rim, llli a jar or collared tecomate with a short, inslanted rim, lld a simple flat-based dish with a flared side, lk a collared tecomate or bowl similar to form llli jars, and lm a tecomate with an interior thickened rim.

San Andrés Unit 8 – Pottery Bed (levels 7 – 10)																													
Types	Forms																												
	Id	III	IIIe	IIey	VII	II	IIb	IIc	IIIb	VIIe	IIft	Ia	IIay	IIm	IIw	Io	IIaa	IIbh	IIc	IItz	IIga	IIj	IIq	IIr	IV	Ibo	Vc	VId	
TI	8	12	0	0	15	14	0	6	3	0	0	0	0	0	0	0	0	0	0	0	0	0	0	0	0	0	0	0	32%
GP	111	0	7	19	0	0	0	0	0	2	3	0	0	0	0	0	0	0	0	0	0	0	0	0	0	0	0	0	21%
DBW	1	1	15	0	3	0	5	1	3	0	0	0	0	0	1	2	0	0	0	0	0	0	0	0	0	0	0	0	21%
TB	0	11	0	0	0	0	0	0	0	0	0	0	0	0	0	0	0	0	0	0	0	0	0	0	0	0	1	0	8%
AI	39	0	0	0	0	0	0	0	0	2	0	0	2	0	0	0	2	0	0	0	0	0	0	0	0	0	0	0	4%
FW	5	0	0	0	0	0	0	0	0	0	0	0	0	0	0	0	1	1	1	0	0	0	1	1	0	0	0	0	3%
MI	2	2	0	0	0	0	0	0	0	0	0	0	0	0	0	0	0	0	0	0	1	0	0	0	0	0	0	0	2%
uTB	0	0	0	0	0	0	3	0	0	0	0	0	0	0	0	0	0	0	0	0	0	0	0	0	0	0	0	0	2%
TMI	0	0	0	0	0	0	0	0	0	0	3	0	0	0	0	0	0	0	0	0	0	0	0	0	0	0	0	0	2%
MZI	2	0	0	0	0	0	0	0	1	0	0	0	0	0	0	0	0	0	0	0	0	0	0	0	0	0	1	0	1%
NBW	2	0	0	0	0	0	0	0	0	0	0	0	2	0	0	0	0	0	0	0	0	0	0	0	0	0	0	0	1%
TC	0	0	0	0	0	0	0	0	0	0	0	1	0	0	0	0	0	0	0	0	0	0	0	0	0	0	0	0	1%
PW	0	0	0	0	0	0	0	0	0	0	0	0	1	0	0	0	0	0	0	0	0	0	0	0	0	0	0	0	1%
FC	0	0	0	0	0	0	0	0	0	0	0	0	0	0	0	0	0	0	0	0	0	0	0	0	0	0	0	1	1%
SAI	0	0	0	0	0	0	0	0	0	0	1	0	0	0	0	0	0	0	0	0	0	0	0	0	0	0	0	0	1%
PI	0	0	0	0	0	0	0	0	0	0	0	0	0	0	0	0	0	0	0	0	0	1	0	0	0	0	0	0	1%
SAT	16	0	0	0	0	0	0	0	0	0	0	0	0	0	0	0	0	0	0	0	0	0	0	0	0	0	0	0	0%
FST	920	0	0	0	0	0	0	0	0	0	0	0	0	0	0	0	0	0	0	0	0	0	0	0	0	0	0	0	0%
VAT	184	0	0	0	0	0	0	0	0	0	0	0	0	0	0	0	0	0	0	0	0	0	0	0	0	0	0	0	0%
<div style="display: flex; justify-content: space-between;"> 17% 14% 12% 12% 9% 5% 5% 5% 3% 3% 2% 2% 1% 1% 1% 1% 1% 1% 1% 1% 1% 1% 1% 1% 1% 1% 1% 1% Proportion of vessels by form </div>																													

Total vessels: 155
Total sherds: 1445

Table 4: Table describing a typical Early Franco complex ceramic assemblage from the sherd pavement in levels 7–10, Unit 8 (shown in [Figure 9](#)), a pavement of largely reburned large sherds and partial vessels. *Types*: TI Tecolotla Incised, GP Gogal Plain, DBW Desengaño Black-and-white, TB Tancochapa Black, AI Acan Incised, FW unspecified Flores Waxy, MI Mecatepec Incised, uTB unspecified Tancochapa Black, TMI Tecolotla Modeled-incised, MZI Mecatepec Zoned-incised, NBW Naranjeño Black-and-white, TC Tecolotla Chamfered, PW Palma White, FC Fernando Coarse, SAI San Antonio Incised, PI Pajalal Incised, SAT San Antonio Thick, FST unspecified fine sand-tempered, VAT unspecified volcanic ash tempered. *Forms*: Id a simple bowl, III unspecified jars, IIIe a jar with a tall outcurved rim, IIey a flat-based dish with an outcurved wall and an interior beveled rim, VII unspecified urn fragments, II unspecified dishes, IIb a flat-based dish with an outflared wall and a slightly interior beveled rim, IIc a flat-based dish with an outflared wall and direct rim, IIIb a jar with an outcurved, spool-like neck and direct rim, VIIe a very large urn with an exterior reinforcing triangular bolster on the rim, IIft a flat-based dish with a flared wall and a widely flared rim, Ia a tecomate with an inslanted collared rim, IIay a shallow flat-based plate with an outflared wall, IIm a thick-walled bowl with a flattened base, nearly vertical sides and an exterior-bolstered rim, IIw a concave base dish with slightly outflared sides and a direct rim, Io a restricted bowl or tecomate with a pinched collared rim, IIaa a flat-based dish with an outcurved wall and a rounded exterior bolster on the rim, IIbh a flat-based dish with an

outcurved wall and slightly interior beveled rim, Ilc a flat-based dish with an outcurved wall and an exterior everted rim, Ilfz an open bowl with a concave, outcurved rim, Ilga a dish with a somewhat rounded base dish, short vertical wall and pinched rim, Ilj an open hemispheric bowl, Ilq a dish or bowl with a slightly flared wall and slightly exterior everted rim, Ilt a flat-based dish with an outflared wall and an exterior bolstered and beveled rim, IV a possible bottle, Ibo a restricted bowl with an inset convex rim, Vc a barrel-shaped vase, and VI d a comal with a slightly upturned rim.

San Andrés Unit 1 Feature 3a																						
Types	Forms																					
	III	IIIc	Id	II	Im	IIbn	IIbp	IIc	IIld	IIby	Ic	Id Ilo	IIld	IIle	IIac	IIbd	IIf	IIfe	IIls	Iam		
GP	830	6	22	4	0	3	0	0	0	1	0	1	0	0	1	0	0	0	0	0	32%	
EP	3	15	4	2	4	0	1	0	0	0	0	0	0	0	0	1	1	1	0	0	25%	
TB	55	0	0	3	2	0	1	3	0	0	0	0	0	0	0	0	0	0	0	1	1	9%
EBW	87	8	0	0	0	0	0	0	0	0	0	0	0	0	0	0	0	0	0	0	7%	
MI	1	0	0	3	0	0	0	0	0	0	0	0	1	0	0	0	0	0	0	0	3%	
EU	37	1	0	0	0	1	0	0	0	0	0	0	0	0	0	0	0	0	0	0	2%	
TI	0	0	0	2	0	0	0	0	0	0	0	0	0	0	0	0	0	0	0	0	2%	
MF	0	0	0	1	0	0	0	0	0	0	0	0	1	0	0	0	0	0	0	0	2%	
MZI	1	0	0	0	0	0	0	0	0	0	0	0	0	0	0	0	0	0	1	0	1%	
Gpl	0	0	0	0	0	0	0	0	1	0	0	0	0	0	0	0	0	0	0	0	1%	
JR	0	0	0	0	0	0	0	0	0	1	0	0	0	0	0	0	0	0	0	0	1%	
DBW	0	0	0	0	0	0	0	0	0	0	0	0	1	0	0	0	0	0	0	0	1%	
AI	0	0	0	0	0	0	0	0	0	1	0	0	0	0	0	0	0	0	0	0	1%	
EI	0	0	0	0	0	0	1	0	0	0	0	0	0	0	0	0	0	0	0	0	1%	
NBW	11	0	0	0	0	0	0	0	0	0	0	0	0	0	0	0	0	0	0	0	0%	
FW	1	0	0	0	0	0	0	0	0	0	0	0	0	0	0	0	0	0	0	0	0%	
JB	1	0	0	0	0	0	0	0	0	0	0	0	0	0	0	0	0	0	0	0	0%	
VAT	50	0	0	9	1	0	0	0	2	1	1	1	0	0	0	0	0	0	0	0	13%	
MST	10	0	0	0	0	0	0	0	0	0	0	0	0	0	0	0	0	0	0	0	0%	
<div style="display: flex; justify-content: space-between;"> 26% 22% 21% 6% 3% 3% 3% 3% 3% 2% 2% 2% 1% 1% 1% 1% 1% 1% 1% 1% Proportion of vessels by form </div>																						

Total vessels: 117
 Total sherds: 1204

Table 5: Table describing a typical Late Franco complex ceramic assemblage from Feature 3a, Unit 1, a trash filled pit (see [Figures 6 and 7](#)). *Types*: GP Gogal Plain, EP Encrucijada Plain, TB Tancochapa Black, EBW Encrucijada Black-and-white, MI Mecatepec Incised, EU Eden Unslipped, TI Tecolutla Incised, MF Mecatepec Fluted, MZI Mecatepec Zoned-incised, Gpl Golpe Incised, JR Joventud Red, DBW Desengaño Black-and-white, AI Acan Incised, EI Encrucijada Incised, NBW Naranjeño Black-and-white, FW unspecified Flores Waxy ware, JB Juliero Bossed, VAT unspecified volcanic ash-tempered, MST unspecified medium sand-tempered. *Forms*: III unspecified jars, IIIc a jar with a short, outcurved neck and direct rim, Id a simple bowl with incurved sides, II unspecified dishes, Im in-mixed tecomates with interior thickend rims (Juliero Bossed tecomates are from Early Puente fill material

sources), Iln a flared composite-silhouette dish or plate, Ibp a saddle-rimmed bowl, Ilc a flat-based dish with an outcurved wall and a direct rim, Ild a flat-based dish with a flared wall and a direct rim, Ilby a flat-based dish with a flared wall and an everted and down-turned rim, Ic a simple restricted bowl with lug handles, Id a simple restricted bowl with an incurved side, Ilo a dish or bowl with a rounded base, slightly incurved wall and direct rim, Ild a cuspidor-like jar with tall spool-like rims, Ille a jar with a tall, gently outcurved neck and direct rim, Ilac a jar or bowl with outcurved rim, Ilbd a bowl or deep dish with a heavy, triangular exterior-bolstered rim, Ilf a composite-silhouette dish, Ilfe a bowl or dish with a vertical, slightly barrel-like wall and tapered rim, IIs a flat-based bowl with a widely flared wall and in-flared, direct rim, Iam a slightly restricted, hemispheric bowl with a tapered, direct rim and double circumferential fillets on the exterior below the rim. Filleting is a common Late Franco complex decorative technique.

Sources Cited

Andrews, E. Wyllys, V.

1986 Olmec Jades from Chacsinkin, Yucatan, and Maya Ceramics from La Venta, Tabasco. In *Research and Reflections in Archaeology and History: Essays in Honor of Doris Stone*, edited by E. Wyllys Andrews V, number 57 in Middle American Research Institute Publication, pp. 11–49. Middle American Research Institute, Tulane University, New Orleans.

Blake, Michael, John E. Clark, Barbara Voorhies, George Michaels, Michael W. Love, Mary E. Pye, Arthur A. Demarest, and Barbara Arroyo

1995 Radiocarbon Chronology for the Late Archaic and Formative Periods on the Pacific Coast of Southern Mesoamerica. *Ancient Mesoamerica* 6:161–183.

Bronk Ramsey, C.

1994 Analysis of Chronological Information and Radiocarbon Calibration: The Program OxCal. *Archaeological Computing Newsletter* 41:11–16.

Bronk Ramsey, C.

1995 Radiocarbon Calibration and Analysis of Stratigraphy: The OxCal Program. Radiocarbon.

Coe, Michael D. and Richard A. Diehl

1980 *In the Land of the Olmec. The People of the River*. The University of Texas Press, Austin.

Drucker, Phillip, Robert F. Heizer, and Robert J. Squier

- 1959 *Excavations at La Venta, Tabasco, 1955.*, volume 170. Bureau of American Ethnology, Smithsonian Institution, Washington D.C.
- Freidel, David, Linda Schele, and Joy Parker
1993 *Maya Cosmos Three Thousand Years in the Shaman's Path.* William Morrow, New York.
- González Lauck, Rebecca B.
1988 Proyecto Arqueológico La Venta. *Arqueología* 4:121–166.
- González Lauck, Rebecca B.
1990 *The 1984 archaeological investigations at La Venta, Tabasco, Mexico.* Ph.D. thesis, Department of Anthropology, University of California, Berkeley, Berkeley.
- González Lauck, Rebecca B.
1996 La Venta: An Olmec Capital. In *Olmec Art of Ancient Mexico*, edited by Elizabeth P. Benson and Beatriz de la Fuente, pp. 73–81. National Gallery of Art.
- González Lauck, Rebecca B.
1997 Acerca de Pirámides de Tierra y Seres Sobrenaturales: Observaciones Preliminares en Torno al Edificio C-1, La Venta, Tabasco. *Arqueología* 17:79–97.
- Hallinan, P. S., R. D. Ambros, and J. F. O'Connell
1968 La Venta Ceramics, 1968. Appendix I to the 1968 Investigations at La Venta. In *The 1968 Investigations at La Venta*, number 5 in Contributions of the University of California Archaeological Research Facility. University of California, Berkeley, Berkeley.
- Heizer, Robert F., John A. Graham, and Lewis K. Napton
1968 The 1968 Investigations at La Venta. *Contributions of the University of California Archaeological Research Facility* 5:127–205.
- Lee, Thomas A., Jr.
1974 The Middle Grijalva Regional Chronology and Ceramic Relationships: A Preliminary Report. In *Mesoamerican Archaeology: New Approaches*, edited by Norman Hammond, pp. 1– 20. Duckworth, London.
- Niederberger, Christina
1987 *Paléopaysages et Archéologie Pre-Urbaine du Bassin de Mexico.* Centro D'Etudes Méxicaines et Centroaméricaines: Etudes Mesoaméricaines II, Mexico City.

- Pohl, Mary E. D., Kevin O. Pope, and Christopher L. von Nagy
2002 Olmec Origins of Mesoamerican Writing and Calendrics. *Science* 298(5600):1984–1987.
- Pope, Kevin O., Mary E. D. Pohl, John G. Jones, David L. Lentz, Christopher L. von Nagy, Francisco J. Vega, and Irv Quitmeyer
2001 Origin and Environmental Setting of Ancient Agriculture in the Lowlands of Mesoamerica. *Science* 292(5520):1370–1373.
- Rust, William F., III and Robert J. Sharer
1988 Olmec Settlement Data from La Venta, Tabasco, Mexico. *Science* 242:102–104.
- Sisson, Edward B.
1970 Settlement Patterns and Land Use in the Northwestern Chontalpa, Tabasco, Mexico: Progress Report. *Cerámica de la cultura Maya* 6:41–54.
- Sisson, Edward B.
1976 *Archaeological Survey of the Chontalpa Region, Tabasco, Mexico*. Ph.D. thesis, Department of Anthropology, Harvard University, Cambridge.
- Squier, Robert J.
1964 *A Reappraisal of Olmec Chronology*. Ph.D. thesis, Department of Anthropology, University of California, Berkeley, Berkeley.
- Symonds, Stacy, Ann Cyphers, and Roberto Lunagómez, eds.
2002 *Asentamiento Prehispánico en San Lorenzo Tenochtitlán*. Universidad Nacional Autónoma de México. Instituto de Investigaciones Antropológicas, Mexico City.
- von Nagy, Christopher L.
2003 *Of Meandering Rivers and Shifting Towns: Landscape Evolution and Community within the Grijalva Delta, Tabasco, Mexico*. Ph.D. thesis, Department of Anthropology, Tulane University, New Orleans.
- von Nagy, Christopher L., Mary D. Pohl, Kevin Pope, Joanne Harrison, and Jennifer Thomason
1998 New Data on Rural Pottery Systems from the La Venta Periphery. Paper presented at the 63rd annual meeting, Society for American Archaeology, Seattle.
- von Nagy, Christopher L., Mary E. D. Pohl, and Kevin O. Pope

2000 Perspectives on the Olmec Elite, Archaeological Research at San Andrés, Tabasco, Mexico. Paper presented at the 99th meeting of the American Anthropological Association.

von Nagy, Christopher L., Mary E. D. Pohl, and Kevin O. Pope
2002 Ceramic Chronology of the La Venta Olmec Polity: The View from San Andrés, Tabasco. Paper presented at the 67th meeting of the Society for American Archaeology under revision for publication.