

CONCEPT AND IMPLEMENTATION OF THE SC CAVITY RESONANCE FREQUENCY MONITOR FOR THE DIGITAL RF FIELD CONTROLLER

W. Jalmuzna, A. Napieralski, DMCS, Lodz, Poland
S. Simrock, DESY, Hamburg, Germany

Abstract

The new generations of digital control systems offer large number of computation resources along with precise ADCs (analog to digital converters) and DACs (digital to analog converters), which can be used to generate almost any klystron driving signal. This functional design creates the possibility to implement such features as digital SEL (self excited loop) and frequency sweep mode. They can be used to monitor resonance frequency of SC cavities, which enables to obtain information required in the process of system tuning. The following result is the capability to adjust cavity tuner settings. Such functionality is valuable especially during the first RF station start up when the cavities may be detuned even by a large frequency. The paper presents the concept of such system and summarizes implementation and tests performed at FLASH facility (DESY, Hamburg).

INTRODUCTION

The European X-Ray Laser facility, which is currently under construction, will be capable of generating 100 femtosecond light pulses with wavelengths below 1 nm. The main part of the laser is 2.1 km long superconducting linear accelerator consisting of 26 RF stations. Total number of over 100 accelerating modules will be installed, with the planned beam energy of 20 GeV.

The accelerating module comprises 8 1.3 GHz superconducting cavities. After the module is manufactured, each cavity needs to be tuned to its nominal resonance frequency by means of cavity tuners. This process requires a driving cavity with user-generated control signals or expensive network analyzers and, also, is highly time-consuming. For such expanded, sizeable facility as XFEL a more effective method needs to be proposed.

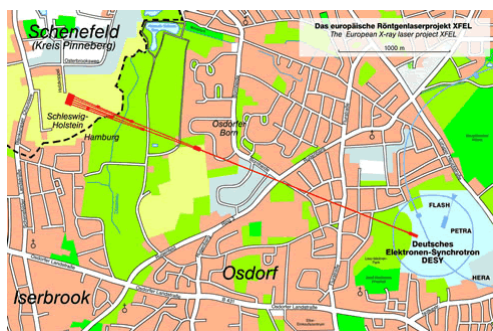

Figure 1: The XFEL facility location.

DIGITAL FIELD CONTROLLER

The new generation of the LLRF control system is based on FPGA chips [1]. Optimized for parallel calculations and peripheral handling, FPGA chips outrank traditional DSP processors in terms of available computation power and latency of data processing [2]. The resources available in FPGA chip can easily accommodate basic control algorithm presented in Fig. 2. Moreover large number of resources makes the future updates of the algorithms possible. They can be extended by additional computation modules or even microprocessor based embedded system requiring no need for any hardware changes [3]. The prototype implementation of the FPGA based RF field controller was installed and tested at FLASH (Free Electron Laser in Hamburg) [4]. It became the base for the XFEL controller extended by additional frequency monitoring modules [1].

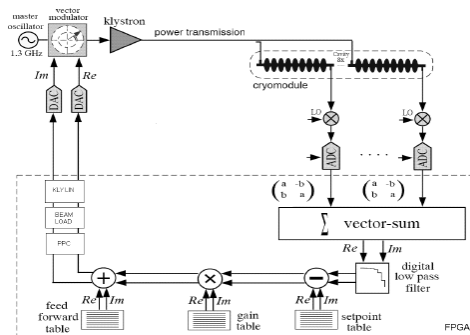

Figure 2: The basic algorithm executed by digital controller.

FREQUENCY SWEEP MODE

The Frequency Sweep control secures the mode of the controller operation, which allows to shift the frequency of the signal generated by the klystron - the RF field source for the cavities. This feature allows to measure the cavity response for the step signal with different frequencies. The measurement can be subsequently used to find resonance frequency of the cavity and to estimate its resonance curve [5]. As well as that, the acquired information may later serve the purpose of the cavity tuning optimization.

The klystron frequency shift is achieved by the slope generation on the phase of the control signal. The basic version of the module is based on the custom feed-forward table generation implemented in the control system. This

approach poses certain limitations on the resolution and scanned frequency range caused by low controller's output update frequency (default 1 MHz). The module has been modified to increase the frequency without an extra need of memory space enhancement for the control tables. The current structure is shown in Fig. 4. The internal counter is used to generate slope on the signal's phase with the clock up to 20 MHz. Fig. 3 shows the simulated frequency spectrum of the klystron output for different output update frequencies. The sidebands in the spectrum of generated signal are increasing together with the frequency offset. This is compensated by the rise in the output update frequency. During the initial tests of the module, the frequency sweep was performed in the injector (ACC1) of the FLASH facility with the cavity 6 detuned from the initial tuning by 2 kHz. The results are presented in Fig. 5 and Fig. 6.

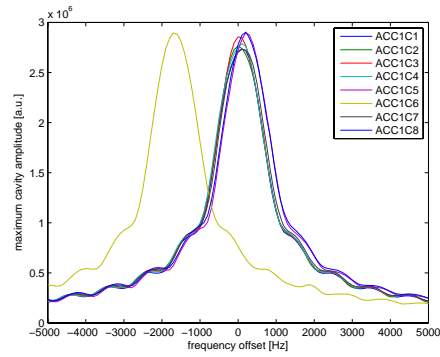

Figure 6: Results of the frequency sweep performed at ACC1 - cavity 6 detuned.

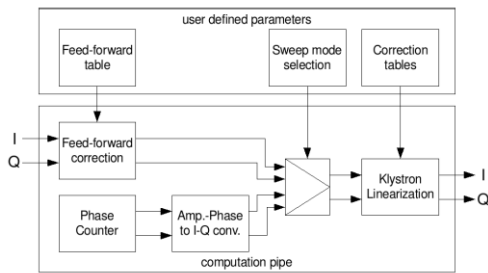

Figure 4: Structure of the Frequency Sweep modules.

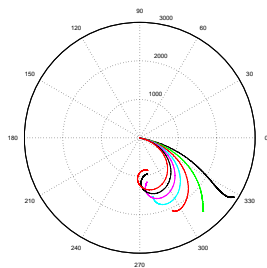

Figure 5: Cavity response for the sweep signal in range 0-700 Hz (polar coordinates).

SELF EXCITED LOOP MODE

The Self Excited Loop mode of operation allows to load the cavity to the nominal gradient, even if it is detuned by several bandwidths in respect to the klystron frequency. The loop phase is adjusted to convert the negative feedback loop into a positive one. When the cavity is locked into SEL, the klystron frequency is tracking cavity resonance frequency [5]. In order to limit the gradient of the field in the cavity, special amplitude limiter on output signal has been implemented. The structure of the SEL subsystem is presented in Fig. 7.

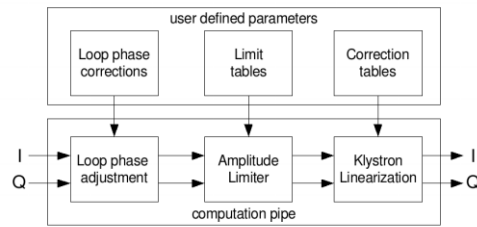

Figure 7: Structure of the SEL modules.

To speed up the SEL start-up, for large cavity detunings, the seeding signal must be used. It is also possible to combine Frequency Sweep Mode with SEL to generate a seeding signal with the frequency closer to the cavity resonance. The control signal and the cavity-field signal for SEL operation is presented in Fig. 8 and Fig. 9. The SEL mode allowed to load the cavity even within periods of cavity detuning by several bandwidths. At the initial stage of the filling, the arbitrary seed signal is visible on the forward power plot.

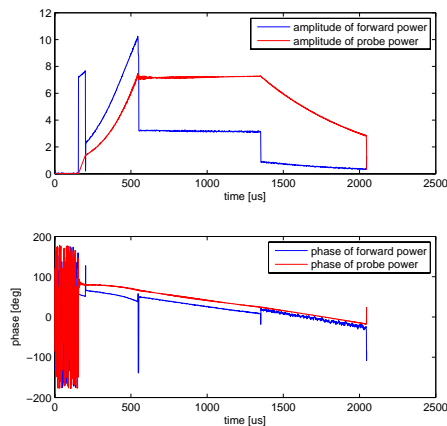

Figure 8: Cavity forward and probe signal in SEL mode - cavity tuned.

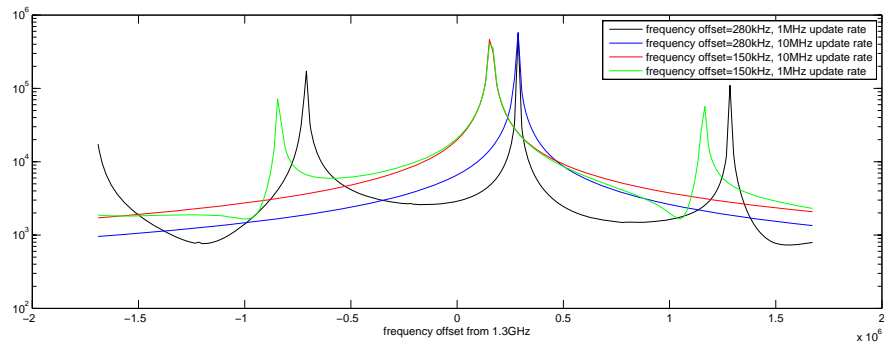

Figure 3: Simulated vector modulator frequency response for different sweep signals.

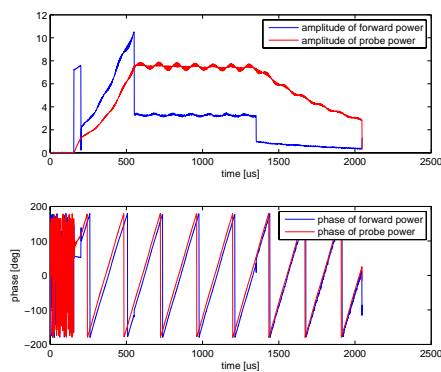

Figure 9: Cavity forward and probe signal in SEL mode - cavity detuned by 4.2 kHz.

- [5] S. Simrock, W. Cichalewski, M.K. Grecki, G.W. Jablonski, W. Jalmuzna, "Universal Controller for Digital RF Control", EPAC06, TUPCH190

SUMMARY

The tests performed at FLASH facility confirm the established presumption that the modules can be practically used to monitor current resonance frequency of the cavity within a great spectrum of frequencies. This allows to minimize the time required for the performance of a number of various tasks related to the resonance frequency change such as module conditioning, start-up of the machine, removal of the cavity from the beam pipe, and cavity behavior studies. The modules will become an optional part to be implemented in the RF field controller for XFEL.

REFERENCES

- [1] S.N. Simrock "Conceptual LLRF Design for the European XFEL", LINAC06, THP001
- [2] W. Jalmuzna: "Design and Implementation of Universal Mathematical Library Supporting Algorithm Development for FPGA Based Systems in High Energy Physics Experiments", TESLA note 2006-01, <http://tesla.desy.de>
- [3] W. Jalmuzna et al. "FPGA-based Implementation of a Cavity Field Controller for FLASH and X-FEL", 2007 Meas. Sci. Technol. 18 2365-2371 doi:10.1088/0957-0233/18/8/010
- [4] W. Jalmuzna et al. "FPGA Based Digital RF Control for FLASH", LINAC06, THP097