

EVALUATION OF THE MAX WIGGLER

G. LeBlanc, E. Wallén, MAX-lab, Lund

Abstract

The MAX wiggler [1] is a cold bore superconducting wiggler with 47 3.5 T poles and a period length of 61 mm constructed at MAX-lab. It has now been installed on the MAX-II [2] storage ring. This paper describes the performance of the cryostat and initial studies of the effects of the wiggler on the electron beam.

1 INTRODUCTION

The increasing demand for high fluxes of x-rays to perform crystallography and material physics at MAX-lab is being met with the MAX wiggler. Together with the 1.5 GeV electron beam of 200 mA in the MAX-II ring, a flux of approximately 2.3×10^{14} photons/sec/mrad/0.1% can be expected at the critical energy of 5.2 keV. The spectral flux from the MAX wiggler is shown in Figure 1. The MAX wiggler parameters are tabulated in Table 1.

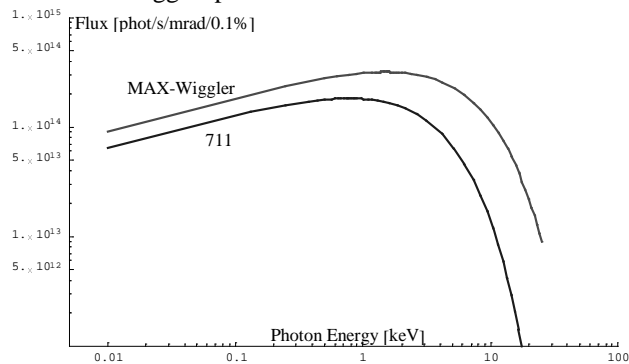

Figure 1: Spectral flux from the MAX wiggler compared to W711 (an existing wiggler on MAX-II).

Table 1: Parameter list of the MAX-Wiggler.

Wiggler period	61 mm
Vertical Aperture	10.2 mm
Horizontal Aperture	70 mm
Total Length of Magnetic Assemblies	1512 mm
Number of Full Size Poles	47
Total Number of Poles	49
Peak Field	3.54 T
Peak Field for End Poles	2.10 T
K, Deflection Parameter	21.2
Total emitted power, 200 mA current	5.0 kW

2 THE MAGNET

The magnet coils were trained prior to installation. Additional training was necessary after the magnet was installed in the ring. This is due to the fact some of the training is lost when the magnet is warmed up. The training cycle of the magnet after installation in the ring is shown in figure 2.

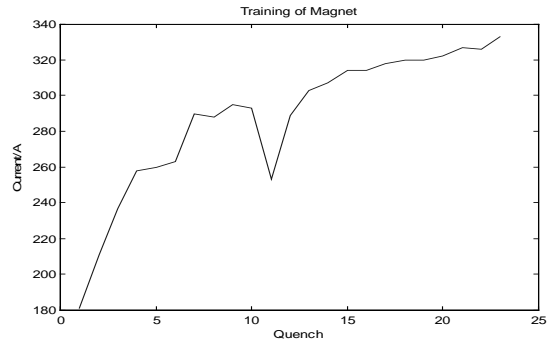

Figure 2: Training cycle of the MAX wiggler.

3 THE CRYOSTAT

The MAX wiggler cryostat is cooled by a liquid He bath. Figure 3 shows some of the details of the cryostat. The boiled-off He gas is used for cooling the accelerator vacuum tube between the cold bore and the rest of the ring, as well as the current leads. There is a thermal shield between the He vessel and the outer vacuum tank that is cooled using liquid nitrogen. The temperature levels that are monitored are indicated in figure 3. T1 is the temperature of the He gas as it leaves the tank. T3 and T5 are the two cooling points on the thin vacuum chamber between the 300 K and 4 K levels. T12 is at the warm end of the high temperature superconductors. T7 and T8 are on the thermal shield. The buffer volume in the He vessel is about 320 litres, which is sufficient for five days of operation. The He consumption with stored beam in the ring averages 2.5 l/hour. This corresponds to a heat load of 1.8 W. The heat load with no current in the ring is 1.5 l/h or 1.1 W. There is no observable increase in the He consumption with the wiggler at full field.

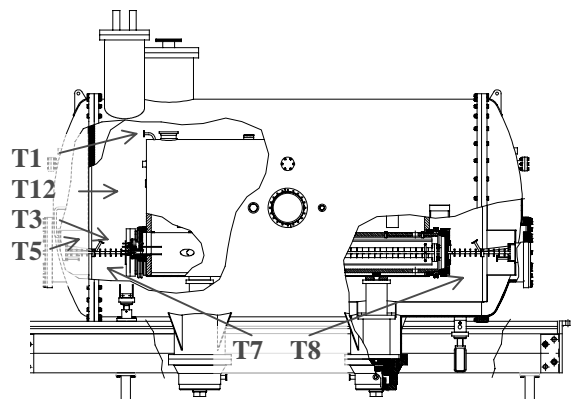

Figure 3: Drawing of the cryostat with temperature levels indicated.

Figure 4 is a plot of the temperature levels, the ring current, and the He level in the cryostat. The data was taken on a day when the cryostat was refilled.

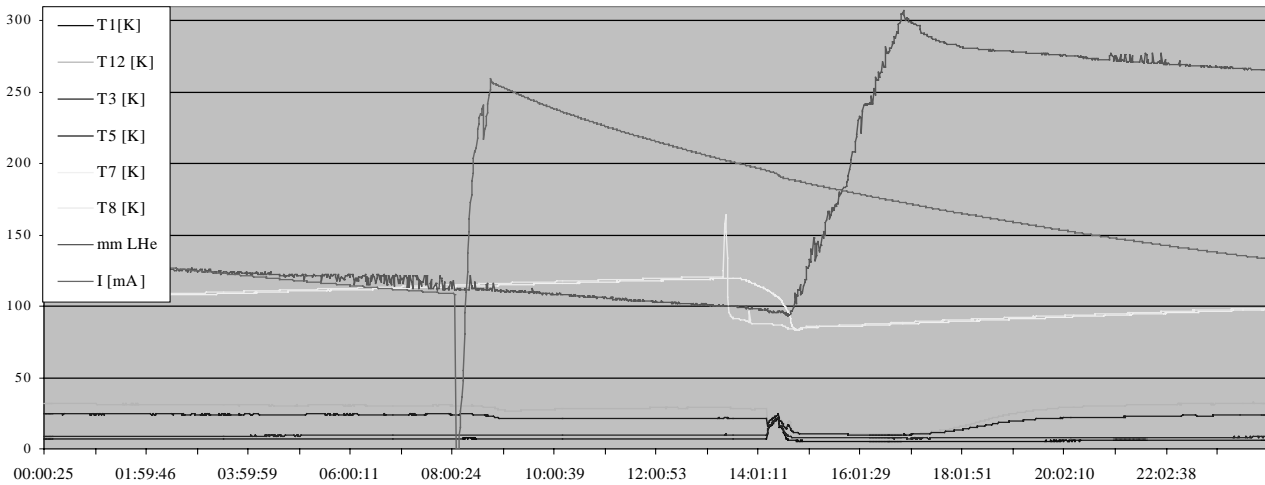

Figure 4: Cryostat temperatures, He level, and ring current for a 24 hour period.

4 EFFECTS ON RING PERFORMANCE

4.1 Cryo-pumping and Vacuum Effects

The cold bore is an effective cryo-pump. Even the vacuum tubes between the cold bore and the ring vacuum system are cryo-pumps, but due to the small mass, their temperature is more easily changed. When the flow of He gas in the cooling tubes on them is reduced, the temperature increases and the pumped gas is released. This results in a lifetime decrease. This can be seen in figure 4 at the start of the LHe filling. An increase in the flow of gas, such as occurs when beam is ramped in the ring, results in a temperature decrease.

4.2 Effects on the Beam

The effects of the magnet on the beam optics are being studied presently. Measurements have been made to determine the focusing properties of the wiggler field and corrections have been implemented as will be described in the next section.

5 RESPONSE MATRIX ANALYSIS

The effects of the wiggler on the electron beam have been studied using models calibrated with measured response matrices [3]. The main effect of the wiggler on the ring optics is the vertical focusing.

5.1 The MAX-II Response Matrix

The starting point for the analysis of the effects of the MAX wiggler on the beam optics was a response matrix measurement made on MAX-II with no insertion devices. A surface plot of the response matrix can be seen in figure 5. A model was calibrated and the machine functions calculated from this model can be seen in figure 6.

5.2 Wiggler Response Matrix

The wiggler can be ramped to the full field without correcting the optics, indicating that the effects on the optics are not too severe. The vertical focusing results in an increased coupling through the tunes, so whatever lifetime reduction that comes from the wiggler is compensated for. This fact made it possible to measure a new response without changing any of the quadrupoles. A surface plot of the difference between the response matrices is shown in figure 7, where it can clearly be seen that the effect of the wiggler is primarily in the vertical plane.

Using the model from the previous measurement, a new calibration was made where the only element that was varied in the model was a transfer matrix with decoupled focusing in the wiggler straight section. The resulting machine functions are shown in figure 8, where the effect of the wiggler can be seen primarily in the vertical betatron function.

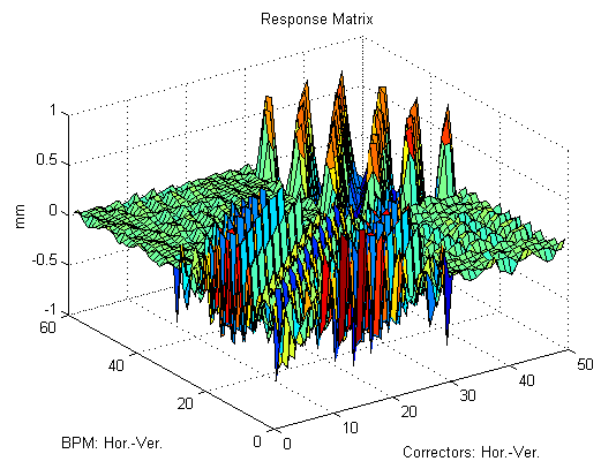

Figure 5: Measured response matrix.

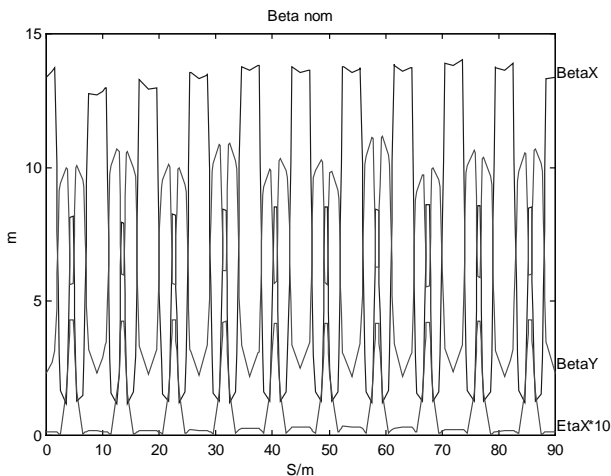

Figure 6: Machine functions from the calibrated model, no wiggler.

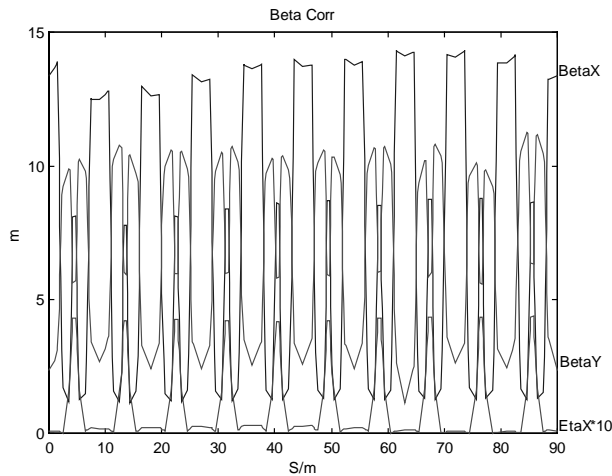

Figure 9: Machine functions from the calibrated model with wiggler and corrections.

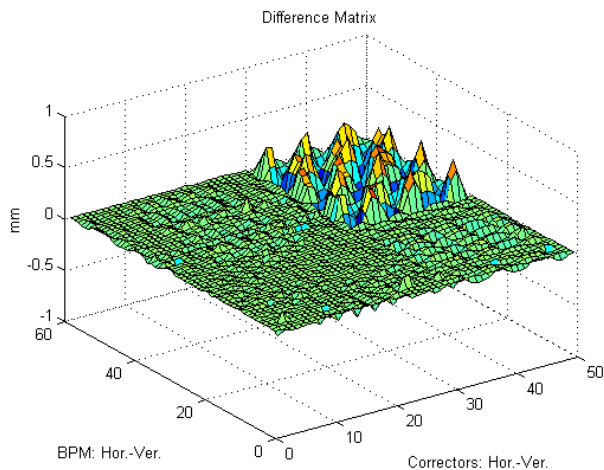

Figure 7: Difference in response matrix with wiggler.

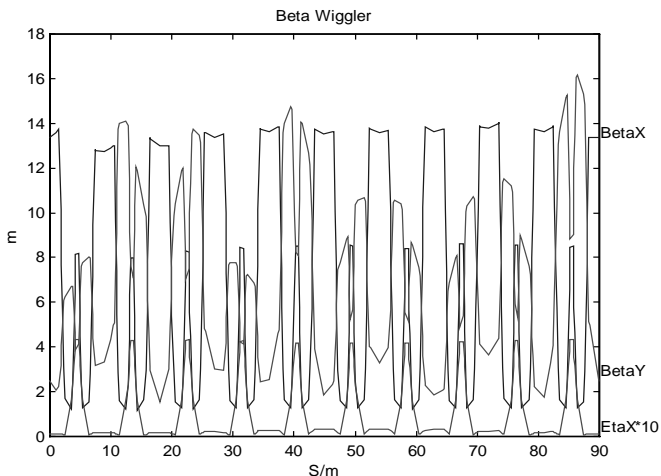

Figure 8: Machine functions from the calibrated model with wiggler.

5.3 Correction of the Optics

The correction scheme used is based on reducing the vertical beta function in the wiggler. This is accomplished with a separate power supply that can increase the strengths of the adjacent vertical quadrupoles. The adjacent horizontal quadrupoles are also fitted with extra power supplies in order to compensate for the extra focusing in the vertical quadrupoles. Since all of the changes so far have been increased focusing, an adjustment of the global tunes must be made by reducing the two quadrupole families.

These corrections were calculated using the calibrated model and then applied to the ring while the wiggler was at full current. A new response matrix was measured and a new model calibrated. The machine functions after correction are shown in figure 9, where it can be seen that this is an efficient method to correct machine optics.

6 CONCLUSIONS

The first MAX wiggler is installed. The cryostat is performing as expected. The effects of the wiggler on the stored beam can be corrected for. The second wiggler is now under construction.

REFERENCES

[1] G. LeBlanc, E. Wallén, M. Eriksson, "The MAX Wiggler", PAC2001, Chicago, IL, June 2001.
 [2] Å. Andersson et.al., 'The MAX II Synchrotron Radiation Storage Ring', Nucl. Instr. and Meth. A 343 (1994) 644-649.
 [3] J. Safranek, "Experimental determination of storage ring optics using response matrix measurement", Nucl. Instr. And Meth. In Phys. A, **388** (1997) 27.