

# FINAL SHAPING OF THE MAGNETIC STRUCTURE OF THE VINČA CYCLOTRON

S. B. Vorozhtsov, A. S. Vorozhtsov, Joint Institute for Nuclear Research, Dubna, Russia  
A. Dobrosavljević, P. Beličev, S. Čirković, A. Ilić, Đ. Košutić, N. Nešković, M. Rajčević,  
J. Ristić-Đurović, V. Vujović, Lj. Vukosavljević, Vinča Institute of Nuclear Sciences,  
Belgrade, Serbia and Montenegro

## Abstract

The test ion beams of the VINČA Cyclotron are the 65 MeV  $H^-$ , 30 MeV per nucleon  $H_2^+$ , 7 MeV per nucleon  $^4He^+$  and 3 MeV per nucleon  $^{40}Ar^{6+}$  beams. The final shaping of the magnetic structure of the machine has been undertaken to increase the transmission efficiency of the  $H^-$  ion beam, reduced substantially due to the effect of electromagnetic stripping. As a result, the new shapes of the sectors and plugs have been defined, using the 3D computer code MERMAID. The thickness of the sectors has been decreased by 8 mm and the gap between them increased to 36 mm. The results of measurements of the magnetic fields agree very well with the results of calculations in the whole acceleration region for all the main coils currents. We have also performed the preliminary ion beam dynamics analysis of the magnetic fields obtained for the four selected acceleration regimes.

## INTRODUCTION

Construction of the VINČA Cyclotron, the main part of the TESLA Accelerator Installation, in the Laboratory of Physics of the Vinča Institute of Nuclear Sciences, has been going on since 1992. The shimming of its magnet as well as all other activities were interrupted in 1998 as a result of the severe economic crisis in the country. After more than four years, at the end of 2002, the activities were resumed. We came back to the shimming of the magnet in the beginning of 2004, after completion of construction of the machine's vault. Since the initial plan of construction of the machine was changed slightly [1], we have modified the magnetic structure accordingly.

The machine is a multipurpose one, and, therefore, its magnetic structure has to provide the required magnetic fields for a number of operating points. The need to accelerate  $H^-$  ions up to 65 MeV with high transmission efficiency lead to a modification of the initially adopted shapes of the sectors and plugs (S5). The significant losses of  $H^-$  ions caused by the effect of electromagnetic stripping were reduced by increasing the gap between the sectors from 31 to 36 mm, resulting in a decrease of the magnetic flutter [2]. Obviously, the condition to be fulfilled was to preserve the axial ion beam focusing (the axial betatron frequency larger than 0) at the nominal extraction radius,  $R_{ex}$ . The influence of the increased gap on the magnetic field was compensated by increasing the main coils current.

The contributions of the trim coils required to achieve the isochronous magnetic field profiles for the four test ion beams with the modified shapes of the sectors and

plugs have been recalculated. Also, the impact of the modification on the four selected acceleration regimes has been estimated and the corresponding preliminary ion beam dynamics analysis has been performed. We have used the shimming approach applied earlier [3].

## MODIFICATIONS

Figures 1, 2 and 3 show the modifications of the shapes of the sectors and plugs. The calculations of the magnetic fields have been performed using the 3D computer code MERMAID while the magnetic fields have been measured using a specially designed magnetic field measurement system. In the first step we modified only the axial shape of the sectors (S6) while in the second step we modified the azimuthal shape of the sectors and introduced a new shape of the plug (S7). The gap between the sectors was increased to 36 mm. This may also help us cope with the possible increase of the axial ion beam envelope, caused by a weaker axial beam focusing. Furthermore, the larger gap made it easier to eliminate the depression of the magnetic field in the central region appearing for the S5 shapes of the sectors and plugs.

Table 1 gives the comparison of the parameters of the magnetic fields at  $R_{ex} = 84$  cm for the 65 MeV  $H^-$  ion beam for the S5 and S7 shapes of the sectors and plugs, and of the corresponding ion beam transmission efficiencies.

Table 1: The comparison of the S5 and S7 shapes of the sectors and plugs

Parameter at $R_{ex} = 84$ cm	S5	S7
Maximal magnetic induction	2.1084 T	2.0115 T
Magnetic flutter	0.235	0.167
Radial betatron frequency	1.050	1.075
Minimal axial betatron frequency	0.35	0.22
Ion beam transmission efficiency	~9 %	~36 %

## ACCELERATION REGIMES

As a consequence of the modification of the shapes of the sectors and plugs, the bending limit of the machine became 134 MeV (instead of 140 MeV for the S5 shapes). The nominal extraction radius ( $R_{ex}$ ) was changed from 86 to 84 cm. The parameters of the four selected acceleration regimes are given in Table 2.

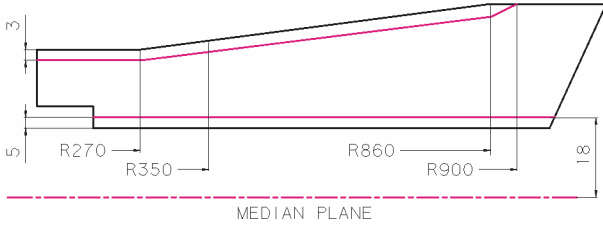
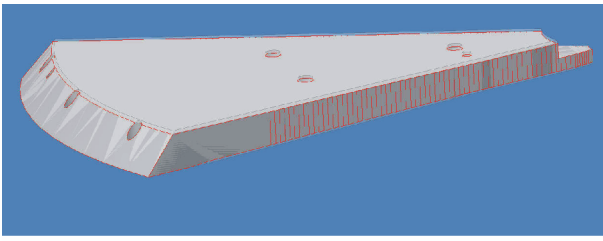

Figure 1: The S5 shape of the sector – black line, and the S6 shape – red line.

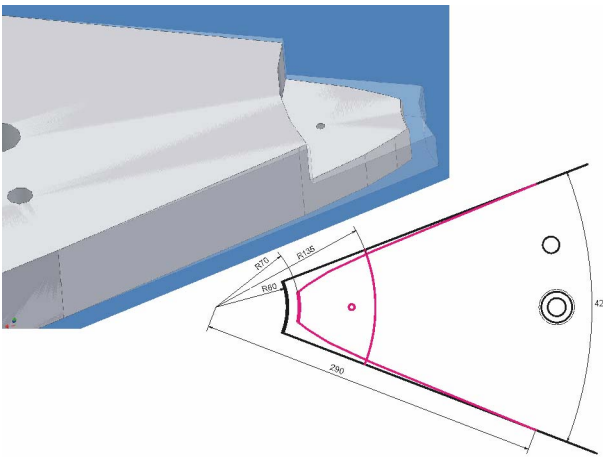

Figure 2: The S6 shape of the sector – black line, and the S7 shape – red line.

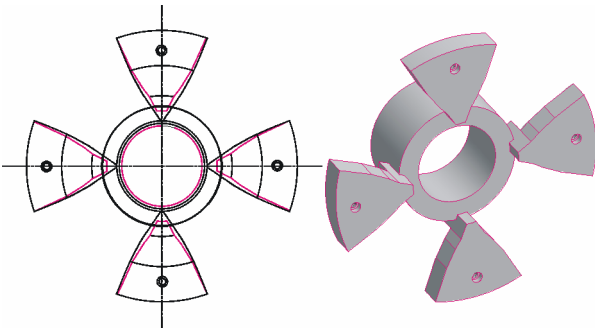

Figure 3: The S5 shape of the plug – black line, and the S7 shape – red line.

## OPERATING DIAGRAM

The operating points corresponding to the four test ion beams should be within the operating diagram of the machine. Apparently, the main coils currents are higher for the S7 shapes of the sectors and plugs than for the S5 shapes, due to a larger gap between the sectors and between the sectors and the median pole plates. As it can be seen from Table 2, the  $^{40}\text{Ar}^{6+}$  ion energy is close to the

bending limit, which is 134 MeV (for the main coils current of 1,000 A). Obviously, the focusing limit has also been decreased, from  $\sim 88$  MeV, for the S5 shapes of the sectors and plugs, to  $\sim 73$  MeV, for the S7 shapes. However, the maximal  $\text{H}^-$  ion energy is limited by the effect of electromagnetic stripping – to  $\sim 65$  MeV.

The required main coils currents were estimated using the central MERMAID model calibrated by the magnetic field measurements for the S5 shapes of the sectors and plugs, and the corresponding global MERMAID model [3].

Table 2: Four selected acceleration regimes

	$\text{H}^-$	$\text{H}_2^+$	$^4\text{He}^+$	$^{40}\text{Ar}^{6+}$
Main coils current, A	265	782	560	988
Magnetic induction at the center, T	1.316	1.838	1.800	1.969
Operating frequency, MHz	20.04	28.02	27.62	18.17
Harmonic number	1	2	4	4
Final ion energy, MeV per nucleon	65	30	7	3

## MAGNETIC FIELD MEASUREMENTS

### Measurement system

The magnetic field measurement system enables a fully automatic measurement of the magnetic field in the median plane of the machine. The diameter of the poles is 2,000 mm and the gap between the sectors is 36 mm. The measurement arm, made of titanium, turns around the central shaft mounted in the lower axial channel of the machine. The absolute encoder with the 15 bit resolution is mounted below the lower plug, in the lower axial channel, and it controls the azimuthal positioning of the arm. Two 200 W OMRON servomotors are mounted at the opposite ends of the arm. One of them enables the radial positioning of the measurement probe along the arm while the other one enables the azimuthal positioning of the arm, by friction. Namely, the other servomotor is connected to a rubber wheel moving along a supporting ring lying between the poles and fixed to the lower one.

The relative accuracy of the measurement probe, which is a miniature Hall probe, is below 0.01 %. The calibration of the probe, up to 2.7 T, was performed using a METROLAB NMR high precision teslameter. The calibration of the radial positioning of the probe, along the measurement arm, was performed using a HP laser interferometer system. We have estimated that the overall uncertainty of the magnetic field measurement system is in the range of  $\pm 0.01$  %.

Figure 4 shows the magnetic field measurement system in its working position.

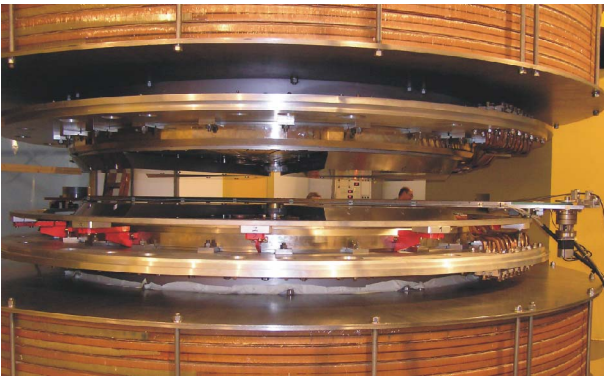

Figure 4: The magnetic field measurement system in its working position with the upper pole elevated.

### Shimming of the sectors and plugs

The S6 shape of the sectors was determined using the MERMAID code. We machined only one pair of sectors and the corresponding parts of the plugs. The magnetic field measurements were performed between the S6 sectors, in the azimuthal range of  $90^\circ$ , first for the main coils currents of 250, 600 and 1,000 A and later for 265, 782 and 988 A. The results obtained were in good agreement with the results of calculations (the differences were in the range of 1-2 mT). The differences were larger only in the central region, due to the asymmetry of the arrangement of sectors (the remaining three pairs of sectors were of the S5 shape).

In the next step we defined the S7 shapes of the sectors and plugs. Again, we machined only one pair of sectors. The remaining three pairs of sectors were machined to the S6 shape. The magnetic field measurements were performed between the S7 sectors for the main coils currents of 250, 257, 267, 527, 570, 600, 711, 780, 945 and 1,000 A. The measurements have enabled us to define the final shape of the sectors. We have eliminated the depression of the magnetic field in the central region.

At the moment we are machining the sectors to the S7 shape, and defining the final shape of the plugs.

Figures 5, 6 and 7 give some of the obtained results of calculations and measurements of the magnetic fields. In the calculations we included the contributions of the main coils as well as of the trim coils. The measurements were performed with the main coils only. The result given in Fig. 7 includes the contributions of the trim coils. The results obtained have been used for the calculations of dynamics of the four test ion beams in the central and extraction regions.

## CONCLUSIONS

The preliminary ion beam dynamics analysis has shown that we have achieved the proper isochronization of the magnetic fields and the axial focusing of the four test ion beams. A detailed analysis is in progress.

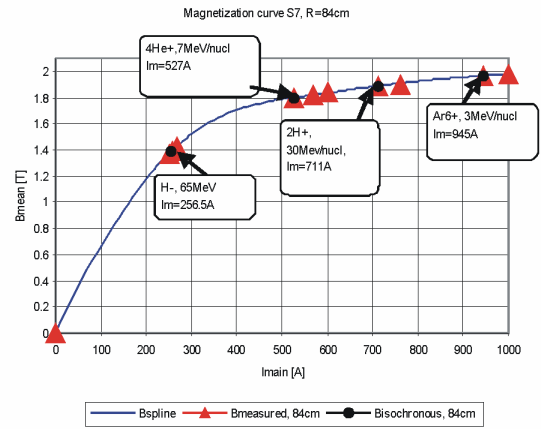

Figure 5: The average magnetic induction at the radius of 84 cm vs. the main coils current.

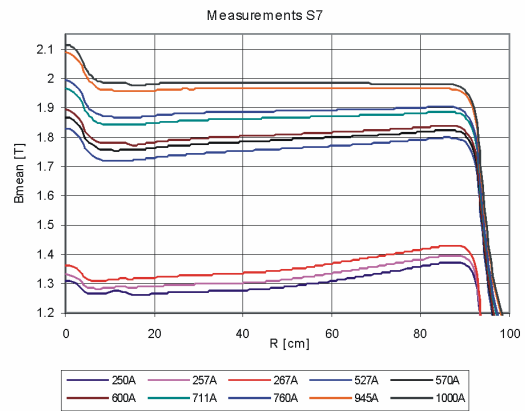

Figure 6: The measured average magnetic induction vs. the radius for different main coils currents.

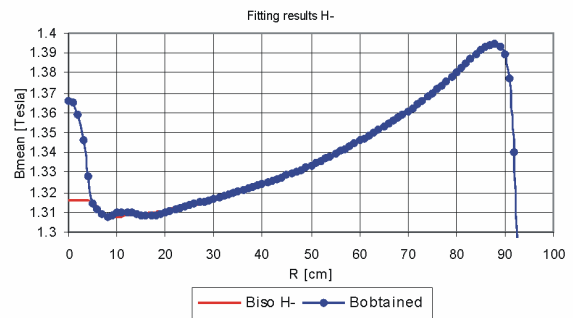

Figure 7: The calculated average magnetic induction vs. the radius compared to the isochronous magnetic field profile for the 65 MeV  $H^-$  ion beam.

## REFERENCES

- [1] N. Nešković et al., "Fast track phase of construction of the TESLA Accelerator Installation," this proceedings.
- [2] A. S. Vorozhtsov et al., "Electromagnetic stripping of  $H^-$  ions in the VINCY Cyclotron," to be published.
- [3] S. B. Vorozhtsov et al., Nukleonika 48, Suppl. 2 (2003) S39.