

# BEAM POSITION MONITOR SYSTEM FOR THE ORBIT FEEDBACK AT THE INTERACTION REGION OF KEKB

Masaki Tejima, Kotaro Satoh and Makoto Tobiya  
 KEK, 1-1 Oho Tsukuba-shi, Ibaraki-ken 305-0801, Japan

## Abstract

To maintain the optimum collision condition of the two rings, two special BPMs with 8-button electrodes, called OCTPOS, were installed inside the super-conducting quadrupole magnets (QCSs) at the interaction region (IR) of KEKB. Four normal BPMs with 4-button electrodes were incorporated outside the QCSs. We have commissioned the OCTPOS BPMs for simultaneous measurements of both the electron and positron beam positions from their composite signal. We have verified the separation of both beams by the finite orbit separation method. The beam positions of OCTPOS and four normal BPMs were consistent. This report describes the performance of the system as a result of operation.

## 1 INTRODUCTION

KEKB is an electron-positron collider with asymmetric energy, which consists of two rings: a high-energy ring (HER) of 8-GeV and a low-energy ring (LER) of 3.5-GeV. In a two-ring collider like KEKB, an orbit adjustment at the interaction point (IP) is important for maintaining stable beam collisions. In the neighborhood of IP, the two beams pass through common pipes and BPMs because both orbits are not separated sufficiently. It is impossible to measure beam signals with a very small bunch spacing of less than 1 nsec in the time domain by fast switch. A finite orbit separation method [1] between the two beams was proposed to detect the beam positions of each ring with a common BPM having many electrodes. To measure the beam orbits at IR by this method, two special BPMs with 8 electrodes were installed at both sides of IP, as shown in Figure 1. The output signal was detected with a narrow band detector, the same electronics employed for measuring of closed orbit at KEKB [2].

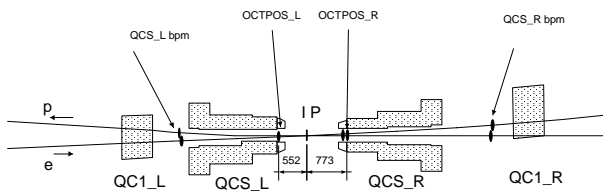

Figure 1: Schematic view of the KEKB IR.

## 2 BPM HEADS OF OCTPOS

Near IP, the orbit separation is so small that both beams pass through a common chamber and OCTPOS. For the serious space problem inside QCSs, we could not adapt such an electrode as directional couplers to measure the positions of the two beams separately. We elected to install two special BPM heads each having eight button electrodes at the front end of the QCSs around the IP. Since the OCTPOS is placed inside the inner bore of the QCS cryostat, the button electrode adopted was a SMA - type connector. In order to improve the contact of the connector, we changed the female structure of the central rod into a male one last summer, as shown in Figure 2.

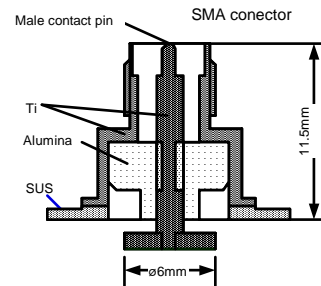

Figure 2: Button electrodes for OCTPOS.

Eight button electrodes were directly welded onto a copper block with a round shape, as shown in Figure 3. They were set directly at both ends of the IP chamber. The OCTPOS head was made from non-magnetic material to avoid any strong force of a magnetic field due to the solenoid coil and the QCS.

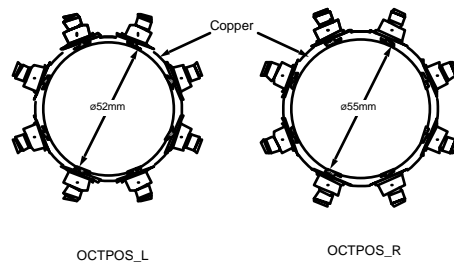

Figure 3: Sections of the OCTPOS head.

### 3 NORMAL BPM HEADS FOR IR

Four normal BPMs with 4 electrodes at the exit of the QCS were also incorporated into this IR BPM system to back up the OCTPOS BPMs. These BPM heads were made of aluminum alloy, and were attached to four button electrodes with an N-type connector by a flange. The BPM head has a double pipe structure, as shown in Figure 4. These BPM chambers were assembled as a QCSL chamber or a QCSR chamber, which were attached to the next chamber by a flange. These BPMs were not supported firmly at the end of a magnet; as a result, heating up of the vacuum chamber caused a mechanical movement of the BPMs. Two displacement sensors measured these movements, which fluctuate depending on the intensity of the stored beam, as shown in Figure 5. At present, these movements are compensated in the beam position data by these displacement measurements.

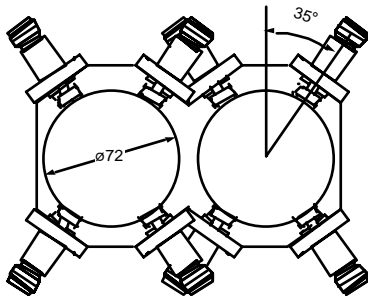

Figure 4: Sections of BPM heads at exit of QCS magnets.

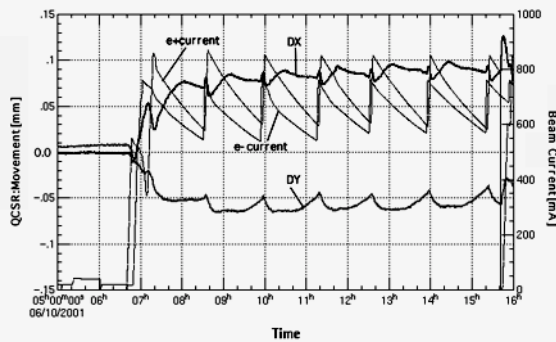

Figure 5: Movement of the QCSR BPM chamber due to heat up by beam intensity.

### 4 MEASUREMENT OF OCTPOS

A schematic layout of the control system for OCTPOS is shown in Figure 6. The eight electrode signals of OCTPOS are read out by the same electronics employed in the closed orbit BPM system -- that is, a multiplexer and a signal processor module [2]. An IOC for OCTPOS has been distributed especially to operate as a collision

feedback system at the IP. The signal processor detects the combined output signal of both beams, and the pickup frequency is 1018MHz, twice the accelerating RF frequency. The signal processor for the OCTPOS BPMs perform a FFT analysis of the signals at 64 sampling points, and an average of 16 measurements are ultimately processed by the IOC controller.

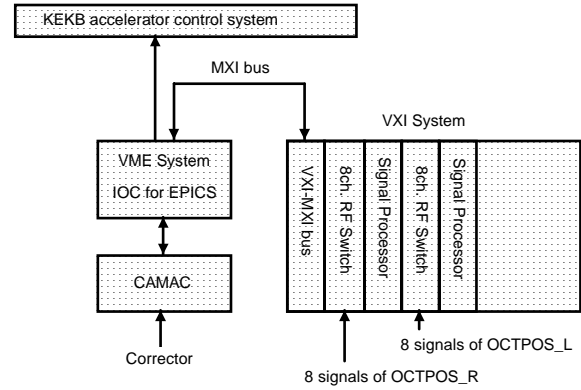

Figure 6: Schematic layout of control system for the OCTPOS.

The output signal can be represented with a phaser, and the peak value ( $V_i$ ) of the phaser is measured by the detector, as follow:

$$V_i = g_i \sqrt{(Q_e F_i(X_e, Y_e))^2 + (Q_p F_i(X_p, Y_p))^2 + 2Q_e Q_p F_i(X_e, Y_e) F_i(X_p, Y_p) \cos \theta}$$

where  $g_i$ ,  $F(X, Y)$  and  $\theta$  are the gain, the response function of the  $i$ -th electrode and the phase difference between two beams;  $(Q_e, X_e, Y_e)$ ,  $(Q_p, X_p, Y_p)$  are the charge and position for positron and electron beams.

In advance, the gains were calibrated with a beam under the condition of single-beam operation (a electron or positron beam). The response function was calculated from the BPM geometry. The phase difference was defined to be constant and can be calculated from the distance between the OCTPOS and the IP. Therefore, when the eight parameters ( $V_i$ ,  $i=1,2,\dots,8$ ) are known, the remaining six unknown parameters can be obtained by a nonlinear fitting, because the unknown parameters  $(Q_e, X_e, Y_e, Q_p, X_p, Y_p)$  are fewer than the number of measured data points (8 outputs from the electrodes) [1].

We applied the phase difference to a constant value, such as  $\pi/4$ , calculated from the designed position of the BPM. But the actual phase difference may differ from the constant value, because the OCTPOS has been installed within a tolerance of a few mm, and also the transient beam loading changes the phase of the RF cavity. Since this finite-orbit separation method is sensitive to the phase difference, simulation studies of the phase error show that the major effect causes movement of the position reading

in the horizontal direction, which it is more harmful in HER than in LER.

## 5 PERFORMANCE

We have commissioned the OCTPOS BPMs for simultaneous measurements of both the electron and positron beam positions from their composite signal. The separation of both beams by this method was verified roughly, as shown in Figure 7.

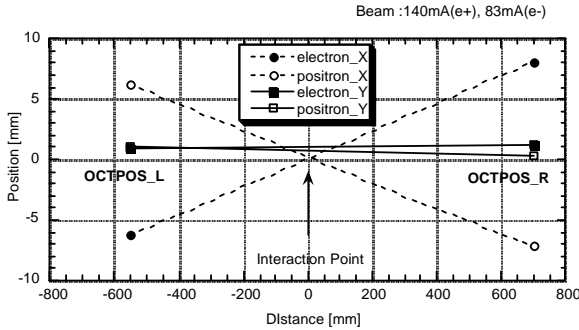

Figure 7: Beam positions at OCTPOSs obtained from composite button-electrode signals induced by the electron and the positron beams.

However, we must test the correlation among these separated positions of OCTPOS with some neighboring BPMs (QCSRe, QCSLe, QCSRp, QCSLp, etc.). For the analysis of the correlation by actual beam positions, we measured all beam positions under single-kick orbits at different source points. A three BPM correlation analysis based on the lattice model of the KEKB ring estimated that a difference of about 10  $\mu\text{m}$  exists in the positions of the OCTPOSs between the single-beam case and the two-beam case, as shown in upper and lower parts of Figure 8. By the way, the other correlation errors of IR are very large (about 0.1mm), perhaps related to the uncertainly value of the model optics.

The global optical function was corrected by using OCTPOS under two-beam operation this summer [3]. There is no notable difference in the result of the correction between two-beam and single-beam operation.

## 6 SUMMARY

The OCTPOS system was introduced at IR in KEKB for measurements of the crossing angle between the electron and positron beams and the beam-beam kick angle at the IP based on the beam-beam deflection technique [4]. The OCTPOS system for the IR has not yet been used to optimize the collisions under two-beam operation for physics experiments, but it has been available for single-beam operation. There is a disagreement in the results of the measurement between the OCTPOS and the four normal BPMs for the backup of the OCTPOS during two-beam operation in the case of

high-current beam. In the case of a low current beam, such as 20 mA, the OCTPOS are available for optics correction of even both beams, because the phase-difference error due to transient beam loading of the RF cavity is negligibly small. It is necessary that we still study of OCTPOS in order to enable optimization of the collision of two beams in the case of a high-current beam. Especially, we need to study the beam-current dependence of the beam positions and to exactly determine the phase deference between an electron bunch and a positron bunch.

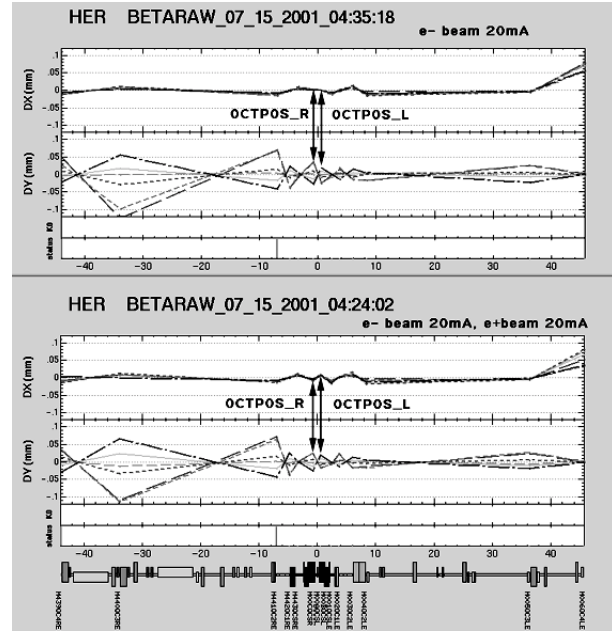

Figure 8: Correlation error at IR was calculated from the difference in the single-kick orbits in HER by the three BPMs correlation method (the upper: electron beam, the lower: both beams).

## ACKNOWLEDGMENT

The authors would like to thank those who kindly cooperated in the study.

## REFERENCES

- [1] K.Satoh, "Detection of the position of two beams with a common BPM", Proc. PAC99
- [2] M.Teijima, et al., " BEAM POSITION MONITOR SYSTEM FOR KEKB", Proc. EPAC2000.
- [3] H.Koiso, et al., "CORRECTION OF OPTICAL FUNCTIONS IN THE KEKB", Proc. Factories99
- [4] Y.Funakoshi, et al., "Feasibility Study of an Orbit Feedback System for the KEKB Facility", Proc. PAC95.