

Mail Collection Boxes: A Brief History

Small letter boxes for the deposit of U.S. Mail first appeared on the streets of American cities in the late 1850s, when they were attached to lampposts or buildings. In the 1890s, larger, free-standing "package boxes" were introduced nationwide, which evolved into today's standard collection box.

First Known Collection Boxes in New York City in 1833

The use of boxes for the deposit of outgoing U.S. Mail began with the penny post system of letter delivery in cities.¹ In 1833, New York City's letter carriers placed boxes along their delivery routes. The carriers collected letters from the boxes "every day (except Sundays) at one o'clock" and took them to the Post Office for a fee of two cents each.² The boxes were removed a few years later, "greatly to the annoyance and inconvenience of the citizens living at a distance of two or three miles from the Post-office."³

Private letter delivery companies, which operated in large cities in the mid-1800s, also used collection boxes.⁴ In August 1842, the Post Office Department bought Alexander Greig's City Despatch Post, which delivered letters within New York City, and continued its intra-city letter delivery service under the name "United States City Despatch Post." Letter boxes labeled "United States City Despatch Post" were placed at 112 stations "in the most populous and eligible situations ... in the city," and mail was collected from them three times daily.⁵ When the service ended in November 1846, New York City residents were once again without boxes for the deposit of U.S. Mail.

Within the next few years, collection boxes for U.S. Mail were installed in other cities. In 1848, Postmaster General Cave Johnson authorized a letter carrier in Jersey City, New Jersey, to place a collection box on his route.⁶ And in 1851, when the penny post system was established in New Orleans, Postmaster Michel Musson divided the city into delivery districts and instructed the carriers in each district to erect "secure Letter Boxes" for the reception of letters.⁷

By 1852, the carriers of the New York City Post Office again collected mail from boxes inside shops and other businesses. Hundreds more collection boxes were installed in New York City in 1855, with collections made four times daily. But postal reformer Pliny Miles was not impressed. He complained that "1,000 little tin boxes" had been hidden "in as many places of business in New York," and that they were accessible only when the businesses were open.⁸ He also complained that the boxes were not locked, noting that "any person ... can ... take out their contents, or carry the entire box away without a question being asked." Miles wanted plainly visible, accessible, and secure collection boxes.

Street Letter Boxes Introduced in 1858

On March 9, 1858, Philadelphia merchant Albert Potts received a patent for a cast-iron letter box designed to fit over city lampposts. In July 1858, on behalf of the Post Office Department, Potts petitioned Philadelphia's city council for permission to fasten his boxes to "any of the public lamp posts."⁹ Potts explained that his boxes would be "much safer and better than the ... tin letter boxes, in hotels, grocery stores, and other private places." He also noted that they would



Albert Potts' Lamppost Letter Box, 1858

courtesy of [The Library Company of Philadelphia](#)

The first cast-iron letter boxes were placed along the streets of Boston, Philadelphia, and New York City in the late 1850s. Until free city delivery was introduced in 1863, letter carriers were entitled by law to charge customers one or two cents for each letter they took to the Post Office for mailing, although this fee was not always charged.

“Perhaps no improvement instituted by the General Government met with greater favor at the time of its inauguration than the establishment in our large cities of a regular system of letter deliveries and street-boxes.”

—New York Times, July 24, 1871

be "accessible at all hours of the day and night, and easily found by every stranger visiting the City." The council gave Potts permission the next month. By July 1859, more than 300 boxes of Potts' design were installed in Philadelphia, "bringing the Post-office to every one's door."¹⁰

In the meantime, Nahum Capen, Postmaster of Boston, directed the placement of 33 "strong and secure iron boxes" near Boston's busiest street corners, with letter collections beginning August 2, 1858.¹¹

Residents of New York City, meanwhile, still suffered with "tin tea-canisters" hidden in "corner groceries and rum holes."¹² That changed in late November 1859, when several lamppost letter boxes were installed in the city. In 1860, the Post Office Department awarded a contract to John Murray of New York City for 1,600 letter boxes. The contract called for Murray to supply and install 300 "medium size" cast-iron lamppost boxes and 1,100 larger boxes that were 24 inches high.¹³ Murray also agreed to relocate 200 medium-size lamppost boxes that he had recently installed in the city.¹⁴ By November 14, 1860, the Postmaster of New York reported that 574 cast-iron collection boxes had been installed, from which mail was collected four times daily.¹⁵

Meanwhile, postal officials continued to purchase and use other types of collection boxes. In 1862, the Postmaster of Philadelphia was reimbursed \$800 for "cash paid proprietors Blood Dispatch [sic] for letter boxes."¹⁶

The Act of March 3, 1863, authorized the establishment of free home delivery of mail in cities as well as "pillar boxes, or other receiving-boxes, for the safe deposit of matter for the mails."¹⁷ On July 1, 1863, free delivery began in 49 cities, including Trenton, New Jersey. Later that month, Postmaster General Montgomery Blair advised Postmaster Joshua Jones of Trenton that "cheap boxes of tin or wood may be procured, and put up at convenient distances throughout the place."¹⁸

In 1864, Postmasters were instructed to

procure and put up in shops, stores or private houses ... at convenient distances throughout the place, cheap boxes of tin or wood, for the deposit of letters for mailing, and apply to the Contract Office of this Department for locks and keys for the same.... These boxes must be lettered "U.S. Letter Box, not for valuable letters."¹⁹

It is unclear when the Post Office Department standardized letter boxes.²⁰ The first known letter box contract was awarded to Samuel Strong in 1869.

Strong's Flat-Top Box Flopped in 1869

On March 30, 1869, Samuel Strong of Washington, DC, received a patent for a flat-top letter box. A month later, 175 of these boxes replaced older boxes in Washington, DC. Strong produced boxes of this type for the Post Office Department under contract beginning in September 1869. He claimed that the boxes were both secure and easy to empty, but letter carriers found them awkward to use. In January 1870, Postmaster General John Creswell directed a group of Postmasters and special agents in Washington, DC, to consider alternatives. After considering and rejecting several proposed designs, they came up with their own — the "round-top" mailbox. Samuel Strong was



Lamppost Letter Box, 1870

Political cartoonist Thomas Nast pictured a letter box in a January 8, 1870, cartoon in *Harper's Weekly*, lambasting the congressional franking privilege. Nast contrasted a contemporary senator, carting a mountain of mail to the Post Office in a wheelbarrow, with "the coming senator," who deposited a handful of letters in a letter box once his free mailing privileges were restricted.

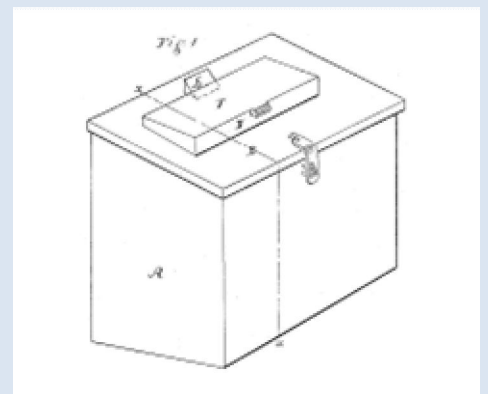

Samuel Strong's Flat-Top Box, 1869

from Patent No. 88,528, courtesy [Google Patents](#)

Samuel Strong made a flat-top letter box for the Post Office Department beginning in September 1869. A hinged lid on top of the box opened to admit letters. Complaints about the box led to a new box design less than a year later.

contracted to make boxes of the new design, incorporating improvements suggested by the Postmaster General, and to supply them under a 4-year contract beginning in February 1870.²¹

The Round-Top Box Proliferated in the 1870s and 1880s

In the 1870s and 1880s, the Department purchased more than 35,000 round-top mailboxes in two sizes.²² The boxes had a metal flap on the side, which lifted up to reveal the letter slot. The Union Foundry and Manufacturing Company of Reading, Pennsylvania, supplied the boxes under contract from 1874 to 1878. In 1878, Orr, Painter & Company won the contract. The boxes were simple to use, but the letter slot sometimes let in rain and snow as well as determined thieves. The slot was also too narrow for newspapers, which led some customers to "mail" newspapers by piling them on top of letter boxes. Carriers were not obligated to collect items placed on top of letter boxes, and such items were also liable to be picked up and carried away by a strong breeze, or thieves.

The variety of letter boxes used in cities, meanwhile, sometimes confused the public. Newspapers occasionally provided accounts of letters mistakenly deposited in fire hydrants and alarm boxes.²³

The Doremus Box, Adopted in 1889, Offered Enhanced Security

After examining more than a hundred different mailbox designs in search of a better mailbox, the Department chose a box designed by Willard D. Doremus, a Washington, DC, inventor.²⁴ Doremus' box had a lid near the top, along the full width of the front, that pulled down to reveal the letter slot. The Department contracted with Doremus for a 4-year supply of the boxes beginning July 1, 1889.²⁵ On March 3, 1893, Maybury & Ellis of Detroit, Michigan, signed a 4-year contract to supply the boxes.²⁶ The cast-iron boxes came in three sizes: No. 1 (750 cubic inches), No. 2 (1,180 cubic inches), and No. 3 (2,360 cubic inches). Orr, Painter & Company of Reading, Pennsylvania, also known as Reading Stove Works, was subcontracted to manufacture the boxes.

A story in the September 1889 issue of *The Postal Record* praised the boxes' "handsome appearance" and "immunity from the weather." The boxes were more theft- and weather-proof than older models, but took some getting used to, since the letter slot had been moved from the side to the front of the box. In January 1890, an article in the *Los Angeles Times* recounted the troubles one young man had when trying to mail a letter:

He looked for the customary slot on the side of the box, but it wasn't there. The young man was surprised, and his surprise visibly increased when the opposite side was discovered equally devoid of an opening of any kind. ... He inspected the front of the box, but no sign of a place to drop the letter. He ran his eyes anxiously over the rounded top, and finally stooped and inspected the bottom, in hopes of finding the wished-for opening. All in vain.²⁷

At length a kindly passerby told the young man to pull on the knob at the top of the box to reveal the opening.

In 1891 a writer for the *Philadelphia Ledger* called Doremus' box a "pigs-in-clover puzzle letter box," as it required the knowledge of the inventor and two

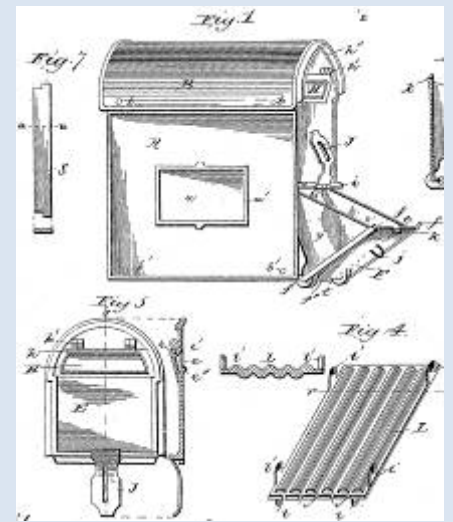

Round-Top Letter Box, 1891

from Patent No. 462,224, courtesy [Google Patents](#)
Samuel Strong was awarded a patent for the round-top letter box in 1891, although it had been designed by Department officials in the early 1870s. (See endnote 21.)

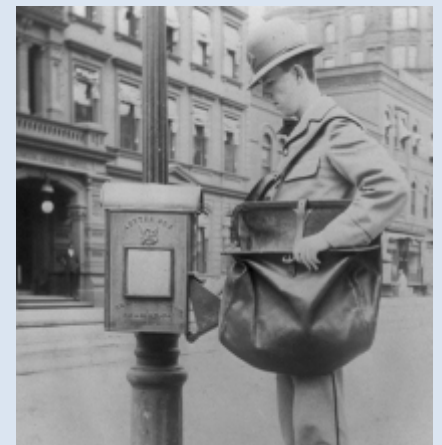

Round-Top Letter Box, 1896

Round-top boxes were made from 1870 to 1889. They had a slot on the side, covered by a top-hinged flap-door, for the deposit of letters.

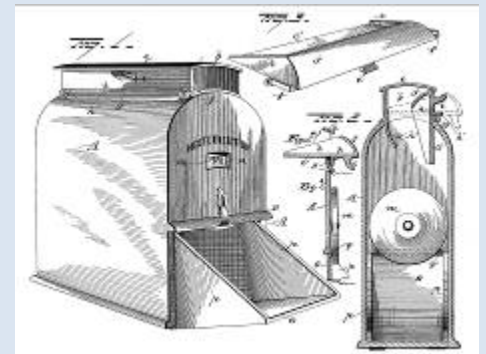

Doremus Letter Box, 1889

from Patent No. 404,828, courtesy [Google Patents](#)
Willard D. Doremus submitted these drawings with his application for a patent for "an improved letter box" which was approved on June 11, 1889.

hands to deposit a letter."²⁸ A year later, the box was still perplexing some mailers. In 1892, Marshall Cushing wrote in *The Story of Our Post Office* that

*the old letter box used to have a slot in the end. In the new box the mail is dropped ... through a tray which opens down at one side of the top. But persons may be seen almost any time looking for the old slot at the end and wondering whither it has disappeared.*²⁹

New Mailbox Designs Chosen by Postal Officials in 1897 and 1901

In September 1893, August Machen of Toledo, Ohio, was appointed Superintendent of the Free Delivery System. For the next 10 years — until he was removed from office while under investigation — Machen colluded with Toledo dentist Eugene Scheble and others to line his own pockets with federal funds. Part of Machen's fraudulent schemes involved contracts for letter boxes, which he oversaw.

In March 1893, Maybury & Ellis had signed a 4-year contract to supply Doremus boxes to the Department. In 1894, after a persuasive visit from Scheble, William C. Maybury agreed to give 25 percent of the profits from the contract to Scheble. Scheble gave half his take to Machen.³⁰ Ostensibly, Maybury was paying for the future right to produce a mailbox design owned by Scheble. In reality, in exchange for a share of the profits, Machen more than doubled the number of boxes the Department ordered, increasing the profits to all concerned. For example, in 1893–94 the Department ordered 1,784 of the small size boxes, while in 1894–95 it ordered 9,215.³¹

In 1897, Maybury & Ellis once again received a 4-year contract to supply letter boxes. This contract was for the "Clouse box," named for Joseph N. Clouse, one of its inventors. It was also known as the "Scheble box," because Scheble owned the rights to it. Scheble's box was cast iron and had a lid along the front that lifted up for the deposit of letters. Maybury agreed to give Scheble 50 percent of his profits, ostensibly in exchange for using Scheble's mailbox design. But Scheble continued to receive 50 percent of the profits even after May 1899, when postal officials asked Maybury to stop using Scheble's design, because it was "unsatisfactory," and to instead supply the older Doremus-style boxes.³²

In 1901, a new 4-year contract was signed for letter boxes. The contract was awarded to the "Michigan Steel Box Company," which was a front for Eugene Scheble. Scheble hired the Adrian Brick and Tile Machine Company of Adrian, Michigan, to manufacture the boxes. The boxes came in four sizes and were made of sheet steel following a design patented by Adrian's Postmaster, Alfred Smith, who had assigned the patent rights to Scheble. Under Machen's direction, the Post Office Department ordered tens of thousands of unnecessary boxes. Within four years, 27,718 boxes were ordered — about 27,000 more than were needed. Machen directed that the extra boxes be installed in the countryside, along rural routes. Not only were these boxes unnecessary — rural customers could deposit mail in their own mailboxes for pickup by carriers — but the boxes impeded service, since carriers were required to stop and check the mostly empty boxes for mail each day. Complaints poured in from Postmasters around the country. Special agents overseeing the rural delivery service recommended that the boxes be removed.



Doremus Letter Box, circa 1900

The Post Office Department purchased Doremus-style boxes from 1889 to 1897, and again from 1899 to 1901. The box had a lid near the top which pulled down for the deposit of letters.

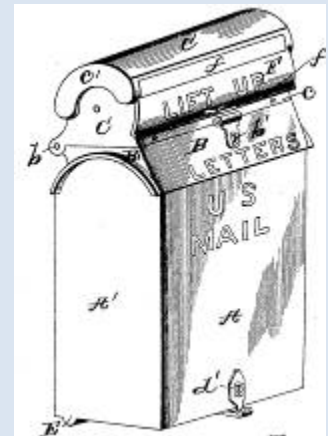

**Clouse/Scheble Box,
Made from 1897 to 1899**

from Patent No. 494,976, courtesy [Google Patents](#)
The Clouse box, also called the Scheble box, was supplied under contract from 1897 until about May 1899, when the Department switched back to the Doremus box.

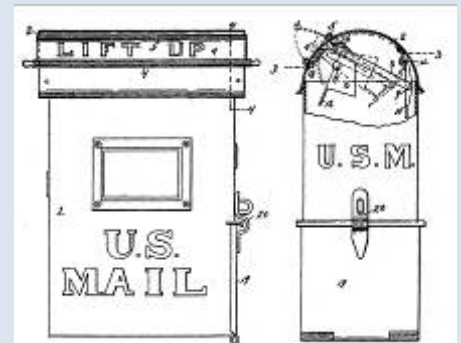

**Second Scheble Box,
Made from 1901 to 1903**

from Patent No. 674,619, courtesy [Google Patents](#)
A second box design owned by Scheble was made by the Adrian Brick and Tile Machine Company from 1901 until 1903. In 1905, the Department contracted directly with the manufacturer for 7,500 remaining boxes.

In 1903, Machen's schemes imploded. Scheble's letter box contract was annulled that June. Machen was removed from office, and Machen and Scheble, among others, were charged with multiple counts of conspiracy and fraud. Machen was ultimately convicted on all counts, imprisoned, and fined \$10,000.³³

In 1904, no additional letter boxes were purchased. Fourth Assistant Postmaster General Joseph Bristow reported that "an ample supply" had been "secured by calling in boxes uselessly scattered along rural routes."³⁴

In May 1905, the Department contracted directly with Scheble's former subcontractor, the Adrian Brick and Tile Machine Company. The Department bought about 7,500 boxes that the company had been stuck with when Scheble's contract was annulled.

In June 1905, the Department awarded a 4-year contract to the Van Dorn Iron Works Company of Cleveland, Ohio, for three sizes of the "Model No. 3, Steel Box, with forged top and malleable drop."³⁵ The collection door was on the side of the box and had an inside lock. The box had a curved hood, with a drip guard along its bottom front edge, which was riveted to the box at the sides. The Department did not sign a new contract when this one expired; instead, it sought a better mailbox while continuing to buy boxes as needed under the terms of the old contract.

Perfecting the Post-Mounted Letter Box

In 1908, First Assistant Postmaster General Charles Grandfield noted that although mailboxes at that time were "fairly satisfactory," both their appearance and function could be improved.³⁶ He explained

At present the door is in the side of the box and when opened forms an inclined plane up which the mail must be pulled by the hand. A box that would ... empty itself by gravity through an opening in the bottom would be a great improvement.

In 1909, Postmaster General George Meyer appointed a committee "to give careful consideration to the question of the style, capacity, material and construction of street letter boxes."³⁷ The committee's quest for a better mailbox lasted more than two years.

In August 1911, the Department began a 6-month test of 500 drop-bottom mailboxes in 25 cities. The monthly magazine *The Postmasters' Advocate* noted that the box looked "exactly" like the ones already in use, "but instead of a side door for removing the mail ... this one has a hinged bottom" to automatically empty mail straight into the carrier's sack.³⁸ The drop-bottom feature had been suggested by David Owen, Postmaster of Milwaukee. Owen had worked in the coal industry, where drop-bottom coal cars were in general use. He claimed that a dozen or more drop-bottom boxes could be emptied in the time it took to empty one of the old ones.

Meanwhile, in September 1911, the Department awarded a contract to the Van Dorn Iron Works Company for letter boxes for the fiscal year ending June 30, 1912.³⁹ The contract called for 2,000 No. 1 size boxes, 1,500 No. 2 boxes, 500 No. 3 boxes, and 50 No. 2 boxes, with doors at both ends.



Doremus Letter Box, circa 1911

Letter boxes remained in service as long as they functioned properly. A city carrier in Washington, DC, pictured above, collected mail from a Doremus letter box using his Flying Merkel motorcycle.



Drop-Bottom Cox Box, 1912

The Department tested drop-bottom mailboxes designed by Dr. Samuel Clifford Cox in Washington, DC, in 1912.



Drop-Bottom Owen Box, circa 1914

Drop-bottom mailboxes designed by Milwaukee Postmaster David C. Owen were tested in 25 cities beginning in 1911.

In late 1912, after investigating mailbox designs for more than two years, the Department's mailbox committee recommended two designs — "Style A," a new rectangular-shaped box, and "Style B," which was similar to the existing style. One of the new boxes featured a drop bottom for quick collection by mounted carriers. The caps on the boxes were gray cast iron and the remainder was nearly pure iron, for durability. Instead of posts, the boxes were designed to be fixed to pedestals whenever possible.

In March 1913, contracts were awarded to Mathis Brothers Company of Chicago and the Allegheny Steel Company of Brackenridge, Pennsylvania, for the supply of letter boxes.⁴⁰ That November, the Department ordered 17,000 Style A, 26 ¼" tall drop-bottom boxes from the Allegheny Steel Company. By June 1914, 8,608 of the new boxes had been purchased.⁴¹

Although the Department considered the Style A mailboxes to be both easier to use and more ornamental than previous versions, New York City's Municipal Art Commission — tasked with beautifying that city's streets — did not agree. The art commission had rejected new mailbox designs since at least 1903 and rejected the Department's newest design in 1914. As old, "unsightly" letter boxes were removed from New York City's streets, its citizens had to walk further and further to mail a letter. An impasse persisted until about 1917, when the city finally decided that an unsightly mailbox was better than no mailbox, and its art commission quietly consented to the adoption of standard styles.⁴²

By April 1916, several weaknesses had been identified in the new boxes: they were not weatherproof; they were extremely heavy; and boxes with drop-bottom chutes tended to clog with mail. The designs were modified, calling for a sheet metal versus cast iron top, and the drop-bottom style (No. 2b) and the 30-inch tall, largest capacity box (No. 3) were discontinued.⁴³ In January 1917, Post Office Department draftsmen drew up specifications for the two styles of street letter boxes — Style "A," the new rectangular box, and Style "B," the traditional round-top box. Both boxes were of riveted, pressed steel. The last contract awarded for Style A boxes expired on April 30, 1918.

Due to the difficulty in obtaining prompt delivery of letter boxes from the "two or three" companies that made them, in 1922 the Post Office Department arranged with the Navy Yard in Washington, DC, for the manufacture of nearly 10,000 Style B letter boxes.⁴⁴ In addition, the Navy Yard made 1,000 special boxes of brass and 100 of zinc, to test the durability of those metals in cities along the Atlantic coast, where corrosive sea air shortened the life of steel boxes.

The 1923 *List of Postal Supplies* listed two sizes of Style B letter boxes: No. 1 (small), 13 by 8 ¾ by 19 ¾ inches, and No. 2 (medium), 15 ½ by 9 ½ by 24 inches. In 1924, new mailbox specifications were issued, calling for cast-iron instead of sheet steel construction. Cast-iron boxes were cheaper than those made of pressed steel and postal officials believed they were more rust-resistant and durable.

The last post-mounted collection boxes were purchased by the Post Office Department in August 1955. In 1962, 109,263 post-mounted boxes were still in service. By 2016, the number had dwindled to 169.

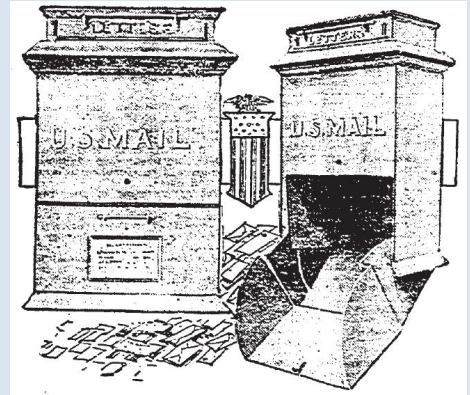

"Style A" Letter Box, 1913

The drop-bottom Style A letter box, "the invention of C.S. Cox" (sic), was illustrated in the December 1, 1913, issue of the *Los Angeles Times*.



"Style A" Letter Box, 1920s

The rectangular "Style A" design adopted in 1912 was considered to be more ornamental than previous styles and was slightly more expensive to produce. Style A boxes were made under contract from 1913 to about 1918.



"Style B" Letter Box, 2014

The curved "Style B" design selected in 1912 was similar to existing designs. This type of letter box was last purchased in 1955.

Large Collection Boxes

Street letter boxes were a great convenience for urban customers, but were designed specifically for letters. City residents who wanted to mail newspapers or packages were instructed to visit the nearest Post Office. Despite these instructions, many customers simply placed oversized mail on top of letter boxes and hoped for the best. Postmasters discouraged this practice for several reasons — not only was mail placed on top of boxes vulnerable to thieves and weather, but letter carriers were duty-bound to collect only mail that was *inside* a letter box, not whatever was placed on top of it. Nevertheless, the practice was widespread.

By 1888, Postmasters in a few Eastern cities provided large boxes for the deposit of newspapers, packages, and other oversized mail. In 1890, such "package boxes" began appearing on city streets nationwide.

The Post Office Department first contracted for a supply of package boxes in 1893, with Isaac McGiehan.⁴⁵ The boxes, made of rolled steel by the Van Dorn Iron Works Company, were originally intended to be fastened to posts, but because of their large size were soon set directly on sidewalks or on blocks. In 1894, a suggestion was made to attach legs to the boxes, and this idea was presumably adopted shortly thereafter.⁴⁶ In 1895, First Assistant Postmaster General Frank Jones noted

The Department increased the facilities for mailing and dispatching small packages of merchandise and papers, by locating at suitable points in the principal cities of the country large package boxes from which the mail is collected by wagon service at convenient intervals throughout the day. This service has been especially effective in New York, Chicago, and Philadelphia, and the postmasters report that it is the source of the marked increase in the quantity of third and fourth class matter dispatched through their respective offices. It also relieves the foot collectors of a large amount of paper mail that was formerly deposited in and on street letter boxes.⁴⁷

In 1897, a combination letter and package box was invented by S. Davies Warfield, Postmaster of Baltimore, Maryland, and was tested in that city in conjunction with streetcar mail service.⁴⁸ The box had two compartments — one for letters and one for small packages. In 1898, First Assistant Postmaster General Perry Heath stated that the tests in Baltimore had gone well and that the boxes would be "extended as rapidly as possible to other cities presenting conditions and facilities equal to those in Baltimore."⁴⁹ The Department first contracted for combination letter and package boxes on December 3, 1904, with the Van Dorn Iron Works Company.⁵⁰

A 1911 survey of collection boxes in 12 large cities revealed that of the total number, 82 percent were post-mounted letter boxes, 12 percent were package boxes, and 6 percent were combination boxes (see Table 1, "Number of Collection Boxes in Select Cities in 1911," on page 12).

Increasing mail volume — especially after the introduction of Parcel Post in 1913 — increased the need for larger mailboxes. On March 30, 1931, the package box was renamed the "Large Collection Box" and the combination box was discontinued.⁵¹



Package Box Next to a Letter Box, 1906
Separate "package boxes" for mailing newspapers and packages were introduced nationwide in the 1890s.



Package Box Next to a Letter Box, 1923

courtesy of the Library of Congress

In 1931, package boxes were renamed "large collection boxes." They became the standard collection box in the 1950s, when post-mounted letter boxes began to be phased out of service.



Combination Letter and Package Box (undated photo)

Combination letter and package boxes had two compartments, one for letters and one for small packages. The Department first contracted for combination letter and package boxes in 1904; they were discontinued in 1931.

Although the same basic style of large collection box has been used since the early 1900s, experimental designs were tested over the years, including a foot-pedal mailbox in the 1950s and a boxy stainless steel model in the 1960s (see Appendix 1, "Experimental Collection Boxes, 1950s–1960s," on page 13). Ultimately, none of these models proved superior to the standard design already in use.

In 1954, the Post Office Department introduced dual collection boxes — side-by-side boxes marked for either "LOCAL" or "OUT-OF-TOWN" delivery.⁵² Mail that was presorted by customers skipped a handling step at the Post Office, enabling speedier service at reduced cost. By the 1960s, dual boxes were also used for the separate deposit of stamped versus metered mail.

In 1988, the Postal Service approved specifications for larger collection boxes: a high density box in two sizes, one 27" wide and another 34 5/8" wide, and a jumbo box, measuring 48.5" wide. By 1992, only the larger-size high density box, measuring 25" deep by 34 5/8" wide by 52 3/8" high, and the jumbo box were produced. The high density box held two large bins, while the jumbo box held a large wheeled hamper. These larger boxes were placed near mail processing plants and large urban Post Offices where customers regularly deposited large amounts of mail. In 2006, the high density box was renamed the "large collection box" and the original "large collection box" became the "standard collection box."

Beginning in 1974, postal guidelines called for collection boxes averaging less than 25 pieces of mail a day to be considered for removal or relocation, although other factors were also taken into account, like the character of the mail and customer convenience. The Postal Service increased its efforts to cull underused collection boxes from city streets in 2002, saving fuel and labor but making it harder for some customers to find the iconic blue boxes (see Table 2, "Number of Collection Boxes, 1975 to 2015," on page 12).

In 2016, of the approximately 153,560 collection boxes in use, 93 percent were standard boxes, 5 percent were large and jumbo boxes, and 2 percent were special collection boxes for the deposit of Priority Mail Express items (see Appendix 3, "Mailboxes for Express Mail and Priority Mail Express," on page 15).

Chronology of Colors and Decals

Green, from 1860

The earliest known reference to the color of boxes for the deposit of U.S. Mail is found in a *New York Times* article of February 22, 1860:

*The green letter-boxes which have been distributed throughout the City ... are hailed as oases, not on account of the color alone, but because they save many a pilgrimage ... from the various parts of the City to [the Post Office].*⁵³

According to newspaper accounts, letter boxes remained green in the 1870s and early 1880s, although the shade was not uniform in each city. In 1882, boxes in Reading, Pennsylvania, were "dark green," while the following year in Oakland, California, they were painted "bright green ... like a bull's-eye lantern on a dark night."⁵⁴



Snorkel Mailbox, circa 1954

Special mailboxes for motorists were tested as early as 1927, when Postmaster Roy Nichols of Houston placed a box near a curb, tilted it toward the street, and attached a long handle to the opening. By 1939 a box with a snorkel-like extension chute was tested in Salt Lake City. The Post Office Department developed a standardized snorkel attachment for mailboxes in 1953 and began distributing it to Post Offices the next year.



Dual Collection Box Signage, circa 1955

Dual collection boxes, introduced in 1954, let mailers presort their letters.



Large Collection Box, 2015

courtesy of Kevin A. Mueller

The large collection box, called a "high density box" prior to 2006, was introduced in 1988. It had an optional snorkel attachment.



Jumbo Snorkel Collection Box, 2016

courtesy of Junemarie J. Brandt

The jumbo collection box was introduced in 1988. It had an optional snorkel attachment.

Red in Some Cities by 1887

By 1887, letter boxes in Washington, DC, had been painted red, "so that they make a sharp contrast with the lamp posts ... and can be more easily found" — a visiting Chicago postal official called it an "improvement" and planned to have the boxes in his city painted red.⁵⁵

In 1889 collection boxes in Baltimore were painted red, while in Boston, they were painted either red or green:

*There are over 800 street letter boxes from which collections are made by the Boston office and its sub-stations. ... Some of these boxes are painted red and others green. The red boxes are the most important ones, and they are visited every hour by the carriers. The others are visited four or five times a day.*⁵⁶

Red, from 1891

In 1891, the color of letter boxes was changed to red. The October 21, 1891, issue of the *Decatur [IL] Herald* reported

The time honored color green by which the boxes have for years been distinguished is to be done away with and will be succeeded by a bright red. The department specifies that the boxes must be painted with two coats of the best vermillion.

In some cities the boxes were all red, while in other cities the raised letters on the boxes were painted yellow or gold, for contrast.

Silvery-White, from 1897

In 1897, Superintendent of Free Delivery August Machen directed that all letter boxes be painted a silvery-white "aluminum" color; boxes were painted this color until about 1905. The letters on the boxes were painted red.⁵⁷ The new color scheme was selected primarily to enable Machen to defraud the government in collusion with John T. Cupper of Lock Haven, Pennsylvania. Machen made an arrangement with Cupper whereby the latter would oversee the painting of mailboxes, and would be grossly overpaid for both the paint and for labor. The aluminum paint was claimed to be more durable and protective than previous paints, but in reality it was neither. The silvery-white color did not weather well, was easily scuffed by match strikes, and was a tempting target for graffiti.

Green, from 1905

In April 1905, the Department switched to green enamel paint for letter boxes, with white lettering. Fourth Assistant Postmaster General Peter DeGraw reported:

*It has been decided, after exhaustive investigation, to substitute for aluminum paints for letter and package boxes a green paint which, it is believed, will afford better protection to the material of which the boxes are made.*⁵⁸

In 1908, the Department experimented with red paint on some boxes in Washington, DC, searching for a durable alternative to green. *The Washington Times* commented:

letter boxes ... in the last several years ... have been changing their exterior appearance more rapidly and violently than the chameleon. First, they were



Silvery-White Letter Box, 1899

courtesy Library of Congress

From 1897 to 1905, collection boxes were painted a silvery-white "aluminum" color, with red lettering.



Olive Green Letter Box, 2010

Green was the standard color for collection boxes from 1905 to 1955, except for ten weeks in 1913 when red prevailed. Initially, the shade of green varied; by 1932 it was "olive green."

green, then silver, then a lighter green, and now they have accumulated an anarchistic sun-burned fiery red.⁵⁹

On February 27, 1913, Postmaster General Frank Hitchcock ordered that collection boxes be painted a new color — “either vermilion or coach-red.”⁶⁰ Ten weeks later, on May 10, the order was rescinded by newly-appointed Postmaster General Albert Burleson because fire departments, city councils, and the public complained about the confusion with fire alarms and police call boxes.⁶¹

In 1920, the shade of green was described as both "dark green" and "emerald green." In 1923, the Post Office Department's *List of Postal Supplies* called it simply "green;" by 1932 it was "olive green."⁶² Boxes remained olive green until 1955, although letter boxes in Manhattan and the Bronx were painted a silver aluminum color in 1953, for improved visibility and rust-resistance, after a successful two-year test.⁶³

Red, White, and Blue, from 1955

On July 4, 1955, Postmaster General Arthur Summerfield announced that street collection boxes would be painted red, white, and blue to make them more easily identifiable. The bottoms of collection boxes were painted blue and the tops were painted red. "U.S. Mail" was painted white, along with the words "LETTERS" and "PULL DOWN" on post-mounted boxes. Specifications for the red, white, and blue color scheme were printed in *Postal Bulletin* 19867, dated August 9, 1955.

In 1962, decals with the words "U.S. MAIL" replaced the painted words on the sides of large collection boxes and the raised or embossed U.S. MAIL lettering was painted blue. In 1967, "local" and "out of town" decals were introduced, for placement on the undersides of snorkels on dual collection boxes, where they would be visible to motorists.

In May 1964, the Post Office Department hired the design firm Raymond Loewy/William Snaith, Inc., to study the design of collection boxes and other equipment with a view to saving money by simplifying painting operations, among other things. The next year, Loewy/Snaith suggested painting collection boxes one color instead of three, recommending a sky-blue color. Sky-blue paint was tested on a few trucks, but the color failed to impress postal officials. In 1968, the Department began testing dark blue collection boxes in four cities. To make them easier to find at night, the boxes had reflective decals featuring the words "U.S. MAIL" and the Department's post rider seal. By April 1969, Department officials settled on the dark blue color.

Dark Blue, with Decals, since 1970

On April 9, 1970, the Post Office Department approved the "One Color Letter Box Painting Program" for all street collection boxes, changing boxes to dark blue. The program was phased in gradually, as boxes needed to be repainted. Reflective red and white decals featuring the words "U.S. MAIL" and the Post Office Department post rider seal were placed on each box.

On August 12, 1970, following the signing of the *Postal Reorganization Act*, Postmaster General Winton Blount unveiled a new color scheme for collection boxes — a solid deep blue color, with reflective decals featuring the Postal Service's new eagle seal. The decals were first available for ordering in March 1971 and were placed on boxes as they needed to be repainted.



Red, White, and Blue Box, 2010
Boxes were painted red, white, and blue from 1955 to 1970.



Experimental Dark Blue Box, 1968
The Department tested dark blue boxes with reflective decals in four cities beginning in 1968.



Collection Box, 1975
In April 1970, the Department approved the "One Color Letter Box Painting Program," changing boxes to dark blue. Decals with the Postal Service's new eagle seal were placed on boxes beginning in March 1971.



Eagle decals: 1971–1992 design at left, 1992–1993 design at right (2016 photo)

courtesy of Sara A. Martin

In 1992, newly designed eagle decals were placed on boxes that needed refurbishing. The eagle decals changed again in 1993.

In early 1971, special mailboxes were installed in hundreds of towns and cities to facilitate next-day delivery of airmail. They were similar to regular blue mailboxes, but were painted white on top and were labeled for "AIRMAIL ONLY."⁶⁴

In addition to box decals featuring the Postal Service's seal, other decals were added, providing information specific to certain mailboxes, like the type of mail collected or the time of the last collection (see Appendix 2, "Box Decals with Service Information Since 1971," on page 14).

In November 1985, the Postal Service introduced new Express Mail collection boxes painted silver, red, and blue. Express Mail collection boxes were redesigned in 1992, and changed to all-blue in 1996. (See Appendix 3, "Mailboxes for Express Mail and Priority Mail Express," on page 15.)

Beginning in August 1992, eagle decals with the new U.S. Mail emblem, the "eagle and bar," were placed on collection boxes that needed refurbishing. In December 1993, the eagle decal was redesigned to feature the Postal Service's new "sonic eagle" logo.

Temporary Promotional Use of Collection Boxes, since 2007

In March 2007, the Postal Service unveiled a special mailbox designed to look like the droid from *Star Wars*, R2-D2. More than 400 R2-D2 mailboxes were placed in cities throughout the United States in connection with a stamp issuance celebrating the 30th anniversary of the movie. These were regular mailboxes wrapped with a vinyl "skin." They were removed from service later that year.

In December 2013, the cartoon character SpongeBob SquarePants appeared on collection boxes in 13 cities. The boxes were part of a letter-writing campaign geared towards children, in partnership with Nickelodeon. The program was initially intended to last only a month, but was extended until June 2014; some of the boxes remained in place through 2015.

Beginning with the 2014 holiday season, the Postal Service temporarily transformed collection boxes into animated holiday experiences, visible only through mobile devices via an augmented reality app. When customers scanned a collection box with their smartphone using the app, they saw flashing holiday lights, dancing penguins, and wrapped gifts, followed by prompts to order stamps and free shipping boxes.



Collection Box, 2004

Decals with the Postal Service's "sonic eagle" logo were placed on boxes beginning in December 1993.



R2-D2 Mailbox, 2007

courtesy of hairygrumpy, "R2-D2 mailbox - 2," cropped, CC-BY-2.0, via [Flickr](#)

In 2007, the Postal Service temporarily placed more than 400 R2-D2 mailboxes in cities nationwide in connection with a stamp issuance celebrating the 30th anniversary of *Star Wars*.



SpongeBob Mailbox, 2013

In December 2013, the Postal Service temporarily placed SpongeBob SquarePants collection boxes in 13 cities as part of a letter-writing campaign.

Table 1: Number of Collection Boxes in Select Cities in 1911

Post Office	Letter Boxes	Package Boxes	Combination Boxes
Brooklyn, NY	2,389	492	49
New York, NY	2,997	611	--
Philadelphia, PA	4,065	564	27
St. Louis, MO	1,929	281	316
Pittsburgh, PA	1,548	38	214
Baltimore, MD	925	178	224
Cincinnati, OH	783	27	262
Chicago, IL	4,838	1,018	47
Boston, MA	3,131	230	161
San Francisco, CA	1,027	121	159
Washington, DC	1,358	285	132
Cleveland, OH	792	78	190
Totals	25,782	3,923	1,781

Source: Hearings Before the Committee on Expenditures in the Post Office Department, House of Representatives, on House Resolution No. 109, to Investigate the Post Office Department, Hearing No. 10, City Delivery in Brooklyn, New York, July 6, 1911 (Washington, DC: Government Printing Office, 1911), 673-695.

Table 2: Number of Collection Boxes, 1975 to 2015

Year	Number of Boxes
1975	303,563
1980	275,000
1985	302,782
1990	281,000
1995	336,000
2000	365,000
2005	345,000
2010	170,120
2015	153,999

*Sources: USPS, except for 1990–2005 figures, from Universal Postal Union's *Postal Statistics**

Appendix 1: Experimental Collection Boxes, 1950s–1960s

Foot-Pedal Mailbox, 1956

A foot-pedal mailbox, designed for hands-free operation, was tested in Washington, DC, in 1956. The tests were not a success. A postal official later explained: "When there's snow, you can't see the pedal. And when there isn't snow, there are kids, who love to pull the works apart."⁶⁵



Mailbox with "Push In" Slots, 1961

In 1958, postal engineers developed a mailbox with three "push in" slots, for one-handed operation. The 1961 *Annual Report of the Postmaster General* explained that it had "separate openings for letters, bulk mail, and auto curb service" and that it might "gradually replace the present box which is difficult to use if the mailer is carrying a package."⁶⁶



Stainless Steel Mailbox, 1967

Stainless steel collection boxes were tested beginning in 1964 but never caught on. "ABCD," on the side of the box pictured, referred to Accelerated Business Collection and Delivery, a 1960s service that offered same-day delivery of mail within the central business area of large cities. The program was phased out partly because many businesses relocated from city centers to the suburbs.



Appendix 2: Box Decals with Service Information Since 1971

Beginning August 30, 1971, new "Airmail" decals and red reflective stripes replaced the painted lettering on boxes designated for airmail only, while a decal with a jet plane in red on a white background was placed in front of the mail drop.

Beginning in May 1972, Labels 55 and 55-A, collection schedule decals — centered in front of the mail drop — replaced the collection schedule cards on boxes. At the same time, white star decals were used on certain boxes to indicate later mail pickup times — one star indicated a pickup time of 5 p.m. or later, while "two star" mailboxes had the latest pickups, scheduled no earlier than 6:30 and as close to 8:00 p.m. as possible.⁶⁷

Beginning in December 1973, Label 162, for use on collection boxes intended for the deposit of local mail only, with LOCAL DELIVERY in large white letters on a blue background, was placed on the side panels of boxes, above the eagle decal.

In October 1977, Label 59, "Last Pickup --- PM," listing the last pickup at half-hour intervals from 5 p.m. to 8 p.m., replaced the white stars on boxes with late pickup times. In 1984, the wording was changed to "Last Collection --- PM."

Beginning in August 1996, letters and packages bearing postage stamps and weighing 16 ounces or more were prohibited from being deposited in collection boxes. Decal DDD1, "STOP!" — alerting customers of the new policy — was placed on collection boxes. In July 2007, the decal was revised to reflect a new 13-ounce limit, and in August 2012, it was revised again to list new restrictions on the deposit of international mail.

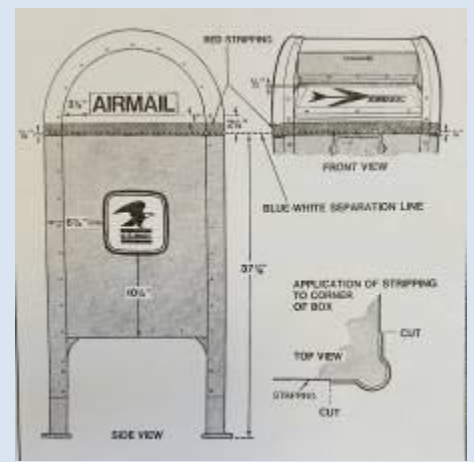

Airmail Decals, 1971

New airmail decals for airmail-only boxes were illustrated in the August 26, 1971, issue of the *Postal Bulletin*. Airmail service was discontinued in May 1977.



One-Star Mailbox, 1970s

From 1972 to 1977, white stars on some mailboxes indicated later mail pickup times.



Decal DDD1, August 1996



Decal DDD1, July 2007



Decal DDD1, August 2012



Snorkel Mailbox, 2015

courtesy of Kevin A. Mueller

Since October 1977, mailboxes with late pickup times have had decals listing the time of the last pickup.

Appendix 3: Mailboxes for Express Mail and Priority Mail Express

In November 1985, the Postal Service installed new silver, red, and blue Express Mail collection boxes in Kansas City, Memphis, New York, Philadelphia, and San Francisco. By July 1986, more than 6,000 of the boxes had been installed nationwide.

Beginning in October 1992, Express Mail collection boxes featured a new silver, red, and blue color scheme with large decals of an eagle's head. In September 1996, the box changed to all-blue and featured decals with the Postal Service's new "sonic eagle" emblem.

In July 2013, Express Mail was renamed Priority Mail Express and the collection boxes were redesigned to incorporate the new name.



Express Mail Collection Box, 1985–1992 design (1986 photo)



Express Mail Collection Box, 1992–1996 design (2007 photo) *courtesy EraserGirl, "USPS mailboxes," cropped, CC-BY-2.0, via Wikimedia Commons*



Express Mail Collection Box, 1996–2013 design (2001 photo)



Priority Mail Express Collection Box, 2013 to date (2016 photo)

¹ Prior to the establishment of free city delivery in 1863, residents of dozens of cities could choose to have their letters delivered for a one- or two-cent fee per letter, paid directly to the carrier. This system of paid delivery was referred to as the "penny post" and the carriers were sometimes called "penny postmen."

² Edwin Williams, *The New-York Annual Register for the Year of Our Lord 1834* (New York, NY: Edwin Williams, 1834), 110. Until July 1863, carriers were entitled by law to charge a fee of one or two cents for taking letters to the Post Office, but fees were not consistently charged.

³ Barnabas Bates, *A Brief Statement of the Exertions of the Friends of Cheap Postage in the City of New York* (New York, NY: Wm. C. Bryant & Co. Printers, 1848), iv. Bates was assistant Postmaster of New York City in the 1830s.

⁴ Private posts provided letter delivery for a fee in dozens of cities in the 1840s and 1850s, in competition with the U.S. Post Office. Private carriers provided boxes for the deposit of letters as early as 1841.

⁵ *Annual Report of the Postmaster General, 1842*, 755. The Post Office's "regular carriers" continued to deliver non-local letters.

⁶ Postmaster General Cave Johnson to the Postmaster of Jersey City, New Jersey, May 3, 1848, Letter Book R2 (March 31, 1847 – May 17, 1848), page 444, in *Letters Sent by the Postmaster General*, Record Group 28, National Archives and Records Administration.

⁷ *The [New Orleans] Times-Picayune*, August 12, 1851, 3.

⁸ Pliny Miles, *Postal Reform: Its Urgent Necessity and Practicability* (New York, NY: Stringer & Townsend, 1855), 40-41.

⁹ *Journal of the Common Council of the City of Philadelphia: Beginning May 10, and Ending November 4, 1858* (Philadelphia, PA: Inquirer Printing Office, 1858), 207–208.

¹⁰ *Scientific American*, July 9, 1859, 24.

¹¹ *Boston Daily Traveller*, August 2, 1858, 1; in *America's Historical Newspapers* (Readex), March 28, 2016. In addition, 11 iron letter boxes were placed in Boston hotels, and one was placed on the east wall of the Massachusetts General Hospital yard. A letter of April 19, 1858, from Capen to Caleb Stetson, indicates that Boston's first iron letter boxes were not attached to lampposts, but were securely fastened to buildings (see *Correspondence respecting postal improvements, and the removal of the Boston post office ... April 1858*, in Library of Congress, *Printed Ephemera: Three Centuries of Broadides and Other Printed Ephemera*, <https://www.loc.gov/item/rbpe.06301100>, accessed March 22, 2017).

¹² New York City's letter boxes were described as "tin tea-canisters" in *American Gas-Light Journal*, October 1, 1859, 60; and as "tin boxes ... in corner groceries and rum holes" in the *New York Times*, November 9, 1859, 4. Some published accounts have incorrectly claimed that the *American Gas-Light Journal* specified that lamppost boxes were installed in New York City on August 2, 1858, the date they were first used in Boston.

¹³ House. *Copies of Contracts—Post Office Department*, June 23, 1860. 36th Congress, 1st session, Document 100, 34–35. Accessed via <http://books.google.com> on April 1, 2016.

¹⁴ *Ibid.* Murray presumably installed the first 200 boxes in January 1860 — the March 5, 1860, issue of the *New York Times* reported that one of his employees had been stealing mail from one of the boxes since January 31. Murray had contracted with the Postmaster General on December 21, 1859, to supply 2,000 boxes; this contract was superseded by a new contract dated April 16, 1860.

¹⁵ *Annual Report of the Postmaster General, 1860*, 516.

¹⁶ *Annual Report of the Postmaster General, 1862*, 90. Blood's Despatch — the largest private carrier in Philadelphia — went out of business in 1862. On March 2, 1861, Congress had included "post routes" in the postal monopoly (12 Stat. 205), which made private posts more clearly illegal.

¹⁷ 12 Stat. 704. Initially, cities were eligible for free delivery service if their Post Office's revenue was sufficient to pay for the service. Over time the requirements to establish service were eased.

¹⁸ July 17, 1863, letter from Postmaster General Montgomery Blair to Joshua Jones, Postmaster of Trenton, New Jersey, partial transcription in files of USPS Historian.

¹⁹ These instructions, approved by the Postmaster General on November 22, 1864, were included in a letter of November 23, 1864, from First Assistant Postmaster General Alexander W. Randall to Joseph W. Briggs. A published copy of the letter is in the files of the USPS Historian.

²⁰ Research notes in the files of the USPS Historian refer to a letter of November 10, 1866, from Joseph W. Briggs, special agent in charge of superintending the city delivery service, to the Postmaster of Trenton, New Jersey, which indicates that letter boxes may have been standardized by that date. Neither the original nor a copy of the letter could be found.

²¹ Strong was awarded Patent No. 462,224 for the round-top letter box on October 27, 1891, even though it was designed by Post Office Department officials. See *Kirk v. United States*, decided January 3, 1893, in *Cases Decided in the Court of Claims of the United States ... from October, 1892, to May, 1893*, Volume XXVIII (Washington, DC: Government Printing Office, 1894), 41–51. Accessed via <http://books.google.com> on May 5, 2016.

²² *Ibid.*

²³ For an account of letters deposited in a fire hydrant, see *The United States Mail and Post Office Assistant*, February 1868, 353. For an account of an attempt to mail a letter in a fire alarm box, see *The United States Mail*, February 1886 supplement, 8.

²⁴ An article in the July 20, 1890, issue of *The Washington Post* noted that two residents of Baltimore, Maryland — Robert F. and Samuel F. Register — claimed that Doremus infringed on their own design, patented on July 24, 1888. Meanwhile, an article in the September 25, 1890, issue of *The (New York) World* noted that Joseph H. McDonald of New York claimed that Doremus infringed on McDonald's letter box patent, dated August 7, 1888.

²⁵ Francis C. Huebner, editor, *Official Opinions of the Assistant Attorneys-General for the Post-Office Department from April 29, 1885, to March 17, 1892*, Volume II (Washington, DC: Government Printing Office, 1905), 939–940.

²⁶ House. *Investigation of the Post Office Department*, January 11, 1904. 58th Congress, 2nd Session, Document 383, 90, 106.

²⁷ *Los Angeles Times*, January 27, 1890, 7.

-
- ²⁸ Cited in the *St. Paul [MN] Daily Globe*, December 26, 1891, 3.
- ²⁹ Marshall Cushing, *The Story of Our Post Office* (Boston, MA: A. M. Thayer & Co., 1893), 239.
- ³⁰ House. *Investigation of the Post Office Department*, January 11, 1904. 58th Congress, 2nd Session, Document 383, 106–112.
- ³¹ *The Michigan Steel Box Co. v. The United States*, in *Cases Decided in the Court of Claims of the United States at the Term of 1913–1914* (Washington, DC: Government Printing Office, 1915), 424. Accessed via <http://books.google.com> on May 5, 2016.
- ³² *Investigation of the Post Office Department*, January 11, 1904. 58th Congress, 2nd Session, House Document 383, 108.
- ³³ In 1903, more than 40 postal inspectors investigated contract frauds in the Post Office Department, resulting in the removal or resignation of 17 postal employees. See House, *Investigation of the Post Office Department*, January 11, 1904, 58th Congress, 2nd Session, Document 383.
- ³⁴ *Annual Report of the Postmaster General*, 1904, 580.
- ³⁵ Order No. 590, June 23, 1905, *Miscellaneous Orders of the Postmaster General*, volume 9, page 490.
- ³⁶ *Annual Report of the Postmaster General*, 1908, 132.
- ³⁷ Order No. 2073, February 15, 1909, *Miscellaneous Orders of the Postmaster General*, volume 14, page 585.
- ³⁸ *The Postmasters' Advocate*, August 1911, 30.
- ³⁹ Order No. 5816, September 21, 1911, *Miscellaneous Orders of the Postmaster General*, volume 16, page 23.
- ⁴⁰ Order No. 6898, March 3, 1913, *Miscellaneous Orders of the Postmaster General*, volume 17, page 154.
- ⁴¹ Letter from Fourth Assistant, Division of City Delivery, to First Assistant, dated June 27, 1914, in USPS Library Vertical Files ("Boxes – Mail, Street Letter").
- ⁴² In 1911 and again in 1916, the Post Office Department and the New York Art Commission tentatively agreed on a more ornamental mailbox design, but both times the Department balked when it learned the cost of manufacturing the proposed boxes. See Michele H. Bogart's *The Politics of Urban Beauty: New York and Its Art Commission* (Chicago, IL: The University of Chicago Press, 2006), 65–72.
- ⁴³ *The Postmasters' Advocate*, April 1916, 225. Box dimensions for the No. 1 (small), No. 2 (medium), and No. 3 (large) boxes were provided in the Post Office Department's 1914 edition of the *List of Postal Supplies* (page 34).
- ⁴⁴ Post Office Department news release, November 2, 1922.
- ⁴⁵ House. *Investigation of the Post Office Department*, January 11, 1904. 58th Congress, 2nd Session, Document 383, 113.
- ⁴⁶ *Ibid.*, 113-114.
- ⁴⁷ *Annual Report of the Postmaster General*, 1895, 115-116.
- ⁴⁸ Streetcar railway mail service began in Saint Louis in 1892, with postal clerks aboard streetcar Railway Post Offices (RPOs) collecting, sorting, and distributing mail along their routes. The service peaked in 1910, when 16 cities had streetcar mail service. Beginning about 1914, the service began to be replaced by automobiles. The last streetcar RPOs made their final trips in Baltimore in November 1929. Streetcar RPOs generally had slots for the deposit of mail. Separately, some cities experimented with letter boxes attached to regular streetcars — for example, in Chicago beginning in 1873, in Baltimore beginning in 1889, and in Des Moines, Iowa, from 1897.
- ⁴⁹ *Annual Report of the Postmaster General*, 1898, 149.
- ⁵⁰ *Annual Report of the Postmaster General*, 1904, 580; and House, *Decisions of the Commissioner of Patents and of the United States Courts in Patent and Trade-Mark and Copyright Cases*, June 12, 1919, 66th Congress, 2nd Session, Document 809 (Washington, DC: Government Printing Office, 1920), 437.
- ⁵¹ The date is recorded on specifications for the "Large Collection Box" (a technical drawing) dated May 5, 1922, with changes through August 12, 1957, located in the collection of the USPS Historian.
- ⁵² The Post Office Department tested dual letter boxes, for local and out-of-town letters, in Washington, DC, as early as December 1922.
- ⁵³ *New York Times*, February 22, 1860, 5.
- ⁵⁴ The December 1, 1882, issue of the *Reading [PA] Times*, stated that boxes were in the process of being painted "dark green," while the October 11, 1883, issue of the *Oakland [CA] Tribune* noted that boxes were being painted "bright green." Boxes were painted "Hibernian" according to the September 28, 1871, issue of the *Memphis [TN] Daily Appeal*, while the January 13, 1878, issue of *The Times-Picayune* (New Orleans) referred simply to "green" boxes.
- ⁵⁵ *The United States Mail*, July 1887, 143.
- ⁵⁶ W. B. Jones, *The Story of the Post Office, Containing a History of the World's Postal Service* (Burlington, VT: Wells, Richardson & Co., 1889), 79–80.
- ⁵⁷ Red lettering was mentioned in the November 2, 1897, issue of *The Allentown [PA] Leader*, and the January 8, 1899, issue of *The Times-Picayune* (New Orleans).
- ⁵⁸ *Annual Report of the Postmaster General*, 1905, 669.
- ⁵⁹ *The Washington Times*, June 9, 1908, 14.
- ⁶⁰ *Postal Bulletin* 10064, February 28, 1913. The coach red color was anticipated by December 1912, when the Purchasing Agent for the Post Office Department noted that an advertisement for new-style boxes would soon be issued calling for boxes and posts "to be painted a coach red." The agent noted that "as the Postmaster General has made an order that all such equipment shall be painted every two years, the mail receptacles throughout the country will hereafter be a credit to the department" (*Annual Report of the Postmaster General*, 1912, 45–46).
- ⁶¹ Order No. 7106, May 10, 1913, *Miscellaneous Orders of the Postmaster General*, volume 17, page 372.
- ⁶² U.S. Post Office Department, *List of Postal Supplies*, July 1, 1932, 43. Later accounts attributed the olive green color to a surplus of olive drab paint that the Post Office Department received from the War Department following World War I. Postal records, however, show that the Post Office Department purchased paint on the open market after WWI.
- ⁶³ *New York Times*, March 6, 1953, 25.
- ⁶⁴ Airmail service ended in 1977.
- ⁶⁵ *The [Sunday] Star Magazine* (Washington, DC), March 22, 1959, 13.
- ⁶⁶ *Annual Report of the Postmaster General*, 1961, 32.
- ⁶⁷ For more information see *Postal Bulletin* issues dated May 11, 1972 (2-3), and October 6, 1977 (10), at www.uspostalbulletins.com.