

BB

GANIL

LE LABORATOIRE NATIONAL D'IONS LOURDS - CAEN
LE COMPLEXE NATIONAL IN2P3 (CNRS) - D.S.M. (CEA)

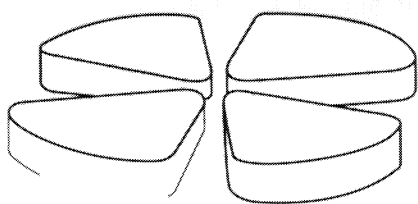

Study of the $N=50$ shell closure close to ^{78}Ni

D Verney

GANIL, BP 55027, 14076 Caen Cedex 5, France

F Ibrahim, O Perru, O Bajeat, C Bougeois, F Clapier, E Cottureau, C Donzaud, S Du,
M Ducourtieux, S Essabaa, S Galès, L Gaudefroy, D Guillemaud Mueller, F Hammache,
F Hosni, C Lau, H Lefort, F Le Blanc, A C Mueller, N Pauwels, J C Potier, F Pougheon,
J Proust, B Roussière, J Sauvage, O Sorlin
IPN, 91406 Orsay cedex, France

*V Latinamerican Symposium on Nuclear Physics
Santos (Brazil), 1-5 September 2003
Submitted to the Brazilian Journal of Physics*

CERN LIBRARIES, GENEVA

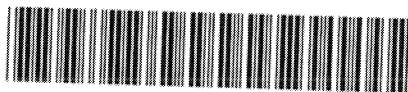

CM-P00047892

GANIL P 04 03

Study of the N=50 shell closure close to ^{78}Ni

D Verney

GANIL, BP 55027, 14076 Caen Cedex 5, France

F Ibrahim, O Perri, O Bajeat, C Bougeois, F Clapier, E Cottureau, C Donzaud, S Du, M Ducourtieux, S Essabaa, S Galès, L Gaudefroy, D Guillemaud-Mueller, F Hammache, F Hosni, C Lau, H Lefort, F Le Blanc, A C Mueller, N Pauwels, J C Potier, F Pougheon, J Proust, B Roussière, J Sauvage, O Sorlin

IPN, 91406 Orsay cedex, France

Abstract The PARRNe (Production d Atomes Radioactifs Riches en Neutrons) experimental program has been part of the recent R&D efforts for the design of the SPIRAL2 project at GANIL. The PARRNe2 set-up installed at IPN-Orsay allows the use of the Tandem as a deuteron driver in order to produce mass separated fission fragment beams. The measured fission fragment yields proved to be high enough to undertake a series of β -decay experiments dedicated at studying the structure of proton-deficient nuclei close to N=50. We report here on two such experiments, the first being dedicated at the observation of the decay of $^{83}\text{Ga} \rightarrow ^{83}\text{Ge}$ ($Z=32$, $N=51$) $^{84}\text{Ga} \rightarrow ^{84}\text{Ge}$ ($Z=32$, $N=52$) and the second of the decay of $^{81}\text{Zn} \rightarrow ^{81}\text{Ga}$ ($Z=31$, $N=50$) allowing for the first time the identification of a few γ lines with transitions in the daughter nuclei thus providing the material for a preliminary glimpse of their structure.

1 Introduction

Shell gap reinforcements and disappearances proved to be widespread in the nuclide chart. They constitute in most occasions the underlying basement of the most interesting features of the nuclear structure far from stability. In certain cases the importance of these phenomena was such that the question to know “how magic are the magic numbers far from stability” could be quite rightly raised. Our studies aim at contributing to the understanding of these features by probing the stiffness of the N=50 shell closure and its influence on the structure of the proton deficient nuclei towards ^{78}Ni . The structure of the N=50 nuclei is known from both β -decay and direct reaction experiments down to ^{84}Se [1]. Below mass 84, ^{83}As was populated in the decay of ^{83}Ge [2] and ^{82}Ge in the decay of ^{82}Ga [3]. Therefore, γ -spectroscopy of fission fragments turned out to be the unique source of spectroscopic information for the most proton deficient N=50 isotones (though this situation is likely to change soon thanks to the production of post accelerated neutron rich Ge beams at Oak-Ridge see the contribution from D. Bardayan to this conference). Our work can be considered, in a sense, as some kind of continuation of the pioneering work undertaken in this mass region during the 70-80's on mass separators like TRISTAN or OSIRIS [4] operating at high flux neutron reactors. The PARRNe2 set-up (see fig. 1) was first built to serve as a test device for the SPIRAL2 project to optimize the various parameters concerning the converter geometry, the extraction and ionization for fission fragments produced in a thick target using a deuteron beam. The simultaneous use of a UC_x target and a plasma ion-source of the MK5 ISOLDE type allowed us to produce most of the the non-refractory elements fed by fission and to systematically measure their effective yields at the collection point (see fig. 1) [5]. For certain metallic ions like Zn for instance, these yields proved to be high enough to envisage studies of the decay of some fission products close to ^{78}Ni which were not reported before.

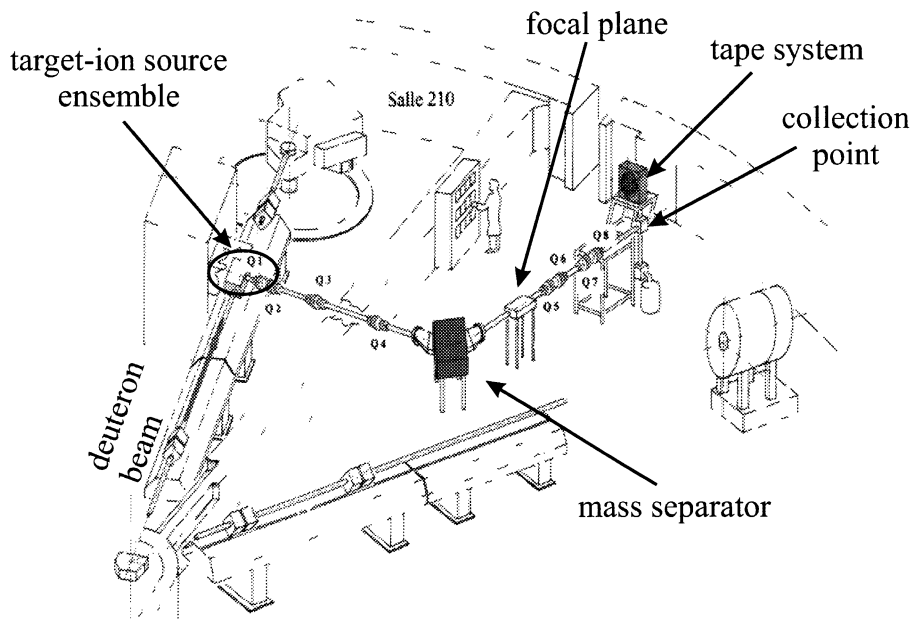

Figure 1 The PARRNe2 mass separator facility at the Tandem of Orsay

2 Experimental procedure

The Ga and Zn sources were obtained with an incident 26 MeV deuteron beam impinging on a graphite converter placed close to the UC_x target ($50 \text{ g of } ^{238}\text{U}/\text{cm}^2$) at 2000°C . The target was connected to a hot-plasma ion source of the MK5 ISOLDE type at 1800°C . The ions were extracted at 30 kV, mass separated using the PARRNe2 mass separator and deposited on a movable Al-coated mylar tape. The γ measurements were made with two HPGe detectors (20% relative efficiency) placed in 180° geometry close to the point at which the beam was deposited onto the tape. The deposit point was surrounded by a tube shaped plastic scintillator with an acceptance solid angle of nearly 4π steradians for β detection. Enhancement of the activities of interest was made by moving cyclically the tape after a short build-up and decay time. Each single β or γ event was labelled by its own absolute time measured from the beginning of each cycle with an accuracy of 400 ps using a dedicated 6-fold peak sensing ADC called COMET-6X [6]. Double $\beta-\gamma$ and $\gamma-\gamma$ as well as triple $\beta-\gamma-\gamma$ coincidence events were constituted and recorded on line, but it is worth mentioning that since each single event is recorded with its associated absolute time, any coincidence gate can be used in the off-line analysis. The energy resolution achieved for the Ge detectors was of the order of 2.3 keV at 1 MeV. Examples of β gated spectra obtained during these experiments are given in fig. 2 and 3. The measured yields were of the order of 0.1 to 1 per second for the Ga isotopes and a few tenths per second for ^{81}Zn .

The ^{83}Ga decay experiment The mass separator was first set on mass 83. No γ activity of ^{83}Ga has been reported previously to this experiment. On fig. 2 part of the β gated spectrum recorded at mass 83 is represented. Two lines which were unknown at mass 83 were observed at 866 keV and 1238 keV. Their decay times which

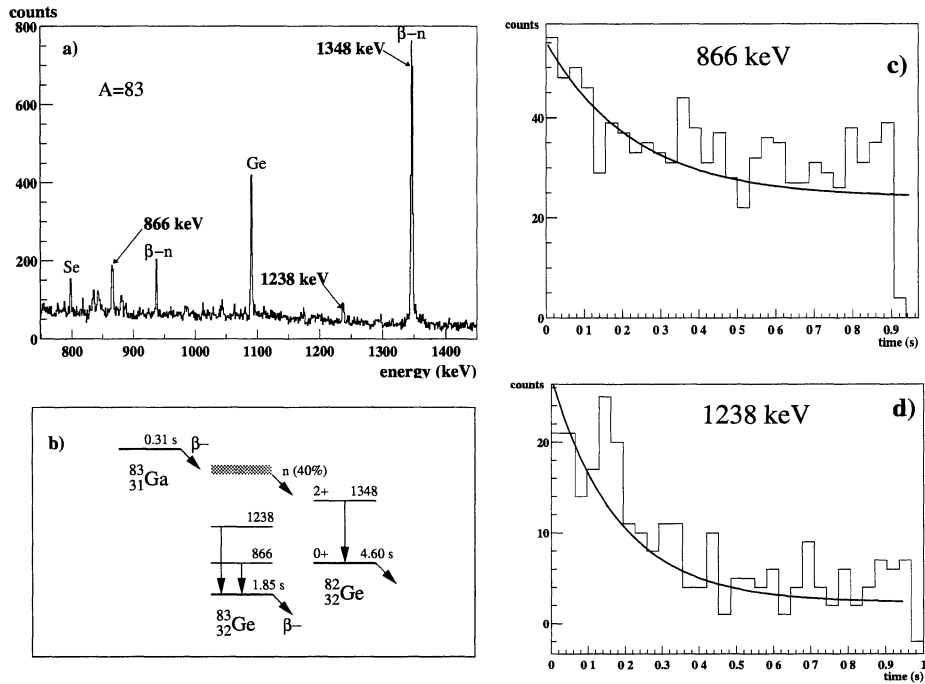

Figure 2 a) Part of the γ -ray spectrum measured at mass 83 in β coincidence b) Schematic representation of some of the observed transitions fed in the ^{83}Ga decay c) Time spectrum and fitted decay curve for the line at 866 keV, the deduced period is 250 ± 161 ms d) Time spectrum and fitted decay curve for the line at 1238 keV, the deduced period is 260 ± 140 ms

were deduced from their time spectra represented in c) and d) on fig. 2 are consistent with the known half-life of ^{83}Ga [7]. Therefore we attributed them to transitions in ^{83}Ge . It is possible, though rather unlikely, that these two transitions or at least one of them fall on a supplementary level situated very close to the ground state. Therefore it is difficult to deduce a level scheme from this study, and the level scheme presented on b) in fig. 2 must be considered as a working hypothesis. At last, it is worth mentioning that the 1348 keV line corresponding to the $2^+ \rightarrow 0^+$ transition in ^{82}Ge was clearly seen in the $A=83$ spectra as it is shown in a) on fig. 2. This confirms that we successfully managed to produce ^{83}Ga .

On a second step, the mass separator was set on mass 84. It was very difficult to find out any new line having the decay time of ^{84}Ga though we knew for sure that the ^{84}Ga was produced since the 866 keV line previously attributed to a transition in ^{83}Ge was identified again in the $A=84$ spectra. One possible candidate is a weak line observed at 820 keV. Unfortunately it seemed not to be confirmed in a recent experiment at ISOLDE-CERN [8]. More details on our Ga β -decay experiment will be found in an article to be published in EPJ [9].

The ^{81}Zn decay experiment The principle of this experiment is the same as the previous one. We used for the first time with success a new target ion-source ensemble completely made by the Orsay group using the ISOLDE MK5 technology. An unknown ray at 351.1 keV was found on-line. Its decay time corresponds to the known period of ^{81}Zn of 290 ± 50 ms [10], it can then be attributed to a transition in

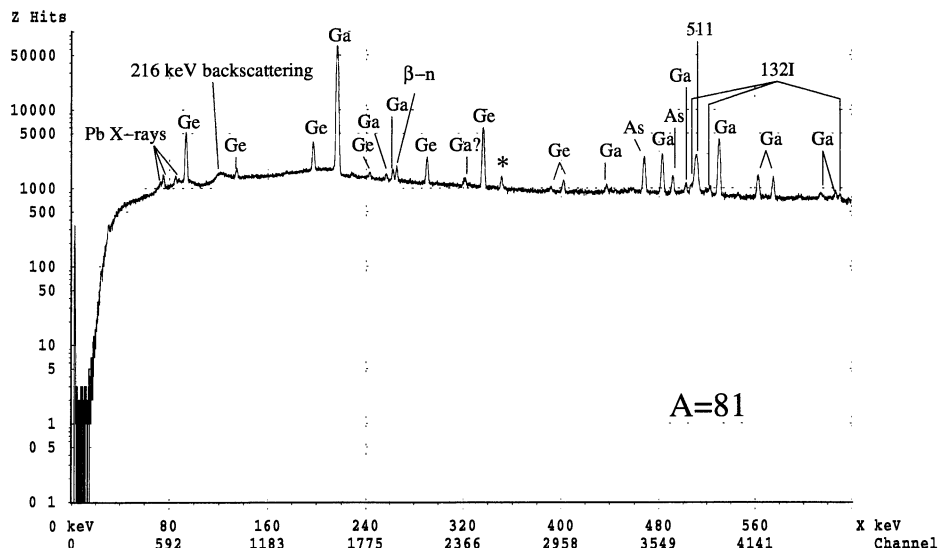

Figure 3 Part of the γ -ray spectrum measured at mass 81 in β coincidence. The * symbol indicates the new line at 351.1 keV which is a good candidate for the decay of ^{81}Zn . The line at 265.4 keV corresponds to a transition in ^{80}As fed by the decay of ^{80}Ge which is produced in the β -n decay of ^{81}Ga . The activity of ^{132}I was also identified, it comes from a previous setting on mass 132 which is oftenly used as a reference in our experiments.

^{81}Ga . The statistics was enough to allow coincidence observation. The γ coincidence spectra are shown in fig. 4. In the spectrum gated on 351.1 keV shown in a) on fig. 4 one can see a new peak at 451.7 keV which was barely noticeable in the β gated spectrum only. The other line at 216 keV corresponds to the most intense line from the ^{81}Ga activity (37.4% absolute intensity) which dominates by far the activity in the $A=81$ spectra. In the coincidence γ spectrum on the weak 451.7 keV line represented in b) on fig. 4 one can see again the 351.1 keV peak thus establishing the existence of a level at 802.8 keV. The intensity of the 351.1 keV line is higher by a factor of two to three therefore we assumed the 351.1 keV transition to be below the 451.7 keV one. Another weak line was found at 1621.6 keV. From this we propose the preliminary and tentative level scheme as represented on fig. 5. In this figure, this level scheme is compared with the result of the shell model calculation of Ji and Wildenthal [11]. They assumed an inert ^{78}Ni core and a closed neutron shell thus reducing the valence space to the proton orbitals $1p_{3/2}$, $0f_{5/2}$, $1p_{1/2}$ and $0g_{7/2}$. They used an empirical effective interaction fitted on a carefully selected set of experimental levels [12]. One of the most important predictions was the existence of a doublet of $3/2^-$ and $5/2^-$ levels separated by only 64 keV with the $3/2^-$ as the ground state. This is at variance from the experimental situation in the neighbouring odd isotone $^{83}_{50}\text{As}_{33}$ which is predicted and supposed to have a $5/2^-$ ground state [2] as can be seen on the right part of fig. 5. Interestingly, the very scarce ^{81}Ga level scheme deduced from this work looks rather like the ^{83}As experimental level scheme than the theoretical one, except if one accepts the idea that there is a 300 keV error in the energy prediction for the first excited state. On the other hand, the apparent similarity between the two experimental level schemes may be extremely misleading due to the low quantity of data we have.

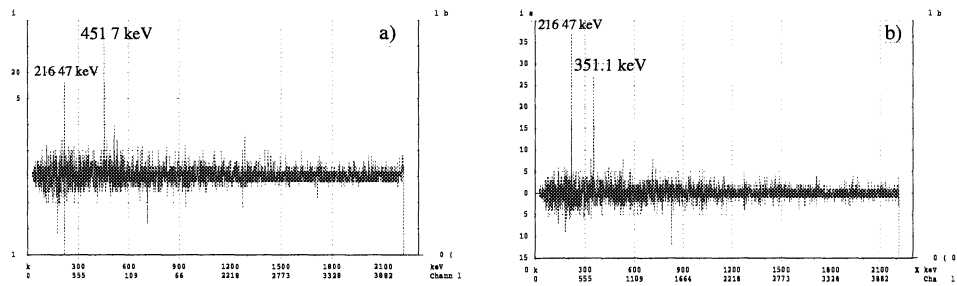

Figure 4 γ -ray coincidence spectra from the decay of ^{81}Zn for the 351.1 keV line in a) and for the 451.7 keV line in b)

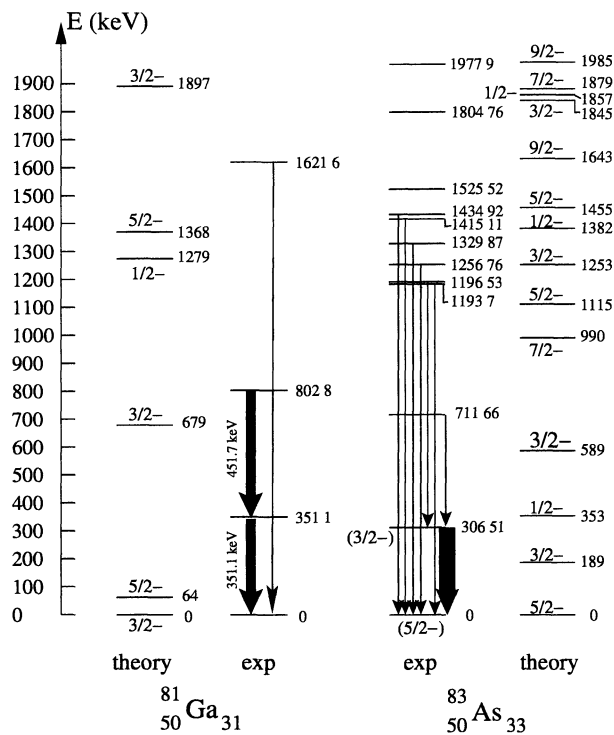

Figure 5 Tentative experimental level scheme for $^{81}\text{Ga}_{31}$ compared with the neighbouring odd isotone $^{83}\text{As}_{33}$ [2]. Both experimental level schemes are compared with the results from the shell model calculation of ref. [11]. The experimental levels of ^{83}As are from ref. [2].

Besides, the status of the 711 keV in ^{83}As (which would be analogous to our 803 keV level) was discussed in ref. [13] and revealed itself as difficult to understand. More precisely its belonging to the valence space is not well accounted for by the calculations while the empirical effective interaction gives *two* intermediate levels $3/2^-$ and $1/2^-$ (see fig. 5) between the first excited state and the dense group of levels situated above 1000 keV, the use of a modified Surface Delta Interaction leads to *no* intermediate level at all [13]. At last, it should be mentioned that the transition between the 711 keV level and the 306 keV level in ^{83}As has an intensity by one order of magnitude

smaller than the transition between the 306 keV level and the ground state while apparently, in the case of ^{81}Ga , though the 451 keV transition is weaker than the 351 keV, the order of magnitude is the same

3 Conclusion

We managed to obtain new results on states in very neutron rich nuclei close or at $N=50$ from β -decay experiments using an experimental set-up, PARRNe2, which at the very beginning, was dedicated to R&D studies for SPIRAL2. In a sense, these results can be considered as the very first results from the “low energy” part of the SPIRAL2 scientific program which concerns the use of fission fragment beams which are *not* post-accelerated. Thanks to the 100 time increased yields available in a near future at the PARRNe2 mass separator facility with ALTO [14] our objective becomes twofold: improving our detection system to get complementary spectroscopic information by adding *e.g.* a neutron detector and/or an electron/X detector together with developing chemical selective target ion-source ensembles *and* performing experiments of strong physical interest in the $N=50$ region. Therefore from now on we are energetically contributing to the preparation of both the experimental and theoretical tools which will be needed to welcome the first SPIRAL2 beams.

References

- [1] J V Kratz *et al*, Nucl Phys A **250**, 13 (1975), S M Mullins, Phys Rev C **37**, 587 (1988)
- [2] J A Winger *et al*, Phys. Rev. C **38**, 285 (1988)
- [3] P Hoff and B Fogelberg, Nucl Phys A **368**, 210 (1981)
- [4] J R McConnell and W L Talbert, Jr, NIM **128**, 227 (1975), Rudstam *et al*, NIM **139**, 239 (1976)
- [5] C Lau *et al*, NIM B **204**, 246 (2003)
- [6] <http://ipnweb.in2p3.fr/~sep/comet/comet.html>
- [7] S-C Wu, NDS **92**, 893 (2001)
- [8] U Koster, private communication
- [9] O Perru *et al* submitted to EPJ
- [10] K-L Kratz *et al*, Z Phys A **340**, 419 (1991)
- [11] X Ji and B H Wildenthal, Phys Rev C **40**, 389 (1989)
- [12] X Ji and B H Wildenthal, Phys Rev C **37**, 1256 (1988)
- [13] J C Hill *et al*, Vth International conference on Nuclei far from stability, Rosseau Lake Canada 1987, I S Towner editor, AIP Conf. proc. **164**, p 375 (1988)
- [14] S Essabaa *et al*, NIM B **204**, 780 (2003) and the contribution from F Ibrahim to this conference