

FLUOROCARBON EVAPORATIVE COOLING DEVELOPMENTS FOR THE ATLAS PIXEL AND SEMICONDUCTOR TRACKING DETECTORS

E. Anderssen¹, D. Bintinger¹, S. Berry², P. Bonneau², M. Bosteels², P. Bouvier³, D. Cragg⁴, R. English⁴, J. Godlewski^{5,2}, B. Gorski⁶, S. Grohmann^{7,2}, [G. Hallewel](mailto:hallewel@atlas.cern.ch)^{8,2}, T. Hayler⁴, S. Ilie², T. Jones⁹, J. Kadlec¹⁶, S. Lindsay¹⁰, W. Miller¹¹, T. Niinikoski², M. Olcese¹², J. Olszowska⁵, B. Payne⁴, A. Pilling⁴, E. Perrin³, H. Sandaker^{13,2}, J-F.Seytre^{14,2}, J. Thadome¹⁵, V. Vacek^{16,2}

¹E.O.Lawrence Berkeley National Laboratory, USA; ²CERN; ³Geneva University, Switzerland;

⁴Rutherford Appleton Laboratory, Chilton, UK; ⁵Institute of Nuclear Physics, Cracow, Poland;

⁶University of Technology, Cracow, Poland; ⁷I.L.K., Dresden, Germany; ⁸Centre de Physique des Particules de Marseille, France; ⁹Liverpool University, UK; ¹⁰Melbourne University, Australia; ¹¹Hytec Inc, Los Alamos, USA;

¹²INFN & Genoa University, Italy; ¹³Institut National des Sciences Appliquées, Toulouse, France;

¹⁴Ecole Nationale Supérieure de Mécanique des Fluides, Toulouse, France; ¹⁵Wuppertal University, Germany;

¹⁶Czech Technical University, Prague, Czech Republic

(Email: hallewel@atlas.cern.ch)

ABSTRACT

We report on the development of evaporative fluorocarbon cooling for the ATLAS Pixel and Semi-Conductor Tracker (SCT) detectors. Data are presented from cooling studies on representative prototype Pixel and SCT detector thermo-structures, using perfluoro-n-propane (C₃F₈), -butane (C₄F₁₀), trifluoro-iodo-methane (CF₃I) and custom C₃F₈/C₄F₁₀ mixtures. Thermo-physical properties were calculated for custom mixtures.

For most of the structures tested at full projected power dissipation, operation of silicon detector substrates at temperatures below -7°C (required for 10 year lifetime in the radiation environment of LHC) should be possible, albeit in some cases with increases in inner diameter (I.D.) of the coolant tubes from those of the present series of prototypes.

Heat transfer coefficients in the range 2-5.10³ Wm⁻²K⁻¹ have been measured in a 3.6 mm I.D. heated tube dissipating 100 Watts - close to the full equivalent power (~110 W) of a barrel SCT detector “stave” - over a range of power dissipations and mass flows in the above fluids.

Aspects of full-scale evaporative cooling circulator design for the ATLAS experiment are discussed, together with plans for future development.

1. INTRODUCTION

The SCT detector [1] will have 4 cylinders around the collision point (*barrel*) and 9 forward disks at each end. Each cylinder consists of “staves” containing 12 silicon strip detector modules, while disks contain 132 modules. The total SCT dissipation will be around 41.3kW, with ~9.2W from each module, subdivided into ~2W (after 10

years of irradiation) from the silicon substrate, and ~7W from the readout electronics.

The pixel detector [2] has ten forward disks and three cylinders containing staves of 13 pixel detector modules. The total detector dissipation will be around 18.7 kW, with around 7.9W from each module (11W in the B-physics layer at a radius of ~4.5 cm from the beams).

Our studies [3],[4] have been directed to cooling systems contributing the minimal possible material, particularly important for the pixel B layer. Evaporative fluorocarbon cooling combines high heat transfer coefficients with very low circulating coolant mass (1-2gram.s⁻¹/100W to evacuate). Liquid refrigerant can be delivered to the detector in capillaries with IDs as small as 0.6 mm. Furthermore, fluorocarbon refrigerants are non-flammable, non-toxic insulators with zero ozone depletion potential.

Table 1: Selected Refrigerant Properties (-15° C)

Fluid <i>[ref for calcn]</i>	L (Jg ⁻¹)	Vol _(vap) / cm ³ _(liq)	S.V.P (bar a) @ -15° C
C ₃ F ₈ [5],[7]	97.0	71.4	2.46
C ₄ F ₁₀ [5],[7]	101.1	242.6	0.58
CF ₃ I [7]	100.8	176.3	1.33
C ₃ F ₈ / C ₄ F ₁₀ (50/50) [8],[9]	98.3	147.6	1.01P _{SV} → 1.65 P _{SL}

Latent heat data for the various refrigerants are shown in table 1, together with their saturated vapor pressures and the volume of vapor produced per cm³ liquid evaporated at -15°C (a temperature chosen to accommodate probable thermal impedances between the silicon substrate and the coolant). A target evaporation pressure of 1 bar (abs)

would allow the use of very low mass tube (~0.2 mm wall aluminum or composite) in a variety of aspect ratios.

2. TEST RESULTS ON SCT AND PIXEL PROTOTYPE THERMO-STRUCTURES

2.1 The Refrigerant Recirculator

A closed-loop evaporative recirculator (figure 1) has been built for testing thermo-structures using all the fluids of table 1. Structures are placed in a chamber purged with inert gas and maintained at -7°C , to simulate the environment of the SCT and pixels in the ATLAS inner detector.

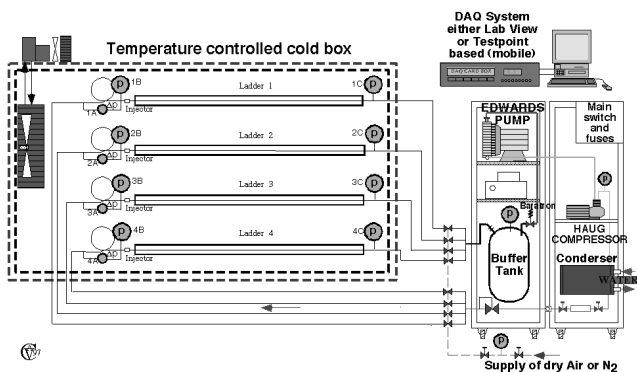

Figure 1: The Two-Stage Evaporative Recirculator

The present circulator contains two compressor stages and a water-cooled condenser, also serving as a high-pressure liquid refrigerant reservoir. The first stage compressor¹ is used only with low input pressure vapors as in the case of C_4F_{10} or $\text{C}_3\text{F}_8/\text{C}_4\text{F}_{10}$, since the pumping speed of the second stage² compressor is insufficient at input pressures below 1 bar abs. These compressors will soon be replaced with a single stage dry scroll compressor (Atlas Copco SF4-8-120) with a measured flat pumping speed of $\sim 20 \text{ m}^3\text{hr}^{-1}$ for both C_4F_{10} ($P_{\text{in}} = 0.25$, $P_{\text{out}} = 4$ bar abs) and C_3F_8 ($P_{\text{in}} = 1.4$, $P_{\text{out}} = 8$ bar abs).

Liquid refrigerant enters a four-channel supply manifold, whose pressure - defined by a regulator - determines the liquid mass flow. Fluid enters the test structures via capillaries with diameters varying between 0.6 and 1 mm, or via injectors made from synthetic ruby watch bearings with orifices varying between 210 and 300 μm .

The temperature of evaporation of fluid in the test structures depends on the pressure in a 4-channel vapor collection manifold tank, controlled via feedback from a

¹ Edwards ECP 30 Dry Rotary Scroll Vacuum pump
(rated $30 \text{ m}^3\text{hr}^{-1}$ air; P_{in} 1 bar abs, $P_{\text{out}} = 1.5$ bar abs limit)

² Haug SOGX 50-D4 Dry Piston Compressor
(rated $3.6 \text{ m}^3\text{hr}^{-1}$ air, P_{in} 1 bar; $P_{\text{out}} = 9$ bar abs limit)

pressure sensor³ to a variable orifice valve located between the tank and the compressor input. The circulating mass flow is metered after the tank.

2.2 Tests on a Forward SCT Thermo-Structure

Figure 2 shows a recent model for the on-detector cooling for a quarter disk of the ATLAS forward SCT, in which 18 similar disks will each support 132 silicon strip modules, and dissipate 1.2kW.

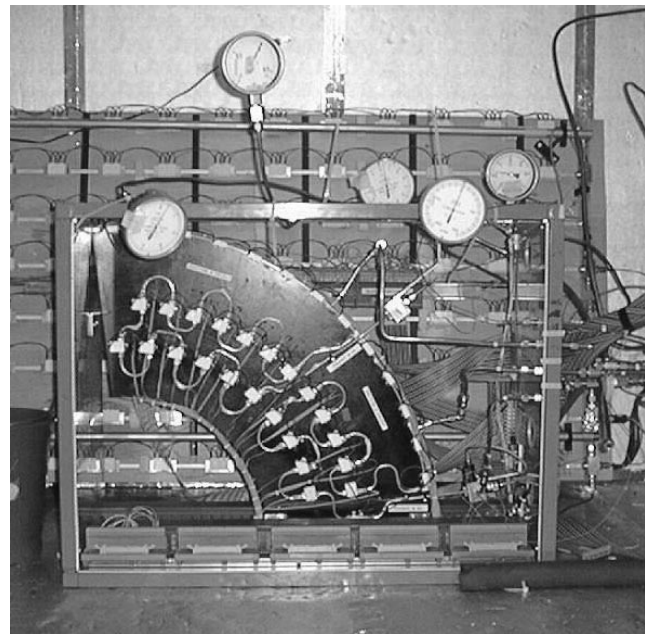

Figure 2: Forward SCT Quadrant Thermal Model

On the “front”, heat from two arcs of silicon micro-strip modules (simulated with resistive heaters) is conducted to the coolant via attachment blocks glued to the cooling tubes (figure 3). On the “rear” a third arc of modules will provide tacking hermeticity through overlap.

To accommodate thermal expansion effects, each quadrant has two serpentine circuits with 3.6 mm ID tubes, and lengths 2.5 & 3.5 m (“A”&“B”), respectively cooling 14 and 19 modules. Each circuit first cools the inner front arc of modules, follows an arc at the outer radius, and then cools the modules on the rear of the panel.

Thermal connections to the cooling tube are of several types: some attachment blocks evacuate the simulated 7W power of the module readout electronics (“E”): those along the front outer arc evacuate only $\sim 2\text{W}$ of substrate (“S”) dissipation. The innermost front blocks traverse the support, and evacuate, in addition to the 9W (E+S) dissipation of the front inner modules, $\sim 2\text{W}$ from the simulated substrates of the rear modules. Blocks are of

³ MKS Baratron Model 122B Range 0-5000 Torr (abs)

several different heights, and some span a gap between joined tubes, presenting lower impedance for heat conduction into the fluid.

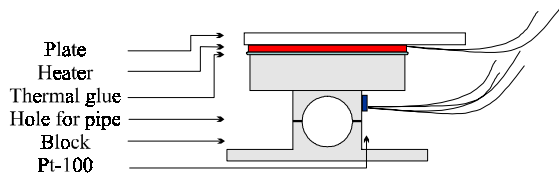

Figure 3: Module Heat Sinking in the Forward SCT Through the use of Attachment Blocks.

Figure 4 shows the temperature profile along circuit “B” with C_4F_{10} at half-nominal power (3.42W (E); 0.97W (S)). The tube is everywhere below $10^\circ C$: with the exhaust cooler than the input (characteristic for evaporative cooling), in this case by $6^\circ C$. Most blocks lie below the target temperature of $-7^\circ C$. The six with double-sided heating are considerably warmer (from $-2^\circ C$ to $-5^\circ C$) than the (S) blocks or those spanning a tube join.

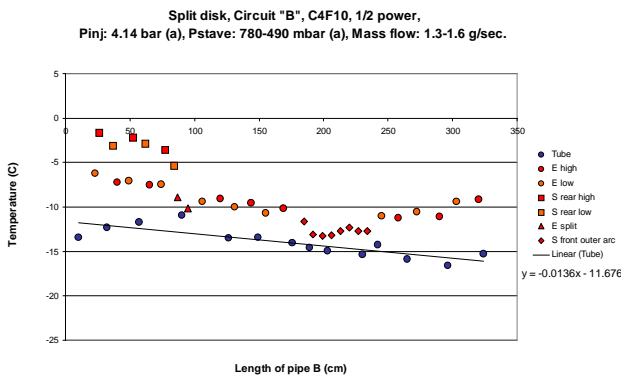

Figure 4: SCT Disk: C_4F_{10} at half power: circuit “B”.

We could not cool the present structure to $-7^\circ C$ at the full power dissipation with C_4F_{10} , due to the large pressure gradient along the 3.6 mm ID tube, generated by the relatively large volume of vapor produced (table 1) at low boiling pressures of around 500 mbar (abs).

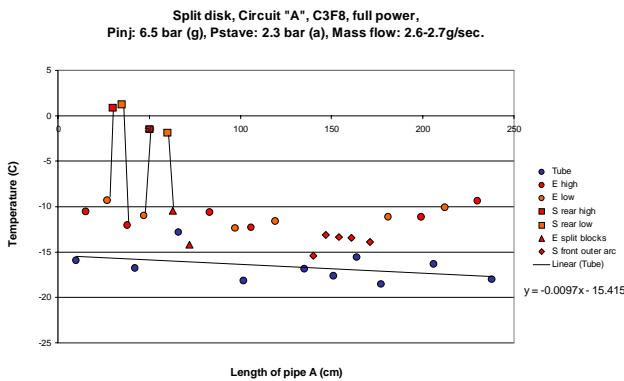

Figure 5: SCT Disk: C_3F_8 at full power: circuit “A”.

For C_3F_8 the results were significantly better. At full power (7W (E); 2W (S)) and a boiling pressure 2.3 bar a, the temperature of all blocks, with the exception of the rear “S” side of the double block (now being redesigned), were below $-6^\circ C$, and the temperature gradient along the tube was only $\sim 2^\circ C$. The temperature difference between the blocks and the tube was also less, probably due to a higher heat transfer coefficient for C_3F_8 . By decreasing this boiling pressure, the temperature of the test structure could be further, uniformly, reduced.

2.3 Tests on SCT Barrel Structures

The present cooling circuit manifolding proposed for the SCT barrel is shown in figure 6. Coolant is injected through a capillary to a series pair of staves with a total tube length of 3.2m. A common exhaust is shared with a second series pair of staves mounted in parallel.

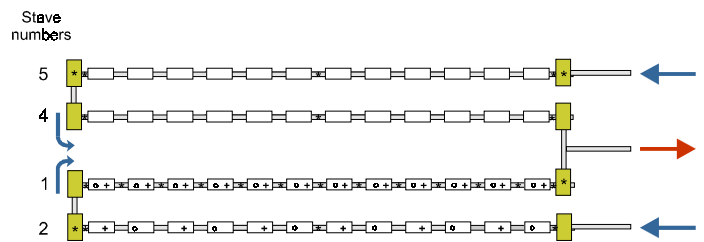

Figure 6: SCT Barrel Stave 4-fold Manifold

In the present thermo-structure, each stave carries 12 heater plates attached with thermally conductive glue to one 7.2mm side of a flat-walled oval tube having an equivalent I.D. of 2.7mm. A total of 64 temperature sensors are attached to the plates and on the tubes between them. Plates are laminated from two (60 x 20 mm) pieces of aluminum with thermally conductive glue, to investigate the layering of the detector module, in which the hybrid supporting the readout electronics (“E”) is mounted on top of the silicon substrate (“S”), which has closer attachment to the cooling tube. Temperature sensors are mounted on the E and S sides of the blocks.

Figure 7 shows sample data taken with C_3F_8 at $\sim 9W/block$. The temperature (pressure) gradient between the input of the first series stave and the output of the second is $\sim 7^\circ C$ (1.1 bar). Block temperatures vary between $-2^\circ C$ and $-13^\circ C$, and the target (S) temperature of $-7^\circ C$ is not met at the beginning of the first stave. The (60 x 7mm) film of thermal glue fastening the blocks to the tube causes an average temperature difference of $\sim 7^\circ C$ between the tube and the S sides of the blocks. The E sides are $\sim 2^\circ C$ warmer. It was concluded that the 2.7 mm ID of the cooling tubes in the present thermo-structure was insufficient to evacuate the

vapor produced from ~220W dissipation of two staves in series.

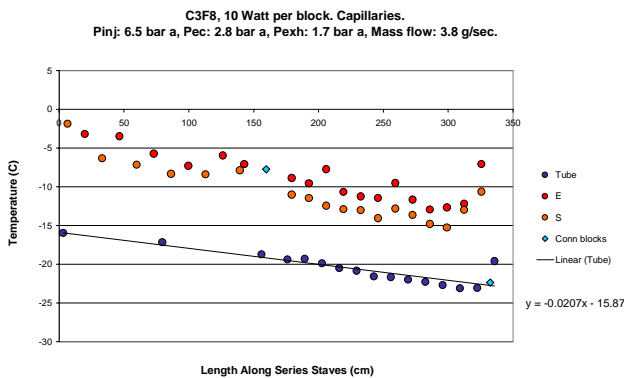
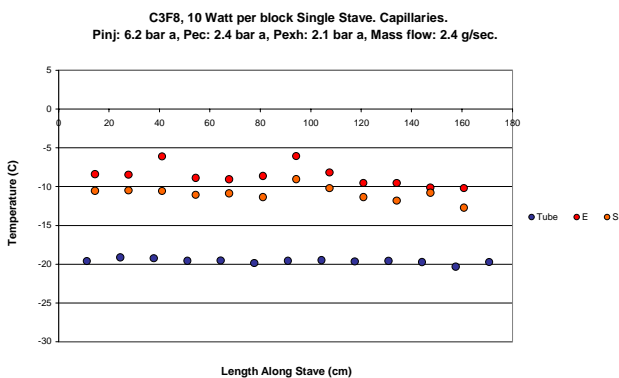

Figure 7: Barrel SCT Manifold Test with C_3F_8 :
10 Watts per block, two staves in series

Figure 8 is an example of test data with the manifold rebuilt for a “single pass” of refrigerant. The temperature (pressure) profile along the 1.6m stave with the 2.7mm ID tube is ~2°C (0.3 bar). Block temperatures (E) vary between -8°C and -11°C, and the target (S) temperature of -7°C was met everywhere along the stave.

Figure 8: Forward SCT Manifold Test with C_3F_8 :



10 Watts per block, single stave

Two-phase flow pressure drop calculations indicate a total pressure drop of 350 mbar in a series pair of SCT staves each dissipating ~110W, if a tube hydraulic ID of ~4mm is used: the next iteration of the SCT stave will study a tube of this dimension.

2.4 Tests on Pixel Forward Structures

Thermal measurements have been made on a developmental series of forward pixel disk sector thermo-structures [2], in which cooling tubes bent in ‘W’ or ‘WV’ shapes are sandwiched between skins of Carbon-Carbon (C-C). In some structures, an aluminum tube with slightly flattened faces was used, while in others, a

glassy carbon tube, “flocked” with grown-on carbon fibers is bonded to the C-C plates. Figure 9 shows the thermal profile on a prototype sector with a 3.2 mm ID carbon tube and C_4F_{10} coolant at a boiling pressure of 345mbar. This sector dissipated a total of 38W. More recent structures have higher dissipation and a shorter cooling tube with increased diameter. The temperature profile on the sector was found to be invariant with orientation [2].

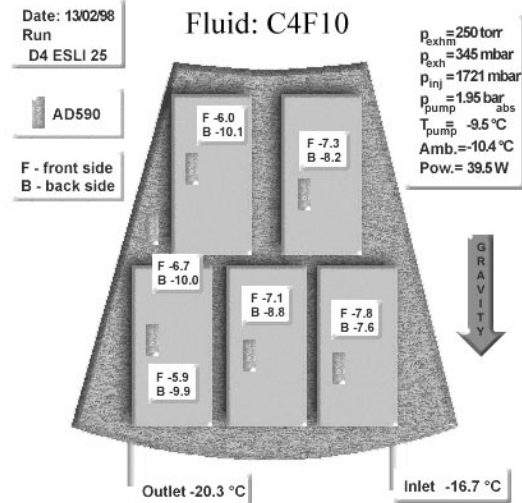

Figure 9: C Pixel Disk Sector Test Data (C- tube: C_4F_{10})

2.5 Tests on Pixel Barrel Structures

Thermal measurements have been made on an 80cm pixel barrel stave thermo-structure (figure 10) with a 3.4 mm equivalent ID cooling channel made from a carbon fiber U channel glued to a sealed C-C support plate, onto which 13 dummy pixel modules are glued. In the pixel cooling layout, pairs of staves in the 2 outer ($r = 10, 13$ cm) pixel layers dissipate ~100W and share a common exhaust tube. In the B-layer the higher occupancy closer to the beams, stave dissipation is ~143W.

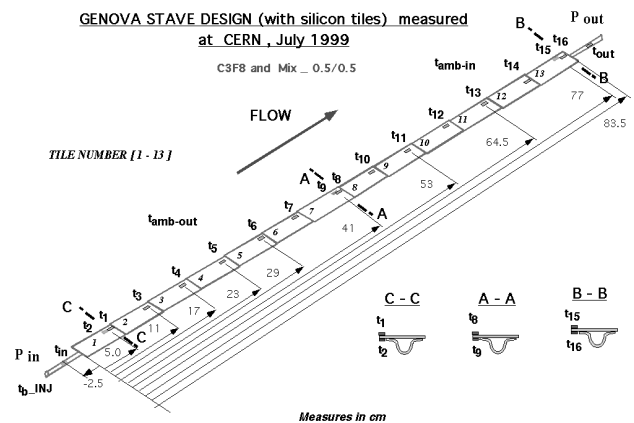

Figure 10: Pixel Stave Carbon-Carbon thermo-structure

Figures 11a & b show the temperature profile along the stave for CF₃I and C₄F₁₀ for power loads varying between 78W and 143W, for C₃F₈ at a power of 100W and for a 50/50 (molar) C₄F₁₀/C₃F₈ mixture at 55W. The average silicon temperatures at the different boiling pressures are given in table 2.

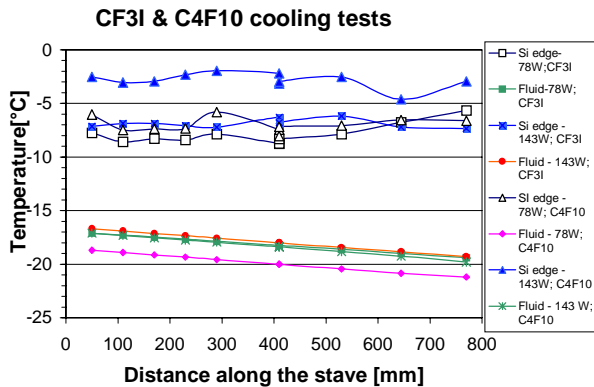

Figure 11a: Temperature Profiles along the Pixel C-C stave: CF₃I and C₄F₁₀

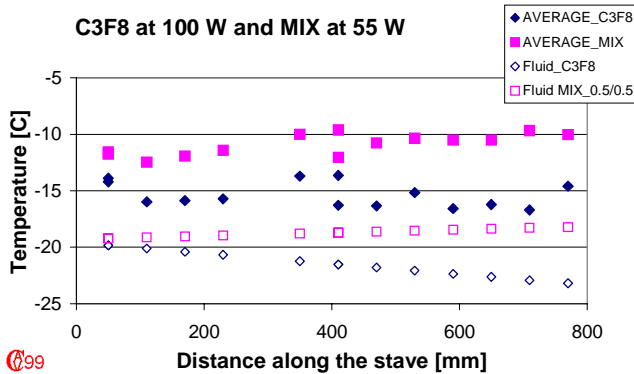

Figure 11b: Temperature Profiles along the Pixel C-C stave: C₃F₈ and 50% C₄F₁₀/50% C₃F₈ molar mixture.

Table 2: Temperature Profile Summary for different fluids: pixel stave thermo-structure

Fluid	Power on pixel stave (W)	Boiling Pressure (bar abs)	Average Silicon Temp
CF ₃ I	78	1.10	-8.0
	143	1.08	-7.0
C ₄ F ₁₀	78	0.35	-7.0
	143	0.40	-3.5
C ₃ F ₈	100	1.67	-15.0
C ₃ F ₈ / C ₄ F ₁₀ (50/50)	55	0.83	-11.0

It was found that the ID of the present pixel stave tube is insufficient to maintain the -7°C silicon temperature with C₄F₁₀ at dissipations exceeding ~80W, and with the 50/50 C₄F₁₀/C₃F₈ mixture at dissipations exceeding ~60W, but that cooling to the target temperature was possible, both

with CF₃I and C₃F₈ at the highest envisaged dissipation (figure 11b). The next version of the pixel stave will use a 4.6 mm equivalent ID tube, which should be large enough to allow pairs of pixel staves to be connected in series.

3. MEASUREMENT OF HEAT TRANSFER COEFFICIENT

A second refrigerant recirculator was constructed to allow simultaneous measurements of heat transfer coefficient (HTC) while full size thermo-structure prototypes were measured in the main circulator. Heat transfer coefficients were measured on a 1.6m long simplified SCT stave with 12 copper blocks soft-soldered onto a 1.6 m long cupronickel tube with 3.6mm ID. On each block were a ceramic heater and a PT100 sensor. PT100's were fitted to the coolant tube in 13 positions between the blocks and at each end. Another sensor measured the liquid temperature upstream of the capillary or injector. In this tube, HTC's were measured at 12 points along the tube from the (block-tube) temperature difference, and knowledge of the dissipation at each block and its contact area with the tube. Typical HTC measurements for the different fluids in this tube are shown in figure 12, and varied in the range 2-5.10³ Wm⁻²K⁻¹ depending on power dissipation. The highest HTC's were seen in the case of C₃F₈, and the lowest with 50/50 C₄F₁₀/C₃F₈. Reduced HTC's for mixtures have been reported elsewhere[10].

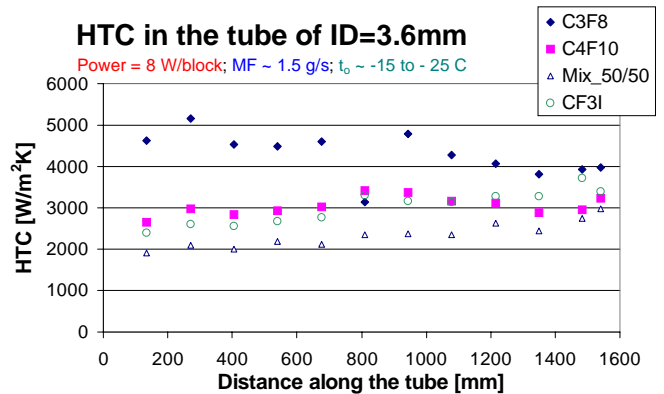

Figure 12: Heat Transfer Coefficients in a 3.6mm ID tube: C₄F₁₀, CF₃I, C₃F₈ & 50% C₄F₁₀/50% C₃F₈ mixture at similar power and flow rate.

4 REFRIGERANT IRRADIATION STUDY

4.1 Effects of Neutron Irradiation

Small, static liquid samples of perfluoro-n-hexane (C₆F₁₄), CF₃I, solid Teflon and iodine (I₂) were irradiated up to 3x10¹³ fast neutrons.cm⁻² to simulate the expected environment at LHC. Studies showed the main longest-lived radioisotopes to be ¹⁸F (106 min: 511 KeV

γ emitter) and ^{128}I (25 min: 433 KeV γ emitter). From neutron capture cross section data, the expected activity levels for these radionuclides are in the range 10^4 - 10^5 Bq.g $^{-1}$ during circulation (for an instantaneous rate $\sim 10^6$ n.cm $^{-2}$ s $^{-1}$), which is believed to be acceptable in a closed circuit system. However, the overall measured level of I_2 activation was measured to be very high.

4.2 Radiation-Induced Chemical Modifications

Small, static liquid samples of C_6F_{14} and CF_3I were exposed to ^{60}C gamma irradiation. After an absorbed dose of 3 Mrad, about 1% by weight of C_6F_{14} liquid had been radio-chemically modified: there was chemical evidence of the production of reactive HF, due to impurities containing C-H groups. Scanning electron microscopy and Auger electron spectroscopy were used to characterize the morphologies and elemental compositions of C, F and O- containing polymeric deposits formed on stainless steel and aluminum samples immersed in liquid during irradiation. After 6Mrad, surfaces were almost uniformly covered to a depth of ~ 0.4 μm . Degradation and plate-out were greater in a sample of C_6F_{14} to which 3% (vol.) n-heptane had been added to act as a H-source.

Since saturated fluorocarbons ($\text{C}_n\text{F}_{(2n+2)}$), are synthesized from alkane precursors, batch testing for residual H contamination (using the characteristic Fourier Transform Infra-Red signature of C-H bonds) is advisable. Techniques for the catalytic removal of $\text{C}_n\text{F}_x\text{H}_{(2n-x)}$ contamination were developed [11] for the DELPHI RICH detector, where high fluid purity is needed for good UV transparency: similar techniques could be used in the present application.

After irradiation to 2Mrad, liquid CF_3I had become opaque, and breakdown of CF_3I into I_2 and HI was seen. This was not a complete surprise, since CF_3I is a refrigerant with a short (~ 24 hr) atmospheric half-life. Oily residues (pre-polymers) were observed after the evaporation of the irradiated CF_3I , and thick deposits, including crystalline I_2 were observed on aluminum and stainless steel immersion samples. Although it was possible to clean the CF_3I to remove I_2 and re-establish the transparency, CF_3I was finally abandoned as a coolant owing to its chemical aggressivity, even in the un-irradiated state, to elastomer seal materials.

5 CONCLUSION

Evaporative cooling has been demonstrated at the full power dissipation of the ATLAS SCT and pixel detectors. Studies with engineering prototypes and measurements of

heat transfer coefficient indicate that C_3F_8 is presently the best candidate refrigerant. The low boiling pressure of C_4F_{10} (~ 350 mbar abs @ $\sim -25^\circ\text{C}$) allows a small pressure head to drive vapor back to the compressor input. Of the fluids with "ideal" thermodynamics (saturated vapor pressure ~ 1 bar (abs) at $\sim -25^\circ\text{C}$), $\text{C}_3\text{F}_8/\text{C}_4\text{F}_{10}$ custom mixtures are less favored due to lower heat transfer coefficient, while CF_3I has been rejected due to its chemical aggressivity, poor chemical stability under ionizing radiation, and radio-activation concerns.

REFERENCES

- [1] ATLAS Inner Detector Technical Design Report **CERN/LHCC/97-16/17**, 30 April 1997
- [2] ATLAS Pixel Detector Technical Design Report **CERN/LHCC/98-13**, 31 May 1998
- [3] "Progress in Fluorocarbon Evaporative Cooling" R. Budinský, G. Hallewell, G. Lenzen, J. Thadome & V. Vacek, Proc. ATLAS Cooling Review, CERN (18-19 September, 1997)
- [4] "Evaporative Cooling: Conceptual Design for the ATLAS SCT" T. Niinikoski **ATL-INDET-98-124** (15 Oct, 1998)
- [5] Mfr: 3-M Corp. Specialty Chemicals Division, St. Paul, MN55113-3223, USA
- [6] Mfr: Ajay North America Inc. Powder Springs, GA, 30127-0127, USA
- [7] "Vapour-liquid Equilibria for Dipolar Two-Centre Lennard-Jones Fluids by Gibbs-Duhem Integration" M. Lísal, R. Budinský & V. Vacek Fluid Phase Equilibria, **135** (1997), 193
- [8] "Direct Evaluation of Vapour-Liquid Equilibria of Mixtures by Molecular Dynamics Using Gibbs-Duhem Integration" M. Lísal, & V. Vacek Molecular Simulation, **18** (1996) 75.
- [9] Custom mixture: properties with "REFPROP": Database of thermodynamic and transport properties of refrigerants and refrigerant mixtures: Version 6.01 National Institute of Standards and Technology, Gaithersburg MD 20899 USA (1998): C_4F_{10} , C_3F_8 , mix & CF_3I extensions by V. Vacek.
- [10] "Characteristics of Heat Transfer Coefficient During Nucleate Pool Boiling of Binary Mixtures" T. Inoue, N. Kawae & M. Monde: Heat & Mass Transfer **33** (1998), 337
- [11] "Per-fluorocarbon Liquid: Specific Chemical Aspects for use within the DELPHI RICH" S. Ilie & G. Lenzen: **DELPHI 93-33 RICH54**, 30 March 1993.