



Non-compensation of an Electromagnetic Compartment of a Combined Calorimeter

Y.A. Kulchitsky, M.V. Kuzmin

*Institute of Physics, National Academy of Sciences, Minsk, Belarus
& JINR, Dubna, Russia*

V.B. Vinogradov

JINR, Dubna, Russia

Abstract

The method of extraction of the e/h ratio, the degree of non-compensation, of the electromagnetic compartment of the ATLAS barrel combined prototype calorimeter is suggested. The e/h ratio of 1.74 ± 0.04 has been determined on the basis of the 1996 combined calorimeter test beam data. This value agrees with the prediction that $e/h > 1.7$ for this electromagnetic calorimeter.

1 Introduction

The existing calorimetric complexes (CDF, D0, H1 etc.) as well as the the future huge ones (ATLAS [1], CMS etc.) at the CERN Large Hadron Collider (LHC) are the combined calorimeters with the electromagnetic and hadronic compartments. For the energy reconstruction and description of the longitudinal development of a hadronic shower it is necessary to know the e/h ratios, the degree of non-compensation, of these calorimeters. As to the ATLAS Tile barrel calorimeter there is the detailed information about the e/h ratio presented in [2], [3], [4], [5], [6]. But as to the liquid argon electromagnetic calorimeter such information practically absent.

The aim of the present work is to develop the method and to determine the value of the e/h ratio of the LAr electromagnetic compartment.

This work has been performed on the basis of the 1996 combined test beam data [7]. Data were taken on the H8 beam of the CERN SPS, with pion and electron beams of 10, 20, 40, 50, 80, 100, 150 and 300 GeV/c.

2 The Combined Prototype Calorimeter

The future ATLAS experiment [1] will include in the central (“barrel”) region a calorimeter system composed of two separate units: the liquid argon electromagnetic calorimeter (LAr) [8] and the tile iron-scintillating hadronic calorimeter (Tile) [5].

For detailed understanding of performance of the future ATLAS combined calorimeter the combined calorimeter prototype setup has been made consisting of the LAr electromagnetic calorimeter prototype inside the cryostat and downstream the Tile calorimeter prototype as shown in Fig. 1.

The dead material between the two calorimeters was about $2.2 X_0$ or $0.28 \lambda_I^\pi$. Early showers in the liquid argon were kept to a minimum by placing the light foam material in the cryostat upstream of the calorimeter.

The two calorimeters have been placed with their central axes at an angle to the beam of 12° . At this angle the two calorimeters have an active thickness of $10.3 \lambda_I$.

Between the active part of the LAr and the Tile detectors a layer of scintillator was installed, called the midsampler. The midsampler consists of five scintillators, $20 \times 100 \text{ cm}^2$ each, fastened directly to the front face of the Tile modules. The scintillator is 1 cm thick.

Beam quality and geometry were monitored with a set of beam wire chambers BC1, BC2, BC3 and trigger hodoscopes placed upstream of the LAr cryostat.

To detect punchthrough particles and to measure the effect of longitudinal leakage a “muon wall” consisting of 10 scintillator counters (each 2 cm thick) was located behind the calorimeters at a distance of about 1 metre.

2.1 The Electromagnetic Liquid Argon Calorimeter

The electromagnetic LAr calorimeter prototype consists of a stack of three azimuthal modules, each one spanning 9° in azimuth and extending over 2 m along the Z direction. The calorimeter structure is defined by 2.2 mm thick steel-plated lead absorbers, folded to an accordion shape and separated by 3.8 mm gaps, filled with liquid argon. The signals are collected by Kapton electrodes located in the gaps. The calorimeter extends from an inner radius of 131.5 cm to an outer radius of 182.6 cm, representing (at $\eta = 0$) a total of 25 radiation lengths (X_0), or 1.22 interaction lengths (λ_I) for protons. The calorimeter is longitudinally segmented into three compartments of $9 X_0$, $9 X_0$ and $7 X_0$, respectively. More details about this prototype can be found in [1], [9].

In front of the EM calorimeter a presampler was mounted. The active depth of liquid argon in the presampler is 10 mm and the strip spacing is 3.9 mm.

The cryostat has a cylindrical form with 2 m internal diameter, filled with liquid argon, and is made out of a 8 mm thick inner stainless-steel vessel, isolated by 30 cm of low-density foam (Rohacell), itself protected by a 1.2 mm thick aluminum outer wall.

2.2 The Hadronic Tile Calorimeter

The hadronic Tile calorimeter is a sampling device using steel as the absorber and scintillating tiles as the active material [5]. The innovative feature of the design is the orientation of the tiles which are placed in planes perpendicular to the Z direction [10]. For a better sampling homogeneity the 3 mm thick scintillators are staggered in the radial direction. The tiles are separated along Z by 14 mm of steel, giving a steel/scintillator volume ratio of 4.7. Wavelength shifting fibers (WLS) running radially collect

light from the tiles at both of their open edges. The hadron calorimeter prototype consists of an azimuthal stack of five modules. Each module covers $2\pi/64$ in azimuth and extends 1 m along the Z direction, such that the front face covers 100×20 cm². The radial depth, from an inner radius of 200 cm to an outer radius of 380 cm, accounts for 8.9λ at $\eta = 0$ ($80.5 X_0$). Read-out cells are defined by grouping together a bundle of fibers into one photomultiplier (PMT). Each of the 100 cells is read out by two PMTs and is fully projective in azimuth (with $\Delta\phi = 2\pi/64 \approx 0.1$), while the segmentation along the Z axis is made by grouping fibers into read-out cells spanning $\Delta Z = 20$ cm ($\Delta\eta \approx 0.1$) and is therefore not projective. Each module is read out in four longitudinal segments (corresponding to about 1.5, 2, 2.5 and 3 λ_I at $\eta = 0$). More details of this prototype can be found in [1], [2].

3 Event Selection

We applied some similar to [7] cuts to eliminate the non-single track pion events, the beam halo, the events with an interaction before LAr calorimeter, the events with the longitudinal leakage, the electron and muon events. The set of cuts is the following:

- the single-track pion events were selected by requiring the pulse height of the beam scintillation counters and the energy released in the presampler of the electromagnetic calorimeter to be compatible with that for a single particle;
- the beam halo events were removed with appropriate cuts on the horizontal and vertical positions of the incoming track impact point and the space angle with respect to the beam axis as measured with the beam chambers;
- the electron events were removed by the requirement that the energy deposited in the LAr calorimeter is less than 90 % of the beam energy;
- a cut on the total energy rejects incoming muon;
- the events with the obvious longitudinal leakage were removed by requiring of no signal from the punchthrough particles in the muon walls;

- to select the events with the hadronic shower origins in the first sampling of the LAr calorimeter; events with the energy depositions in this sampling compatible with that of a single minimum ionization particle were rejected;
- to select the events with the well developed hadronic showers energy depositions were required to be more than 10 % of the beam energy in the electromagnetic calorimeter and less than 70 % in the hadronic calorimeter.

4 The e/h ratio of the LAr Electromagnetic Compartment

The response, R_h , of a calorimeter to a hadronic shower is the sum of the contributions from the electromagnetic, E_e , and hadronic, E_h , parts of the incident energy [11]

$$E = E_e + E_h , \quad (1)$$

$$R_h = e \cdot E_e + h \cdot E_h = e \cdot E \cdot (f_{\pi^0} + (h/e) \cdot (1 - f_{\pi^0})) , \quad (2)$$

where e (h) is the energy independent coefficient of transformation of the electromagnetic (pure hadronic, low-energy hadronic activity) energy to response, $f_{\pi^0} = E_e/E$ is the fraction of electromagnetic energy. From this

$$E = \frac{e}{\pi} \cdot \frac{1}{e} \cdot R_h , \quad (3)$$

where

$$\frac{e}{\pi} = \frac{e/h}{1 + (e/h - 1)f_{\pi^0}} . \quad (4)$$

In the case of the combined calorimeter the incident beam energy, E_{beam} , is deposited into the LAr compartment, E_{LAr} , into Tilecal compartment, E_{Tile} , and into the dead material between the LAr and Tile calorimeters, E_{dm} ,

$$E_{beam} = E_{LAr} + E_{Tile} + E_{dm} . \quad (5)$$

Using relation (3) the following expression has been obtained:

$$E_{beam} = c_{LAr} \cdot \left(\frac{e}{\pi}\right)_{LAr} \cdot R_{LAr} + c_{Tile} \cdot \left(\frac{e}{\pi}\right)_{Tile} \cdot R_{Tile} + E_{dm} , \quad (6)$$

where $c_{LAr} = 1/e_{LAr}$ and $c_{Tile} = 1/e_{Tile}$. From this expression the value of the $(e/\pi)_{LAr}$ ratio can be obtained

$$\left(\frac{e}{\pi}\right)_{LAr} = \frac{E_{beam} - E_{Tile} - E_{dm}}{c_{LAr} \cdot R_{LAr}}, \quad (7)$$

where

$$E_{Tile} = c_{Tile} \cdot \left(\frac{e}{\pi}\right)_{Tile} \cdot R_{Tile} \quad (8)$$

is the energy released in the Tile calorimeter.

The $(e/h)_{LAr}$ ratio and

$$f_{\pi^0, LAr} = k_{LAr} \cdot \ln E_{beam} \quad (9)$$

can be inferred from the energy dependent $(e/\pi)_{LAr}$ ratios:

$$\left(\frac{e}{\pi}\right)_{LAr} = \frac{(e/h)_{LAr}}{1 + ((e/h)_{LAr} - 1)f_{\pi^0, LAr}}. \quad (10)$$

We used the value $(e/h)_{Tile} = 1.3$ [4] and the following expression for the electromagnetic fraction of a hadronic shower in the Tilecal calorimeter

$$f_{\pi^0, Tile} = k_{Tile} \cdot \ln E_{Tile}. \quad (11)$$

with $k_{Tile} = 0.11$ [12], [13].

For the c_{LAr} constant the value of 1.1, obtained in [14], [7], was used.

The algorithm for finding the c_{Tile} and c_{dm} constants will be considered in the next section.

5 The c_{Tile} Constant

For the determining of the c_{Tile} constant the following procedure was applied. We selected the events which start to shower only in the hadronic calorimeter. To select these events the energies deposited in each sampling of the LAr calorimeter and in the midsampler are required to be compatible with that of a beam particle. We used the following expression for the normalized hadronic response [11]

$$\frac{R_{Tile}^c}{E_{beam}} = \frac{c_{Tile}}{(e/h)_{Tile}} \left(1 + \left(\left(\frac{e}{h}\right)_{Tile} - 1\right) \cdot (f_{\pi^0})_{Tile}\right), \quad (12)$$

where

$$R_{Tile}^c = R_{Tile} + \frac{c_{LAr}}{c_{Tile}} \cdot R_{LAr} \quad (13)$$

is the Tile calorimeter response corrected on the energy loss in the LAr calorimeter, $f_{\pi^0, Tile}$ is determined by the formula (11).

The values of R_{Tile}^c are shown in Fig. 2 together with the fitting line. The obtained value of c_{Tile} is equal to 0.145 ± 0.002 .

6 The Energy Loss in the Dead Material

Special attention has been devoted to understanding of the energy loss in the dead material placed between the active part of the LAr and the Tile detectors. The term, which accounts for the energy loss in the dead material between the LAr and Tile calorimeters, E_{dm} , is taken to be proportional to the geometrical mean of the energy released in the last electromagnetic compartment ($E_{LAr,3}$) and the first hadronic compartment ($E_{Tile,1}$)

$$E_{dm} = c_{dm} \cdot \sqrt{E_{LAr,3} \cdot E_{Tile,1}} \quad (14)$$

similar to [7], [15]. The validity of this approximation has been tested by the Monte Carlo simulation and by the study of the correlation between the energy released in the midsampler and the cryostat energy deposition [7], [16], [17]. We used the value of $c_{dm} = 0.31$. This value has been obtained on the basis of the results of the Monte Carlo simulation performed by I. Efthymiopoulos [18]. These Monte Carlo (Fluka) results (solid circles) are shown in Fig. 3 together with the values (open circles) obtained by using the expression (14). The reasonable agreement is observed. The average energy loss in the dead material is equal to about 3.7%. The typical distribution of the energy losses in the dead material between the LAr and Tile calorimeters for the real events at the beam energy of 50 GeV, obtained by using Eq. 14, is shown in Fig. 4.

7 The $(e/\pi)_{LAr}$ and $(e/h)_{LAr}$ Ratios.

Figs. 5 and 6 show the distributions of the $(e/\pi)_{LAr}$ ratio derived by formula (7) for different energies. The mean values of these distributions are given in Table 1 and shown in Fig. 7 as a function of the beam energy. The fit of this distribution by the expression (10) yields $(e/h)_{LAr} = 1.74 \pm$

0.04 and $k_{LAr} = 0.108 \pm 0.004$ ($\chi^2/NDF = 0.93$). For the fixed value of the parameter $k_{LAr} = 0.11$ [12] the result is $(e/h)_{LAr} = 1.77 \pm 0.02$ ($\chi^2/NDF = 0.86$). The quoted errors are the statistical ones obtained from the fit. The systematic error on the $(e/h)_{LAr}$ ratio, which is a consequence of the uncertainties in the input constants used in the equation (7), is estimated to be ± 0.04 .

Wigmans showed [12] that the e/h ratio for non-uranium calorimeters with high-Z absorber material is satisfactorily described by the formula:

$$\frac{e}{h} = \frac{e/mip}{0.41 + 0.12 n/mip} \quad (15)$$

in which e/mip and n/mip represent the calorimeter response to e.m. showers and to MeV-type neutrons, respectively. These responses are normalized to the one for minimum ionizing particles. The Monte Carlo calculated e/mip and n/mip values for the RD3 Pb-LAr electromagnetic calorimeter are $e/mip = 0.78$ and $n/mip < 0.5$ leading to $(e/h)_{LAr} > 1.66$. Our measured value of the $(e/h)_{LAr}$ ratio agrees with this prediction.

There is the estimation of the $(e/h)_{LAr}$ ratio of 3.7 ± 1.7 for this electromagnetic compartment obtained in [19] on the basis of data from the combined lead-iron-LAr calorimeter [20]. This value agrees with our value within errors. But we consider their method as the incorrect one since for the determination of the $(e/\pi)_{LAr}$ ratios the calibration constants are used which have been obtained by minimizing the energy resolution that leads to distortion of the true $(e/\pi)_{LAr}$ ratios.

8 Conclusions

The method of extraction of the e/h ratio, the degree of non-compensation, for the electromagnetic compartment of the ATLAS barrel combined prototype calorimeter is suggested. On the basis of the 1996 combined test beam data we have determined this value which turned out to be equal to 1.74 ± 0.04 and agrees with the Monte Carlo prediction of Wigmans that $e/h > 1.7$ for this LAr calorimeter.

9 Acknowledgments

This work is the result of the efforts of many people from the ATLAS Collaboration. The authors are greatly indebted to all Collaboration for their test beam setup and data taking. Authors are grateful Peter Jenni and Marzio Nessi for fruitful discussion and support of this work. We are thankful Julian Budagov and Jemal Khubua for their attention and support of this work. We are also thankful Illias Efthymiopoulos for giving the results of the Monte Carlo simulation, Irene Vichou and Marina Cobal for constructive advices and fruitful discussion.

References

- [1] ATLAS Collaboration, ATLAS Technical Proposal for a General Purpose pp Experiment at the Large Hadron Collider, CERN/LHCC/94-93, CERN, Geneva, Switzerland.
- [2] F. Ariztizabal et al., NIM A349 (1994) 384.
- [3] A. Juste, ATLAS Internal note, TILECAL-No-69, 1995, CERN, Geneva, Switzerland.
- [4] J.A. Budagov, Y.A. Kulchitsky, V.B. Vinogradov *et al.*, JINR, E1-95-513, 1995, Dubna, Russia; ATLAS Internal note, TILECAL-No-72, 1996, CERN, Geneva, Switzerland.
- [5] ATLAS Collaboration, ATLAS TILE Calorimeter Technical Design Report, CERN/LHCC/96-42, ATLAS TDR 3, 1996, CERN, Geneva, Switzerland.
- [6] Y.A. Kulchitsky, V.B. Vinogradov, JINR, E1-99-12, 1999, Dubna, Russia; ATL-TILECAL-99-002, 1999, CERN, Geneva, Switzerland.
- [7] M. Cobal *et al.*, ATL-TILECAL-98-168, 1998, CERN, Geneva, Switzerland.
- [8] ATLAS Collaboration, ATLAS Liquid Argon Calorimeter Technical Design Report, CERN/LHCC/96-41, ATLAS TDR 2, 1996, CERN, Geneva, Switzerland.
- [9] D.M. Gingrich *et al.*, (RD3 Collaboration), NIM **A364** (1995) 290.

- [10] O. Gildemeister, F. Nessi-Tedaldi and M. Nessi, Proc. 2nd Int. Conf. on Calorimetry in High Energy Physics, Capri, 1991.
- [11] D. Groom, Proceedings of the Workshop on Calorimetry for the Supercollides, Tuscaloosa, Alabama, USA, 1989.
- [12] R. Wigmans, Proc. 2nd Int. Conf. on Calorimetry in High Energy Physics, Capri, 1991.
- [13] D. Acosta *et al.*, NIM A316 (1992) 184.
- [14] Y.A. Kulchitsky, M.V. Kuzmin, JINR, E1-98-336, 1998, Dubna, Russia.
- [15] Z. Ajaltouni *et al.*, NIM **A387** (1997) 333 – 351.
- [16] M. Bosman, Y.A. Kulchitsky, M. Nessi, ATL-COM-TILECAL-99-011, CERN, Geneva, Switzerland.
- [17] ATLAS Collaboration, ATLAS Physical Technical Design Report, Volume 1, CERN-LHCC-99-02, ATLAS-TDR-14, CERN, Geneva, Switzerland.
- [18] I. Efthymiopoulos, Private communication.
- [19] M. Stipcevic, RD3 Note 44, 1993, CERN, Geneva, Switzerland.
- [20] D.M. Gingrich *et al.*, [RD3 Collaboration], NIM **A355** (1995) 295.

Table 1: The mean $(e/\pi)_{LAR}$ ratio as a function of the beam energy.

$E_{beam}(GeV)$	$(e/\pi)_{LAR}$
10	1.471 ± 0.025
20	1.419 ± 0.015
40	1.331 ± 0.017
50	1.330 ± 0.019
80	1.276 ± 0.010
100	1.278 ± 0.009
150	1.255 ± 0.009
300	1.191 ± 0.014

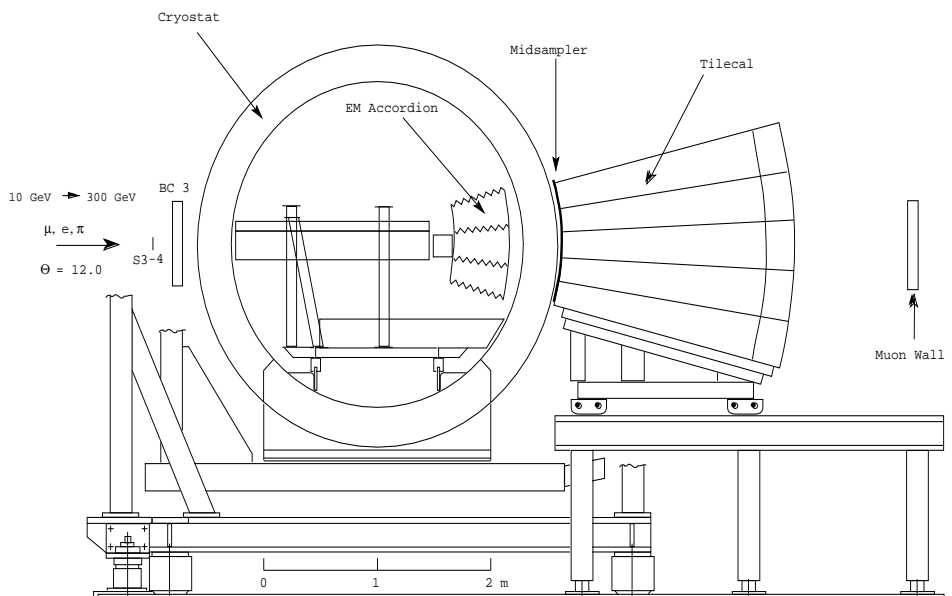

Figure 1: Test beam setup for the ATLAS combined prototype calorimeter.

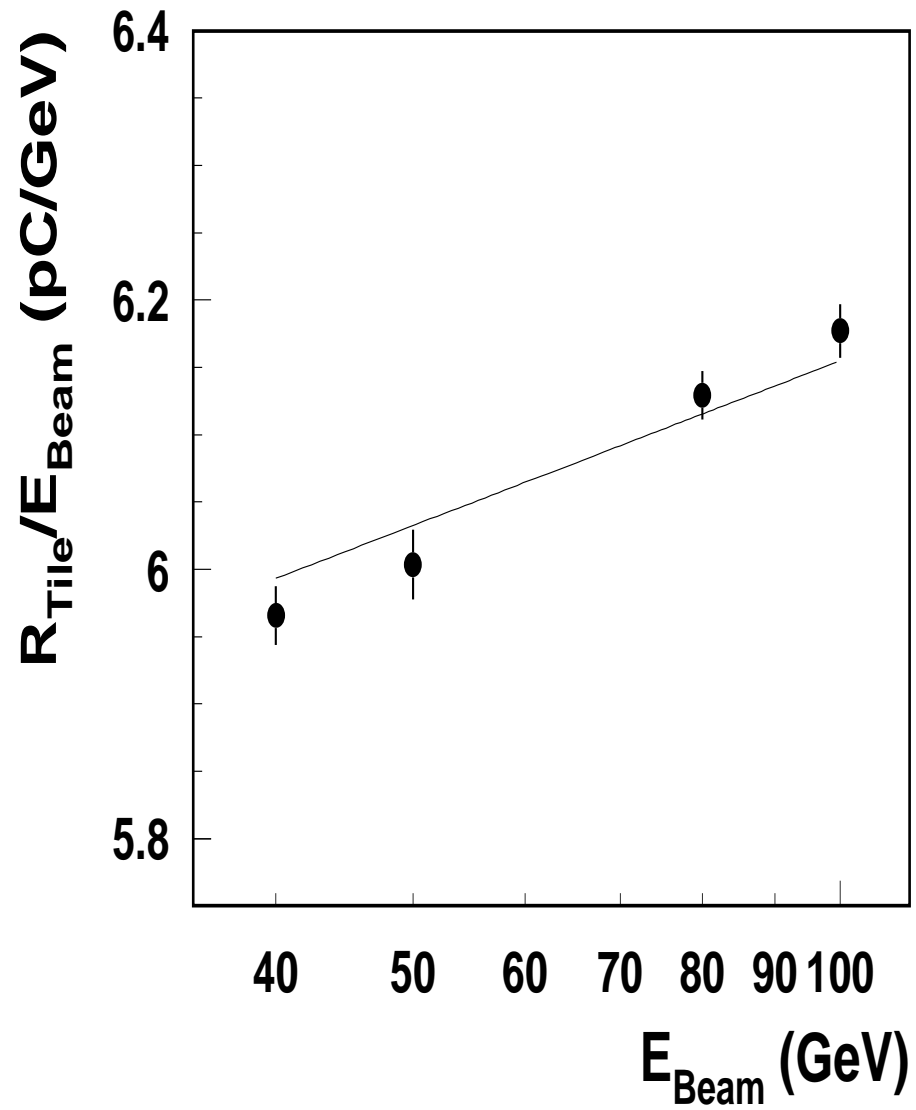

Figure 2: The corrected R_{Tile} response as a function of the beam energy.

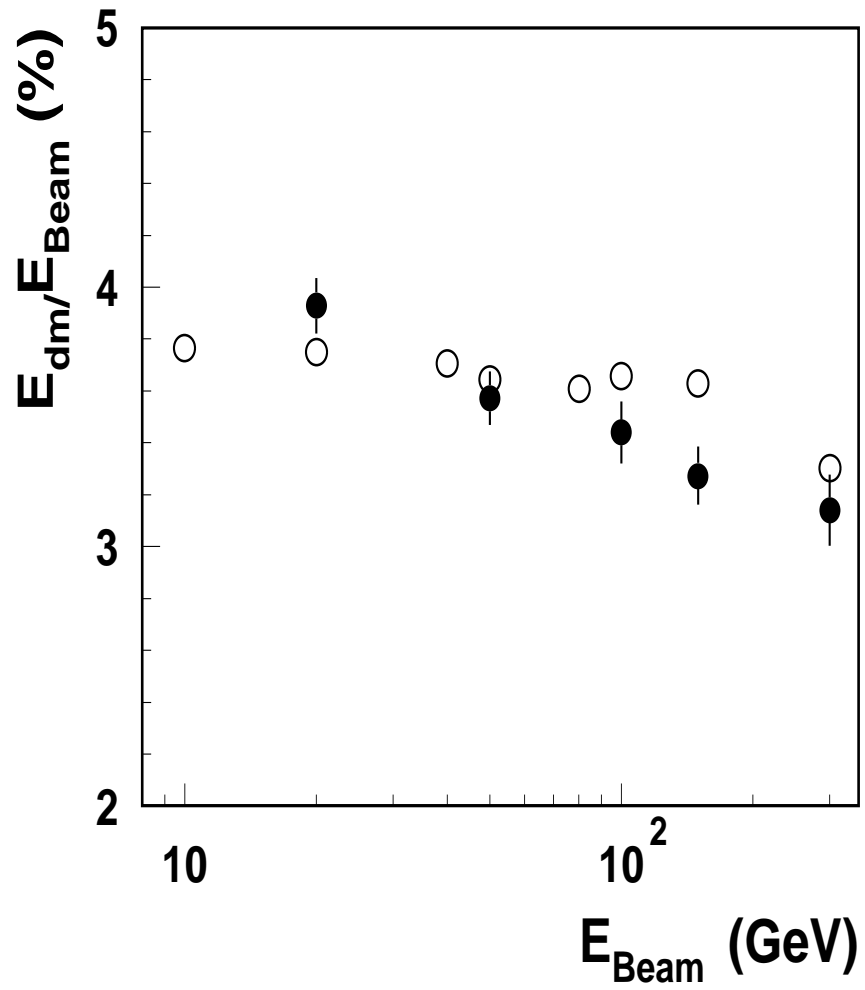

Figure 3: The comparison between the Monte Carlo simulation (solid circles) and the calculated values (open circles) for the average relative energy losses in the dead material, E_{dm}/E_{beam} , as a function of the beam energy.

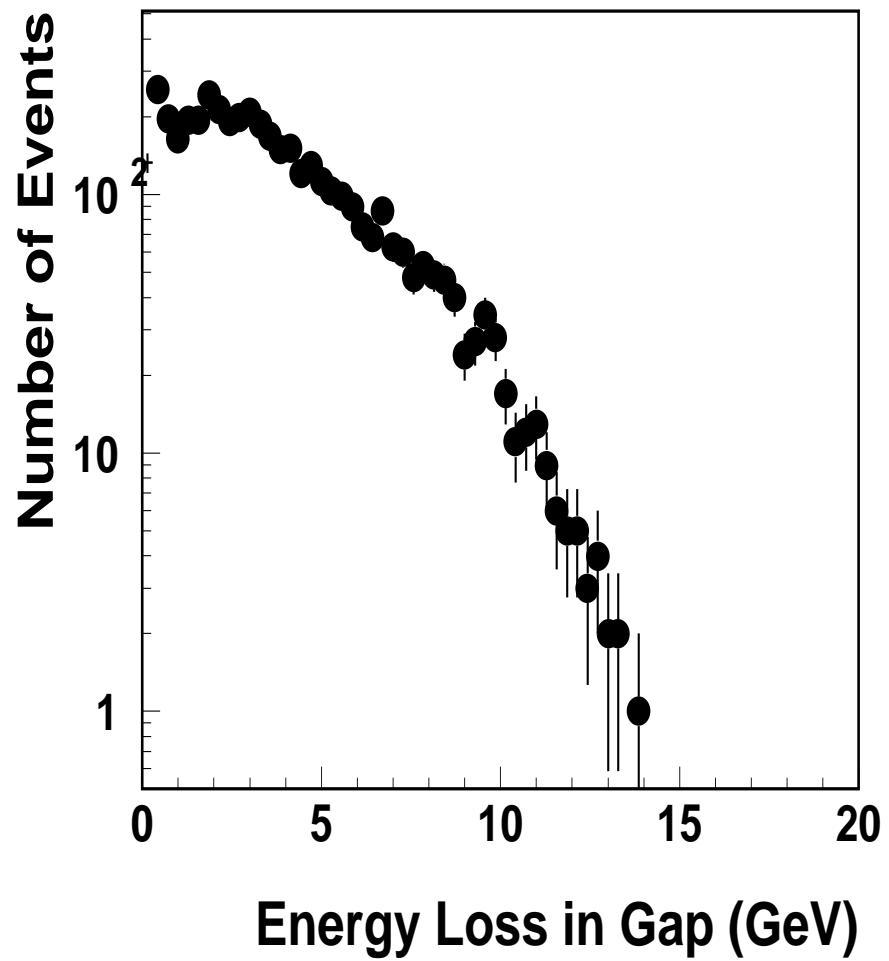

Figure 4: The distribution of energy loss in the dead material for 50 GeV pion beam.

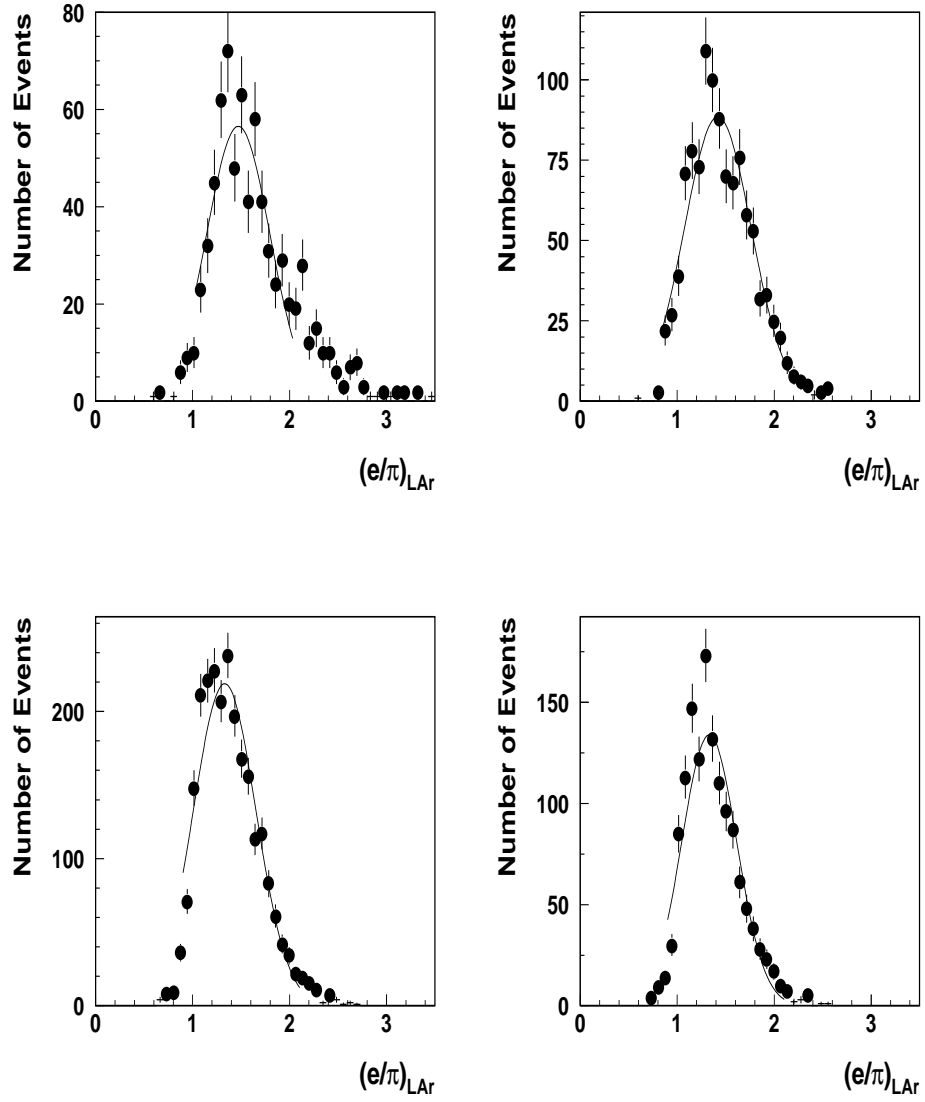

Figure 5: The distributions of the $(e/\pi)_{LAr}$ ratio for $E_{beam} = 10, 40$ GeV (left column, up to down) and $E_{beam} = 20, 50$ GeV (right column, up to down).

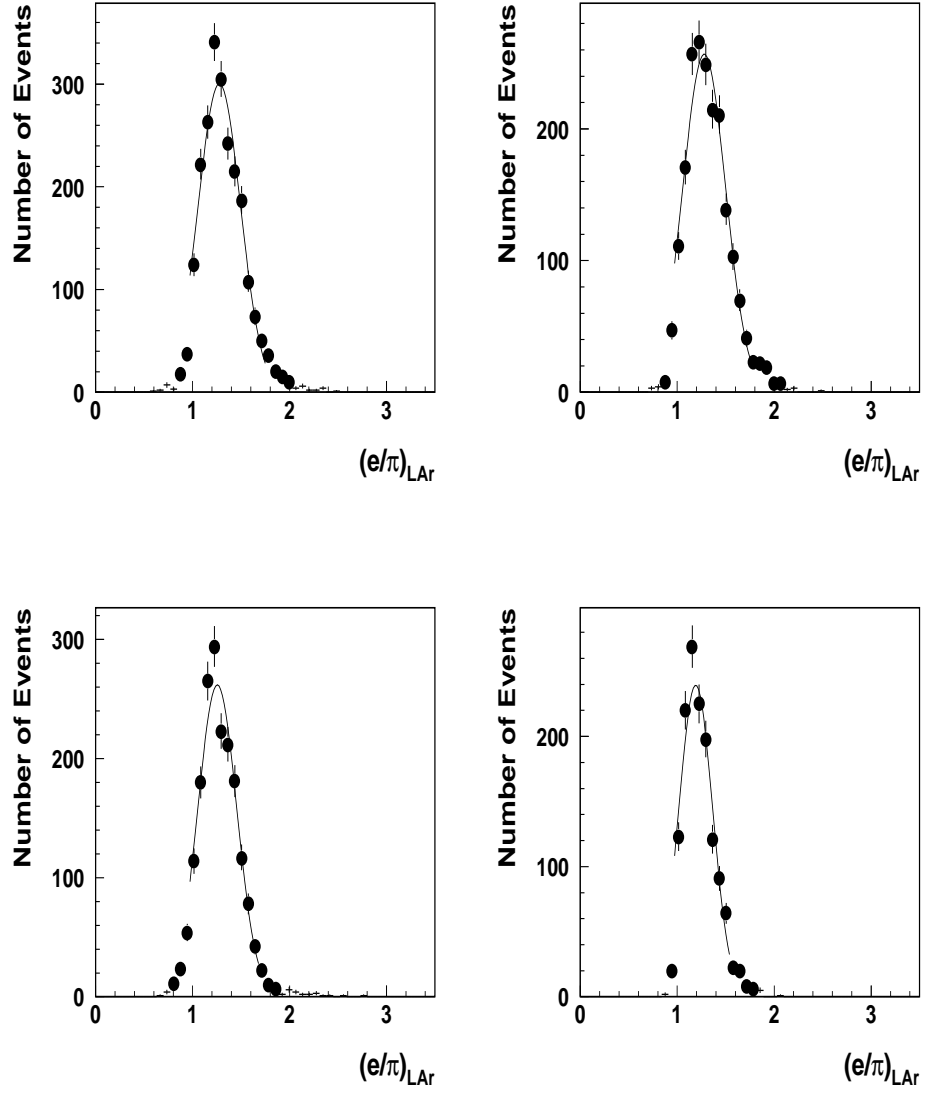

Figure 6: The distributions of the $(e/\pi)_{LAr}$ ratio for $E_{beam} = 80, 150$ GeV (left column, up to down) and $E_{beam} = 100, 300$ GeV (right column, up to down).

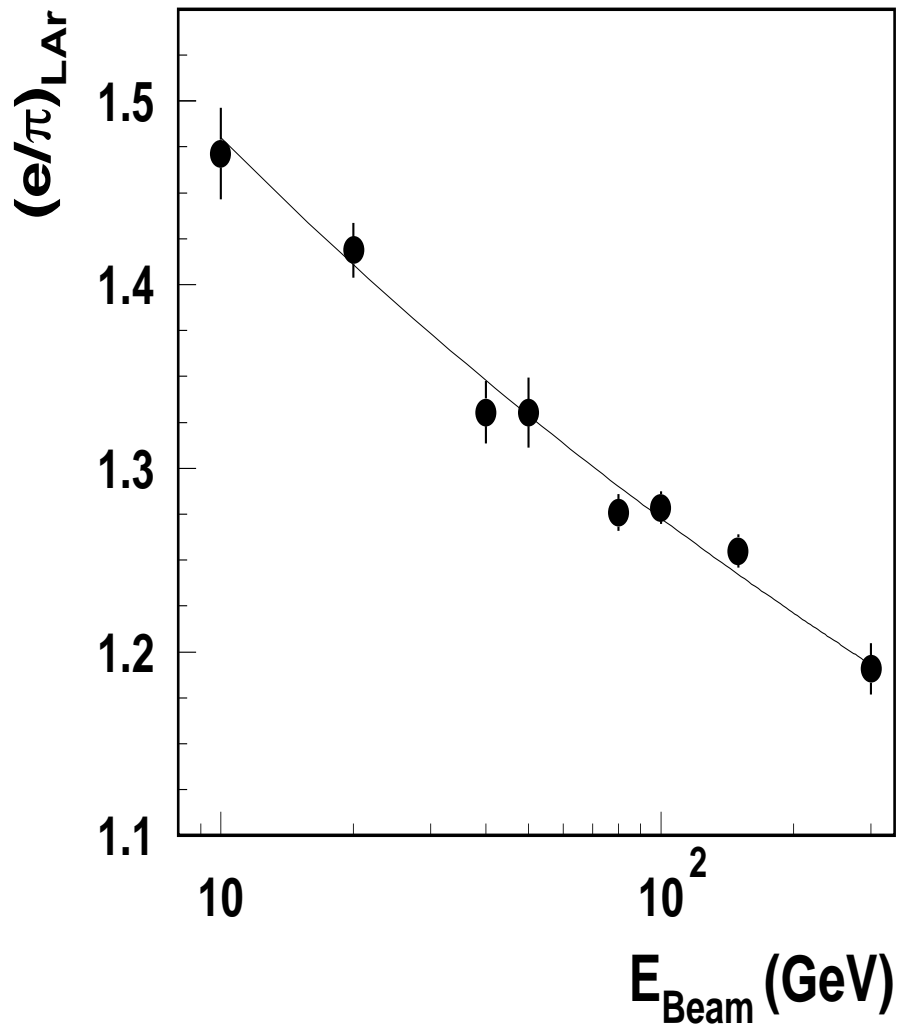

Figure 7: The mean values of the $(e/\pi)_{LAR}$ ratios as a function of the beam energy. The line is the result of a fit of eq. (10).