

CERN LIBRARIES, GENEVA



SCAN-9901010

E3-98-145

swg901

S.B.Borzakov, A.N.Andreyev, E.Dermendjiev¹, A.Filip²,
W.I.Furman, Ts.Pantelev, I.Ruskov, Yu.S.Zamyatnin,
Sh.Zeinalov

MEASUREMENTS OF DELAYED NEUTRON YIELDS
FROM THERMAL NEUTRON INDUCED FISSION
OF ²³⁵U, ²³³U, ²³⁹Pu, AND ²³⁷Np

¹Institute for Nuclear Research and Nuclear Energy, BAS, Sofia,
Bulgaria

²CEA, Cadarache, France

Introduction

It is well known that the existence of delayed neutrons (DN) from neutron induced fission of heavy nuclei has a fundamental significance for the realization of a controllable fission chain reaction. The yields and time characteristics of delayed neutrons from the thermal neutron induced fission of the main reactor isotopes (^{235}U , ^{239}Pu , and ^{233}U) are some of the most important nuclear reactor constants used in reactor kinetics calculations[1-5]. An accuracy of 3% for ^{235}U , 4% for ^{239}Pu , and 6% for ^{233}U has now been achieved for DN yields. The requirements for the accuracy of the parameters have continued to increase, especially in connection with the problems of the reactor safety [4,5].

However, despite a considerable number of measurements the discrepancy in the obtained data is significant. This discrepancy is especially seen when comparing the DN data obtained using two radically different methods of determining the DN parameters: 1) DN decay curve measurements with subsequent a approximation with six exponents and determination of DN parameters: decay constants λ_i and weights a_i ; 2) calculation of the group parameters by summation of

all precursors yields, included in this group. In the second case, the DN yield for a given precursor ν_{di} is equal to the product of the cumulative yield of the precursor Y_i and the neutron emission probability P_{ni} . For example, the experimentally achieved DN yield accuracy for one of the well-studied cases (thermal neutron induced fission of ^{239}Pu) is 4%, but the calculated value of the DN yield ν_d is 10% above the experimental one [6]. Moreover, the boundaries of the six groups have an arbitrary character and vary in the different works [7,8]. One should mention that the values of the parameters for the 5th and the 6th groups are determined with the worst accuracy (20-40%), because of their short decay periods (less than 1 sec.). This is comparable to the time needed, in some works, to move a sample from the irradiation position to the DN registration position.

As a consequence, the values of ν_d and $\beta_0 = \nu_d/\nu$ (where $\nu = \nu_d + \nu_p$ is the total number of fission neutrons and ν_p is the number of prompt neutrons per fission) are the subject of continuing efforts to improve their accuracy.

The total yield determination for DN from the thermal neutron induced fission of ^{233}U , ^{239}Pu , and ^{237}Np , and from the cold neutron induced fission of ^{233}U , ^{235}U , and ^{239}Pu (by using the data on ν_d from the thermal neutron induced fission of ^{235}U as a standard) is the subject of this work. Our specific interest in the investigation of fission characteristics for ^{237}Np was stimulated by the recent work by Lisowski et al. [9], where it was demonstrated that ^{237}Np is a perspective isotope for accelerator driven energy production and waste transmutation. Also, one of the purposes of this work was to experimentally check the existence of DN groups with very short periods (less than 0.1 sec) in thermal neutron induced fission of ^{235}U and ^{239}Pu , which is stipulated by the existence of such isotopes as ^{94}Br , ^{99}Rb , ^{100}Rb , and ^{102}Sr .

I. Method

To study the short-lived DN groups in the millisecond time range, a method of periodic irradiation of the samples without replacement was developed at the Frank Laboratory of Neutron Physics (JINR, Dubna). Since the method has been

discussed in detail elsewhere [10-12], we present here a short summary with relevant formulas.

The IBR-2 pulse reactor [13] was used as the neutron source. The reactor pulses with a half-width of 230 μ s at a repetition rate of 5 Hz and a high intensity of the pulse neutron flux (the peak power is about 1350 MW) give a unique possibility to study DN with short decay periods. The pulse reactor allows us to carry out the periodic irradiation of samples and to measure the DN in the time intervals between the pulses. The registration of prompt neutrons and DN under the same conditions allows one to determine the β_0 value with good accuracy.

In the case of a periodic sample exposure, the counting rate for DN decreases with time t according to the following expression:

$$n_d(t) = N_f \cdot v_d \cdot \epsilon_d \cdot \sum_{i=1}^6 \frac{a_i}{\Delta t} \cdot \frac{1 - \exp(-\lambda_i \cdot \Delta t)}{1 - \exp(-\lambda_i \cdot T)} \cdot \exp(-\lambda_i \cdot t) \quad (1)$$

$$0 < t < T - \Delta t$$

where N_f is the number of fission events, ϵ_d is the detector efficiency for DN, λ_i and a_i are the decay constant corresponding to the half-life $T_{1/2,i}$ ($\lambda_i = \ln 2 / T_{1/2,i}$) and the relative yield for the i th group of the DN ($\sum a_i = 1$), respectively. Δt is the irradiation time, and T is the time interval between neutron bursts. The value of t is counted from the end of the irradiation time-point. This formula uses the well-known 6-group approximation of Keepin [1] and takes into account the periodic irradiation of the target.

If the count numbers of prompt N_p (measured in some time interval $[t_0, t_1]$) and delayed N_d neutrons (in a time interval $[t_1, t_2]$, see Fig.2) are known from the experiment, one can calculate the value of β_0 using the formulas given below.

In particular, the total number of DN is equal

$$S_d = \frac{N_d}{\epsilon_d} F(T, \Delta t, t_1, t_2), \quad (2)$$

where $F(\Delta t, T, t_1, t_2)$ is a function that can be obtained from (1) and which takes into account the finite time interval of the DN measurement

$$F(t_1, t_2, \Delta t, T) = \left[\sum_{i=1}^n \frac{a_i}{\lambda_i \Delta t} \frac{1 - \exp(-\lambda_i \Delta t)}{1 - \exp(-\lambda_i T)} (\exp(-\lambda_i t_1) - \exp(-\lambda_i t_2)) \right]^{-1} \quad (3)$$

The number of prompt fission neutrons is

$$S_p = \frac{N_p}{\varepsilon_p}, \quad (4)$$

where ε_p is the detector efficiency for prompt neutrons. Evidently,

$$v_d/v_p = S_d/S_p \quad (5)$$

and, then

$$\beta_0 = \frac{v_d/v_p}{1 + v_d/v_p} \quad (6)$$

Therefore, the determination of β_0 value is reduced to measurements of the detector counts for prompt and delayed neutrons, and the ratio of their registration efficiencies.

The main advantage of this method lies in the fact that it is not necessary to know the absolute detector efficiency, the neutron flux, and the sample mass for these measurements. On the other hand, the measurements of DN from the short-life groups are carried out with a background from other groups with longer periods, which reach saturation in a few minutes after the start of irradiation.

II. The experimental setup

The measurements were performed on the “Isomer” setup (see Fig. 1), which was described in detail in [11-12]. The ‘Isomer’ facility was placed 27 m from the reactor core and the time-of-flight method allowed the energy of the incident neutrons to be determined. The neutrons from the reactor core passed through a bent mirror guide (cross-section 150x15 mm²) which considerably suppressed the background from fast neutrons and gamma quanta. The thermal neutron flux density at the exit of the mirror guide was $6 \cdot 10^5 \text{ n} \cdot \text{sm}^{-2} \cdot \text{s}^{-1}$.

The “Isomer” facility consists of a slow neutron chopper and a 4π -neutron detector. The chopper is a Cd disk with two slits. The rotation of the chopper was

synchronized with the reactor neutron bursts. The chopper served the following purposes: 1) to cut off the tail of cold neutrons quickly (during a time of about 1 ms) and to produce neutron pulses with a width of 10-40 ms, depending on the size of the slits and the rotation phase; 2) to suppress the reactor neutrons between these pulses. The action of the chopper is shown in Fig. 2. By shifting the chopper phase relative to the neutron bursts, one can choose different energy intervals of incident neutrons.

The neutron detector consists of 12 ^3He counters in a polyethylene moderator. The counters can be placed either in an internal ring ($\varnothing = 22.5$ cm) or in an external ring ($\varnothing = 33$ cm). The sample was placed in the central hole ($\varnothing = 15$ cm) of the detector. To avoid registration of the thermal neutrons, scattered by the sample, the detector was shielded inside by a Cd tube. The outside of the detector was covered by the 5 cm borate polyethylene shield against the environment scattered neutrons.

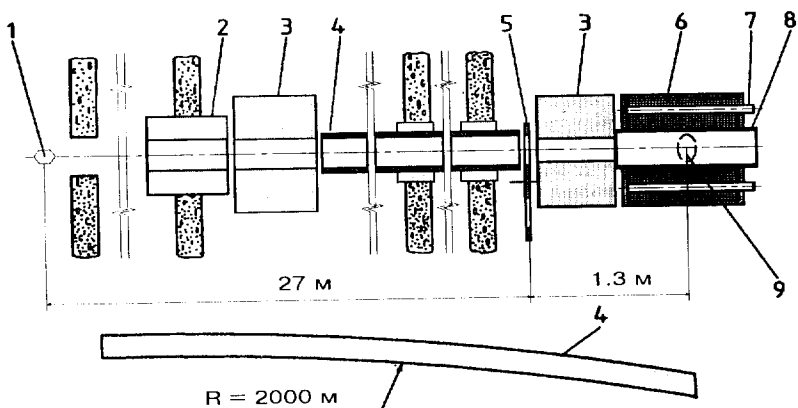

Fig. 1 The scheme of the "Isomer" setup: 1- IBR-2 reactor active zone and the moderator; 2,3 - collimators; 4 - bent mirror guide; 5 - chopper; 6- neutron detector; 7 - ^3He -counters; 8 - Cd tube; 9 - sample.

The high-intensity neutron burst from the reactor causes a pile-up of prompt fission neutron pulses during the exposure. Also, the dead time of the electronics used in these measurements leads to additional count losses. Therefore, special attention was paid to the correct estimation of the loss of prompt neutrons. The total

dead time of the acquisition system τ was measured by the usual method of two neutron sources. The main part of the measurements was carried out with $\tau = 5.5 \mu\text{s}$; other measurements were performed with the improved electronics ($\tau = 2.5 \mu\text{s}$). The conditions of the experiments were chosen such that the total correction of the number of detected prompt fission neutrons obtained in such measurements was not more than a few percent.

CAMAC-based electronics, connected to a PC, were used in the experiments to collect the data.

III. Measurements

In this section, we present the results of the DN yield measurements for the $^{233,235}\text{U}$, ^{239}Pu , and ^{237}Np isotopes and the decay curve measurements for the ^{235}U and ^{239}Pu isotopes performed in our work.

Due to the large thermal neutron fission cross-section, the samples used for measuring the DN yield values for main reactor isotopes had masses of about 25-70 mg. As the thermal neutron cross-section for ^{237}Np is rather small, we used a sample of ^{237}Np with a mass of 40 g. For the decay curve measurements, much larger samples of ^{235}U and ^{239}Pu (with masses of 7g and 20g, respectively) were used. Some characteristics of the samples used are shown in Table 1.

Table 1. Characteristics of the samples used in the measurements.

Isotope	Weight (g)	Enrichment, %	Chemical compound	Backing
^{235}U	0.025	90	oxide	Al
^{235}U	7.0	90	metal	-
^{233}U	0.067	98.1	oxide	Ni
^{239}Pu	0.057	95.2	metal	--
^{239}Pu	20.0	99.9	metal	--
^{237}Np	40.4	99.999	oxide	Ni

III.1 Delayed neutron yields

A typical spectrum, measured with the ^{235}U sample over 18 hours, is shown in Fig. 2. The background was measured with a 1.5 mm Cd filter in the beam just behind the chopper. The background was due to: a) the (α, n) -reaction on the backings and on the oxygen in the oxides of the isotopes, and b) the scattering of fast reactor neutrons in the sample. To reduce the first part of the background, Ni foils for the backings or metallic samples were used. The background value in the time interval $[t_1, t_2]$ for the DN counting was approximately 15% for ^{235}U , 30% for ^{233}U , and 45% for ^{239}Pu .

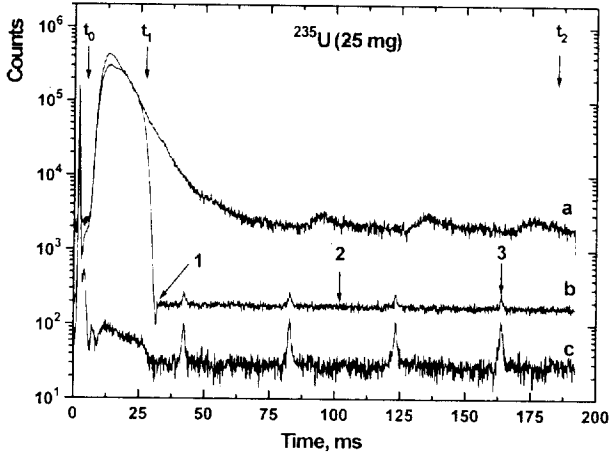

Fig. 2. The experimental time distributions measured with a ^{235}U sample: a) without chopper; b) with the chopper; c) background, measured with a Cd-filter in the beam. (1) cut-off point of the reactor thermal neutron flux; (2) delayed neutrons; (3) “satellites” of the main burst due to the specific design of the IBR-2 reactor;

Our preliminary results were obtained from a number of runs that measured the effect for several hours and the consequent measurement of the background for approximately the same time [26]. To ensure the long-term stability of the results, we repeated the measurements with improved detector electronics, software, and automatic system, which allowed us to alter the measurements of the effect and the background with the period 20 min.

The ratio of the efficiencies for delayed and prompt neutrons was obtained from the measurements with the ^{235}U sample at the mean energy of 0.023 eV and a value of $\beta_0 = (0.680 \pm 0.020)\%$. The latter was derived using the recommended values of $\nu_d = 0.01653$ [5] and $\nu = 2.4320 \pm 0.0036$ [14]. The resulting ratios of the efficiencies are $\varepsilon_d/\varepsilon_p = 1.32 \pm 0.04$ and $\varepsilon_d/\varepsilon_p = 1.08 \pm 0.035$ for internal and external rings, respectively. These values are in good agreement with the

calculations made by the Monte-Carlo method, performed with the help of the MCNP code [15].

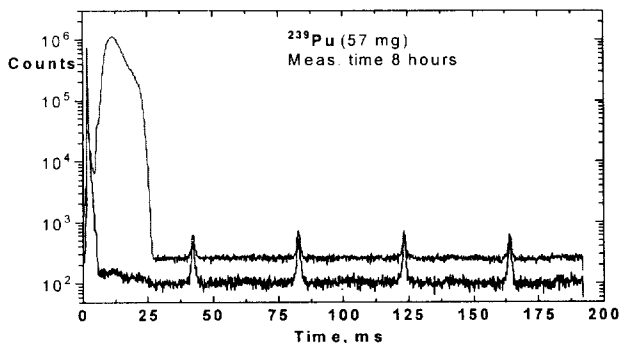

Fig.3. The experimental time distribution, measured with the ^{239}Pu sample.

A typical spectrum, measured with the ^{239}Pu sample (57 mg) is shown in Fig.3.

The β_0 values were measured for the neutron energy intervals having mean energies of 0.003 eV and 0.023 eV. These energy intervals were chosen by changing the phase of the neutron chopper. A Be-filter was used to perform measurements with cold neutrons with a mean energy of about 0.003 eV (see Fig. 4). Several runs of about 10-15 hrs each were carried out for each isotope. The statistical errors were less than 0.5 % for ^{235}U and ^{233}U , and less than 1.0% for ^{239}Pu . The total error was calculated as a standard deviation from the weighted mean value obtained from all runs and the error of the standard.

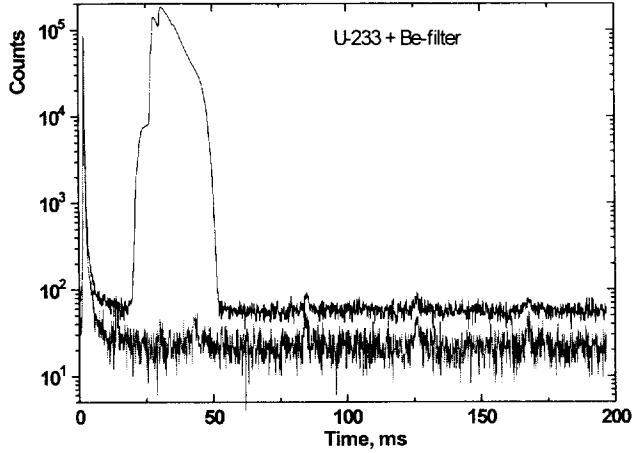

Fig. 4 The experimental time distribution measured with the ^{233}U sample and Be-filter.

The data from main reactor isotopes are shown in Table 2.

Table 2. The β_0 values (in percent) for different energies of the initial neutrons and their ratios (in brackets) to the standard $\beta_0 [^{235}\text{U}(n_{th},f)]$ for ^{235}U , ^{233}U , and ^{239}Pu .

Isotope	$E_n = 0.003 \text{ eV}$	$E_n = 0.023 \text{ eV}$
^{235}U	$0.683 \pm 0.021 (1.004 \pm 0.009)$	$0.680 \pm 0.021 (1.000)$
^{233}U	$0.274 \pm 0.009 (0.403 \pm 0.006)$	$0.267 \pm 0.009 (0.393 \pm 0.006)$
^{239}Pu	$0.227 \pm 0.011 (0.334 \pm 0.016)$	$0.234 \pm 0.008 (0.344 \pm 0.004)$

We should stress that the final experimental error of β_0 includes both the experimental error itself and the error of the standard used. The main contribution to the final experimental error arises from the error of the standard used ($\sim 3\%$). The experimental error itself is much lower ($\sim 1.5\%$) and determined by the statistics and losses in count of prompt neutrons.

One can see from Table 2 that there is no energy dependence for the β_0 values in the studied energy region. Therefore, we calculated the mean values of β_0 and, using the known values of ν from [14], we obtained the values of ν_d , shown in Table 3.

Table 3. The obtained values of β_0 and ν_d , together with the data from the literature.

Isotope	$\beta_0, \%$	ν	ν_d	
			our data	other data
^{233}U	0.270 ± 0.009	2.4946 ± 0.0040	0.006735 ± 0.00022	0.00667 ± 0.00029 [25]
^{239}Pu	0.232 ± 0.008	2.8799 ± 0.0090	0.00668 ± 0.00023	0.00653 ± 0.00026 [5]

Up to now, the value of ν_d for ^{237}Np has been measured only for fast neutron induced fission [17-19]. Measurement of the β_0 value for thermal neutron induced fission is an extremely difficult task because ^{237}Np has a very small fission cross-section (21.5 mb [20]), and a relatively large neutron background due to the (α, n)-reaction.

Because of the thermal neutron fission cross-section for ^{237}Np is 3×10^4 times smaller than for ^{235}U and ^{239}Pu , determination of the possible admixture is a very important task. Therefore, the ^{237}Np sample was chemically purified of ^{235}U and ^{239}Pu contamination to reduce their concentrations to a value less than 10^{-6} g/g. The concentration of ^{239}Pu was measured by the method of α -spectroscopy, which gave the limit of 10^{-6} g/g. Unfortunately, the methods of α - and γ -spectroscopy do not allow the concentration of ^{235}U to be determined with good sensitivity. To solve this problem, the method of neutron resonance spectroscopy was used. For this purpose,

an ionization chamber with 88 mg of ^{237}Np of the same purity was made. The measurements were carried out at the 16 m flight base of the IBR-30 booster, with a pulse width of $4 \mu\text{s}$ [21]. The results showed no indications of the strongest resonances of ^{235}U in the measured spectra. The conclusion that the concentration of ^{235}U was less than 10^{-5} g/g was made from the obtained data.

The measured time spectrum of the DN for ^{237}Np is shown in Fig. 5. One should note that despite the large mass of the sample, the number of DN counts was only about 5-6% relative to the background. Further increases of the sample mass was useless and was limited by the flux attenuation due to the large radiative capture cross-section of the thermal neutrons in the sample. As a result of ten runs of measurements (5-12 hours each) we obtained:

$$\beta_0 = (0.486 \pm 0.028) \%$$

Tacking into account the known value of $\nu = 2.47 \pm 0.14$ [22] one can obtain the value of ν_d , which is shown in Table 4 with the measured [17-19] and calculated [6] data for fast neutron induced fission.

Table 4. The values of ν_d for ^{237}Np .

$\nu_{dn} (\%)$				
our work	other works			
thermal neutrons	fast neutrons			
1.20 ± 0.10	1.18 ± 0.13 [17]	1.22 ± 0.03 [18]	1.26 ± 0.07 [19]	1.14 ± 0.12 [6]

In conclusion, the values of β_0 for all isotopes presented here are in agreement with previously measured data and have the accuracy comparable with that of the recommended evaluated data [5].

III.2 Decay curve measurements.

The time dependence of the DN count rate after irradiation by thermal neutrons (the decay curve) was measured for ^{235}U (7 g) and ^{239}Pu (20 g) in time intervals up to 350 ms. In this case, the background was less than 0.1%. It is interesting to check the consistency between the decay curve of the DN activity that was measured using our facility “Isomer” and the calculated decay curves based on different six-group sets of constants [1,2,6,7,23,24].

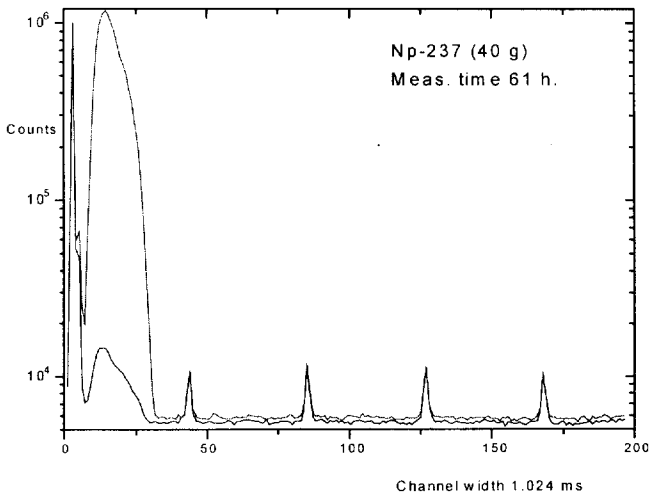

Fig. 5. The experimental spectrum for ^{237}Np . The channel width is equal to 1.024 ms.

All curves are shown in Figs. 6 and 7 for ^{235}U and ^{239}Pu , respectively. The calculated curves were normalized to the experimental ones at 350 ms time-point.

Each point in Figs. 6 and 7 represents a time interval of 1.024 ms and has statistical errors less than 0.3% for ^{235}U and 0.2% for ^{239}Pu . One can see from the

results shown in these figures that the best agreement between the measured data and the calculated curves is achieved with the Keepin-Tuttle parameter set.

To check the existence of the DN groups with short periods, a fit of the ^{235}U data was made with the Keepin-Tuttle parameter set, adding a 7th group with $T_{1/2,7} = 50$ ms. The conclusion was made that the 7th group was absent at the level of $a_7 < 5.2 \cdot 10^{-3}$ (with a probability of 95%). A more detailed analysis of the decay curves will be made in a separate paper.

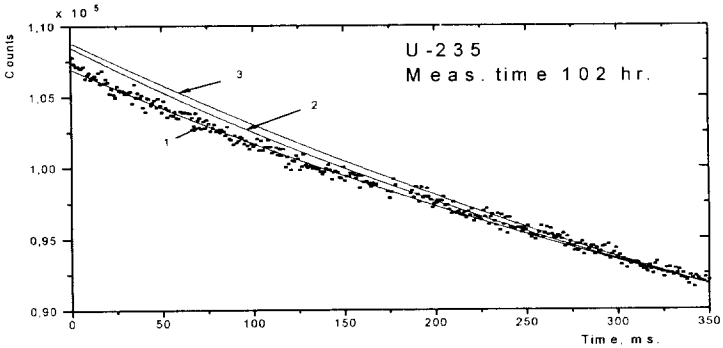

Fig. 6. The experimental DN decay curve for ^{235}U and the calculated ones using different 6-group sets of constants: 1- Keepin-Tuttle [1,2]; 2 - Waldo et al. [23]; 3 - Mills et al. [24].

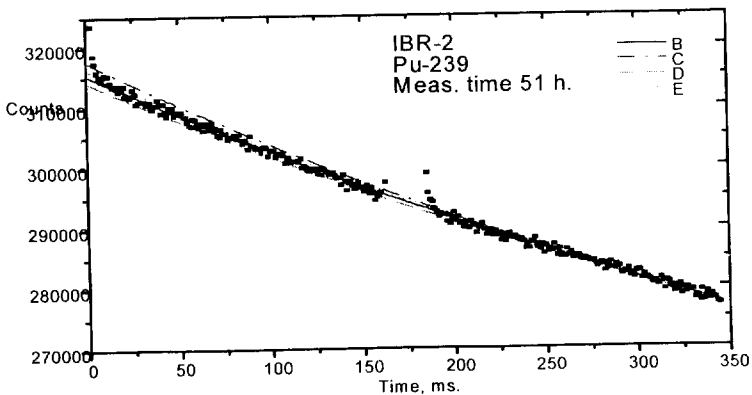

Fig. 7. A DN decay curve for ^{239}Pu and the calculated ones using the 6-group set of DN constants: B - Keepin-Tuttle [1,2], C - A. Wahl [7], D - R.W. Waldo et al.[23], E -- M.C. Brady and T.R. England [6].

Acknowledgments.

The authors wish to thank Drs. Yu.V. Grigoriev, V.B. Pavlovich, G.V. Buklanov, S.M. Soloviev, and V.N. Konev for providing fissile samples for these measurements and S.S. Pavlov and V.Yu. Konovalov for their help with the measurements.

This work was supported by the ISTC project #471, grant RFFR 95-02-03740 and the CEA-JINR Agreement.

References

1. G.R.Keepin, Physics of Nuclear Kinetics, Addison Wesley, Reading, Mass., 1965.
2. R.J. Tuttle, Nucl. Sci. Eng., v. 56, p. 37, 1975.
3. V.M.Sluchevskaya, I.P.Matveenکو, Problems of Atom. Sci. and Technique, Nucl. Data, Moscow, USSR, v. 3(38), p. 29, 1980.
4. A.Filip, A.D'Angelo, Nuclear Data for Science and Technology, Proceedings, FRG, Juelich, 13-17 May 1991, p. 946, Springer-Verlag, Berlin, 1992.
5. J. Blachot et al., OECD-NEA, NEACRP-L-323, 1990.
6. M.C. Brady, T.R. England, Nucl. Sci. Eng., v. 103, p. 129, 1989.
7. A.C.Wahl, Atomic Data and Nuclear Data Tables, v. 39, p. 1, 1988.
8. G. Rudstam, Nucl. Sci. Eng., v. 80, p.238, 1982.
9. P.W. Lisowski et al., Nuclear Data for Science and Tecnology, Proceedings, FRG, Juelich, 13-17 May 1991, p. 92, Springler-Verlag, Berlin, 1992.
10. E. Dermendjiev, V.M. Nazarov, S.S. Pavlov, I. Ruskov, Yu.S. Zamyatnin, Preprint JINR, E3-93-6, Dubna, 1993.
11. S.B. Borzakov, E. Dermendjiev, Yu.S. Zamyatnin, V.M.Nazarov, S.S. Pavlov, A.D. Rogov, I. Ruskov, Atomnaya Energiya, v. 79, p. 231, 1995 (in Russian).

12. S.B. Borzakov, E. Dermendjiev, Yu.S. Zamyatnin, V.M. Nazarov, S.S. Pavlov, A.D. Rogov, I. Ruskov, Preprint JINR P3-94-447, 1994.
13. V.D. Ananiev et al., *Atomnaya Energiya*, v.57, p. 227, 1984 (in Russian).
14. H. Tellier, in *Nucl. Data Standards for Nucl. Measurements*, NEA OECD, p.90, 1992.
15. J.F. Briesmeister (Ed.), *MCNP-A General Monte-Carlo N Particle Transport Code, Version 4A*, Los-Alamos Lab. Report LA-12625, 1993.
16. J.F. Conant, P.F. Palmedo, *Nucl. Sci. Eng.*, v. 44, p. 173, 1971.
17. A.N. Gudkov et al., *Atomnaya Energiya*, v. 66, p. 100, 1989.
18. G. Benedetti et al., *Nucl.Sci.Eng.*, v. 80, p. 379, 1982
19. A.A. Malinkin et al., *VANT, Phys. of Nucl. Reactors*, v. 3, p. 37, 1992.
20. S.F. Mughabghab et al. *Neutron Cross-Sections*, v. 1, part B, N.Y. - London, Academic Press, 1984.
21. I.M. Frank, *Particles and Nuclei*, v. 2, p. 807, 1972.
22. A. Thierens et al., *Nucl. Phys.*, v. 342, p. 229, 1980.
23. R.W. Waldo et al., *Phys. Rev. C*23, p. 1113, 1981.
24. R.W. Mills et al., *Nuclear Data for Science and Technology, Proceedings, FRG, Juelich, 13-17 May 1991*, p. 86, Springer-Verlag, Berlin, 1992.
25. R.J. Tuttle, IAEA report, *INDC(NDS)-107/G+Special*, p.29, 1979.
26. S.B. Borzakov et al., *Nucl. Data for Science and Technology, Proceedings, Italy, Trieste, 19-24 May 1997*, v. I, p. 497, Bologna, 1997.

Received by Publishing Department
on July 10, 1998.

Борзаков С.Б. и др.

E3-98-145

Измерения выходов запаздывающих нейтронов

в делении тепловыми нейтронами ^{235}U , ^{233}U , ^{239}Pu и ^{237}Np

Представлены результаты исследований на импульсном реакторе ИБР-2 запаздывающих нейтронов (ЗН) с короткими периодами, возникающими в делении тепловыми нейтронами ряда актинидов. Использовался метод периодического облучения без перемещения образца. Проведены прецизионные измерения кривых распада во временном интервале 5—350 мс для ^{235}U и ^{239}Pu . Измерены полные выходы ЗН в делении тепловыми нейтронами ^{239}Pu , ^{233}U и ^{237}Np , а также в делении холодными нейтронами ^{235}U , ^{233}U и ^{239}Pu . Все величины получены с использованием значения β_0 для $(n_{\text{th}} + ^{235}\text{U})$ в качестве стандарта.

Работа выполнена в Лаборатории нейтронной физики им. И.М.Франка ОИЯИ.

Сообщение Объединенного института ядерных исследований. Дубна, 1998

Borzakov S.B. et al.

E3-98-145

Measurements of Delayed Neutron Yields

from Thermal Neutron Induced Fission

of ^{235}U , ^{233}U , ^{239}Pu , and ^{237}Np

The experimental results on delayed neutron (DN) yields from thermal neutron induced fission of some actinides on the IBR-2 pulsed reactor are presented. A method of periodic irradiation without displacement of the sample was used. Precise measurements of decay curves in the time interval of 5—350 ms for ^{235}U and ^{239}Pu were performed. The measurements of DN total yields in thermal neutron induced fission of ^{239}Pu , ^{233}U , and ^{237}Np and in cold neutron induced fission of ^{235}U , ^{233}U , and ^{239}Pu were carried out. All values were obtained using the value of β_0 for $(n_{\text{th}} + ^{235}\text{U})$ as a standard.

The investigation has been performed at the Frank Laboratory of Neutron Physics, JINR.

Communication of the Joint Institute for Nuclear Research. Dubna, 1998

Макет Т.Е.Полеко

Подписано в печать 21.07.98
Формат 60 × 90/16. Офсетная печать. Уч.-изд. листов 1,8
Тираж 345. Заказ 50827. Цена 1 р. 30 к.

Издательский отдел Объединенного института ядерных исследований
Дубна Московской области