

**ERNEST ORLANDO LAWRENCE  
BERKELEY NATIONAL LABORATORY**

**Application of a Pulsed, RF-driven,  
Multicusp Source for Low Energy  
Plasma Immersion Ion Implantation**

A.B. Wengrow, K.N. Leung, L.T. Perkins, D.S. Pickard,  
M. Rickard, M.D. Williams, and M. Tucker  
**Accelerator and Fusion  
Research Division**

June 1996  
Presented at the  
*XI International Conference on  
Ion Implantation Technology*,  
Austin, TX,  
June 17-21, 1996,  
and to be published in  
the Proceedings

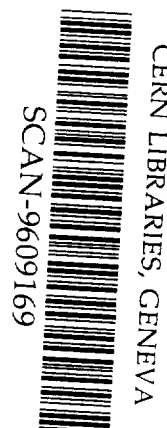

5w9640

#### **DISCLAIMER**

This document was prepared as an account of work sponsored by the United States Government. While this document is believed to contain correct information, neither the United States Government nor any agency thereof, nor The Regents of the University of California, nor any of their employees, makes any warranty, express or implied, or assumes any legal responsibility for the accuracy, completeness, or usefulness of any information, apparatus, product, or process disclosed, or represents that its use would not infringe privately owned rights. Reference herein to any specific commercial product, process, or service by its trade name, trademark, manufacturer, or otherwise, does not necessarily constitute or imply its endorsement, recommendation, or favoring by the United States Government or any agency thereof, or The Regents of the University of California. The views and opinions of authors expressed herein do not necessarily state or reflect those of the United States Government or any agency thereof, or The Regents of the University of California.

Ernest Orlando Lawrence Berkeley National Laboratory  
is an equal opportunity employer.

---

**Application of a Pulsed, RF-driven, Multicusp Source for  
Low Energy Plasma Immersion Ion Implantation**

A.B. Wengrow, K.N. Leung, L.T. Perkins, D.S. Pickard,  
M. Rickard, and M.D. Williams,

Accelerator and Fusion Research Division  
Ernest Orlando Lawrence Berkeley National Laboratory  
University of California  
Berkeley, California 94720

and

M. Tucker

Spectrum Sciences Inc.  
Santa Clara, California 95051

June 1996

# Application of a Pulsed, RF-driven, Multicusp Source for Low Energy Plasma Immersion Ion Implantation

A. B. Wengrow, K. N. Leung, L. T. Perkins, D. S. Pickard, M. Rickard, M. D. Williams  
Lawrence Berkeley National Laboratory  
University of California  
Berkeley, California 94720 USA

M. Tucker  
Spectrum Sciences Inc.  
Santa Clara, California 95051 USA

**Abstract**—The multicusp ion source has the capability of producing large volumes of uniform, quiescent, high density plasmas. Due to the versatility of the multicusp source, a plasma chamber suited for plasma immersion ion implantation (PIII) was readily constructed. Conventional PIII pulses the bias voltage applied to the substrate which is immersed in a CW mode plasma. However, in the interest of finding a more efficient and improved means of implantation, a method by which the plasma itself is pulsed was developed. Typically pulse lengths of 500  $\mu$ s are used and are much shorter than that of the substrate voltage pulse (~5 to 15 ms). This approach, together with low gas pressures and low bias voltages, permits the constant energy implantation of an entire wafer simultaneously without glow discharge. Results show that this process can yield implant currents of up to 2.5 mA/cm<sup>2</sup>, and thus very short implant times can be achieved. Uniformity of the ion flux will also be discussed. Furthermore, as this method can be scaled to any dimension, it could be made to handle any size wafer.

## I. INTRODUCTION

Plasma immersion ion implantation (PIII) offers an improved method of semiconductor processing, as compared to traditional implanters. PIII methods are far less expensive, offer low energy capabilities, and provide significantly higher dose rates than ion beam implanters. Conventional PIII, whether it be for metallurgical processing [1,2] or semiconductor processing [3,4], typically applies a negative voltage pulse to a sample placed in direct contact with a CW mode plasma. The ions from the plasma are then implanted according to a dynamic sheath model [5] during the voltage pulse. However, PIII is not without its limitations. For example, the dose can be more difficult to control, wafer heating can take place, and plasma/ substrate surface interactions can occur. With these drawbacks in mind, a method of PIII to minimize these problems was developed.

This method of PIII limits the existence of the plasma within the chamber by pulsing the exciting RF power. Since

this pulse takes place within a much larger bias pulse, a pseudo DC implantation field is present when the plasma strikes. The substrate voltage was pulsed to eliminate any chance of glow discharge or electrical breakdown between plasma pulses, thus preventing any unwanted implantation or implantation at other than the prescribed voltage. Pulsing the substrate voltage also allows the grounding of the wafer between pulses to ensure the complete collapse of the plasma sheath. With this method of PIII, the presence of the plasma itself controls the implantation as opposed to conventional PIII's use of a voltage pulse. In order to guarantee the uniformity of the plasma pulses, a large multicusp ion source was chosen, due to its proven ability to generate large volumes of dense, uniform, quiescent plasmas [6,7].

## II. IMPLANTER DESIGN

The plasma chamber consisted of a reinforced stainless steel vessel 48 cm in diameter and 47 cm in height (see Fig. 1). Electron confinement was achieved with the use of 30 cusp magnet columns secured around the cylinder wall with 6 magnet rows mounted to the bottom of the chamber (the end opposite to the wafer). The wafer support structure was composed of two, stacked, graphite plates. The plates were electrically isolated from both the chamber wall, and from each other. The wafer was physically mounted to the innermost plate (25 cm diameter) to which the high voltage substrate bias was applied. The upper plate (45 cm diameter) was allowed to float electrically, and was mounted to the top of the chamber. In this particular configuration, wafers up to 200 mm in size could be accommodated.

The plasma was generated by a single turn, porcelain-coated antenna with a loop diameter of 20 cm. The antenna was positioned 15 cm from the wafer and 18 cm from the bottom of the chamber. The antenna was driven using a RF amplifier through a tuned matching network (see Fig. 2). The center frequency of the matching network was 1.8 MHz.

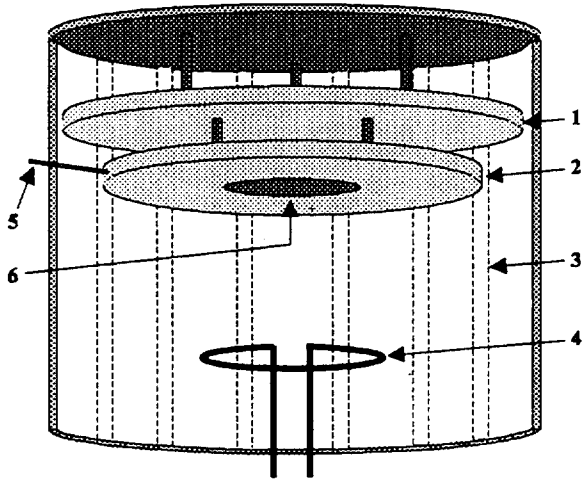

Fig. 1. Schematic diagram of PIII Plasma Chamber: (1) upper graphite plate, (2) lower graphite plate, (3) cusp magnet, (4) RF antenna, (5) high voltage connection for wafer bias, (6) Wafer.

To aid in maintaining a constant bias voltage during the plasma pulse, a capacitor bank in parallel with the bias voltage supply was used. Fast acting, high voltage capacitors with a total capacitance of approximately 100  $\mu\text{F}$  were used. The choice of capacitance was dependent on the ion current present during implantation. The capacitors were switched using a high voltage, fast acting relay. The relay was used to apply the bias voltage to the substrate, and to ground the substrate between pulses for the reasons mentioned above.

### III. OPERATING CONDITIONS

The primary goal was to develop a method of implantation which could provide a consistent and controlled-energy implantation of an entire wafer simultaneously. This was achieved by controlling the operating conditions of the implantation.

The gas used during implantation was a mixture of argon and helium. The argon gas was used to simulate phosphine for future tests, and had an operating pressure of approximately  $5 \times 10^{-4}$  Torr. Helium was added until the total pressure was 1 to 2 mTorr. The helium not only served to

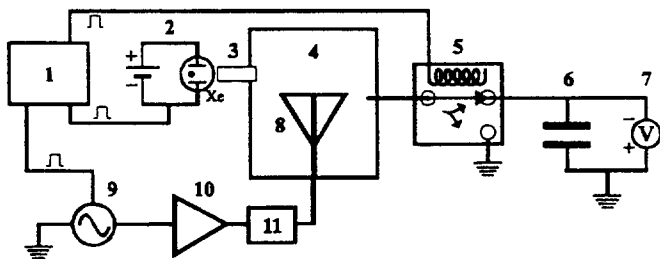

Fig. 2. Schematic diagram of experimental set-up: (1) timing control unit, (2) flash lamp, (3) light pipe, (4) plasma chamber, (5) H.V. relay, (6) H.V. capacitors, (7) bias high voltage supply, (8) RF antenna, (9) signal generator, (10) RF amplifier, (11) matching network.

dilute the argon (a safety feature for the future toxic dopant gas), but also served as a plasma suppression mechanism reducing the possibility of glow discharge due to helium's much higher ionization energy. The final value of the two gas pressures were the result of an optimization for spatial uniformity across the wafer, as well as, temporal uniformity within the plasma pulse.

The RF power used to strike the plasma and maintain it during the plasma pulse was typically 200 Watts. At this low energy the only plasma present was that of the argon. Because of the relatively low RF power, the aid of a xenon flash lamp to ignite the plasma was required. The flash lamp focused UV light into the chamber, photo-emitting electrons from the chamber walls. These electrons were then accelerated by the RF field of the antenna and ionized the argon molecules [8]. The flash lamp also aided in the maintaining of a consistent duration plasma pulse by providing a definite point of plasma ignition.

The implantation energies typically ranged from 500 V to 2 kV, although tests as low as 45 V were performed. This low energy implantation capability is ideal for ultra-shallow junctions and thin film deposition, while providing the added feature of less energy for glow discharge. As the bias voltage approached values of 500 V, the strength of the bias field began to aid the ignition of the plasma (i.e., the plasma would strike sooner in the plasma pulse). This could be observed by monitoring the RF voltage or current at the amplifier through a voltage probe or current transformer. At the ignition point of the plasma there was an abrupt change in the RF voltage and current pulse envelopes which was a result of the load change with and without a plasma (see Fig. 3). If this unwelcome assistance from the bias is not compensated for by lowering the RF power, or by increasing the helium in the gas mixture, breakdown from the chamber walls to the wafer holder can occur. By decreasing RF power, and/or altering the gas mixture the duration of the plasma pulse can be made to stay constant but the dose rate decreases. Therefore the duty factor or implantation time

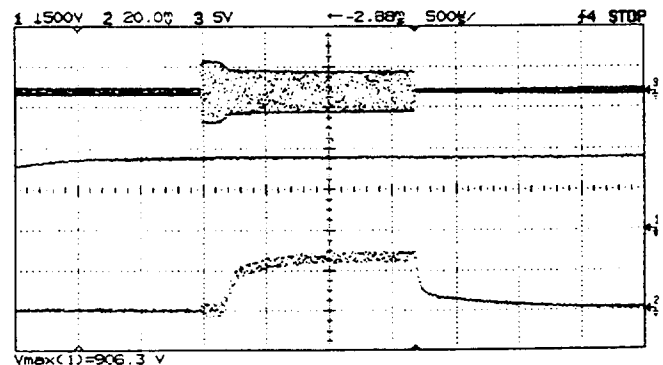

Fig. 3. Oscilloscope traces of the RF current pulse envelope (top), the wafer bias voltage at 906 V (middle), and the ion current from the center Langmuir probe (bottom). Change in RF current pulse width indicates plasma ignition.

must be increased to maintain the desired dose. In fact, the ion current is almost completely determined by the RF power and gas composition, with only a small effect coming from the bias voltage value.

#### IV. RESULTS

The principal results of this experiment concern the plasma pulse reproducibility, the temporal consistency within the pulse, and the spatial uniformity of the implant across typical wafer dimensions. We measured uniformity and dose consistency with three small planar Langmuir probes placed at specific locations on the wafer holder (see Fig. 4). The probes were biased separately from the wafer holder and were electrically isolated from the plasma chamber. The wires from the probes were shielded from the plasma by means of hollow ceramic tubes, so that only the disks themselves were available for ion collection. The probe signals measured the ion flux at different locations, as well as, the flux as a function of time.

The pulse-to-pulse deviation was found to be negligible when the external variables, such as gas pressure and RF power, remained constant during an implant. However, the temporal consistency within the pulse depended strongly on the operating pressure of the argon. Higher pressures yielded a peak of ion current at the beginning of the plasma pulse, while lower pressures yielded an increase of current at the end of the pulse (Fig. 5). At the optimal pressure of approximately  $5$  to  $8 \times 10^{-4}$  Torr the pulse was relatively flat, representing a constant current throughout the plasma pulse. The flat pulse, which does not necessarily represent better implantation, makes it simpler to calculate the final implant dose. This flat pulse pressure was also found to be the

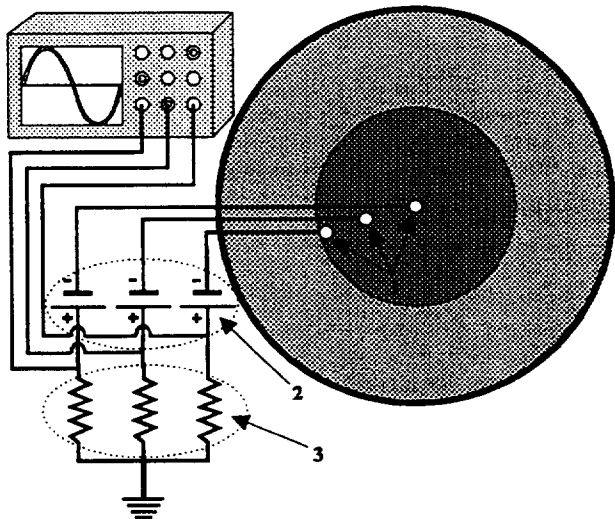

Fig. 4. Schematic diagram of ion current probe measurements: (1) planar Langmuir probes, (2) batteries for probe biasing, (3)  $100 \text{ k}\Omega$  resistors to measure voltage drop across due to ion current.

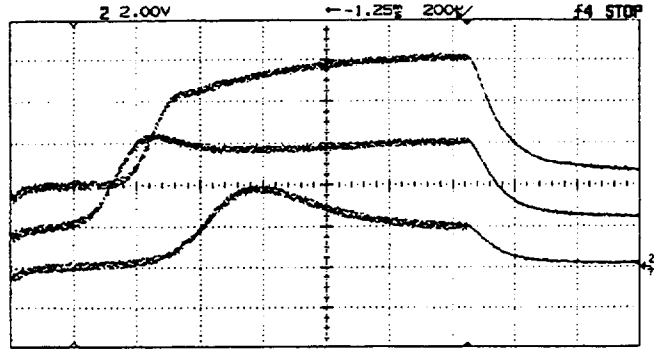

Fig. 5. Pressurization effects on ion current: current with  $0.3 \text{ mTorr}$  argon (top),  $0.8 \text{ mTorr}$  argon (middle), and  $3 \text{ mTorr}$  argon (bottom).

pressure that produced the optimal RF coupling (i.e., the earliest plasma ignition). The effect of increasing the helium or suppression gas lowered the overall ion current and caused plasma ignition later in the plasma pulse envelope (see Fig. 6).

Implantation uniformity across wafer dimensions was greatly aided by the inherent design of the multicusp plasma chamber. For a diffusion limited plasma the magnetic confinement of the electrons due to the cusp magnets provides uniformity of the plasma density within the chamber [6,7]. To ensure this was also true when the plasma was pulsed, the three probes and the wafer holder were independently biased to approximately  $450 \text{ V}$  and the ion current was measured at the center, and at radial distances of  $3$  and  $6 \text{ cm}$ . The wafer holder was also biased to  $450 \text{ V}$  in an attempt to reproduce the exact conditions of implantation, as well as assuring that the field lines would be as perpendicular to the wafer holder plane as possible. The results showed that, apart from small differences of the pulse shapes coming from the different probes, the current values were less than  $3 \%$  lower than the value at the center probe (see Fig. 7).

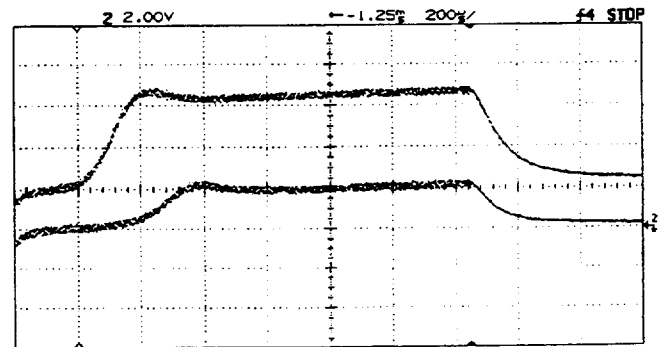

Fig. 6. The effects of the suppression gas on ion current: ion current pulse without helium with  $0.8 \text{ mTorr}$  argon (top), ion current pulse adding  $2 \text{ mTorr}$  helium without changing argon pressure (bottom).

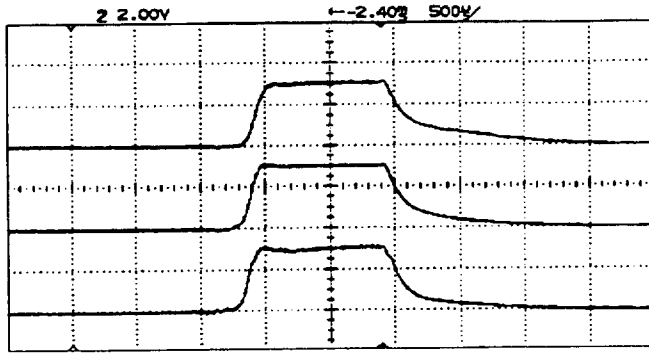

Fig. 7. Ion current from the three probes at 450 V across 100 k $\Omega$  resistors: center probe (bottom), probe at 3 cm radius (middle), probe at 6 cm radius (top).

For RF powers in the range of 150 to 225 W and with a bias of 450 V the typical ion currents from the planar probes were 1 to 2 mA/cm<sup>2</sup>. This yields a particle flux of  $6.7 \times 10^{15}$  to  $1.3 \times 10^{16}$  particles/cm<sup>2</sup>·s. With a duty factor of only 1% (1 ms plasma pulses at 10 Hz) the implantation time for a typical  $5 \times 10^{14}$ , and  $5 \times 10^{15}$  dose would be 4 and 40 seconds, respectively. Using an improved switching device (capable of >10 Hz) these times could be significantly reduced. As the plasma pulses were widened (>2 ms), an increase in electric breakdown occurred along with an ensuing momentary collapse of the bias voltage.

Finally, the most important result concerns the energy of implantation. The approach of pulsing the plasma allowed for implantation to occur at a constant energy. As mentioned previously, the inclusion of a sufficient capacitance fixes the bias voltage during implantation. As the middle trace of Fig. 3 shows, there was no change in bias voltage during implantation. Therefore the ions present during the plasma pulse are accelerated with the same energy toward the substrate upon entering the plasma sheath (assuming an adequate mean free path, i.e., no significant scattering). When the capacitance is less than satisfactory a small dip in implant energy is observed (see Fig. 8).

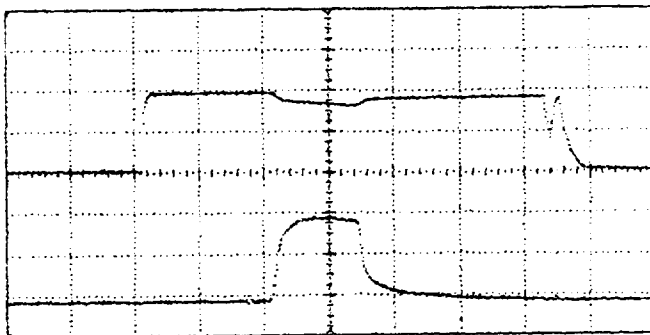

Fig. 8. The effect of insufficient capacitance on bias voltage (top). (The lower trace is that of total ion current to the wafer holder.)

## V. CONCLUSION

As the results show this method of PIII was successful in its ability to implant consistently at a fixed energy, as opposed to conventional PIII's pulsed energy. As long as glow discharge and electric breakdown are avoided through manipulation of the operating conditions, this method will offer improved control of the implant energy for full wafer implantation. In addition, because this method limits the existence of the plasma, there is less time for substrate surface/plasma interactions to take place, as well as wafer heating due to the plasma. However, further testing would be required to improve the uniformity of the ion flux to less than 1% for actual wafer processing. Areas for subsequent study include antenna position, size, and geometry, all of which will effect plasma production and thus possibly contribute to uniformity. Moreover, since most of the dimensions of the device were chosen rather arbitrarily, such as chamber size, there is much room for improvement of uniformity to meet industry standards. Furthermore, the flexibility of source dimensions means that once uniformity is achieved, this method of PIII can be scaled to handle any size wafer.

## ACKNOWLEDGMENT

We would like to take this opportunity to thank T. McVeigh, S. Wilde, and the employees of Spectrum Sciences for their technical assistance. This work was supported by Spectrum Sciences under CRADA BG-94-121(00) with Lawrence Berkeley National Laboratory and the Division of Nuclear Physics, U.S. Department of Energy under contract No. DE-AC03-76F00098.

## REFERENCES

- [1] J.R. Conrad and C. Forest, *Proc. IEEE International Conference on Plasma Science*, Saskatoon, Canada, pp. 28-9, 1986.
- [2] J.R. Conrad, J.L. Radtke, R.A. Dodd, and F.J. Wozzala, *J. Appl. Phys.*, vol. 62, pp. 4591-6, 1987.
- [3] C. Yu, N.W. Cheung, *Nucl. Instrum. Methods. Res. B*, vol. 79, pp. 655-658, 1991.
- [4] B. Mizuno, I. Nakayama, N. Aoi, M. Kubota, and T. Komeda, *Appl. Phys. Lett.*, vol. 53, pp. 2059-61, 1988.
- [5] S. Qin, C. Chan, *J. Vac. Sci. Technol. B*, vol. 12, pp. 962-8, 1994.
- [6] K.N. Leung, G.R. Taylor, J.M. Barrick, S.L. Paul, and R.E. Kribel, *Phys. Lett. A*, vol. 57, pp. 145-147, 1976.
- [7] R. Limpaecher and K.R. MacKenzie, *Rev. Sci. Instr.*, vol. 44, pp. 726-31, 1973.
- [8] D.S. Pickard, W.B. Kunkel, K.N. Leung, A.T. Young, *Rev. Sci. Instr.*, vol. 67, pp. 1666-9, 1996.