

WORKSHOP ON A LEAD-ION LINAC FOR THE CERN ACCELERATOR COMPLEX  
-----

CERN, PS DIVISION  
CH-1211 GENEVA 23, SWITZERLAND

MAY 25-26, 1987

Scientific Secretary: U. Tallgren

P R O G R A M M E  
-----

0. Welcome. (O. Barbalat)
1. Introduction. (H. Haseroth)
2. Feasibility Study for a Lead Linac. (M. Weiss)
3. Sources
  - 3.1 ECR Source (R. Geller)
  - 3.2 High Current Sources. (N. Angert)
4. Focussing and Acceleration. (Moderator: P. Lapostolle)
  - 4.1 RFQ. (H. Klein,)
  - 4.2 Focussing at low beta. (M. Weiss)
  - 4.3 Alvarez vs Wideroe. (J. Klabunde)
  - 4.4 Accelerating Structures for Heavy Ions. (G.Dome)
  - 4.5 Alternating Phase Focussing (P. Lapostolle)
  - 4.6 Break-Down Problems. (H. Klein)
  - 4.7 High Intensity Aspects and Stripping (J. Klabunde)
  - 4.8 The Japanese RFQ 'TALL' (M. Olivier)
5. Vacuum Considerations. (A. Poncet)
6. RF Power. (F. Nitsch)
7. Beam Instrumentation.
  - 7.1 Beam Instrumentation at the Unilac. (J. Klabunde)
  - 7.2 Instrumentation at the CERN linacs. (P. Tetu)
8. Conclusions. (H. Haseroth)

## PARTICIPANTS

---

### Outside:

N. Angert, GSI Darmstadt  
R. Geller, CEN Grenoble  
J. Klabunde, GSI Darmstadt  
H. Klein, Univ. of Frankfurt  
P. Lapostolle, consultant  
M. Olivier, CEN Saclay

### CERN :

F. Caspers  
G. Dome  
A. Fiebig  
G. Nassibian  
F. Nitsch  
A. Poncet  
D. Warner

### Linac Group:

H. Haseroth  
C.E. Hill  
J. Knott  
U. Tallgren  
P. Tetu  
M. Weiss

## 0. WELCOME. (O. Barbalat)

I welcome our outside guests on behalf of the PS Division Leader, Roy Billinge. After the very successful oxygen run in September last year, there is now a strong interest in heavier ions, and we hope to accelerate sulphur ions next autumn. At present, there is no formal project for a CERN lead linac. This could change, if, in the future, there is enough interest and pressure from the physicists. Therefore, I wish you a fruitful and interesting workshop on the lead ion linac!

## 1. INTRODUCTION. (H. Haseroth)

First, I will trace the history of ions at CERN. Deuterons were accelerated in Linac 1 for the first time in 1964, more like a curiosity. Some years later, the experiment was repeated with higher beam currents and longer pulses. This time the acceleration in the PS was also successful, and a deuteron beam was delivered to ISR. The physicists started to be interested, particularly Faessler and his group, when they heard that we could also produce alpha particles. However, what we thought to be an alpha beam of decent intensity, turned out to be mostly deuterons, even though we had fed the source for a few days with helium! We finally managed to produce a good alpha beam by making helium 1+ in the source, and stripping the beam at 500 keV. At ISR, good stacked alpha beams were then obtained at several runs.

Meanwhile, more physicists became interested, inside and outside CERN, and they stressed the need for still heavier particles. A collaboration was therefore started with Frankfurt on an EBIS ion source, and some RF structure work. A decline in interest, from the physics community, unfortunately stopped this work. A revival of the interest came after the several good alpha runs at ISR. A letter of intent was accepted for experiments at CERN with heavier ions. A collaboration started between GSI, LBL and CERN. It was agreed that CERN should do the implementation, GSI provide the ion source (constructed at Grenoble), and LBL build the RFQ. At this time, we had dispensed with the voluminous Cockroft-Walton preinjector at Linac 1, and installed a 500 keV RFQ as a replacement. This provided space for the installation of an oxygen ion source with RFQ, and their heavy power supplies, consuming several hundred kW.

Last year, we made an oxygen beam finally after some teething problems. The source produced oxygen 6+, and to

keep the RF synchronism, we had to increase the fields in the linac tanks by 33 percent. This was indeed a feat with such an old machine, as our Linac 1. The oxygen run was not the end, as GSI now will pay for a sulphur source from Grenoble, which should run at CERN towards the end of 1987. Some ideas exist also on how to make low intensity beams of argon or calcium ions, by using the sulphur beam as a carrier.

However, to reach substantially heavier ions, such as lead or uranium, we need a new accelerator. The lead nucleus, being a more perfect sphere, is preferred over uranium for the physicists' experiments. So, Mario Weiss has looked into the feasibility of building an inexpensive lead linac, using, as far as possible, existing equipment of the old Linac 1. He will first review his work and thereafter we should discuss his ideas, and any other proposal that might turn up at this workshop. We must though keep in mind, that the new facility has to fit into the existing building.

There are some enthusiasts who even see the end goal not being a lead beam on a fixed target at SPS, but rather lead on lead in a future LHC accelerator! But then we obviously will need much higher intensities. If we aim so high, then there are some options which we must consider, particularly for the low energy part of the linac.

## 2. FEASIBILITY STUDY FOR A LEAD LINAC. (M. Weiss)

The main specifications of the CERN lead linac are the charge to mass ratio of the ions,  $q/m = 1/7$ , the final energy, 8 MeV/nucleon, the overall length, less than or equal to 35 m, and the requirement to operate at 200 MHz, in order to reuse, as far as possible, the existing RF equipment.

A low  $q/m$  value makes the acceleration and the focussing very inefficient. It is this latter problem, which is preponderant and has a primary influence on the choice of accelerators.

The Alvarez linac, which usually operates in the beta-lambda mode, can be designed for two beta-lambda operation in order to ease the problem of focussing. A two beta-lambda linac is, on the other hand, much less power efficient. The problem of power in the Alvarez structure, in the two modes of operation, has been studied recently by J. Klabunde and J. Ungrin at Darmstadt. The work done at CERN is somewhat complementary: we have analysed the accelerators from the point of view of their focussing capabilities. Simple formulae of smooth focussing were

derived and used, to link the synchrotron and betatron phase advances to accelerator and focussing parameters.

The CERN lead injector, which will be composed of several accelerators, would have an RFQ at the low energy end, and a beta-lambda Alvarez at the high energy end. The problem is the choice of accelerators at intermediate energies of a few hundred keV/u. For that region it could be interesting to consider a two beta-lambda Alvarez, or an interdigital structure. We can be guided also in our choice by existing installations of heavy ion accelerators, such as the Unilac at GSI, Darmstadt, or by the new Japanese project, where the more than 7 meter long RFQ, labelled TALL, accelerates ions with a q/m of 1/7 at a frequency of 100 MHz to energies of 800 keV/u.

The smooth betatron phase advance per period is given by

$$G_{OT}^2 = \frac{B_f^2}{8\pi^2} - \frac{1}{2} G_{OL}^2$$

where  $B_f$  is the smooth focussing and  $G_{OL}$  the synchrotron phase advance per period. The first term on the right hand side is preponderant, and can be expressed (for magnetic focussing as in the Alvarez) by

$$B_f \propto \frac{q}{m} \beta \chi G \lambda^2 N^2 \quad \text{where}$$

$\lambda$	RF wave length
N	number of cells/period
G	magnetic gradient
$\beta$	relativistic factor
$\chi$	factor depending on the type of focussing (+-, ++-- or +++----) and on $\mathcal{L}$ (quad filling factor/cell)

The smooth focussing depends on  $\beta$  (more critical at lower energies) and quadratically on  $\lambda$  and N. Therefore, lower energies and ++-- or +++---- focussing have to be used in extreme cases. The quadrupole filling factor  $\mathcal{L}$  is 0.5 in the  $\beta\lambda$ -Alvarez, but is 0.75 in a  $2\beta\lambda$ -Alvarez.

It is interesting to compare the Alvarez structures designed for  $\beta\lambda$  and  $2\beta\lambda$  operation. (It should be stressed that we talk about a  $2\beta\lambda$  structure designed for this operation, and not a  $\beta\lambda$ -structure run in a

$2\beta\lambda$ -mode.) To facilitate the comparison, we keep in both cases the ratio

$$\frac{g}{\beta\lambda} = \frac{1}{4} ,$$

where  $g$  is the gap length. This means that

$$\begin{aligned} \frac{g}{\text{cell length}} &= \frac{1}{4} && \text{--- } \beta\lambda \text{ - Alvarez} \\ &= \frac{1}{8} && \text{--- } 2\beta\lambda \text{ - Alvarez} \end{aligned}$$

Usually the ratio 'g/cell length' is adjusted to give the best effective shunt impedance. The above values are not far off. The accelerating efficiency is

$$\bar{E}T = E_s \cdot \frac{g}{h\beta\lambda} \cdot \frac{1}{E_f} \cdot T \quad \text{where}$$

- $E_s$       maximum surface field
- $h$         mode number (1 or 2)
- $E_f$       field enhancement factor ( $\sim 1.5$ )
- $T$         transit time factor

Evidently, for the same  $E_s$ , the accelerating efficiencies of both Alvarez modes stay in the ratio 2/1. This is the price we have to pay for the better focussing in the  $2\beta\lambda$ -mode. Fig. 1A shows the effective shunt impedance,  $ZT^2$ , as function of the energy,  $W$ . For  $W < 1\text{MeV/u}$ , even the  $\beta\lambda$ -Alvarez has a rather low  $ZT^2$ , and, in the  $2\beta\lambda$  case, it starts to fall above 1 MeV/u.

The focussing situation is presented on Fig. 1B. If one limits the magnetic flux density in the quadrupoles to 1.3 T, a  $\beta\lambda$ -Alvarez with ++-- focussing is not possible below 500 keV/u a  $2\beta\lambda$ -Alvarez with +- focussing can, on the contrary, start as low as 150 keV/u. The effective shunt impedance, as seen from Fig. 1A, is very low at these energies, but still more favourable than in the RFQ's.

To conclude, the question is how to optimize the CERN lead injector at intermediate energies, 200-500 keV/u and what structure to choose for this region. Hopefully, this will be more clear at the end of the workshop.

Discussion:

- "What would be the voltage required for the ion source EHT platform?". (R.G.)

- "We took 100 kV as a reasonable assumption but, if necessary, one could lower this value. (M.W.)

- "Is 200 MHz really imperative, or could we not consider to go to lower frequencies?" (H.K.)

- "We can consider other frequencies, but we must remember that we actually possess a lot of equipment for this frequency, hence, if feasible, a 200 MHz linac is obviously a less expensive project. However, if there are good technical reasons, we can certainly go to lower frequencies." (H.H.)

- "What is the pulse length of the beam?" (H.K.)

- "About 200 microseconds at 1-2 Hz." (H.H.)

- "What is the beam current you will need for fixed target physics, and in the second stage for colliding lead beams?" (H.K.)

- "10 microamps (electric, not particle current) at 8 MeV/u after stripping to a q/m ratio of 1/3 seems to be the lower limit which the booster can handle, if the beam phase feedback controls should work properly. For the second stage with the Large Hadron Collider, LHC, we take as a crude guess a factor of 100 times more. As a matter of fact, there is the so called Weizsaecker-Williams effect. In the LHC you have the relativistic compression of the large field due to the fully stripped nucleus. That field becomes at high gamma so strong that it shakes the neighbour nucleus, and you may shake off a proton. Therefore, if you have too high a luminosity, you destroy your beam, not by interaction between particles by collision, but due to that effect. Consequently, for relativistic beams, the attainable luminosity for the users might be limited, even without considerations of space charge limits in the accelerators. Of course, one could in such a case envisage to use calcium, or to lower the energy. Anyhow, a factor

of 100 in intensity seems a reasonable crude first guess for stage two." (H.H.)

- "Can you give the  $q/m$  at the different stages of acceleration?" (G.D.)

- "We start with a  $q/m$  of 1/7 from the source. After stripping at the end of the linac we should have 60+/207, which then would be valid for the booster and the PS. Before entering the SPS we do a full stripping and arrive at 82+/207. This scheme should not be very different for whatever option we choose for the lead linac." (H.H.)

### 3. S O U R C E S

#### 3.1 ECR-source. (R. Geller)

-----

The possibility of building a satisfactory ion source for your lead accelerator will, to a large extent, influence the cost of your project, and hence its feasibility. I have tried to write down some scaling laws for the ECR ion source, some are based on physical facts, others on experience (Fig. 2). As you know, in plasma physics scaling laws are sometimes very restricted, and a factor of two might already be quite a lot. Scaling laws applied to magnetic fields is also a source of worries, because with permanent magnets we are rapidly limited to what can be achieved in practice. I am also concerned about the problem of microwave power generation, and the reliability of microwave components.

If we call  $q$  the average charge of the ions coming out from the source, it will be proportional to the logarithm of  $n$  times  $\tau$ ,  $n$  being the electron density of the plasma, and  $\tau$  the ion lifetime in the plasma. The plasma electron density is proportional to the square of the microwave frequency, and the ion density is equal to the electron density divided by the average charge  $q$  of the plasma.

We must have plasma electrons available with an energy of at least three times the ionisation potential of the ions we want to obtain. The values for particles of interest to us are given in fig. 2A. For instance, for oxygen 6+ we get  $3 \cdot I_p = 750$  eV, for lead 30+ we require 3000 eV. You see that the necessary energy goes up fast.

Another scaling law is the life time of the ions. I took it proportional to the magnetic field in the source,



raised to the power 1.5, instead of 2, as predicted by the classical diffusion theory (which we never get). So this is a compromise. It is interesting to note that the electron life time in the plasma is given by the ion life time divided by the average charge. This follows, because when you have one ion with charge  $q$  leaving the plasma, it drags  $q$  electrons with it. Therefore, we must take into account the life time of the electrons, and not the one of the ions, if we are concerned about the life time of the energy in the plasma. Only the plasma electrons are energetic, so if you lose them rapidly, you have to feed a lot of microwave power back into the plasma.

I now come to the first important question. What is the necessary microwave power we need to feed into the source? This power increases with the square of the frequency, it is also proportional to the ionisation potential of the ions we want to obtain, as well as to the volume of the plasma. It is proportional to the magnetic field to the power -1.5, and to the average charge of the ions.

The second important question: What are the available ion currents coming out of the source? We have to forget about the Child-Langmuir law, and look for the number of ions incident on the extraction hole, since we can never extract more than what arrives there. We find that this current varies as the square of the frequency, like the charge state divided by the average charge state, and, unfortunately, it decreases with the mass of the ions. In other words, everything else being equal, we get for lead instead of neon ions, a 10 times lower current, since lead is 10 times heavier than neon.

If we look on the ECRIS scaling graph (Fig. 2B), we can see that it is a pity that there is not a demand for mercury, since that element would probably be easier to handle in the source than lead. The shape of its nucleus is also spherical. Anyhow, if I take the 15 GHz frequency, which we delivered to CERN for the oxygen source, we have a real point on the diagram, as well as the one for 10 GHz, whereas the 20 and 30 GHz values are extrapolations. We have already done oxygen 6, sulphur 12 and argon 13. We look now for xenon 25 and lead 30. The electron temperature needed was earlier only 750 eV, here it is nearly 2000 eV and what we need in the future for xenon and lead is 3000 eV (Fig. 2A).

The plasma volume considered is always one litre. In the table we see that the necessary microwave power in the first source was 0.5 kW, it amounts to 2 kW for the sulphur source, it should be 6kW at 20 GHz for the xenon and the lead sources. At these frequency the necessary magnetic

field is 0.84 T. In the table we can also see values for the densities and the life times. We expect an ion current of 30 microamp.

Assuming a high voltage installation of 25 kV we arrive at a total cost of 11 M FFr. Three years of research and development with three engineers is assumed. The price of the microwave generator and components, as well as the equipment for the magnetic field, are also given in the table. I warn you that the figures could be 10-20 % wrong.

I have also looked on the case of 30 GHz, where gyratrons can be used to generate the needed  $\approx 25$  kW of RF. It is difficult to build a superconducting field around a one litre volume, because one cannot bend the superconductors with such a small radius. Therefore you need at least a diameter of 10-15 cm, giving a bigger volume, say 10 litres. You need in this case 1.25 T and  $\approx 250$  kW of microwave power. This is really the limit for gyratrons, and remember they are not very reliable and their power tuning remains an open problem. In addition, the power dissipation on the walls becomes troublesom. If you want Pb 38+, like some people propose, it becomes unrealistic at 30 GHz.

I have also looked on another variant at 30 GHz, this time a very small source of only 125 cubic centimetres. In this case we could again try to use permanent magnets, probably with Bitter coils for the solenoidal field. We will need 3kW of microwave power, which is possible with two or three extended wave generators, available in Europe or Canada. This looks possible, but again the power diipated on the wall becomes critical. ( $20 \text{ W/cm}^2$ ). Therefore, I am glad to see that our first proposal falls within the requirements discussed at this workshop. Nevertheless, we are prepared to go further ahead if necessary, and to take some risks. In this case we probably will need 5 engineers during 5 years, of which the gyatron itself permanently occupies three engineers. The life time of a gyatron is only about a few hundred hours, and every time you kill it, it will cost you nearly 1 million dollars to replace it! So, I do not say it cannot be done, but not alone by us at Grenoble, rather as a joint effort.

#### Discussion:

- "What was the predicted current out of the source?"  
(H.K.)

- "30 microamps. out of the source (electrical), both from the 1 litre and the 125 cm<sup>3</sup> source. The current depends only on the plasma density, hence the number of

ions which will reach the extraction hole." (R.G.)

- "What is then the interest to have a bigger source?" (P.L.)

- "None, well perhaps you can expect a longer lifetime of the ions, because the diffusion length of the plasma is longer. This will have to be checked." (R.G.)

- "How much will one gain?" (P.L.)

- "If you talk to Tokomak people they would say: The bigger, the fatter, the better." (R.G.)

- "There is another factor, which I cannot scale, and that is the influence of mixing gases. In these sources we normally have a light support gas plus the useful gas, therefore always a mixture. For instance, the oxygen source works better when you put helium inside. This depends on q-average, if it is lower you need less microwave power. Say you have a source with maximum 1 kW power as limit. If you now put also a light gas into the source, q-average goes down, and you need less microwave power. You can therefore now reach a higher plasma density with your available microwave power". (R.G.)

- "Why are we using helium and not hydrogen?" (H.H.)

- "Due to the hot electrons in the plasma, hydrogen gas will deliver small amounts of  $H^+$  and  $H_2^+$  (because the ionization probabilities are bad) whereas with helium one obtains many  $He^+$  and  $He^{++}$  inside the plasma. Thus the improvements due to the mixing gas effect are not due to the chemistry but to the ion average charge. The average ion charge decrease improves the lifetime of the plasma. (R.G.)

- "A question to Mario Weiss, we have heard that we can have 30 microamp. out of the source and about 10 microamp. out of the linac. Can you say something about expected losses. (H.K.)

- "At such low currents the losses are extremely small. (M.W.)

- "Can you say something about the emittance?" (H.K.)

- "It should be very similar to the present sources, and they have a small emittance, something like 0.2 mm\*mrاد." (R.G.)

- "Due to the magnetic field?" (P.L.)

- "Probably due to the extraction region, magnetic stray fields etc. It is not the ion temperature." (R.G.)

- "What can you say about plasma oscillations and stability.?" (P.T.)

- "When you see plasma oscillations and instabilities you twiddle the knobs and they disappear. You should never reach the cutoff frequency, hence no wave penetration into the plasma. People working with the source learn to avoid the turbulent zones. It is of no use to work there, since you do not get the power into the plasma. The sulphur source is not more troublesome than the others." (R.G.)

- "There is no room, I gather, for normal electromagnets in your scheme?" (D.W.)

- "We have used electromagnets in our first source, but we needed something like 2-3 MW. (R.G.)

- "To illustrate this point, the sulphur source itself uses more electrical power than the rest of Linac 1." (H.H.)

- "We still use an electromagnet for the solenoidal field, but not for the hexapolar field." (R.G.)

- "What is the power generator you are considering for the 20 GHz source?" (G.D.)

- "This is an important question. We cannot freely increase the frequency, because there are generators available only for a few frequencies. Presently there is on the market a 19 GHz 10 kW watercooled klystron. Lifetime is good, but they are expensive, whereas it is difficult to give an opinion about the gyratrons. Some fusion people say they only work for half an hour, others say that they have to change the window every week. It certainly is advanced technology which we should try to avoid, in order to get a reliable source for this project." (R.G.)

- "Could one not use several magnetrons working in parallel?" (F.C.)

- "Frankly, I have not considered that, but if one needs a big number of them, it could perhaps be difficult to produce a smooth RF-pulse, which gives a smooth plasma current." (R.G.)

- "What is the pulse length of such a magnetron?" (P.L.)

- "Of the order of a microsecond." (F.C.)

- "Could it not be difficult to phase the output from several parallel magnetrons?" (P.L.)

- "It would certainly not be easy." (F.C.)

### 3.2 High Current Sources. (N. Angert)

-----

We have so far discussed high charge state ion sources, and we will now discuss high current sources. I want to go the way from highly charged ions to medium and low charge states, with correspondingly increasing source currents. For that reason, I will describe the Penning, or PIG source, the MEVVA and the CHORDIS ion sources, to give you an impression of their capabilities. For the PIG source I refer to work by M. Mueller, for the MEVVA to I. Brown and R. Keller, and for the CHORDIS also to R. Keller.

You all know the principles of the PIG source with two cathodes and a cylindrical hollow anode (Fig. 3A). You can either feed the source with a gas or sputtered metal ions. A typical charge state spectrum for uranium is shown in fig. 3B. If you would replace uranium with lead, you should get a similar spectrum with one charge state less. In other words, a Pb 8+ peak would correspond to the U 9+ peak. You see that this peak gives 30 microamps of beam current, which compares to what we discussed for the ECR source. In fig. 3C is a table of several elements and charge states, which describes the capabilities of such a PIG source. For high charge states you get about 100 microamps, for medium charge states about 1,5 ma, and for low charge states, such as argon 3+, about 4 ma. For currents below a ma, the emittance is about 200-300 mm\*mrads, for higher currents the emittance blows up quickly. You can get a higher current by increasing the extraction area, but you will lose in beam brightness.

Instead of running the PIG source at 50 Hz with a 25 % duty cycle, we did some recent tests with a low repetition rate (Fig. 3D). We heated the cathode by an auxiliary gas, every third pulse we made a sputter pulse of 1 ms. We could then observe 1.4 ma of uranium 10+ in the injection line of the Unilac, which shows that the PIG source can deliver interesting results.

I will now switch to a really high current source, MEVVA, which stands for Metal Vapour Vacuum Arc (Fig. 4A). It is a rather old development, but apparently Berkeley is trying to use one with an accelerator. The results are impressive, 77 ma of titanium 2+, 29 ma of uranium 4+ in an

emittance of 200 mm\*mrad. We have tried such a source on our test-bench at GSI. The analysed currents after a beam transport with quadrupoles and an analysing magnet are shown in fig. 4B. This source has the advantage that you immediately can make all metal ions. It is easy to manufacture and use, and you get multiple charged ions, which saves you a lot of accelerating voltage. The metal arc is unfortunately not so stable and reproduceable as you could wish for an accelerator source. Some development work is needed, but it is still an interesting alternative to other high current sources. We have done some work with a special extraction and an integrated preaccelerating system. We could manage to get a very quiet beam with only 12 mm\*mrad emittance at 159 kV with 15 ma of uranium, which is not so bad.

Let me now switch to our own source work, CHORDIS, a so called cold and hot reflex type ion source (Fig. 5A). It is simply a filament cathode and a cylindrical anode with so called reflector electrodes, which also can be used for sputtering techniques. We have a special multipole magnetic field to get a very quiet plasma (Fig. 5C), which is of importance to get a quiet beam without difficulties for the beam transport. In the range of lithium to bismuth we got several tens of milliamps, in an emittance of 250 mm\*mrad at 30-50 kV extraction (Fig. 5B). The CHORDIS results are given on fig. 6A. We looked not only for singly, but also for doubly charged ions, and what you can get is 20-10 ma of doubly charged ions, as compared to 40-20 ma of singly charged ions. One could go still higher, but we are limited in the current capabilities of the EHT supply. We also looked for multiply charged ions which can be reached under special discharge conditions. For instance, xenon up to 5+, but the currents are low compared with the MEVVA source. Anyhow, this source has a quiet plasma and gives a beam of high brightness, which can easily be transported. In the development stage at present, we can operate with gases and high vapour pressure materials. With sputtering technique we get, as indicated in the table, only a few ma, so we are bound more or less to the oven technique. However, to use mercury would be very easy.

I should like to sum up with a comparison of the sources I have described, as well as the ECR and EBIS sources. The table (Fig. 6B) shows in a crude way their equivalent stripping energy, which goes from 10 keV/u for the PIG source to 10MeV/u for the EBIS source. At the same time you go from high current and low charge states to low current and high charge states. You can for instance reach fully stripped xenon in an EBIS ion source. This table can serve as matter of reflection in the difficult choice of an appropriate source for a project.

#### 4. FOCUSING AND ACCELERATION.

(Moderator: P. Lapostolle)

Before we can have a discussion it is useful that we first get a presentation of the different subjects. A problem is, what is focussing and what is acceleration? They are interrelated and are difficult to separate.

##### 4.1 R F Q . (H. Klein)

-----

We will consider two possible RF structures for the RFQ, the 4-vane and the 4-rod RFQ (Fig. 7).

When you come in to the first part of the RFQ, the shaper (SH), you do not accelerate, but only focus. You go with a stable phase of -90 degrees. Then you slowly start to modulate the vanes in the so called gentle buncher (GB). In the first part of the buncher you do not bunch in real space, but only in phase space, if you want a high beam current. Slowly you come, as the vane modulation increases, to a stable phase of -30 degrees, as in a normal accelerator (AC). At the same time we have to look that the focussing forces are not becoming too weak, since, if you are modulating the vanes, a part of the focussing field is used for the accelerating field.

In fig. 8A, we have calculated, for ions with a  $q/m$  in the range 1/1 to 1/50, the maximum current as function of the phase advance for the horizontal and longitudinal planes. Where the two curves of a given  $q/m$  cut each other, you have a possible working point of the RFQ. This particular case has been calculated on the assumption of a constant emittance, injection energy of 25 keV/u, aperture radius of 4 mm and 100 kV RF at 100 MHz. From the RF breakdown point of view, this corresponds roughly to 2 Kilpatrick. You can see that the maximum beam current decreases as you go to higher masses.

The larger the RFQ aperture, the higher the voltage must be. The RF power increases rapidly, so we prefer to work with small apertures. The lower the frequency, the higher the possible beam current (Fig. 8B). For lower frequencies the bunch length increases, but also the transverse dimension, since we like to keep a spherical shape of the bunch, or close to it. The RF-power required goes up so rapidly, that you cannot handle it. On the

other hand, if you limit the radial bunch dimension to a fixed value, then you get a clear maximum at a frequency, as you can see on the graph.

For the HERA project (Fig. 9) the input energy of the RFQ is 20keV, the output energy 750keV with a minimum beam intensity of 20 ma H-. Since there was more confidence in the vane RFQ at the time of decision, we built a vane RFQ rather similar to the CERN proton RFQ, but we also took the occasion to try out a 4-rod RFQ. Hence, we had the opportunity to compare the two different RFQ's under very similar conditions. The RF frequency chosen for the two RFQ's is 200 MHz. We designed for a beam of 60 ma and obtained 42 ma of accelerated beam with the 4-vane RFQ, and 35 ma with the 4-rod RFQ. The vane voltage is 70 kV, the maximum field 22 MV/m (1.5 KP.), the minimum aperture radius 2.5 mm. We have studied the region between the ion source and the RFQ with the PARMTEC code. It gives the maximum possible current as 43 ma, which is suprisingly close to our results. That the 4-rod structure gives 7 ma less than the vane RFQ, can be explained by the fact that the rods were modulated in a simplified way. One can of course do this in a more refined way by a numerically controlled milling machine. We plan to try this out in the future. Fig. 9 also shows the influence on the beam when you vary the RF power on the 4-rod and 4-vane RFQ's.

We have deviated from the CERN design of the vane RFQ in several respects at HERA. The vanes are not made out of copper but of chromium-copper. We have introduced vane positioners, so the vane position can be adjusted from the outside. We have only one RF-loop and only one RF-plunger to tune the frequency, whereas at CERN you have eight. This is possible, due to an invention by A. Schempp, which diminishes the probability of exciting the disastrous dipole mode (for the beam) in the cavity. This problem of mode-mixing does not exist in the 4-rod structure.

At the moment we are looking into a design of an RFQ for the CRYRING project at Stockholm. Schempp has proposed to deviate from the principle of the gentle buncher, which could permit us to build a shorter RFQ than the one if we follow the previous designs.

The problems in building an RFQ are mainly mechanical. You have to get the tolerances down to something like 10 micrometres. That was the main reason why we looked into another solution, replacing the vanes with 4 rods and lumped circuit elements. The rods are modulated in diameter but the tolerances required are now only about 0.1 mm, ten times less sensitive. The RF excitation of this structure is also quite different. From experience we learned that we can expect a 2% change of the resonance



frequency, when we move this structure into the cavity.

To sum up, you can certainly build a 200 MHz RFQ for the lead project, but if the length becomes equal to two wavelengths it becomes critical. Another possibility is then a 100 MHz RFQ, which should particularly be considered for stage 2. One could go to 1 MeV/u, and at that stage change to a 200 MHz structure of different type for further acceleration.

Discussion:

- "What is the diameter of a rod?" (M.W.)
- "About 6 mm diameter for the thinnest part, with a hole inside for cooling." (H.K.)
- "It sounds like these rods could easily bend?" (M.W.)
- "We had some problems in the beginning when we used brazing at certain places. But after we fixed the parts with screws, those problems disappeared." (H.K.)
- "Why the difference in tolerance between the vane and the rod RFQ?" (G.D.)
- "Because one structure is a resonant cavity, the other a lumped circuit." (H.K.)
- "How far can one go with the final energy of an RFQ?" (P.L.)
- "If you want to go to high energy, you have an advantage to go as high as possible in frequency. However, losses will increase and it seems to me that there is a certain energy gap between the RFQ and the Alvarez where other structures look more interesting." (H.K.)
- "It could still be interesting to push the Alvarez input energy down, at the price of lower efficiency, in order to avoid the complication of an intermediate structure." (D.W.)
- "There exist certainly many solutions which have to be evaluated in the design stage." (P.L.)
- "How does the acceptance influence the scaling of the RFQ?" (N.A.)
- "If you increase the mean radius by 1.4, in order to increase the acceptance, the RF power goes up by a factor of two. Since the voltage goes up, you have to watch the

Kilpatrick criterion, to avoid breakdown problems." (H.K.)

- "Instead of a  $q/m = 1/7$ , could we not consider to go to  $1/10$  and simplify the requirements on the ion source.?" (G.N.)

- "Yes, but in this case you must go to a lower frequency in the RFQ, which is not so beneficial, because it becomes longer." (H.K.)

Summary: ( P. Lapostolle)

The question of intensity seems to pose no problem. There is a question of emittance and acceptance. That influences the voltage, and hence the required RF-power. It might not be the most important criterion, but it should be looked into. On the contrary, one important parameter is the final energy of the RFQ. If you increase the final energy, you have to increase the length. Due to the modulation, the energy goes up more and more slowly, it is not linear like in the Alvarez, but rather similar to the Wideroe. However, as we will see to-morrow, the Japanese have succeeded to build a rather long RFQ. With the vane RFQ there is an increased risk of getting mixed modes, but I wonder if this risk is not minimized with the 4-rod structure.

- "This point will be investigated by us in Frankfurt. We also should like to push up the voltage, thereby making the RFQ shorter and a more efficient accelerator. Anyhow, we should remember that an Alvarez structure typically has an effective shunt impedance of 50-60 Mohm/m, whereas the RFQ only reaches about 10 Mohm/m." (H.K.)

Coming back to the final energy, we see that we have to pay with proportionally more RF power when we increase the final energy, due to the lower shunt impedance of the RFQ. The length will probably not be such that mode-mixing will be a problem. One has to know better the effect of the emittance on the RF voltage and the power, because in this structure, the power needed depends very critically on the emittance and the acceptance of the machine, which is not the case for all structures. What is characteristic of the RFQ, is that the power needed on the shunt impedance is balanced against its acceptance. The higher the acceptance, the higher the power needed. Since we do not want to go to several MeV/u, I do not expect any particular problem with the length of the RFQ.

#### 4.2 Focussing at low beta. (M. Weiss)

-----

The problem of focussing at low beta in an Alvarez structure has been analysed, and the results are shown on Fig. 1B, which we discussed already. We have seen, e.g., that a  $\beta\lambda$ -Alvarez with ++-- focussing can be used from about 500 keV/nucleon. At still lower energies RFQ's are advantageous solutions.

When we design an RFQ, we choose always first a phase advance per period for the synchrotron and betatron oscillations, thereafter we work out the other parameters. Now the question is, should we go as high as 500 keV/u with the RFQ, or should we introduce another structure earlier? This other structure could be a two beta-lambda Alvarez structure. It should be noted that this structure is from the beginning designed to work in the two beta-lambda mode and not, as commonly done, designed for the beta-lambda mode and later used in the two beta-lambda mode. We get a sufficient space for the focussing magnets, but the average accelerating field is of course low. The maximum effective shunt impedance is obtained when  $g/l$ , the gap over the cell length, is about 1/8, but at these low velocities, it is no more than about 10 Mohms/m.

Conclusion: (P.L.)

For the RFQ, we discussed to increase its final energy, and to specify where we have the limits. For the Alvarez, we discussed to reduce the input energy, and there we see that one of the problems is the shunt impedance, which then becomes very low. So we need more and more power as we go down with the energy. With the RFQ, if we go up with the final energy, we need also more and more RF power, so it is a similar problem.

In addition, in the Alvarez, since the surface field goes up, it is not so much the power, but the length, which has to be increased. This is because you cannot go too high with the accelerating field, so you have less gaps and more length to get the acceleration. Nevertheless, the worst factor is, if you go down with the energy, the required magnetic focussing, where fields will quickly exceed what you practically can achieve. There is a way to improve the situation, and that is to go to a two beta lambda Alvarez, because here you have a longer period as compared to the normal beta-lambda situation. Hence, there is more space for the focussing elements, but you pay this with a lower acceleration rate.

Discussion:

- "If you go to two beta-lambda, you give away acceleration rate. It seems to me, that you should first closely look at the parameters at the beginning of the normal beta-lambda linac, and see what possible modifications you can make. For instance, you can go higher than 1.5 Tesla, if you pulse the focussing. You could gain 10% on the quadrupole filling factor, (normally taken as 50%). Safety factor on the aperture is not needed in the beginning. The beginning of the linac is very special, but it does not last very long. I would prefer to play around with such modifications rather than having to switch from a two beta-lambda structure to a beta lambda linac at a higher energy." (D.W.)

- "I agree, we do not have to take a decision now." (P.L.).

4.3 Two Beta-Lambda Alvarez versus Wideroe. (J. Klabunde)

-----

First I will give you very briefly the parameters of the operating Unilac, and then the modifications we are planning. I will finish with some comments about the subjects which we have discussed previously.

The first part of the Unilac is a 27 MHz Wideroe RF-structure (Fig. 10A). The input energy is 11 keV/nucleon, and the output energy is, at the end of the four Wideroe tanks, 1,4 MeV/u. The minimum charge to mass ratio is 10/238, i.e. uranium 10+. As stripper, we use a foil or a gas. In the latter case, we can increase the charge state to 28+ for uranium. The Wideroe structure is followed by four 108 MHz Alvarez tanks, and a structure of several single gap cavities. After the upgradings in 1981-82, the output energy for uranium, and all other ions, (if we only accelerate through the Alvarez tanks) is now 11,4 MeV/u.

The performance given is of the Unilac in its actual state. For operation with our synchrotron, in the future, we have some new ideas. First, we should like to bring up the intensity of the Unilac to the space charge limit of our synchrotron. This work may be relevant for the discussion of phase 2 of the lead injector. For the high current injector, we will use the old beam line, but only three of the Wideroe tanks fed from a high current RFQ injector, (Fig. 10B). Another idea, visible on the same figure, is to install a new injector for the Alvarez, starting with an

ECR source delivering uranium 28+ or lead 26+, followed by an RFQ at 108 MHz. The RFQ could feed an interdigital structure with an output energy of 1,4 MeV. We can then inject, without stripping, in the Alvarez part of the Unilac. We see as an advantage of this scheme, that the high current part of the operation is separated, and for the rest of the machine we can remain with the output intensities at their previous peak values. We have the luck to have Mr Ratzinger joining us. He worked on the so called Schwein accelerator at Munich, where they used the interdigital RF-structure for their tandem. His experience will be useful for the design of our new injector, on which I will now give some comments.

The parameters we are discussing for the new injector is a 50 keV beam from the ECR source of uranium 28+ or lead 26+, followed by an RFQ to perhaps 200 keV/u. Designs are available from Schempf at Frankfurt for energies up to 500 keV, but 200 keV seems a good value, since then the RF power required is less than 200 kW, and we can use the transmitters available for the single gap cavities. We have already finished the first design for the interdigital structure, a tank of 2.5 m length. The necessary RF-power is again below 200kW, and the accelerating voltage is about 10 MV. We can then obtain 1,4 MeV for the heaviest elements, i.e. uranium 28+, so further acceleration is possible directly in the Alvarez. Space is sufficient between the accelerators for matching elements. At Munich, they fully debunched the beam with the help of a fundamental and a harmonic frequency debuncher. Focussing might turn out to be a problem. At Munich, the tanks are very short, and they are capable of using an RF phase alternating scheme. Probably this will not be sufficient in our case, particularly at higher intensities, and Mr Ratzinger is looking into some other solutions.

I will now come back to the Wideroe. At Unilac we have in the first tank the  $3\pi - \pi$  structure, and then the  $\pi - \pi$  structure in the other tanks. In this region you have a high shunt impedance as compared to the Alvarez structure, which of course was the reason why we favoured the low frequency Wideroe. At higher frequencies, I am not sure that you can profit from the Wideroe structure. There the interdigital structure looks more promising, even if the focussing might pose a problem.

In 1984 there were plans for replacing the first tank of the old CERN Linac 1, accelerating silicon 4+. Since  $q/m = 1/7$ , the results are of interest here (Fig. 11). We compared a real two beta-lambda Alvarez with the normal beta-lambda structure, optimized for 2.5 MeV/u. An important factor is the Kilpatrick limit. We also studied the focussing. Taking the limits mentioned by Mario Weiss

for the gradient, acceptance and size of the quadrupoles, we agree with his conclusions that you could go down to about 130 keV/u for the two beta lambda case, and about 600 keV/u for the normal beta-lambda Alvarez. You can vary the length of the structures, depending on the available space, and you get different values for the required RF-power. We took two cases. The first has the two-beta lambda structure up to 2.5 MeV/u, and the second case up to 1 MeV/u, both followed by a beta-lambda structure. The corresponding K.P. figures are 1.0 and 1.5. For a normal beta-lambda Alvarez, this is quite high. At the Unilac Alvarez, at 108 MHz, the field strength goes from 2.2 to 2.6 MV/m, corresponding to a K.P. figure of about 1. For an RFQ 1.5 K.P. is nothing, but we have to ask ourselves if this also applies in the case of an Alvarez.

I have made some preliminary calculations for the lead injector, assuming 200 keV as RFQ output energy (Fig. 12). For the low current case, one can use from 0.2 to 1 MeV a two beta-lambda Alvarez at 200 MHz, switching over to a beta-lambda Alvarez at 1 MeV. The total length of the linac plus RFQ would be about 20 m.

For the high intensity case, I have assumed an 108 MHz Alvarez, because then we have to use beams of a low charge state, perhaps from a Penning source. Based on the Unilac experience, you will have to strip with gas at 2 MeV/u, to reach a charge state of 30+. It is therefore convenient with a two beta lambda structure to 2 MeV, followed by a beta lambda structure up to 8 MeV/u. The total length with the RFQ should be about 30 m. This is a conventional design, based on the normal Unilac quadrupoles. If you can use your shorter quadrupoles, you might go lower with the beta-lambda Alvarez, say to 400 keV, which can be reached by an RFQ. However, if you have the space and the money, the solution with first a two beta-lambda, followed by a beta lambda Alvarez, is a no risk solution.

#### Discussion:

- "In your interdigital structure at 100 MHz, have you already worked out a focussing system?" (P.L.)

- "No, we have just started on that. Concerning the interdigital structure I should like to mention that we have an RFQ for xenon 1+ with an output energy of 170 keV/u. We would then like to come up to 1.4 MeV. We have the Wideroe tank that could handle this kind of current, but we were interested to compare it with an interdigital structure with the same focussing and space charge limit. When one introduces the quadrupoles in the interdigital structure, the shunt impedance goes down and there is no

improvement over the Wideroe." (J.K.)

- "What are you calling an interdigital structure?"  
(G.D.)

- "For me, a Wideroe structure is a transmission line. Its shunt impedance is different from an interdigital structure. On this curve I like to show you how the shunt impedance goes down when you increase the diameter of the drift tube. We are looking for solutions where you do not have to increase the diameter of all drift tubes in the tank, in order to house the quadrupoles." (J.K.)

- "What is clear, is that in the Wideroe and the interdigital structure, the shunt impedance goes up at lower energies, whereas in the Alvarez it goes down. The reason is evident, when you go down in energy, in the Alvarez structure, you keep the same accelerating field. It even goes down due to the transit time factor, while in the interdigital you increase the number of gaps and, since you keep the voltage, you increase the acceleration. In an Alvarez structure, when you go down with the energy, you have also more gaps, but on the gaps you have less voltage. At the other end in the RFQ when you go up with energy, you keep, if you like, the same voltage per gap, but you have less and less fields, while in the Alvarez, you have more and more voltage per gap." (P.L.)

Conclusion: (P.L.)

To sum up, what we have to discuss further is how to make a more efficient focussing, and maybe consider electric focussing at low energies. The magnetic focussing depends on the particle velocity, so it is obvious that it will decrease in efficiency at low energies.

#### 4.4 Accelerating Structures for Heavy Ions. (G. Dome)

---

A very basic fact for heavy ion linacs, as well as for any other accelerator, is the fundamental condition of synchronism. If we take the RF current of a beam of particles of velocity  $v$ , we can write:

$$I = I_0 \cdot e^{j\omega(t - \frac{z}{v})} = I_0 \cdot e^{j\omega t - jkz}$$

The propagation constant of the particle beam:

$$h = \omega / v$$

Let  $L$  be the distance between neighbouring accelerating gaps and  $\Theta$  the phase shift of the RF voltage between those gaps, then the acceleration is based upon the condition of synchronism:

$$\Theta = \frac{\omega}{v} L \quad \text{mod } 2\pi$$

Since the beam loading is small with low intensity heavy ions, the accelerating structure is operated, for reasons of RF power economy, in the standing wave mode.

- If the cavities are of the type SINGLE GAP, fed by independent RF amplifiers, the synchronism condition can always be met by proper phasing of the amplifiers. This is the most flexible, but probably also the most expensive solution (last section of the UNILAC).

- If an accelerating cavity contains SEVERAL GAPS,

$$\Theta = 0 \quad \text{or} \quad \pi$$

for maximum shunt impedance in the standing wave mode.

The synchronism condition becomes:

$$\frac{\omega}{v} L = n \cdot \pi$$

$$\begin{aligned} n &= 2, 4, \dots \text{ for } \Theta = 0 \\ n &= 1, 3, \dots \text{ for } \Theta = \pi \end{aligned}$$

$$\text{i.e. } L = \frac{n}{2} \beta \lambda$$



Higher values of  $n$  result in a lower transit-time factor, because

$$T = \frac{\sin\left(\frac{\omega}{v} \frac{g}{2}\right)}{\left(\frac{\omega}{v} \frac{g}{2}\right)} \cdot \frac{1}{I_0\left(\frac{\omega}{v} \frac{a}{\gamma}\right)} \quad \text{and} \quad \frac{\omega}{v} = \frac{n \cdot \pi}{L}$$

A few words now about the longitudinal beam dynamics. The energy gain per gap:

$$m_0 c^2 \cdot \Delta\gamma = q V T(v) \cos\varphi \quad \text{or} \quad \Delta\gamma = \frac{q}{m_0 c^2} V T(v) \cos\varphi$$

$$\text{If } \beta \ll 1, \quad \Delta(\beta^2) = 2 \frac{q}{m_0 c^2} V T(v) \cos\varphi$$

$$\beta(z) = \sqrt{2 \frac{q}{m_0 c^2} \sum_i V_i T_i(v_i) \cos\varphi_i}$$

as a function of  $z$ , this quantity is determined by the structure, up to a constant factor  $V_{RF} \cdot T$  where  $T = \langle T_i(v_i) \rangle$ .

A given structure can be used for different ions if the function  $\beta(z)$  is maintained, except for a constant factor. From the synchronism condition,

$$\frac{nv}{\omega} = \frac{L}{\pi} \quad \text{hence} \quad \frac{n}{\omega} \sqrt{\frac{q}{m_0} V_{RF} T} = \text{constant}$$

There are several ways to satisfy this condition:

a) Keep  $n, \omega$  and the product  $q/m_0 \cdot V_{RF} \cdot T$  constant; the last condition implies a large  $V_{RF}$  when  $q/m_0$  is small.

b) Keep  $\omega$  constant, change  $n$  from 2 into 4 (when  $\Theta = 0$ ) or from 1 into 3 (when  $\Theta = \pi$ )

This allows reducing the product  $q/m_0 \cdot V_{RF} \cdot T$  by a factor 4 (when  $\Theta = 0$ ) or by a factor 9 when  $\Theta = \pi$ ; but one should not forget that  $T$  is reduced noticeably.

c) Keep  $n, V_{RF}$  and the ratio  $1/\omega \sqrt{q/m_0}$  constant; the last condition implies varying the resonant frequency of the structure (RILAC).

### Type of Accelerating Structures:

ONE GAP STRUCTURE: two half drift tubes on two parallel plates (a single Alvarez cell).

TWO GAP STRUCTURE: ( $\theta = \pi$ ): one drift tube in the middle space between two parallel plates. The drift tube is the open end of a  $\lambda/4$  line which can be a straight stem (Fig. 13A), or a spiral (Fig. 13B).

THREE GAP STRUCTURE: ( $\theta = \pi$ ): two drift tubes between two parallel plates. The drift tubes are the open ends of two  $\lambda/4$  lines operated in push-pull, which can be straight stems (Fig. 13A), or rings (Fig. 13C).

Remark: The more gaps in a structure, the more peaked the overall transit time factor at the nominal particle velocity, i.e. the less flexible the structure is for accelerating ions with different velocities.

### MANY GAP STRUCTURES:

a) RFQ : ideal for very low  $\beta$  . Considered elsewhere.

b) Helix : small dimensions.

c) Wideroe (or Sloan - Lawrence) ( $\theta = \pi$ ) :

$L = 1/2 \beta \lambda$  or  $3/2 \beta \lambda$  . Drift tubes are connected alternatively to the two conductors of a bifilar transmission line. (Fig. 14A). Ideal for low  $\beta$  , because there is no lower limit on the operating frequency.

d) Interdigital line ( $\theta = \pi$ ):  $L = 1/2 \beta \lambda$  or  $3/2 \beta \lambda$  .

This is the waveguide version of the Wideroe accelerator (Fig. 14B). Very high shunt impedance at low  $\beta$  , with low resonant frequency.

If the structure is terminated by metallic plates in the middle of drift tubes, the  $H_{110}$  mode cannot be exited. The first mode that can be exited is the  $H_{111}$  mode, which has a  $\sin(\pi \cdot z/l)$  variation of  $E_z$  .

If one wants to avoid such a  $E_z$  variation, the structure must be terminated at both ends by a space modeling of an open circuit.

Fig. 14C and 15A show variations on the interdigital line concept.

e) Alvarez ( $\theta = 0$ ):  $L = \beta\lambda$  or  $2\beta\lambda$  (HILAC)

Supersedes the other structures when  $\beta > 0.1$

Finally, on Fig. 15B, we see a comparison of structures, with respect to their shunt impedance at different kinetic energies.

#### Discussion:

- "Which structure should we use between the RFQ and the beta-lambda Alvarez?" (H.H.)

- "As you have seen, there is a big choice, interdigital line, a few gap cavities, spiral resonators, there are indeed many possibilities." (G.D.)

- "From Fig. 15B, we can see that for the Alvarez the effective shunt impedance drops towards lower energies, whereas for the interdigital line it increases. One may discuss about the crossing point, as for the interdigital line the size of the drift tubes will have a big influence. The latter is in many ways similar to the RFQ, with which we will have to start. If there is a gap between the RFQ and the Alvarez, it is clear that some variant of the interdigital line is a good candidate. What remains to study is the focussing. Most of the machines that have been built use magnetic focussing, but it is clear that at low beta the electric focussing is more effective." (P.L.)

- "At Greenfield an Alvarez linac has been rebuilt to become an interdigital structure. One has never heard the outcome of this operation, but it would be interesting to find out what happened. They changed the quadrupoles and the stems. The resonant frequency then of course went down quite a lot." (H.K.)

- "Yes, the interdigital line has basically a much lower resonating frequency than the Alvarez, for the same size of tanks, due to the fact that the stems and the capacitance of the drift tubes are an important part of the resonating circuit. (G.D.)

- "One could expect about half the frequency, in the interdigital case." (P.L.)

- "You have to do something with the ends of an

interdigital structure." (H.K.)

- "Yes, you have a sinusoidal variation of the field along the length of an interdigital structure, provided you close the ends with plates. You can change this by leaving the ends open, as does Teplyakov.(G.D.)

- "The situation is very similar to what you have with the RFQ." (G.N.)

- "But, to compare structures, if you take the Alvarez you should use half the frequency, 100 instead of 200 MHz, instead of 2 mode." (P.L.)

#### 4.5 Alternating Phase Focussing. (P. Lapostolle)

-----

Yesterday, we discussed various schemes and structures for the lead linac, trying either to extend the RFQ upwards, or the Alvarez downwards, in order to fit them together, or to join them by new intermediate structures. The latter could have similarities with the Alvarez structure, or be completely different.

On the RFQ, there was some kind of fear that a too long RFQ could be difficult. Horst Klein showed that with the four-rod RFQ, the length was not so much of a problem. Later to-day, Michel Olivier will speak about a Japanese RFQ which is exceptionally long, and seems to work. So perhaps our fear is exaggerated.

Many solutions seem to be available for our lead linac, and I will add still another: Alternating Phase Focussing. Here we find almost the normal Alvarez structure, but without quadrupoles. This is of course an advantage, although for the moment it is not clear where the lower energy limit would be in this case. Horst Klein did some work on the phase alternating scheme 10-12 years ago, before the event of the RFQ. The RFQ looked more interesting, with the result that the other scheme was more or less forgotten. It might, however, be worthwhile to see what such a scheme can offer, without going too much into the details.

Fig. 16A shows the old wellknown diagram of the focussing in a linac, where P and Q are in fact some kind of focussing strength, due to the electric accelerating field and the quadrupolar fields.  $\mu_f$  is the phase advance per period, i.e. it is the synchrotron phase oscillation. A period covers the distance between two gaps in normal  $2\pi$  operation. We then have that  $P_z$  is proportional to the energy gain,  $\Delta W_s$ , divided by the average energy,  $W_s$ , and

multiplied by the tangent of the stable phase:

$$P_z = \left( \frac{M_L}{\pi} \right)^2 = \frac{\Delta W_s \operatorname{tg} \varphi_s}{\pi W_s}$$

(Rigorously  $\operatorname{tg} \varphi_s$  should be replaced by  $\sin \varphi / \cos \varphi_s$ , but if the phase is not far from the stable phase, the result is similar.) This covers the longitudinal stability. For the transverse case, if one assumes circular symmetry, we have, due to the divergence theorem:

$$P_x = P_y = \frac{P_z}{2}$$

If  $P_z$  is longitudinally focussing, the transverse  $P_x$  and  $P_y$  are defocussing. Therefore, in the normal linac, you add some transverse focussing, usually produced by a magnetic gradient,

$$Q = \frac{e B' (\lambda_0 \beta_s)^2}{\pi^2 m c \beta_s}$$

Since the gradient sometimes is positive, sometimes negative, the sum of the focussing forces will be

$$Q - \frac{P}{2} \quad \text{or} \quad -Q - \frac{P}{2}$$

and then you have on Fig. 16A, the familiar necktie diagram of AG-focussing, but rotated. This is the normal situation for focussing in linacs.  $P$ , the phase stability, and  $Q$ , from the magnetic focussing, are similar, but the  $P$  terms are much smaller than the  $Q$  terms. This means, that to compensate for the defocussing of the electric fields, you need a much larger quadrupole focussing.

Now, what are you doing with alternating phase focussing? You replace the magnetic focussing with electric focussing by quickly alternating the phase, either abruptly or sinusoidally. You will then move between the stable and unstable regions of the necktie diagram. In one case, it is longitudinally stable but transversely unstable, in the other the situation is reversed, and overall you get stability. However, since the focussing force in the transverse direction is only half of the force in the longitudinal direction, the corresponding necktie diagram for the alternating phase focussing will be unsymmetrical (Fig. 16B).  $P_1$  and  $P_2$  correspond to the positive and negative RF phases.

In the original proposals, one was using symmetrical

focussing in such a way that one had the classical AG-focussing, but with different focussing in the longitudinal and transverse directions. It is again the factor of two, we mentioned earlier. Bunches, for equal emittances, then tended to be "flat". However, there is no need to have equal values, it can be varied. If you look at what the P's stand for, you see that they represent the phase advance for half a period. One could also imagine, not to change the phase at each gap, but only after two or three gaps. Then follows that  $\mu_z$  is multiplied by n, the number of gaps, and P by the square of n. So, if we take three gaps, instead of one, P will be almost 10 times stronger, and we get a much better stability. Since now we have increased the focussing wavelength, the average focussing is not increased correspondingly. Since we cannot increase the aperture for a given frequency, we have a smaller acceptance. If this situation is acceptable remains to be studied.

#### Discussion:

- "Looking into my ten year old papers, I find that we assumed a q/m of 0.25. We started with 100 keV and went up to 1 or 2.5 MeV/nucleon. The accelerator consisted of 6 tanks of spiral loaded cavities. It turned out that the phase acceptance was reasonable, radial acceptance was small, 4-5 mm\*mrad, with an aperture radius of 0.8 cm. This is not so bad, but my conclusion was, since quadrupole focussing looked more advantageous with a factor of two better acceptance, that APF, Alternating Phase Focussing, was to be disregarded. At the time, we assumed a phase change of only +- 20 degrees. Of course now we want q/m = 1/7, and if someone is interested, we could repeat the calculations for the new conditions." (H.K.)

- "Did you ever study a combination?" (N.A.)

- "No, we did not." (H.K.)

- "By combination, I assume you mean that, since you have drift tubes, you can still put quadrupoles in them. If you have a marginal operation with only quadrupoles, you could, by adding APF, reach a satisfactory operation. One must remember that the structure itself does not raise any technological problem, but still one has to study the size of the drift tubes in order to have this change of phase, which is not trivial. Then the drift tubes will not have equal lengths and if you intend to put quadrupoles into them, you will not always have the same space for them, and so on. It is not impossible to do this, but it is not trivial." (P.L.)

- "In our case, we did not change the length of the drift tubes, but with the six tanks we changed the phase between tanks. The first two had three spirals, the others seven spirals." (H.K.)

- "Work on the APF has been done at several places, but now, with the success of the RFQ, more or less forgotten. Perhaps the same has happened with the idea of electric rather than magnetic focussing at low beta. For instance, one Tesla at 500 keV/u, about c/30, corresponds to 10MV/m, i.e. 100kV/cm, which is perhaps marginal, but still possible. Somewhere there is a crossing point where electric focussing becomes advantageous. Of course, there are practical problems with electric focussing, such as breakdowns, not only on the electric quadrupoles themselves, but also on feed-throughs and supports. But at low velocities, say 100 keV/u, one should perhaps re-evaluate its advantage." (P.L.)

#### 4.6 Break-Down Problems. (H. Klein)

-----

I will not go into any theories, but give you some practical results, and explain what the Kilpatrick limit means. It is an assumption, not a theory, related to RF electric breakdowns. If you accelerate protons between two electrodes by RF, some protons will hit the second electrode, liberate electrons and other particles, which then bounce forth and back until you get a discharge. The energy of the first particles is relevant, so you calculate something like a transit time factor (Fig. 17A). If the frequency is high and the gap is large, the result is different from if the gap is small, or the frequency is low. Therefore, for the Kilpatrick value, the gap width and the frequency always play a role. Both the maximum field strength and the overall voltage have an influence. Normally, you would say that only the field strength matters. This is true if the frequency is high and the gaps are large, but not if the gaps are small or the frequency low.

The Kilpatrick equation

$$W E^2 \cdot \exp [ -1.7 \times 10^5 / E ] = 1.8 \times 10^{14}$$

where E (v/cm) is the field, and W (eV) the energy of the bombarding particles, gives you a curve, (Fig. 17B), with a region of no sparking and another region where sparking possibly occurs. The points on the figure come from measurements around 1952. If you want to follow this

formula, you run into difficulties with the Fowler-Nordheim expression, with discrepancies even by a factor of 1000. Therefore, as said before, the Kilpatrick equation is an assumption, not a theory.

On fig. 18A, we have plotted the voltage as a function of the frequency, with the gap width as a parameter, for the case of two times the Kilpatrick limit. As can be seen, at smaller gap widths the breakdown voltage is smaller, but the field strength is higher, than you can apply for wider gaps. The influence of the frequency is more pronounced at larger gaps, due to the transit time factor. As an example, at 200 MHz with a gap width of 3 mm, you can apply just below 100 kV for a Kilpatrick figure of 2. Now, an interesting question is: how far can you go above the predictions of Kilpatrick before breakdown really occurs? For that reason we have done a series of measurements with a quarter wave structure at 108 MHz (Fig. 18B). You can easily change the material, and the dimensions of the electrodes. We have also explored 27 MHz, and plan to go, in the future, to higher frequencies. Fig. 19A, shows the influence of the pulse length, the situation is much better for short pulses. Curves for two different pressures are given, but, as you can see, the influence of the pressure is not very important. The Kilpatrick limits for the different gap widths are also given, and obviously one can go much higher before breakdowns do occur. This difference between prediction and reality gets smaller as the gap width increases.

The electrode material plays a role in breakdowns, due to the different workfunctions. This is visible on fig. 19B, where the work function has been lowered by the introduction of cesium. Pure copper is about 10% better than chromium copper, but the latter has better mechanical properties. The choice therefore depends on the particular application.

We have also looked what happens with the partial gas pressures, when you increase the RF voltage in a gap. For hydrogen the pressure first goes down, but then, as microdischarges begin to appear, it goes up again. Even though we looked on the partial pressure of several gases, it is difficult to draw a general conclusion, or explanation of the sparking phenomena, from this experiment.

Another important parameter, is the size of the electrode. On fig. 20A we have drawn the Kilpatrick limit for different gap widths, the measured figures for plane electrodes and rods of a diameter of 20 mm. The enhancement factor is important for small electrodes and gaps, and goes down as the gap width or the electrode size increases.



Fig. 20B shows the beneficial result of a good conditioning of the electrodes on the maximum voltage holding, and the corresponding field strengths at various gap widths.

The maximum electric fields in such experiments can be determined either by perturbation methods in the cavity, or by measurement of the x-rays coming out. Fig. 21A gives an example of the latter method, using a germanium detector. From this curve you can work out the maximum energy of the electrons, and hence the field strength. In this case we reached 243 kV, corresponding to 4.9 Kilpatrick, with 1 ms pulses at 108 Mhz, which is a fairly high value. The electrodes had in this case been carefully polished and cleaned in an ultrasonic bath.

The lead project requires rather short pulses, so it should be possible to go fairly high with the field strength, without running into breakdown problems. The situation at 200 Mhz is also more favourable than at 108 Mhz, where we did our measurements.

#### Discussion:

- "How comes that you never see the effect of multipactoring?"

- "This is another effect, which occurs at very low field strengths. It is a resonance situation for the electrons. What we have discussed here, is the effect of ions or protons." (H.K.)

- "But the electrons must play an important role?"

- "Yes, in the final stage when you get a gas discharge, their role gets important. At least, this is the theory. Not everyone believes it. There are many other theories, such as the clump theory, they all lead to rather similar results. The important thing is to do measurements, but there you have to be very careful. Cleanliness is important, as well as a good conditioning. You have to raise the voltage very slowly." (H.K.)

- "Did you have many sparks at 4.9 K.P.?"

- "4.9 K.P. corresponded to 243 kV, at 238 kV we had no sparks. If you get too many sparks, they will destroy the surface of your electrodes, and the situation will deteriorate." (H.K.)

#### 4.7 High Intensity Aspects and Stripping. (J. Klabunde)

---

We assumed yesterday for the lead project, that we should have at the end 8 MeV/u, and an electric current of about 10 microamps of Pb 60+. I will now discuss what you have to do if you go up to something like 1-20 mA. High intensity means first of all, that we have to go to an ion source producing the required intensity, for instance the PIG source. Unfortunately, this means also that we have to start with a beam of low charge state.

At GSI, we expect to start with xenon 1+. For uranium, it would be too expensive to accelerate 1+, and we hope to get enough intensity of uranium 2+. At the beginning we have an RFQ. Its space charge limit is:

$$I \text{ (e mA)} = 0,2 \cdot \frac{A}{p}$$

where  $p$  is the charge state. That means that for lead or uranium 2+, we need about 20 mA of current. The frequency of the RFQ structure is 13.5 MHz, its total length 20m. The output energy is planned for 130 keV/u. The reason for this choice is that it is too expensive to continue the acceleration at this low charge state. We therefore plan to do an intermediate stripping and continue the acceleration with the 27 MHz Wideroe structure. Heavy ions, like uranium, should have a charge state of at least 10+. We base the choice of stripping energy on low intensity measurements, but we should repeat those at higher intensities. The outcome might be that we have to go to slightly higher energies. The Wideroe part of the Unilac should be able to handle the intensity we get. Before we enter the Alvarez structure, we need to do a second stripping. So far, we have installed the first five tanks of the RFQ. The output energy is 45 keV/u. Experiments with argon beams gave us 5mA, instead of the expected 8 mA. We would like to get more current and a higher brilliance. We are also considering to go to 27 MHz for the RFQ.

The high current mode of the CERN lead injector will need gas stripping, because the life time of foils would be too short. I suggest a charge state of 30+ for the post accelerator, i.e. the Alvarez part. Then we could come to an injection energy of 2MeV/u for the Alvarez. One could then copy the GSI front end design, with a low frequency RFQ followed by a 27 MHz Wideroe structure. It is probably necessary to lower the Alvarez frequency from 200 to 108 MHz. Otherwise the longitudinal emittance would become too large.

To summarize, if you stay with the low current option, it is possible to go to 200 MHz for the Alvarez linac. However, if you decide to go for high intensities, the sources which can be considered only deliver low charge state beams. This requires lower frequencies for the RFQ and the Alvarez. I think 27 MHz would be an upper limit for the RFQ and the Wideroe. There is also a possibility to start after the RFQ, and the first stripper, with a two beta-lambda Alvarez linac at around 100 MHz, followed by a beta-lambda Alvarez of the same frequency.

#### Discussion:

- "The figure you showed me earlier (Fig. 21B), giving charge state as function of stripping energy, was that for lead, and was it based on experimental results? (H.H.)

- " Yes it is for lead. At Unilac we have the stripping energy of 1,4 MeV/u and there one finds the maximum at 26+. We have done measurements at different energies, and we have introduced these values in our computers, together with fitting formulae for other energies." (J.K.)

- " For gas?" (P.L.)

- " Yes, for nitrogen. You must use a gas for higher intensities. For uranium at 1,4 MeV, and a current of only 1 microamp., the energy will change if you use a carbon foil, and you have problems with matching later. The lifetime in this case is only about two hours. So if you consider higher intensities, you must go to gas stripping." (J.K.)

#### 4.8 The Japanese RFQ 'TALL'. (M. Olivier)

-----

I will talk about the Japanese RFQ 'TALL' which has been built a few years ago and installed in 1985. It is said, even by the Japanese, that TALL stands for Too Ambitious Long Linac! It is a 7.25 m long machine, which is rather unusual for a wavelength of 3 m. The very first beam was obtained in very good conditions in July 1985, when I was there. The main parameters for this machine are given in Fig. 22A. The input energy is 8 KeV/nucleon for q/m of 1/7, the output energy 800 kev/u. The vanes are in four tanks, each vane section of 1.81 m length is longitudinally separated from the next by a small gap of 0.2 mm. At this junction, the vane edges have a radius of curvature of 0.3 mm, to avoid excessive fields. Calculations show, that in this case, the crest values of the fields do not exceed what is considered as normal in RFQ's.

Nevertheless, after the first power test we have observed some sparking, due to misalignment of the vanes, but without serious consequences.

The duty factor, 16 %, is rather high for this machine. There is only one coupling loop for RF, in one of the quadrants, and no coupling ring for the stabilisation of the field. The RF power is 226 kW for  $q/m$  of 1/7. The cavity consists of copper plated aluminium, the thickness of the plating is 100 microns. In the initial tests aluminium vanes were used, the Q-value obtained was above 7'000. Later, when copper vanes were installed, the Q-value went up to 10'000. SUPERFISH predicted a Q-value of 10'100.

For the RF tuning of this machine, longitudinally and azimuthally, we used side tuners with a diameter of 100 mm. Per tank, there was one moveable side tuner per quadrant, three adjustable with motors. At the end of the machine, we had four capacitive end tuners of 25 mm for a vane thickness, at this place, of 20 mm.

The pumping was rather poor, we had difficulties to reach  $5 \cdot 10^{-7}$  torr, with the two installed turbopumps of 500 l/s.

The PARMTEQ program was used to calculate the precision needed for the adjustment of the vanes. We concluded that with a misalignment between two tanks, or two vanes, of less than 0.2 mm, the transmission factor was not reduced significantly. This is the reason why we could use this geometry for such a long machine with a rather short wavelength. There is always the factor of  $L/\lambda^2$ , which causes problem with the potential distribution, longitudinally and azimuthally. This factor is 5.9 for TALL, which is very high, and twice the value we have for our RFQ at Saclay. The latter is considered already, with its 2.3 m length, to be rather long for an RFQ without compensation rings. However, in the case of TALL, with its four independent tanks, you could assume that this factor should be divided by four. This was also confirmed by measurements during the tuning process.

The possibility of reaching the desired power level was verified by building, before TALL, another accelerator, LITL. This machine accelerated a beam to 138 keV/u with a duty factor of 40 %, and it was possible to achieve without sparking a Kilpatrick value of 1.8, corresponding to 62 KV RF on the vanes. The operation was very stable, and this machine was used for all measurements before the construction of TALL. Fig. 22B shows the TALL beam dynamic parameters of the four tanks.

Calculations and measurements were done for the mode separation in the cavity. As usual, this was done by varying the end inductance of the vanes by the so called cutback method (Fig. 23A). The desired mode is the TE<sub>210</sub>, and by varying the 'cutback area' one can influence the separation from the undesired modes. This effect is even more pronounced in fig. 23B, where we have plotted, for the different modes, the square-root of  $d/s$  ( $d$ = vane thickness,  $s$ = surface left for the magnetic flux) against the frequency. Similar work was done at Saclay earlier, and it was found that you had to choose the distance between the end plate and the vanes with care, in order to avoid a mixing of the dipolar and the quadrupolar modes.

The influence from the variation of the end capacitance on the longitudinal tuning, as measured by a field perturbation method, is shown in fig. 23C. The effect of the variation of the coupling loop is shown in fig. 23D. The four curves correspond to the four quadrants. The side tuners offer a very convenient method for adjusting the cavity. If you adjust one tuner, the opposite quadrant is also affected, but in the opposite direction, whereas the other two quadrants are hardly affected. Fig. 24A shows the result of the final tuning. The deviations are within 3% for the main part of TALL. In the beginning is the matching section with a large gap between the vanes, where the electric field gets larger and larger. Still, there the deviations are within 6.5 % , a very satisfactory result.

The beam tests have been performed with protons, using two type of emittances. The power level was rather low compared to the design figure. The result is given on fig. 24B, which shows the transmission as a function of input power (arbitrary units). Unfortunately, TALL was poorly equipped for matching the input beam transversely. My stay at TALL was only five months. This included the design phase, so there was not much time available for extensive beam tests.

(A set of slides were shown, illustrating the design features of TALL.)

## 5. VACUUM CONSIDERATIONS (A. Poncet)

It is difficult to say something before one can have the necessary information: ion life time (fully and partially stripped), the RF power level, the high voltage level, the RF accelerating technique and frequency (giving the size of the cavities). The design average pressure, operational aspects (pump down and conditioning times), economic considerations, all this input will finally

influence the design of the vacuum system. Anyhow, we will be happy to design a new system once the necessary information is available, because the present old linac vacuum system represents a big work load on our section.

The Linac 2 is now 10 years old, and represents the evolution towards ion pumps: 11'000 l/s, average pressure  $2 \cdot 10^{-7}$  torr. The pressure could probably have been lower, if we would not have been plagued by virtual leaks from the copper-steel boundary in the tanks. With a change of technology, it therefore seems possible to aim for an order of magnitude lower pressure with ion pumps on a new linac.

I believe however, that we should go to cryopumps for the new lead linac. These pumps could be similar to the one presently installed on tank 1 of Linac 1 (10'000 l/s, Gifford-Macmahon cryogenerator, cryopanel and compressor.) It requires no external handling of liquid helium or nitrogen, and is of low cost and highly reliable. It would then be possible to reach easily the 10 to  $-8$  Torr region with very low hydrocarbon content in the residual gas.

In fig. 25A, I have given a figure of merit, with respect to linac 1, for Linac 2 and an expected figure for Linac 3 (the lead linac). This figure is simply the gas load capacity per meter of the RF tanks, 15 for Linac 2 and 45 for Linac 3. This assumes two 10'000 l/s cryopumps for Linac 3, better cleanliness and avoiding the virtual leaks between copper plating and tanks. To reduce cost, we can recuperate turbopumps and control rack equipment from Linac 1.

The present proton RFQ at Linac 1 is pumped with turbopumps and ion pumps. I find this system too complicated and not very efficient. It should be possible to innovate for the new RFQ, and also there use a combination of turbopumps and a cryopump. Even the best turbopumps let a certain amount of hydrocarbons into the vacuum system. It should be worthwhile to try to use also a cryopump acting as a cryotrap during the initial pump-down.

The cryopumps are getting more and more used in industries and laboratories. Their reliability has been improved, and they combine high pumping speed with low price. A price comparison with other pumps is given in fig. 25B. The cryopump on Linac 1 has now more than 10'000 hours of operation, and apart from an initial accident, there has been no more problems. We have now 19 such installations at PS, and we have learnt that some of them might be delivered with some defects which show up early in their life. At 10'000 hours we apply the recommended maintenance, an exchange of the charcoal filters of

the compressors. At the Antiproton Accumulator, AA, we have even been running cryopumps during four years without any maintenance whatsoever. The future will show, if this practice can be recommended!

As a conclusion, I would like to stress the importance of a proper mechanical design for vacuum. This approach has been beneficial for the new electron-positron accelerator at PS. In accelerators where there is no substantial gas load, or problems with RF breakdowns, the vacuum system should not pose any particular problem. One could fear that there will be more problem with the vacuum system for the machine coming after the lead linac, i.e. the Booster. There is actually a study under way to see how we can improve the vacuum in the Booster. It is too early to say what this will cost. In the PS-ring, the vacuum chamber has recently been overhauled, and one can hope that other modifications, if necessary, should neither be difficult nor expensive.

#### 6. RF POWER. (F. Nitsch)

Let me start by making a few remarks about the frequency. As was said yesterday, technically there should not be any problem to design amplifiers for 100, 200 or even 300 MHz. However, if there are not stringent needs for a particular frequency, I would make a plea for our standard frequency of 202,5 MHz. It is a good frequency to use at CERN, since, to the best of my knowledge, there has never been any problem with equipment using this frequency, such as parasites or harmonics therefrom, interfering with the airport services. The 114 MHz frequency, chosen for the EPA cavity, happens to be very close to the RF beacon frequency, used at the airport for navigation purposes. As a consequence, it was necessary to put in a big shielding effort at CERN, and to build the amplifiers in Faraday cages, in order to reduce the radiated power to acceptable levels.

If one thinks to replace Linac 1 by a lead linac, and stays with the same frequency, it is possible to recuperate a big number of elements of proven design and reliability. This is the case for the big final cavity amplifiers, the driver amplifiers, the smaller amplifiers, the so called Frank James amplifiers, and transistor amplifiers. It would not be possible to modify the present equipment to work at a very different frequency. Also on the low level electronic side, phase shifters, phase and amplitude modulators, detector boxes for automatic tuning and feedback, etc., are of interest.

We have a considerable standardisation at our two

linacs. At Linac 1 we have eight, and at Linac 2 seven amplifier chains in service. They are more or less composed of identical elements. We start with a transistor amplifier, giving 200 W of peak power. The next stage is a pre-driver, typically delivering 2.5 kW. The Frank James amplifier, which follows, has typically 40 kW. The driver, which is water cooled, gives up to 500 kW. For the final stages, we have two different types. One is equipped with the powerful TH-116 tube, giving up to 4 MW, but currently used at about 3MW. At Linac 2, we use a slightly different scheme for the final stages, with two smaller TH-170 tubes, each having its own feeder loop in the tank. With this standard list of amplifiers, one can compose any desired arrangement. All drivers and amplifiers have amplitude and phase feed-back, in order to remain stable under the effect of the beam loading.

It is difficult to say something about prices, but I have found a list that was established when a rebuild of Linac 1 RF was envisaged. The feedback and control system was about 600 kFr. in 1982. If one envisage another frequency, then all the amplifier chains mentioned earlier have to be re-built. Obviously this will be much more expensive. More specific details must be known before we can work out the price of such an operation.

## 7. BEAM INSTRUMENTATION.

### 7.1 Beam Instrumentation at the Unilac. (J. Klabunde)

---

The current situation we have at the Unilac is similar to the lead linac low current situation, where we expect 30 microamps from the ECR source. At Unilac we have uranium 28+ after the gas stripper, or lead 26+ with a maximum intensity of 10 microamps. (electrical). Many times we also run with even lower intensities. Fig.26A gives you an overview of our instrumentation. The difference with a proton linac is that we frequently have to change the energy and the ion species. We decided to have many different stages of acceleration and quite a lot of beam diagnostic elements. What you see on the figure 26A was the planning stage. If we take the post stripper section, we find installed Faraday cups, profile harps and phase probes (Fig 26B). This equipment exist after each tank, and also at the end of the Unilac. There we also have additional semiconductor detectors for the beam energy measurements. Similar equipment could be used for the lead linac.

A very important tool for the tuning is the phase



probe. We are using for that purpose a capacitive ring, so the bunch current will be differentiated. We can observe on an oscilloscope a microbunch. In our case the time difference between bunches is 36 nanosec., due to the Wideroe frequency. The bunch length half widths are in the region of 0.8 to 1.5 nanosec. We can see the bunches for intensities above 200 nanoamps of pulse current. That means that if we include the bunching factor of about 30, the peak current will be in the microamp. region.

If we compare the situation of the lead linac, and even the case of a 200 MHz bunch structure, then with a bunching factor of about 20 for a current of 10 microamps. it should be possible to see the bunch shape. We used our equipment at CERN for the oxygen beam, and with 8 microamps. you could see the bunch shape. So it should be possible to use a similar equipment also for the lead linac, even in the low intensity case. An advantage of the scheme we use at the Unilac is, that an energy measurement can be done very quickly. It is therefore very easy to look for the tuning of different sections of the accelerator. We have several phase probes, and using a time of flight method, we can measure the bunch distance on the oscilloscope. Therefrom we can calculate the energy (Fig. 27 ). To tune the RF cavities, we pick up a signal from the cavity and compares it with a signal from a phase probe in front of the tank on an oscilloscope. The operator can then from experience, or calculated figures, very easily tune the tank.

Another very useful instrument at the Unilac is the profile harp. We have between 16 to 48 wires for each plane, the distance between the wires is in the range 1 to 1.5 mm. The sensitivity is very good, you can see beams from a few nanoamps. Depending on beam energy, you can destroy the wires for pulse currents above 50 microamps. Faraday cups are also useful for checking the total beam current, and represent no problem in their use.

As a conclusion I would say that beam instrumentation should not present any particular problem at the lead linac, apart from the constraints imposed by the budget.

#### Discussion:

- "When you talked about the profile harps, did you include the secondary electron current in the figures?" (H.H.)

- "Secondary electrons cause an amplification, but the main effect comes from the ions." (J.K.)

- "Are you not using any beam transformers at the Unilac?" (H.H.)

- "With the help of our phase probes and amplifiers, we can observe the beam envelope and measure the intensity in a nondestructive way." (J.K.)

- "What is the minimum current you can measure?" (H.K.)

- "As I said before, it is possible to see microamps of uranium." (J.K.)

## 7.2 Instrumentation at the CERN linacs. (P. Tétu)

-----

I do not intend to make a complete inventory of the instrumentation at the CERN linacs, but talk about how we adjust Linac 1. In the low energy part of Linac 1, we adjust the source by observing the beam on a probe. After that we adjust tank by tank, looking for the maximum intensity with minimum energy spread in our measurement line after the linac.

In the part of the beam line we share with Linac 2, we have two semgrids installed. The semgrids work on a pulse to pulse basis. We use them for centering the beam with magnetic steerings, and to measure the beam profile. We can measure down to 0.1 microamps., and up to 200 mA. Thereafter, we can go into the emittance or the spectrometer measuring line. In the emittance line, on a pulse to pulse basis, we can measure the emittance in 12 microsec. and get the necessary parameters for matching the beam. The mismatch in percent, in relation to the beam desired for the booster, is automatically updated for each pulse. Due to that the beam ranges in this line from one microamp. to 150 mA, it is necessary to have the facility of changing the gain in the amplifiers. We can also adjust the reference value, to set a given equidensity level. Since we work with sample and hold amplifiers, it is also possible from pulse to pulse to vary the sampling time in the beam pulse. In the future, it would be interesting to do four measurements in one pulse, in order to get a good average value.

To conclude, with the help of new amplifiers and local treatment by microprocessors, it should be no problem, for the intensities considered, to measure, on a pulse to pulse basis, all interesting parameters.

Discussion:

- "Are the grids not damaged by intensive beams?"  
(P.L.)

- "At a beam of 150 mA, it is necessary to limit the repetition rate to one pulse every two seconds. We use titanium of a thickness of 7 micrometers. A beam of 50 MeV loses only about 40 keV". (P.T.)

- "Could it be used at low energy? (P.L.)

- "We could certainly not pass 150 mA at low energies." (P.T.)

- "Scattering could then also be a problem." (H.H.)

- "We have started an experiment to use the light coming out from the residual gas, excited by the beam. It seems to work for our proton beams, but I do not yet know where the limit would be for low intensities." (P.T.)

8. CONCLUSIONS. (H. Haseroth)

Perhaps it is too early for a conclusion. Anyhow, it seems that for beam instrumentation, we have practically everything we need, it seems also that RF is not a problem, certainly there is plea for staying with the 200 MHz, but there is no catastrophe if we have to go to another frequency. On the low energy side, it seems clear that we should start with an RFQ, what type of RFQ structure remains to be discussed. There is also an agreement, that at higher energies we should have an Alvarez. The real problem is what we do between the RFQ and the Alvarez. In the opinion of Dave Warner, we should try to avoid having another structure in between. Other people might favour a two beta lambda Alvarez or an interdigital structure in this place. For people who can stay longer, I would suggest that we meet later to informally discuss these subjects.

I should also like to thank all participants for having participated in this workshop, and for all valuable information we have collected. We will certainly stay in contact, and we will keep you informed of any progress.



## Effective shunt impedance as function of energy

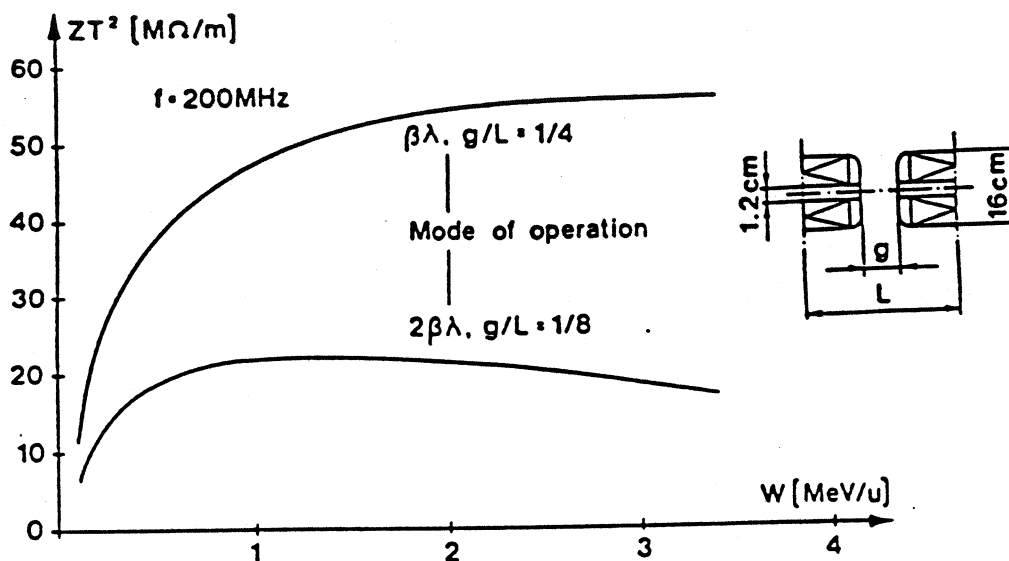

Fig. 1A

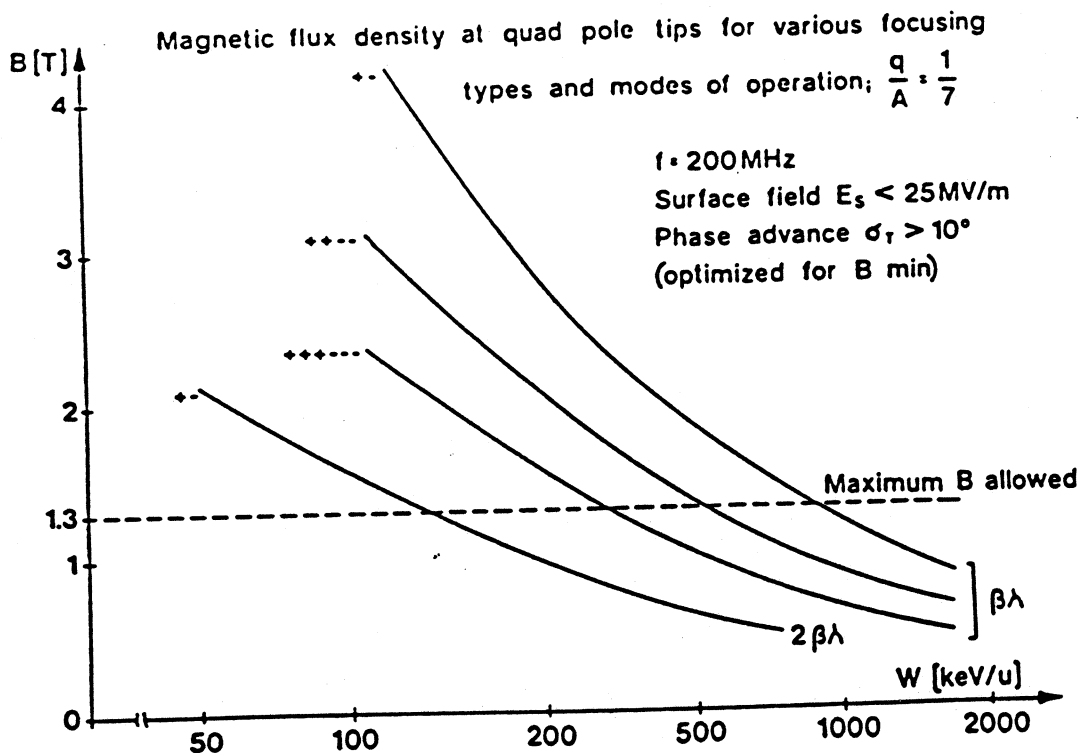

Fig. 1B

ECRIS - Facts & Extrapolations

Fig. 2

f GHz	Species	Elect. Temp. T <sub>e</sub> eV	Plasma Vol. cm <sup>3</sup>	Max. HV Power kW	Bmax Teds	n <sub>e</sub> (10 <sup>20</sup> ) cm <sup>-3</sup>	n <sub>e</sub> (10 <sup>21</sup> ) cm <sup>-3</sup>	Z <sup>+</sup> n <sub>e</sub> (10 <sup>21</sup> ) cm <sup>-3</sup>	E <sub>z</sub> (10 <sup>10</sup> ) V/m	n <sub>e</sub> (10 <sup>21</sup> ) cm <sup>-3</sup>	HV KV	ft cm	Observations	Main Components		
10GHz	O <sup>6+</sup>	75eV	1000	0.5kW	0.42	10 <sup>12</sup>	4	2.5	10 <sup>10</sup>	10	2.5	10 <sup>10</sup>	15KV	100	4MFF	NVgen. - 0.55 amp HV amp. 0.15 amp PM tubes - 120 amp Gain 2
15GHz	S <sup>12+</sup> Ar <sup>13+</sup>	130eV	1000	2KW	0.63	2.8	8	2.5	10 <sup>10</sup>	18	2.2	3.6	15KV	30	5.5MFF	NVgen. 1 amp HV amp. 0.25 amp PM tubes - 2 amp Gain 2

Fig. 2A

f GHz	Species	Elect. Temp. T <sub>e</sub> eV	Plasma Vol. cm <sup>3</sup>	Max. HV Power kW	Bmax Teds	n <sub>e</sub> (10 <sup>20</sup> ) cm <sup>-3</sup>	n <sub>e</sub> (10 <sup>21</sup> ) cm <sup>-3</sup>	Z <sup>+</sup> n <sub>e</sub> (10 <sup>21</sup> ) cm <sup>-3</sup>	E <sub>z</sub> (10 <sup>10</sup> ) V/m	n <sub>e</sub> (10 <sup>21</sup> ) cm <sup>-3</sup>	HV KV	ft cm	Observations	Main Components		
20GHz	Xe <sup>28+</sup> Pb <sup>30+</sup>	300eV	1000	6KW	0.84	4.0	14	2.8	10 <sup>11</sup>	28	2	1.1	100	30	11MFF	IGNORABLE - PM tube NVgen. 5MFF HV amp. 0.15 amp PM tubes - 2.2 amp Gain 2
30GHz	Xe <sup>28+</sup> Pb <sup>30+</sup>	300eV	10000	<250KW	1.26	8.0	14	6.2	10 <sup>11</sup>	50	3.5	4.5	?	30	30MFF?	IMPOSSIBLE B SUPRA or PM JOINT LABS: Pacific STRAUSS SCHEM. SUPPLYING > 60MFF 25 cm dia 30 cm dia CAENBLE POSSIBLE 2.2 amp PM tubes 4MFF 4 cm dia 9 cm dia
30GHz			725	3KW										30	7MFF	Problem 8MFF 4 cm dia 9 cm dia

V.B.  
 6KW 20GHz Possible - reasonable 1992  
 3KW - 30GHz Possible + risks - P.M. Brin - ?  
 250KW - 30GHz JOINT VENTURE = risks !! expensive - 1992 ??  
 Pb<sup>30+</sup> would need 500KW, 30GHz !!  
 @ Price without 100KV insulation system

ECRIS Ion charges

Facts —■—  
 Extrapolations ---■---

1987

q<sup>+</sup> vs (Z)<sub>I+</sub>

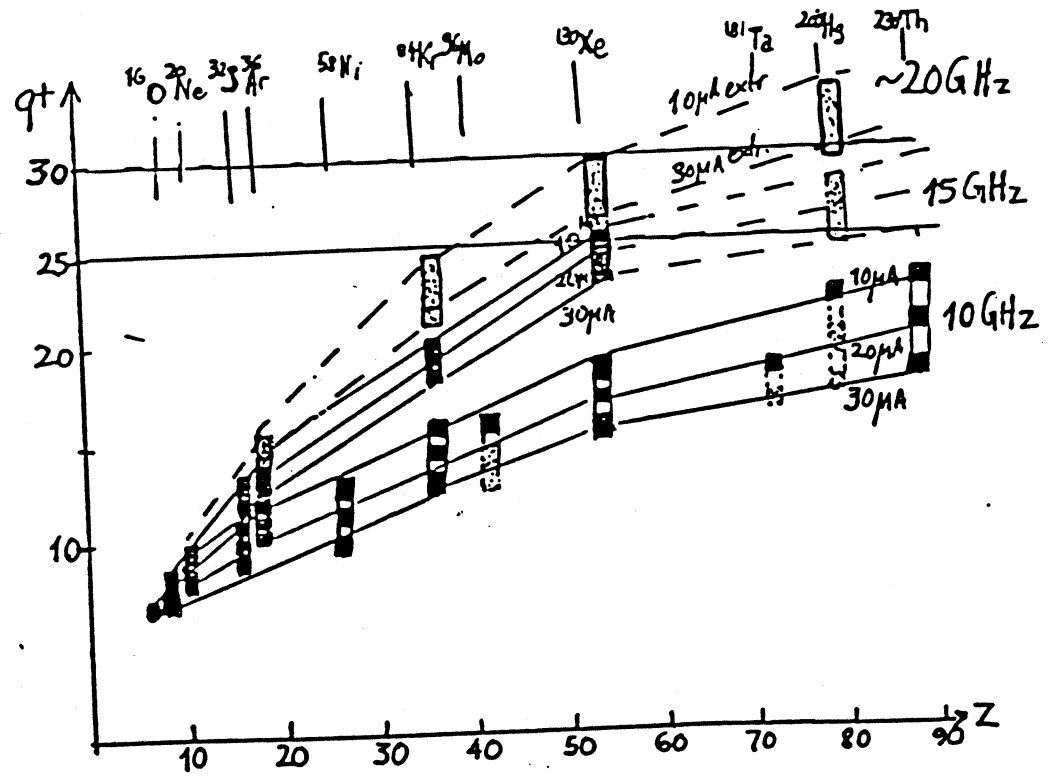

Fig. 2B

Tentative ECRIS Scaling - (Reasonable)

PIG:  $P = 10^{-4}$  Torr  
 $j_c = 100 \text{ A/cm}^2$   
 $\tau = \mu\text{s}$   
 $E_c = .5 - 2 \text{ keV}$

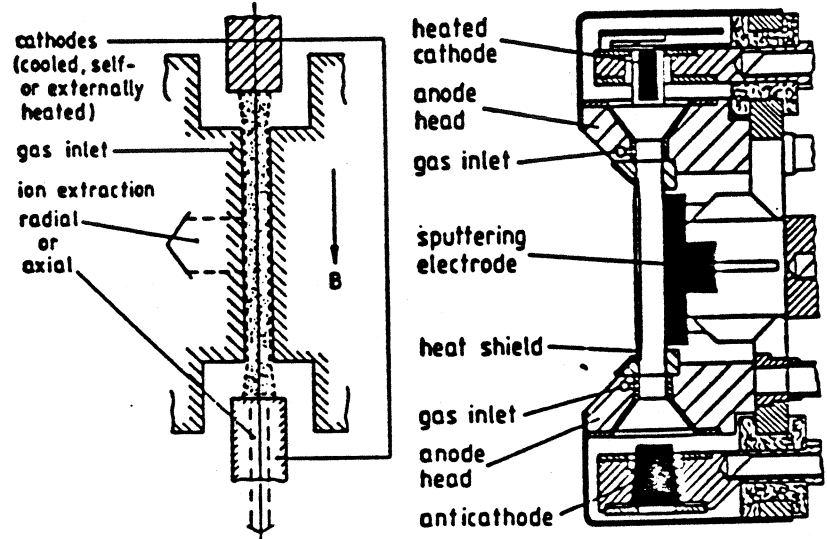

Fig. 3A

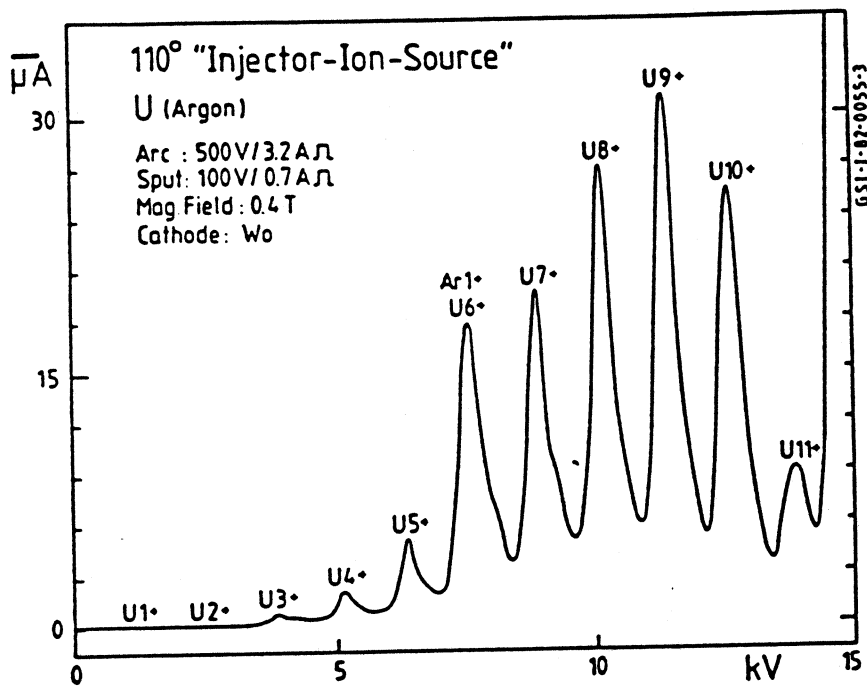

Fig. 3B

Ion	Arc V/A	Sput Volt. V/A	Extract Volt. kV	el. Current μA c.w.	Anode Slit mm <sup>2</sup>	Emitance mm mrad radial
U 10 <sup>+</sup>	450/5	300/ 8	12.5	100	40 x .8	286
Pb 9 <sup>+</sup>	800/5	200/ 6	10.2	130	40 x .8	313
Au 6 <sup>+</sup>	600/5	400/ 8	15	1500	45 x 2.0	
Xe 6 <sup>+</sup>	950/5	..	24	1500	45 x .5	
Xe 7 <sup>+</sup>	500/8.8	..	23.8	1050	45 x .5	
Ni 4 <sup>+</sup>	250/7	1000/ 8	13.2	140	40 x .8	
Fe 4 <sup>+</sup>	850/5	800/1.6	13.4	400	45 x .8	
Ca 3 <sup>+</sup>	950/5	400/ .3	14.9	1000	45 x 1	266
Ar 3 <sup>+</sup>	400/8.3	..	13.1	4000	45 x 2	1100

Fig. 3C

Most recent results from  
PIG - source  
UNILAC - Injector

Uranium (low rep. rate)

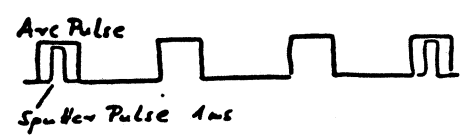

Charge State	Peak Current [μA]
8 <sup>+</sup>	1
9 <sup>+</sup>	1
10 <sup>+</sup>	1.4
11 <sup>+</sup>	.6

after injector mag  
 $E \sim 100 \text{ KeV}$

Fig. 3D

Fig. 4

LBL - MEVVA - Ion Source

USER 12.19 DATE: MONDAY, 6 OCT 86 TIME: 10:30:03

Metal  
Vapor  
Vacuum  
Arc

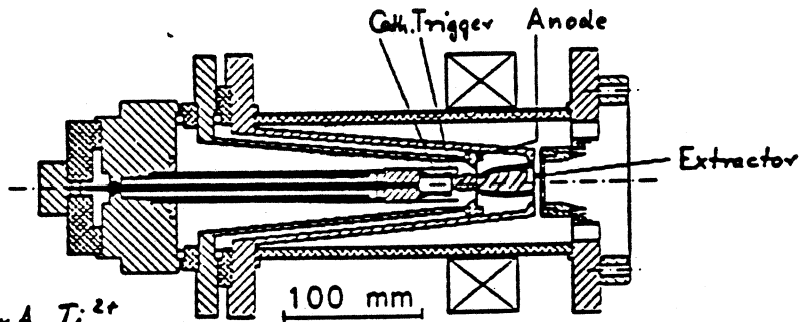

77 mA Ti<sup>2+</sup>

29 mA U<sup>4+</sup>  
(200 mA, 38 kV)

.1 to 1 ms

7-hole extr.

GNDN PICTURE 00000 FROM USP MEVVA

Fig. 4A

Fig. 4B

MEVVA Results

Ions from e.g. Al, Ti, Nb, La, Ta, Pb, U

Experiments at GSI

Test bench transport: 4.5 m, 90°-magnet

1+ 2+ 3+ 4+ 5+

Ti: 18 30 12 8 mA (78/200)

U 1.5 5.5 11 1 mA (19/120)

extr. voltage: 38 kV

norm. emittance: 0.15...0.3  $\pi$  mm mrad

+ : broad spectrum of  
metal ions  
multiply charged  
ions

- : pulse-to-pulse  
reproducibility  
noise of beam pulse  
missing pulses  
no gases



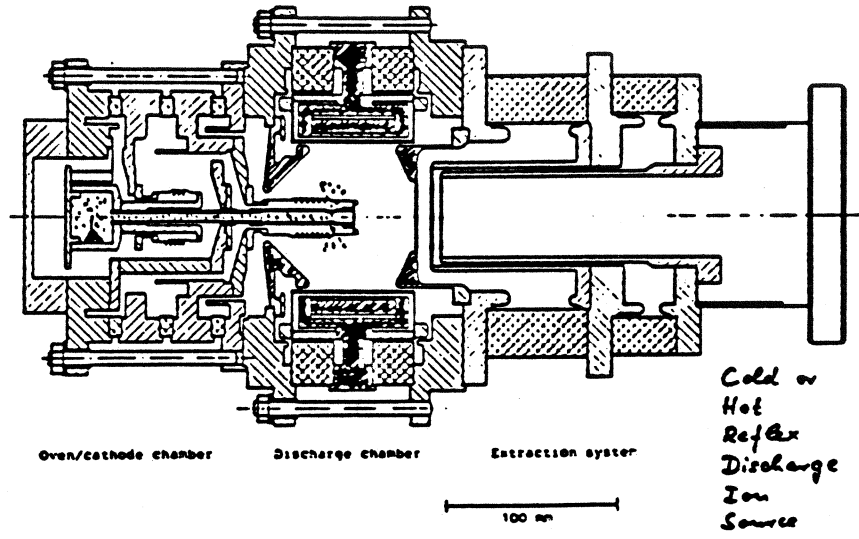

Fig. 5A

CHORDIS With respect to CORDIS, 1, the oven (left) is added; the vapour is guided through the cathode pipe into the discharge chamber. An inner, hot shell on anode potential surrounds the plasma; all supporting tubes or flanges are thinned out to reduce their heat conductance. For working temperatures over about 800 °C, thin tantalum heat shields, not shown on this figure, are mounted around the oven and its heating filaments, usually eight tungsten wires, each 0.8 mm thick.

Table 1: Beam Parameters for Some Elements from the CHORDIS-Source

Element	I (mA)	$\epsilon$ (mm mrad)	$U_{ex}$ (kV)	Extract. Area (cm <sup>2</sup> )
Li	41	255	30	1.4
Ar	120	220	50	2
I	28	150	31	1.4
Xe	71	67	50	2
Bi	37	265	36	2

Fig. 5B

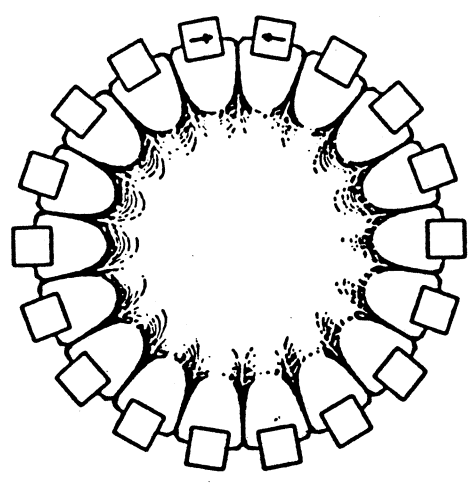

Fig. 5C

Multipole of GSI source

Computer plot of the magnetic field pattern inside the source. The magnets are tangentially oriented, in alternating directions.

No loss lines on magnet surface  
(Halbaad, LBL)

Fig. 6

Fig. 6A

CHORDIS Results

Conservative interpolation for routine operation

Test bench transport: 4.5 m, 90°-magnet

	Ar	Kr	Xe	I	Bi	[U]
1+	46	32	26	21	16	4 mA
2+	23	16	13	10	7	2 mA

extr. voltage: 30 kV

norm. emittance:  $< .1 \pi$  mm mrad

With special discharge conditions:

	1+	2+	3+	4+	5+
Kr	15.8	9.9	3.4	0.44	0.16 mA
Xe	11.6	10.2	5.6	2.2	0.8 mA

$U_A: 375$  V,  $I_A: 57$  A

7 holes:  $2.7$  cm<sup>2</sup> extr. area

+ : quiet plasma and beam  
high brightness

- : high vapour pressure material  
Low currents with sputtering

Fig. 6B

Ion Sources vs. Stripping

Type	Charge States	Current	Equivalent Stripping Energy
High Current	Low	1...160 mA	10 keV/u
PIG	medium	.1...5 mA	100 keV/u
ECR	high	.01...5 mA	1 MeV/u
EBIS	very high	.1...1 $\mu$ A (x pulse rate)	10 MeV/u

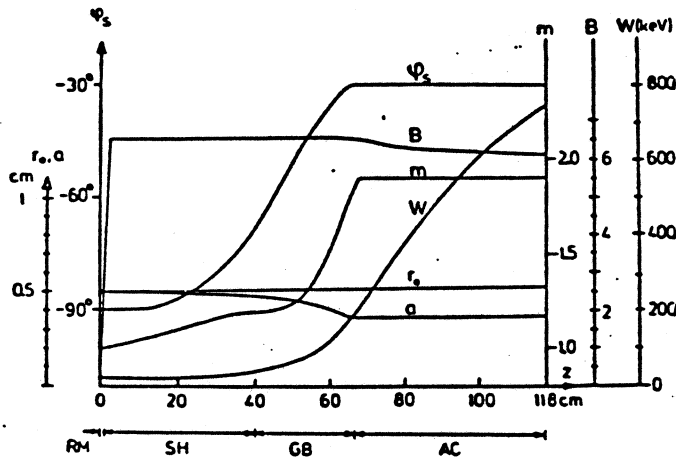
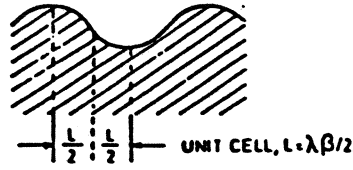
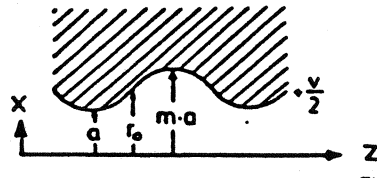
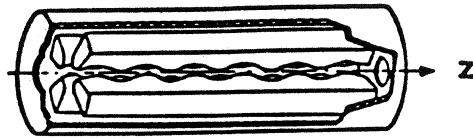

Fig. 7A  
4-vane  
RFQ

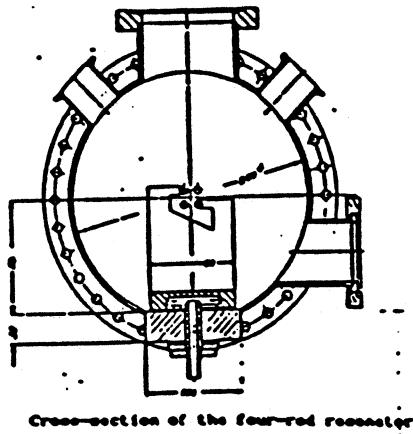
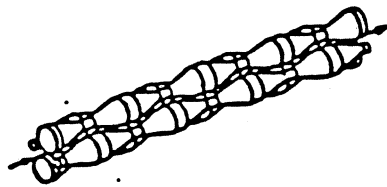
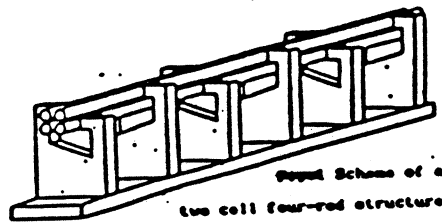
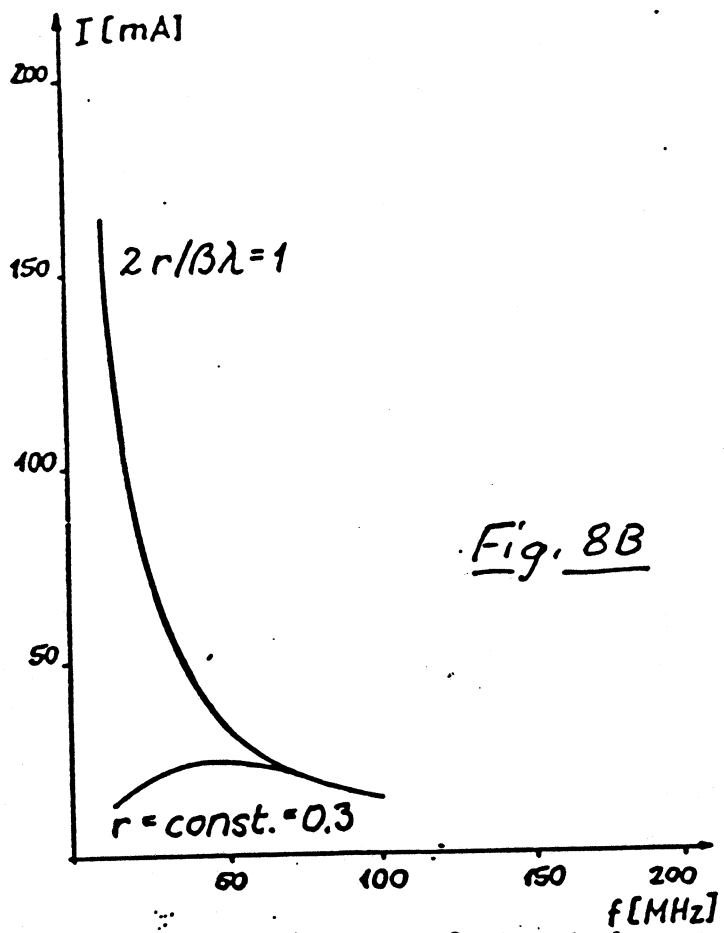
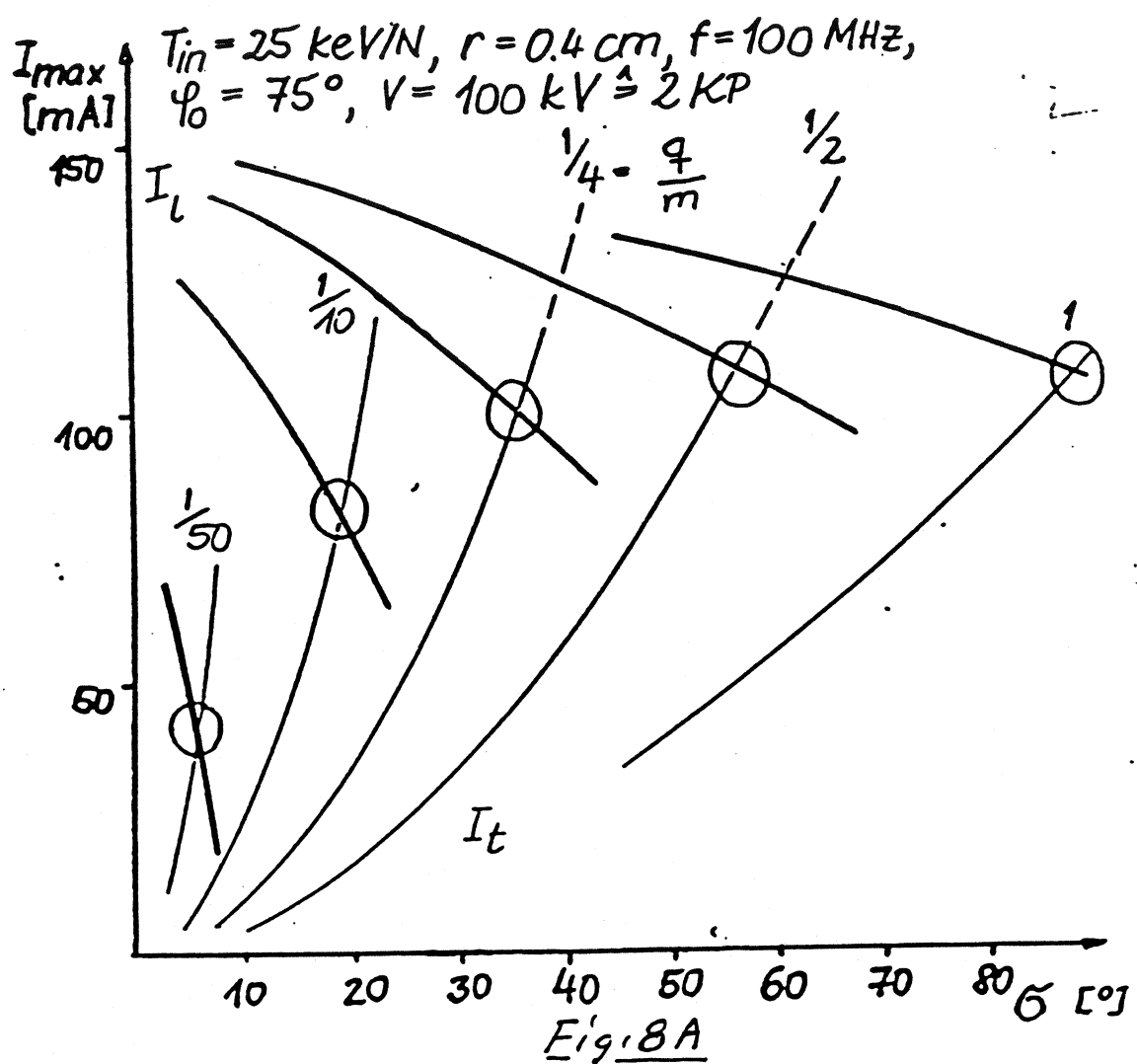

Fig. 7B  
4-rod  
RFQ

Cross-section of the four-rod resonator

Fig. 8



$T_i = 6.25 \text{ keV/N}$ ;  $\varphi_i = 75^\circ$ ,  $\varphi_s = 30^\circ$   
 $U_{max} \hat{=} 2 \text{ KP}$ ,  $N = 100$

# HERA RFQ's

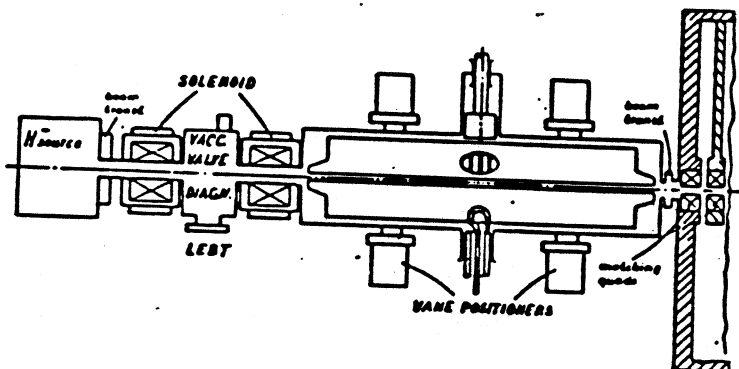

Input energy $W_{in}$	18	keV
Output energy $W_{out}$	750	keV
Radio frequency $f$	202.56	MHz
Beam current $I$	20	mA
Current limit $I_{max}$	60	mA
Transmission efficiency $\eta$	96	%
Total length $L_{tot}$	117.7	cm
Total cell number $N_c$	135	
Intervane voltage $V$	70.5	kV
Maximum electric field $E_{max}$	21.9	MV/m
Vane modulation $m$	1 to 1.88	
Minimum aperture radius $a$	3.5	mm
Average radius $r_a$	5.0 - 5.2	mm
Radial focusing strength $B$	0.4 - 6.5 - 6.14	
Synchronous Phase Angle $\phi_s$	90 - 30	degree
Normalized input emittance (90%) $\epsilon_{ni}$	0.7	$\mu\text{m rad}$
Ellipse parameters, input (> 90%)		
$a_x = a_y$	0.57	
$b_x = b_y$	20.58	mm
Normalized output emittance (90%) $\epsilon_{no}$	1.0	$\mu\text{m rad}$
Ellipse parameters, output (90%)		
$a_x$	2.41	
$a_y$	157	mm
$b_x$	-1.46	
$b_y$	-120	mm
Envelope in x (90%) $x_{max}$	2.1	mm
Envelope in y (90%) $y_{max}$	1.8	mm
Energy spread (90%) $\Delta W_{max}$	10.4	keV
Phase spread (90%) $\Delta\phi_{max}$	22.8	degree

4 ROD

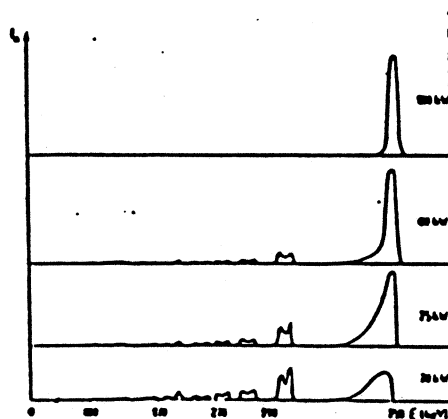

Energy spectra for different rf powers

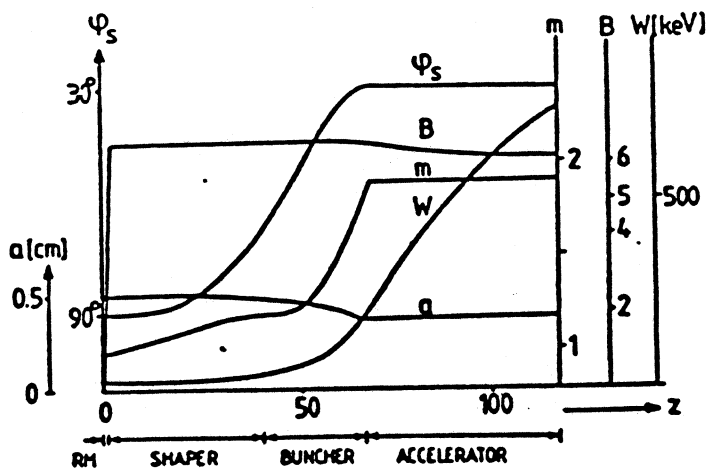

4 VANE

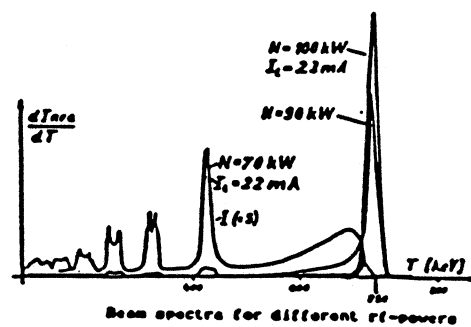

Beam spectra for different rf-powers

Fig. 10

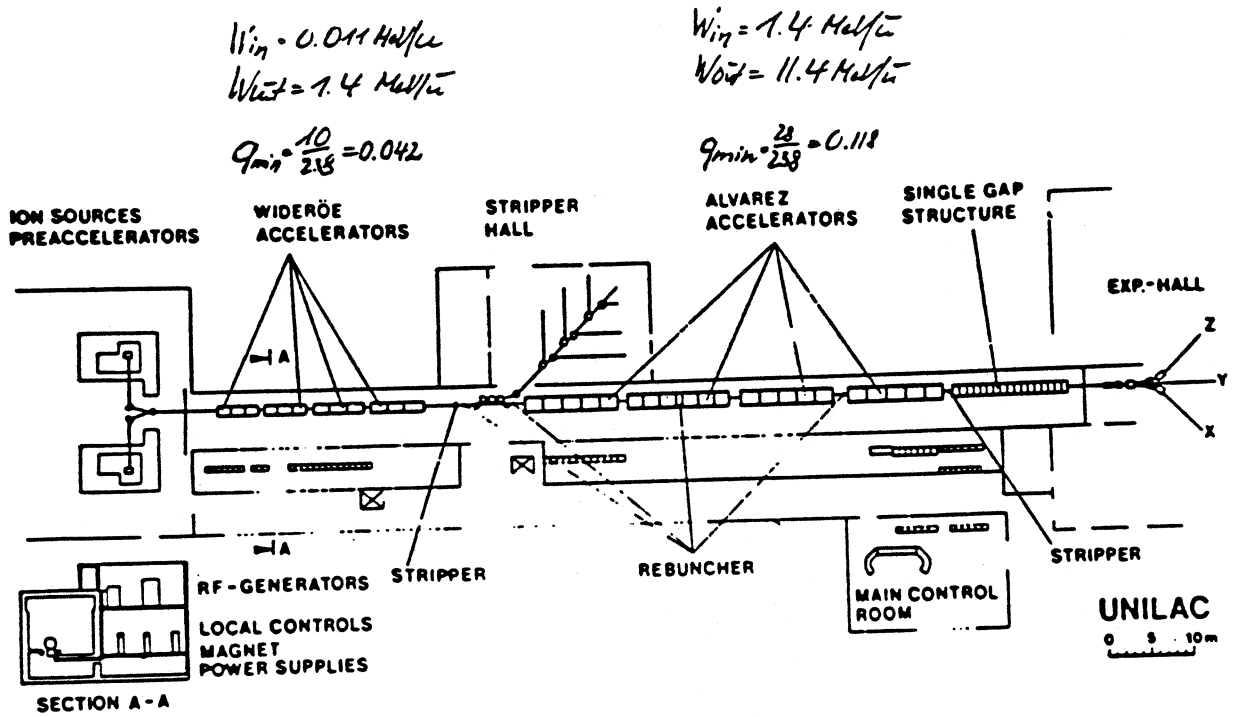

Fig. 10A UNILAC before modifications.

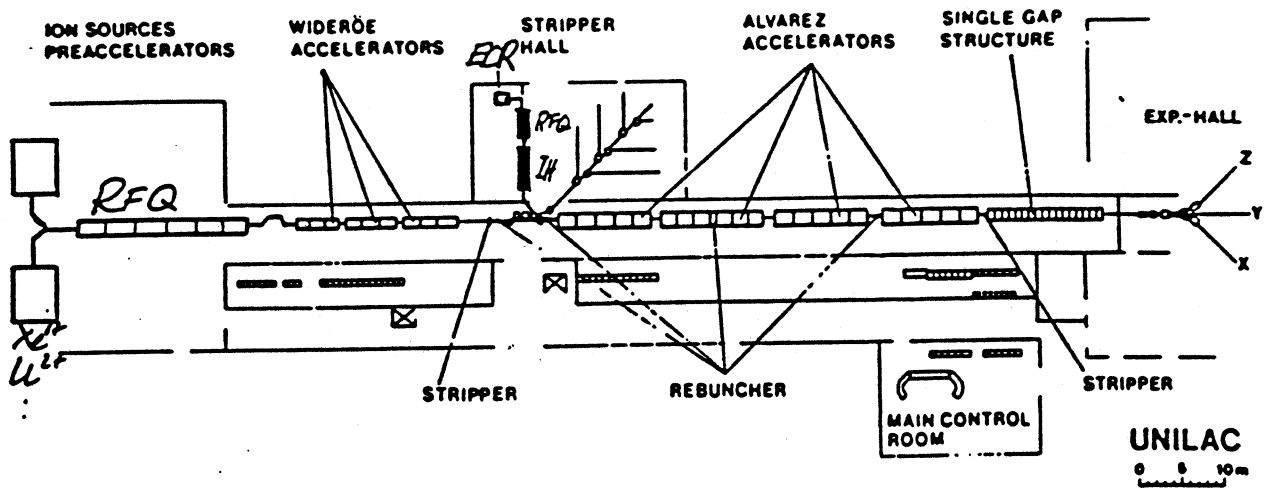

Fig. 10 B, UNILAC after modifications.

CERN Replacement Linac		28 Si 0.2 → 2.5 MeV		1500-18	
Scenario	Length m	# of Cells	Power MW	Length m	# of Cells
Scenario 4+	16.06	117	0.974	16.06	117
	10.30	75	1.524	10.30	75
Scenario 2, 4+	11.1 (5.8 + 5.3)	119 (59 + 60)	1.175 (0.387 + 0.788)	11.1 (5.8 + 5.3)	119 (59 + 60)
	12.7 (5.8 + 6.9)	137 (59 + 78)	0.925 (0.387 + 0.538)	12.7 (5.8 + 6.9)	137 (59 + 78)
	7.38	79	1.794	7.38	79
	8.34 (3.74 + 4.60)	90 (38 + 52)	1.417 (0.610 + 0.807)	8.34 (3.74 + 4.60)	90 (38 + 52)

Scenario 4+	2β1: 16.06 m	1.0K
	2β1: 10.30 m	1.5K
Scenario 2, 4+	1.0 MV/m	0° face angle
	β1: 5.3 m	1.0K
	β1: 6.9 m	E <sub>0</sub> =
	E <sub>0</sub> = 5.8 MV/m	
	E <sub>0</sub> = 2.7 MV/m	
	β1: 3.64 m	0° face angle
	β1: 4.60 m	5°
	E <sub>0</sub> = 2.5 MV/m	
	E <sub>0</sub> = 4.0 MV/m	

$f = 202 \text{ MHz} :$

ECR	RFQ	IH - Acc.	Alvarez	Focusing! IH
	0.2 MeV/c	-2.0 MeV/c	8 MeV/c	
ECR	RFQ	IH - Acc.	...	Focusing! IH
	0.2 MeV/c		8 MeV/c	

$f = 108 \text{ MHz} :$

ECR	RFQ	$2\beta\lambda$ - Rev.	$\beta\lambda$ - Rev.
	-0.2	-1-2 MeV/c	-8.0 MeV/c
		15.0 cm ( $E_0 = 1.15 \text{ MV/m}$ )	25 cm ( $E_0 = 2.3 \text{ MV/m}$ )

High Current:

Ion Source	RFQ	IH/ Wideroe	Alvarez ( $\beta\lambda$ )
		27 MHz	$f = 108 \text{ MHz}$

Source	RFQ	$2\beta\lambda$ - Alvarez	$\beta\lambda$ - Alvarez
$q_{min} = \frac{30}{200} = \frac{1}{7}$	-----	-----	-----
$W(\text{MeV/c})$	0.2	0.2 - 1.0	1.0 - 2.5 - 8.0

I L ~ 3 cm

	5.8 (1.4p)	5.3	19.5 (Σ 25 cm $\gamma$ Rev. $\beta$ )
	3.7 (1.54p)	3.6	13.2 (Σ 17 cm $\gamma$ Rev. $\beta$ )

II W: ~ 0.006 - 0.2

	RFQ	$2\beta\lambda$ - Alvarez	$\beta\lambda$ - Alvarez
	~ 3 cm	0.2 - 2.0	2.0
		12.5 (1.4p)	21 cm
		8.1 (1.54p)	14 cm

8.0 MeV/c



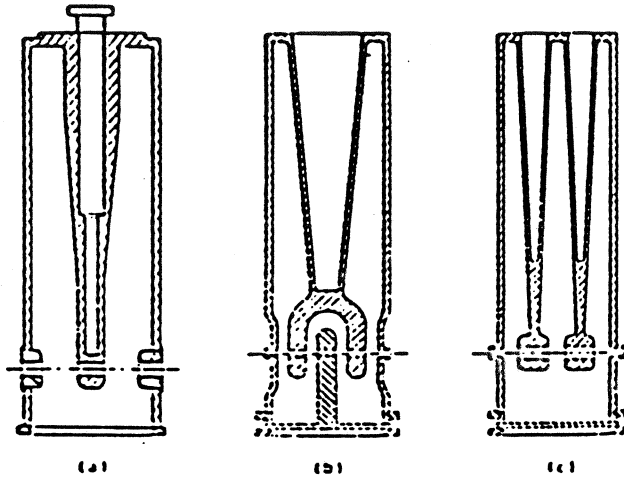

Fig. 1 Three different types of low  $\beta$  structures: (a) quarter wave; (b) 4-gap interdigital; (c) half-wave (not to scale).

Fig. 13A

drift tubes supported by  $2/3$  lines.

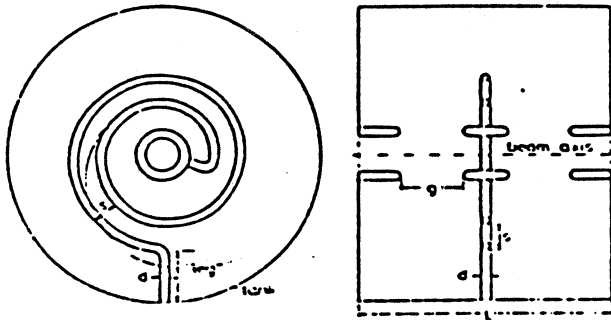

Fig. 1 Schematic drawing of a spiral resonator. Tank length  $L$ , pitch  $s$ , gap width  $e$ , tubing diameter  $d$

Fig. 13B

Spiral loaded cavity.

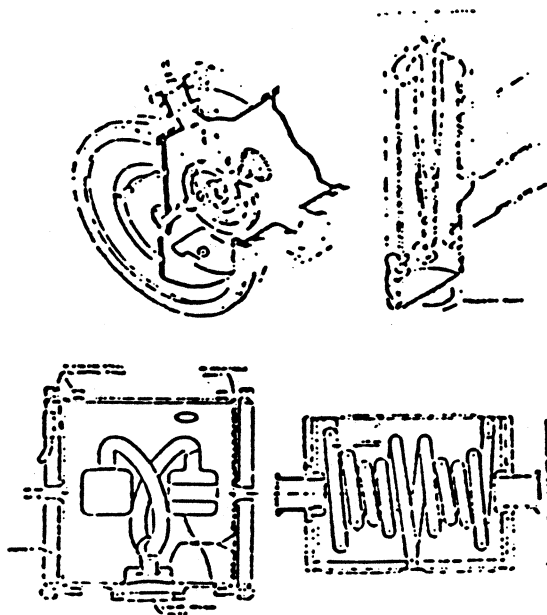
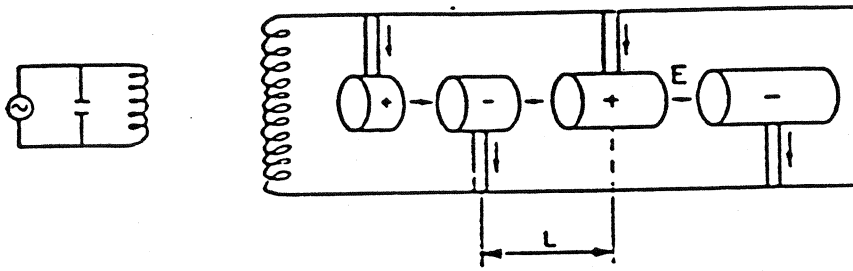

Fig. 3. Resonators frequently used in postaccelerators. a: spiral<sup>1</sup>, b: quarter wave<sup>2</sup>, c: splitring<sup>10</sup> and d: helix resonators<sup>11</sup>.

Fig. 13C

Split ring cavity and helix.

Fig. 14



*Fig. 14 A*  
Principle of a Widerøe accelerator.

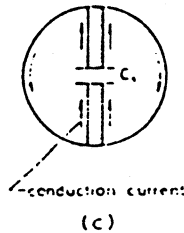
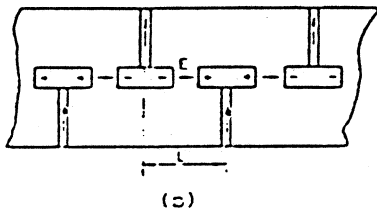
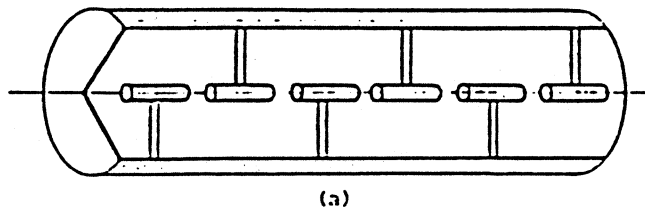

*Fig. 14 B*  
Interdigital line.

Fig. 46. Interdigital line.

Energy range 0.5-10 MeV  
Average effective shunt impedance at 60 MHz 50 MΩ/m  
(a) Cut-away view.  
(b) Periodic field pattern of the stem  $\pi$  mode  
(c) Idealized cross-section in  $\pi$  mode.

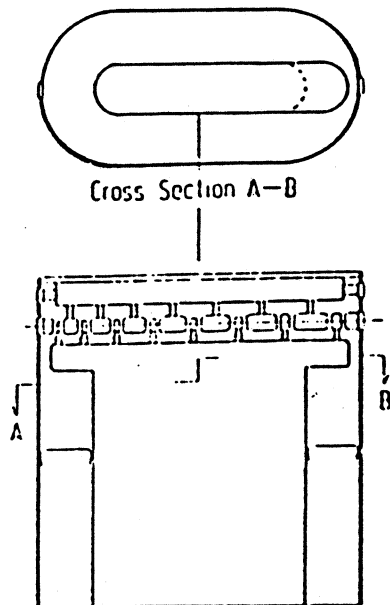

Concept of a quarter wave coaxial resonator having a race track-type cross section with drift tubes loaded at its open end.

*Fig. 14 C*  
Interdigital line with variable frequency (RILAC).

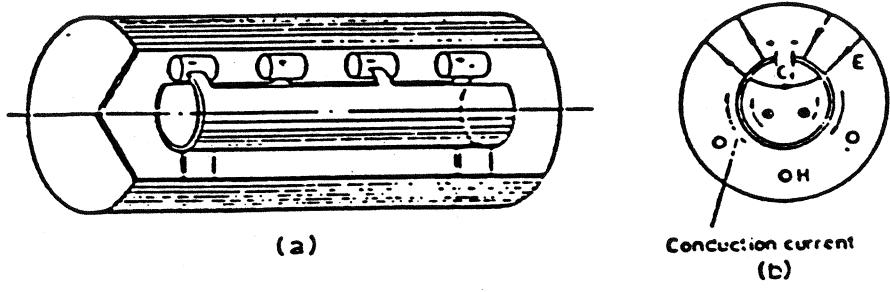

Fig. 15A  
The H-type structure.

Fig. 47. The H-type structure (Teplyakov et al. (1967)).  
Energy range 0.5-50 MeV  
Effective shunt impedance at 150 MHz 600-7 MΩ/m  
(a) Cut-away view (not to scale).  
(b) Idealized cross-section in  $2\pi$  mode.

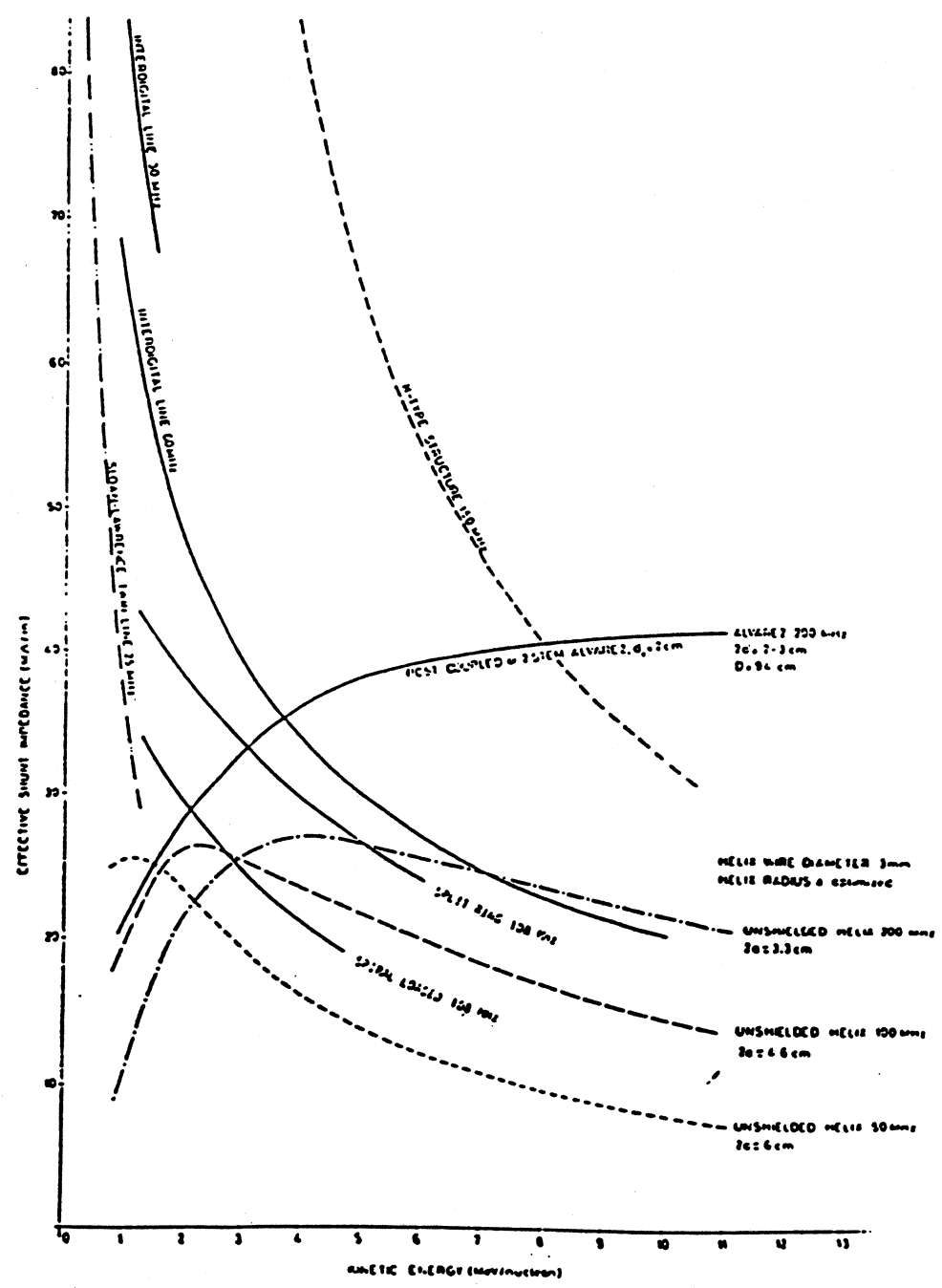
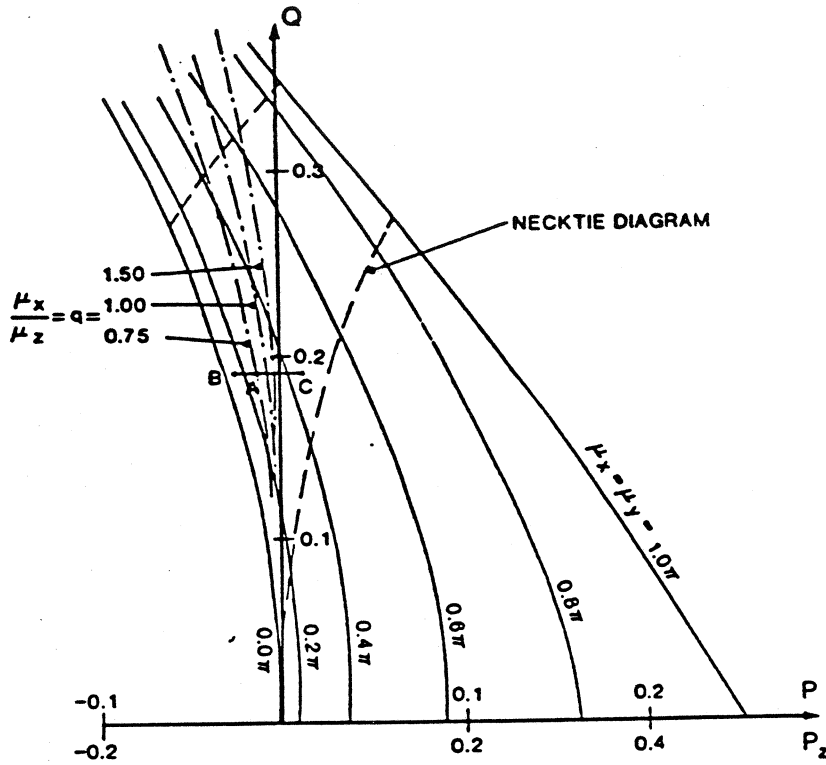

Fig. 15B

Comparison of structures for shunt impedance.

Fig. 16



Linac stability diagram.

Fig. 16A

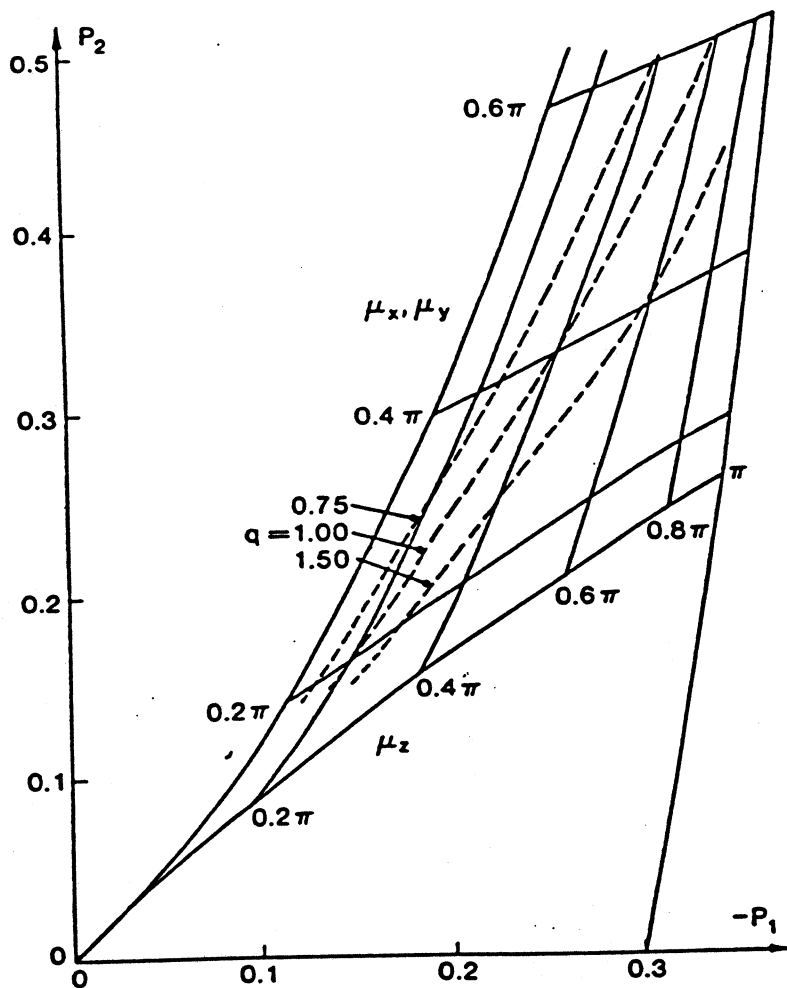

Stability diagram for APF focusing.

Fig. 16B

Fig. 17

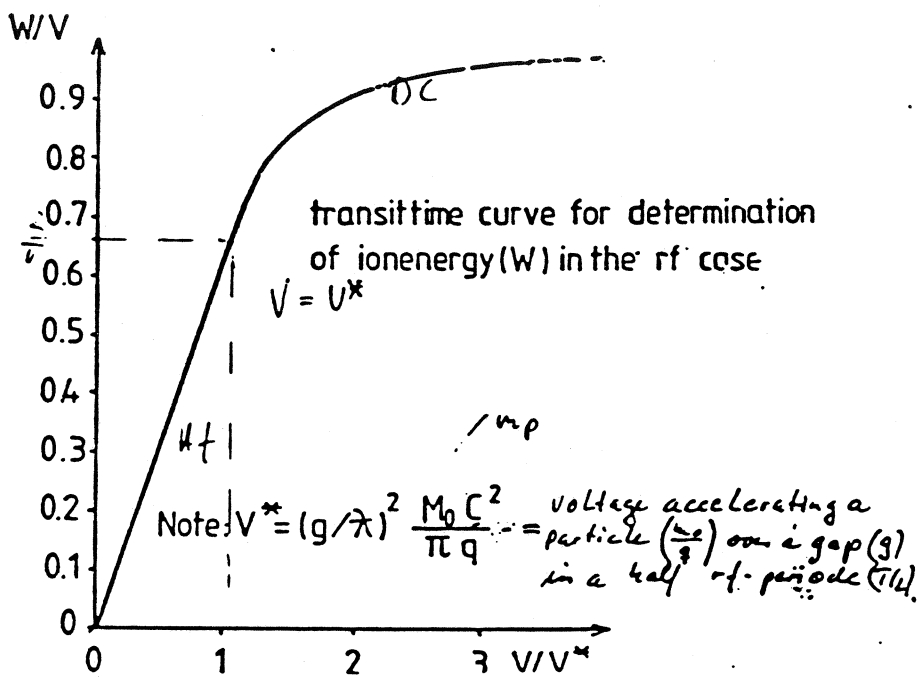

Fig. 17A

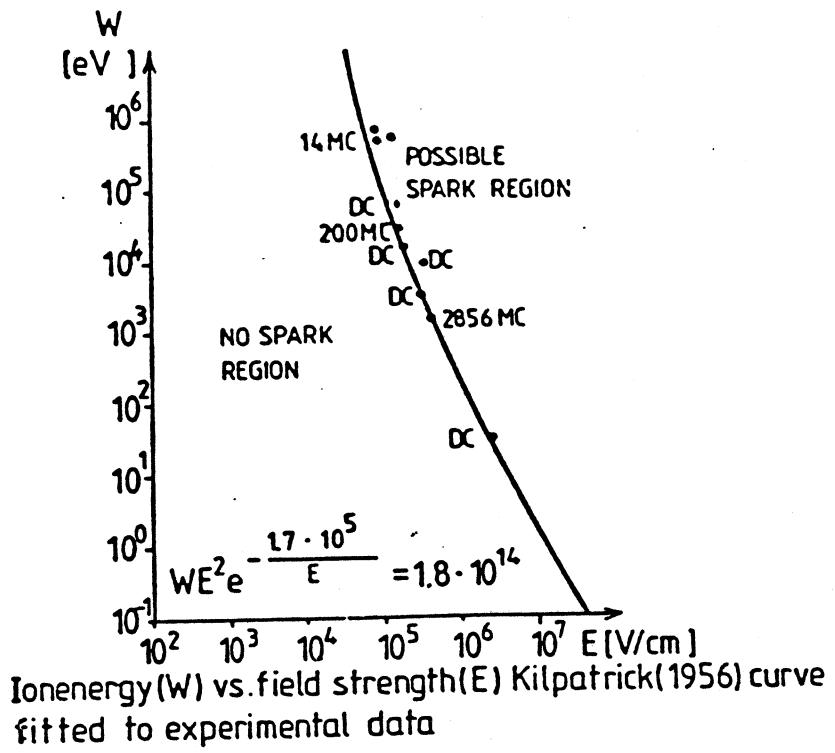

Fig. 17B

Fig. 18

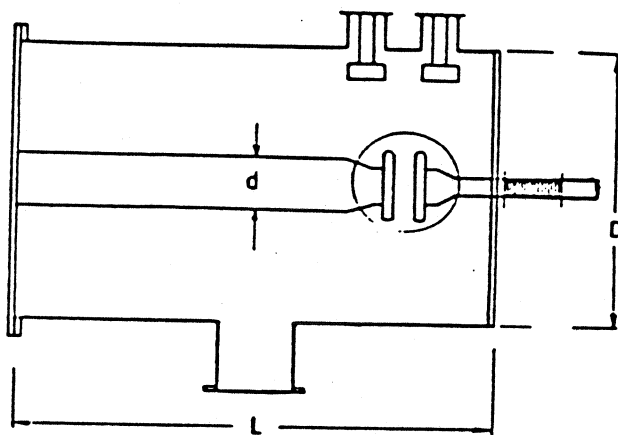
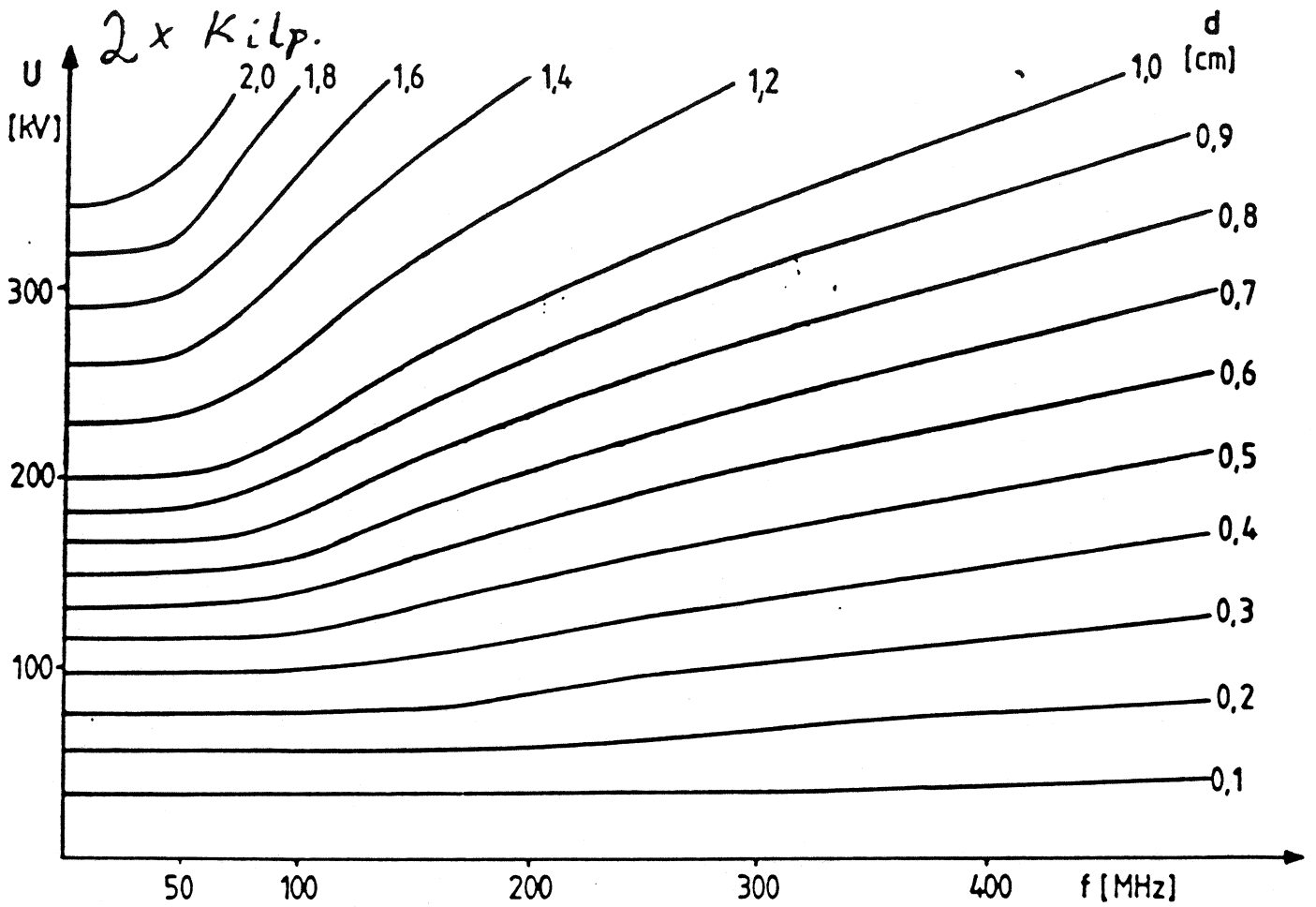

Fig. 18B

electrode material OFHC - Copper  
disc diameter = 40 mm  
edge curvature radius 2,5 mm

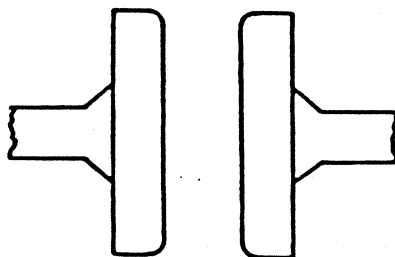

Fig. 19

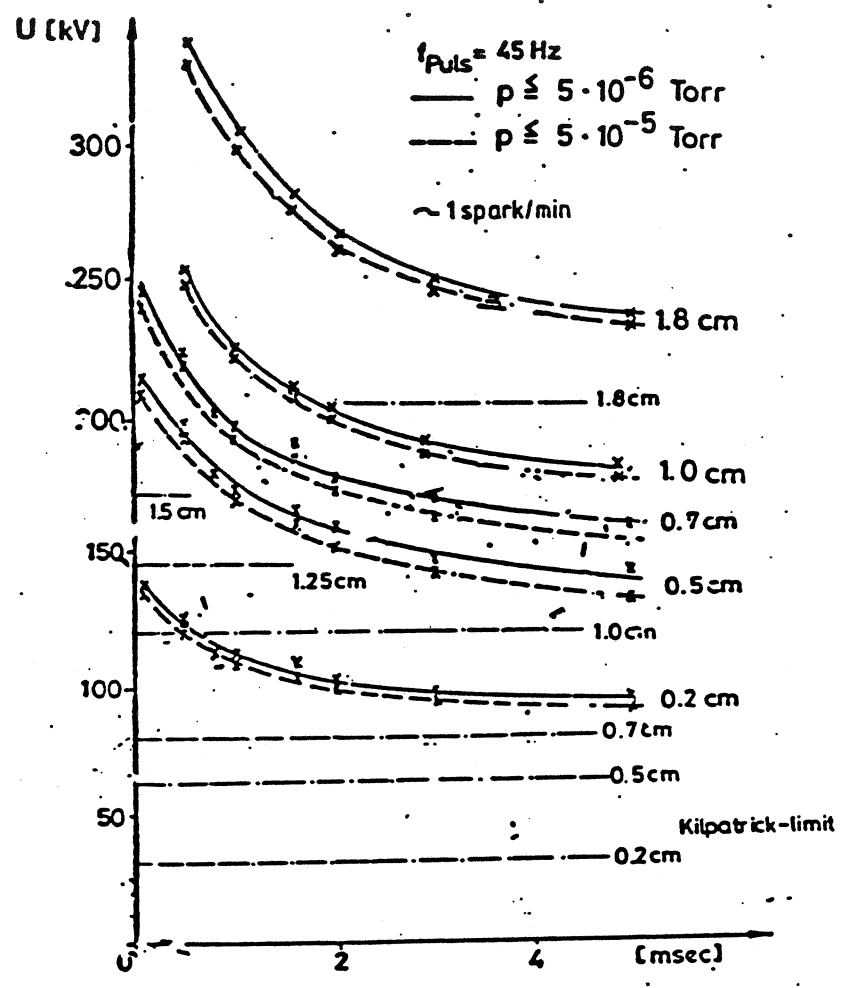

Fig. 19A

BREAKDOWN VOLTAGE VS. PULSE LENGTH FOR PLANE ELECTRODES  
(DISKS; 7 CM Ø)  
- - - - KILPATRICK THRESHOLD

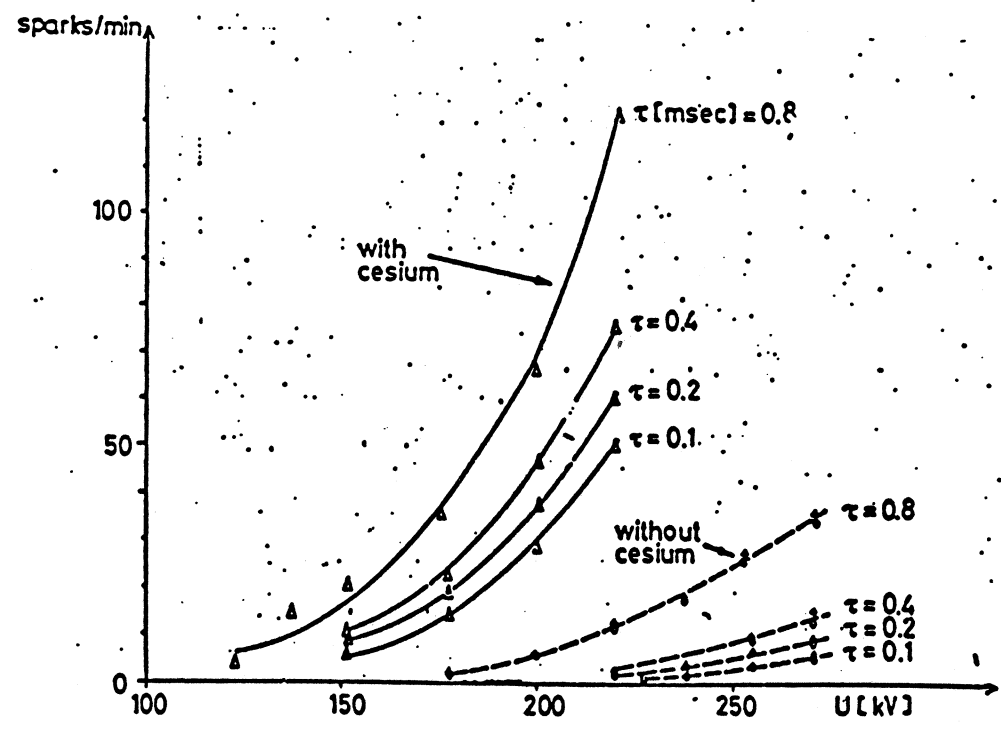
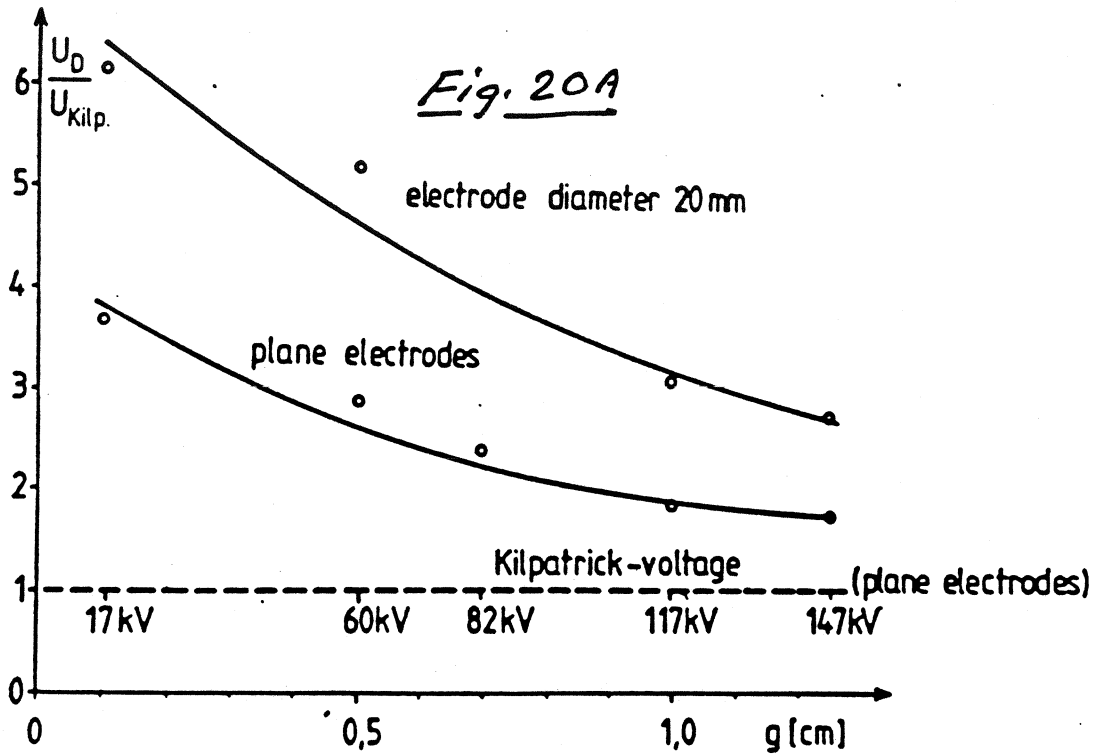

Fig. 19B

Duty cycle: const = 0.5%, repetition frequencies: 6-45 Hz  
 $f = 108 \text{ MHz}$ , gap width = 0.7 cm,  $p = 10^{-5} \text{ Torr}$ , Kilpatrick limit: 83 kV  
 cathode  $1 \text{ mm } \phi$  or less,

Fig. 20



Ratio of breakdown voltage to Kilpatrick voltage vs. gap length  
 $f_{rf} = 108,5 \text{ MHz}$ ,  $f_{repet.} = 45 \text{ Hz}$ , pulse length = 1msec

experimental results  $U \sim g^n$   $0,47 \leq n \leq 0,5$

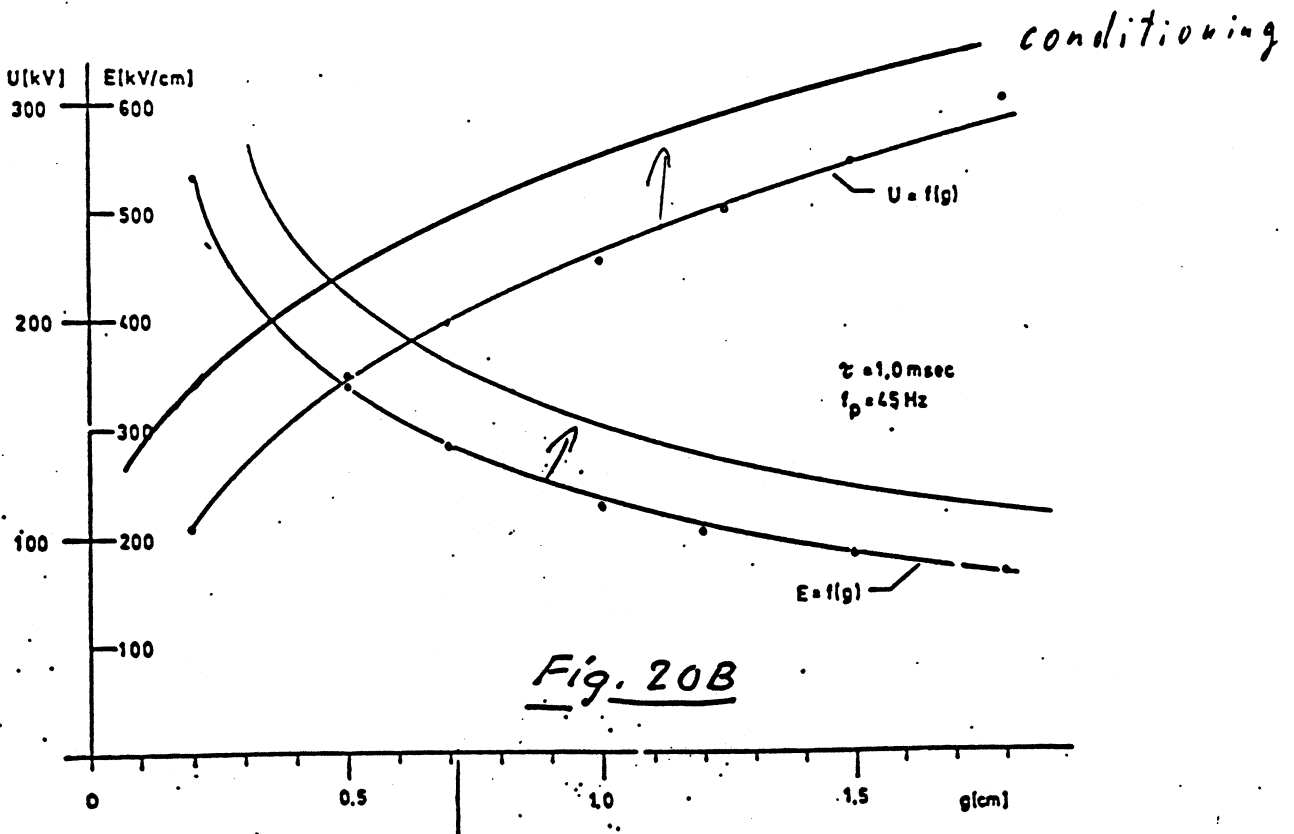



TYPE = -1 MCA # 1 SEGMENT # 1  
 REALTIME = 300.00 SECONDS, LIVETIME = 11.52 SECONDS  
 DATA COLLECTED AT 12:16:00 ON 11-MAY-87

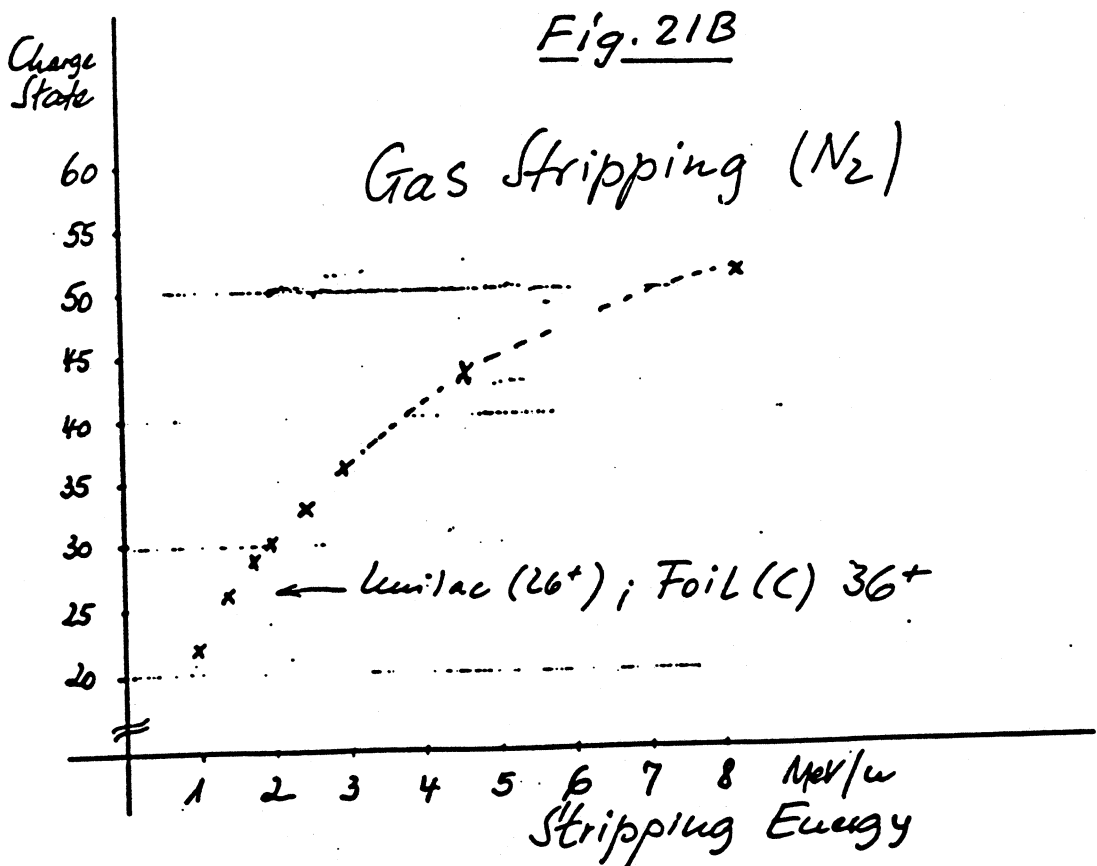
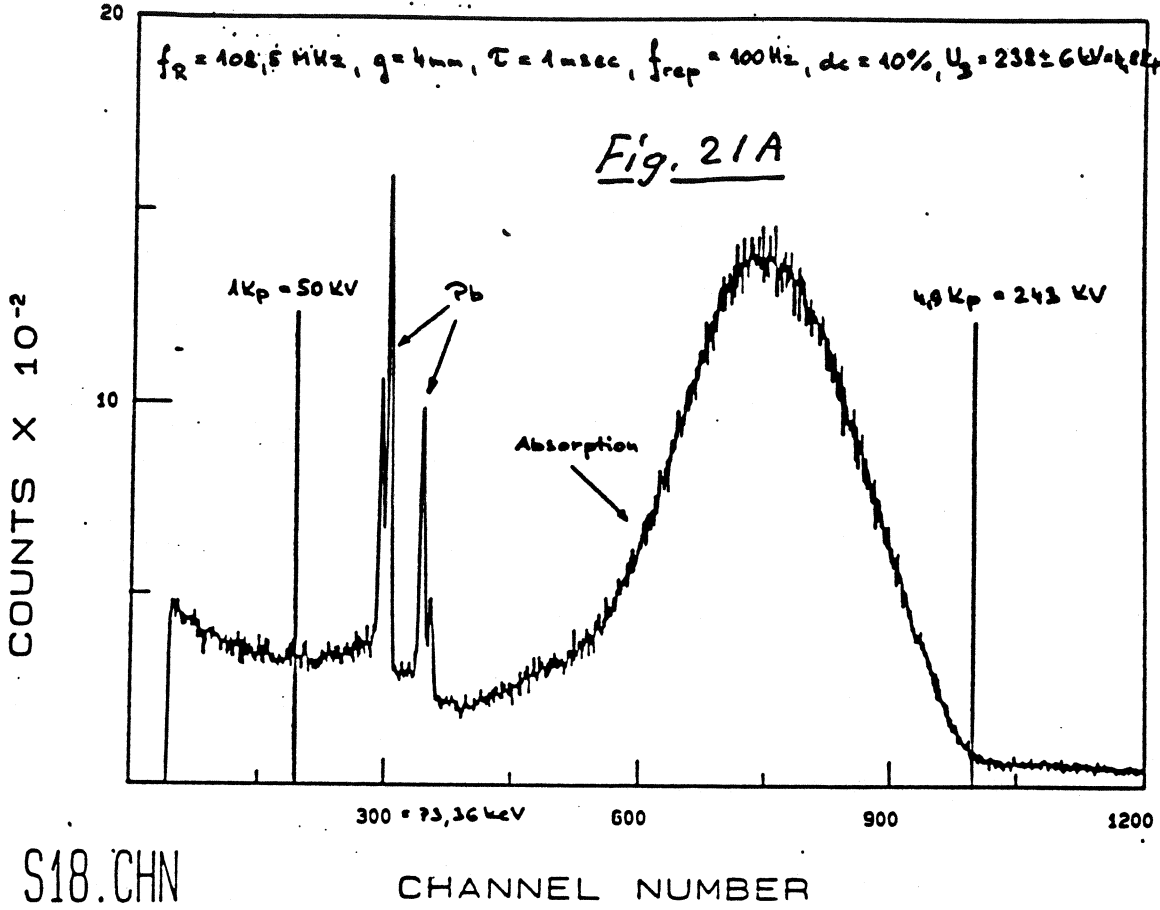

Fig. 22

INS-Tokyo  
TALL RFQ

Fig. 22A

See also LINAC 86 - Palo Alto

INPUT ENERGY	8 KEV/A for $q/A = 1/4$
OUTPUT ENERGY	800 KEV/A
FREQUENCY	100 MHz ( $\lambda = 3m$ )
LENGTH	7.25m (vanes in 4 sections* of 1.81m each)
D.F	2ms/12ms
COUPLING RINGS	NO
COUPLING LOOP	1 (no manifold)
WORKING PT	$B = 3.8 \quad \Delta = -.075$
POWER	226 KW *
PLATING	Cavity Copper Pl. (100 $\mu$ ) Alum vanes then 10.000 Copper (coiled)
TUNING	$\phi$ 100mm side tuners 1 movable S.T/Q } per tank 3 adjust. ST/Q }  $\phi$ 25mm Capacitive end tuners (vane thick. 20mm)
PUMPING	2 Turbo-pumps 500 L/s ( $P \approx 5 \cdot 10^{-7}$ )

\* beam tests carried out with Alum. vanes with p only  
- power available limited by present transmitter

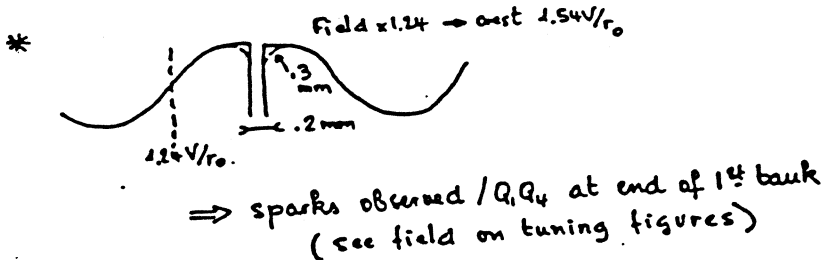

TALL RFQ: Parameters  
Fig. 22 B

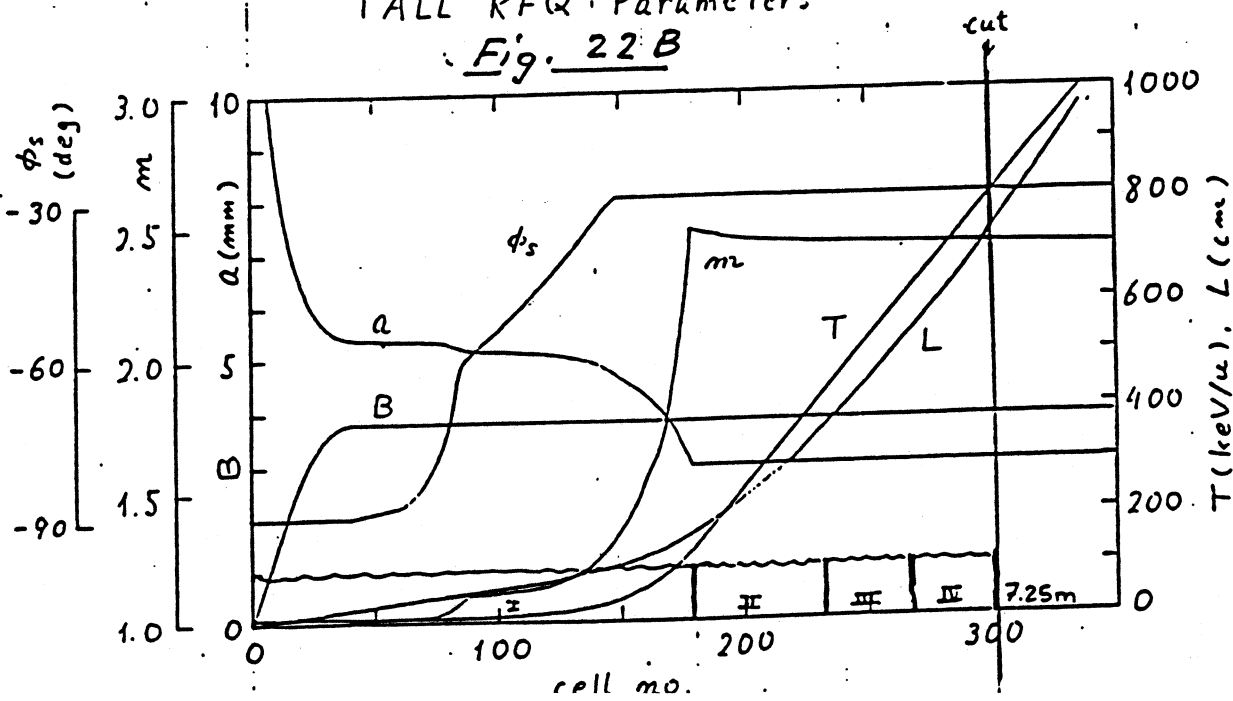

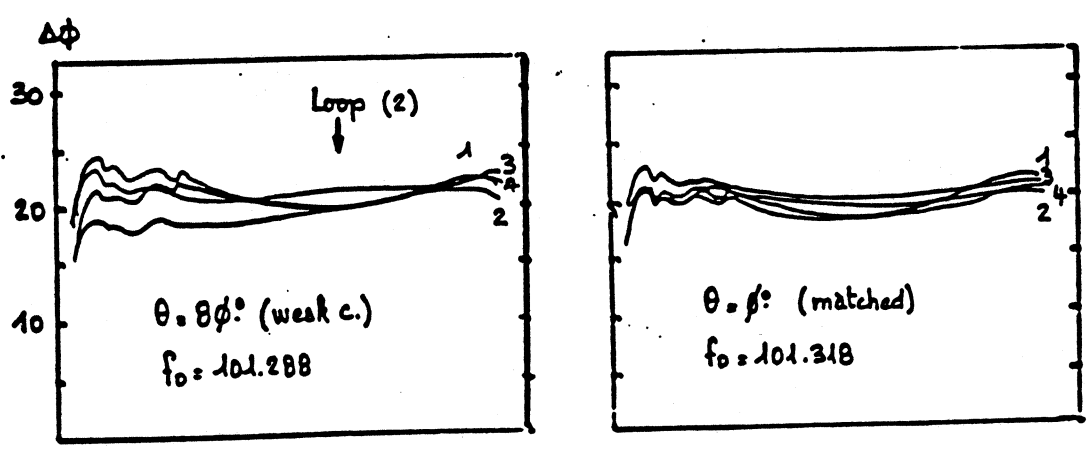
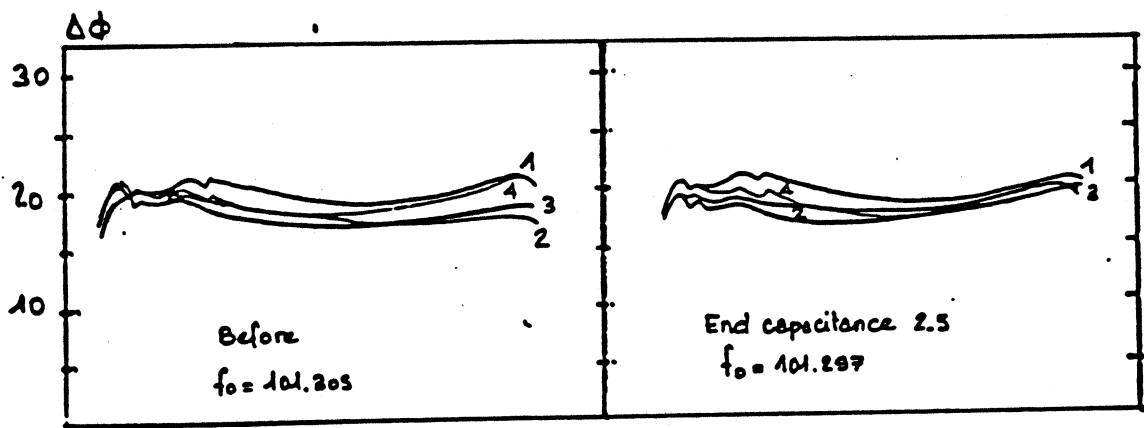
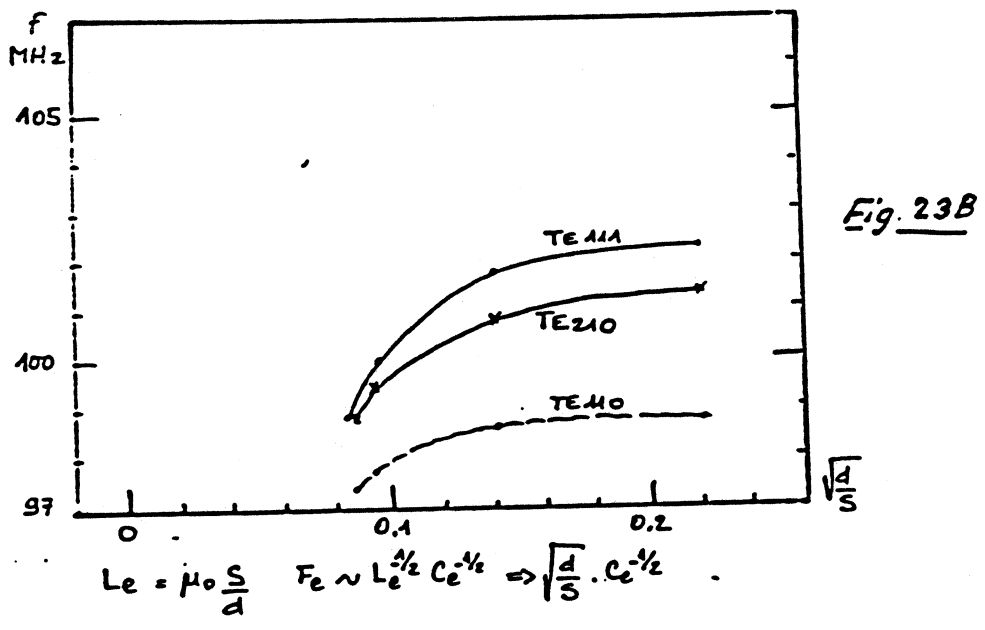
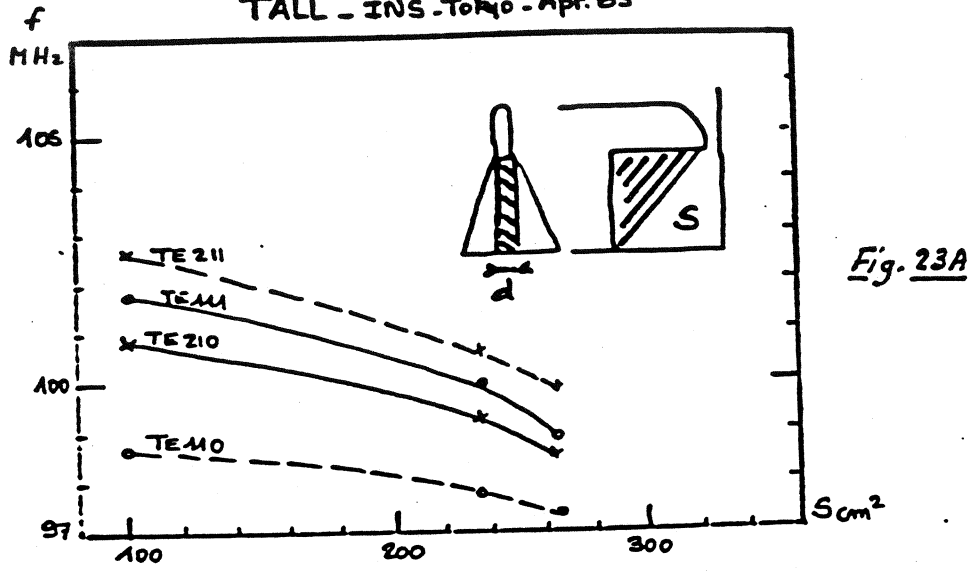



(ind) Future LINAC evolution (VAC SYSTEMS)

	AGE	LENGTH	ANODE	CHARGE PRESSURE
LINAC 1	30 yrs	30m	TUNNS ~9000 l/s	$\approx 2 \cdot 10^{-6}$ Torr
LINAC 2	10	60	ION PUMPS ~1'600 l/s	$\approx 2 \cdot 10^{-3}$
LINAC 3? Pb <sup>208</sup>	-	30	CRYOPUMPS? ~20'000 l/s	$\approx 10^{-8}$ ?

FIGURE OF MERIT (Linac 23 & Linac 1)

$$\eta_{11} = \frac{\text{GAS LOAD}}{\text{NO. OF RF UNIT}} = \frac{P_{in} - S}{L}$$

LINAC 2 = 15  
LINAC 3 = 45 ?

Fig. 25A

IMPROVEMENT OF A FACTOR OF 3 FOR  $\eta_{11}$   
SHOULD BE POSSIBLE WITH IMPROVED  
TECHNOLOGY (Linac 2 is plagued by virtual  
leaks from TUNNS / COPPER PLATING)

CAPITAL COST (MM SF) LINAC 1: ~600 MF  
(NOT INCLUDING TUNNS) LINAC 2: ~1'600 MF  
LINAC 3: ?

MUCH CAN BE RECOVERED FROM LINAC 1  
(TURBOS, CONTROL RACKS etc...)

LINAC 3:

- # ONLY ONE 1'500 l/s TURBO PER TANK (enough to start up cryopump at  $10^{-4}$  Torr in ~2 hours)
- # ONE 10'000 l/s CRYO PUMP (Gifford-McMahon CRYOGENERATOR, CRYOPUMPS & COMPRESSOR) (SIMILAR TO ACTUAL PUMP INSTALLED ON LINAC 1 - TANK 1)

CRYOS: BIG IMPROVEMENTS IN PERFORMANCE & RELIABILITY OVER THESE LAST YEARS  
REDUCED MAINTENANCE (every 10'000 hrs ~ One year)  
LOWER COST:

Fig. 25B

COST OF R/L pumping speed:

- TURBOS : ~ 30 SF
  - ION PUMPS : ~ 30
  - CRYOS : ~ 3-5
- } HYDROCARBONS FREE !

19 CRYO PUMPS ARE INSTALLED ON PS VAC SYSTEMS (RFQ, 9MHz ACOL DEBUNCHING CAVITIES, ACOL STOCHASTIC COOLING TANKS, TANK 1 LINAC 1 - - -)

Fig. 26

Fig. 26A

UNILAC-Projekt, Parameterliste des Strahltransportsystems

Stand 15.7.1973

SD-ÜBERSICHTSZEICHNUNG

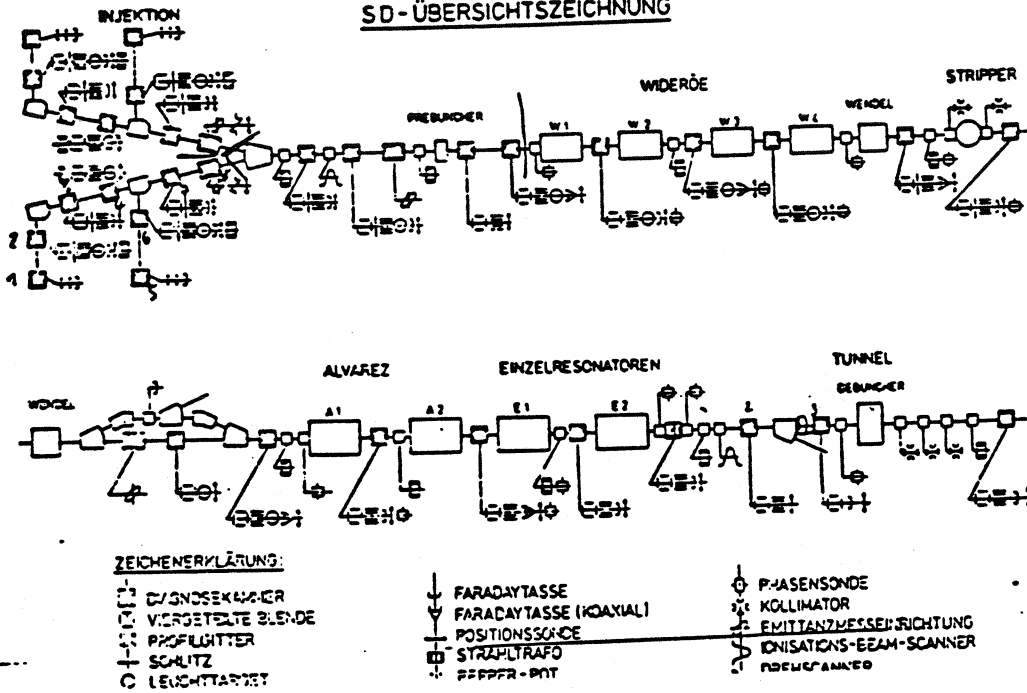
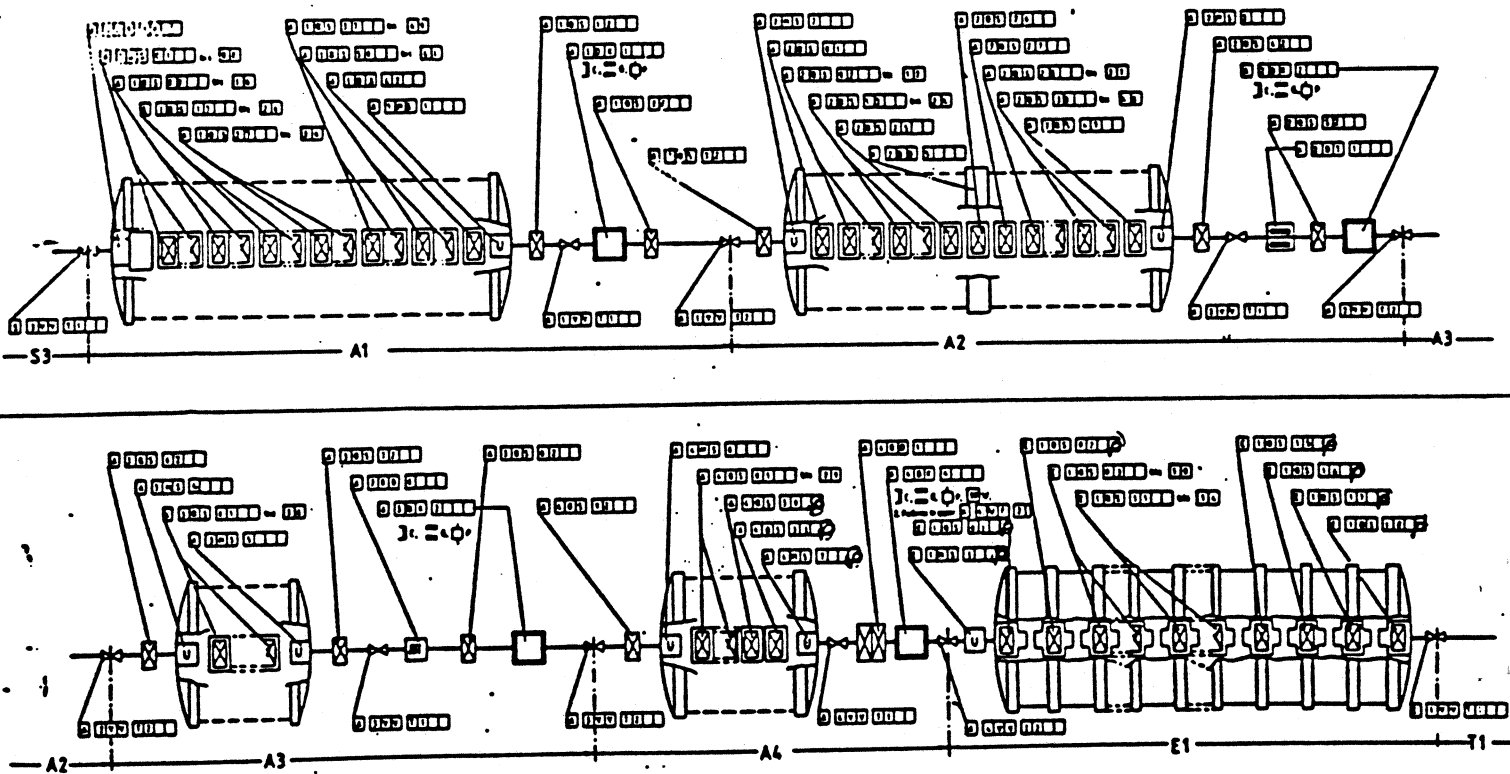
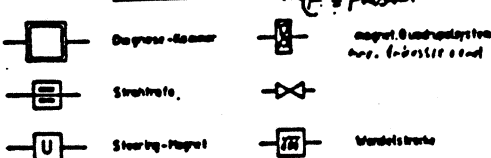

Fig. 26B



Bildzeichen



Diagnose-Meßsysteme

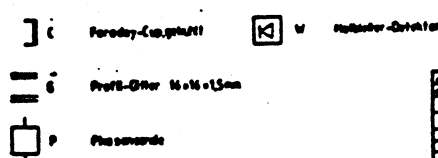

12.1.73

UNILAC	
Alvarez-Driftkammer-Abschnitt	
Strahlleitung / Strahltransport	
GSI	
UNILAC CA/E005020	
BARNSTADT	

PRINCIPLE OF TIME OF FLIGHT MEASUREMENT

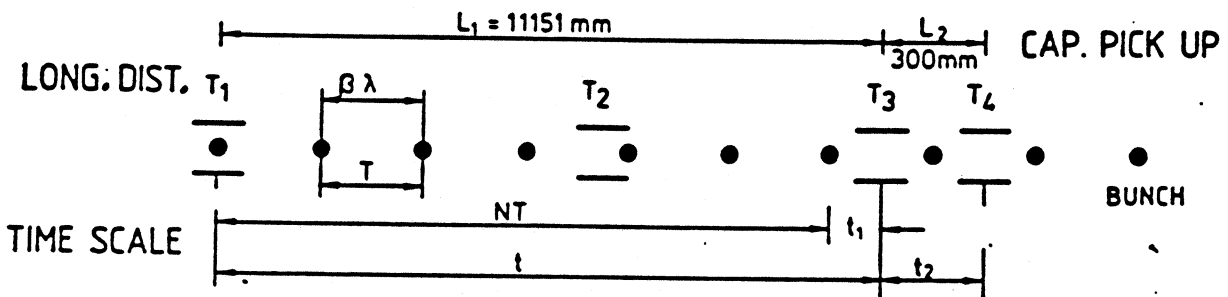

$$\left. \begin{aligned} \lambda &= 11061 \text{ mm} \\ T &= 36,8983 \text{ ns} \end{aligned} \right\} \text{ UNILAC PARAMETERS}$$

$$\beta_{\text{COARSE}} = \frac{L_2}{t_2}$$

$$N = \text{INT} \left( \frac{L_1}{\beta_{\text{COARSE}} \cdot \lambda} \right)$$

$$t = NT + t_1 ; \text{ TIME OF FLIGHT}$$

$$\beta = \frac{L_1}{ct} ; \beta \text{ --- ENERGY}$$

