

THE INTERNATIONAL LINEAR COLLIDER

FROM DESIGN TO REALITY

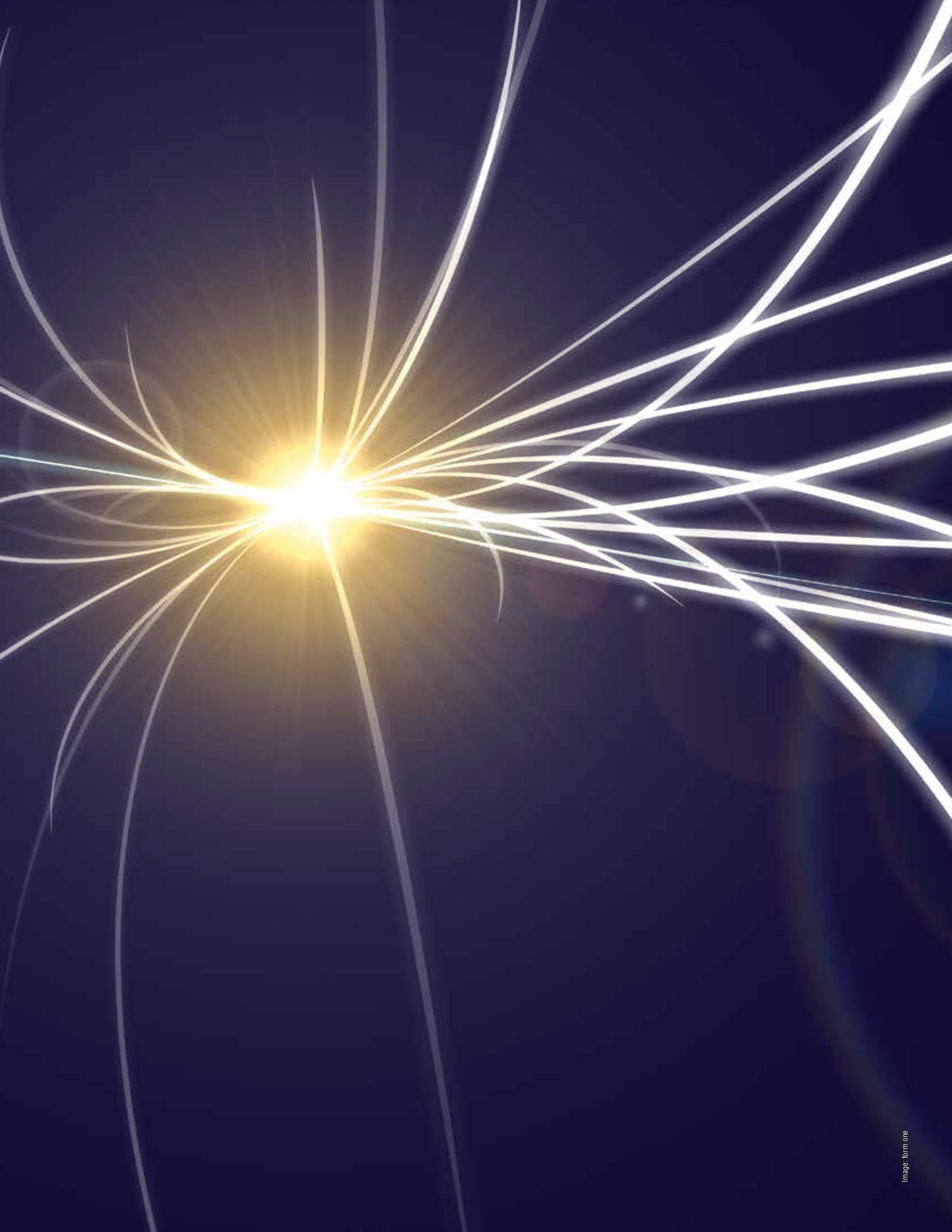



FOREWORD: WINDOW TO THE TERASCALE

Particle accelerators have been the primary tool of particle physics for over 60 years. They have enabled great advances and discoveries, the latest being the discovery of the Higgs boson at the Large Hadron Collider at CERN. Using complementary approaches of colliding protons on protons as a broad-band discovery device and colliding electrons on positrons as a precision probe of the physics, we have uncovered the basic constituents of matter and fundamental symmetries in nature. The International Linear Collider is the next advance in accelerators and will be the complementary electron-positron collider for the Large Hadron Collider. The ILC will enable precision studies of the underlying physics of the Higgs, a completely new kind of particle responsible for the creation of mass in nature.



Among the earliest particle accelerators were cyclotrons, which were followed by larger and larger particle accelerators and colliders that brought us at each step to higher energies and new discoveries of physics at very short distances. Now, the development of a linear collider represents yet another major step in our ability to accelerate very light particles, like electrons and positrons, and pave the way to new insights into how our world works. The technologies for a linear collider have been developed through an ambitious global R&D programme and are now, with the publication of the ILC Technical Design Report, ready to be employed in the next particle accelerator. We are technically prepared to build a complementary electron-positron collider to the Large Hadron Collider. Japan is seriously considering offering to host the ILC for the global collaboration, siting it in the mountains of Japan. They propose to begin with a Higgs Factory and extend it to higher energies in the future. This possibility is now being considered both within Japan and by the worldwide community. We look forward to taking the next step in the adventure that is the ILC.

BARRY C. BARISH
June 2013

THE INTERNATIONAL LINEAR COLLIDER – FROM DESIGN TO REALITY EDITORIAL COMMITTEE

PHILIP BURROWS

University of Oxford

BRIAN FOSTER

DESY and University of Hamburg

NICHOLAS WALKER

DESY

JOHN CARWARDINE

Argonne National Laboratory

KEISUKE FUJII

KEK

KIRK YAMAMOTO

KEK

MARCEL DEMARTEAU

Argonne National Laboratory

MICHAEL HARRISON

Brookhaven National Laboratory

Linear Collider Communicators:

PAN QIAN, PERRINE ROYOLE-
DEGIEUX, RIKA TAKAHASHI,
BARBARA WARMBEIN

This brochure represents Volume 5 of the ILC's *Technical Design Report*. It summarises the content of the four TDR volumes for a non-expert audience. For more information go to www.linearcollider.org

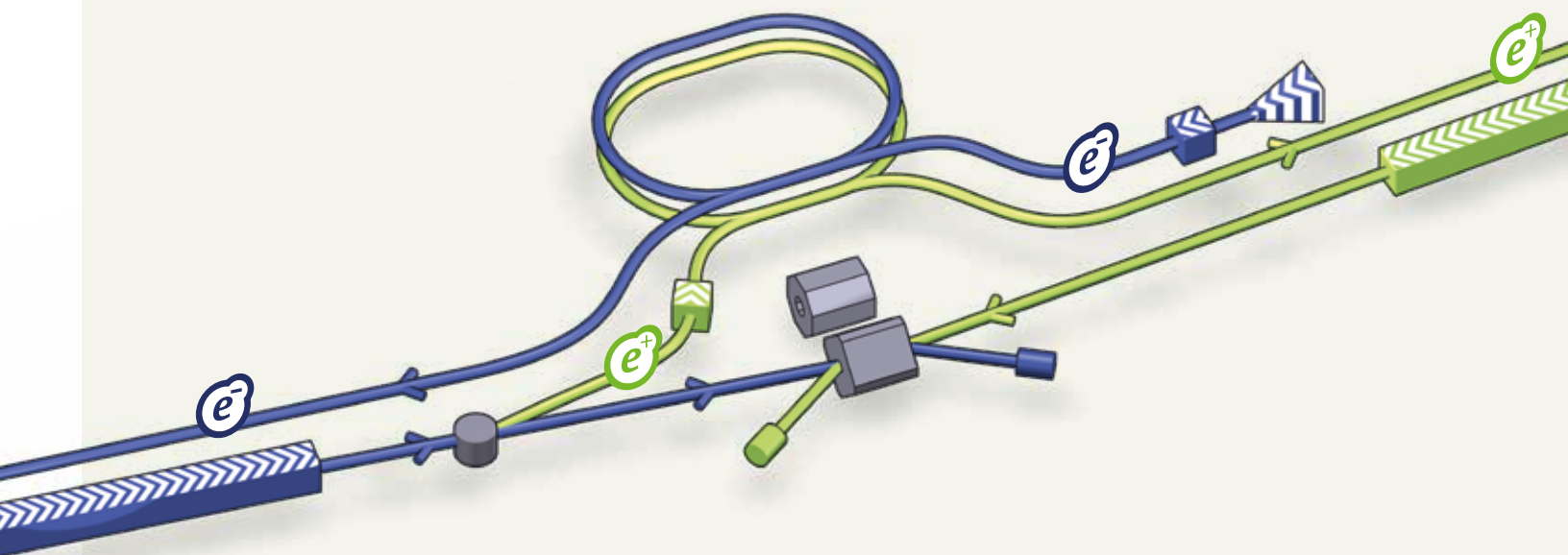

CONTENTS

3 FOREWORD: WINDOW TO THE TERASCALE

01 6 THE SCIENCE BEHIND THE NEW COLLIDER

- 7 The LHC has discovered the Higgs – what does that mean?
- 8 What is the Standard Model?
- 10 What is the Higgs and Higgs mechanism?
- 13 How will the ILC investigate the Higgs and other phenomena precisely?
- 15 How far can the Standard Model go?
- 15 What are dark matter and dark energy?
- 16 How is the ILC complementary to the ILC?
- 16 What is supersymmetry? And how can the ILC study it?
- 17 What are extra dimensions?
- 19 The ILC – shaping the future of particle physics

02 20 TECHNOLOGIES BEHIND THE NEW COLLIDER

- 21 The ILC travel guide
- 22 Source
- 23 Damping ring
- 24 Ring to main linac and bunch compression
- 24 Main linac
- 26 Positron source
- 27 Final focus
- 28 Interaction point and detectors

03 30 THE ORGANISATION WITHOUT BOUNDARIES

- 31 The project that goes beyond boundaries
- 32 The project that attracts people
- 32 The project that nurtures the next generation
- 33 The project that pushes technology and other sciences
- 34 The project that has economic impact as its home

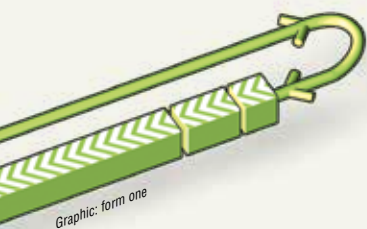



01 | THE SCIENCE BEHIND THE NEW COLLIDER

THE LHC HAS DISCOVERED THE HIGGS – WHAT DOES THAT MEAN?

July 4th in 2012 is destined to be a special day in the history of humankind. On that day, physicists working with the world's largest scientific facility, the Large Hadron Collider (LHC), at the European particle physics laboratory CERN, in Switzerland, announced that they have discovered a particle that looks a lot like the long-sought Higgs boson – the final missing piece in the Standard Model that describes fundamental particles and forces. The Higgs boson is the key to the explanation of how all the other fundamental particles get their masses. A few months later, this particle was confirmed to be a Higgs particle.

Discovering this new particle at the LHC is a triumph. After two successful years of operation at the LHC, the next step in our understanding of the Universe has been revealed. Now that the scientists have found a Higgs boson, many more years of follow-up research will be needed to verify its full identity. For a particle to be exactly the Higgs as originally conceived, all of its properties must be measured with great accuracy; a tough job indeed.

The energy of the Higgs particle recently discovered at CERN is well within the range of the ILC. It is too soon to know exactly what additional information will be uncovered from the LHC experiments, but even without this information the potential for exploiting Higgs physics at the ILC is enormous. At the ILC, Higgs particles will be created in electron-positron collisions and their properties measured: e.g. mass, the strength of their interactions with all other elementary particles with unprecedented precision and without assumptions. Will the Higgs properties be as predicted by the Standard Model? Or will it be just the first of a family? Will nature be more complicated than a single “minimal” Higgs boson? The precision of the measurements that can be made at the ILC allow us to estimate at what energy new particles may appear. There is agreement in the high-energy physics community that a linear collider like the ILC is the ideal facility to make these vital measurements.

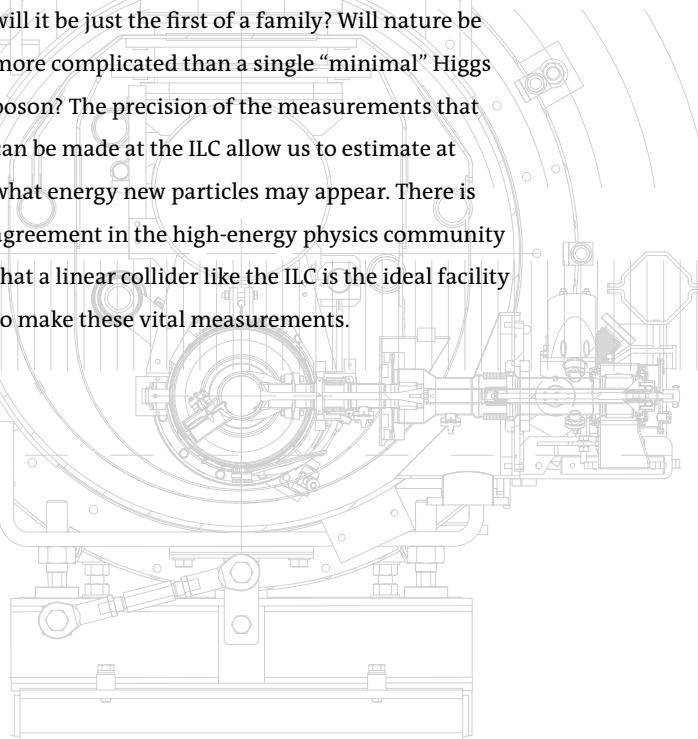

WHAT IS THE STANDARD MODEL?

The Standard Model of particle physics is a theory that describes the known particles that are the constituents of matter and three of the four known fundamental interactions between them. These interactions, or forces, are the electromagnetic force (which we experience every day when we turn on the light, the TV, use wireless communication etc), the strong force (which holds quarks together inside the protons and neutrons in the atomic nucleus, thereby forming the plethora of elements, from helium to iron to uranium, that make up our world) and the weak force (which is responsible for the Sun shining, without which life on Earth would be impossible, as well as for many radioactive decays).

The Standard Model works extremely well, but we know that it cannot be the complete theory if for no other reason than that it is incomplete; it does not incorporate gravity. It describes beautifully the ordinary matter of which we, and the entire visible universe, are made. It does not describe the invisible 95% of the universe that we know to be there, but which has thus far evaded detection. The Standard Model has nevertheless been tested to exquisite precision over a wide range of energies. It must therefore be a good approximation to a final, unified, theory.

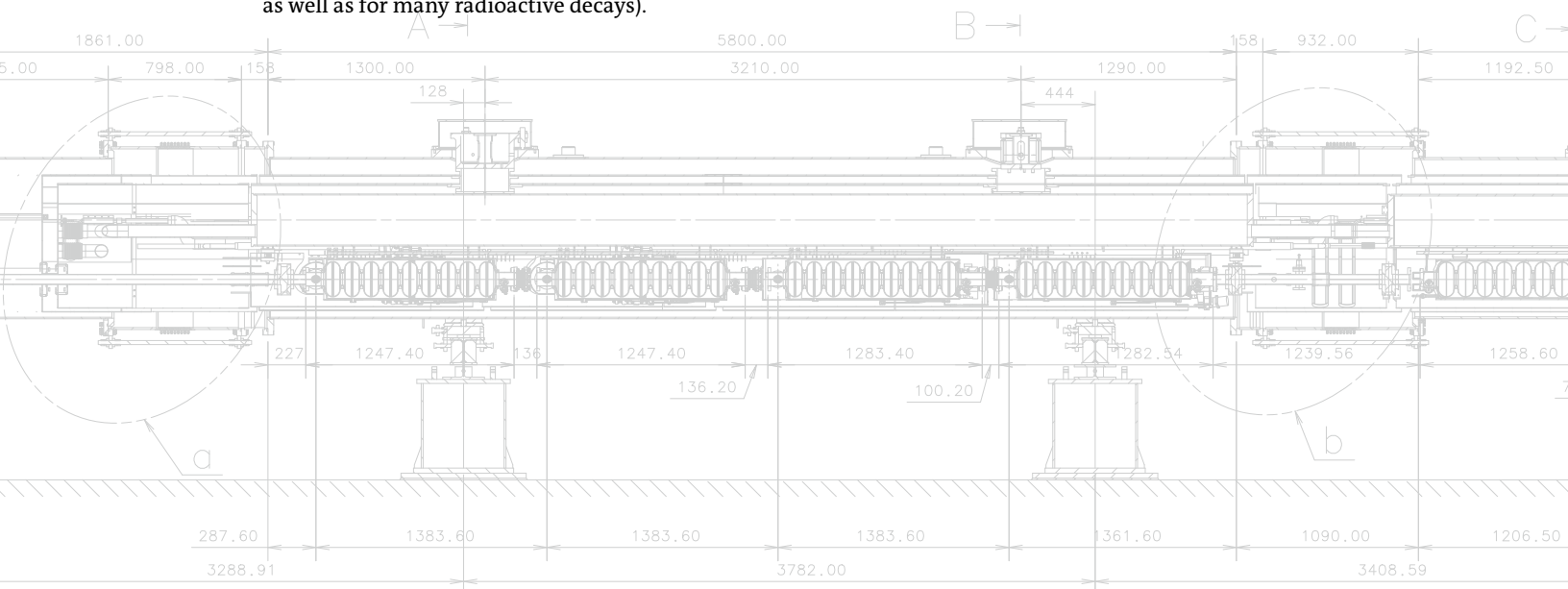

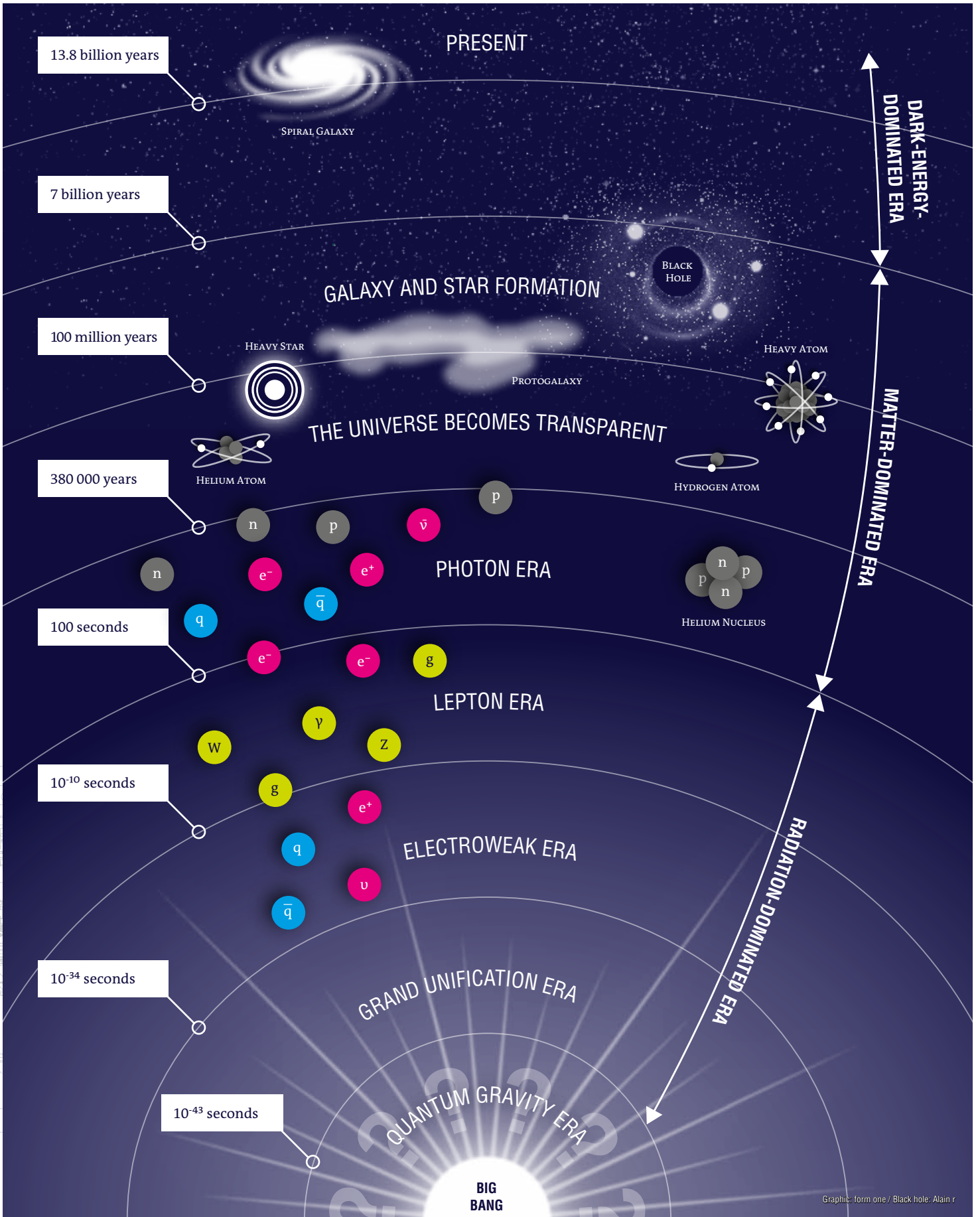

WHAT IS THE HIGGS AND HIGGS MECHANISM?

The Standard Model successfully describes all of the elementary particles we know to exist and how they interact with one another. But one piece is missing. The Standard Model cannot yet answer one basic question: why do most of these elementary particles have mass?

Theoretical physicists ROBERT BROUT, FRANÇOIS ENGLERT, PETER HIGGS, GERALD GURALNIK, CARL HAGEN and TOM KIBBLE proposed a mechanism that would explain how particles get their mass.

This mechanism postulates a medium that exists everywhere in space. Particles gain mass by interacting with this medium, or “field”. PETER HIGGS pointed out that the mechanism required the existence of a particle unseen until now, which we now call the Higgs boson after its inventor.

The Higgs mechanism predicts the Higgs boson to be a fundamental scalar, meaning a spinless particle. No other fundamental spinless particles exist in nature. Its spinless nature allows the Higgs to condense and fill the vacuum much like steam condenses to form the sea. The Higgs discovery raises a variety of new questions on the supposed nature of this boson and opens up a very important area of research.



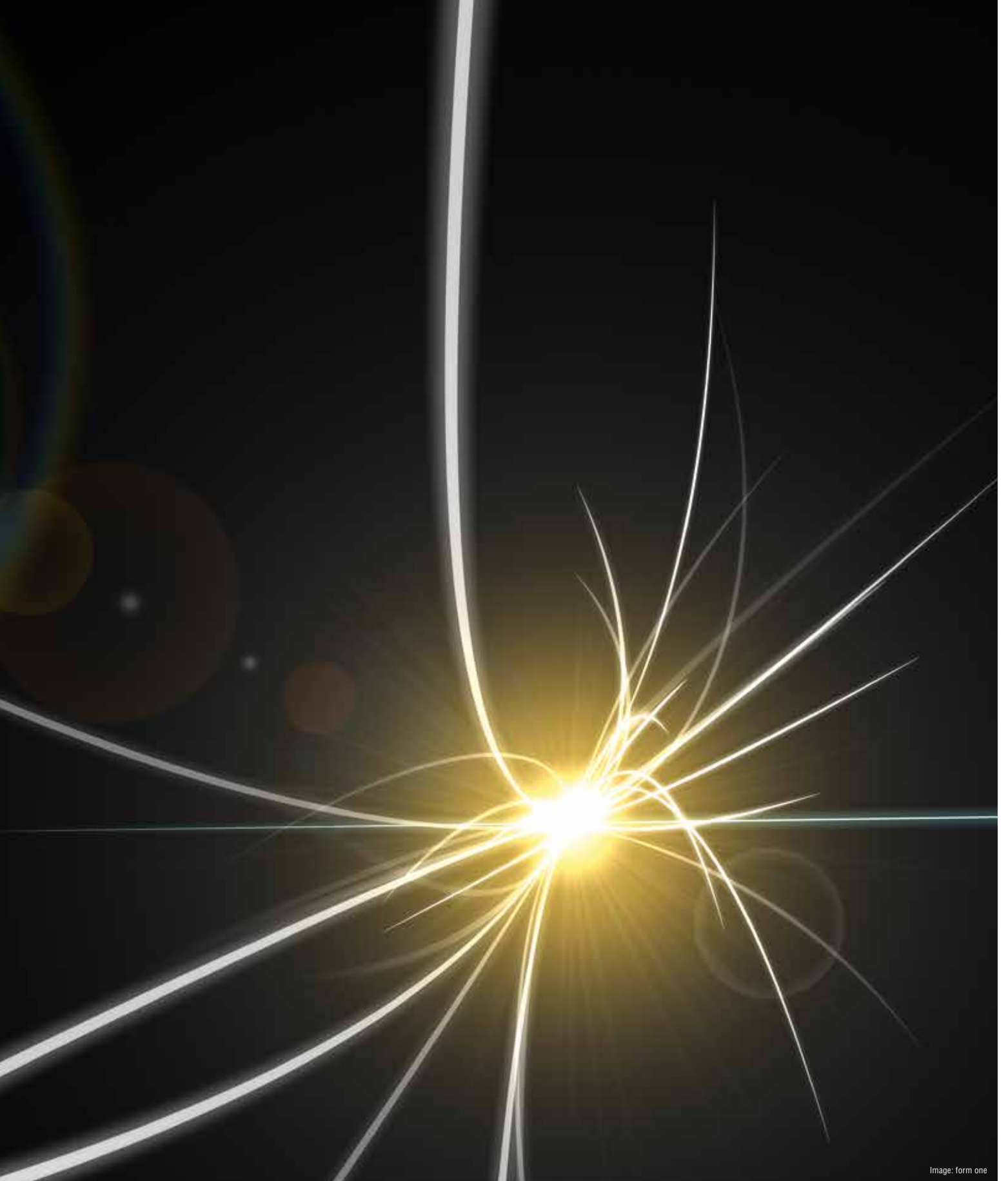

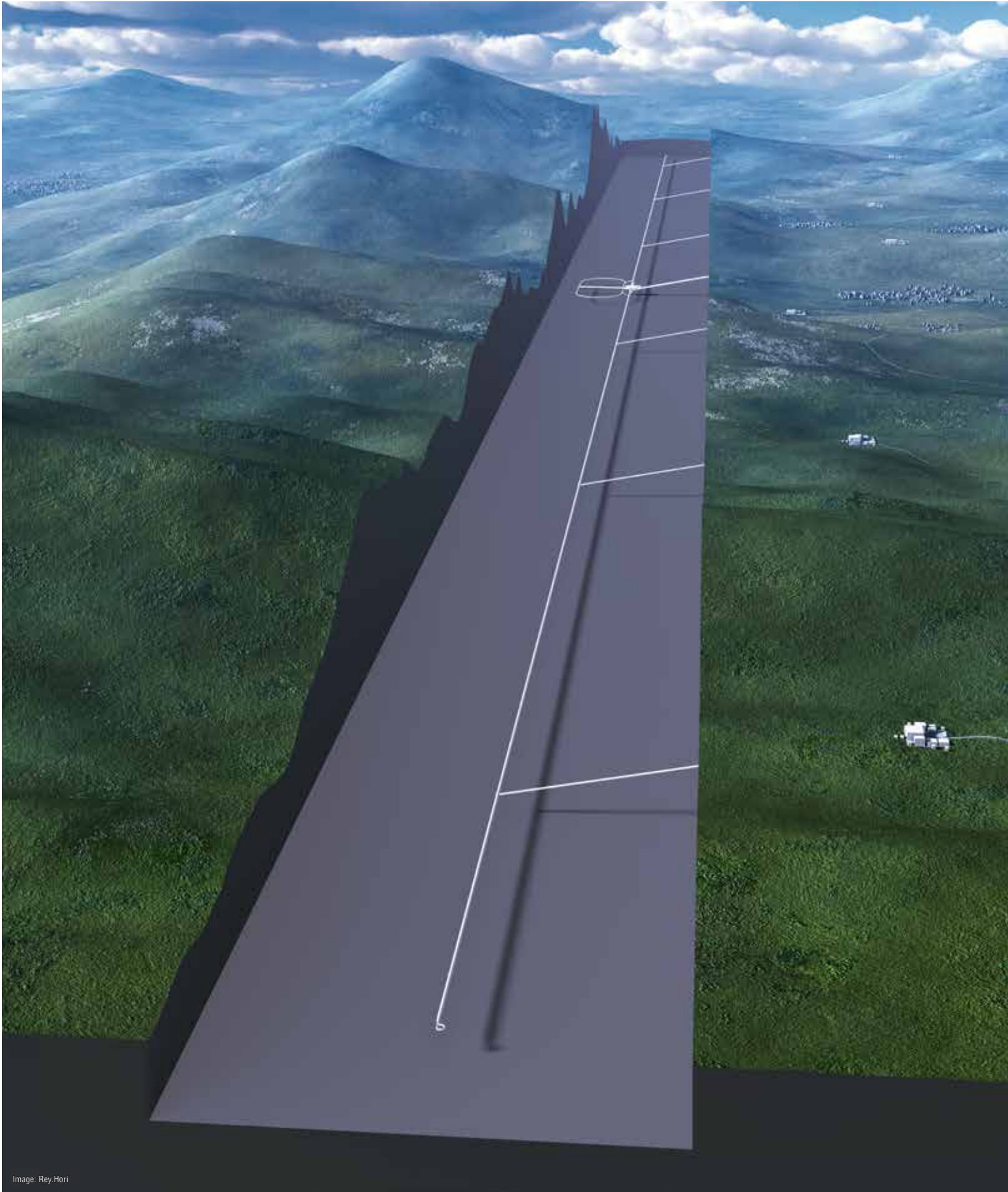



HOW WILL THE ILC INVESTIGATE THE HIGGS AND OTHER PHENOMENA PRECISELY?

The ILC is complementary to the LHC's proton-proton collisions. The LHC, a circular proton-proton synchrotron, operates at the highest energies any particle accelerator has ever achieved. The International Linear Collider will explore the same phenomena using a different approach. By colliding electrons with positrons, the ILC would allow us to home in with exquisite precision on the new landscape that the LHC will reveal. It will expand on the discoveries made by the LHC and investigate new laws of nature.

Apart from its spinless property, the Higgs boson's coupling strength to other particles is its second unique feature, which is ultimately responsible for generating these particles' masses. Measuring the strength with which the Higgs boson interacts with particles having different masses will investigate whether the predicted relative strengths are correct. The many precisely measured Higgs events at the ILC will produce quantitative measurements of the different coupling strengths that will enable us to distinguish among possible different types of Higgs bosons.

Another unique feature of the Higgs boson is its coupling to itself. The Standard Model precisely describes how the Higgs boson couples to other particles, including itself. With its precision, the ILC enables an accurate measurement of the Higgs' self-coupling and determines its potential, confirming or disproving in a completely model-independent way whether it is the Standard-Model Higgs boson.

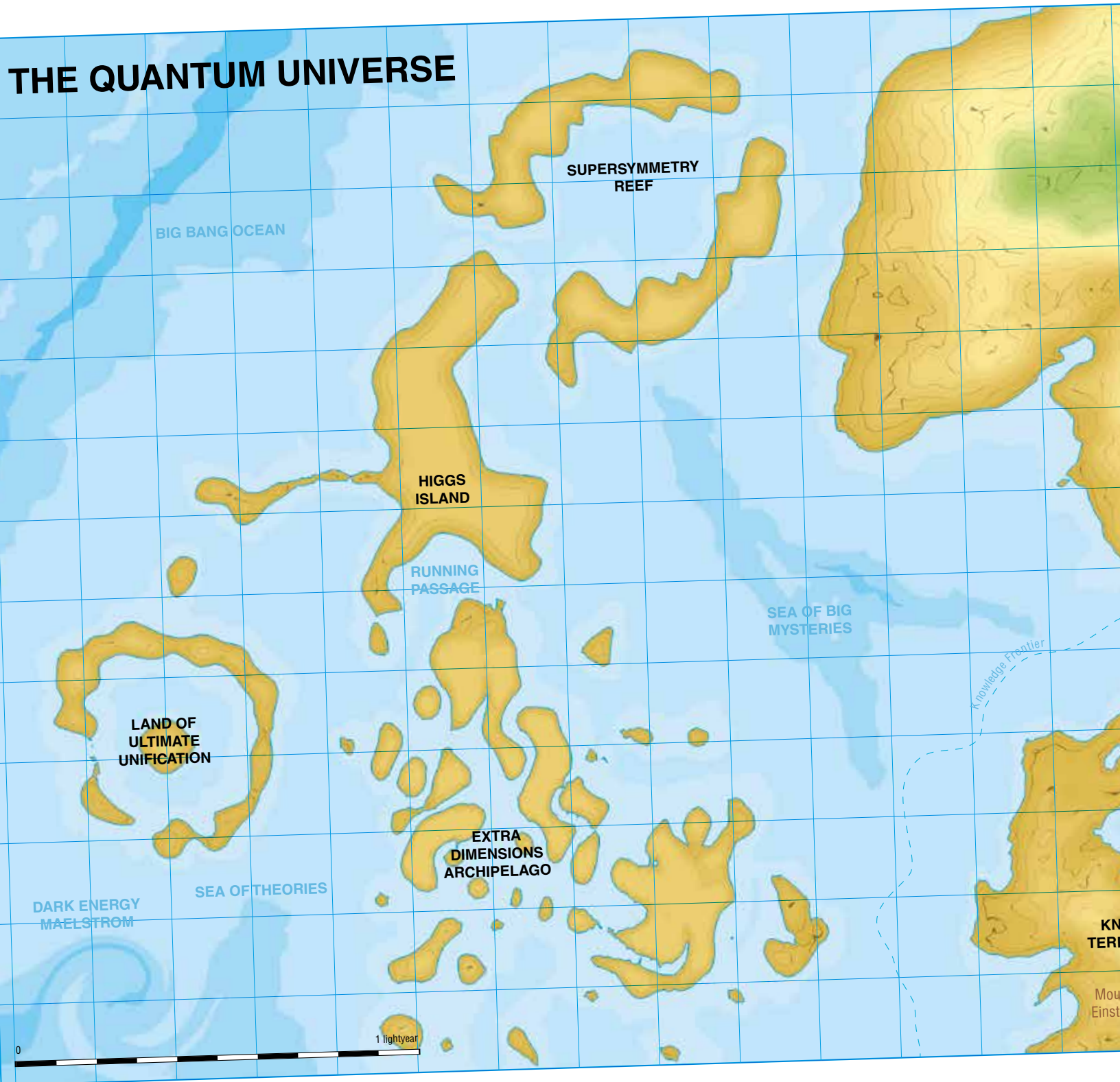

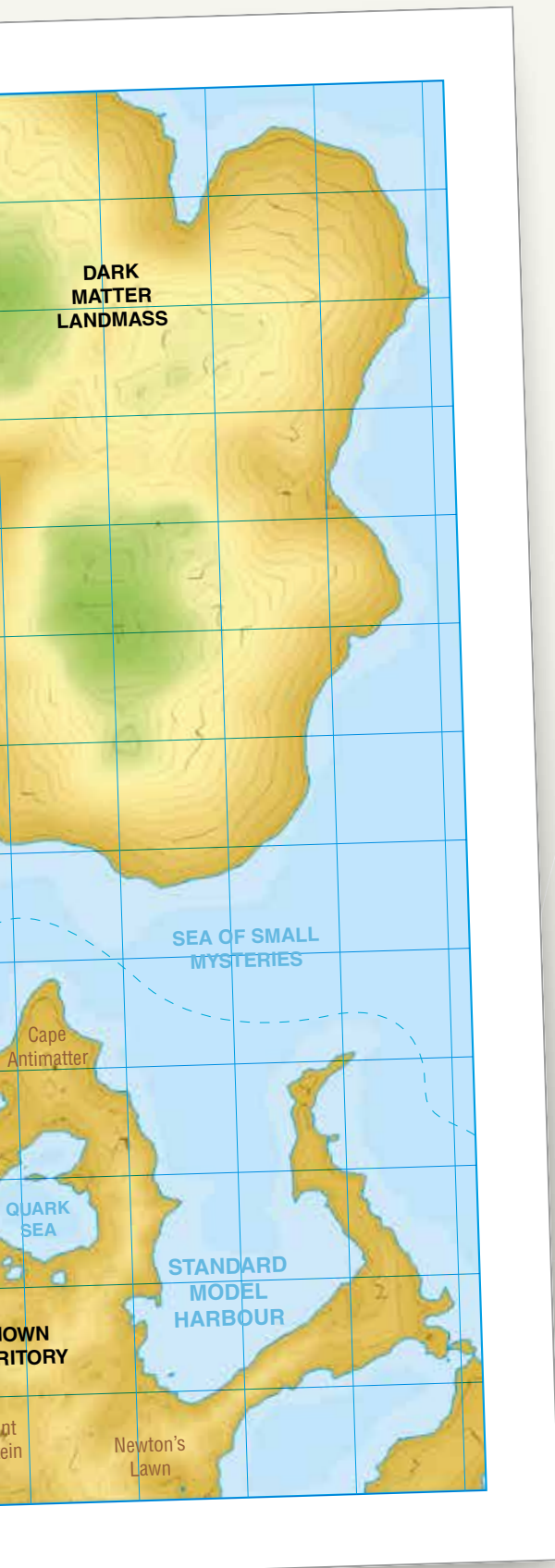

HOW FAR CAN THE STANDARD MODEL GO?

If the LHC does not find anything that hints at a deviation from the Standard Model, scientists would have to test the energy scale up to which the Standard Model can be valid. One way to do this is to check the stability of the theory. This is determined by values of the Higgs mass and the mass of the top quark. Whether the theory – its “vacuum stability”, as it is called – is absolutely stable or not depends critically on the precise value of the top mass. The ILC can measure the mass to unprecedented precision and decide the fate of the Standard Model.

WHAT ARE DARK MATTER AND DARK ENERGY?

Most of the matter in the universe is dark. Without dark matter, galaxies and stars would not have formed and life would not exist. It holds the universe together. What is it?

It is only in the last 10 to 15 years that scientists have made substantial progress in understanding the properties of dark matter, mostly by establishing what it is not. Recent observations of the effect of dark matter on the structure of the universe have shown that it is unlike any form of matter that we have discovered or measured in the laboratory. At the same time, new theories have emerged that may tell us what dark matter actually is.

Searches for candidate dark matter particles are underway at present-day colliders. If these particles have masses at the TeV scale, they will surely be discovered at the LHC. However, verifying that these new particles are indeed related to dark matter will require a linear collider to characterise their properties. The International Linear Collider can measure their mass, spin and parity with extremely high precision. These results will permit calculation of the present-day cosmic abundance of dark matter and comparison to cosmological observations. If the values agree, it will be a great triumph for both particle physics and cosmology and will extend the understanding of the evolution of the universe after the big bang.

HOW IS THE ILC COMPLEMENTARY TO THE LHC?

The LHC and the ILC provide very different conditions to produce and allow us to study particles. High-energy interactions of protons at the LHC proceed via the interactions of the constituents of protons, the quarks and gluons; the ILC will study collisions of electrons and positrons. As electrons and positrons are elementary particles and have no known internal structure, linear-collider experiments are able to study simpler, more elementary processes without the complicated “background” present at the LHC and hence achieve a higher level of precision. The LHC is already operating, so it gives us the chance to discover new particles and to study properties of the known particles today. The linear collider, with its higher level of precision, will add qualitatively new knowledge. It has the potential to reveal new details and possibly particles that are invisible to the LHC experiments.

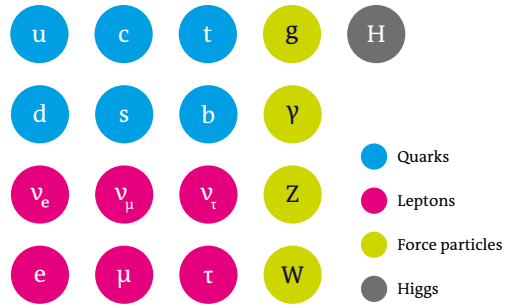

WHAT IS SUPERSYMMETRY? AND HOW CAN THE ILC STUDY IT?

The theory of supersymmetry says that all known particles have heavier superpartners, new particles that bring a new dimension to the subatomic world. The lightest superpartner is a likely candidate to be dark matter, and could thus also explain the structure of the cosmos.

A linear collider would be best suited for producing the lighter superpartners. Linear-collider experiments could focus on one type of superpartner at a time, measuring their properties precisely enough to detect the symmetry of supersymmetry, and to reveal the supersymmetric nature of dark matter. In this way, physicists could discover how supersymmetry shapes both the inner workings and the grand designs of the universe. Designed with great accuracy and precision, the ILC becomes the perfect machine to conduct the search for dark-matter particles with unprecedented precision; we have good reasons to anticipate other exciting discoveries along the way.

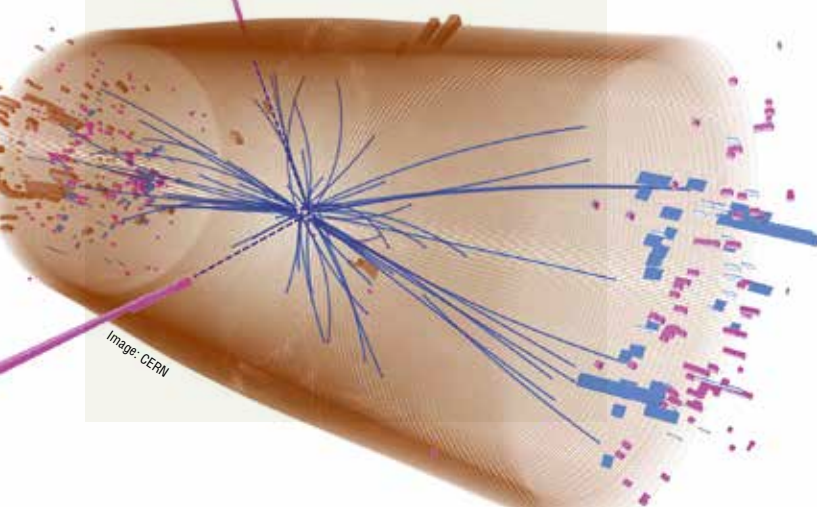
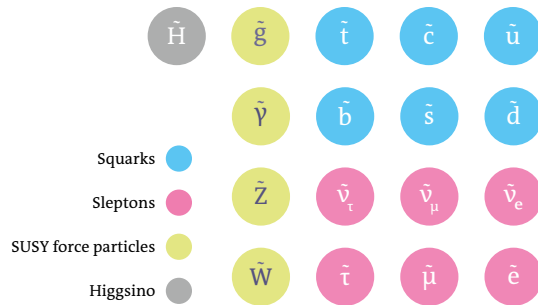

Image: CERN



WHAT ARE EXTRA DIMENSIONS?

Many theories, such as Superstrings, that try to unify gravity with the other forces require the Universe to have additional dimensions to those of space and time that are familiar to us. Such theories attach additional spatial dimensions to each point in space. The extra dimensions must be very tiny or otherwise hidden from view since none of our experiments have so far given any evidence that they exist. Matter might be made of particles that already live in extra dimensions and feel their effects. A particle moving in an extra dimension would have extra energy, making it look like a heavier version of itself. Measurement of the mass and other properties of these travelers would show what the additional dimensions look like.

If new dimensions exist at the Terascale, then the LHC should discover them; experiments will look for high-energy collisions in which particles literally disappear into an extra dimension. The ILC would be able to reveal the detailed structure of these extra dimensions and their associated particles and might detect signs for others that cannot be seen by the LHC.

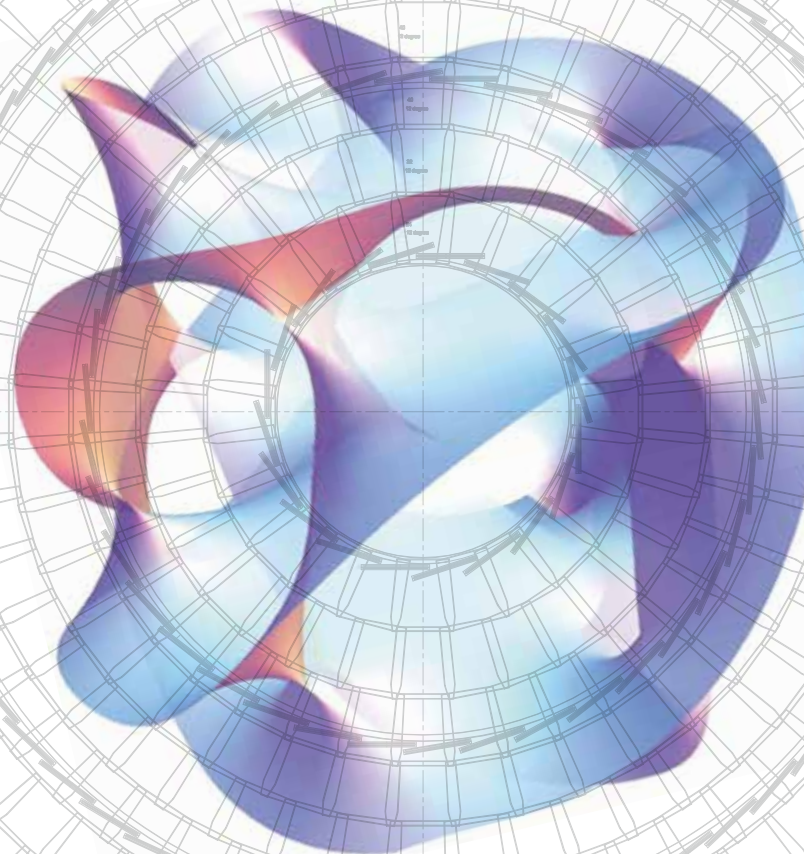

“NEW DIRECTIONS IN SCIENCE ARE LAUNCHED BY NEW TOOLS MUCH MORE OFTEN THAN BY NEW CONCEPTS. THE EFFECT OF A CONCEPT-DRIVEN REVOLUTION IS TO EXPLAIN OLD THINGS IN NEW WAYS. THE EFFECT OF A TOOL-DRIVEN REVOLUTION IS TO DISCOVER NEW THINGS THAT HAVE TO BE EXPLAINED.” FREEMAN DYSON, Imagined Worlds



THE ILC – SHAPING THE FUTURE OF PARTICLE PHYSICS

With the discovery of a Higgs boson, the ILC has a guaranteed, rich physics program to explore. If the new particle is truly a spinless fundamental particle, it is the only such particle that we know about. It adds a completely new dimension to our understanding of the fabric of space-time. The ILC and its detectors are precision instruments allowing the properties of the Higgs boson to be studied with laserlike focus. The impact of the ILC, however, reaches far beyond the Higgs. With its variable center of mass energy, it can, as future measurements might require, carry out a programme of ultra-precise electroweak measurements of the Z-boson, study the top quark in great depth and study the self-coupling of the Higgs boson at its highest centre-of-mass energy. Furthermore, it can make measurements which do not rely on any theoretical assumptions, thereby investigating the internal consistency of new theories. The ILC will be a tool of unprecedented versatility. As FREEMAN DYSON once said, “New directions in science are launched by new tools much more often than by new concepts. The effect of a concept-driven revolution is to explain old things in new ways. The effect of a tool-driven revolution is to discover new things that have to be explained”. The ILC is such a tool!



02 | TECHNOLOGIES BEHIND THE NEW COLLIDER





THE ILC TRAVEL GUIDE:

follow the particles on their trip through the accelerator and discover ingenious technologies along the way

At the height of operation, bunches of electrons and their antiparticles (positrons) will collide roughly 7,000 times per second at a total collision energy of 500 GeV, creating a surge of new particles that are tracked and registered in the ILC's detectors. Each bunch will contain 20 billion electrons or positrons – this means a very high rate of collisions. This high “luminosity”, when combined with the very precise interaction of two point-like colliding particles that annihilate each other, will allow the ILC to deliver a wealth of data to scientists that will allow the properties of particles, such as the recently discovered Higgs boson, to be measured precisely. It could also shed light on new areas of physics such as dark matter.

How will it work? How do the particles get from one end of the accelerator to the collision point at the centre, and what happens to them on their way? Here's your travel guide.

O
START
HERE

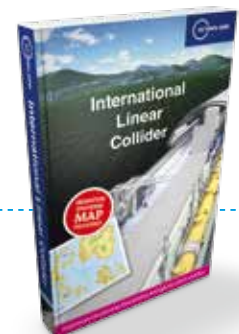



Image: DESY

WHY IS THE LINEAR COLLIDER LINEAR?

When an electric charge follows a curved track, it emits X-rays and loses energy. The higher its energy, the more energy it loses. The energy loss also depends on the mass of the particle and is much more severe for electrons and positrons than for the LHC's protons. The solution to reach high energies is to eliminate the curves, hence to build a "linear" collider.

WHAT IS A GEV?

An electronvolt, eV, is the basic unit of energy or mass used in particle physics. It refers to the amount of energy a single electron gains when it is accelerated across an electric potential difference of one volt. One eV is extremely small, and units of a million electronvolts, MeV, or a billion electronvolts, GeV, are more common. The latest generation of energy-frontier particle accelerators, such as the LHC, reaches up to several trillion electronvolts, or TeV.

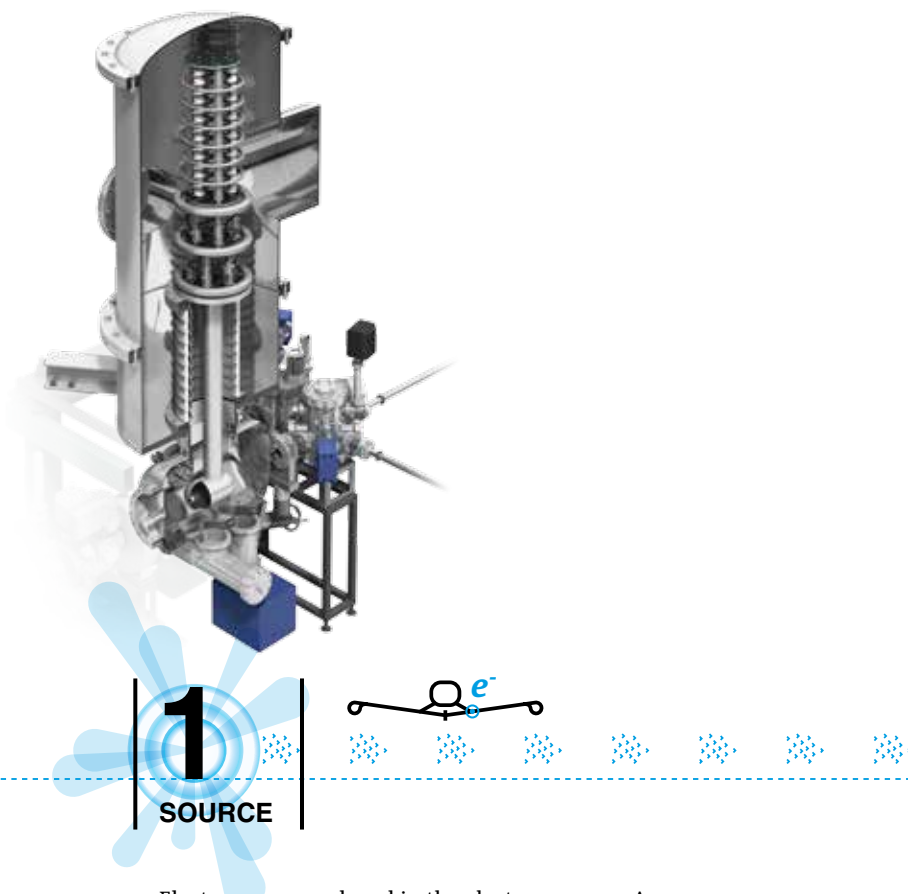

1
SOURCE

Electrons are produced in the electron source. An intense laser beam shines onto a semiconductor cathode and knocks out billions of electrons. Electric and magnetic fields gather the electrons together and accelerate them to an initial energy of 5 GeV.



2

DAMPING RING



Their next port of call is the damping ring. The density of the particles in the bunch generated by the source is far too low, and the particles need to be packed into a much smaller volume – or damped – to reach the high ILC performance requirements. This is done in a closed storage ring accelerator similar to many synchrotron light sources around the world. Indeed it is the same “synchrotron light” that the particles radiate as they go around the ring that causes them to pack together more tightly. But the ILC pushes this technology still further, demanding that the entire damping process happen in a fraction of a second before the bunches are extracted and sent on the next stage of their journey to the collision point. This requires some impressive technologies to make the particles radiate as fast as possible. No easy feat, but experiments at test accelerators have shown that these requirements can be met. Experts from the fields of light sources and high-energy-physics accelerators have worked

together to create a design of a high-performance damping ring that will be up to the ILC job. One kind of special magnet, the so-called wiggler, sends the particle bunches on a serpentine course, causing them to shed some of their energy, which makes them more uniform within the bunch and thus reduces its size. Other technologies for the vacuum system needed to deal with the very high number of particles in the rings have also been the subject of intense study over the last several years. There are two damping rings of three-kilometre circumference installed inside one tunnel – one for electrons, the other for positrons. When the electron or positron bunches leave their respective damping ring they will have gone around the rings about 20,000 times and become very compact and dense – but not quite dense enough. The bunches are still too long and need to be “compressed”, but that’s the next part of the story.

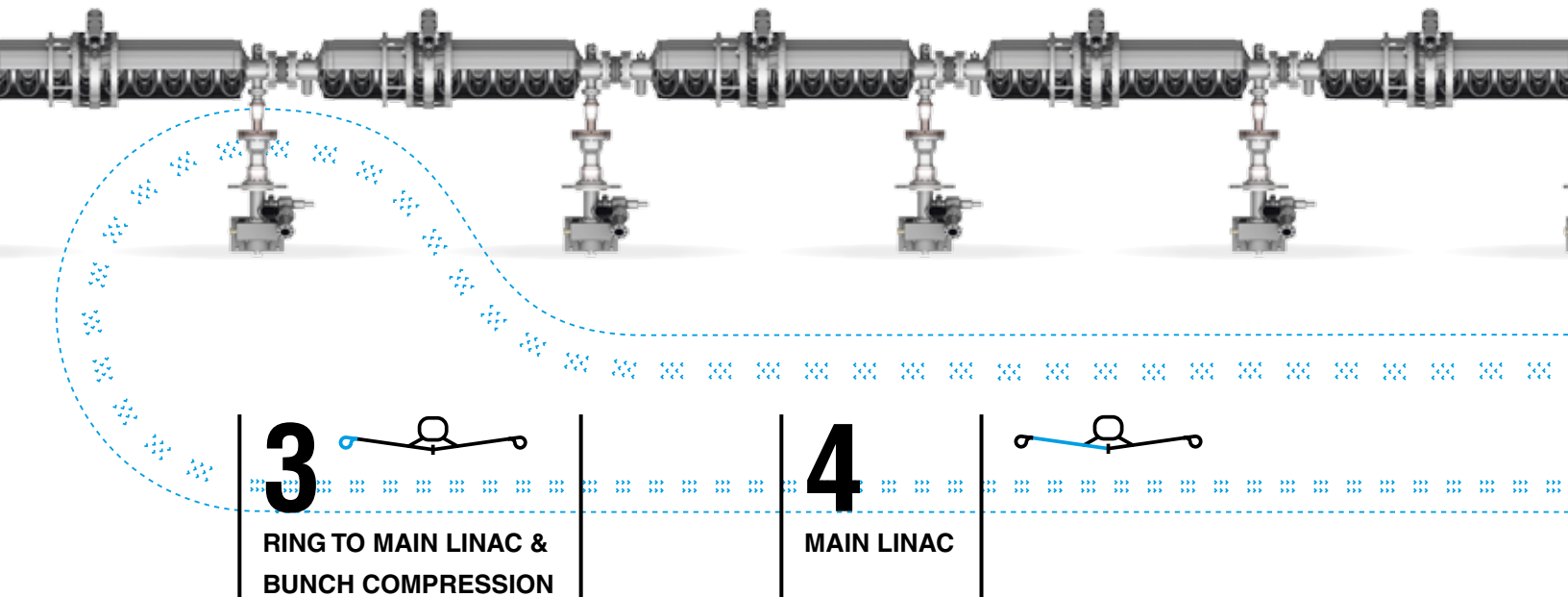

3
RING TO MAIN LINAC &
BUNCH COMPRESSION

The neatly packaged and tiny – but still too long – electron and positron bunches are extracted from their respective damping rings and transported in opposite directions some 15 kilometres before being turned 180 degrees in a gentle arc of magnets, ready for the race back to the collision point. Before that all-important sprint through the main accelerator, the bunch length is compressed from 6 mm down to just 0.3 mm, using special sections of the same accelerator technology used in the main linacs, together with some special magnets. While doing this compression, the bunches undergo their first acceleration from 5 to 15 GeV. Now the ultra-compact bunches are ready to be accelerated to the collision energy.

4
MAIN LINAC

Now comes the fast part. Up until this point, the electrons and positrons have been accelerated to a modest 15 GeV. The energy they need to reach at the collision point, however, is 250 GeV (or even twice that at a possible later phase of the ILC). At these energies, scientists hope they can see, and study in detail, the physics phenomena that have been out of reach or only been glimpsed at by other colliders.

Superconducting microwave cavities are the key to reaching this energy. The more accelerating voltage they can apply to the electrons and positrons, the shorter the accelerator can be (which can reduce the cost quite substantially). The cavities' core quality is their acceleration gradient – the higher the gradient, the bigger the boost they can give to the particles. Gradients are however limited by the quality of the inner surface of the cavities, which must have an ultra-clean mirror-like finish as perfect as possible.

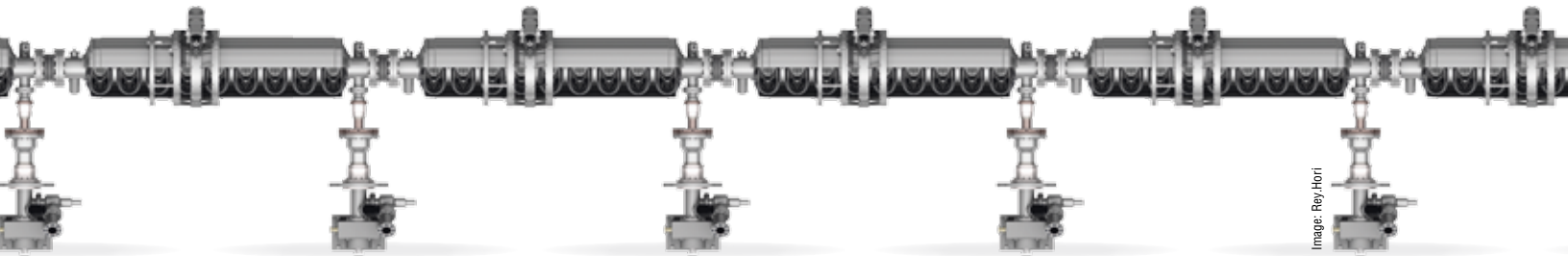

Image: Rey-Hori

Several decades of research on superconducting cavities have resulted in a recipe for fabrication and surface treatment that can produce cavities with a gradient exceeding the average 35 Mega-volts per metre required for the ILC. Despite this state-of-the-art performance, the two linacs still need to each be 12 kilometres long in order to accelerate the particle bunches to 250 GeV. Operating at -271 degrees Centigrade, the ILC's main linacs will also require one of the world's largest liquid-helium refrigeration plants like the one in operation at the LHC.

The electrons and positrons zoom through the cavities, carried along by the force of electromagnetism. An oscillating electric field inside the cavity at the frequency of radio waves – which is where the name of the acceleration technology comes from: superconducting radio-frequency acceleration – push the particles from cavity to cavity. For a beam energy of 250 GeV, they will pass through 8,000 cavities, or a total of 16,000 cavities for both accelerators.

The production of these cavities and their surrounding equipment has been one of the greatest challenges in the R&D work for the ILC. Accelerator and particle physicists from institutes all over the world have worked together with industry from different countries to work out the best way to produce reliable as well as affordable cavities and their cryomodules, the containing structures within which they operate. The production of accelerator parts like cavities and cryomodules will be done by industry, almost certainly different companies in different regions of the world, whose products then have to fit together to ultra-high precision.

Once accelerated through the main linacs, the positrons are ready for the final leg of the journey to collisions. However, the electrons have one additional job to do before colliding. We have omitted to say where the positrons come from – they are in fact produced by the electron beam!



5

POSITRON SOURCE



While it is relative straightforward to rip electrons out of a semiconductor with a laser beam, making positrons presents an altogether bigger challenge. This is because, unlike their matter counterparts the electrons, positrons do not actually exist naturally in our universe. They have to be made.

The way the ILC will do this is by using the 250 GeV electron beam on its way to the collision point. The high-energy electrons will pass through a special magnet called a helical undulator, which is 200 metres long. Just as in the damping rings, the electrons will be made to radiate light in this magnet – indeed it is exactly the same phenomenon.

The difference is in the energy: the 250 GeV electron beam in the positron source's helical undulator generates high-energy gamma rays in a very narrow cone. These gamma rays slam into a thin titanium-alloy target, knocking loose a shower of electrons and positrons. The accelerator sections downstream then collect the positrons and throw away the electrons. The positrons are then bunched, accelerated to 5 GeV and injected into the positron damping ring in much the same way as the electrons.

In the meantime, the 250 GeV electron beam is gently bent away from the gamma ray cone and around the metal target before it proceeds on its way to meet the positrons generated on the previous machine pulse at the collision point.



Image: Rey.Hori

6

FINAL FOCUS



When electrons and positrons have each reached their collision energy of 250 GeV, the beams get one last massage before they enter the hall where it all happens: the interaction point around which the detector sits ready to record the collisions.

In the last two kilometres, instead of running through accelerating cavities the beams pass a series of specially designed and arranged magnets that ultimately focus them down to a height of just a few nanometres at the collision point. The “final focus” system can be thought of as a sort of microscope in reverse, where the beams are demagnified – instead of magnified – by a factor of about 300. Rather than using glass lenses as in an optical microscope, special arrangements of magnets are used to produce the focusing “lenses”.

The tiny beams need to be collided with an accuracy of a fraction of their size, so less than a nanometre! At this level, great care has to be taken to deal with vibration and other tiny fluctuations in magnetic and electric fields that can easily cause the bunches to wobble as they pass through the accelerator and final focus. Ultra-fast diagnostics systems analyse the shape and position of the bunches and tell the magnets how to correct them to optimise the collisions: without such fast “feedback systems”, the beams would simply miss each other. Using a purpose-built final-focus test beamline in Japan, an international collaboration has developed the controls and instrumentation needed to achieve these challenging parameters.

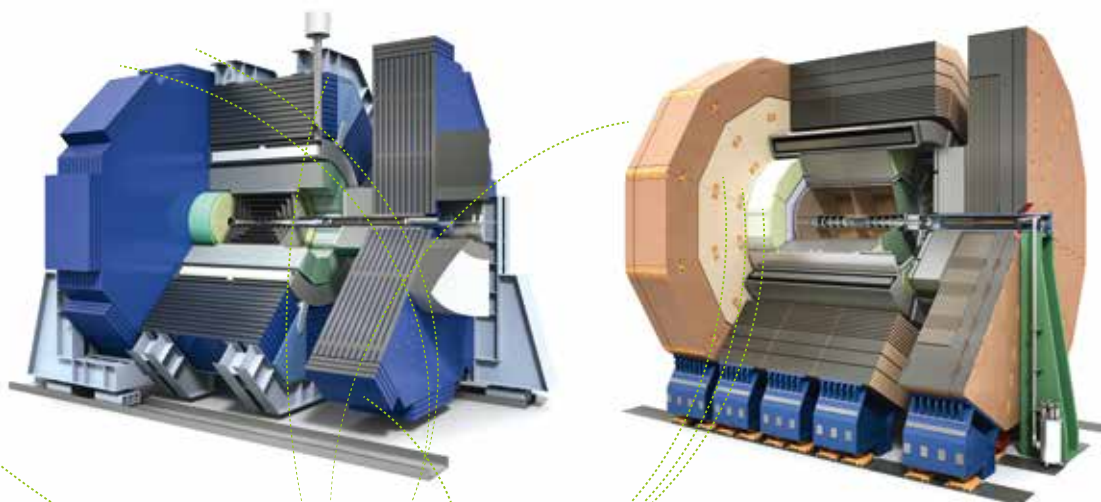

7

INTERACTION POINT AND DETECTORS

After all the squeezing, acceleration and focusing, the particles can finally hurtle towards their final destination: the collision between electron and its antiparticle, the positron. At full operation there are a potential 1.3×10^{14} (that's 130 trillion) electron-positron collisions per second, crammed into the tiny interaction area of just $6 \times 500 \text{ nm}^2$ – or just 0.000000003 mm^2 . Despite these impressive numbers, only a tiny fraction of the electrons and positrons actually collide. The higher the density of the particles at the interaction point, the greater the probability that some will collide: one reason why so much effort is made to produce tiny intense beams at the collision point.

When they do collide, electrons and positrons annihilate in a burst of energy, creating an array of new particles that fly out from the collision point. It's these new particles, their interactions, lifetime, and energy that the detectors will study.

Arranged in concentric cylinders of subdetectors with different technologies and tasks, these detectors are awe-inspiring in speed and precision (and in physical volume). Years of research and development have already produced mature technologies and concepts which will be required for the unprecedented precision of the measurements that need to be made. This R&D will go on until the very last minute to get even better, faster results more cost-effectively. The way the detectors will take data is unique, too. Two detectors will be built as one has to verify the results of the other before physicists can claim to have made a discovery. In order to avoid building a second, very costly, final-focus system, the ILC scientists invented the push-pull system: while one detector is installed in the interaction point and takes data, the other is in servicing position. After some time they swap position, being moved on two gigantic platforms that ensures the stability of even the tiniest part within the huge detector.

WHAT ARE THE POSSIBLE STAGES OF CONSTRUCTION?

The current design foresees an ILC with a maximum operating energy of 500 GeV centre-of-mass energy, i.e. 250 GeV per beam, which could be raised to one TeV at a later stage by making the linacs longer. The ILC could also be built as a so-called Higgs factory: at half the original design energy, requiring just half of the linacs, it could mass-produce and study the new particle found at the LHC in great detail. Such a scenario should be considered as a first phase of the larger machine.



HOW MUCH WILL IT COST?

For the Technical Design Report, the GDE has produced a “value estimate”. Value estimates are a common form of costing large international projects that are usually constructed using mainly in-kind contributions from participating nations.

The value estimate for the construction of the ILC in the Technical Design Report is 7.8 billion ILCU together with 23 million person hours (approximately 13,000 person years) of additional labour (ILCU stands for ILC value Unit. One ILCU is 1 US Dollar in January 2012. The relation of the ILCU to a currency other than the US Dollar is determined by purchasing power parity indices published by the Organization for Economic Co-operation and Development.). This estimate is averaged over three regional sample sites and represents the construction cost of a 500 GeV linear collider as described in the cost chapter of the Technical Design Report. The variance among the three regional site estimates is about 2%. The value estimate has an uncertainty of 25%. A more accurate estimate can be calculated when a host site is identified and the international project governance and in-kind contributions are agreed upon.

WHAT IS SUPERCONDUCTIVITY AND SUPERCONDUCTING RF?

Some metals become superconducting when they are cooled down to very low temperatures, which means that they lose all electrical resistance and can conduct electricity in an ultra-efficient way. Superconducting radio-frequency cavities are at the heart of the technology in the International Linear Collider. The ILC will use a voltage generator to fill a hollow structure called a cavity with an electromagnetic field. Made out of pure niobium, the cavities will be chilled to 2 Kelvin, near absolute zero temperature, at which point niobium is a superconductor and the cavities have almost no electrical resistance. Inside the cavities, the voltage of the field oscillates with a certain frequency – a radio frequency. Charged particles feel the force of the electric field and accelerate. String enough of these cavities together, and you will have a particle accelerator.



03 | THE ORGANISATION WITHOUT BOUNDARIES



THE PROJECT THAT GOES BEYOND BOUNDARIES

The International Linear Collider will be one of the world's largest and most sophisticated scientific endeavours.

Planning, designing, funding, building and operating the ILC will require true global participation. The ILC can be realised only as a collaboration between many people in many fields: engineers, business persons, scientists, students, local officials and residents.

The ILC is the culmination of an assembly of all kinds of cutting-edge technologies and expertise. We can expect the breakthroughs led by ILC R&D to have huge impact on our society, both technologically and economically, which goes far beyond the pure science results of particle physics.

In addition, the fruits of the research done at the ILC will have benefits in a wide range of areas directly linked to people's lives, such as environment, education, medicine, life science, IT, energy, and more.

ILC is the project that goes beyond boundaries.

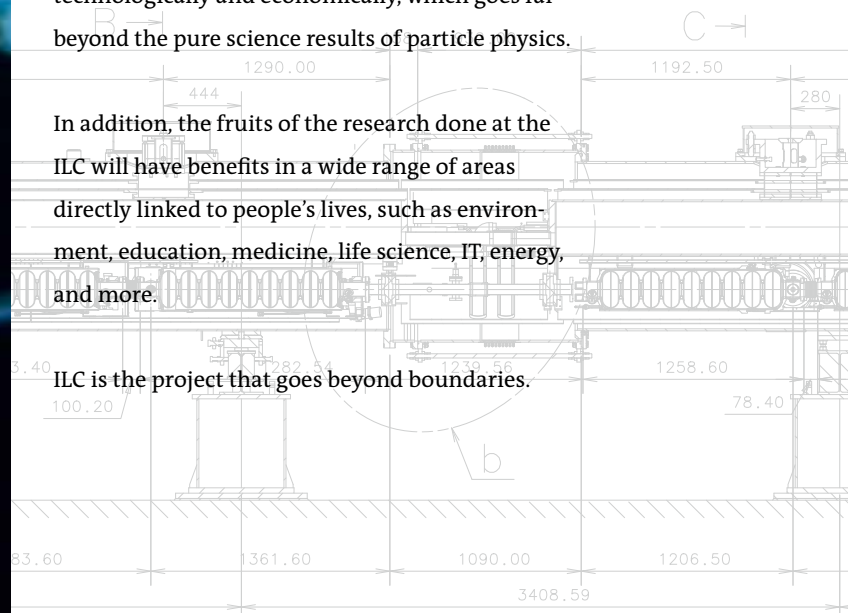



THE PROJECT THAT ATTRACTS PEOPLE

Particle physics inspires. Particle physicists are on a quest to solve the universal questions – the mysteries of the universe – by studying fundamental laws of nature. They are working together across time zones, borders and languages. This cooperation across the world produced the World Wide Web; the ILC may catalyze other ground-breaking technologies.

The ILC will provide a melting pot of the world's wisdom, attracting some of the best minds in science and technology. These great minds will continue to advance technology and yield many applications in science and industry.

The ILC will also attract people who wish to fulfill their intellectual curiosity, and to share the excitement of the science.

THE PROJECT THAT NURTURES THE NEXT GENERATION

Today at laboratories and universities around the world, several hundred students, under the guidance of senior scientists and engineers, are already contributing to the ILC. The international nature of particle physics provides younger generations with a working environment in which the experience and knowledge of different cultures are harnessed towards a common goal.

The ILC allows us to train future generations of scientists and engineers. But the ILC is not an island; ILC scientists come from other projects and work on other projects in parallel. Also, more than half of the students who obtain their PhD in particle physics go on to work for high-tech industry, financial institutions, and information technology companies. There is high demand for their talents because of their broad array of skills, as well as their physics knowledge. This benefits all of us.

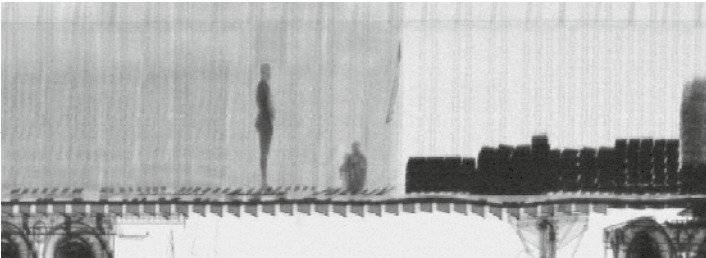
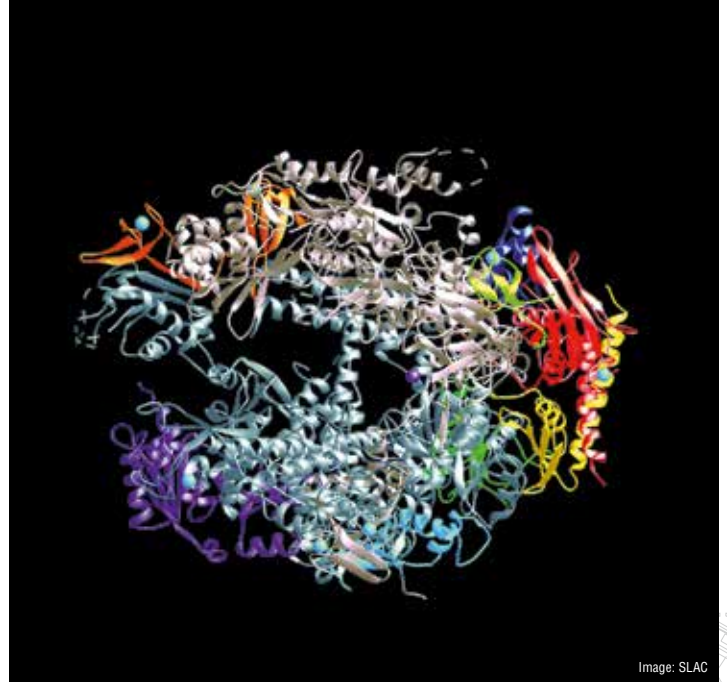

THE PROJECT THAT PUSHES TECHNOLOGY AND OTHER SCIENCES

The first *Free-Electron Lasers* (FELs) now being built or in operation in the US, Japan and Germany are direct consequences of linear-collider research. Light sources like these FELs have brought important advances in many sciences over the past decades, leading to many applications in materials science, drugs research and even the arts. Superconducting technology should also advance work on *Energy Recovery Linacs* (ERLs), permitting substantial savings in size and cost. The ILC technology can also be applied to the acceleration of protons and nuclei, which can lead to a wide range of studies on biological properties.

The ILC detectors must deliver exquisite precision. A hallmark of the ILC detectors is their fine granularity. These detectors are 3-D imaging devices that enable unprecedented study of the physics processes. Imaging calorimeters developed for the ILC, for example, are already being used in the development of proton-computed tomography for the treatment of cancer. This is just one of the societal “spin-offs” that the ILC detector development can already point to.

Fundamental research in particle physics is done to advance the boundaries of our knowledge of the Universe, not with the aim to serve other sciences or technologies. However, the track record shows that numerous applications in materials science, nuclear science, chemistry, structural biology and environmental science have already taken place. Many of these will have direct applications on everyday life.

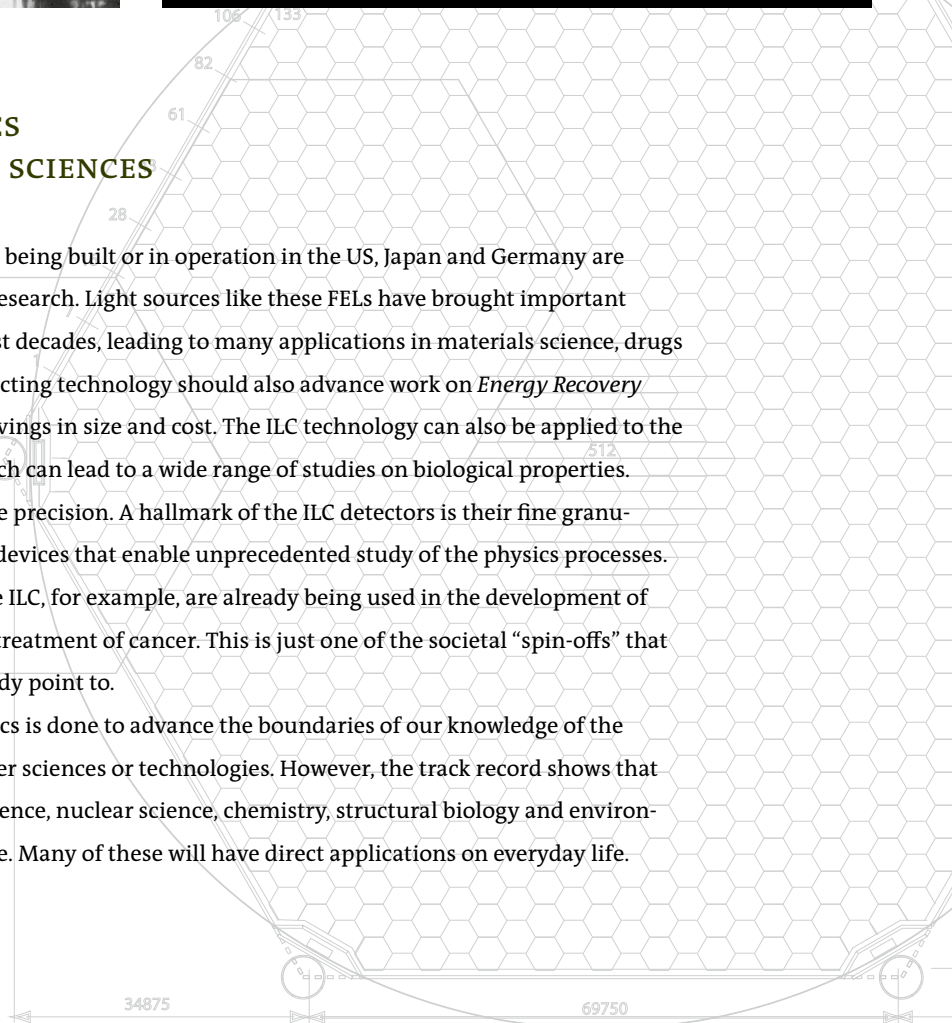

THE PROJECT THAT HAS ECONOMIC IMPACT AS ITS HOME

Particle physics has been the source of many innovations. Many of those – medical diagnostics and therapy and the World Wide Web are two striking examples – have changed the way we live and do our business. History tells us that a tool for the future, such as the ILC, should be the source of yet more technological breakthroughs.

Independent experts have estimated that the social and economic impact of hosting this highly visible and prestigious facility will be great. Thousands of jobs will be created locally to directly and indirectly support the construction of the ILC and then its research programs, and there will be many other benefits from having a large world-famous science facility in the area.

The campus that will grow around the ILC site will be a future home for scientists, engineers, students and their families from around the world. The campus – which can become a science city – needs to fulfil the needs of people from different cultures, such as education, medical and social services, and leisure pursuits and amusements. Those needs will definitely create significant impact on the ILC construction region and beyond, both economically and culturally.

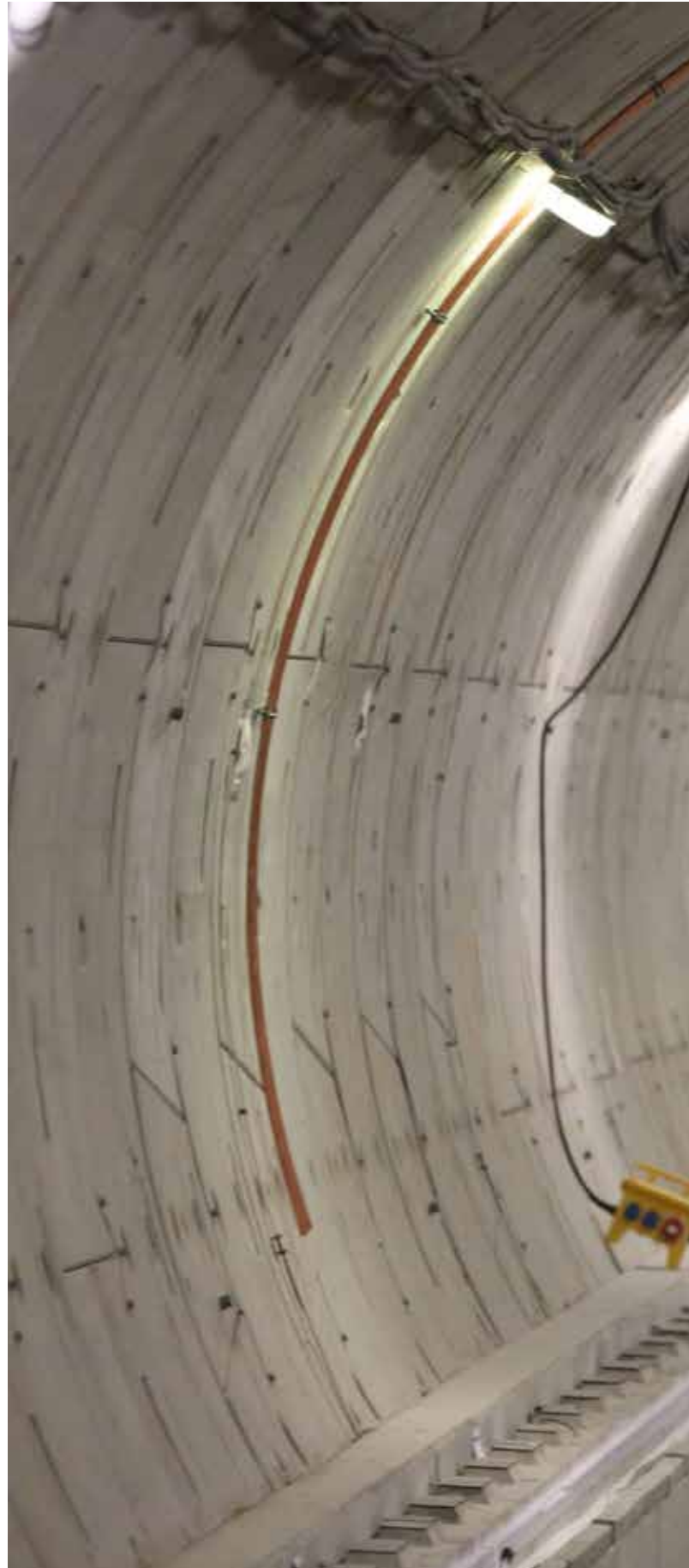



ISSUED BY

ilc *international linear collider*

WWW.LINEARCOLLIDER.ORG

ISBN 978-3-935702-79-9

Argonne National Laboratory: ANL-HEP-TR-13-20
Brookhaven National Laboratory: BNL-100603-2013-IR
CEA/irfu: IRFU-13-59
CERN: CERN-ATS-2013-037
Cockcroft Institute: Cockcroft-13-10
Cornell University: CLNS 13/2085
DESY: DESY 13-062
Fermilab: FERMILAB TM-2554
IHEP: IHEP-AC-ILC-2013-001
ILC report: ILC-REPORT-2013-040

INFN: INFN-13-04/LNF
JAI: JAI-2013-001
JINR: JINR E9-2013-35
JLab: JLAB-R-2013-01
KEK: KEK Report 2013-1
KNU: KNU/CHEP-ILC-2013-1
LLNL: LLNL-TR-635539
SLAC: SLAC-R-1004
ILC HiGrade: ILC-HiGrade-Report-2013-003