

Development of Laparoscopic Surgery Training System Using VR Technology

Yoichi MIYAKE

Research Center for Frontier Medical Engineering, Chiba University
1-33 Yayoi-cho, Inage-ku, Chiba, 263-8522, Japan
e-mail address: miyake@faculty.chiba-u.jp

Abstract

It is well known that surgeons are required to learn many skills and to take many medical training for diagnosis and surgery. Traditionally, the medical doctors have been learned from the anatomy of patients, dead body, animals and simple abdomen. In recent years, medical training system based on the VR (Virtual Reality) technologies became popular for remarkable development of the computer and graphic technologies. In our laboratories, we have developed surgical simulators for medical training such as central venous catheter placement, lumbar puncture, incision and laparoscopic surgery using VR technologies. We have also developed spectral endoscopes cooperation with Fujinon co.ltd. and laparoscopic surgery support systems by using image projected onto the abdomen. In this paper, these developed surgical simulator and a new endoscopes are introduced and some clinical applications are presented.

1. Introduction

Figure 1 shows education and training systems for medicine. In Japan, almost student of medical school enter it directly from high school after overcoming difficult entrance examination. They must pass The National Examination for Medical Practitioners to get a medical license after fundamental education of medicine for six years. They learn various kinds of medical practitioners during the internship for two years after get a license. Then, they must do training and clinical examination for medical specialist, and continue Lifelong integrated education for ideal medicine.

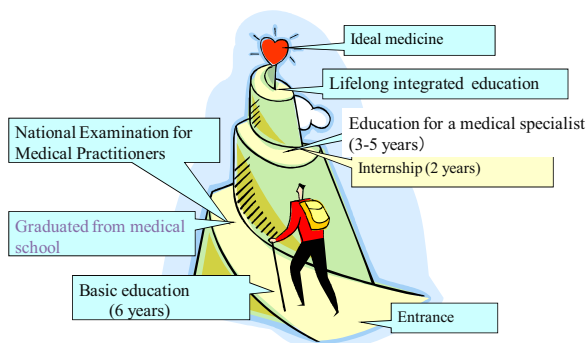

Figure 1 Education and training system for medicine in Japan (by Prof. M.Tanabe, Chiba University Hospital.)

During their training, one of the most fundamental skills is central venous catheter placement and lumbar puncture. For a long time, an anatomical model of the human body has been used for training as shown in Fig.2.



Figure 2 Anatomical model of the human body for training of central venous catheter (in Chiba University Hospital)

Anatomical model are made with realistic in shape, color and also touch of the surface. However, these human body model cannot use repeatedly and very expensive for training.

Therefore, in recent years various kinds of medical training systems used computer graphics and VR technologies, for example injection on the arm have been proposed on the market for clinical use. These systems, however, are simple and are not based on the practical CT image of human body. In our laboratories, we are developing medical training system based on the CT image and the practical measurement of an elasticity in living body for calculation of haptic texture.⁽¹⁻⁵⁾

In this paper, our recent works on the medical training and supporting systems are presented as follows:

- (1) Development of injection training system for central venous catheter placement and lumbar puncture
- (2) Laparoscopic surgery training system
- (3) Laparoscopic surgery support system used projection image
- (4) Development of spectral endoscopes

2. Development of Medical Training system

2.1 Training system for central venous catheter placement and lumbar puncture

Central venous catheter placement (CVCP) is one of the most important skills for medicine and used frequently in a

clinical examination, for example, the intravenous hyperalimentation of patients who cannot eat any food. On the other hand, lumbar puncture is also important skills for medicine to collect the cerebrospinal fluid and anesthesia. The system consists of PC, PHANToM haptic device (SensAble Technology) and stereo glasses (STREOGRAPHICS) as shown in Fig.3.

The slice images of male breast and spinal column were taken by high resolution CT scanner with 512x512x390 pixels in Chiba University Hospital. Marching cubes algorithm was applied to the volume to extract surface of vein, lung, skin and bone. Marching cubes algorithm creates surface polygons in each voxel by comparing the value with neighboring voxels.

This system realizes the palpation, injection phase of catheter placement and lumbar puncture as the three-dimensional virtual human displayed on the CRT monitor as shown in Figs.4 and 7. The horizontal and vertical sections can be watched simultaneously in the lumbar puncture. The PHANToM haptic device can produce a sense of touch, friction, viscosity and programmable reaction force. In the designing of this system, the relationship between reaction force and displacement was measured by using PHANToM as shown in Fig.5. Example of haptic texture measured by this method is shown in Fig. 6. In the figure, hardness is represented as gray tone from white (hard) to black(soft).

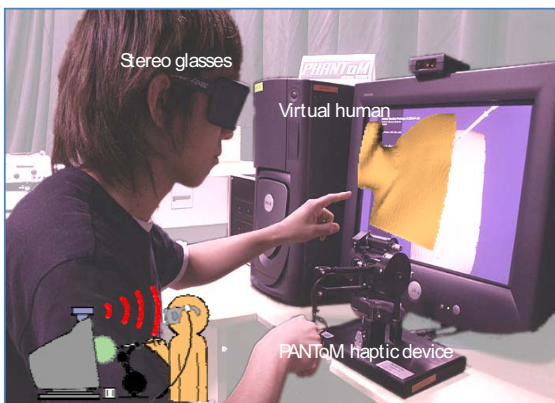

Figure 3 Developed training system of central venous catheter placement

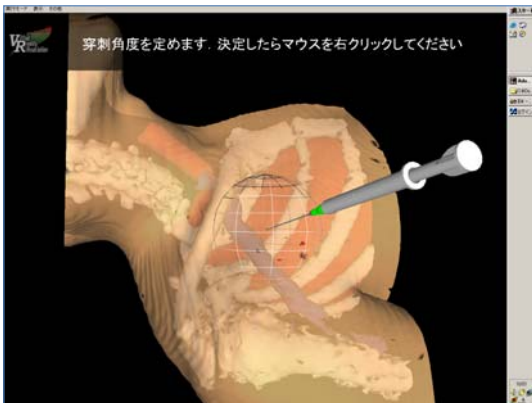

Figure 4 Displayed three-dimensional virtual human and injection



Figure 5 Measurement of the hardness and deformation of skin used PHANToM haptic device



Figure 6 Haptic texture of the lumbar (left) and breast (right)

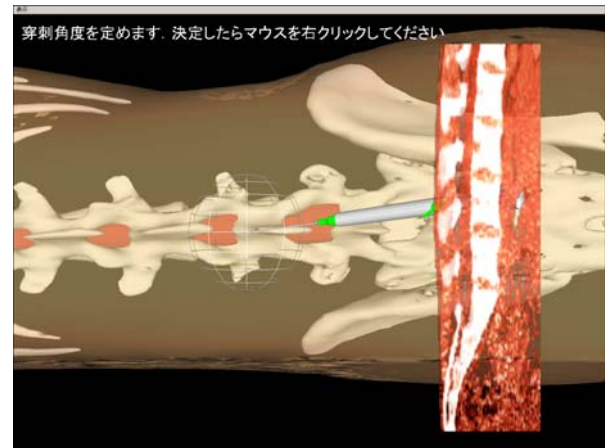

Figure 7 Developed training system for lumbar puncture

Our developed training system for central venous catheter placement and lumbar puncture has characteristics as follows:

1. Haptic feedback in palpation and injection phase.
2. Three-dimensional virtual human with same size of real human is displayed on the CRT monitor by using stereoscopic glasses.
3. The virtual human has correct anatomy taken by CT images and users can change its viewing angle arbitrary.
4. It is possible to change the transparency of skin for learning the anatomy.

5. The training process can record and check the training process.
6. The surface of skin is deformed interactively at the palpation and injection phase.

Two training systems developed in our laboratories are now using at the medical training center of Chiba University Hospital.

2.2 Laparoscopic surgery training system

Laparoscopic surgery as shown in Fig.7 has been widely used to remove a pain and damage to the patient. However, surgeon is required to have high skill for this surgery since the limited viewing angle and resolution of laparoscopes. Therefore it is necessary to accumulate various experiences for this surgery. In our laboratories, we are developing the training systems for laparoscopic surgery of cholecystectomy (LAP-C). In developing of this system, at first, it is necessary to produce a realistic virtual environment with similar feeling in the practical surgery. Then we have developed the real-time deformation model of liver based on structural mechanics.

Finite Element Method (FEM) has been widely used to simulate organ deformations with high accuracy. However, it is difficult to realize real-time deformation since the large scale matrix operations is required in FEM. We introduced deformation model⁽⁶⁾ (named Beam model) of liver based on the beam of structural mechanics as shown in Fig.8 for real time deformation.



Figure 7 Laparoscopic surgery

In this model, the deformation can be calculated by straining the coordinate axis (coordinate space) based on the assumption that the beam is located at a center axis of the coordinate space. The beam is bended by action of the force on the liver.

As the beam is straight line, the computational cost for deriving the bend is very small compare to the FEM based on the three-dimensional deformation.

Figure 9 shows comparison of deformation between FEM and Beam model for three different deformation of liver. We confirmed that the efficiency of Beam model in both computational cost and accuracy of deformation.

Figure 10 shows implemented Beam model for the laparoscopic surgery training system with two forceps. In our laboratories we are also developing the surgical incision training system⁽⁷⁾ based on the six degree of

freedom haptic rendering system with three rotation and three translation which can be rendered the cut, friction and clamping force acting on a surgical knife. We consider to implement both incision and deformation models to laparoscopic surgery training system.

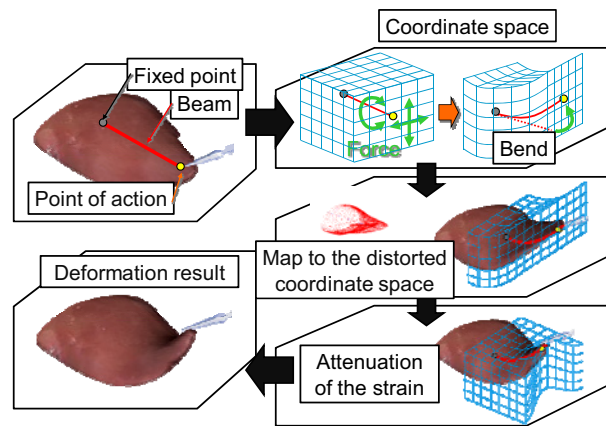

Figure 8 Beam model of liver based structural mechanics

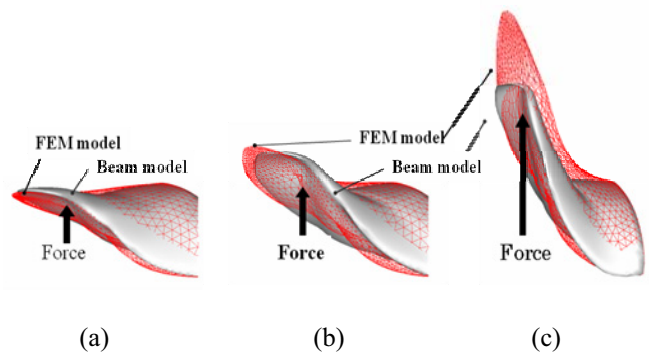

Figure 9 Deformation of liver by FEM model (Wire) and Beam model. (a) Small deformation (25mm), (b) Middle deformation (56mm), (c) Large deformation (126mm)

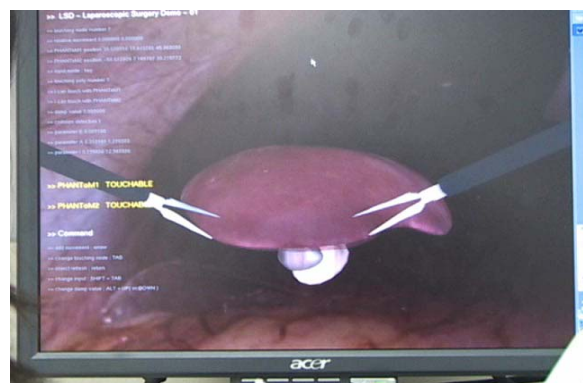

Figure 10 Implemented Beam model for laparoscopic surgery training system

3. Laparoscopic surgery support system used projection display

Laparoscopic surgery has been widely used as minimal invasive surgery. However, surgeon is required to have high skill for this surgery as described in a previous section. In order to avoid the accident during the operation

due to the limited field of view of the laparoscope in the abdominal cavity, we propose a new laparoscopic surgery method by projected laparoscopic image on the abdominal region as shown in Fig.11.⁽⁸⁾

In this system, a surgeon can perceive laparoscopic image of organ as 3D image by using a stereo projector. Though the projected image is distorted since the abdominal surface is not flat, our proposed system can correct the shape of the projected image in real time by acquiring the shape of abdominal surface and the position of the surgeon's head. As we also have developed projector-based color simulator, it is possible to reproduce the exact color of projected laparoscopic images⁽⁹⁾. We confirmed that the validity of laparoscopic surgery support system developed in our laboratories by the experiment used fig.

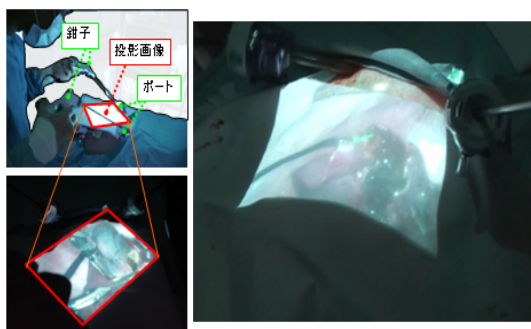

Figure 11 Laparoscopic surgery support system by using projected image

4. Development of spectral endoscopes

4.1 Spectral reflectance of membrane

A color image taken by electronic endoscopes gives important information for diagnosis of various kinds of rectal and stomach diseases. Color reproduction of electronic endoscopes, however, is not enough to diagnose the early stage of the diagnosis. Therefore, improvement of color reproduction in electronic endoscopes has been required. We have developed the endoscope spectrophotometer to measure the spectral reflectance of gastric mucous membrane in 1988.⁽¹⁰⁾ Figure 12 shows the measured reflectance spectra of rectal membrane after the noise reduction processing and calibration used a standard white plate. It is clear that these spectra have absorption between 520nm and 600nm by the spectral characteristics of hemoglobin. These measured spectra of the gastric and rectal mucous membrane have been analyzed by principal component analysis and we showed that the reflectance spectra can adequately be described by only three principal components.⁽¹¹⁾

Figure 12 shows the measured reflectance spectra of rectal membrane after the noise reduction processing and calibration used a standard white plate. Figure 13 shows three principal components and the cumulative contribution ratio of three principal components, namely this result describes that 99.7 % of the reflection spectra of rectal membrane can be expressed by only three principal components. This shows that the reflectance spectra of rectal mucous membrane can be expressed as a linear combination of three eigenvectors obtained by principal component analysis and RGB signal from CCD of

endoscopes. Wiener estimation method can be also applied to estimate the reflection spectra of those membranes.

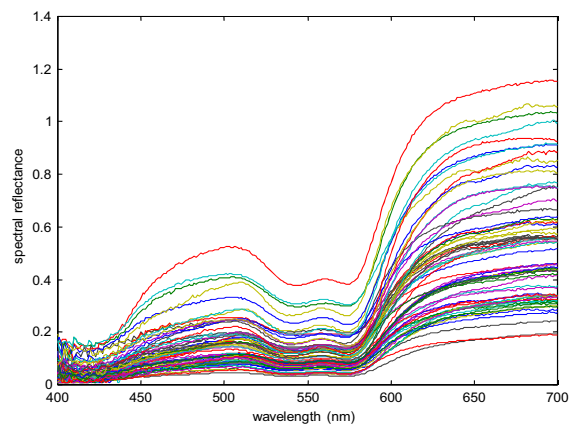

Figure 12 Spectral reflectance of rectal membrane measured by endoscopic spectral photometer

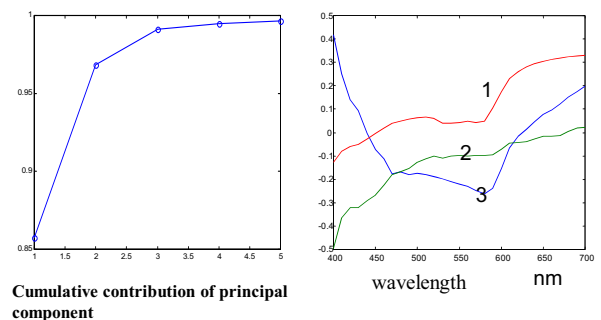

Figure 13 Principal component analysis of spectral reflectance of Rectal membrane

4.2 Color reproduction simulator for electronic endoscopes

The color reproduction characteristics of electronic endoscopes are dependent on many factors such as spectral radiant distribution of illuminant $E(\lambda)$, spectral sensitivity of CCD $S(\lambda)$, spectral transmittance of filters $f_i(\lambda)$ ($i = r, g, b$), and spectral transmittance of imaging lenses $L(\lambda)$. Then the output signal $v_i(x,y)$ ($i = r, g, b$) can be calculated as

$$v_i(x,y) = \int E(\lambda)S(\lambda)f_i(\lambda)L(\lambda)O(\lambda,x,y)d\lambda \quad (1)$$

$$i = r, g, b$$

where, $O(\lambda, x,y)$ is a spectral reflectance of the mucous membrane and (x,y) is coordinate of the object.

From principal component analysis and the Wiener estimation method, reflection spectra of the object $O(\lambda, x,y)$ can be estimated from three eigen vectors obtained by the principal components of spectral reflectance of a rectal or Wiener matrix. In the Wiener estimation, at first, we measure R , G , and B digital values

(camera output), in Eq. (1), where R, G, B correspond to v_i of the Macbeth Color Checker using electronic endoscopes. Secondly, we measure the precise reflectance spectra of each color patch with a spectrophotometer. Using these two data sets, we can calculate a system matrix to estimate spectral reflectance of the object by the Wiener estimation method. Therefore, we can calculate spectral reflectance of all pixel in the stomach $O(\lambda, x, y)$ in the Eq.(1). The result was applied to estimate the color reproduction of electronic endoscopes under different illuminants, optimum spectral sensitivity of CCD and designing of spectral transmittance of a color filter of electronic endoscope by computer simulation. (12,13)

4.3 Developed spectral endoscopes and diagnosis using a spectral image

Figure 14 shows the flow diagram of developed spectral endoscope.⁽¹⁴⁾ Noise reduction and gamma correction are done to the RGB signals from the CCD.

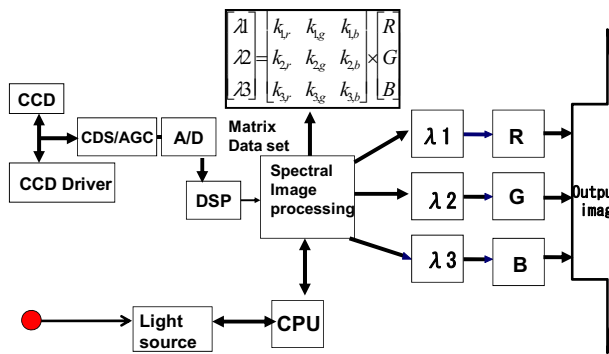

Figure 14 Flow diagram of spectral endoscopes

The spectral image is estimated by 3 x 3 matrices from corrected RGB signals. The dataset of coefficients of these matrices are calculated by the Wiener estimation method. For example, in the case of $\lambda_1 = 500nm, \lambda_2 = 620nm, \text{ and } \lambda_3 = 650nm$ These spectral images can be calculated as follow:

$$\begin{bmatrix} \lambda_1 \\ \lambda_2 \\ \lambda_3 \end{bmatrix} = \begin{bmatrix} -0.00119 & 0.002346 & 0.0016 \\ 0.004022 & 0.000068 & -0.00097 \\ 0.005152 & -0.00192 & 0.000088 \end{bmatrix} \begin{bmatrix} R \\ G \\ B \end{bmatrix} \quad (2)$$

Figure 15 shows the spectral image of a stomach at 400nm, 450nm, 500nm 550nm, 600nm, 650nm and 700nm calculated from the RGB image taken by electronic endoscopes.

On the other hand, Figure 16 shows that the gullet and colon membrane reproduced by three kinds of spectral image combinations. In the Figure 16, (a) is original RGB image and (b) shows the synthesized color image using spectral images at wavelength 500nm, 450nm and 410nm as the Red, Green, Blue channels, respectively.

Figure 13 (c) shows original RGB color image, and (d) is

synthesized image as R:520 nm, G:500 nm, B:405nm.

We can clearly recognize the differences between each image. The optimum selection of spectral image depends on the kinds of diseases of the membrane.

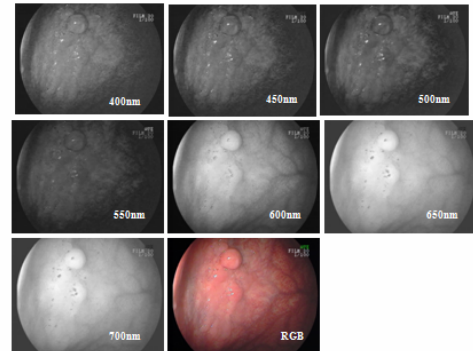

Figure 15 Spectral images taken by spectral endoscope

Therefore, many pictures with various kinds of diseases should be taken and analyzed. We are now taking and analyzing many clinical images by using developed electronic endoscopes at the Chiba University Hospital and other hospital. Our final purpose is to find the optimum combination of spectral images for the diagnosis of the early stage of diseases of the stomach, gullet, colon and rectum.

Figure 17 shows the photograph of the developed spectral endoscopes.

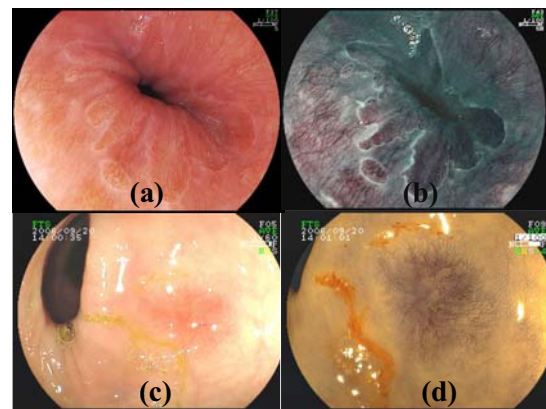

Figure 16 RGB images of gullet (a) and colon (b) (a),(b) taken by Prof. T. Kouzu, Chiba University Hospital, (c),(d) taken by Dr. Nakase, Kyoto University Hospital

4.4 Optimum combination of wavelength

In the spectral endoscopes, it is possible to reproduce a great many RGB images by the combination of different wavelength. Therefore, it is not easy to find the optimum wavelength for diagnosis of stomach diseases corresponding to Red, Green, and Blue channels. It is considered that optimum wavelength for RGB channels depends on the kind of diseases and its selection should be determined by medical doctor.

In order to decide the optimum color reproduction for diagnosis of endoscopic image, we have developed the real time color translation system as shown in Fig.18.



Figure 17 Developed spectral endoscopes

This system consists of PC and PHANToM (SensAble Technology). In this system, control of arm to six directions; left/right, up/down, in/out are available, then the wavelength corresponding to R, G, B channels can be changed by the control of the angle w_r, w_g, w_b of the arm.

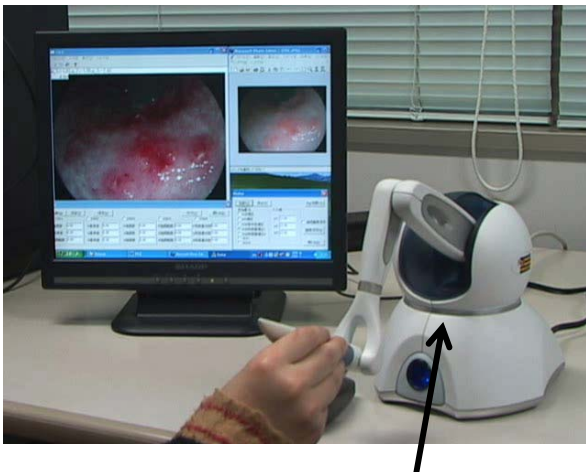

PHANToM (SensAble Technology)

Figure 18 Real time color correction and transformation system

Then the medical doctor can choose the optimum color for diagnosis. Figure 19 shows the color reproduction of the gastric mucous membrane with early stage of the cancer. It is shown that the portion of cancer is enhanced and becomes clear its boundary.

The first paper on the measurement of reflectance spectra of gastric mucous membrane was published in 1988, on the basis of the analysis of those measured reflectance spectra, a new electronic endoscopes using spectral information has been developed and clinically used to diagnose for various kinds of diseases. We recognize that the importance of the basic research on the color science and technology.

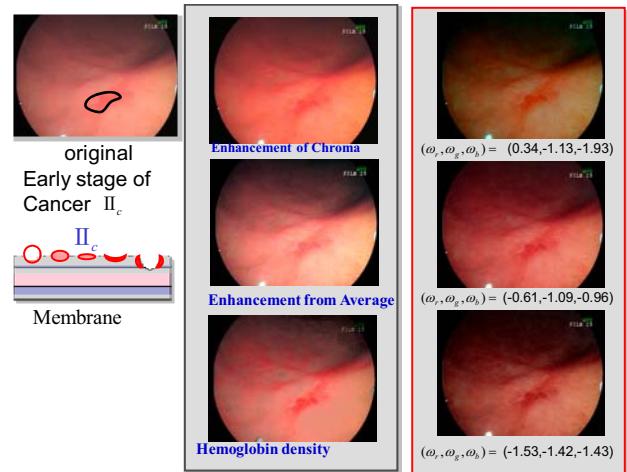

Figure 19 Six color images transformed by developed real time color transformation system used Phantom.

5. Conclusion

In this paper, we introduced our recent works on the medical training, support system and spectral endoscopes. In the medical training system, central venous catheter placement and lumbar puncture used VR technologies have developed and these systems have been used at the medical training center in Chiba University Hospital. In the training system of laparoscopic surgery for cholecystectomys, real time deformation of liver named beam model was introduced and this proposed model was implemented for real time deformation by two forceps controlled with two PHANToM. We also showed the laparoscopic surgery support system used projection display. In this system, surgeon can perceive laparoscopic image of organ as 3D image by using a stereo projector and the system can correct the shape of the projected image in real time by acquiring the shape of abdominal surface and the position of the surgeon's head. On the spectral endoscopes, it became possible to reproduce spectral image and diagnose various kinds of diseases by using spectral information.

We believe that these new techniques help the improvement of diagnosis, training of surgery and learning of skills for medicine. In the future, we consider to develop a new medical training and support system by combination of VR, spectral information and color image processing technologies.⁽¹⁵⁾

Acknowledgements

I would like to thank Dr. N.Tsumura, Dr. H.Haneishi, Dr. T.Nakaguchi, Dr. N.Tamura, Mr. T.Koishi, Mr. S.Ushiki and Miss. C.Matsukuma in our laboratories, and Mr. S Yamataka, Fujinon co.ltd., for their help to develop the medical training, supporting systems and spectral endoscopes. I would also like to express many thanks to Prof. T.Kouzu and Prof. M.Tanabe, Chiba University Hospital for their helpful suggestion and comments. A part of this research is supported by Grant in aid for scientific research by Japan Society for the Promotion of Science (No. 16200037).

References

1. N.Tamura, N.Tsumura and Y.Miyake: Simulation of the Deformation of Skin Using Continuous Deformation Model and

- Its Application to Medical Training System, *Medical Imaging Technology*, 22(1)35-40(2004). (in Japanese)
2. N.Tamura, N.Tsumura and Y.Miyake: Development of Medical Training System Using Haptic Texture, *J. J. Medical Virtual Reality*, 3(1)30-37(2004). (in Japanese)
 3. T.Koishi, N.Tamura, T.Nakaguchi, N.Tsumura and Y.Miyake: Development of Image Overlay System with Head-Tracking for VR-Based Injection Training, *J. J. Medical Virtual reality*, 4(1) 18-24(2006). (in Japanese)
 4. H.Endo, T.Nakaguchi, N.Tsumura and Y.Miyake: Directional haptic Texture for VR Injection Training System, *J. J. Medical Virtual Reality*, 4(1)11-17(2006). (in Japanese)
 5. N.Tamura: Development of VR Technologies for the Realistic Medical Training System (Ph.D. Thesis, Chiba University, 2005)
 6. T.Nakaguchi, M.Tagaya, N.Tamura, N.Tsumura and Y.Miyake: Real Time Deformation of Organ Based on Structural Mechanics for Sugical Simulator, *Proc.SPIE, Medical Imaging*, Vol.6143, 2A1-2A6 (2006).
 7. Y.Kawaguchi, T.Nakaguchi, N.Tsumura and Y.Miyake: Six Degree of Freedom Haptic Rendering for the Surgical Incision Training, *Medical Imaging Technology*, 24(4) 277-284(2006). (in Japanese)
 8. S.Ushiki, T.Koishi, T.Nakaguchi, H.Hayashi, N.Tsumura and Y.Miyake: Development of Laparoscopic Surgery Support System Used Projected Image on the Abdominal Surface, *Medical Imaging Technology*, 24(5)394-400 (2006). (in Japanese)
 9. S.Yamamoto, K.Ueda, N.Tsumura, T.Nakaguchi and Y. Miyake: Projector-Based Color Simulator for Print Industry, *IEICE Trans.*,E89(11)2962-2969(2006).
 10. Y.Miyake, T.Sekiya and T.Hara: A New Spectrophotometer for Measuring the Spectral Reflectance of Gastric Mucous Membrane, *J. Photographic Science*, 37(1)134-138(1989).
 11. T. Shiobara, S. Zhou, H. Haneishi, N. Tsumura and Y. Miyake: Improved Color Reproduction of Electronic Endoscopes, *J. Imaging Science and Technology*, 40(6)494-501(1996).
 12. N.Tsumura, T.Tanaka, H.Haneishi and Y.Miyake: Optimal Design of Mosaic Color Electronic Endoscopes, *Optics Communications*, 145,27-32(1998).
 13. T. Shiobara, H. Haneishi and Y. Miyake: Color Correction for Colorimetric Color Reproduction in an Electronic Endoscope, *Optics Communications*, 114, 57-63 (1995).
 14. Y.Miyake, T.Kouzu and S.Yamataka: Development of New Electronic Endoscopes Using the Spectral Images of an Internal Organ, *Proc.CIC13m* 31-35(2005, Scottsdale).
 15. Y.Miyake edited: Introduction of Spectral Image Processing (University of Tokyo Press, 2006) (in Japanese).

Society of Photographic Science and Technology of Japan) from 2000 to 2002 and a vice president of IS&T (The Society for Imaging Science and Technology, USA) from 2000 to 2004. He was also served as a president of The Japanese Association of Forensic Science and Technology from 1998 to 1999. He is currently served as professor and director of Research Center for Frontier Medical Engineering in Chiba University.

Yoichi MIYAKE

Professor Yoichi MIYAKE has been professor of Chiba University since 1989. He received Ph.D. from Tokyo Institute of Technology in 1978. During 1978 and 1979, he was a post doctoral fellow of Swiss Federal Institute of Technology (ETHZ). In 1997, he was a guest professor of University of Rochester. He received Charles E Ives Award (paper award) from IS&T in 1991, 2001 and 2005. He became a fellow of IS&T in 1995. He was named as Electronic Imaging Honoree of the year in 2000 from SPIE and IS&T. He became honoree member of IS&T in 2003. He published many books and original papers on the image processing, color science and image evaluations. He was served as a president of SPSTJ (The