

# User's Guide

## MSPM0 MCUs Development Guide



### ABSTRACT

This document is a good resource for finding important information about MSPM0™ microcontrollers (MCUs). This application note can serve as a reference, a starting guide, a self-learning tool, or an application-development guide.

### Table of Contents

<b>1 Overview</b>	4
<b>2 MSPM0 Online Selection</b>	5
<b>3 Software Development Instructions</b>	7
3.1 LaunchPad Setup	7
3.2 MSPM0-SDK Setup	9
3.3 SysConfig Setup	14
3.4 IDE Quick Start	20
<b>4 Hardware Design Instructions</b>	43
4.1 Obtaining a MSPM0 Package	43
4.2 Fix Pin Functions through Sysconfig	46
4.3 Schematic and PCB Attention	46
<b>5 Mass Production Instructions</b>	48
5.1 Generate Production Image	48
5.2 Program Software Tools Quick Start	49
5.3 Program Hardwares Quick Start	57
<b>6 Quality and Reliability Instructions</b>	59
6.1 Quality and Reliability Material Entrance	59
6.2 Failure Information Collection and Analysis Guidance	59
<b>7 Common Development Questions</b>	60
7.1 Unlock MCU	60
7.2 MSPM0 Program Failure	64
7.3 Reprogram with SWD Disabled	64
7.4 MCU Performs Differently in Debug and Free Run	65
7.5 Set SWD Password	65
7.6 BSL Related Questions	67
7.7 Reach Expected Current in LPM Mode	67
7.8 CCS Common Questions	67
7.9 Keil Common Questions	69
<b>8 Summary</b>	70
<b>9 Technical Documentation Resources</b>	70
9.1 Technical Reference Manuals	70
9.2 Subsystems	70
9.3 Reference Designs	71
9.4 Hardware EVM User's Guides	71
9.5 Application Notes and Others	71
<b>10 Revision History</b>	74

### List of Figures

Figure 1-1. MSPM0 Ecosystem	4
Figure 2-1. MSPM0 Device List	5
Figure 2-2. MSPM0 Important Document List	5
Figure 2-3. Device Comparison Table	6
Figure 2-4. Ordering and Quality Part View	6

Figure 3-1. MSPM0G3507 LaunchPad.....	8
Figure 3-2. Launchpad Setup View.....	8
Figure 3-3. MSPM0-SDK Download.....	9
Figure 3-4. MSPM0-SDK Install Step-by-Step.....	9
Figure 3-5. MSPM0-SDK Structure.....	10
Figure 3-6. RTOS and Nortos Code Examples.....	11
Figure 3-7. SysConfig Install.....	14
Figure 3-8. MSPM0 SysConfig.....	15
Figure 3-9. SysConfig View.....	15
Figure 3-10. Basic Operations.....	16
Figure 3-11. Project Configuration.....	16
Figure 3-12. Board View.....	17
Figure 3-13. NONMAIN View.....	17
Figure 3-14. SYSCTL View.....	18
Figure 3-15. Peripherals View.....	19
Figure 3-16. CCS Key Install Steps.....	21
Figure 3-17. Import CCS Project.....	22
Figure 3-18. CCS Project Overview.....	23
Figure 3-19. Change Debugger Selection.....	23
Figure 3-20. Build, Debug and Run the Code.....	24
Figure 3-21. Commonly Used Debug Functions.....	24
Figure 3-22. Migrating Between MSPM0 Derivatives.....	25
Figure 3-23. Generate Hex File.....	26
Figure 3-24. Programming NONMAIN.....	26
Figure 3-25. Add MSPM0 SDK to IAR.....	27
Figure 3-26. Install SysConfig for MSPM0.....	28
Figure 3-27. Import a SDK Example.....	29
Figure 3-28. Use SysConfig With IAR.....	29
Figure 3-29. Download and Debug.....	30
Figure 3-30. Migrating Between MSPM0 Derivatives.....	31
Figure 3-31. Generate Hex Files.....	32
Figure 3-32. Program NONMAIN.....	32
Figure 3-33. Open Pack Installer.....	33
Figure 3-34. Search Device.....	33
Figure 3-35. Install Device Pack.....	34
Figure 3-36. Approve the License.....	34
Figure 3-37. Edit syscfg.bat.....	35
Figure 3-38. Edit MSPM0_SDK_syscfg_menu_import.cfg.....	35
Figure 3-39. Keil Customize Tools.....	35
Figure 3-40. Import MSPM0_SDK_syscfg_menu_import.cfg File.....	36
Figure 3-41. Finish SysConfig Setup.....	36
Figure 3-42. Open Project.....	36
Figure 3-43. Select Keil Project.....	37
Figure 3-44. Open .syscfg file.....	38
Figure 3-45. Open Options for Target.....	38
Figure 3-46. Select the Debug Pane.....	39
Figure 3-47. Check the Setting of XDS110 Probe.....	39
Figure 3-48. Check the Setting of J-Link Probe.....	40
Figure 3-49. Flash Download Setting.....	40
Figure 3-50. Download Project.....	41
Figure 3-51. Build RTOS Example Under Keil.....	41
Figure 3-52. Migrating Between MSPM0 Derivatives.....	42
Figure 3-53. Generate Hex Files.....	42
Figure 3-54. Program NONMAIN.....	43
Figure 4-1. Ultra Librarian Tool Start Page.....	43
Figure 4-2. Ultra Librarian Tool Device Selection.....	43
Figure 4-3. Ultra Librarian Tool CAD Download.....	44
Figure 4-4. Run Altium Designer Script.....	44
Figure 4-5. Generate Library.....	45
Figure 4-6. Select Footprint.....	45
Figure 4-7. Import Library.....	45
Figure 4-8. Generate Peripherals and Pin Assignments File.....	46
Figure 4-9. MSPM0 Minimum System.....	46

Figure 4-10. MSPM0 Schematic.....	47
Figure 5-1. Program Software and Tools.....	48
Figure 5-2. Program Through SWD.....	49
Figure 5-3. Program Through Bootloader.....	50
Figure 5-4. J-Flash Quick Start.....	51
Figure 5-5. GangPro-ARM Install.....	52
Figure 5-6. C-Gang Pin Assignment.....	53
Figure 5-7. Online Program.....	54
Figure 5-8. Enable Non-Main Programming.....	55
Figure 5-9. Save Image.....	55
Figure 5-10. Go Button Setting.....	56
Figure 5-11. Offline Downloading.....	56
Figure 5-12. Pin Connection of TMDSEMU110-U.....	57
Figure 5-13. XDS110 Onboard.....	57
Figure 5-14. LP-XDS110ET.....	58
Figure 7-1. E2E Online.....	60
Figure 7-2. CCS Error.....	60
Figure 7-3. Unlock Through GUI.....	62
Figure 7-4. Unlock Through Uniflash.....	63
Figure 7-5. Unlock Through CCS.....	63
Figure 7-6. Device Manager View.....	64
Figure 7-7. Disable BSL.....	65
Figure 7-8. Enable SWD Password.....	66
Figure 7-9. Clear SWD Password.....	67
Figure 7-10. Change Optimization Level.....	68
Figure 7-11. Copy Keil Example Out of SDK.....	69

## List of Tables

Table 3-1. MSPM0 Development Chain.....	7
Table 3-2. MSPM0 Debugger Comparison.....	7
Table 3-3. MSPM0 Example Coverage.....	11
Table 3-4. MSPM0 Supported IDEs Overview.....	20
Table 5-1. Product File Generated by IDE.....	48
Table 5-2. XDS110 Debugger Summary.....	57
Table 7-1. Tools Suggested Version.....	60
Table 7-2. Unlock Commands.....	61
Table 7-3. Unlock Method Selection.....	61

## Trademarks

MSPM0™, LaunchPad™, Code Composer Studio™, SimpleLink™, C2000™, and TIVA™ are trademarks of Texas Instruments.

Arm® and Cortex® are registered trademarks of Arm Limited.

are registered trademarks of Arm Limited (or its subsidiaries) in the US and/or elsewhere.

All trademarks are the property of their respective owners.

## 1 Overview

The MSPM0 microcontroller family uses an enhanced Arm® Cortex®-M0+ 32-bit processor, operating at up to 80MHz and supports both industrial and automotive applications (with AEC-Q100 FS-QM and ASIL-B qualification). Designers can easily find a cost-effective MCU within the broad portfolio, which offers pin-to-pin compatibility across a wide range of memory and package sizes. TI's leadership in integrated precision analog endows this device family with the high precision and speed ADC, zero-drift chopper OPA, DAC, COMP, and so forth.

MSPM0 MCUs are supported by an extensive hardware and software ecosystem. The ecosystem includes easy-to-use development tools, affordable evaluation boards, and a wide range of embedded software kits, drivers, and examples. This document describes these factors into four topics: [MSPM0 Online Selection](#), [Software Development Instructions](#), [Hardware Design Instructions](#) and [Mass Production Instructions](#).

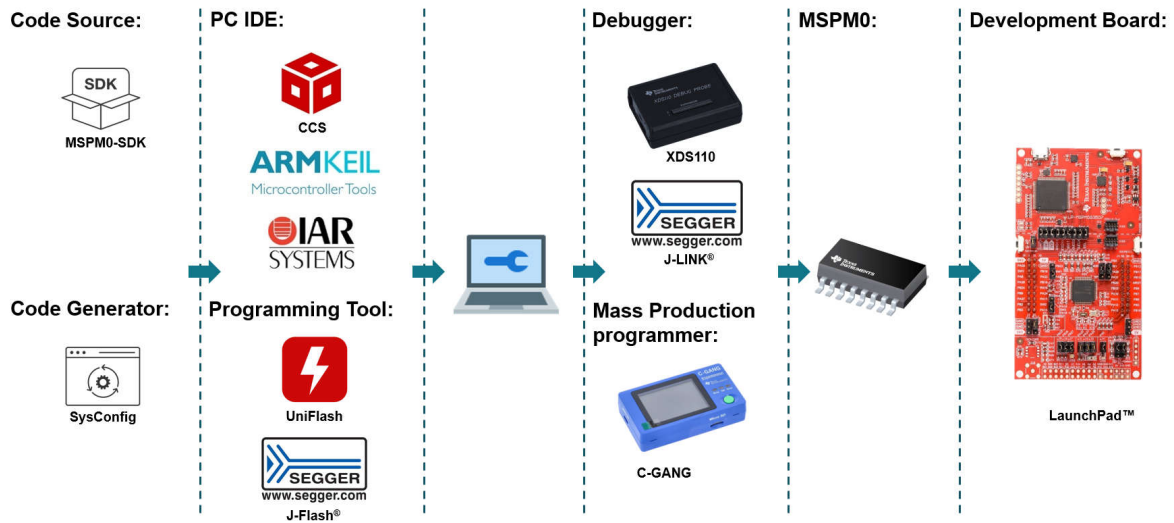

**Figure 1-1. MSPM0 Ecosystem**

Besides of common development topics, we also list all the [Technical Documentation Resources](#), [quality and reliability resources](#) and [common development questions](#). Please refer to the table of contents to choose your interested topic for reference.

## 2 MSPM0 Online Selection

This step discusses how to find an MSPM0 orderable number.

Visit the [Arm Cortex-M0+ MCUs product page](#) to view the list of MSPM0 devices. After navigating to this page, use the filters on the left to perform an initial screening based on MCU peripheral requirements, or directly navigate to the device page using the search box on the left side of the page.

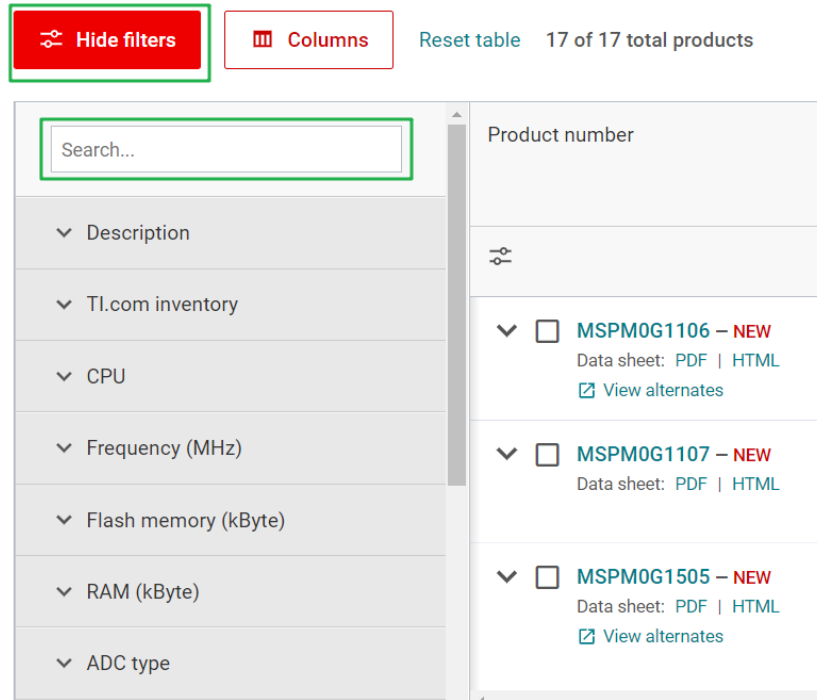

Figure 2-1. MSPM0 Device List

After navigating to the device page, more specification or functional details for a specific product are available. The key documents are the data sheet, technical reference manual (TRM), and errata. The device-specific data sheet introduces the parameters and functional data information for the MSPM0. The device-specific TRM introduces the application method and characteristics of a MSPM0 device. The device-specific errata shows descriptions of MSPM0 related series or versions.



Figure 2-2. MSPM0 Important Document List

Figure 2-3 shows the *Device Comparison* table in a device-specific data sheet. A user can compare different part numbers using this table.

### 5 Device Comparison

Table 5-1. Device Comparison

DEVICE NAME <sup>(1)</sup> <sup>(2)</sup>	FLASH / SRAM (KB)	QUAL <sup>(3)</sup>	ADC CH.	COMP	OPA	GPAMP	UART/I2C/SPI	TIMG	GPIOs	5-V TOL. IO	PACKAGE [BODY SIZE] <sup>(4)</sup>
MSPM0L1306xRHB	64 / 4	T/S	10	1	2	1	2 / 2 / 1	4	28	2	32 VQFN [5 mm × 5 mm] <sup>(5)</sup>
MSM0L1305xRHB	32 / 4										
MSM0L1304xRHB	16 / 2										
MSPM0L1306xDGS28	64 / 4	T/S	10	1	2	1	2 / 2 / 1	4	24	2	28 VSSOP [7.1 mm × 3 mm]
MSPM0L1305xDGS28	32 / 4										
MSPM0L1304xDGS28	16 / 2										
MSPM0L1346xDGS28	64 / 4	T	9						22		
MSPM0L1345xDGS28	32 / 4										

Figure 2-3. Device Comparison Table

See the *Ordering and Quality* page on the device page to view the orderable part number and the reference price.

MSPM0L1306 PREVIEW Data sheet Order now

Product details | Technical documentation | Design & development | **Ordering & quality** | Support & training

Ordering & quality

Part number ↓↑	Buy	Ti.com inventory ↓↑	Qty   Price (USD) ↓↑	Package qty   Carrier ↓↑
XMSM0L1306SDGS20R ACTIVE	<input type="text" value="Enter quantity"/> <span>Add to cart</span> Limit: 5	93	1ku   <span>▼</span>	1   LARGE T&R Select
XMSM0L1306SDGS28R ACTIVE	<input type="text" value="Enter quantity"/> <span>Add to cart</span> Limit: 10	170	1ku   <span>▼</span>	5,000   LARGE T&R

Figure 2-4. Ordering and Quality Part View

## 3 Software Development Instructions

[Table 3-1](#) lists a summary of all the required components in an MSPM0 development chain. Devices are described individually in the following sections. Users can also refer to [Section 7](#), when encountering problems in MSPM0 development.

**Table 3-1. MSPM0 Development Chain**

IDE	SysConfig (Code Generator GUI)	SDK	Debugger	Hardware
<a href="#">CCS with SysConfig integrated</a>	Standalone <a href="#">SysConfig</a>	<a href="#">MSPM0 SDK</a>	Launchpad with XDS110 On-Board	
Keil			<a href="#">XDS110</a>	Customized board
IAR			J-Link	

### 3.1 LaunchPad Setup

#### 3.1.1 Debugger Selection

This section summarizes different debuggers that support MSPM0 devices. The XDS110 debuggers are owned by TI, which support more functions, as compared to general debuggers. For more details about XDS110 debuggers, see [Section 5.3](#).

**Table 3-2. MSPM0 Debugger Comparison**

Features	XDS110 ( <a href="#">TMDSEMU110-U</a> )	XDS110 On-Board	J-Link
cJTAG (SBW)	√	√	√
BSL tool	√	√	
Backchannel UART	√	√	
Power supply	1.8 - 3.6V	3.3 - 5V	5V
IDE	CCS, IAR, Keil	CCS, IAR, Keil	CCS, IAR, Keil

### 3.1.2 LaunchPad Introduction

TI recommends to start MSPM0 development with LaunchPad™. **Figure 3-1** shows an overview of the LaunchPad. The LaunchPad contains the MCU and a XDS110 debugger. A user can use a debugger such as a J-Link to debug the MCU after removing the jumpers.

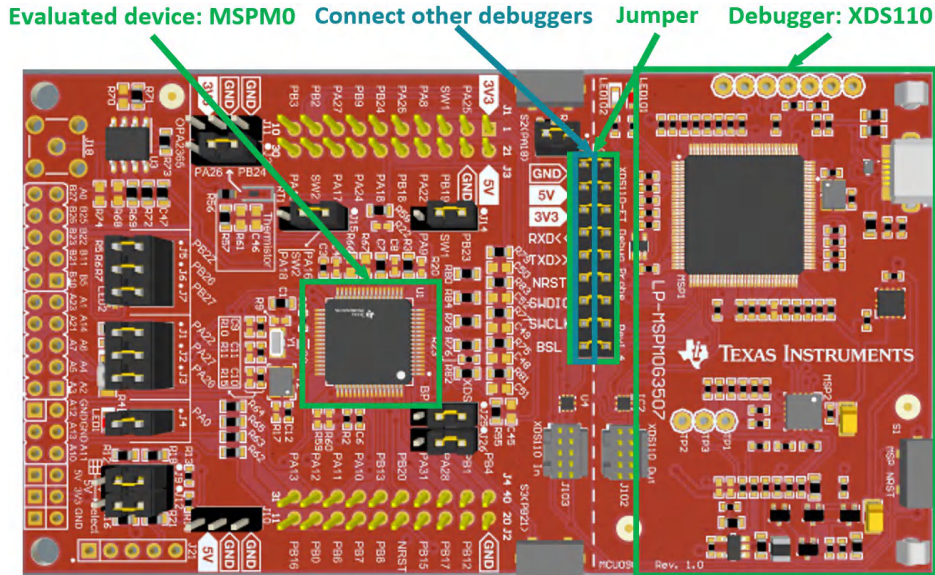

**Figure 3-1. MSPM0G3507 LaunchPad**

A real LaunchPad setup condition is shown in **Figure 3-1**, which can be debugged and powered with a USB port.

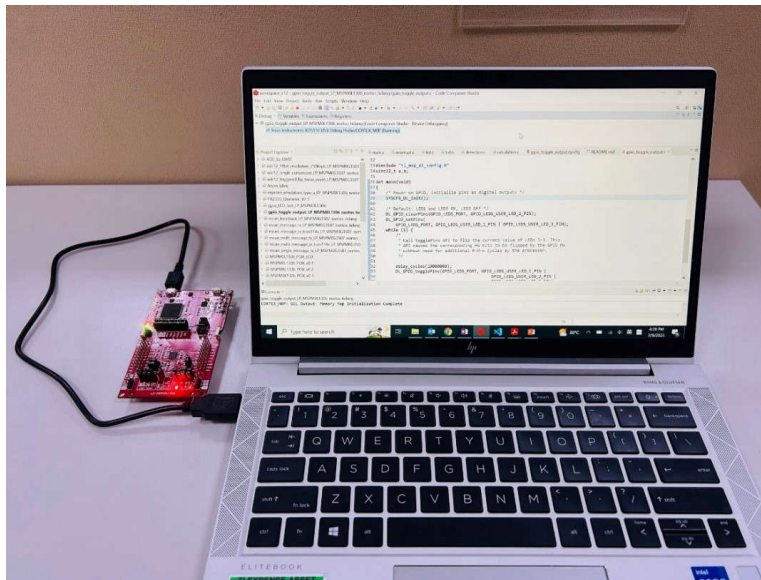

**Figure 3-2. Launchpad Setup View**

For all the orderable LaunchPad, refer to [Arm® Cortex®-M0+ MCUs design & development](#) webpage. All the LaunchPad user's guides are also listed in [Section 9.4](#).



### 3.2 MSPM0-SDK Setup

The MSPM0-SDK provides the ultimate collection of software, tools, and documentation to accelerate the development of applications for the MSPM0 MCU platform. The MSPM0-SDK provides a consistent and cohesive experience with a wide variety of drivers, libraries, and examples under a single software package.

#### 3.2.1 MSPM0-SDK Installation

This section details steps to install MSPM0-SDK. After installation, the default SDK directory path is: `C:\ti\mspm0_sdk_x_xx_xx_xx`.

1. Before downloading, a myTI account is required. Register for a myTI account [here](#).
2. Download the latest MSPM0-SDK from the [product page](#). Click *Download options*, select the operating system, and click the file name to start downloading.

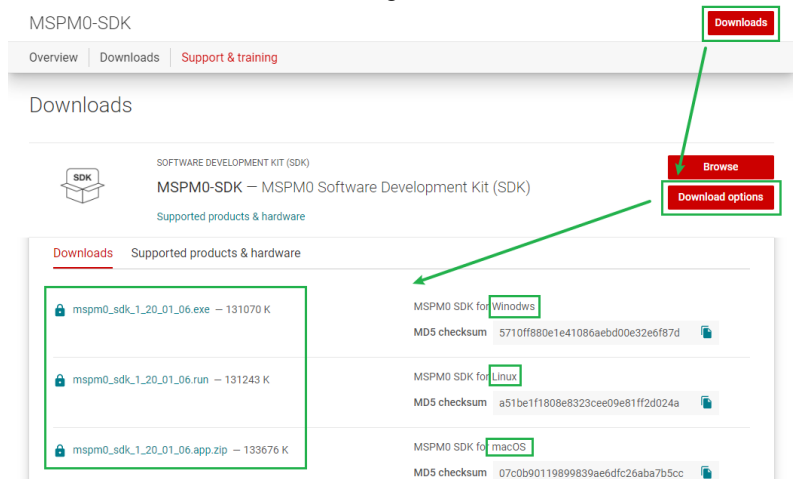

**Figure 3-3. MSPM0-SDK Download**

3. After downloading, follow the steps in [Figure 3-4](#) to finish installation.

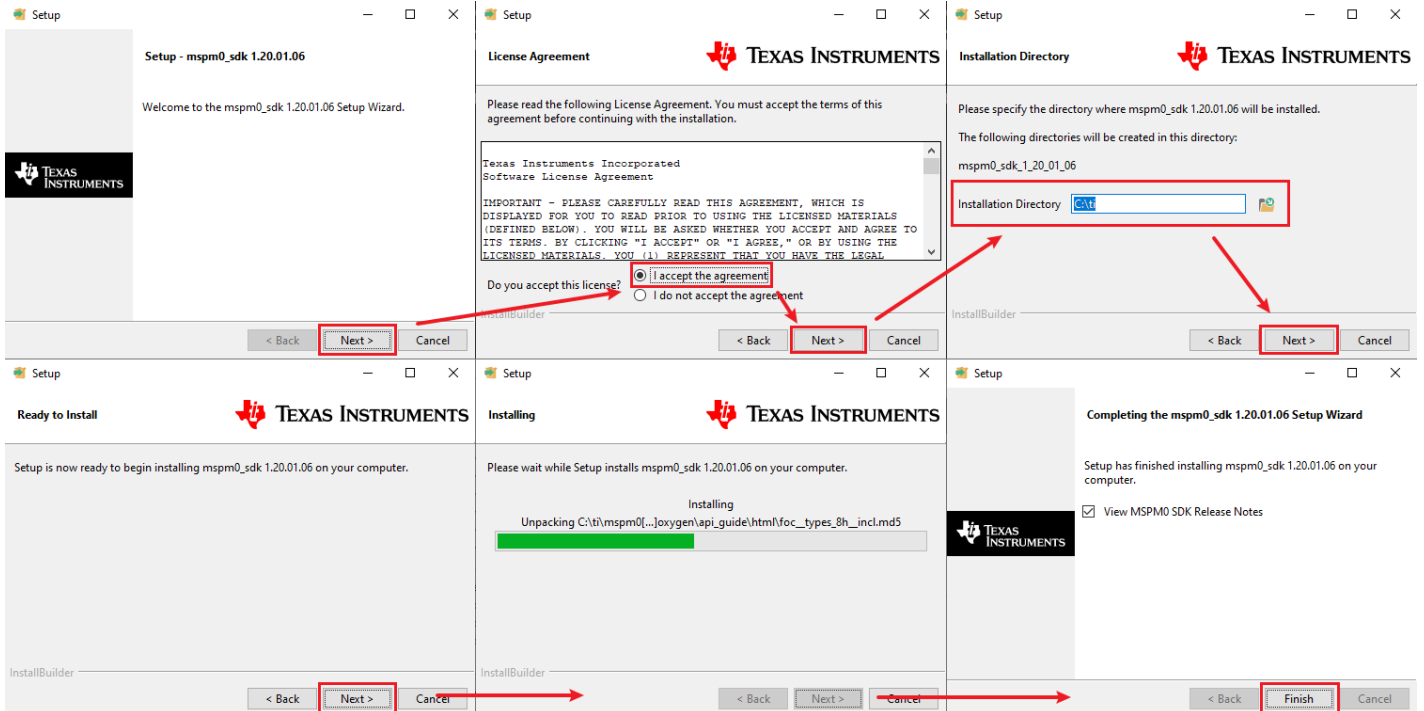
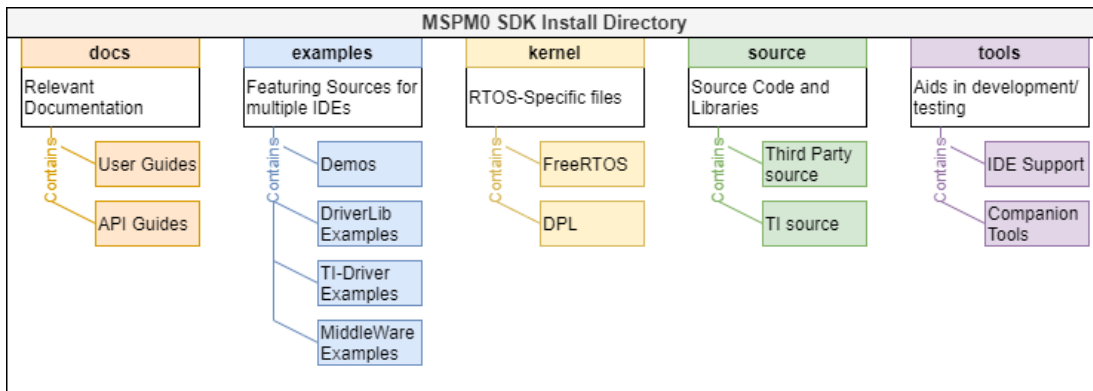

**Figure 3-4. MSPM0-SDK Install Step-by-Step**

### 3.2.2 MSPM0-SDK Introduction

The SDK install directory contains five folders (Figure 3-5). This section briefly introduces each folder.

- Docs folder: Contains all the documentation for SDK.
- Examples folder: Contains all the examples for reference, which can be used to provide a reference and starting point to accelerate application development. For more details, see the [MSPM0-SDK Example Guide](#).
- Kernel folder: Built files for RTOS and nortos, which is included in the example project and accelerates the speed of the project build.
- Source folder: Contains all the source code for TI and third party libraries.
- Tool folder: Contains all the tools related to SDK, such as sysconfig support files, BSL GUI, and metrology GUI.



**Figure 3-5. MSPM0-SDK Structure**

The most important folders are example and document folders, which are introduced in the following sections.

#### 3.2.2.1 Examples Folder Introduction

TI manufactures a LaunchPad for one MSPM0 sub family with a superset MSPM0 on board. The same example code can be reused across this MSPM0 sub family. The nortos example is under the address `mspm0_sdk_x_x_x_x \ examples \ nortos \ LP_MSPM0xxxx` and the RTOS example is under the address `mspm0_sdk_x_x_x_x \ examples \ RTOS \ LP_MSPM0xxxx`. This section shows a brief introduction for some key example types.

- RTOS Folder:
  - Drivers: Examples uses kernel functionality and provide higher-level hardware operation based on TI Drivers. For Driver Porting Layer (DPL), the DPL abstracts the drivers, allowing for migration between different RTOS kernels or No-RTOS. For POSIX layer, the layer abstracts RTOS functionality, allowing for migration to new kernels.
- Nortos Folder:
  - DriverLib: Simple modular examples showing MSPM0 functionality, consisting of low-level drivers with the highest optimization.
  - Middleware: Designs for different applications, with libraries and protocol stacks, including automotive, appliances, building automation, and so on. For a list of supported middleware, see [MSPM0-SDK Document Overview](#).
  - Demos: Integrated ready-to-use demos, such as driver code examples to work with TI analog devices.

In the RTOS example level, the most important folder is the *Drivers* folder that demos the peripheral control based on TI Drivers. In the Nortos example level, the most important folder is the *DriverLib* folder, which contains the peripheral example code based on DriverLib. The address and content example are shown in [Figure 3-6](#).

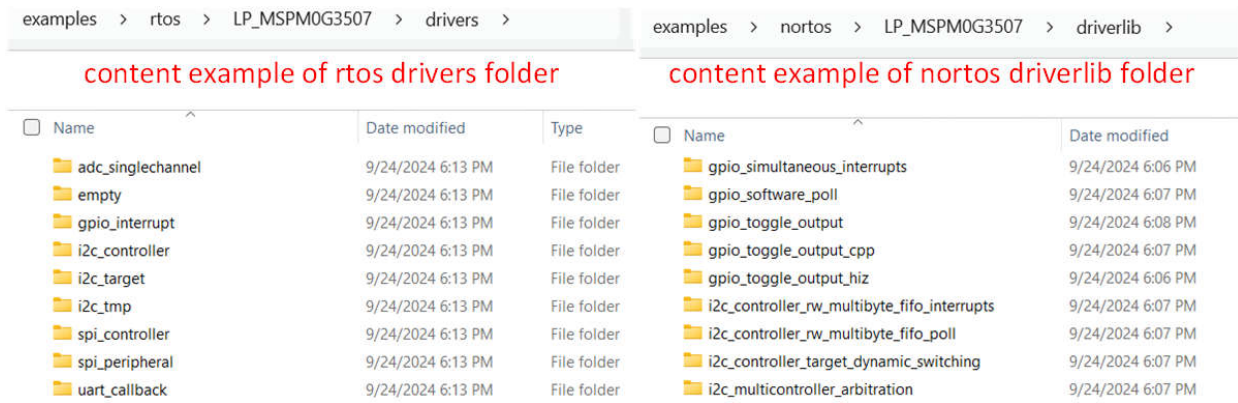

**Figure 3-6. RTOS and Nortos Code Examples**

For reference, examples under *Drivers* and *DriverLib* supports all the platforms listed in [Table 3-3](#). Examples under other folders at least support the CCS platform.

**Table 3-3. MSPM0 Example Coverage**

Supported by SDK	Platform 1		Platform 2	Platform 3
IDE	CCS		Keil	IAR
Compilers	TI Arm-Clang	GNU Arm (GCC)	Arm and Keil Compiler	IAR Arm compiler
RTOS	FreeRTOS			
Code examples	DriverLib and TI Drivers			

For a MSPM0 peripheral quick start, see [MSPM0 Academy](#). This delivers training modules for various topics in the MSP MCU portfolio.

### 3.2.2.2 Documents Folder Introduction

This section lists all the documents in MSPM0-SDK. This is based on version 1\_20\_01\_06.

#### MSPM0 SDK Documentation:

- [Release Notes](#): Lists all the contents of the MSPM0-SDK and release notes.
- [Quick Start Guides](#): Provides step-by-step instructions to get started quickly using MSPM0 with Code Composer Studio™ (CCS) Theia, CCS, IAR or Keil.
- [MSPM0 SDK User's Guide](#): Homepage of MSPM0-SDK. Provide navigation to MSPM0-SDK example guide and SDK overview.
- [Manifest](#): Lists all the contents in SDK and every installation file path for each component.
- [Early Samples Migration Guide](#): Describes the recommended tool versions that support production samples and provide migration guidelines for applications using DriverLib and SysConfig configuration files.

#### DriverLib Documentation:

- [DriverLib Guide](#): Provides a software layer to the programmer to facilitate a higher level of programming compared to direct register access.

#### TI Drivers Documentation:

- [TI Drivers Overview](#): TI Drivers is a collective of peripheral drivers for TI's MSPM0 portfolio. The drivers are centered around a portable application programming interface (API) which enables seamless migration across the MSPM0-SDK portfolio. Unless specifically stated otherwise, TI Drivers are designed to be thread safe and work seamlessly inside of a real-time operating system (RTOS) application.

#### Middleware Documentation (Libraries and protocol stacks for different applications):

- [Middleware Main Folder](#)
- [Secure Booting and Updating](#)
- [Brushed Motor Control Library](#)
- [DALI Library](#)

- [Diagnostic Library](#)
- [EEPROM Emulation Library](#)
- [Energy Metrology Library](#)
- [GUI Composer Library](#)
- [Hall Sensored Trap Motor Control Library](#)
- [IQMath Library](#)
- [LIN Library](#)
- [Sensorless FOC Motor Control Library](#)
- [SENT Library](#)
- [SMBBus Library](#)
- [Stepper Motor Control Library](#)
- [PMBus Library](#)

**Third Party Documentation:**

- [CMSIS DSP](#): Texas Instruments supports Arm® Cortex® Microcontroller Software Interface Standard (CMSIS), a standardized hardware abstraction layer for the Cortex-M processor series.
- [IO-Link](#): Digital interfaces such as IO-Link on the sensor and actuator level offer advantages when maintenance and repair is required in addition to providing seamless communication and improved interoperability.
- [Zephyr](#): Texas Instruments has started development to support [Zephyr](#) as a real-time operating option for MSPM0 devices.

### MSPM0 Tools Documentation:

- IDEs and Compilers: MSPM0 supports IDEs: Code Compose Studio (CCS), [IAR Embedded Workbench for Arm](#), [Arm Keil MDK](#). For the toolchain, MSPM0 supports both [TI Arm Clang Compiler](#) and [Arm GCC Toolchain](#).
- Code Generation: MSPM0 supports [SysConfig](#).

### Debugging and Programmings Tools:

- **XDS-110**: The Texas Instruments XDS110 is a new class of debug probe (emulator) for TI embedded processors.
- **MSP-GANG**: The MSP Gang Programmer (MSP-GANG) is a device programmer that supports MSPM0 and all variants of MSP430 and MSP432.
- **UniFlash**: UniFlash is a standalone tool used to program on-chip flash memory on TI MCUs and on-board flash memory for Sitara processors. To access the quick start guide, click [here](#).
- **BSL Host**: MSPM0 devices are shipped with a highly customizable ROM-based bootloader that supports universal asynchronous receiver/transmitter (UART) and inter-integrated circuit (I2C) communication by default. For more information, see the [MSPM0 Bootloader \(BSL\) Implementation](#).
- **MSPM0 Factory Reset GUI Tool**: The Debug Subsystem Mailbox (DSSM) can be used to perform a device mass erase, perform a factory reset, and send a password to unlock the SWD interface.
- **Elprotronic**: Elprotronic offers multiple hardware and software programming tools supporting MSPM0 in addition to Texas Instruments' MSP430 and MSP432, SimpleLink™ (CC), C2000™, and TIVA™-C MCUs. Elprotronic supports MSPM0 include the MSP-GANG, FlashPro-ARM, and GangPro-ARM.
- **Segger**: [SEGGER J-Link](#) debug probes are the most widely used line of debug probes available today. For more details, see [Using Segger programmers with MSPM0](#).
- **PEmicro**: [PEmicro Multilink and Multilink FX](#) debug probes offer an affordable and compact method for TI MSPM0 development, and allow debugging and programming to be accomplished simply and efficiently.
- **Lauterbach**: MSPM0 is supported by all Arm debug tools. Generally used for Cortex-M controllers, the preferred tool is the [μTrace for Cortex-M](#).

### 3.3 SysConfig Setup

SysConfig is a collection of graphical utilities for configuring pins, peripherals, and other components. SysConfig helps manage, expose, and resolve conflicts visually so that a user has more time to create differentiated applications. The output of the tool includes the C header and code files that can be used with MSPM0-SDK examples or used to configure custom software.

#### 3.3.1 SysConfig Installation

If a user selects CCS as the IDE platform, this section can be ignored, as SysConfig is already integrated.

If a user selects Keil or IAR as the IDE platform, download the standalone [SysConfig configuration tool](#) and follow the steps to finish the installation, as shown in [Figure 3-7](#).

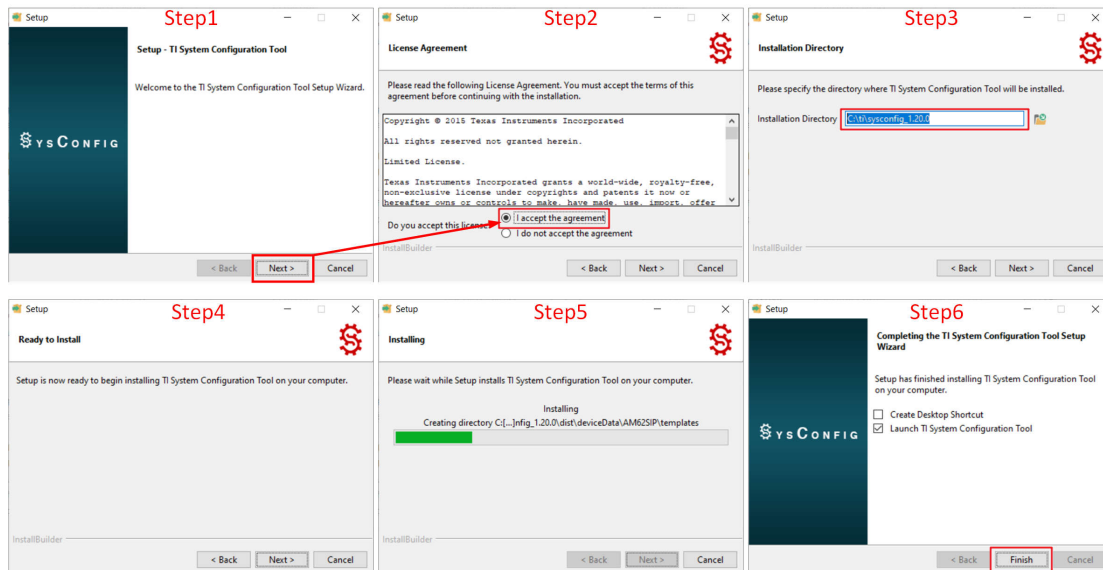

**Figure 3-7. SysConfig Install**

### 3.3.2 SysConfig Introduction

This section is a simple introduction on how to use SysConfig. Additional sections further introduce how to use SysConfig with IDE in [Section 3.4](#).

- Add the required peripherals in *Peripheral Usage*.
- Set the parameters in *Peripheral* setting, paired with the device-specific technical reference manual.
- After debugging, the peripheral can generate C code directly.

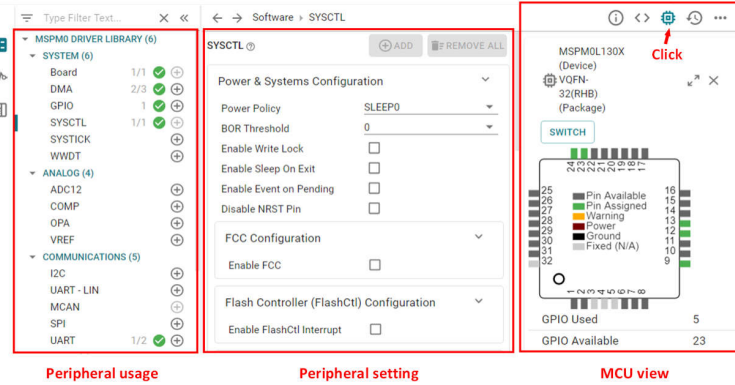

Figure 3-8. MSPM0 SysConfig

The next section introduces the components in SysConfig, which is abstracted from [Using SysConfig with MSPM0](#).

#### 3.3.2.1 Basic Concept

This section introduces SysConfig function blocks and basic operation.

As shown in [Figure 3-9](#), the basic view is shown after SysConfig is opened. SysConfig has two function blocks: the peripheral usage block, which is used to show the added peripherals and the peripheral setting menu entrance. Second is the peripheral setting, which is used to configure the MCU peripherals.

After clicking the buttons on the right side of the screen, the user can open more windows. Generated files are shown after the project build. The user can click the files individually to know the changes after doing new settings on SysConfig. The MCU view is used to view the pin assignment and pin resources, which is also an entrance for MSPM0 migration.

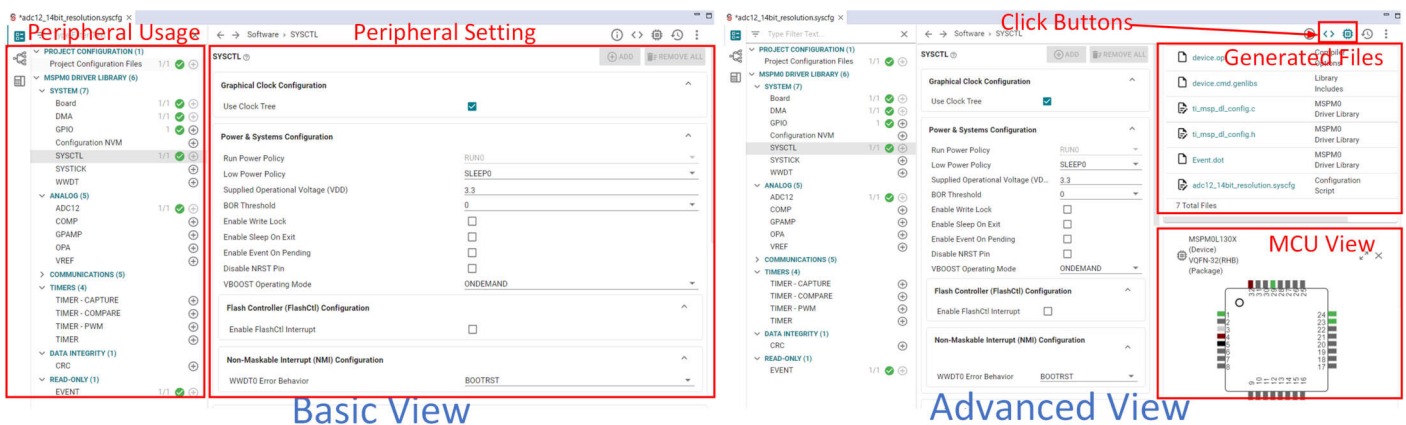
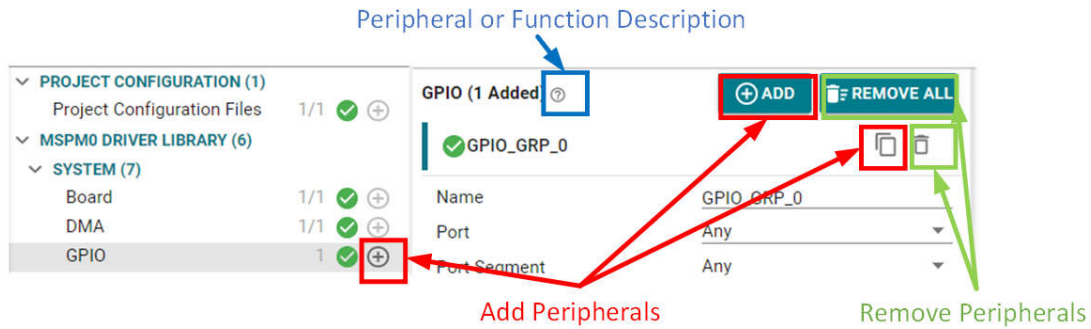

Figure 3-9. SysConfig View

The basic operations of SysConfig, includes adding peripherals, removing peripherals and referring the peripheral or function descriptions. As SysConfig is a low level MSPM0 peripheral setting GUI, see the technical reference manual or the peripheral examples to obtain a better understanding.

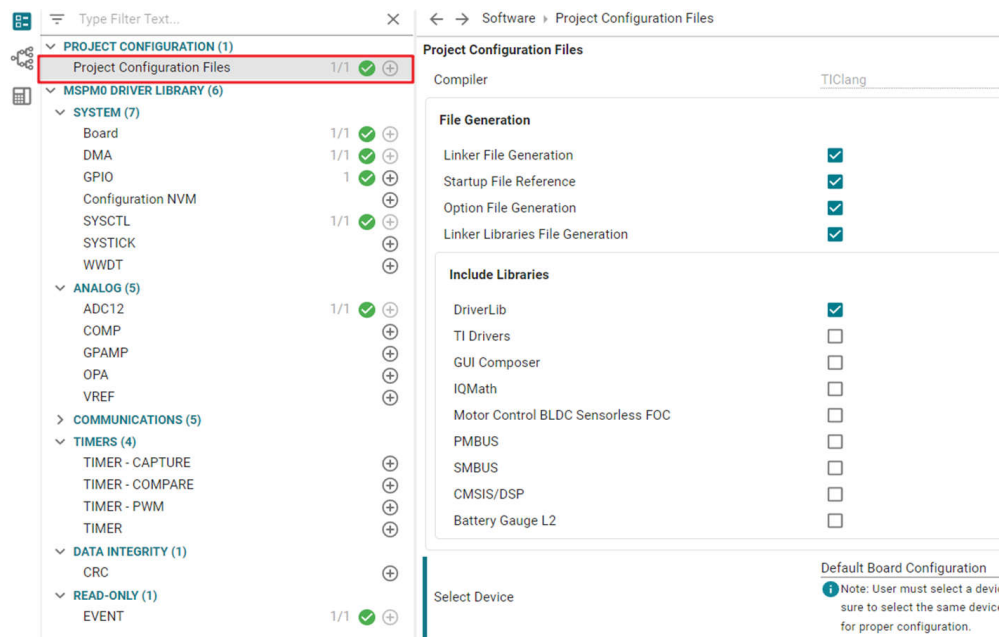

**Figure 3-10. Basic Operations**

### 3.3.2.2 Project Configuration View

Here is the project configuration. The configuration influences the total MCU project setting. This section is an introduction to some important features.

- **File Generation:** After you enable all the selection box, the project related files are auto generated by SysConfig. We suggest you to keep them under selection.
- **Include Libraries:** This shows all the libraries included in the SDK. After the selection box is enabled, the related library is included into the project automatically.
- **Select Device:** As the SDK examples is for the LP, after the MCU is migrated, this setting can be changed.



**Figure 3-11. Project Configuration**



### 3.3.2.3 Board View

Board view is used to configure the total MCU configuration.

- **Debug Configuration:** For some MSPM0s, the configuration reuses the debug port as peripheral functions. This is the SWD disabled entrance.
- **Global Pin Configuration:**
  - Enable Global Fast-Wake: This reduces the wake-up time sourced from any GPIO port.
  - Generate Peripherals and Pin Assignments File: After enabling, a peripherals and pin assignments file is generated in the *Debug* folder, as shown in [Figure 3-12](#).

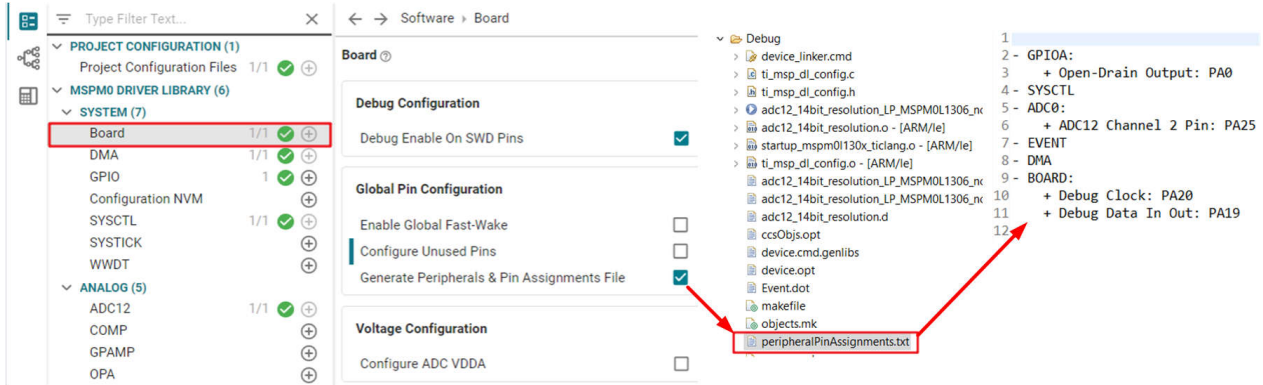

Figure 3-12. Board View

### 3.3.2.4 NONMAIN View

The NVM (NONMAIN) is used to configure the MSPM0 protected area related to boot configuration, security, and bootloader. With the incorrect program in NONMAIN, MSPM0 breaks. That is why the configuration risks must be accepted before performing configurations. As this function is for high level users, for details, please refer to [MSPM0 NONMAIN FLASH Operation Guide](#).

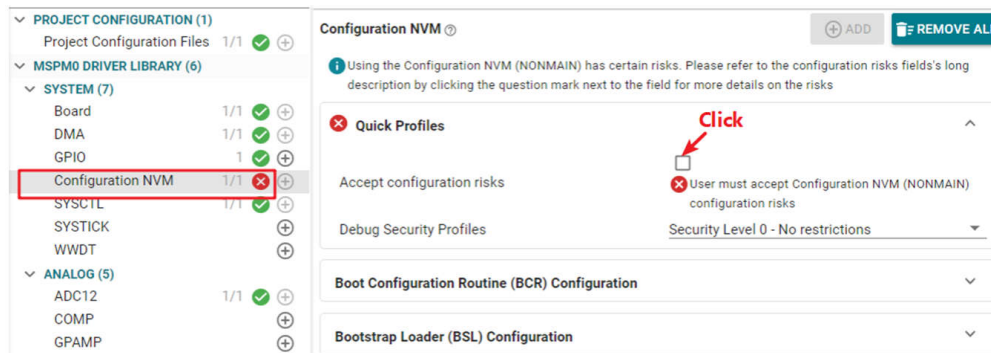

Figure 3-13. NONMAIN View

### 3.3.2.5 SYSCTL View

SYSCTL is used to configure MCU power, clock, and reset modules. The basic view is menu view. This section introduces the main configurations.

- Power and Systems Configuration:
  - Low power policy: Sets the low-power level for MSPM0.
  - Disable NRST pin: For some MSPM0 devices, the NRST pin can be reused as peripheral functions. This is the NRST pin disabled entrance.

The second view is clock tree view. The clock tree feature allows the user to configure the clocking of a device graphically rather than using SYSCTL menus, which can be found by clicking the signal icon near the top left corner of SysConfig. At the bottom left of the clock tree view, a user can locate all of the used clocks. For a detailed configuration on every clock source, click the icons as shown in Figure 3-14.

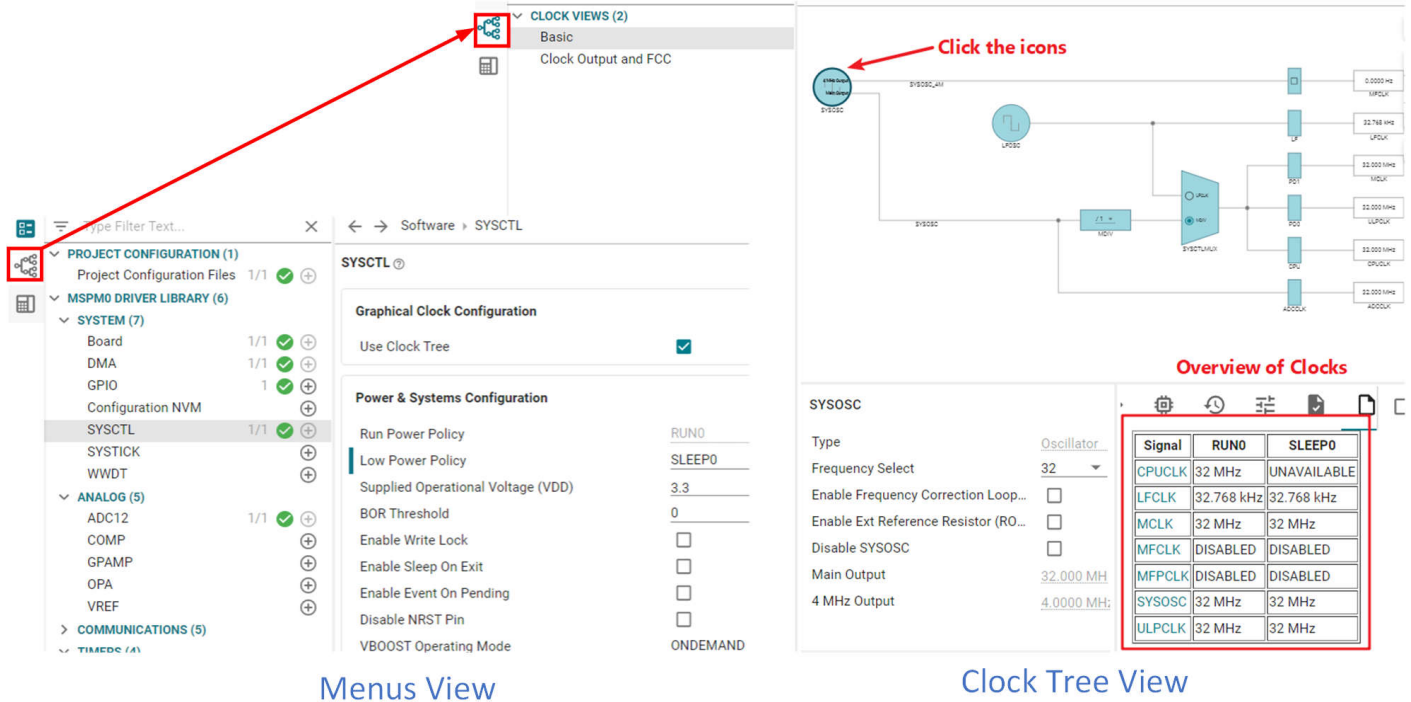

Figure 3-14. SYSCTL View

### 3.3.2.6 Peripherals Setup

This section introduces peripheral settings, as shown in [Figure 3-15](#). Open the software module description by selecting the module before adding the description. The description includes an overview of the functionality of the module. For more information, see the device data sheet or technical reference manual.

A peripheral configuration is a combination of these configurations:

- Basic configuration: Basic peripheral configuration
- Advanced configuration: Advanced peripheral configuration
- Interrupts configuration: Enable or disable MCU interrupt
- Event configuration: Peripheral to peripheral trigger configuration
- Pin configuration: Enables pullup or pulldown resistors
- PinMux: Selects the pin input or output for the selected functions

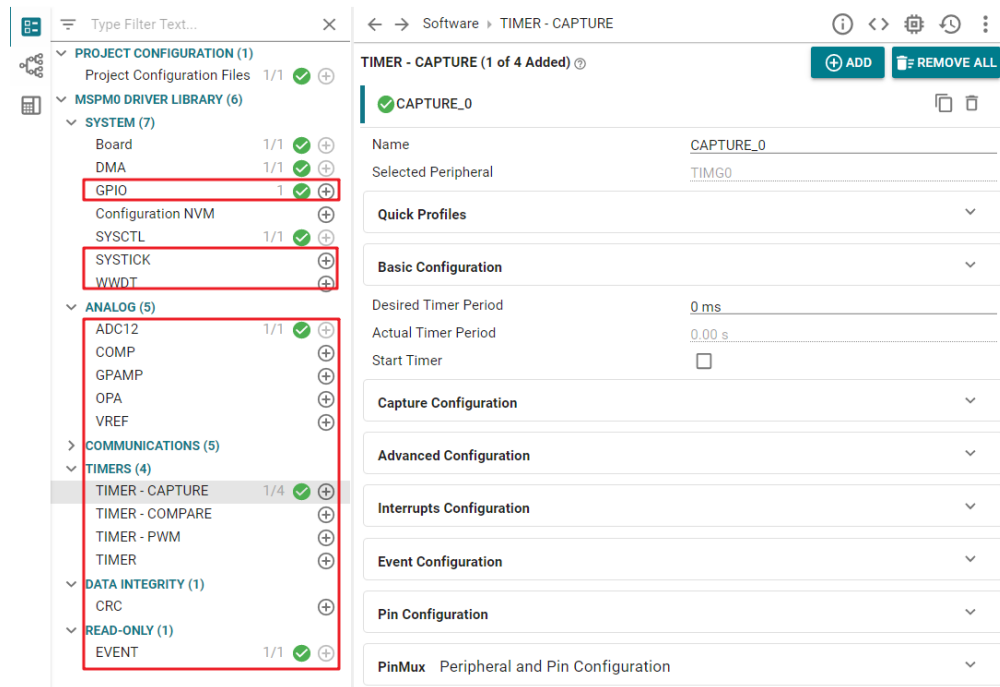

Figure 3-15. Peripherals View

### 3.4 IDE Quick Start

The MSPM0 series supports three IDEs to develop. CCS is recommended as a preferred option, as this is TI's IDE, which is compatible with MSPM0. The three different types of IDEs are listed and compared in [Table 3-4](#).

**Table 3-4. MSPM0 Supported IDEs Overview**

IDEs	CCS	IAR	Keil
License	Free	Paid	Paid
Compiler	TI Arm Clang GCC	IAR C/C++ Compiler™ for Arm	Arm Compiler Version 6
Disk size	4.60G(ccs2001)	6.33G(Arm 8.50.4)	2.5G (µVision V5.37.0)
XDS110	Supported	Supported	Supported
J-Link	Supported	Supported	Supported
EnergyTrace	Supported	No	No
MISRA-C	No	Supported	No
Security	No	Supported	No
ULINKplus	No	No	Supported
Function safety	No	Supported	Supported

The following links provide the related guides for different IDEs. All the content in this part is abstracted from these guides, especially for new beginners.

- [MSPM0 SDK Quick Start Guide for CCS](#)
- [MSPM0 SDK Quick Start Guide for IAR](#)
- [MSPM0 SDK Quick Start Guide for Keil](#)
- [CCS IDE Guide for MSPM0](#)
- [IAR IDE Guide for MSPM0](#)
- [Keil IDE Guide for MSPM0](#)

### 3.4.1 CCS Quick Start

Note that in 2024, CCS changed platforms from CCS 12.x to CCS 20.x. CCS 20.x, built on the Theia IDE framework, is newer, with a modern interface and better features than CCS 12.x (based on Eclipse). Here are the selection suggestions:

- When to choose CCS 20.x: if users are starting a new project with the latest TI devices and want the most up-to-date features, or prefer a more modern and user-friendly IDE experience.
- When to choose CCS 12.x: if users have existing projects developed in CCS 12.x and want to avoid major code changes during migration.

This section details an introduction based on CCS 20.x. If users want to use CCS 12.x, then here is the latest version entrance: [CCS12.8.1](#). For documentation, refer to [MSPM0 SDK Quick Start Guide for CCS v12 \(Eclipse\)](#) and [CCS V12 Eclipse IDE for MSPM0](#).

#### 3.4.1.1 CCS Installation

This section details steps and tips for CCS installation. Remember to save CCS at the address and the default installation place that is suggested.

1. Download [CCS](#) (20.0 version or above), start installation, and keep pressing **Next**.
2. Select *I accept the agreement*.
3. Suggest to keep the install address to be default.
4. Select MSPM0 support component.

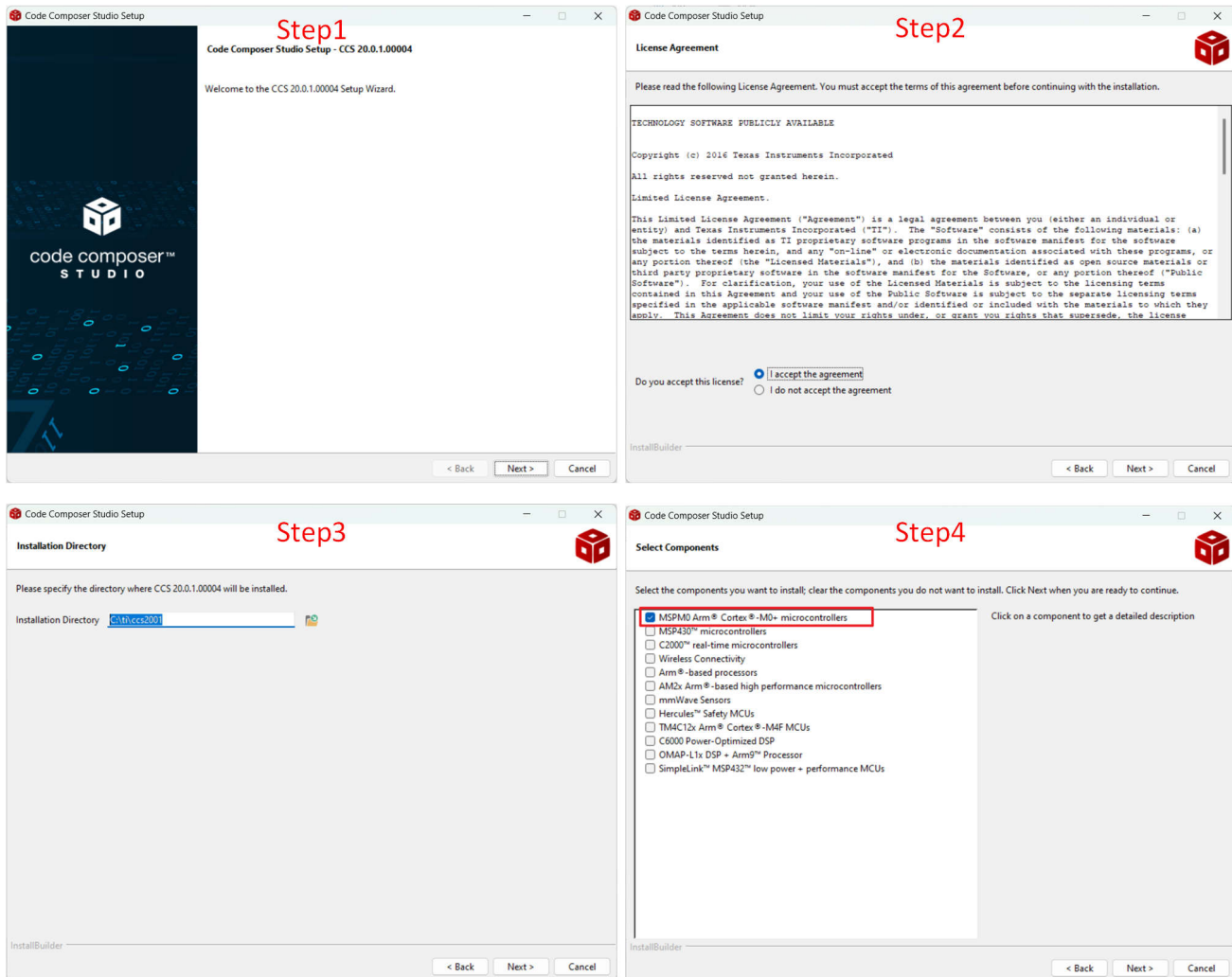

Figure 3-16. CCS Key Install Steps

### 3.4.1.2 Import a SDK Example

Import an example with the TI-Clang compiler from the installed SDK. Here are the steps:

1. Select File → Import Projects.
2. Browse to the SDK installed address.
3. Select the code example folder.
4. Select the code example with the wanted compiler. The tclang compiler is suggested.

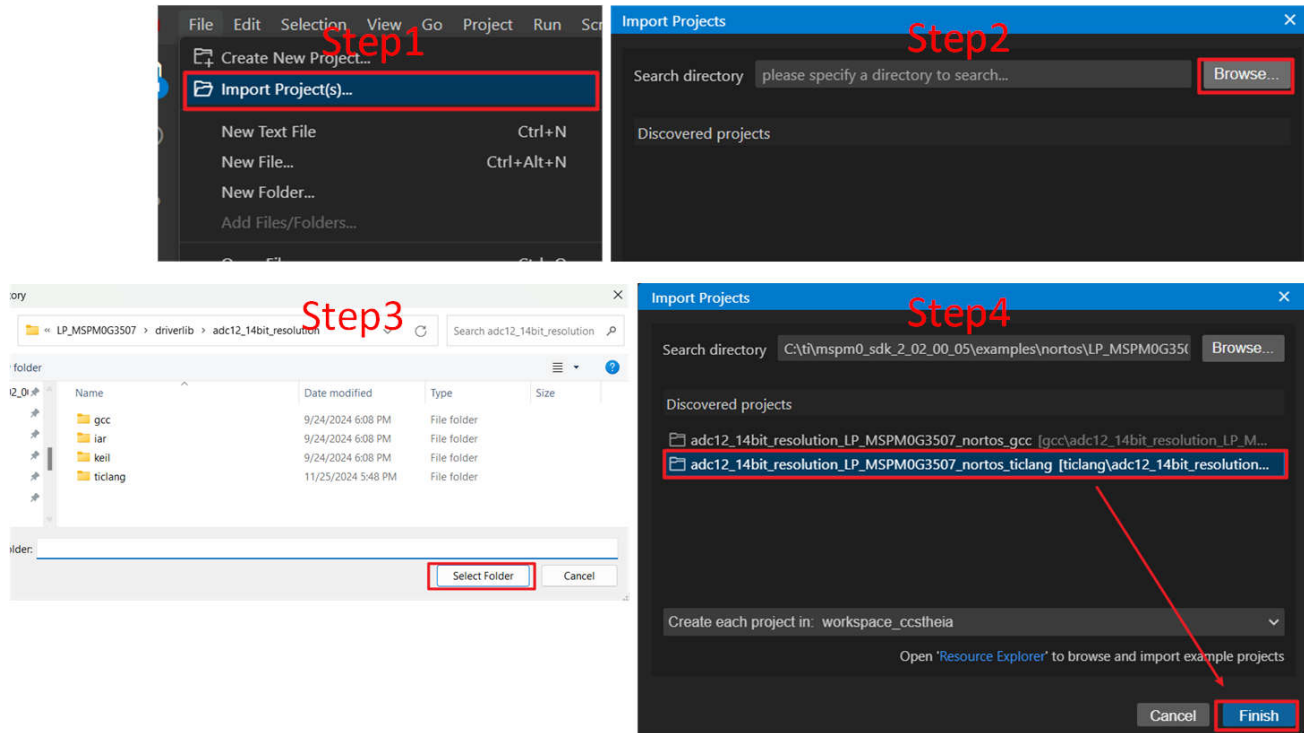

Figure 3-17. Import CCS Project

Here is the view of the imported project. The most important files are in red. This section shows a brief introduction.

- Sysconfig generated code: Click the *Build* button, the SysConfig generates the code under the *Debug\syscfg* folder or directly under the *Debug* folder .
- .map file: In the *Debug* folder, refer to the .map file to find out more about the memory usage condition.
- Main function .c file: Includes the main function in the file.
- .cmd file: Define the MCU memory allocation. In the latest CCS, SysConfig generates the allocation file automatically with the setting in *Project Configuration Files*.
- SysConfig: GUI tool to generate the peripheral setting code.

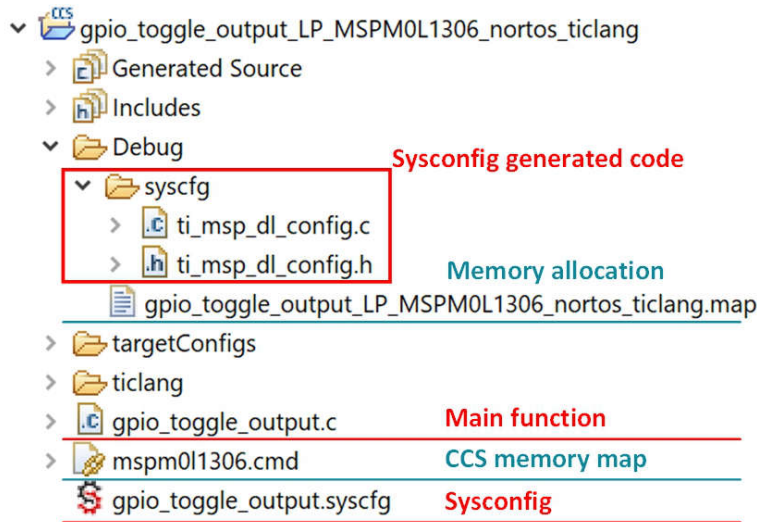

Figure 3-18. CCS Project Overview

### 3.4.1.3 Example Download and Debug

The default debugger selection is XDS110. If users are using the Launchpad, then keep default. To select J-Link, right-click the Project name, *Project -> Properties -> General* and follow the instruction as bellow to select J-Link.

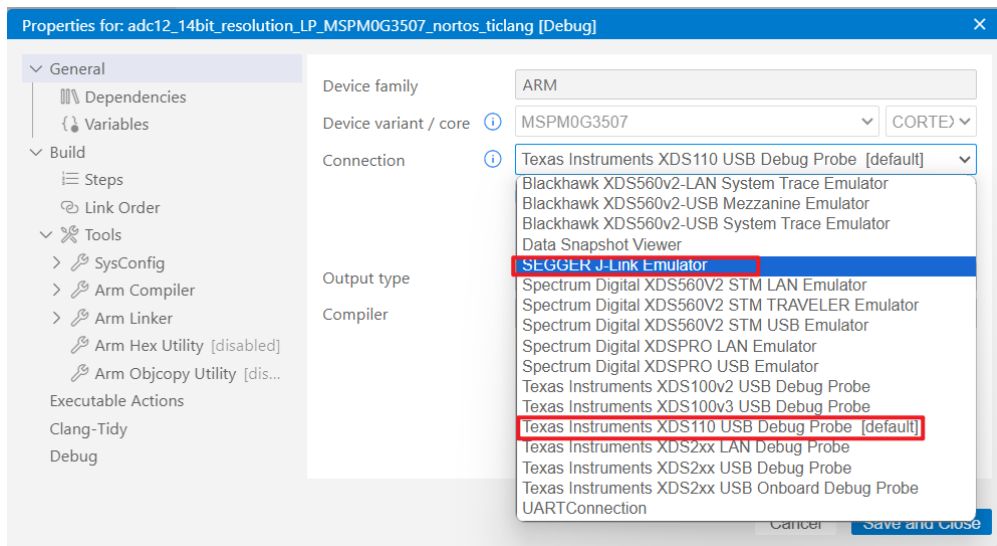
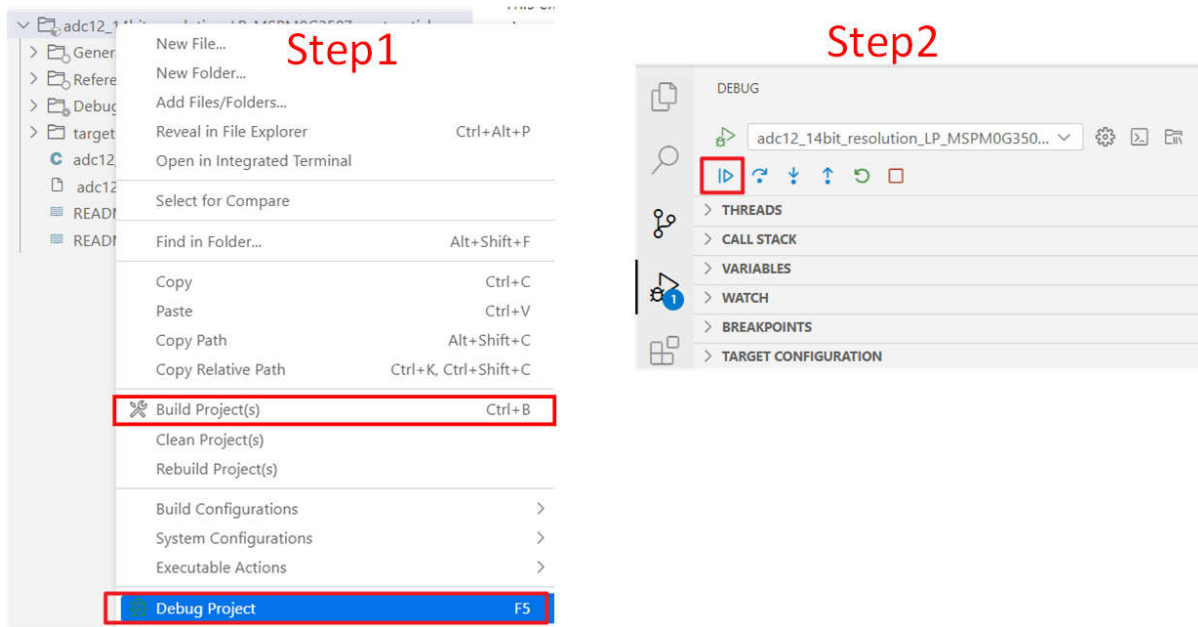

Figure 3-19. Change Debugger Selection

After the project is imported and the hardware is set up, users can follow the setup to run the code on MCU.

1. Start debug by right-clicking the project name. First click *Build Projects* and then click *Debug Project*. Users can also use Ctrl+B and F5 instead.
2. After that, the window automatically moves from the CCS edit view to CCS debug view. After the MCU enters debug mode, click the *Run* button to enable the code running.



**Figure 3-20. Build, Debug and Run the Code**

This section is a quick introduction to CCS functions. The commonly used functions and meanings are shown in Figure 3-21. To view registers, users need to click *View -> Registers* and to open a register view window.

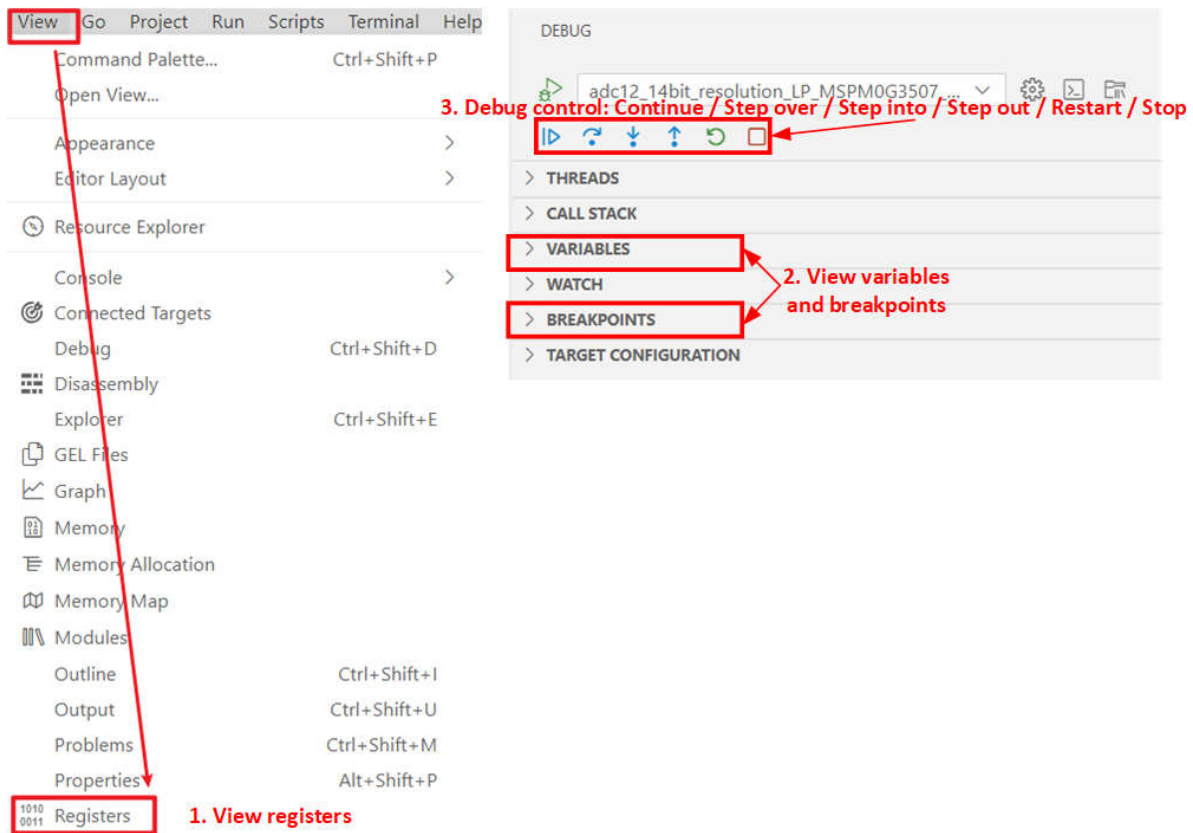

**Figure 3-21. Commonly Used Debug Functions**



### 3.4.1.4 Migrating Between MSPM0 Derivatives

Project migration in this scope means updating relevant project configuration files and settings that are specific to the derivative, including linker files, startup files, and included libraries. To facilitate project migration, SysConfig generates project configuration files by default, which can be controlled through the project configuration module.

Here are the migration steps based on CCS:

1. In SysConfig, enable the device view and click on *SWITCH*.
2. Select *New Values* for the *Device*, *Package*, and *CCS Launch Device* to migrate the project configuration to a new device, and then click *CONFIRM*.
3. After confirming the new device values, SysConfig highlights an error on the project configuration module. The user must select the new device in the *Select Device* options. Make sure the device selection matches what was selected for *CCS Launch Device* in the previous step.
4. Note that SysConfig highlights any conflicts with the migration, such as unavailable pins and peripherals. Fix any conflicts as needed, and save all the changes to the SysConfig configuration script. Migration is now complete and the user can build a project for the new target device.

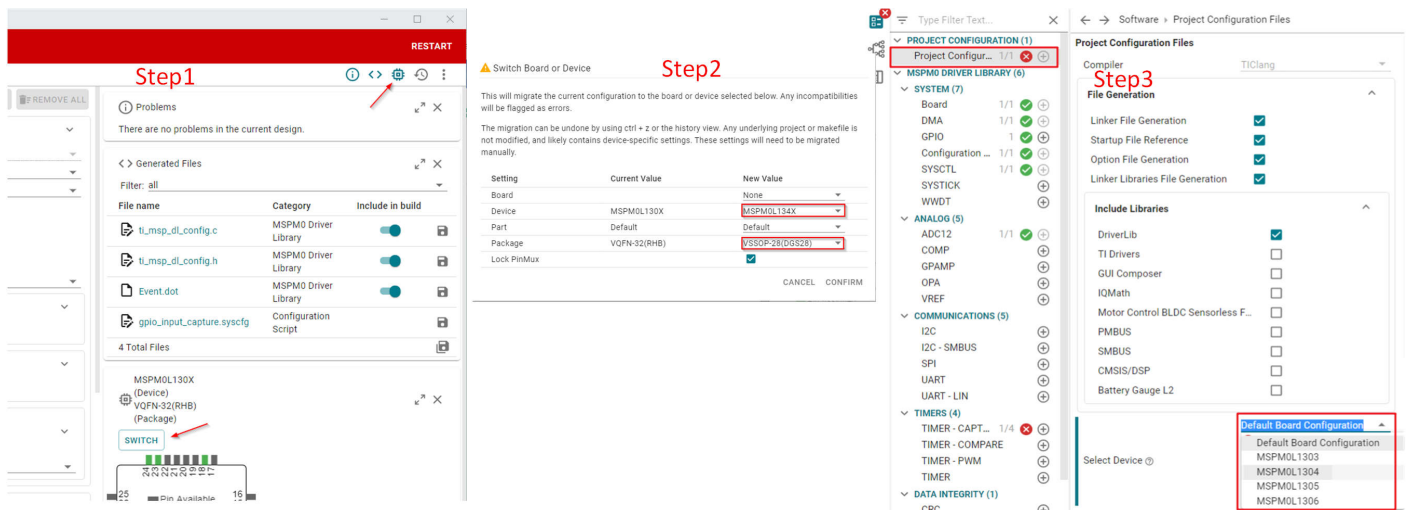
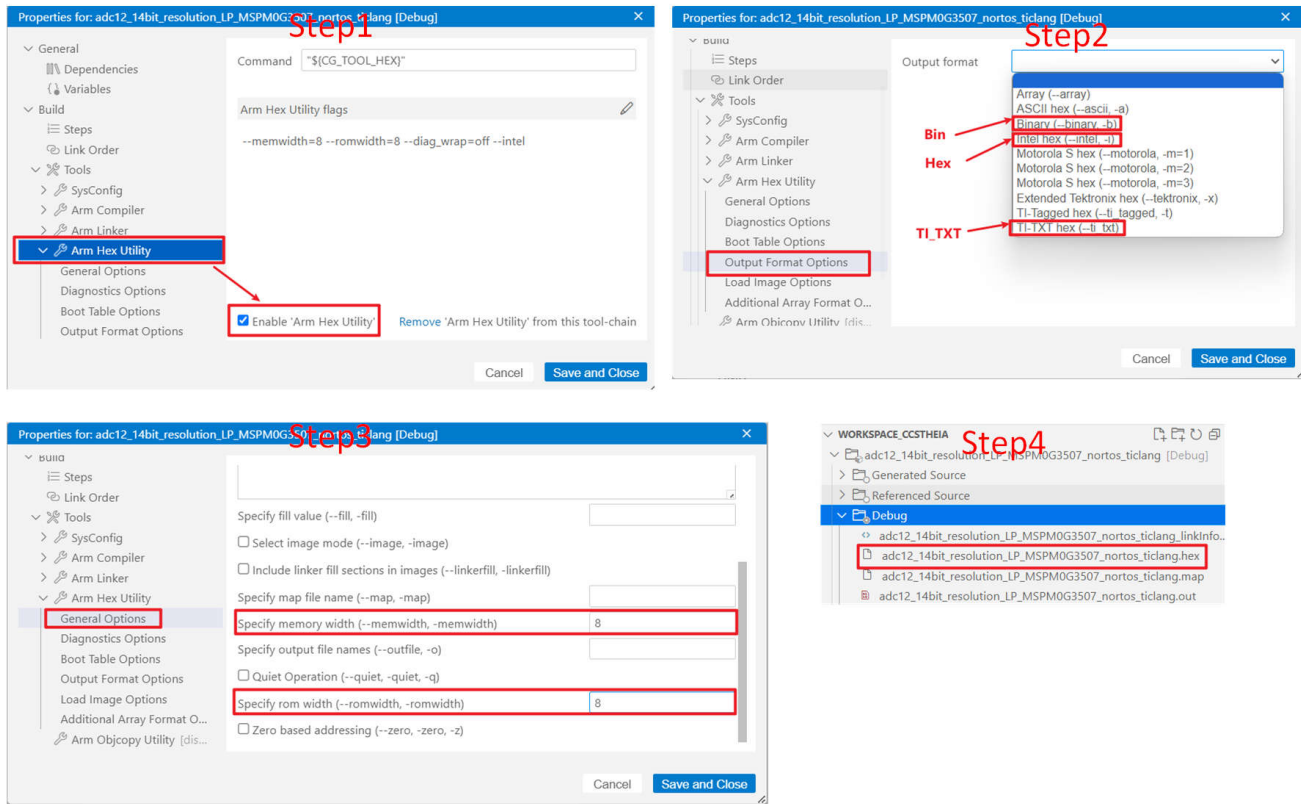

Figure 3-22. Migrating Between MSPM0 Derivatives

### 3.4.1.5 Generate Hex Files

CCS includes utilities which can be used to generate output objects in multiple formats for use with programming tools. The following steps explain how to enable the hex files using the hex utility which is integrated into CCS.

1. Right-click on a project and select *Properties*. Select *Build* → *Tools* → *Arm Hex Utility* and select *Enable Arm Hex Utility*.
2. Select *Output Format Options*. The common selections are *Bin*, *Hex*, and *TI\_TXT* format. Select the desired output format options.
3. If the Intel *HEX* format is selected, **one additional step** is required to specify the memory and ROM width as parameters. Select a memory and ROM width of 8in *Properties* → *Arm Hex Utility* → *General Options*.
4. Right-click on the project and select *Build Projects*. The hex file generates in the debug folder.



**Figure 3-23. Generate Hex File**

### 3.4.1.6 Program NONMAIN

If changes are made on the bootloader or MCU security settings by configuring the NONMAIN as shown in [Section 3.3.2.4](#), enable the NONMAIN erase in the CCS setting as well, as shown in [Figure 3-24](#). Otherwise, keep the default settings.

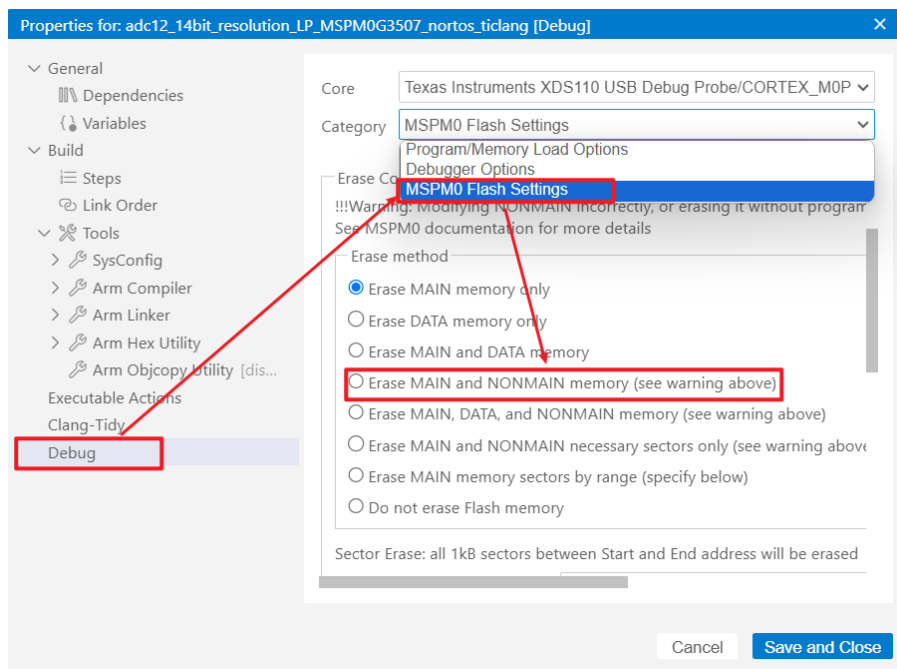

**Figure 3-24. Programming NONMAIN**

**Note**

Extreme care must be taken when erasing and programming NONMAIN. If done incorrectly, like losing connection in NONMAIN programming, the device is locked in a permanently unrecoverable state.

**3.4.2 IAR Quick Start**

TI recommends an IAR Embedded Workbench version higher than Arm 9.32.x. The less recent versions do not support MSPM0.

**3.4.2.1 Environment Setup**

**3.4.2.1.1 SDK Support Setup**

In IAR, users must add the latest MSPM0 SDK version. This step only has to be done once, or when the SDK is updated. This step only has to be done once, or when the SDK is updated.

- Step 1: In IAR, click on *Tools* → *Configure Custom Argument Variables*.
- Step 2: Click the *Global* tab, and then *Import*.
- Step 3: Navigate to your SDK folder into *<MSPM0\_SDK\_INSTALL\_DIR>/tools/iar/* and open *MSPM0\_SDK.custom\_argvars*.
- Step 4: The SDK variables is now installed in IAR. Click *OK* to close the window.

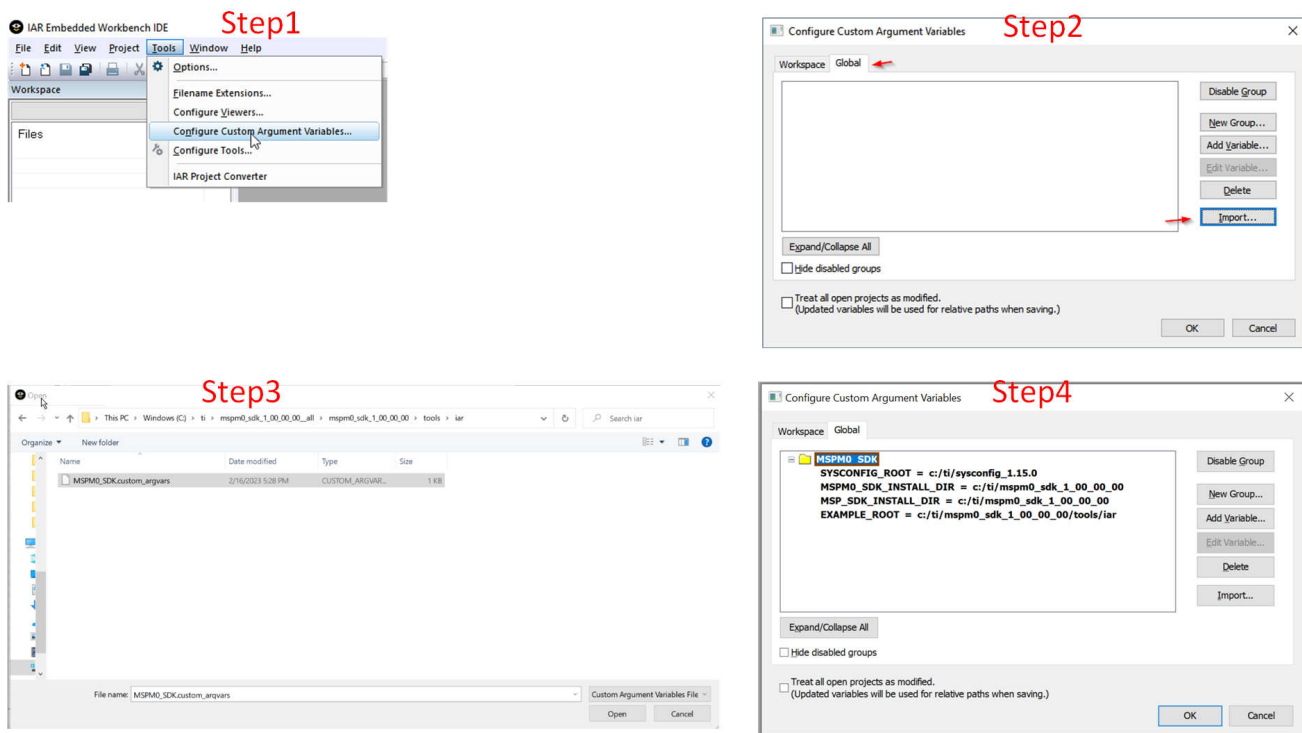

**Figure 3-25. Add MSPM0 SDK to IAR**

**Note**

Make sure the MSPM0 SDK path and SysConfig path matches the location and version needed for this SDK release. If an earlier version of the SDK is installed, then make sure to update the path to the current version. If the SysConfig path installed is incorrect or pointing to an older version, then modify the version.

### 3.4.2.1.2 SysConfig Support Setup

The SDK includes a preliminary version of SysConfig metadata which can be used to evaluate the user experience of MSPM0 SDK.

1. In IAR, select *Tools* → *Configure Viewers* from the menu.
2. Click *Import*.
3. Navigate to your SDK folder into `<MSPM0_SDK_INSTALL_DIR>/tools/iar/` and open `sysconfig_iar_setup.xml`.
4. The standalone SysConfig is associated to `.syscfg` files. Click *OK* to close window.
5. Double-check that the `SYSCONFIG_ROOT` Custom Argument Variable is correctly pointing to the SysConfig folder.

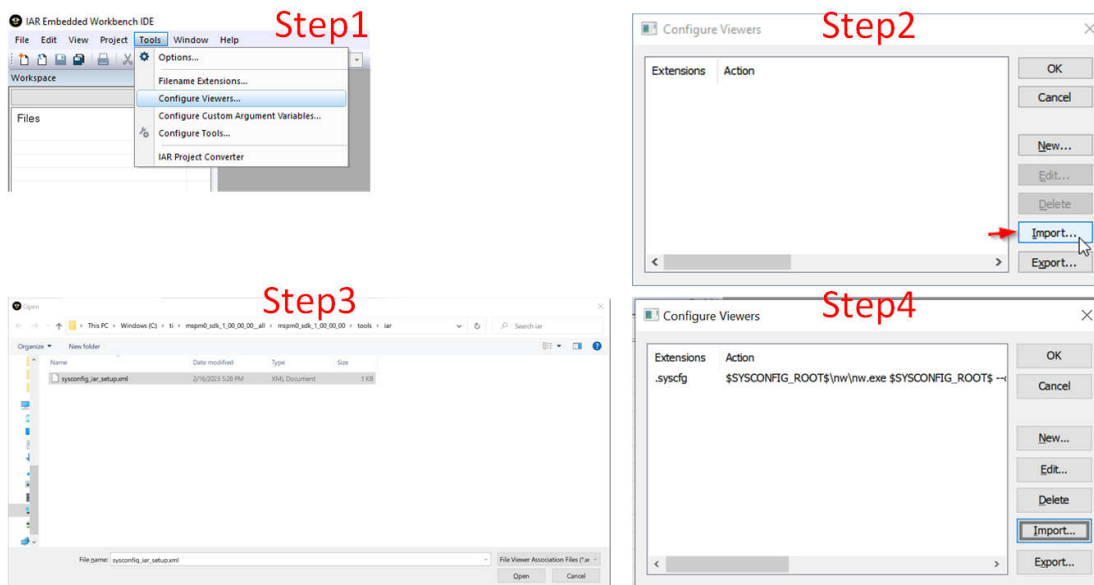

**Figure 3-26. Install SysConfig for MSPM0**

### 3.4.2.2 Import a SDK Example

Here are the steps to import an IAR code example from SDK:

1. In IAR, select *File* → *Open Workspace* from the menu.
2. Navigate to an IAR folder in SDK example at `<MSPM0_SDK_INSTALL_DIR>/examples/` and open the `.eww` workspace file.
3. Click *OK* on the message.
4. Select a folder to install the example.

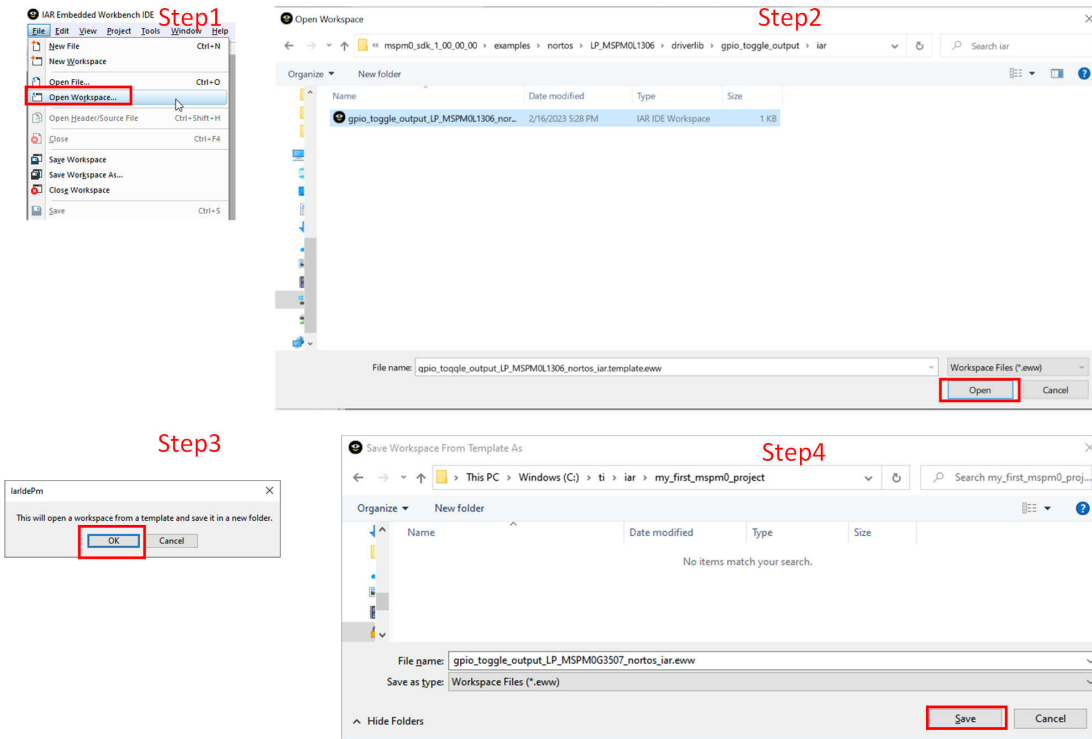

Figure 3-27. Import a SDK Example

This is a simple instruction to use SysConfig with IAR.

1. Double-click on the .syscfg file in your project.
2. This opens SysConfig and allows users to configure peripherals, IO pins, and other settings.
3. Save the changes and switch back to IAR EWARM. Build the code example. The Files in the SysConfig Generate Files folder is updated.

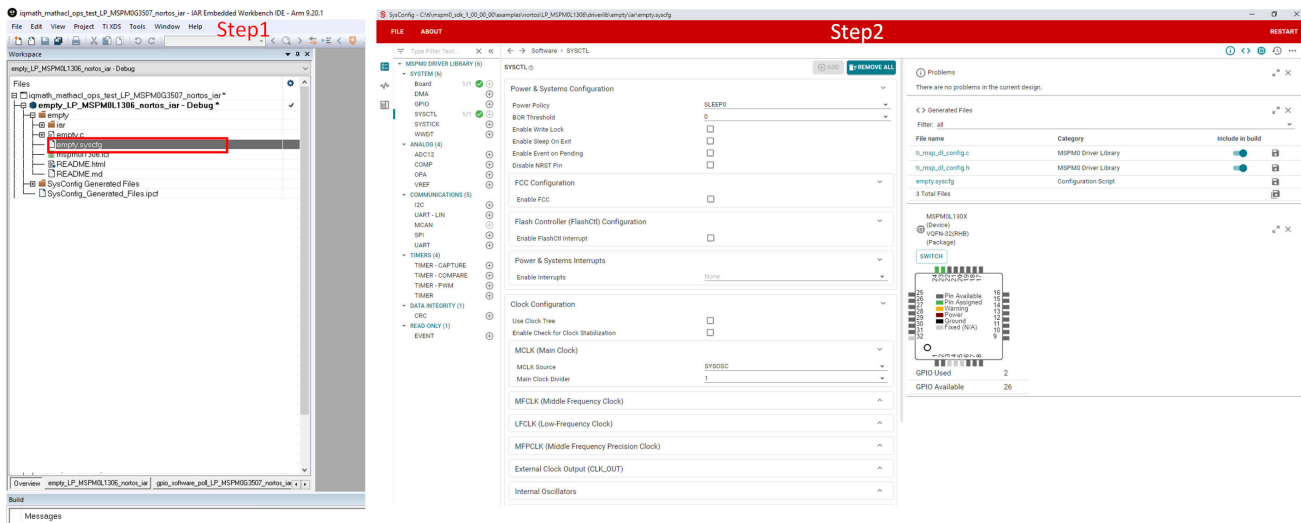

Figure 3-28. Use SysConfig With IAR

### 3.4.2.3 Example Download and Debug

Follow the steps below to build the example under IAR:

1. To build the example, right-click in the project and select **Make**. Note that SysConfig projects automatically generates files in the *SysConfig Generated Files* folder.
2. Click the **Download and Debug** button to download the code.
3. Now, start to debug the code.

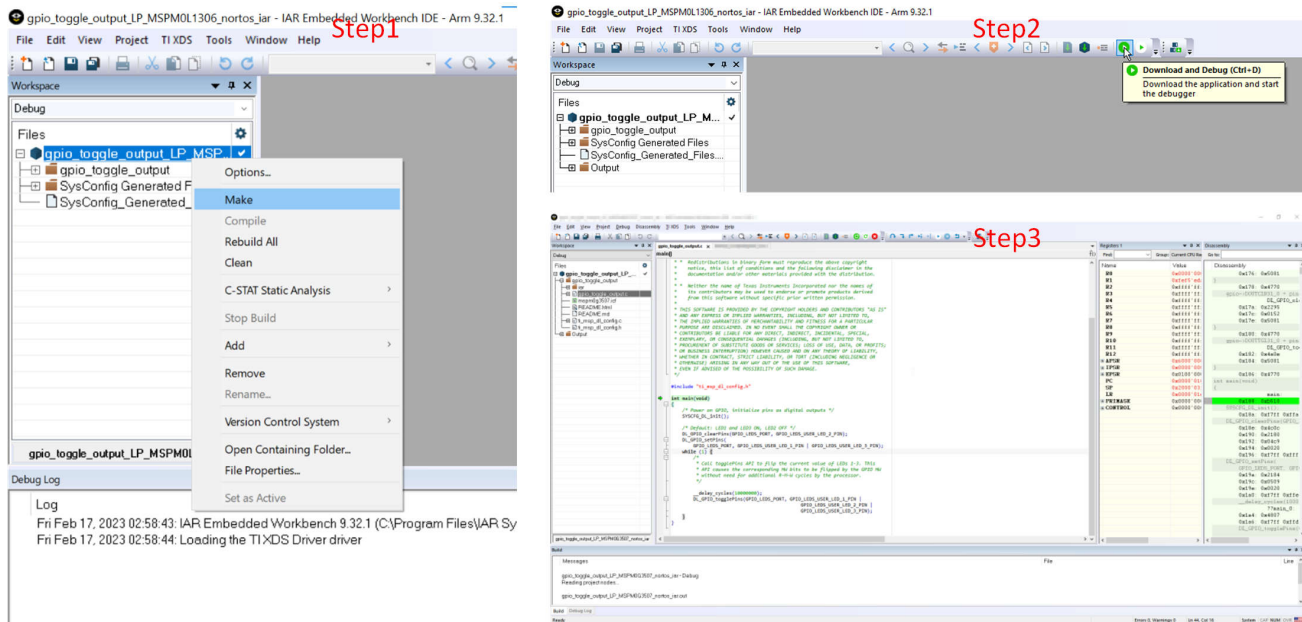

Figure 3-29. Download and Debug

### 3.4.2.4 Migrating Between MSPM0 Derivatives

SysConfig allows for an easier migration between MSPM0 derivatives. However some manual modifications are required on IAR. Here are the instructions:

1. In SysConfig, enable the Device View and click on **SWITCH**.
2. Select the corresponding options for the new MSPM0 device and click **CONFIRM**. Note that SysConfig highlights any conflicts with the migration, such as unavailable pins and peripherals. Fix any conflicts as needed.
3. In the project options, select **General Options** → **Target** → **Device**. Select the MSPM0 device.
4. In the project options, select **C/C++ Compiler** → **Preprocessor** → **Defined symbols**. Add the device definition as per the device selected.

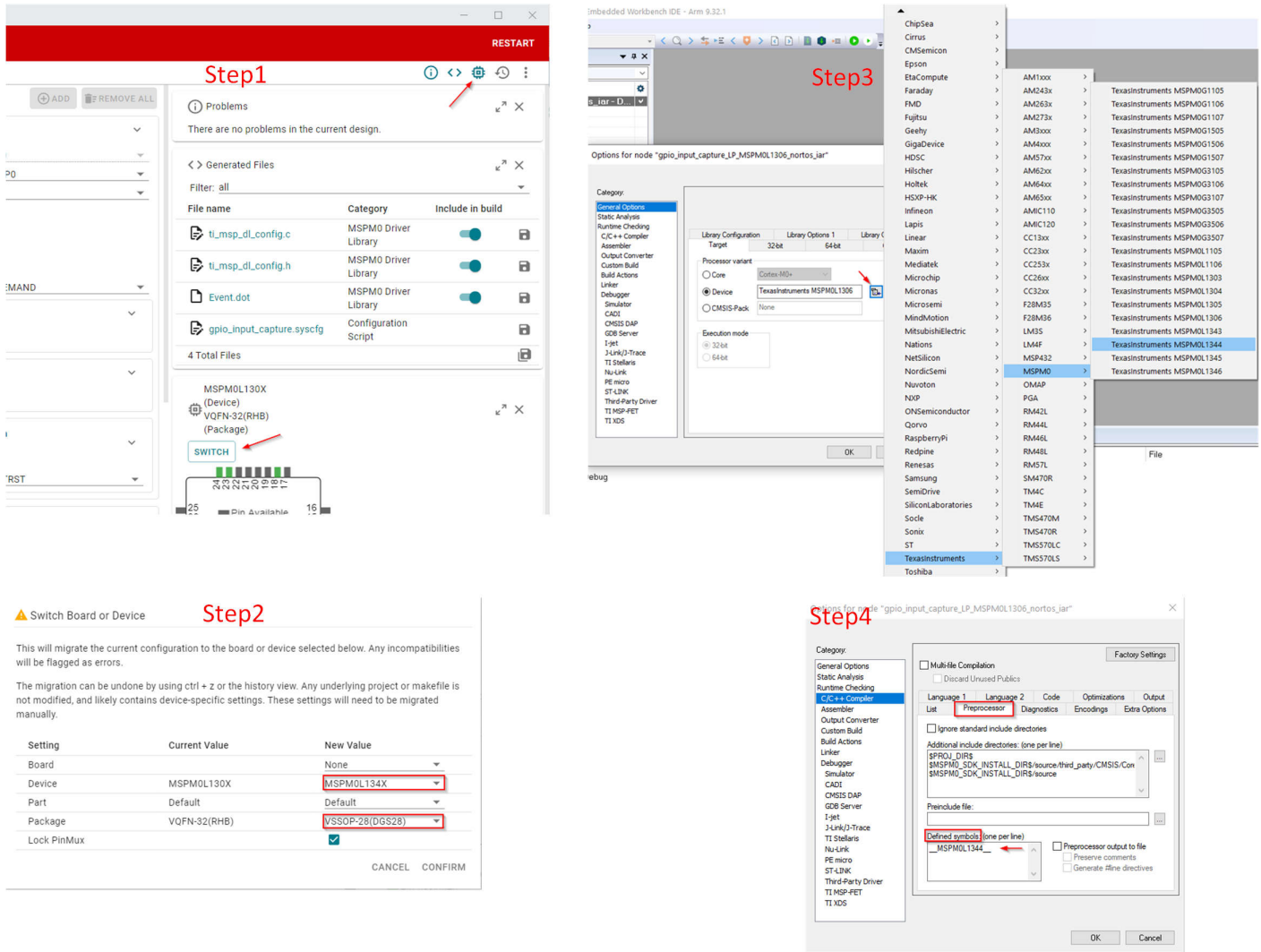
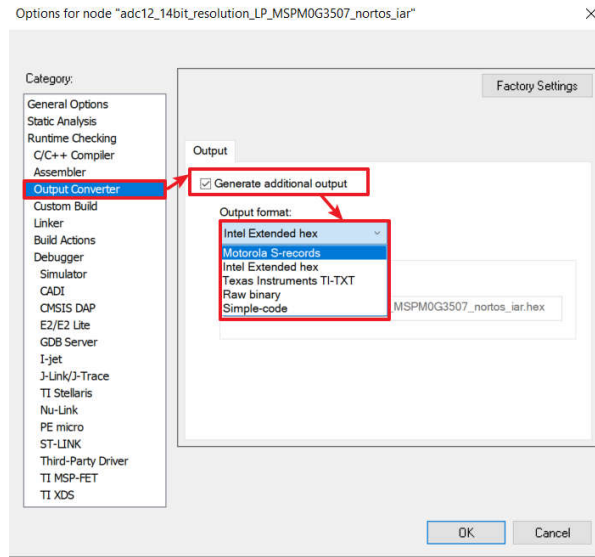

Figure 3-30. Migrating Between MSPM0 Derivatives

### 3.4.2.5 Generate Hex Files

Here is the instruction to generate hex files in IAR. Click *Project* → *Options* → *Output Converter* → *Generate additional output* → *Output format* → *Texas Instruments TI-TXT*. Intel Hex or other formats also can be selected.

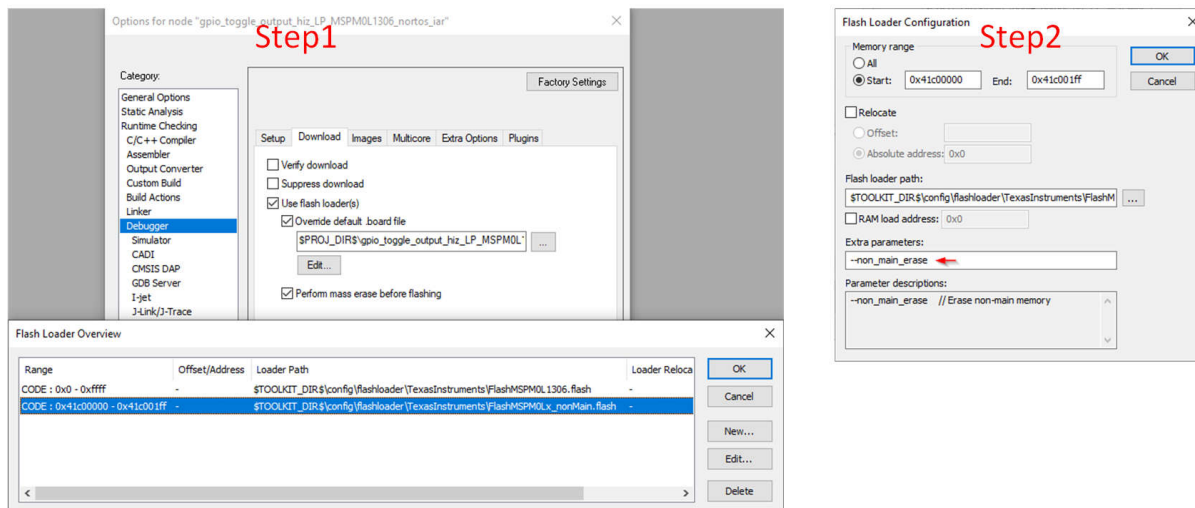

**Figure 3-31. Generate Hex Files**

### 3.4.2.6 Program NONMAIN

If users do the changes on Bootloader or MCU security setting by configuring the NONMAIN, then users need to enable the NONMAIN Erase in the IAR setting, as shown in [Section 3.3.2.4](#). Follow the steps below, otherwise, please keep the default:

1. Click *Options* → *Debugger* → *Download* → *Override default .board file* → *Edit*. Select the 2nd element and then click Okay.
2. Add `--non_main_erase` as an extra parameter.



**Figure 3-32. Program NONMAIN**

#### Note

Extreme care needs to be taken when erasing and programming NONMAIN. If done incorrectly like losing connection in NONMAIN programming, then the device becomes locked in a permanently unrecoverable state.



### 3.4.3 Keil Quick Start

#### 3.4.3.1 Environment Setup

Unlike the IAR, this is OK to use old version, Keil, however, remember to update the MSPM0 CMSIS-Pack.

##### 3.4.3.1.1 MSPM0 CMSIS-Pack Setup

The Pack installer needs to be installed first before the MSPM0 is developed. Here are the steps to update MSPM0 CMSIS-Pack:

1. In  $\mu$ Vision, open *Pack Installer* through quick guide or select *Project*  $\rightarrow$  *Manage*  $\rightarrow$  *Pack Installer*.

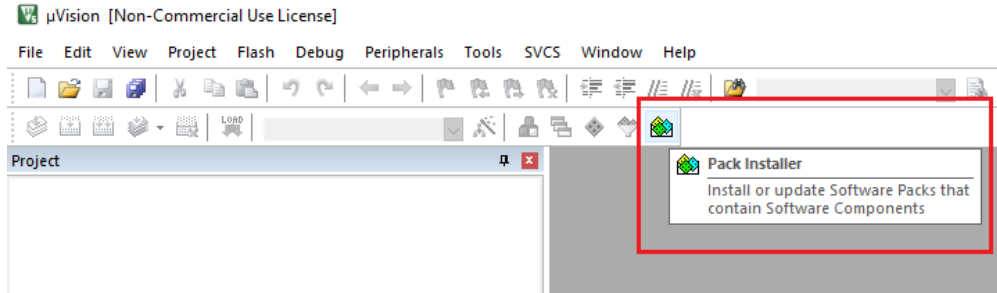

**Figure 3-33. Open Pack Installer**

2. In Pack Installer, search MSPM0 on the left side in the search text box. Then, the corresponding MSPM0 family is shown on the screen.

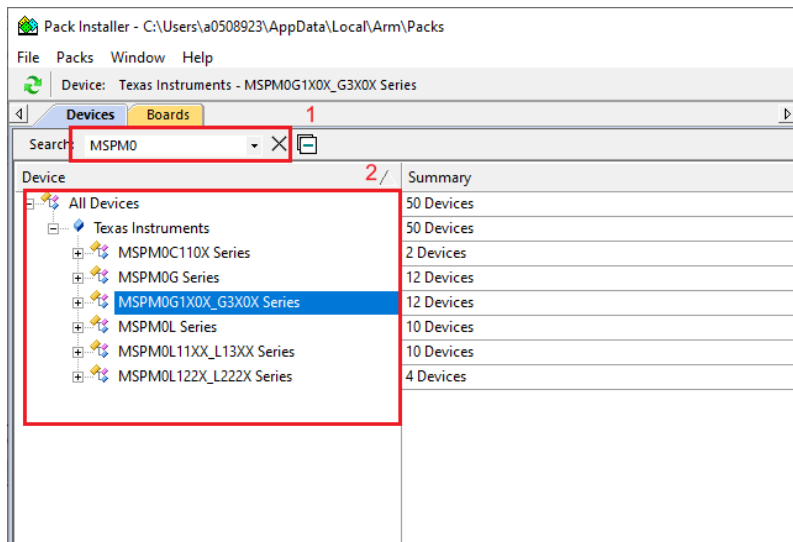

**Figure 3-34. Search Device**

### 3. Select the device to install a pack. Then on the right side, install the device-specific pack.

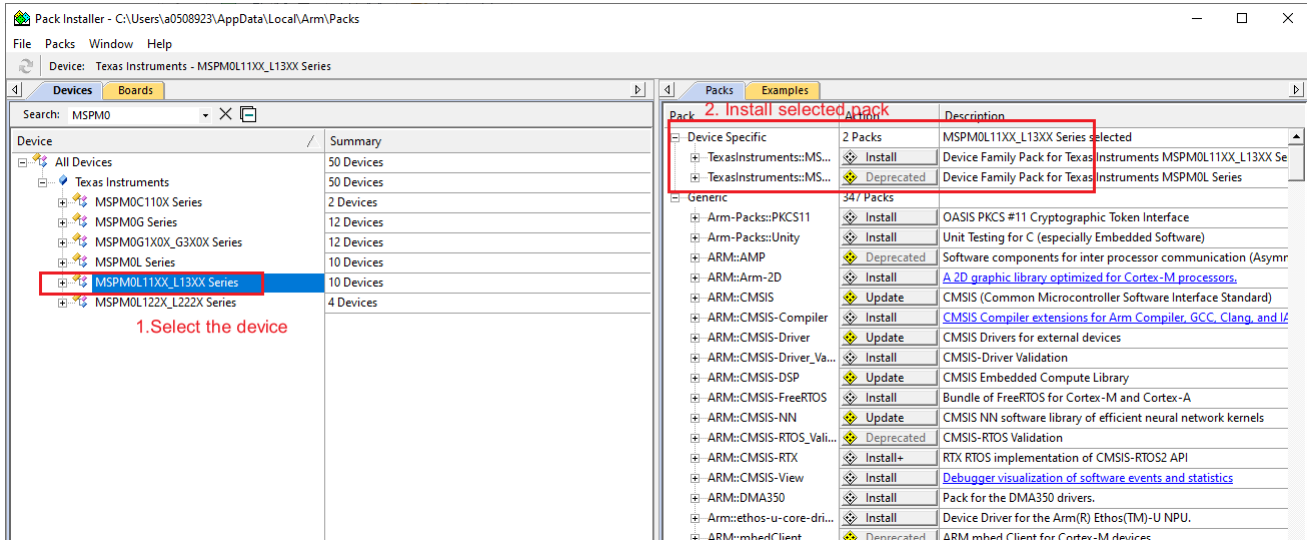

**Figure 3-35. Install Device Pack**

### 4. After approving the license terms, the pack is successfully installed.

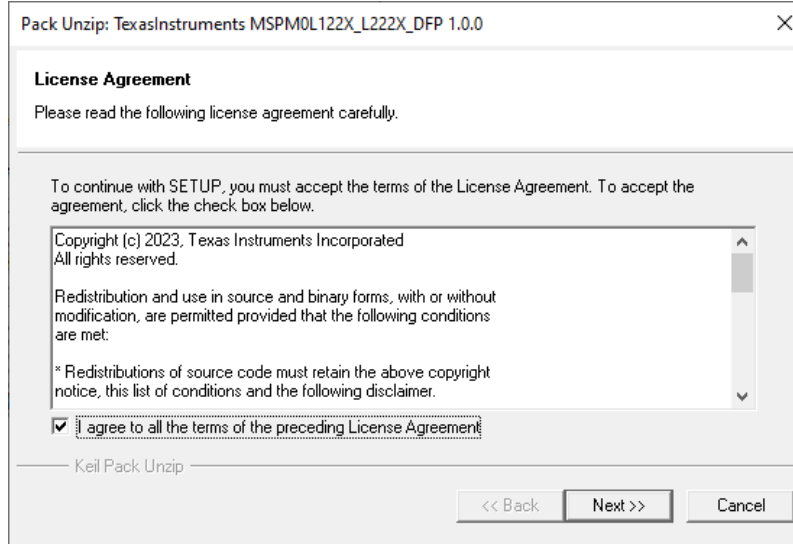
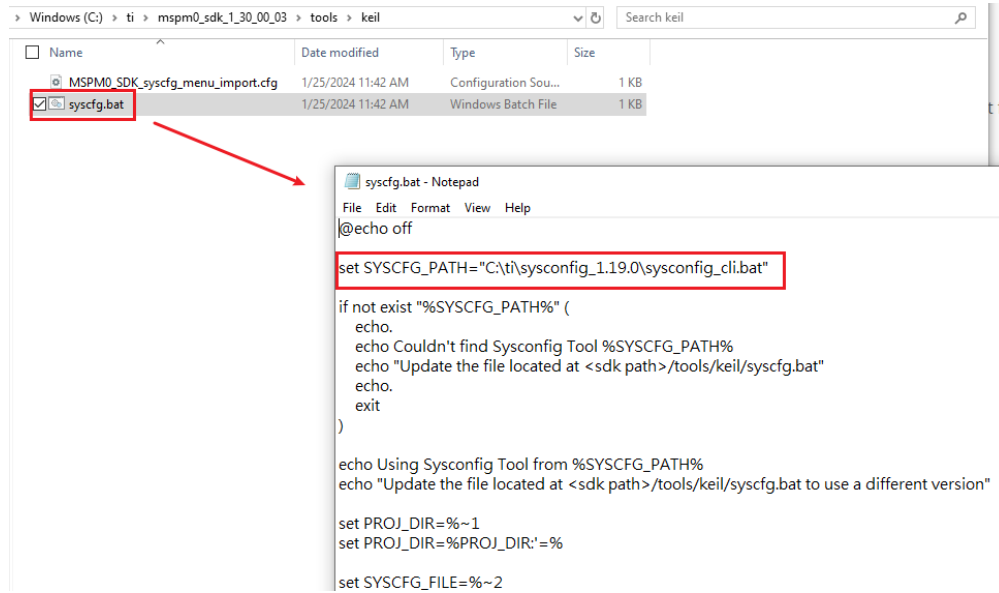

**Figure 3-36. Approve the License**

### 3.4.3.1.2 Sysconfig Support Setup

If SysConfig is required, follow the steps below to enable use. Make sure that SysConfig and SDK are installed ahead. Here, we use SDK v1.30 and SysConfig v1.19 as an example.

1. Navigate to the SDK folder ( ...\ti\mspm0\_sdk\_x\_xx\_xx\_xx\tools\keil). Edit SysConfig path in *syscfg.bat* to match the downloaded standalone SysConfig address.



**Figure 3-37. Edit syscfg.bat**

2. In the same folder, open another file for editing. Modify the SysConfig and SDK versions and paths.

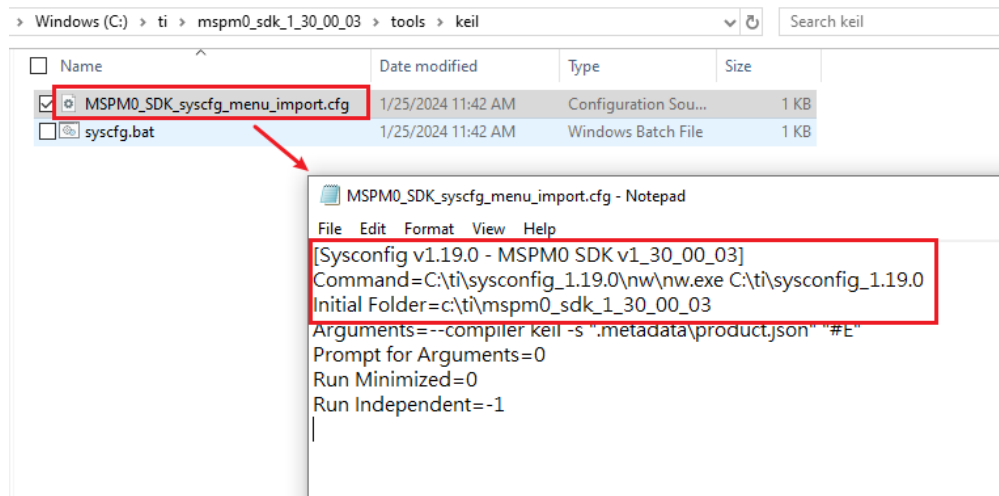

**Figure 3-38. Edit MSPM0\_SDK\_syscfg\_menu\_import.cfg**

3. In Keil, select *Tools* → *Customize Tools Menu* from the menu.

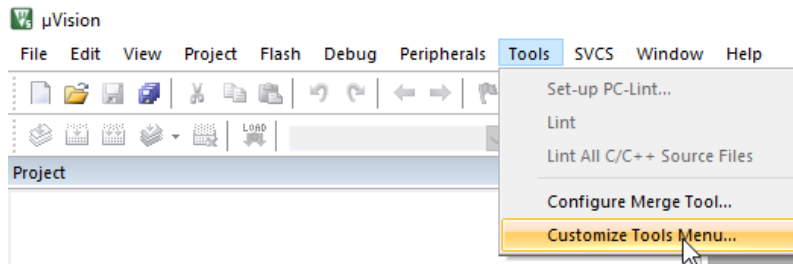

**Figure 3-39. Keil Customize Tools**

4. Import MSPM0\_SDK\_syscfg\_menu\_import.cfg file into the *Customize Tools Menu*.

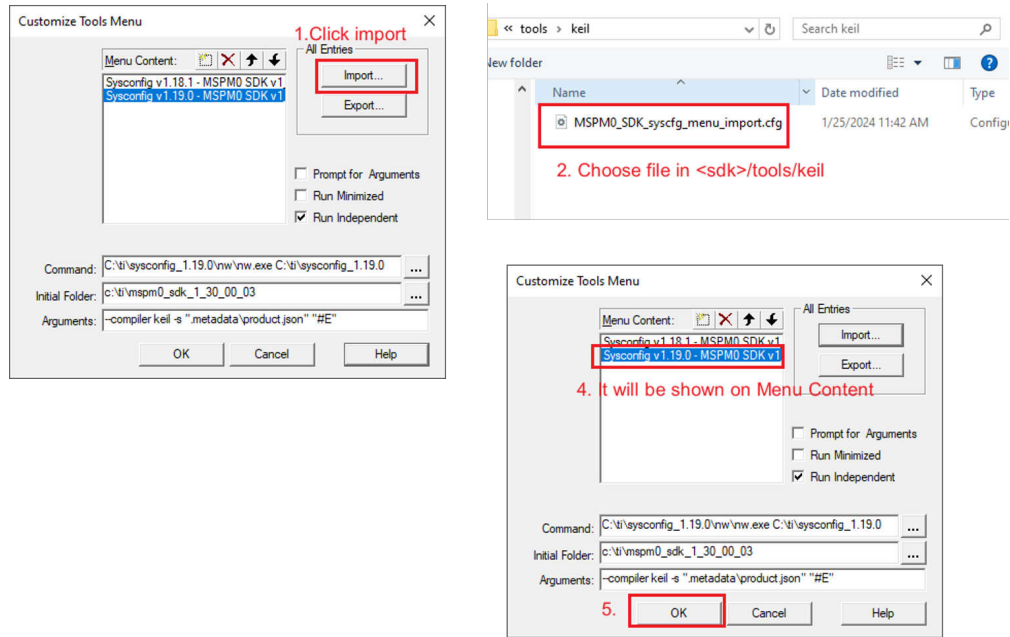

**Figure 3-40. Import MSPM0\_SDK\_syscfg\_menu\_import.cfg File**

5. The SysConfig entrance now appears on the menu. You can use SysConfig for MSPM0 development on Keil.

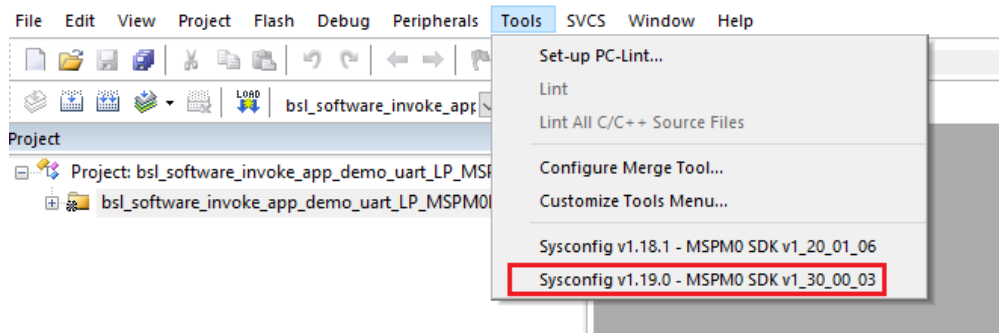
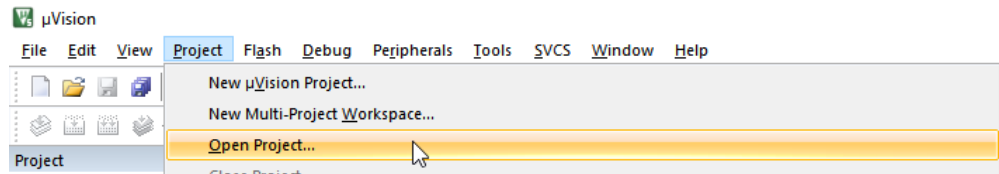

**Figure 3-41. Finish SysConfig Setup**

**3.4.3.2 Import a SDK Example**

Here is the guide that explains how to import a MSPM0 SDK example into Keil:

1. In Keil, select *Project* → *Open Project*.



**Figure 3-42. Open Project**

2. Select a demo project from SDK. For the nortos example, use the .uvprojx project file. For the RTOS example, use .the uvmpw work space file. An example is shown in [Figure 3-43](#).

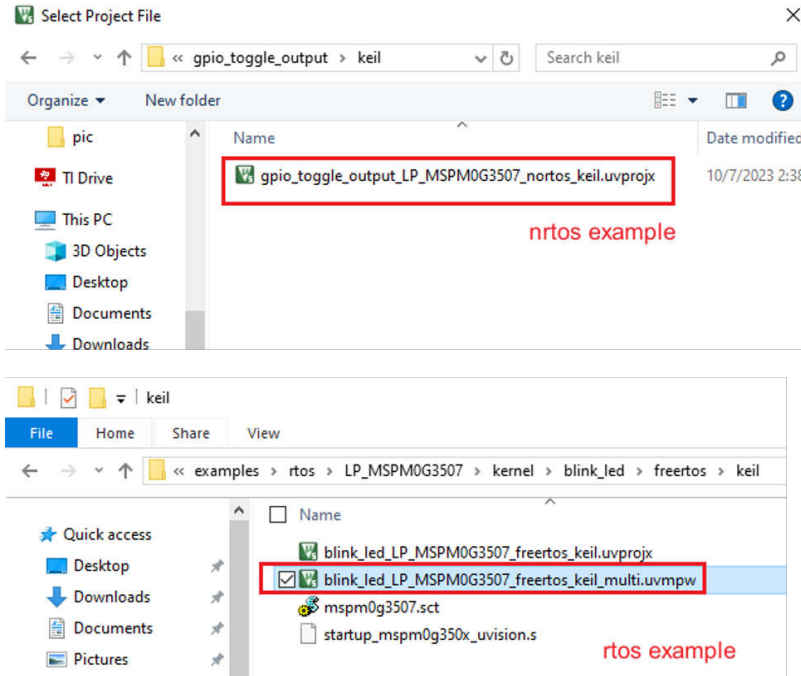

**Figure 3-43. Select Keil Project**

- To open the .syscfg file, double click the .syscfg file. Then, select *Tools* → *Sysconfig v1.19.0 - MSPM0 SDK v1\_30\_00\_03*. The .syscfg file opens in a separate window.

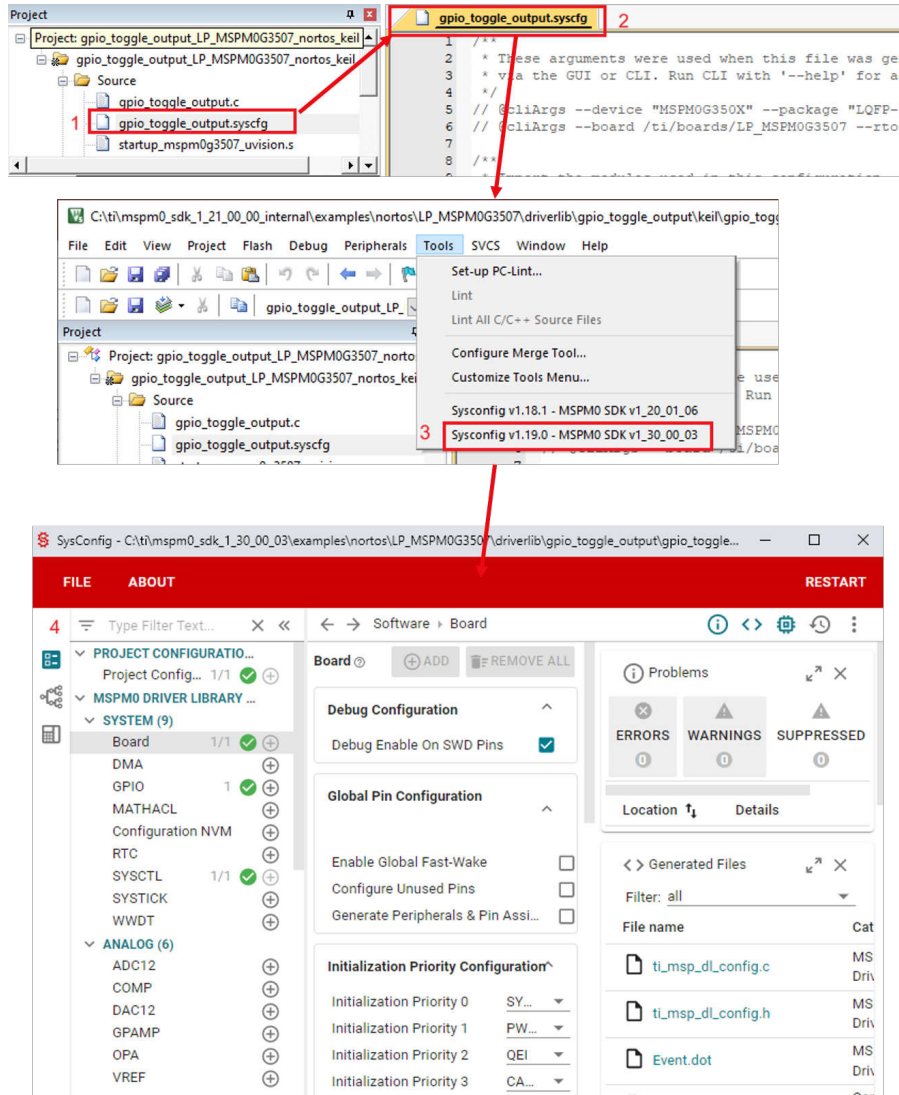

Figure 3-44. Open .syscfg file

### 3.4.3.3 Example Download and Debug

Here is the guide that explains how to download the code into MSPM0 based on Keil:

- Right-click project files, then select *open options for target*

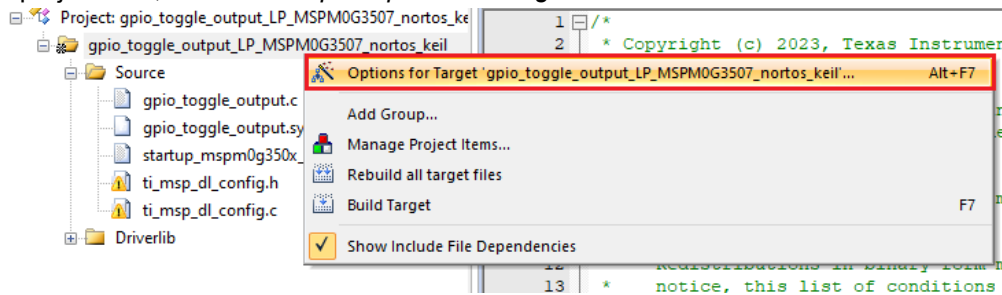
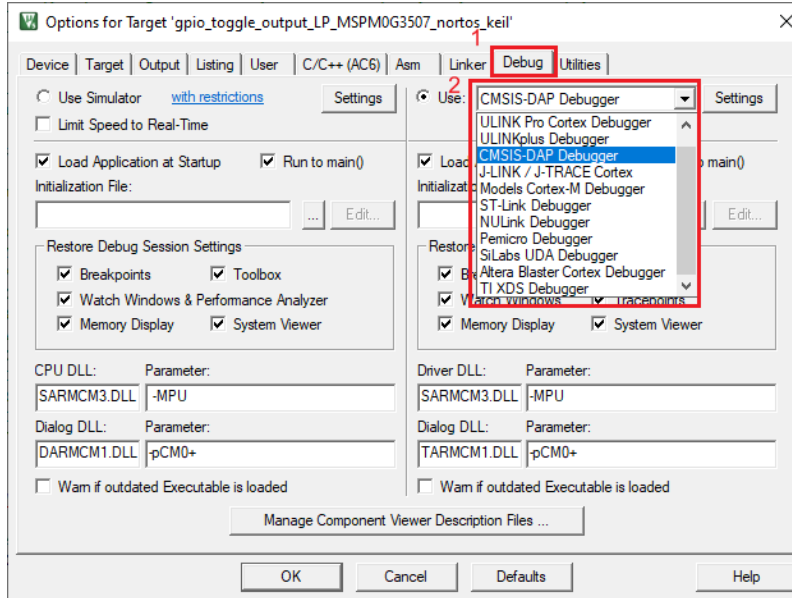

Figure 3-45. Open Options for Target

- Select a debugger from the *Target Options* window. To use XDS-110, select *CMSIS-DAP Debugger*. If J-Link is required, then select *J-LINK/J-TRACE Cortex*.



**Figure 3-46. Select the Debug Pane**

- Click on the *Settings* button. On the *Debug* tab, make sure the settings match with [Figure 3-47](#) and [Figure 3-48](#).

### XDS110

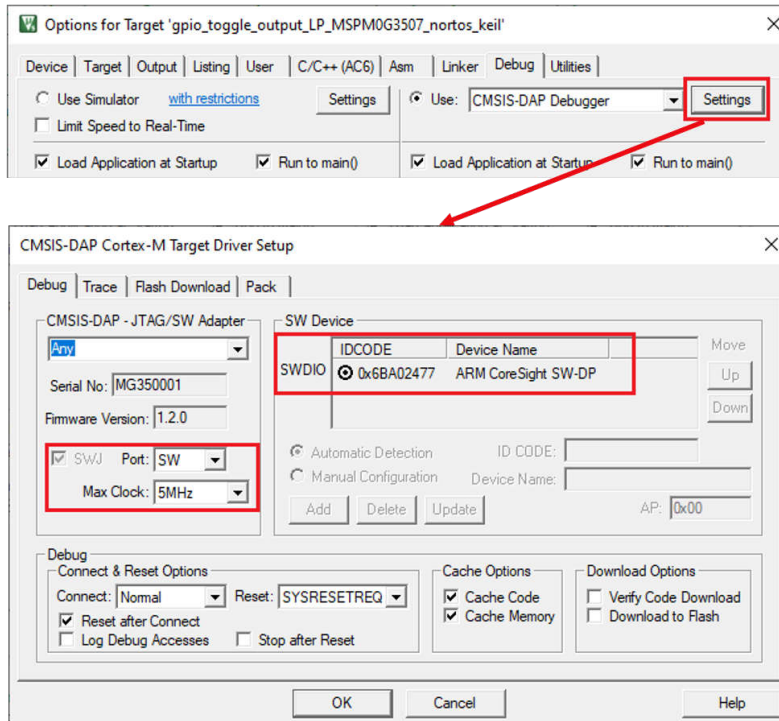

**Figure 3-47. Check the Setting of XDS110 Probe**

## J-Link

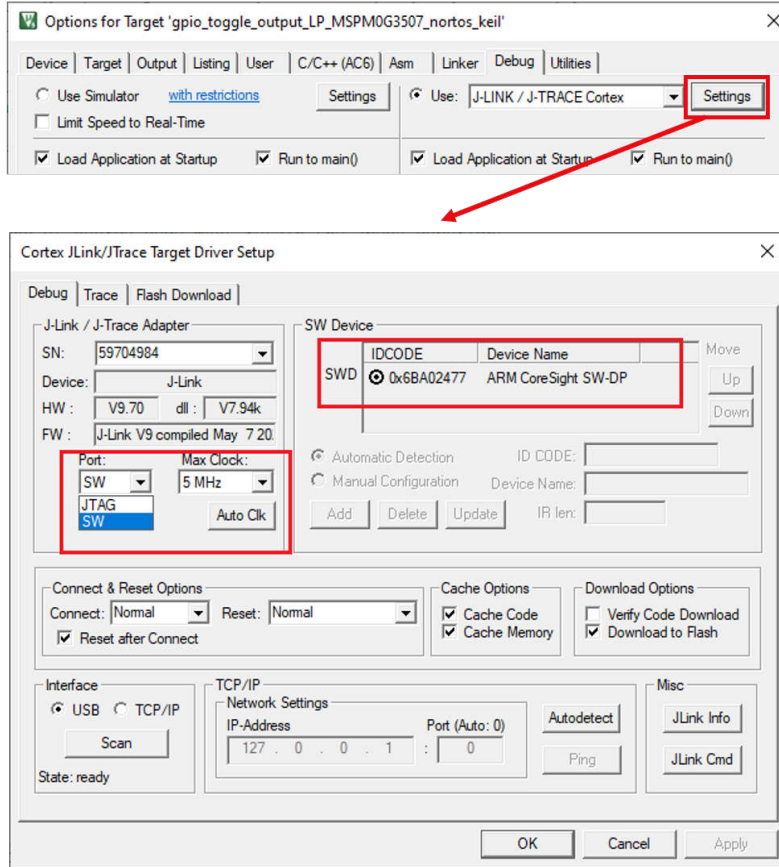

**Figure 3-48. Check the Setting of J-Link Probe**

- Click on the *Flash Download* tab and check whether the description matches [Figure 3-49](#). If this does not match, then click on the *Add* button and select the corresponding MSPM0 MAIN option. The device type is *On-chip Flash*. At last select *Reset and Run*.

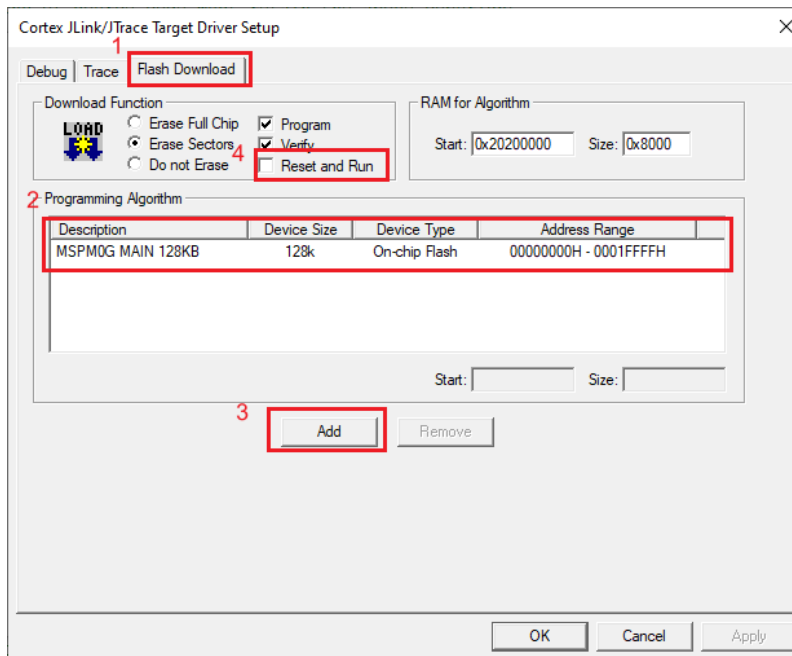

**Figure 3-49. Flash Download Setting**



- Click the *Build* button to build the project, then click the *Load* button.

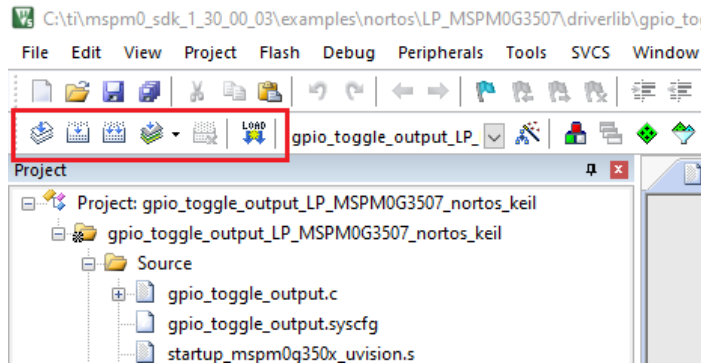

Figure 3-50. Download Project

- To build the FreeRTOS supported example, select *Project* → *Batch Setup* and select all the project targets for the build. Next, select *Batch Build* to build all the projects in the workspace.

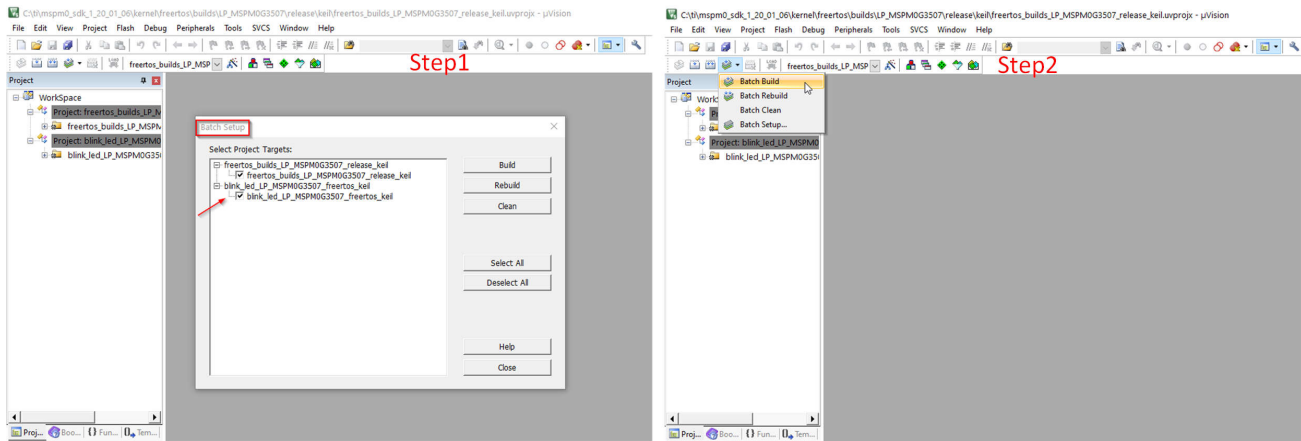
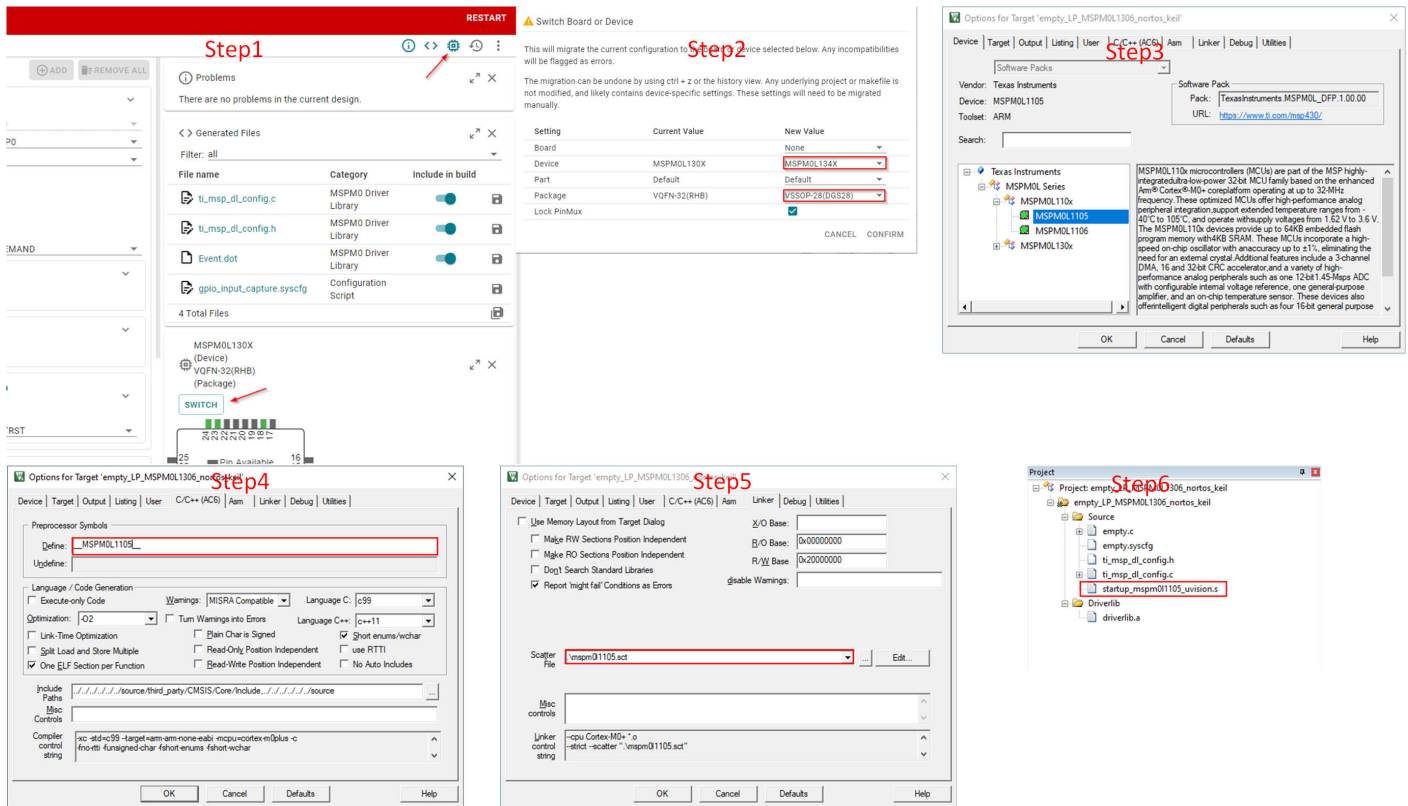

Figure 3-51. Build RTOS Example Under Keil

#### 3.4.3.4 Migrating Between MSPM0 Derivatives

SysConfig allows for an easier migration between MSPM0 derivatives. However some manual modifications are required on Keil. Follow the steps below:

- In SysConfig, enable the Device View and click on *SWITCH*.
- Select the corresponding options for the new MSPM0 device and click *CONFIRM*. Note that SysConfig highlights any conflicts with the migration, such as unavailable pins and peripherals. Fix any conflicts as needed.
- In the Keil IDE, open the *Device* tab in project options, and select the new MSPM0 derivative.
- Update the device definition by selecting *C/C++ (AC6)* → *Preprocessor Symbols* → *Define*. Add the device definition as per the device selected.
- Update the linker file in *Linker* → *Scatter File*. The MSPM0 SDK includes default files for all MSPM0 derivatives at `<sdk>\source\ti\devices\mspm0p\linker_files\keil`.
- Add the startup file of the new derivative to the project and remove existing one. The MSPM0 SDK includes default files for all MSPM0 derivatives at `<sdk>\source\ti\devices\mspm0p\startup_system_files\keil`.



**Figure 3-52. Migrating Between MSPM0 Derivatives**

**3.4.3.5 Generate Hex Files**

Here is the instruction to generate hex files in Keil. Click *Project* → *Options* → *Output* → *Create Hex File* → *OK*. You can select the paths through click *Select Folder for Objects* to locate the HEX file. The default path is the object folder under project file.

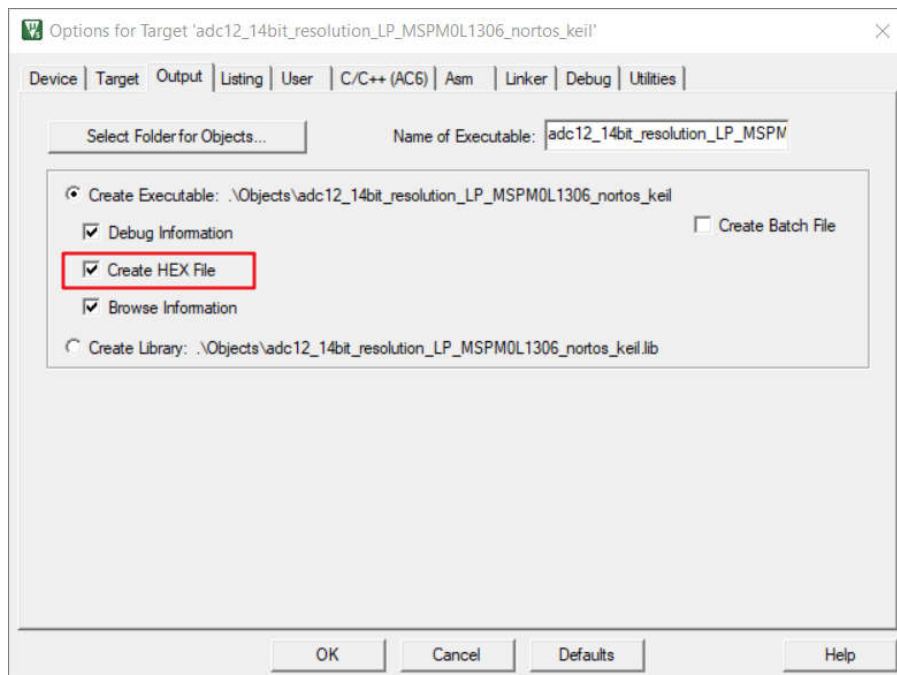

**Figure 3-53. Generate Hex Files**

### 3.4.3.6 Program NONMAIN

If users make the changes on Bootloader or MCU security setting by configuring the NONMAIN, as shown in Section 3.3.2.4, then users need to enable the NONMAIN Erase in the IAR setting as well. Follow the steps below, otherwise and keep the default:

1. Click *Options* → *Debug* → *Settings* → *Flash Download*.
2. Add the NONMAIN programming algorithm, and then click *OK*.

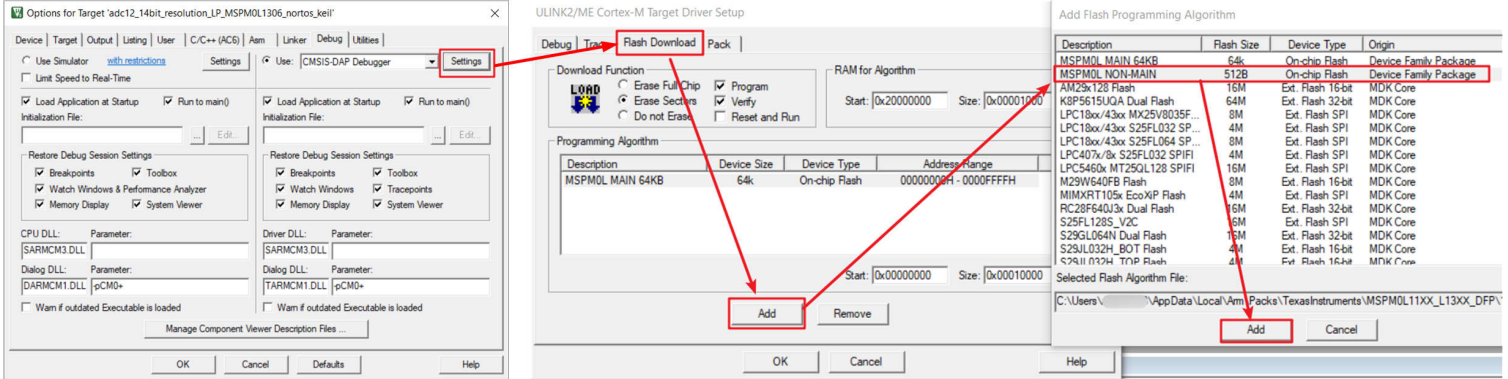

Figure 3-54. Program NONMAIN

## 4 Hardware Design Instructions

### 4.1 Obtaining a MSPM0 Package

To obtain a MSPM0 package, use the Ultra Librarian tool on TI.com. The detailed instructions are as below.

1. Go to the start page of the Ultra Librarian tool under the MSPM0 device page using the steps.

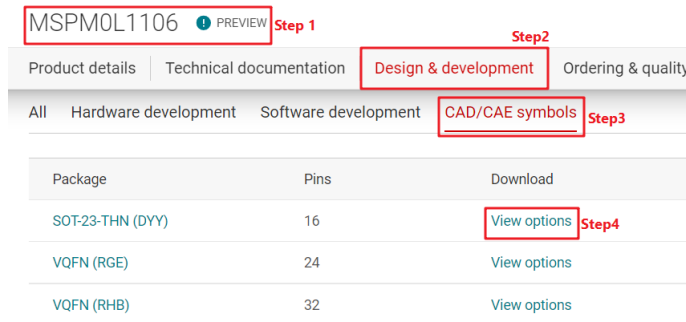

Figure 4-1. Ultra Librarian Tool Start Page

2. Select the desired CAD format and pin ordering to obtain the Altium design library file.

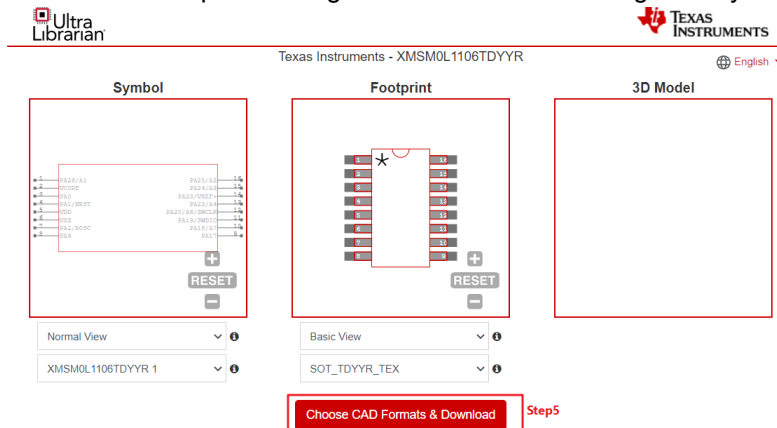

Figure 4-2. Ultra Librarian Tool Device Selection

3. The Altium Designer library file is used as an example.

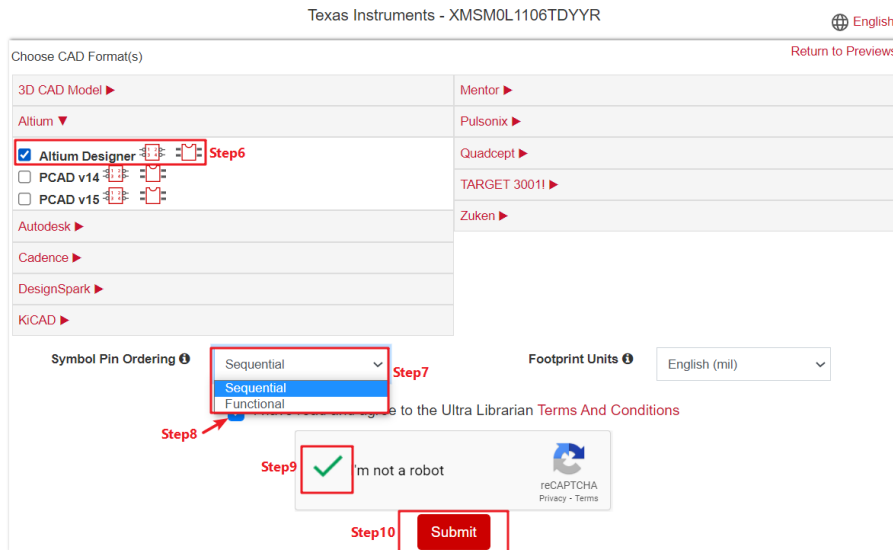

Figure 4-3. Ultra Librarian Tool CAD Download

4. Run the *Altium Designer* script.

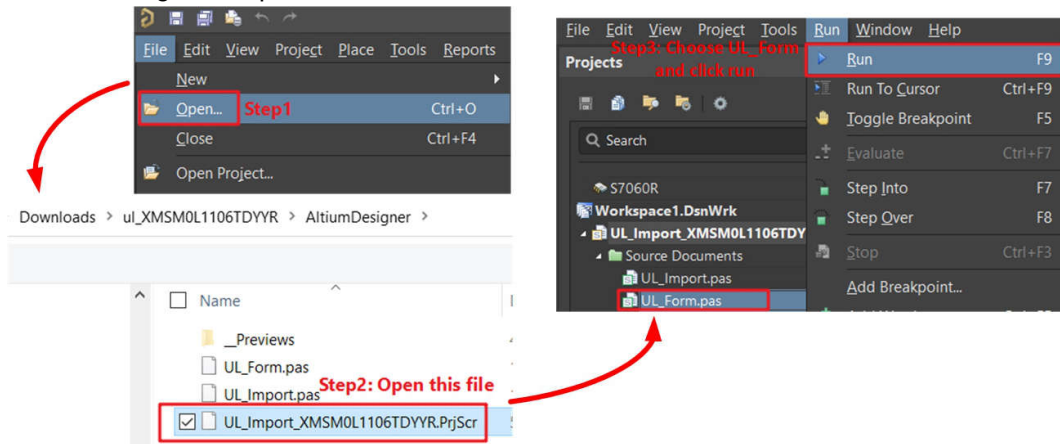

Figure 4-4. Run Altium Designer Script

5. Generate the PCB library and schematic library as shown in Figure 4-5.

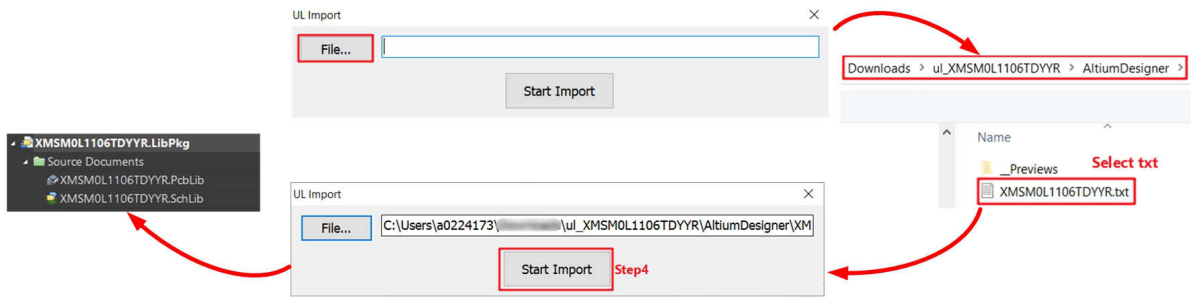

Figure 4-5. Generate Library

6. Select the correct footprint under PCB Library.

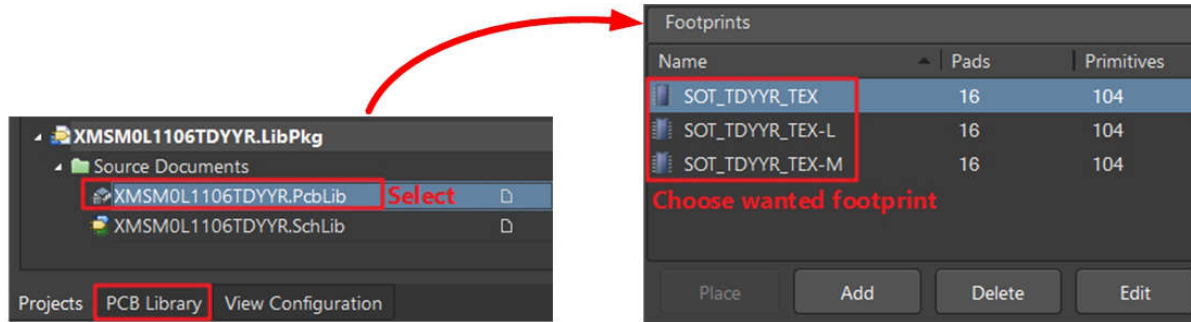

Figure 4-6. Select Footprint

7. Import the PCB library and schematic library.

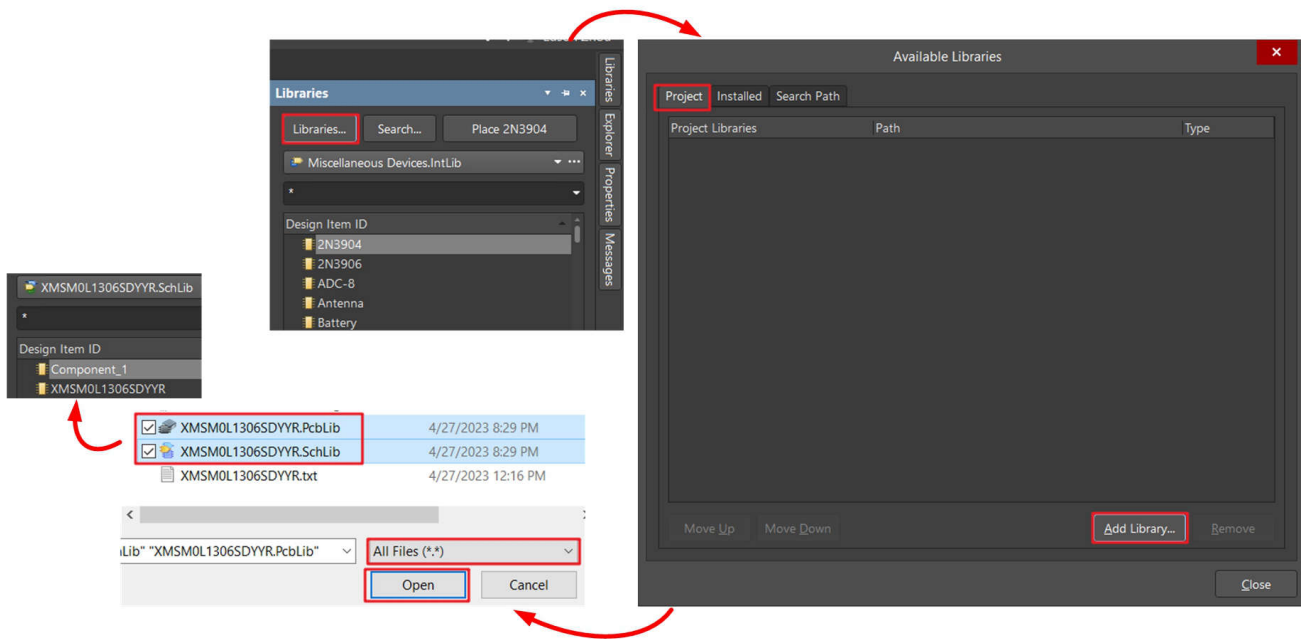

Figure 4-7. Import Library

## 4.2 Fix Pin Functions through Sysconfig

TI recommends hardware engineers use the *Peripherals and Pin Assignments File* to fix the pin functions with assistance from a software engineer by following the instructions in Figure 4-8.

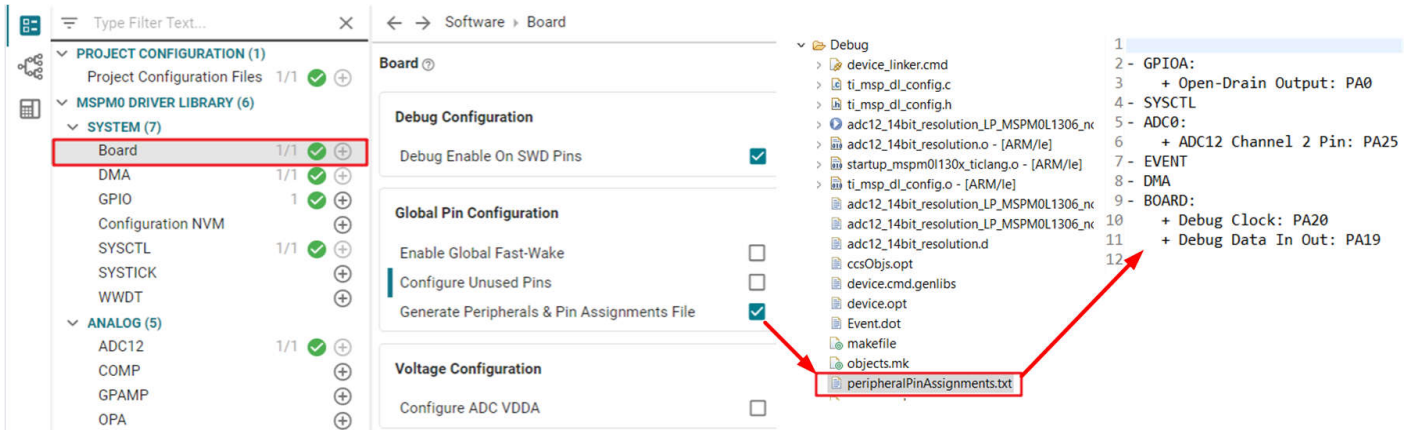

Figure 4-8. Generate Peripherals and Pin Assignments File

## 4.3 Schematic and PCB Attention

The minimum requirements (power, reset, and Vcore) with suggested values for MSPM0 hardware setup are shown in Figure 4-9.

- **Power pin:** TI recommends adding 10uF and 0.1uF capacitors, which are used to remove AC noise on the power rail.
- **Reset pin:** TI recommends adding a 47kR pullup resistor and a 10nF pulldown resistor. This makes sure that the MSPM0 releases from reset, after the power rail is stabilized.
- **Vcore pin:** This pin is used to stabilize the CPU voltage. For some MSPM0 devices, this pin is not included. If the pin is included, connect the pin to a 0.47uF capacitor.

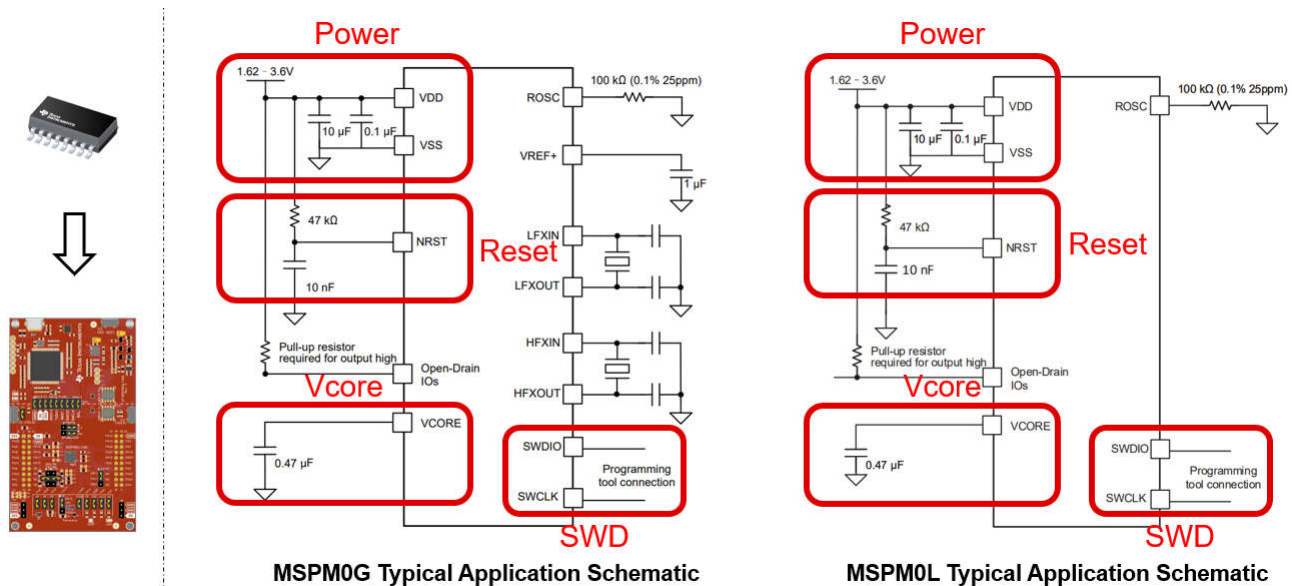
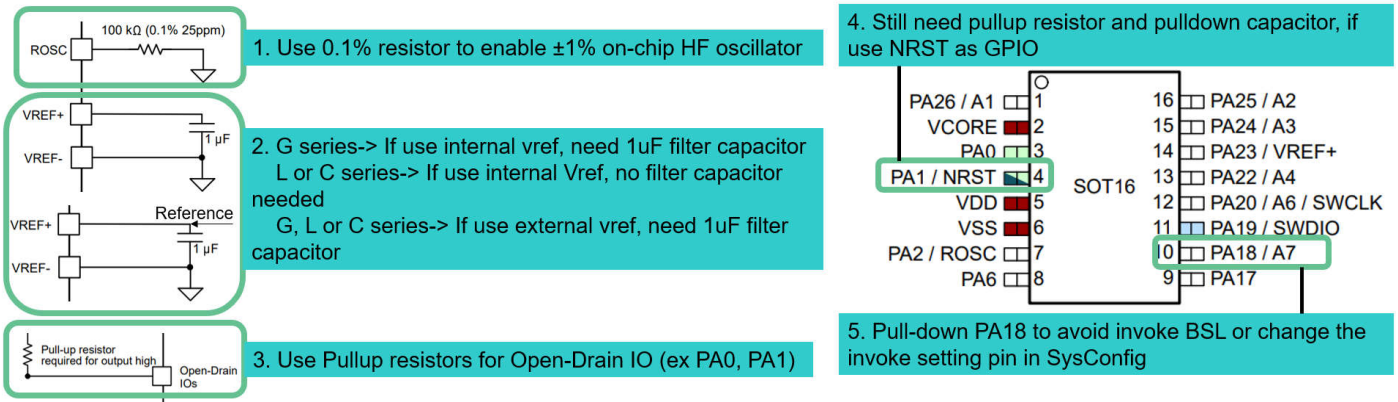

Figure 4-9. MSPM0 Minimum System

Other considerations when drawing a schematic file are listed in Figure 4-10.

- **ROSC Pin:** If users want to reach accurate high frequency clock with internal SYSOSC, then 0.1% resistor is suggested. Some low-cost devices cannot have this function.
- **VREF+/VREF- Pin:**

- If using an internal reference, then the G series require a 1uF capacitor between VREF+ and VREF- to support 4MSPS ADC. For L or C series, then the capacitor is not required as the ADC speed is only support 200KSPS with internal Vref.
- If using an external reference, then all the MSPM0 devices require a 1uF capacitor between VREF+ and VREF-.
- **Open-Drain IO:** Open-Drain IO cannot output high voltage from the MCU side, so external pullup resistors are required, such as a 4.7kR capacitor.
- **Reset Pin:** If reusing the reset pin as GPIO, I2C or UART, then the pullup resistor and the pulldown capacitor are still required. This makes sure that the MCU is released from reset state after the power is stable. TI recommends reducing the resistor and capacitor, such as using a 2.2kR pullup resistor and 10pF pulldown capacitor.
- **PA18:** PA18 is the invoke pin to enter bootloader. Make sure this pin is not in pullup or affected by noise or analog signals with this pin floating. Otherwise, the device enters the bootloader instead of the application code. More details and a software option to change and disable the invoke pin in sysconfig are shown in [Section 7.4](#).



**Figure 4-10. MSPM0 Schematic**

For further information about schematics or PCB design references, see the following links.

- [MSPM0 L-Series MCUs Hardware Development Guide](#)
- [MSPM0 G-Series MCUs Hardware Development Guide](#)
- Device-specific MSPM0 Launchpad EVM user's guide
- Device-specific MSPM0 data sheet

## 5 Mass Production Instructions

An overview of the program software and tools is shown in [Figure 5-1](#). The available interface is JTAG (SWD) and Bootloader (BSL). J-Link and C-GANG only support SWD. XDS110 supports SWD and Bootloader over UART.

J-Link and XDS110 can only program one MSPM0 at a time. C-GANG can program six MSPM0s at one time.

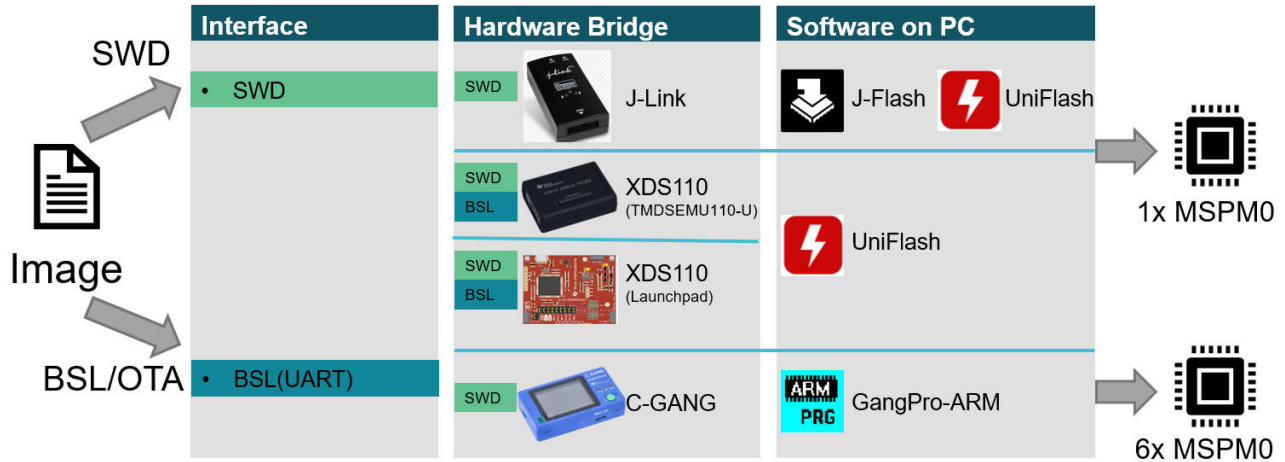

Figure 5-1. Program Software and Tools

For more implementation about bootloader, see [MSPM0 Bootloader \(BSL\) Implementation](#). For more production programming tools, see [E2E page](#).

### 5.1 Generate Production Image

[Table 5-1](#) lists different types of image generated by different IDEs. For the step by step generation guidance, see [Section 3.4](#).

Table 5-1. Product File Generated by IDE

IDE	TI_TXT (.txt)	Intel hex (.hex)	bin (.bin)	Step by Step Guidance
CCS	Y	Y	Y	<a href="#">Link</a>
IAR	Y	Y	Y	<a href="#">Link</a>
Keil	N	Y	N	<a href="#">Link</a>



## 5.2 Program Software Tools Quick Start

### 5.2.1 Uniflash Quick Start

This section describes how to install the UniFlash tool with TI's MSPM0 devices. See the [UniFlash Quick Start Guide](#) for more information.

#### 5.2.1.1 Program Through SWD

The debugging interface such as XDS110 can be used by UniFlash to program the device. The needed hardware pins are SWDIO, SWCLK, 3V3 and GND. Follow the steps below:

1. Follow the steps to select the debugger (either XDS110 or J-Link). Then click *Start* to start program.
2. If NONMAIN must change, change the erase setting before programming. If this is not required, keep the default option.
3. Select the image and start to program by clicking *Load Image*.
4. Using the *Memory* tab, UniFlash can also inspect the flash memory of the device simply by selecting *Read Target Device*.

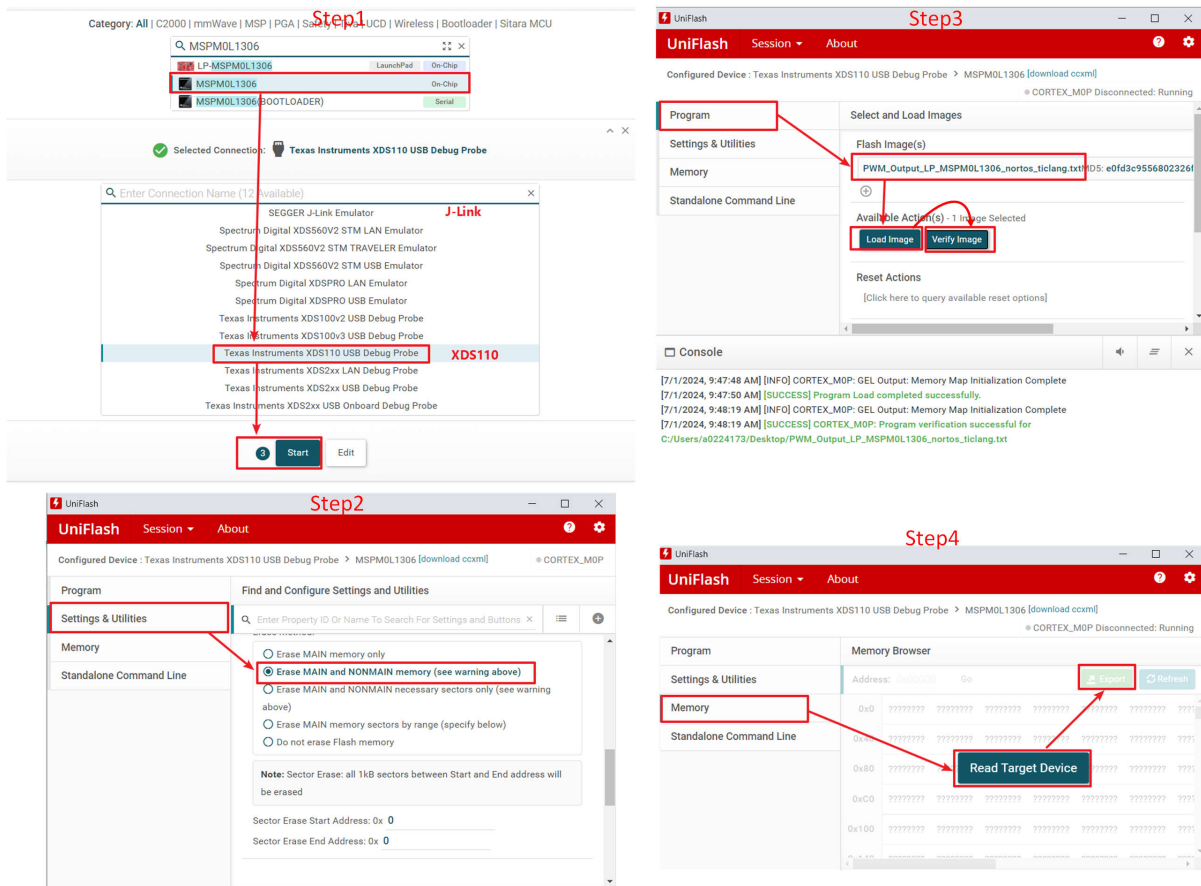
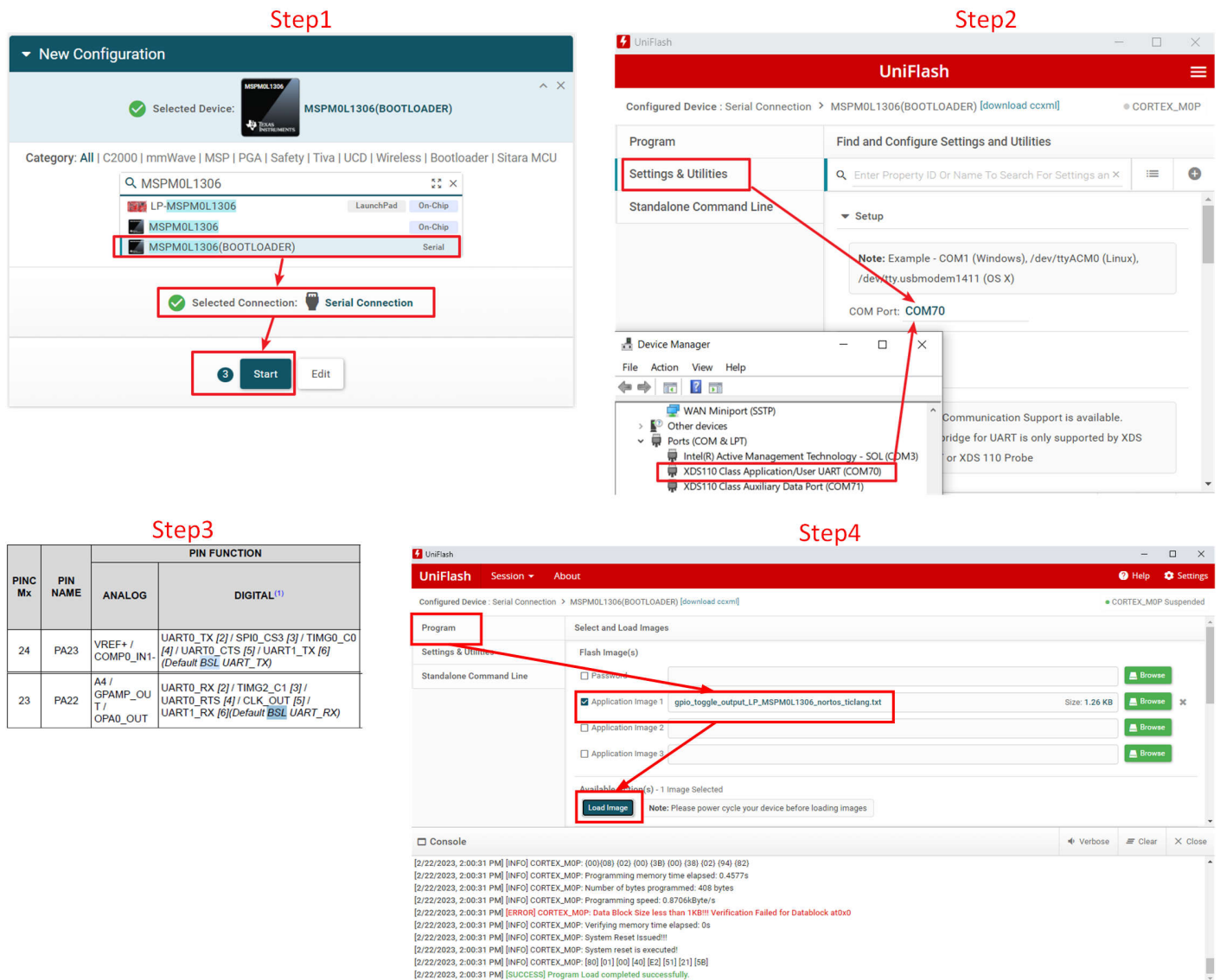

Figure 5-2. Program Through SWD

#### 5.2.1.2 Program Through Bootloader

Here are the steps to program MSPM0 through bootloader using Uniflash. The required hardware pins are TX, RX, 3V3, GND and invoke pins.

1. Search the device name and select the bootloader option for the device.
2. Check the COM port by referring to the device manager.
3. Check the UART Bootloader port by referring to the data sheet.
4. Finish the hardware connection (RX, TX, 3V3, GND, Invoke) and start program.



**Figure 5-3. Program Through Bootloader**

### 5.2.1.3 Program Through CMD Line Interface

For this requirement, see this [E2E](#) thread.

### 5.2.2 JFlash Quick Start

This instruction is based on J-Flash V7.92n. TI recommends using the latest J-Flash version, which supports all the latest versions of MSPM0. Use the following steps to program MSPM0 with J-Flash:

1. Click *New project*.
2. Select the related MSPM0 part number.
3. Select the desired programming memory. If NONMAIN does not need to change, deselect *NONMAIN memory*.
4. Click *Connect device* and click *Production Programming*.
5. A confirmation screen appears.

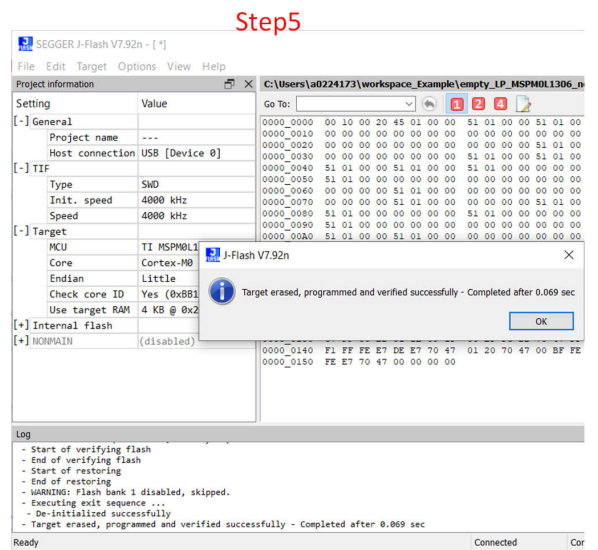
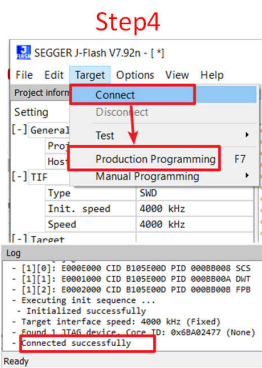
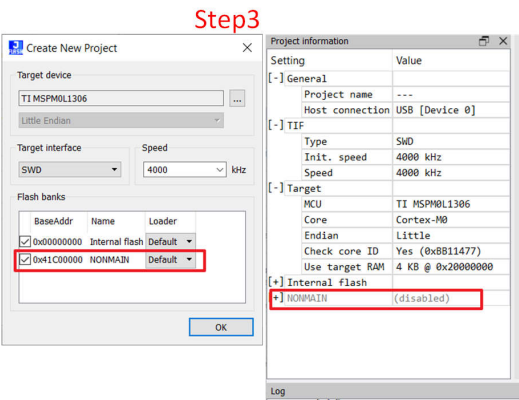
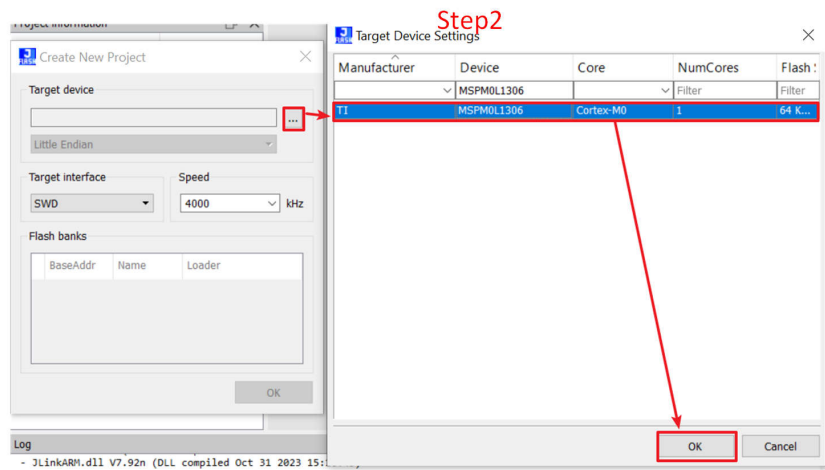
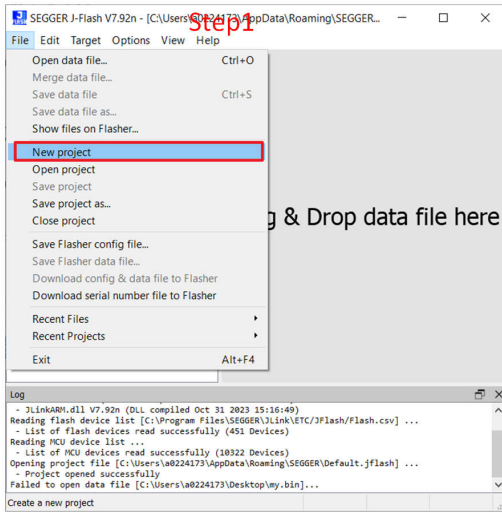

Figure 5-4. J-Flash Quick Start

### 5.2.3 C-GANG Quick Start

This section shows how to use C-GANG to do the MSPM0 online and offline program. For more advanced usage, like setting password or Factory Reset, refer to the user's guide in the [C-GANG product page](#) and [TI-CGANG-MSPM0](#) video.

1. Please follow the steps bellow to finish [GangPro-ARM](#) GUI installation and [USB driver](#) installation.

#### Step1

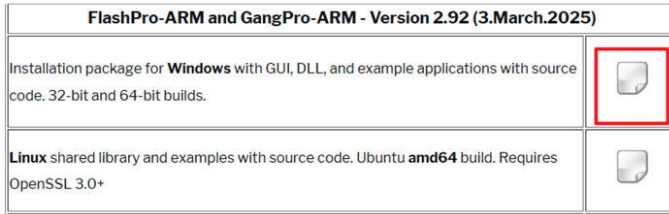

#### Step2

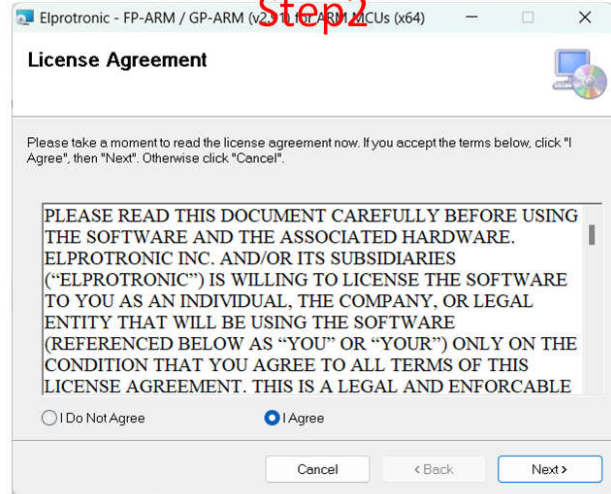

#### Step3

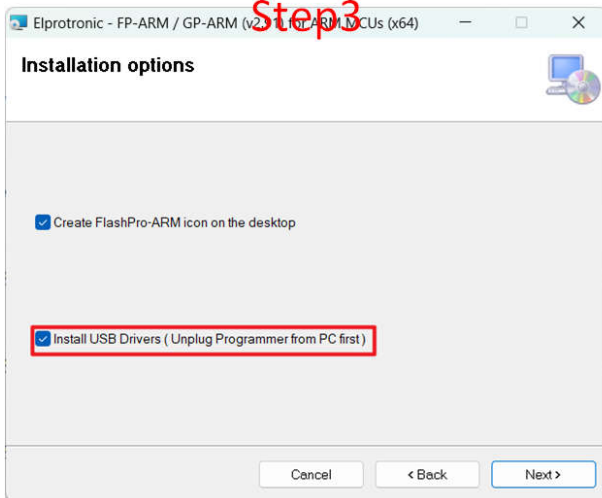

#### Step4

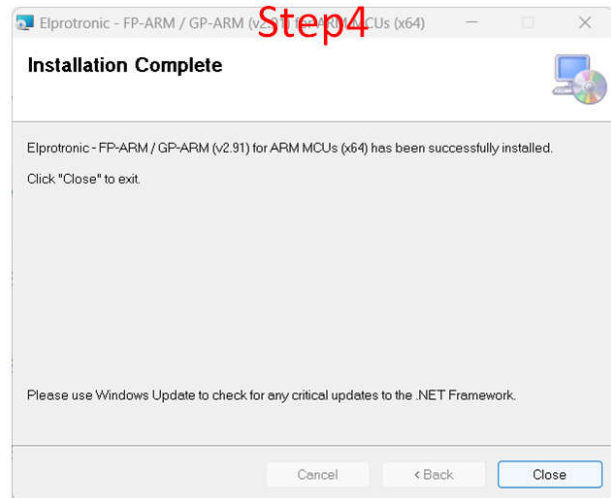

#### Step5

Description	Download Link
USB drivers for Elprotronic products: XS, X2S, SC-GANG, and CMSIS-DAP 2.0, with support up to Windows 11 (24H2) where applicable (11.Oct.2024)	

#### Step6

Name	Date modified
A long time ago	
 XS-DriverUninstaller.exe	10/11/2024 1:30 PM
 XS-DriverInstaller.exe	10/11/2024 1:30 PM
 WIN-64	10/11/2024 1:31 PM
 WIN-32	10/11/2024 1:31 PM

**Figure 5-5. GangPro-ARM Install**

2. Finish connection between C-GANG and the connector board, as shown in [Figure 5-6](#). Finish the pin connection between MSPM0 and C-GANG. The least used pins are VCC, GND, SWDIO, SWCLK. If users want to use “Clear Locked Device” function, reset pin is also needed.

VCC	1	2	TMS / SWDIO
GND	3	4	TCK / SWCLK
RX	5	6	TDO
TX	7	8	TDI
TST	9	10	RST



**Figure 5-6. C-Gang Pin Assignment**

- After the hardware setup is finished, follow the programming steps. If users open the GUI, then users can go through step 2 to scan the C-GANG. In step 3, see [Section 5.1](#) to generate the code file. Remember the enabled target is related to the hardware port used, which is labeled numerically next to the port.

Step1

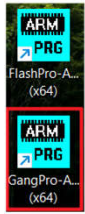

**Step2**

Adapter Communication Options

Communication via USB [ all adapters ]

Select the serial number of the desired FPA to connect to this software.

FPA list ( 1 ... 8 )

- 63000010 - C-GANG - (TI) C-GANG-TI

Refresh USB Device List

Communication via UART [ S-GANG only ]

Select the COM port of the desired FPA to connect to this software.

COM Port List

Available COM Ports: NONE

Baud Rate: 38400

Refresh COM Port List

XStreamPro Adapter's Ethernet Options (Internal - Not Connected)

Successfully test connection to modify internal settings

Disable LAN when USB communication is active

Factory MAC Address: 00 00 00 00 00 00

Custom MAC Address: 00 00 00 00 00 00

IP Address Assignment ->  DHCP  Fixed IP

Use the following IP address:

IP address: 0.0.0.0

Subnet mask: 0.0.0.0

Default gateway: 0.0.0.0

Save to XStreamPro | Reload from XStreamPro

Connect to XStreamPro Adapter using these Settings (GUI/DLL)

LAN Connection ->  First found  IP  MAC  SN

Destination IP/MAC/SN

Label Check

Software will use this Adapter

FPA:SN 630101552

Interface Type=3, Access Key=1

HW PN=C-GANG-1.0

Adapter Desc=C-GANG-TI

Test Connection

Done

Accept

Exit

**Step3**

GangPro-ARM (Gang Programmer for ARM MCUs) - Elprotronic Inc. (version 2.91, x64)

File View Setup Serialization Measurement Standalone About/Help

Open Code File: C:\User... \adc12\_14bit\_resolution\_LP\_MSPM0C1104\_nortos\_ticlang.txt

Append | Power DN/OFF | RESET

Interface: SWD Fast(2w) | Speed: 5.00 MHz

Microcontroller Type

Vendor: TI-MSP | Status: Pass

Family: MSPM0 Cortex M0

Group: MSPM0C Series

Name: MSPM0C1104

Target: MSPM0C1104

MCU Vcc: 3.3V | Enable

Target Devices Programming Result

Target Enable	1	2	3	4	5	6	7	8
<input checked="" type="checkbox"/>	<input type="checkbox"/>	<input type="checkbox"/>	<input type="checkbox"/>	<input type="checkbox"/>	<input type="checkbox"/>	<input type="checkbox"/>	<input type="checkbox"/>	<input type="checkbox"/>
Erase/Blank Check	<input checked="" type="checkbox"/>	<input type="checkbox"/>	<input type="checkbox"/>	<input type="checkbox"/>	<input type="checkbox"/>	<input type="checkbox"/>	<input type="checkbox"/>	<input type="checkbox"/>
Program/Verify	<input checked="" type="checkbox"/>	<input type="checkbox"/>	<input type="checkbox"/>	<input type="checkbox"/>	<input type="checkbox"/>	<input type="checkbox"/>	<input type="checkbox"/>	<input type="checkbox"/>
Protection	<input checked="" type="checkbox"/>	<input type="checkbox"/>	<input type="checkbox"/>	<input type="checkbox"/>	<input type="checkbox"/>	<input type="checkbox"/>	<input type="checkbox"/>	<input type="checkbox"/>
Final Result	<input checked="" type="checkbox"/>	<input type="checkbox"/>	<input type="checkbox"/>	<input type="checkbox"/>	<input type="checkbox"/>	<input type="checkbox"/>	<input type="checkbox"/>	<input type="checkbox"/>

Memory Protection

Flash only

Enable

Lock Device

Clear Locked Device

Device Action

Reload Code File

Enable Blank Check

AUTO PROG. (F8)

VERIFY ACCESS

ERASE FLASH

BLANK CHECK

WRITE FLASH

WRITE SN / Model

VERIFY FLASH

READ / COPY

Read after A. PROG.

Script - none

AUTO PROGRAM

NEXT (F5)

Report

```
Erasing memory..... done
Flash programming.....
#1: .. failed
----- FAILED !!! -----
Unlocking target device..... OK
----- D O N E --- (run time = 1.3 sec.)
Communication initialization..... OK
#1: OSC=24.03 MHz, Sys.CLK=24.03 MHz
Erasing memory..... done
Flash programming.....
#1: .. OK
Verifying checksum.....
#1: .. OK
Writing Locking Registers.....
#1: .. OK
Writing Debug Registers.....
#1: .. OK
----- D O N E --- (run time = 1.3 sec.)
```

Selected Device Information

RAM - 1.0 kB; FLASH - 16.0 kB

Checksum from File and Options

Source: 0x01BC4892

Code: 0x01BC4892

Checksum from MCU Memory

1  0x01BC4892

2  3  4

5  6  7  8

Device Serialization

Cur. Model/Group:

Next Model/Group:

Target Device #1: 00000000

Target Device #2:

Target Device #3:

Target Device #4:

Target Device #5:

Target Device #6:

Target Device #7:

Target Device #8:

Next SN: Format: yyyj(d)J1234

Adapter: (TI) C-GANG-TI

Interface: SWD-fast(2w)

FPA:SN 630101552

Erase / Write memory option:

\* Flash Memory only \*

**Figure 5-7. Online Program**

- To change the code file in the non-main (SWD and BSL configure flash area), click the *Enable* button in the *memory protection* region. If it is not needed, please keep it disabled.

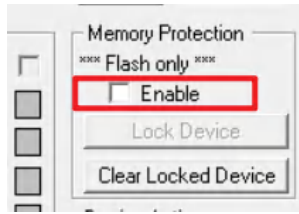

**Figure 5-8. Enable Non-Main Programming**

5. Save the code file and settings (Image) into C-GANG.

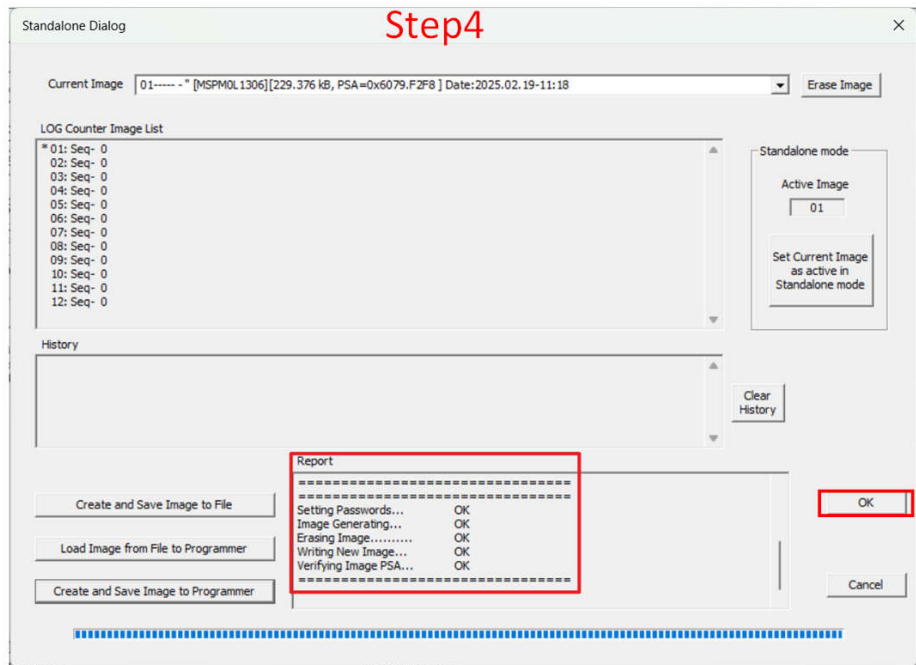
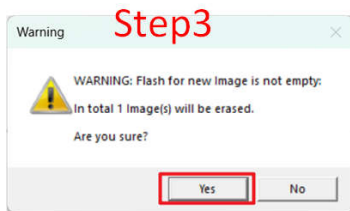
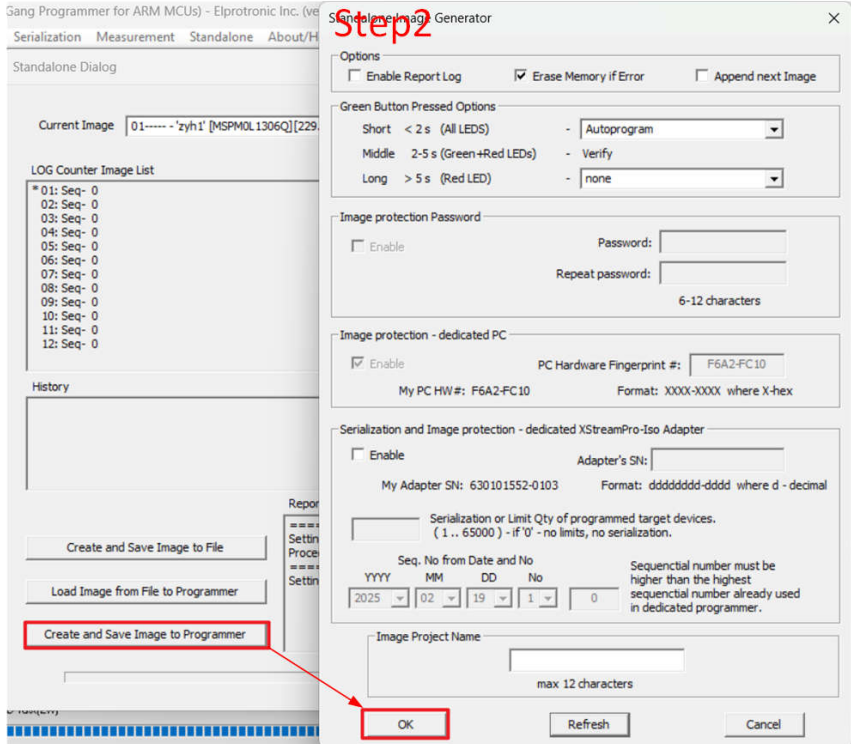
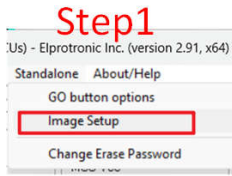

**Figure 5-9. Save Image**

6. Set the function for GO button.

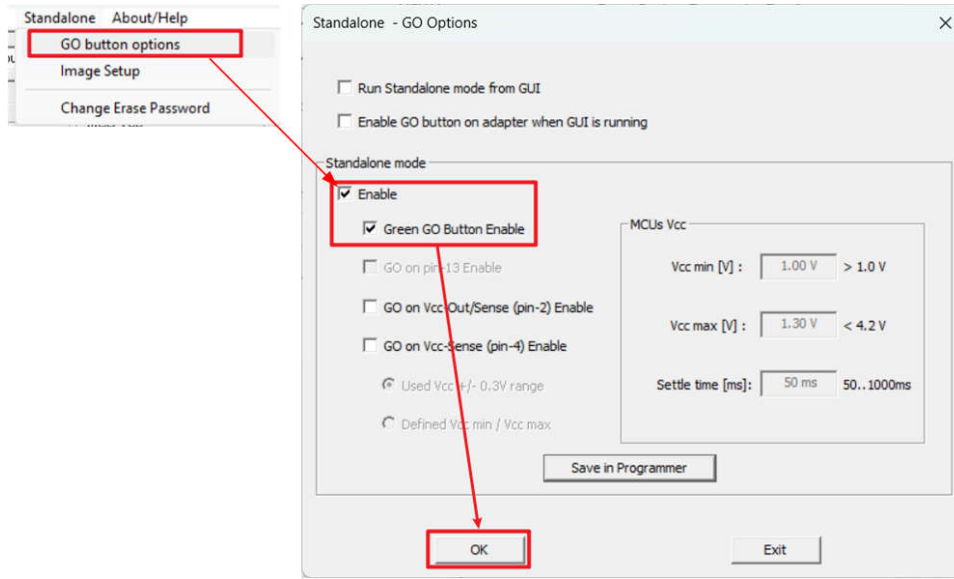

**Figure 5-10. Go Button Setting**

7. Now that the image is downloaded into C-GANG. Users can close the GUI to do the programming by pressing the green button.

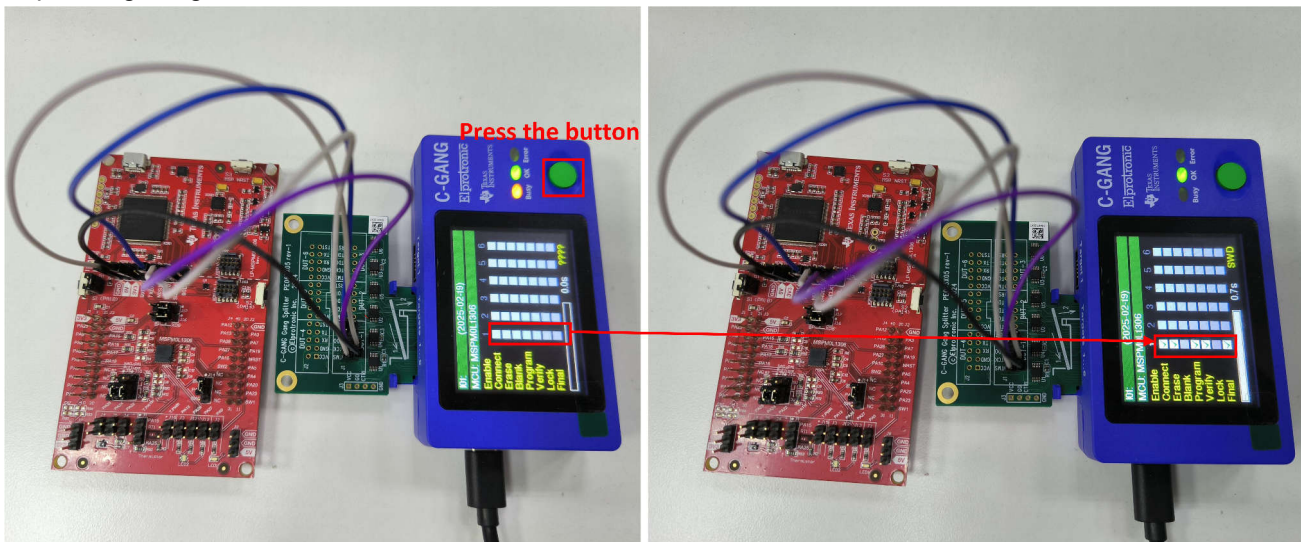

**Figure 5-11. Offline Downloading**



### 5.3 Program Hardwares Quick Start

Due to J-Link is commonly used and C-GANG hardware is already introduced in [Section 5.2.3](#), this section focuses on the XDS110 debugger. For more production programming tools, see [E2E page](#).

There are four different types of XDS110 debuggers available. The summary table is listed [Table 5-2](#).

**Table 5-2. XDS110 Debugger Summary**

Support Features	XDS110		XDS110 On Board	
	TMDSEMU110-U	MSPM0 LaunchPad	LP-XDS110	LP-XDS110ET
JTAG	Yes	No	Yes	Yes
SBW	Yes	Yes	Yes	Yes
EnergyTrace	Yes	Rely on type	No	Yes
MSPM0 bootloader	Yes	Rely on type	No	No
Comment	Highest Performance	Cheapest	Easy to use	Easy to use

With the [TMDSEMU110-U](#) device, the pin that is used is shown in [Figure 5-12](#). When using for bootloader, GPIOOUT0 must connect to the MCU reset pin. GPIOOUT1 must connect to the MCU invoke pin (PA18).

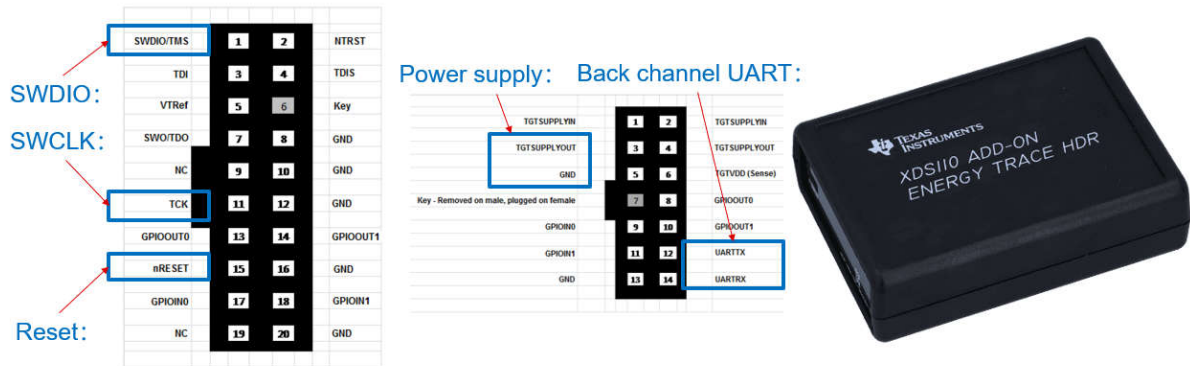

**Figure 5-12. Pin Connection of TMDSEMU110-U**

For XDS110 on LaunchPad, the basic programming functions are intact compared to the TMDSEMU110-U. The board is shown in [Figure 5-13](#). The cheapest XDS110 on LaunchPad is [LP-MSPM0C1104](#). However, [LP-MSPM0C1104](#) only supports SBW and there is no EnergyTrace or bootloader function.

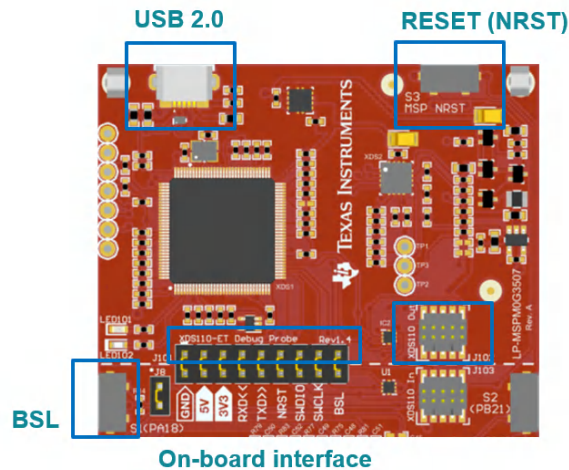

**Figure 5-13. XDS110 Onboard**

LP-XDS110 and LP-XDS110ET are similar with XDS110 on a LaunchPad. The difference lies on that one has EnergyTrace function and the other does not. The pin assignment is shown in [Figure 5-14](#).

For LP-XDS110 and LP-XDS110ET, the level shift function is enabled by changing the jumper at the left bottom of the board. The support voltage range is from 1.2V to 3.6V.

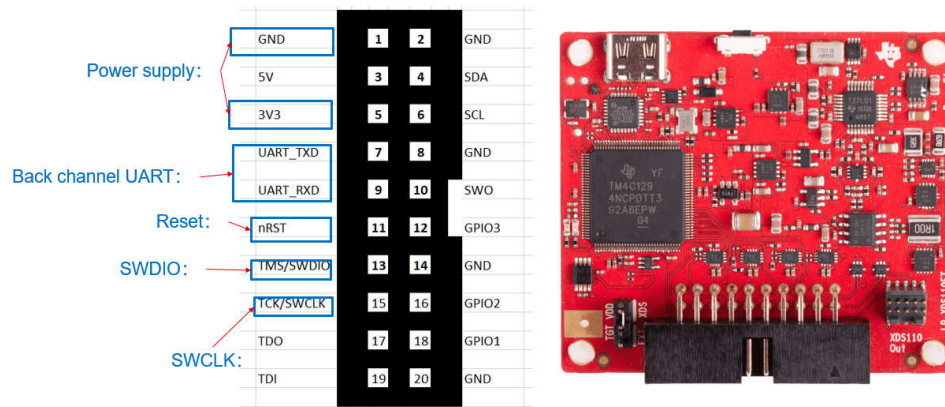

**Figure 5-14. LP-XDS110ET**

## 6 Quality and Reliability Instructions

TI is committed to delivering high quality and reliable semiconductor designs that meet our customers' needs. Our holistic approach to quality permeates every aspect of the company's supply chain from process technology and design through manufacturing, packaging, test and delivery.

### 6.1 Quality and Reliability Material Entrance

This is the landing page for [Quality & reliability](#). The following are the common used tools and links under that page:

- [Qualification summary](#)★: Used to search reliability data of related devices. Representative data summary of the material sets, processes, and manufacturing sites used by the device family.
- [Reliability testing](#): Listed the various types of testing that TI conducts for reliability of the products.
- [Customer returns](#): The *Customer Returns* page provides detailed guidelines for returning material to TI.
- [DPPM/FIT/MTBF estimator](#): The DPPM/FIT/MTBF estimator search tool allows you to find generic data based on technology groupings to estimate these typical questions and shows conditions under which the rates were derived.
- [Ongoing reliability monitoring](#): The search tool of ongoing reliability monitor (ORM) program provides the quarterly ORM report by wafer fab process or device package family.
- [Packaging](#): This website allows users to find package considerations including package size, SMT recommendations, reliability, and performance expectations.

### 6.2 Failure Information Collection and Analysis Guidance

Failure analysis needs to collect as much technical background information as possible to narrow down the scope of analysis and accelerate the analysis speed. If users meet any device failure on MSPM0, then collect the information as below, and connect to TI through the [Customer returns](#) page or the Regional CQE and Sales supporting your product or business.

Device name (TI Part Number, including package designator):

- Example: MSPM0L1306SRGER

Failure rate (purchased vs. customer failed units):

- Example: Failure rate: 5% (Total tested qty: 2000, Failed qty: 100)

Detection place (field return, production, incoming, and so forth):

- Example: Board level function test

Schematic of the application:

- Example: Schematic of the MCU part, with detailed description to every input and output signals

Detailed device level failure description

- Example: MCU PA1 cannot output high voltage

This is an introduction to the common methods to collected the failure information.

- Method 1: ABA swap test to judge whether the issue is caused from the device or the relativity between the device with the total system. Here are the steps to do ABA swap test: Remove the suspected component (A) from the original failing board. Replace the suspected component (A) with a known good component (B) and check if the original board now works properly. Mount the suspected component (A) to a known good board and see if the same failure occurs on the good board.
- Method 2: Compare MCU current consumption with the data sheet under the standby mode. Some device failure is caused from EOS (Electrostatic Overstress), which causes additional leakage current. This can be caught by current consumption test.
- Method 3: Pin impedance check. Some EOS (Electrostatic Overstress) is purely happened at I/Os, and using pin impedance check can easily catch this failure to give more information to TI. Users can choose to detect the IO resistance with or without powering the device. The resistance of a GPIO in high impedance state needs to be MΩ level.

- Method 4: Find a smallest system or code example. Some failure happens with the typical application and typical code project. Through comparison method, removing the unrelated hardware setup and software code step-by-step can gradually narrow down the scope of analysis. The best result is that the problem is purely related to the device and a simplest code example. With that, TI can carry the further failure analysis faster.

## 7 Common Development Questions

This section lists some common questions for users to search. For further questions, search the device-specific data sheet, technical reference manual, or [E2E](#). TI engineers provide response in 24 hours on this online support platform.

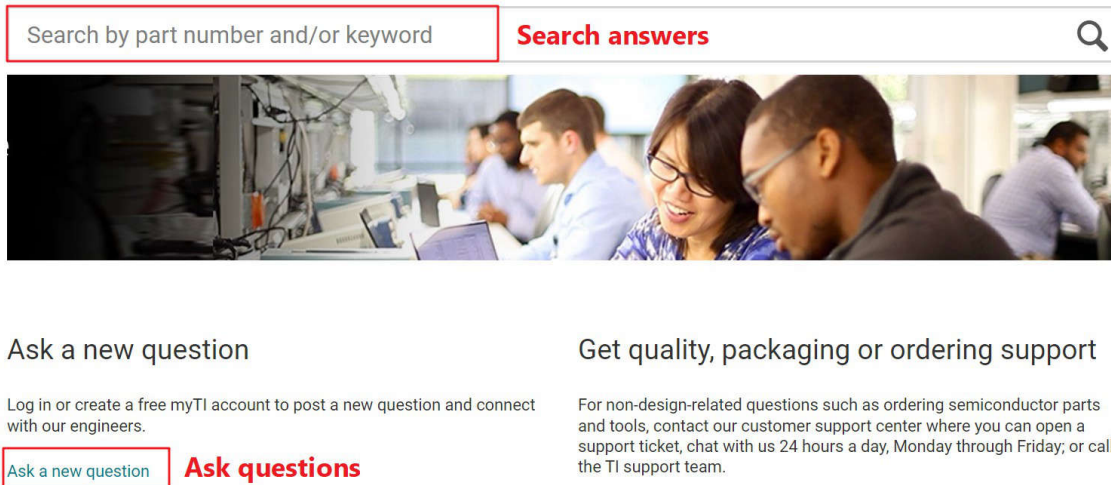

Search by part number and/or keyword **Search answers**

**Ask a new question**

Log in or create a free myTI account to post a new question and connect with our engineers.

[Ask a new question](#) **Ask questions**

**Get quality, packaging or ordering support**

For non-design-related questions such as ordering semiconductor parts and tools, contact our customer support center where you can open a support ticket, chat with us 24 hours a day, Monday through Friday; or call the TI support team.

**Figure 7-1. E2E Online**

### 7.1 Unlock MCU

MSPM0 can experience SWD connection issues when going into STOP, STANDBY, or SHUTDOWN mode. The effect of this limitation depends on the IDE and debugger implementation. Please use the tools with the latest versions, shown in [Table 7-1](#). For more details, please refer to the Debugging in Low Power Modes chapter in the [MSPM0 SDK Known Issues and FAQ](#).

**Table 7-1. Tools Suggested Version**

Keil CMSIS Pack	IAR IDE	CCS IDE	J_Link
MSPM0L11XX_L13XX_DFP: 1.3.1+ MSPM0G1X0X_G3X0X_DFP: 1.3.1+ MSPM0C110X_DFP: 1.1.1+ MSPS003FX_DFP:1.1.0+ MSPM0L122X_L222X_DFP:1.1.0+	9.60.1+	12.80+	<a href="#">V 8.10+</a>

MSPM0 can also lose connection after downloading a wrong code, and CCS reports errors when programming a new code. An example is shown in [Figure 7-2](#).

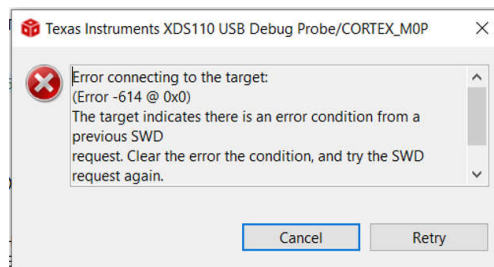

**Figure 7-2. CCS Error**

The Debug Subsystem Mailbox (DSSM) enables a debug probe to pass messages to the boot ROM of an MSPM0 device through the SWD interface. There are four unlock commands that you can choose in tools. The brief introduction is in [Table 7-2. DSSM Factory Reset is recommended](#), which the reset level is higher than DSSM Mass Erase.

**Table 7-2. Unlock Commands**

Unlock Commands	Hardware Connection With Debugger	Reset Pin Control	Command Influence
DSSM Factory Reset Manual	3v3, GND, SWDIO, SWCLK, Reset	End users	Erase main flash and reset NONMAIN flash
DSSM Factory Reset Auto		Debugger	
DSSM Mass Erase Manual		End users	Erase main flash
DSSM Mass Erase Auto		Debugger	

The suggestion on the provided three unlock methods is shown in [Table 7-3](#). An important note is that the unlock method only supports XDS110 and does not support J-Link currently.

**Table 7-3. Unlock Method Selection**

Unlock Method	Support Debugger	When to Choose
Factory Reset GUI Tool	XDS110	Internet connection is available
Uniflash	XDS110	Internet connection is unavailable
CCS	XDS110	Use CCS as the development IDE

### 7.1.1 Unlock Through Bootloader

If users do not touch the NONMAIN memory and come to this problem, then the easiest way is to make the device enters Bootloader mode when the device powers on. Then, reprogram the flash. Follow the steps below:

1. Before powering on MSPM0, pull and hold PA18 to be high.
2. Program the flash with the right code. Then release PA18.

### 7.1.2 Unlock Through Factory Reset GUI Tool

The [MSPM0 Factory Reset GUI tool](#) is a standalone tool used to gain debug access or recover an MSPM0 device using this interface. This tool is available free of charge. Follow the steps to reset the MSPM0.

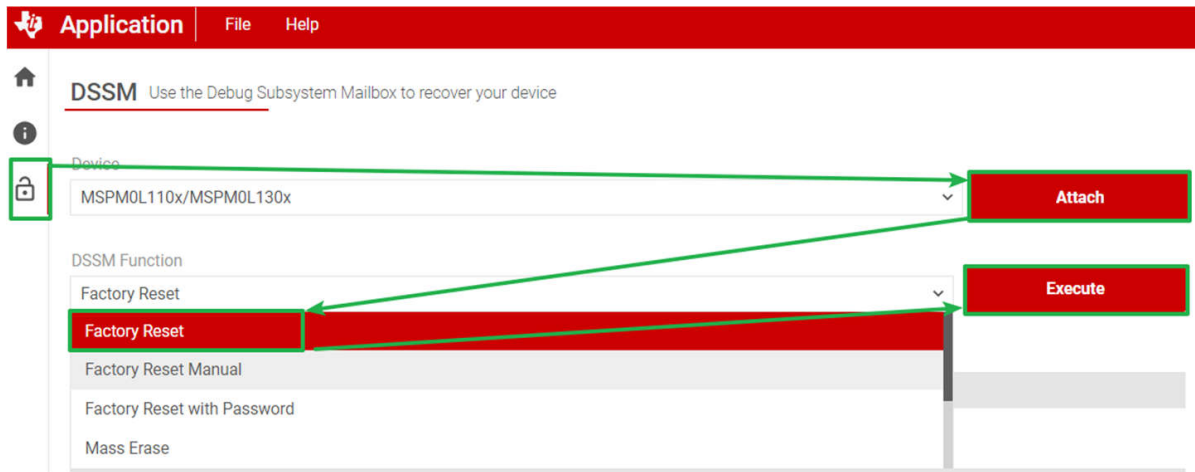

### Output console

```

CS_DAP_0: GEL Output: SEC_AP Reconnect
CS_DAP_0: GEL Output: Command execution completed.
CORTX_M0P: GEL Output: Factory Reset executed. Please terminate debug session, power-cycle and restart debug session.
DSService deconfigured. Core deattached/closed.
    
```

**Figure 7-3. Unlock Through GUI**

### 7.1.3 Unlock Through Uniflash

Uniflash above Version: 8.7.0.4818 also supports to unlock MSPM0. First, follow the steps to connect the MSPM0 with Uniflash, as shown in Section 5.2.1.1. Then, follow the instructions to unlock MSPM0 in Figure 7-4.

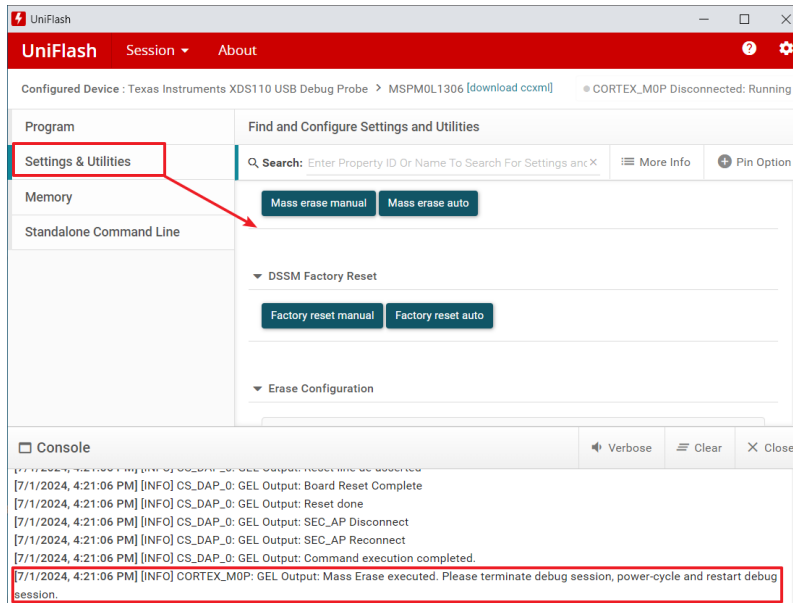

Figure 7-4. Unlock Through Uniflash

### 7.1.4 Unlock Through CCS

Here are the steps to unlock MSPM0 through CCS:

1. In the CCS project, select *targetConfigs* → *MSPM0xxxx.ccxml*. Right-click the .ccxml and select *Start Project-less Debug*.
2. Select *Scripts* → *MSPM0xxxx\_Commands*.
3. If users choose the manual command, then users need to reset the device manually according to the command in the console. After that, users can repower the device. If users choose auto command, then the debugger resets the device.

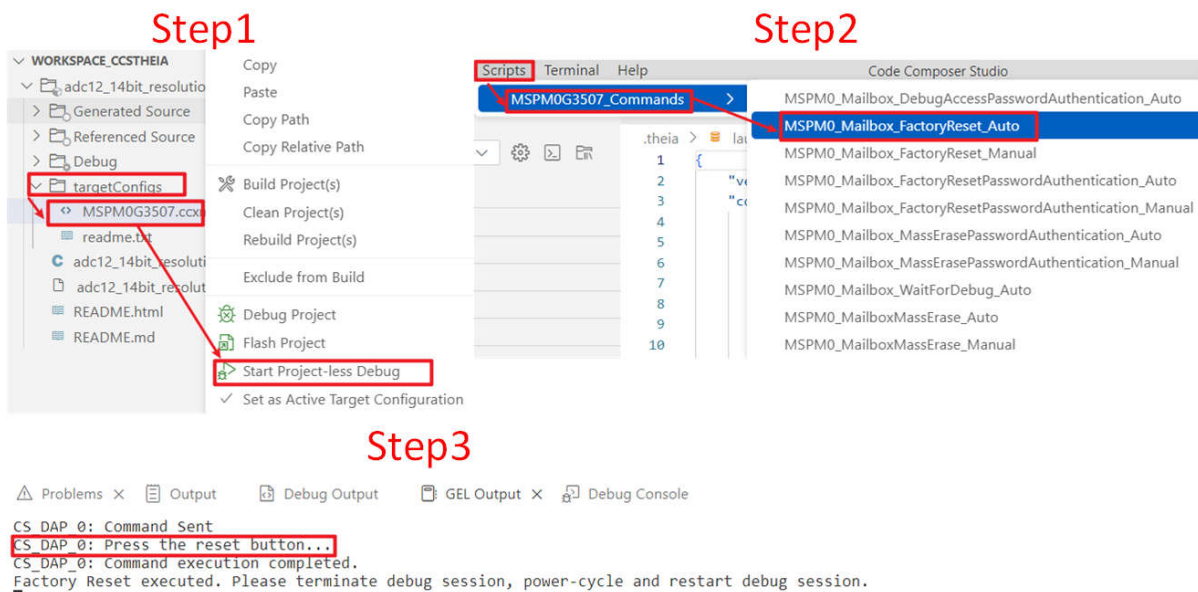
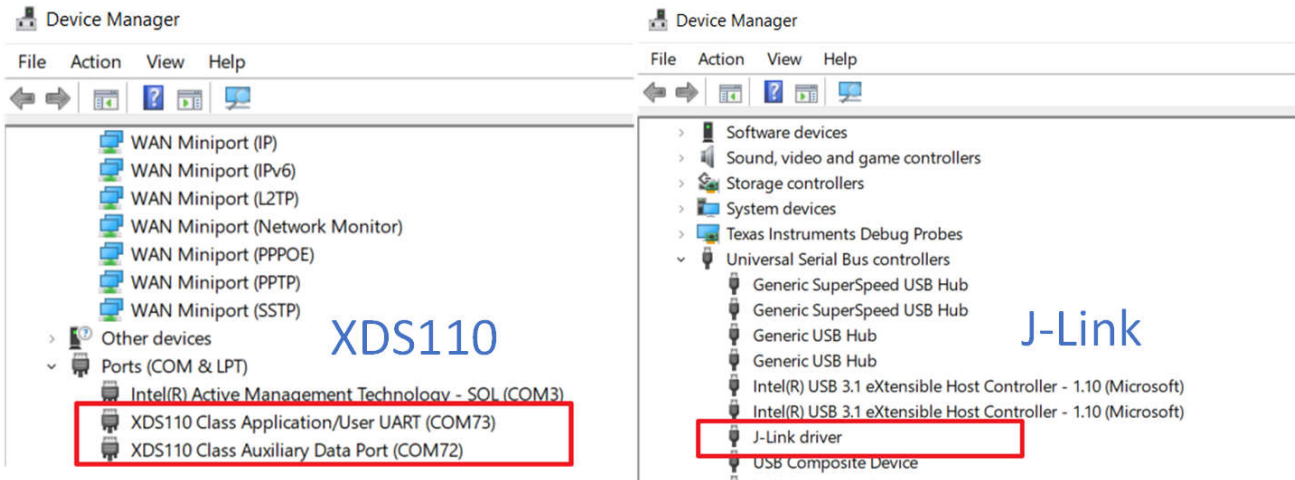

Figure 7-5. Unlock Through CCS

## 7.2 MSPM0 Program Failure

If the program failure is met for the first time, then check these items one by one:

1. Install the latest IDE or programming software tools at the English path. The default install path is suggested. For install instructions, please see the related chapter in this note.
2. Plug in the debugger and check whether the debugger is found by the computer. Check for computer limitations if the debugger does not show like [Figure 7-6](#).



**Figure 7-6. Device Manager View**

3. Try to program with MSPM0 Launchpad to check whether the PC environment setting is OK.
4. For your customized board, check the schematic by referring to [Section 4.3](#). Pay attention to the Vcc, Vcore and reset pin setting.
5. Then, check the connection between the debugger and the MSPM0. Users can use multimeter to directly check the signal path at debugger side by referring to [Section 5.3](#), and at MCU pin side by referring to the related data sheet.
6. Check the power supply on the board. Remember the power output of the debugger has limitations and the output voltage can only be 3V3. An additional power supply can be needed.
7. Use oscilloscope to check the signal wave on SWDIO and SWCLK, especially when the wire is very long. Please make sure the signal establishment time is enough.

If the program failure is met for the second time and the device can be programmed before, then refer to [Section 7.1](#).

## 7.3 Reprogram with SWD Disabled

On MSPM0, the SWD function is only enabled after reset and is impossible to re-enable through software in free run mode. Here are the common methods to reprogram MSPM0 under this condition.

1. Add a delay like 5 seconds before `SYSCFG_DL_init()`. With that, users have some time to connect MSPM0 before disabling SWD is executed.
2. Use ROM Bootloader. Before powering on MSPM0, pull and hold PA18 to be high. Program the flash with the right code. Then release PA18.
3. Use factory reset. Before powering on, press and hold the reset button. Perform a factory reset according to [Section 7.1](#). When prompted to reset the chip, release the reset button. Then, the chip is blank.



## 7.4 MCU Performs Differently in Debug and Free Run

MSPM0 performs differently in debug and free run. Check the setting on PA18. The device enters the Bootloader in free run mode after MSPM0 is reset or repower, when PA18 input is **pulled to a high level** or **affected by noise with this pin floating**. If you meet this problem and PA18 cannot be pulled to a low level with an external resistor, you can follow the steps in [Figure 7-7](#) to disable BSL or change the invoke pin assignment. As these settings need to change NOMAIN, please refer to the Program NONMAIN chapter for the related IDE in [Section 3.4](#).

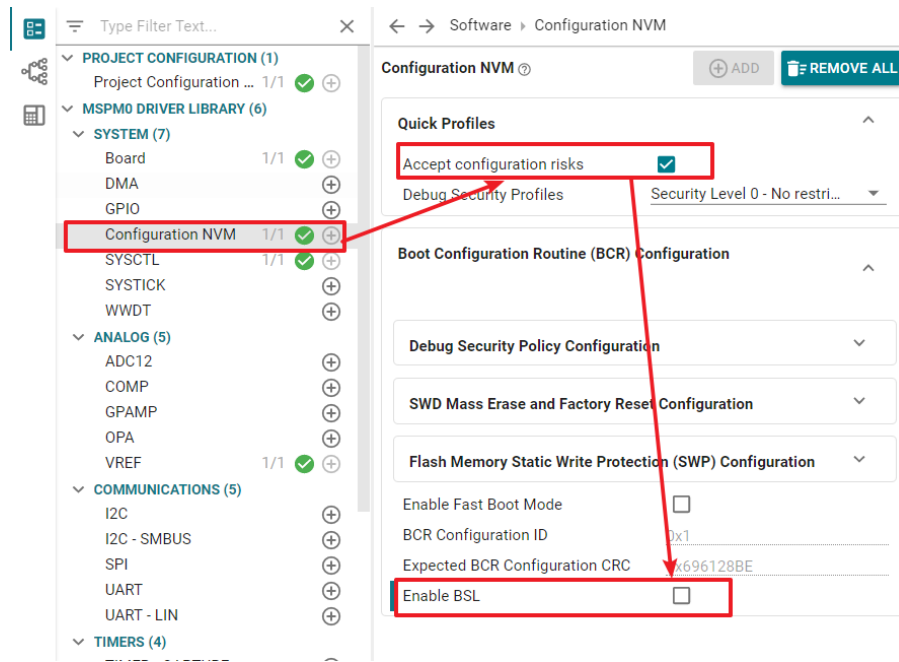

Figure 7-7. Disable BSL

## 7.5 Set SWD Password

The SWD interface can be configured to be disabled, enabled, or enabled with a 128-bit password by writing the BOOTCFG0 and SWDPW registers in NONMAIN. See the device Technical Reference Manual and [Cybersecurity Enablers in MSPM0 MCUs](#) for more information about NONMAIN and SWD password. Users can follow the steps to add password on SWD.

1. Enable and input SWD Password through sysconfig.
2. Enable Nonmain configuration.
3. After repowering, the device is locked.

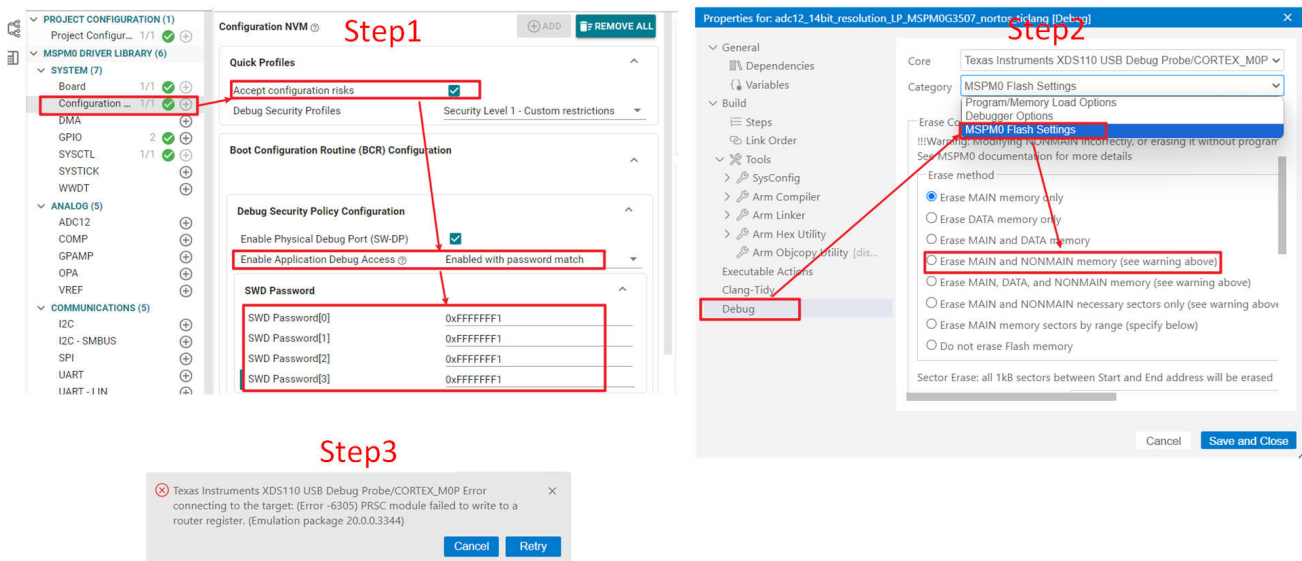

Figure 7-8. Enable SWD Password

**Note**

SBW security only works after repowering.

Here are the steps to reprogram MSPM0 with the password. This action does not erase NONMAIN, so the password remains active unless NONMAIN is modified.

1. In the CCS project, select *targetConfigs* → *MSPM0xxx.ccxml*. Input password in *.ccxml* file. Ctrl+S to save *.ccxml* file.
2. Right-click the *.ccxml* and select *Start Project-less Debug*. First select *DebugAccessPasswordAuthentication*. After the GEL output shows *Command execution completed*, select *FactoryReset*. For more about factory reset, refer to [Section 7.1](#).
3. Now, the device returns to empty and is ready to reprogram a new firmware.

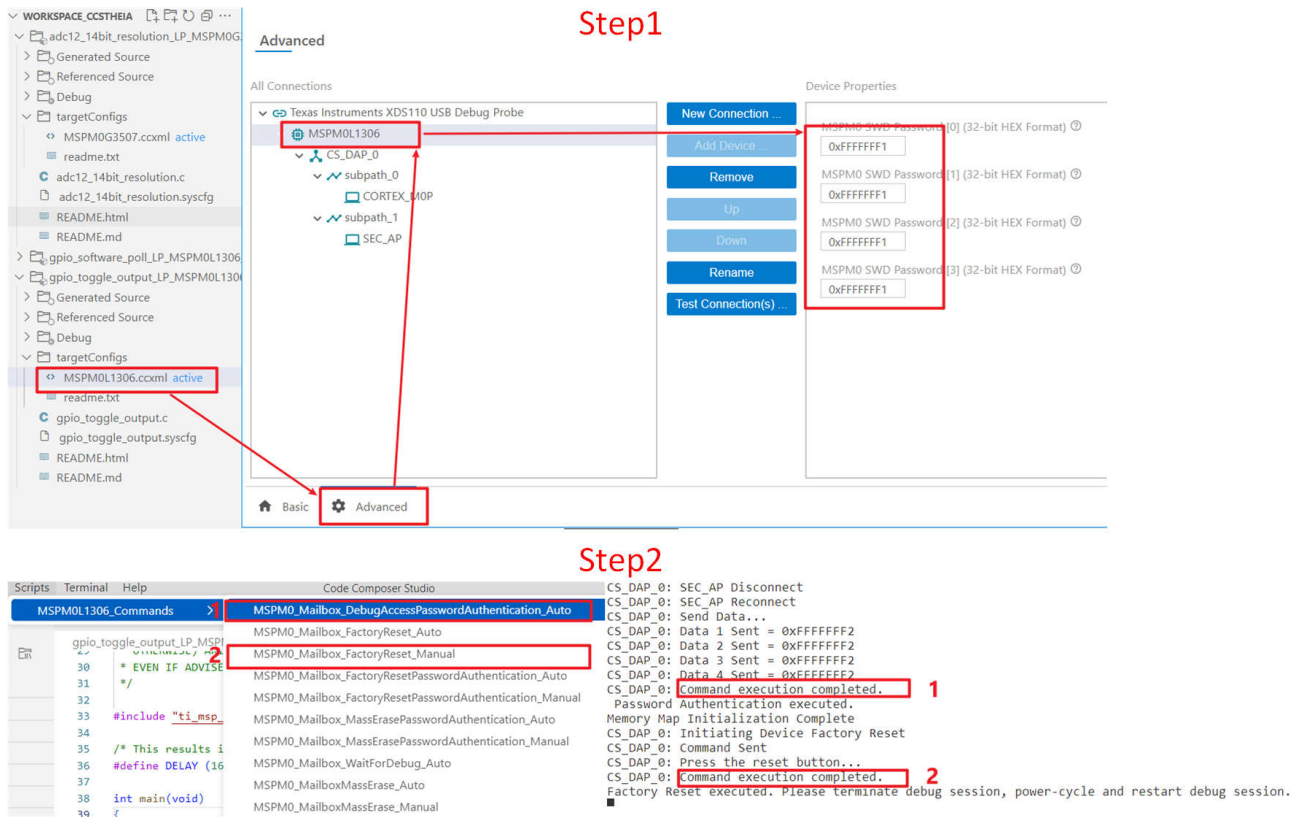

Figure 7-9. Clear SWD Password

**Note**

Enabling a password can work with CCS, IAR and Keil. Clearing passwords can only work on CCS.

**7.6 BSL Related Questions**

For questions about how to use bootloader, see [MSPM0 Bootloader \(BSL\) Implementation](#). This provides an overview of bootloader implementation and step-by-step instructions.

For questions about bootloader protocol and the spec, see the [MSPM0 Bootloader User's Guide](#).

**7.7 Reach Expected Current in LPM Mode**

On MSPM0, if there are peripherals requiring high speed clock above the settled LPM mode, then the current consumption above the spec is listed on the data sheet. The best solution is to reset all the peripherals before entering the LPM mode. After getting out of the LPM mode, reconfigure the peripheral again.

For more detailed instructions, refer to [MSPM0G3507 Low Power Test and Guidance](#).

**7.8 CCS Common Questions**

In this section, some common questions met in CCS are introduced. Here are some additional documents for reference when meeting questions with TI's compiler, linker or IDE:

- Texas Instruments, [MSPM0 SDK QuickStart Guide for CCS](#), webpage
- Texas Instruments, [CCS IDE Guide for MPSM0](#), webpage
- Texas Instruments, [Code Composer Studio User's Guide](#), webpage
- Texas Instruments, [ARM Assembly Language Tools User's Guide](#), user's guide
- Texas Instruments, [ARM Optimizing C/C++ Compiler User's Guide](#), user's guide
- Texas Instruments, [TI Arm Clang Compiler Tools User's Guide](#), webpage

### 7.8.1 Change the Optimization Level

The default SDK example is with optimization level 2. The code size is smaller. However, this causes a mismatch of the C code and the assembly code and breakpoint cannot be added at the certain C code line. To solve this issue, choose the optimization from level 2 to level 0.

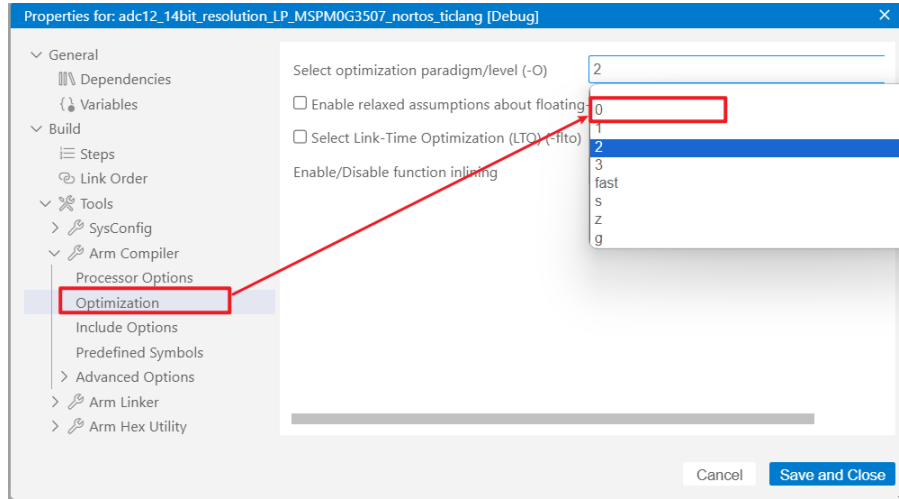

**Figure 7-10. Change Optimization Level**

## 7.9 Keil Common Questions

### 7.9.1 Copy Keil Example Out of SDK

If example code is copied out of SDK and compiled directly, then there are errors. The root cause lies on the SDK and SysConfig address setting in the code example. To solve this problem, see [Figure 7-11](#).

1. Step 1: modify the path of driverlib.a

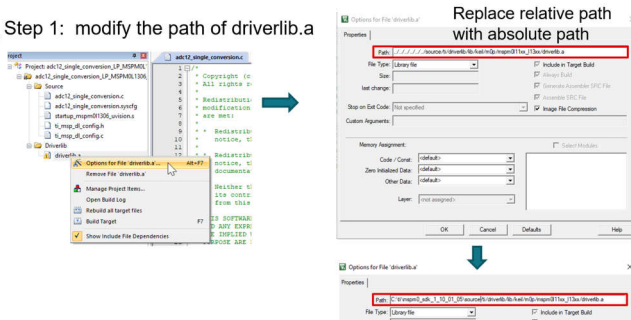

2. Step 2: modify the Include Paths

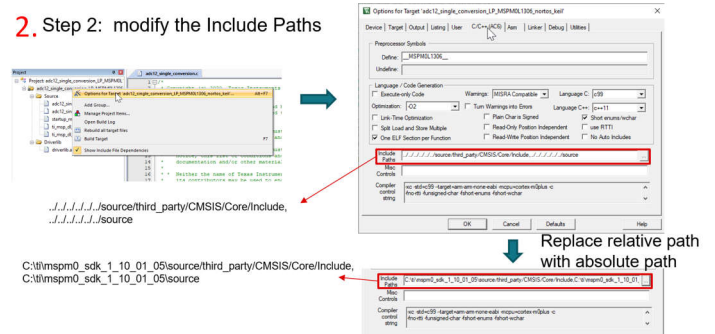

3. If you copy the sysconfig, change the file type to text and may need change the sysconfig name like from empty.syscfg to username.syscfg

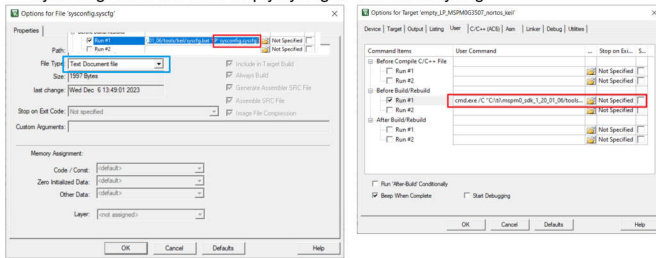

4. Now you can compile normally, but SysConfig still cannot be used

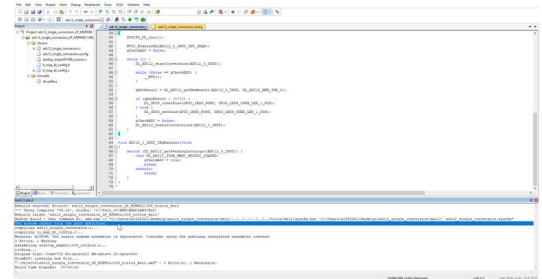

5. Step 3: modify the User command paths for sysconfig

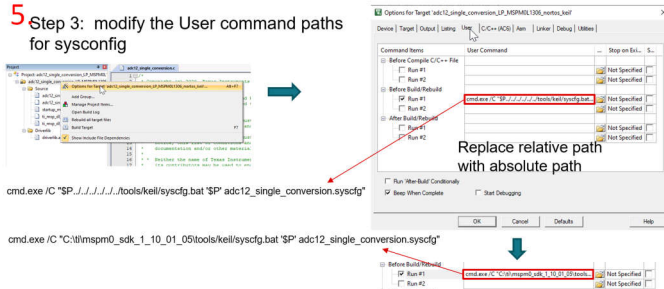

6. Step 4: modify the tools configuration for sysconfig, import from SDK<MSPM0\_SDK\_INSTALL\_DIR>/tools/keil

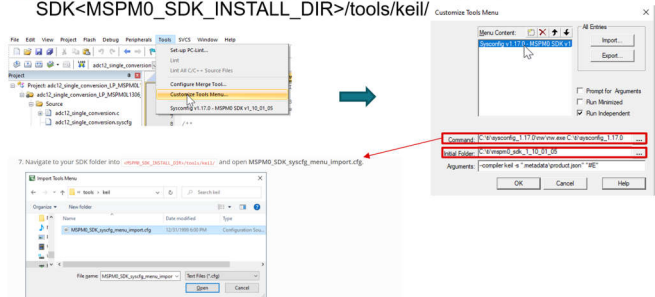

7. Step 5: modify the syscfg.bat in C:\ti\msp0\_sdk\_1\_10\_01\_05\tools\keil

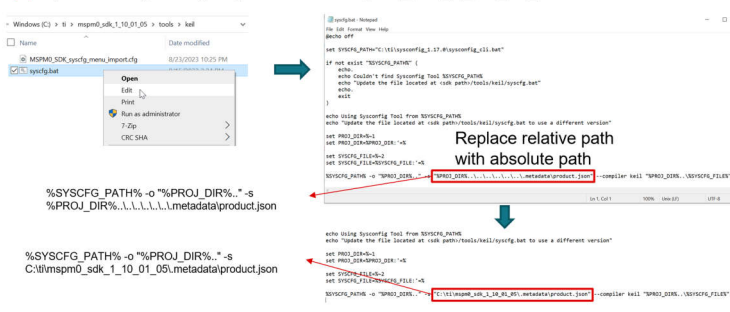

8. Now you can use SysConfig normally. Don't put the Keil project under an address name with ". For example, use "My\_path" instead of "My path".

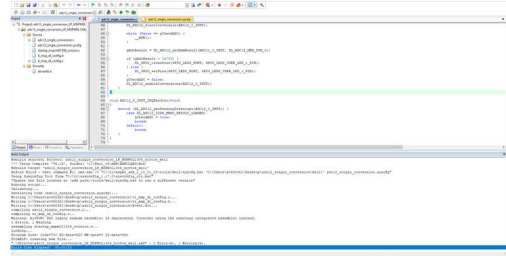

Figure 7-11. Copy Keil Example Out of SDK

## 8 Summary

This document is a good start for the MSPM0 development and provides an overview of MSPM0 ecosystem and step-by-step instructions. Users are also provided with clear processes and image explanations. In addition to basic knowledge, the document also lists references and further reading materials for users to refer to further. TI recommends this document for users to quickly handle MSPM0 development work and overcome common obstacles.

## 9 Technical Documentation Resources

### 9.1 Technical Reference Manuals

Technical reference manuals introduce the application method and characteristic of MSPM0 MCUs, including but not limited to the abstract model of CPU and peripherals, working mode, and corresponding register configuration method.

- Texas Instruments, [MSPM0 C-Series 24MHz Microcontrollers](#), technical reference manual
- Texas Instruments, [MSPM0 G-Series 80MHz Microcontrollers](#), technical reference manual
- Texas Instruments, [MSPM0 L-Series 32MHz Microcontrollers](#), technical reference manual

### 9.2 Subsystems

This section lists all the subsystem examples based on MSPM0 MCUs. As MSPM0s have become smaller and extremely cost-competitive, MSPM0s have begun to replace systems that were historically performed by fixed function analog devices. For more information, users can also refer to the [Analog Engineer's Circuit Cookbook: M0+ MCUs](#) e-book and the [Arm® Cortex ®-M0+ MCUs subsystems](#) product page.

- Texas Instruments, [5V Interface](#), subsystem design
- Texas Instruments, [ADC to I2C](#), subsystem design
- Texas Instruments, [ADC to SPI](#), subsystem design
- Texas Instruments, [ADC to UART](#), subsystem design
- Texas Instruments, [CAN to I2C Bridge](#), subsystem design
- Texas Instruments, [CAN to SPI Bridge](#), subsystem design
- Texas Instruments, [CAN to UART bridge](#), subsystem design
- Texas Instruments, [Common Amplifier Topologies: PGA](#), subsystem design
- Texas Instruments, [Connected Diode Matrix](#), subsystem design
- Texas Instruments, [DMA Ping Pong With ADC](#), subsystem design
- Texas Instruments, [Data Sensor Aggregator Subsystem Design](#), subsystem design
- Texas Instruments, [Digital FIR Filter](#), subsystem design
- Texas Instruments, [Digital IIR Filter](#), subsystem design
- Texas Instruments, [Emulating a Digital MUX](#), subsystem design
- Texas Instruments, [Frequency Counter: Tone Detection](#), subsystem design
- Texas Instruments, [Function Generator Using DAC8](#), subsystem design
- Texas Instruments, [I2C Expander Through UART Bridge](#), subsystem design
- Texas Instruments, [I2C to UART Subsystem Design](#), subsystem design
- Texas Instruments, [IO Expander With SPI, I2C, and UART](#), subsystem design
- Texas Instruments, [LED Driver With PWM](#), subsystem design
- Texas Instruments, [Low-Cost MSPM0C MCUs as an I/O Expander](#), subsystem design
- Texas Instruments, [MCU Design Techniques: ADC to PWM](#), subsystem design
- Texas Instruments, [PWM DAC](#), subsystem design
- Texas Instruments, [Parallel IO to UART Bridge](#), subsystem design
- Texas Instruments, [Power Sequencer](#), subsystem design
- Texas Instruments, [Scanning Comparator](#), subsystem design
- Texas Instruments, [Task Scheduler](#), subsystem design
- Texas Instruments, [Thermistor Temperature Sensing](#), subsystem design
- Texas Instruments, [Transimpedance Amplifier](#), subsystem design
- Texas Instruments, [Two OPA Instrumentation Amplifier With M0 Devices](#), subsystem design
- Texas Instruments, [UART to I2C Bridge](#), subsystem design
- Texas Instruments, [UART to SPI Bridge](#), subsystem design
- Texas Instruments, [Emulate EEPROM With FLASH \(Type B\)](#), subsystem design

- Texas Instruments, [Emulate EEPROM with FLASH \(Type A\)](#), subsystem design

### 9.3 Reference Designs

This section lists all the reference designs based on MSPM0 MCUs. The references contain full design resources and most are a reference for developing an end equipment.

- Texas Instruments, [24V, 35W sensorless FOC BLDC reference design with 85VAC to 265VAC, PF of 0.92, single-stage PFC](#), design guide
- Texas Instruments, [250W motor inverter reference design with GaN IPM DRV7308](#), design guide
- Texas Instruments, [Cost-Effective, 3-Phase CT Electricity Meter Ref. Design Using Standalone ADC](#), design guide
- Texas Instruments, [IO-Link device implementation for sensors and actuator reference design](#), design guide
- Texas Instruments, [Low-Cost Blood Pressure and Heart Rate Monitor Reference Design](#), design guide
- Texas Instruments, [Radiation-Hardened Space Battery Management System \(BMS\) Reference Design](#), design guide
- Texas Instruments, [Single-Chip Pulse Oximeter Reference Design With 90dB Dynamic Range for Lower PI](#), design guide
- Texas Instruments, [Smart Analog Sensor Interface for Smoke Detection With Ambient Light Cancellation Reference Design](#), design guide
- Texas Instruments, [Three-Phase Shunt-Based Energy Metrology Reference Design](#), design guide

### 9.4 Hardware EVM User's Guides

The Hardware EVM User's Guides includes all the documentations of Launchpads and EVMs, related to MSPM0.

- Texas Instruments, [LP-MSPM0C1104 Evaluation Module User's Guide](#), user's guide
- Texas Instruments, [LP-MSPM0G3519 Evaluation Module User's Guide](#), user's guide
- Texas Instruments, [LP-MSPM0L1117 Launchpad Development Kit](#), user's guide
- Texas Instruments, [LP-MSPM0L2228 Evaluation Module User's Guide](#), user's guide
- Texas Instruments, [MSP-DRV-ADAPT-EVM Evaluation Module User's Guide](#), user's guide
- Texas Instruments, [MSP-LITO-L1306 Evaluation Module User's Guide](#), user's guide
- Texas Instruments, [MSPM0G3507 LaunchPad Development Kit User's Guide \(LP-MSPM0G3507\)](#), user's guide
- Texas Instruments, [MSPM0L1306 LaunchPad Development Kit](#), user's guide
- Texas Instruments, [XDS110-ETP Evaluation Module User's Guide](#), user's guide

### 9.5 Application Notes and Others

This section lists all the application notes, application briefs, product overviews, subsystem designs and functional safety informations based on MSPM0 MCUs and the peripherals. The application note is the technical document about device, device peripherals or applications, which is the most common type of technical documentation on ti.com.

- Texas Instruments, [A Self-Calibratable Current Detection Solution Based on MSPM0](#), application note
- Texas Instruments, [A2L Refrigerant Standard Overview and TI Mitigation Control Board Designs for Designers](#), application note
- Texas Instruments, [Automotive Seat Comfort Module Using MSPM0](#), application brief
- Texas Instruments, [BLDC and PMSM Control Using Sensorless FOC Algorithm Based on MSPM0 MCUs](#), application brief
- Texas Instruments, [BQ769x2 Control Based on MSPM0 Through I2C](#), application note
- Texas Instruments, [BQ79616 Control Based on MSPM0 Through UART to CAN](#), application note
- Texas Instruments, [Build Scalability in Cordless Power and Garden Tools Using Low-Cost MSPM0 MCUs](#), application brief
- Texas Instruments, [Closed Loop Constant Power Drive to Simplify Heater Element Control and Extend Battery Life](#), application note
- Texas Instruments, [Cybersecurity Enablers in MSPM0 MCUs](#), application note
- Texas Instruments, [Designing Single- and Three-Axis Selfie Sticks With MSPM0 MCUs](#), application brief
- Texas Instruments, [Designing Temperature Monitoring Systems with NTC and RTD](#), application note
- Texas Instruments, [Designing With MSPM0 MCUs and Segment LCDs](#), application note

- Texas Instruments, [Dual-Ray Smoke Detector with the TPS8802 and MSPM0 MCUs](#), application note
- Texas Instruments, [EEPROM Emulation Type A Solution](#), application note
- Texas Instruments, [EEPROM Emulation Type B Design](#), application note
- Texas Instruments, [Flash Multi Bank Feature in MSPM0 Family](#), application note
- Texas Instruments, [Full-Featured Automotive Side Mirror](#), application brief
- Texas Instruments, [Functional Safety Manual for MSPM0G](#), functional safety information
- Texas Instruments, [How to Charge With Smart Battery Using MCU in Between to Translate SMBus/I2C](#), application note
- Texas Instruments, [Increasing Flexibility in Your Battery Management Designs With a Low-Cost MSPM0](#), application brief
- Texas Instruments, [Increasing Flexibility in Your Electrical Thermometer Designs With Low-Cost MSPM0](#), application brief
- Texas Instruments, [Isolated Loop Powered 4 to 20mA Field Transmitter Designs](#), application note
- Texas Instruments, [Low-Frequency Subsystem and VBAT Feature in MSPM0L222X](#), application note
- Texas Instruments, [MSPM0 - Advanced Control Timer Helps for Better Control and Better Digital Output](#), application note
- Texas Instruments, [MSPM0 ADC Noise Analysis and Application](#), application note
- Texas Instruments, [MSPM0 Bootloader \(BSL\) Implementation](#), application note
- Texas Instruments, [MSPM0 Bootloader](#), user's guide
- Texas Instruments, [MSPM0 C-Series MCU Hardware Development Guide](#), application note
- Texas Instruments, [MSPM0 Design Flow Guide](#), application note
- Texas Instruments, [MSPM0 Enables Cost-Effective Field Transmitter Applications](#), application note
- Texas Instruments, [MSPM0 G-Series MCUs Hardware Development Guide](#), application note
- Texas Instruments, [MSPM0 G-Series MCUs Power Optimization Guide](#), application note
- Texas Instruments, [MSPM0 Gauge L1 Solution Guide](#), application note
- Texas Instruments, [MSPM0 Gauge L2 Solution Guide](#), application note
- Texas Instruments, [MSPM0 L-Series MCUs Hardware Development Guide](#), application note
- Texas Instruments, [MSPM0 L-Series MCUs Power Optimization Guide](#), application note
- Texas Instruments, [MSPM0 Live Firmware Update \(LFU\) Bootloader Implementation](#), application note
- Texas Instruments, [MSPM0 MCUs Quick Reference Guide](#), application note
- Texas Instruments, [MSPM0 MCUs: More Options, Unlimited Possibilities](#), product overview
- Texas Instruments, [MSPM0 Motor Control](#), application note
- Texas Instruments, [MSPM0 Sensored FOC Tuning](#), user's guide
- Texas Instruments, [MSPM0 Sensorless FOC Tuning Guide](#), user's guide
- Texas Instruments, [MSPM0 Universal FOC Tuning](#), user's guide
- Texas Instruments, [MSPM0-Based Low-Cost Single-Chip Pulse Oximeter Reference Design](#), product overview
- Texas Instruments, [MSPM0-Based Medical Alarm Design](#), application brief
- Texas Instruments, [MSPM0: Idea to Product With Easy-to-Use Tools, Software, and Academy](#), product overview
- Texas Instruments, [MSPM0C: A New Standard 32-Bit MCU for 8-Bit and 16-Bit MCU Applications](#), product overview
- Texas Instruments, [MSPM0Cx- Toothbrush and Shaver](#), application brief
- Texas Instruments, [MSPM0G3507 Low Power Test and Guidance](#), application note
- Texas Instruments, [MSPM0L or MSPM0G: How to Pick the Right MSP Microcontroller for Your Application](#), application note
- Texas Instruments, [Functional Safety Manual for MSPM0L130x-Q1](#), functional safety information
- Texas Instruments, [MSPM0Lx22x Microcontrollers Enabling Low-Power Display and Security Designs](#), product overview
- Texas Instruments, [Make System Design Easy With MSPM0 Precision Analog](#), application note
- Texas Instruments, [Migration Guide From Microchip to MSPM0](#), application note
- Texas Instruments, [Migration Guide From NXP to MSPM0](#), user's guide
- Texas Instruments, [Migration Guide From Renesas RL78 to Arm-Based MSPM0](#), application note
- Texas Instruments, [Migration Guide From STM8 to MSPM0](#), application note
- Texas Instruments, [Operating Time of MSPM0 Powered by a Capacitor](#), application note



- Texas Instruments, [Optimize Automotive Body Electronics Designs With AEC-Q100 MSPM0 MCUs](#), application brief
- Texas Instruments, [Optimized H-Bridge Driver Control for Stepper and BDC Motors Using MSPM0 MCUs](#), application brief
- Texas Instruments, [Optimizing Field Sensor and Transmitter Applications With MSPM0 MCUs](#), application brief
- Texas Instruments, [PGA460 Control Based on MSPM0 for Distance Detection](#), application note
- Texas Instruments, [PIR Motion Detection With MSPM0](#), application note
- Texas Instruments, [Realizing HVAC FAN Control Design with MSPM0 MCU](#), product overview
- Texas Instruments, [Realizing Low-Power and High-Scalability OBC Wake-up Design with MSPM0 MCU](#), product overview
- Texas Instruments, [Realizing UWB Passive Entry Passive Start \(PEPS\) Design with MSPM0 MCU](#), product overview
- Texas Instruments, [Scalable Battery Backup Subsystem With Adjustable Output](#), product overview
- Texas Instruments, [Sensored Brushed DC Motor Control Based on MSPM0](#), application note
- Texas Instruments, [Simplifying Design in True Wireless Stereo Control With a Low-Cost MSPM0 MCU](#), application brief
- Texas Instruments, [Simplifying Pulse Oximeter Designs With Low-Cost Highly Integrated MSPM0 MCUs](#), application brief
- Texas Instruments, [Software Defined Glass LCD Solution Based on MSPM0 MCUs](#), application note
- Texas Instruments, [Streamlining Smoke Detector Designs With Highly Integrated MSPM0 MCUs](#), application brief
- Texas Instruments, [TI's Smallest M0+ MCU Package Enables Room to do More in Your Design](#), application brief
- Texas Instruments, [TPS929xxx LED Driver Control Using MSPM0 Through UART Over CAN](#), application note
- Texas Instruments, [True Wireless Stereo \(TWS\) Charging Case Design Based on MSPM0L1105](#), application note
- Texas Instruments, [Understanding the MSPM0 Debug Subsystem](#), application note
- Texas Instruments, [Using MSPM0 MCUs to Design Trapezoidal-Based BLDC Motor Controllers](#), application brief

## 10 Revision History

NOTE: Page numbers for previous revisions may differ from page numbers in the current version.

<b>Changes from Revision D (October 2024) to Revision E (March 2025)</b>	<b>Page</b>
• Updated <i>Overview</i> section to include MSPM0 device overview and ecosystem introduction.....	4
• Added a link to <a href="#">Section 7</a> in <i>Software Development Instructions</i> section.....	7
• Added a link for the LaunchPad product page in <i>LaunchPad Introduction</i> section.....	8
• Added a description of MSPSDK in the <i>MSPM0-SDK Setup</i> section.....	9
• Removed MSPM0-SDK Example figure.....	10
• Added the code example figure in the <i>Examples Folder Introduction</i> section. ....	10
• Updated the <i>CCS Quick Start</i> section to include a different CCS version description.....	21
• Updated the CCS installation picture due to CCS version update in <i>CCS Installation</i> section.....	21
• Updated <i>Import a SDK Example</i> section with the CCS example importing picture due to CCS version update.....	22
• Updated <i>Example Download and Debug</i> section with the Debugger Selection picture due to CCS version update.....	23
• Updated the debugger selection picture due to CCS version update in <i>Generate Hex Files</i> section.....	25
• Updated the Nonmain programming picture due to CCS version update in <i>Program NONMAIN</i> section.....	26
• Updated <i>Obtaining a MSPM0 Package</i> section to give more detailed instruction for MSPM0 package generation.....	43
• Added C-GANG information to <i>Mass Production Instructions</i> section.....	48
• Changed the product introduction to C-GANG in <a href="#">Section 5.2.3</a> section .....	52
• Added more detailed instructions and images to <i>Program Hardware Quick Start</i> section.....	57
• Change the unlock picture due to CCS version change in the <i>Unlock Through CCS</i> section.....	63
• Added more CCS reference links in <i>CCS Common Questions</i> section.....	67
• Changed the picture due to CCS version update in <i>Change the Optimization Level</i> section.....	68
• Added <a href="#">Technical Documentation Resources</a> section.....	70

## IMPORTANT NOTICE AND DISCLAIMER

TI PROVIDES TECHNICAL AND RELIABILITY DATA (INCLUDING DATA SHEETS), DESIGN RESOURCES (INCLUDING REFERENCE DESIGNS), APPLICATION OR OTHER DESIGN ADVICE, WEB TOOLS, SAFETY INFORMATION, AND OTHER RESOURCES "AS IS" AND WITH ALL FAULTS, AND DISCLAIMS ALL WARRANTIES, EXPRESS AND IMPLIED, INCLUDING WITHOUT LIMITATION ANY IMPLIED WARRANTIES OF MERCHANTABILITY, FITNESS FOR A PARTICULAR PURPOSE OR NON-INFRINGEMENT OF THIRD PARTY INTELLECTUAL PROPERTY RIGHTS.

These resources are intended for skilled developers designing with TI products. You are solely responsible for (1) selecting the appropriate TI products for your application, (2) designing, validating and testing your application, and (3) ensuring your application meets applicable standards, and any other safety, security, regulatory or other requirements.

These resources are subject to change without notice. TI grants you permission to use these resources only for development of an application that uses the TI products described in the resource. Other reproduction and display of these resources is prohibited. No license is granted to any other TI intellectual property right or to any third party intellectual property right. TI disclaims responsibility for, and you will fully indemnify TI and its representatives against, any claims, damages, costs, losses, and liabilities arising out of your use of these resources.

TI's products are provided subject to [TI's Terms of Sale](#) or other applicable terms available either on [ti.com](https://www.ti.com) or provided in conjunction with such TI products. TI's provision of these resources does not expand or otherwise alter TI's applicable warranties or warranty disclaimers for TI products.

TI objects to and rejects any additional or different terms you may have proposed.

Mailing Address: Texas Instruments, Post Office Box 655303, Dallas, Texas 75265

Copyright © 2025, Texas Instruments Incorporated