

JACKSONVILLE
AUTOMATED SKYWAY EXPRESS
PHASE I - PRELIMINARY ENGINEERING

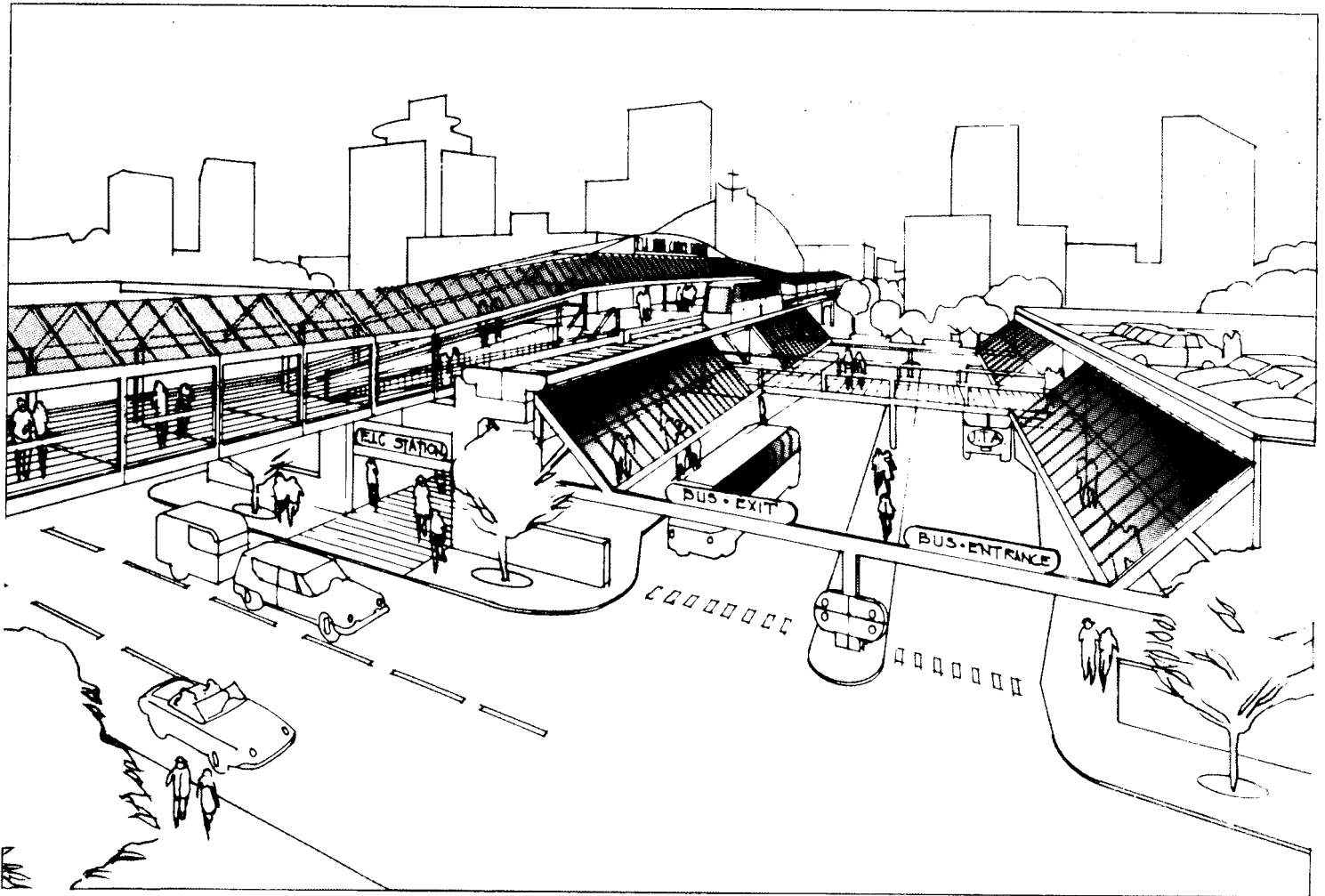

COMPREHENSIVE DESIGN REPORT

PREPARED FOR

JACKSONVILLE TRANSPORTATION AUTHORITY

BY

PARSONS BRINCKERHOFF/FLOOD ASSOCIATES

OCTOBER, 1982

JACKSONVILLE
AUTOMATED SKYWAY EXPRESS
PHASE I - PRELIMINARY ENGINEERING

COMPREHENSIVE DESIGN REPORT
OCTOBER 1982

Prepared for
JACKSONVILLE TRANSPORTATION AUTHORITY

Prepared by
PARSONS BRINCKERHOFF/FLOOD ASSOCIATES

The preparation of this report has been financed in part through a grant from the U.S. Department of Transportation, Urban Mass Transportation Administration, under the Urban Mass Transportation Act of 1964, as amended.

TABLE OF CONTENTS

<u>CHAPTER</u>	<u>DESCRIPTION</u>	<u>PAGE</u>
1	SUMMARY	1-1
	INTRODUCTION	1-1
	HISTORY OF THE PROJECT	1-3
	THE INITIAL SEGMENT	1-3
	PATRONAGE AND OPERATIONS	1-3
	ENVIRONMENTAL CONSIDERATIONS	1-3
2	INTRODUCTION	2-1
	COMMUNITY FRAMEWORK	2-1
	<u>Project Background</u>	2-1
	<u>Planning Framework</u>	2-5
	TRANSPORTATION ASPECTS	2-6
	JUATS	2-6
	<u>Regional Interfaces</u>	2-8
	ECONOMIC AND DEVELOPMENT ASPECTS	2-9
	CBD Characteristics	2-9
	<u>Growth Aspects</u>	2-12
	PUBLIC INVOLVEMENT	2-14
	Planning History	2-14
	<u>Citizen's Advisory Committee</u>	2-16
	<u>Task Force</u>	2-17
	ALTERNATIVE ANALYSIS	2-17
	Goals and Objectives	2-17
	<u>Description of Alternatives</u>	2-20
	<u>Comparison of Alternatives</u>	2-25
	<u>Recommended Alternative</u>	2-25
	SYSTEM FEASIBILITY	2-28
	Transportation and Land Use	2-28
	<u>Ridership</u>	2-32
	<u>Environmental and Economics</u>	2-33
	<u>Financial and Costs</u>	2-35
	AGT TECHNOLOGY SELECTION	2-35
	Candidate Systems	2-38
	<u>Reference System Criteria</u>	2-47
	<u>Selection Process</u>	2-52
	REFERENCES	2-58

TABLE OF CONTENTS (CONT.)

<u>CHAPTER</u>	<u>DESCRIPTION</u>	<u>PAGE</u>
3	SYSTEM DESCRIPTION OF INITIAL SEGMENT	3-1
	REFERENCE VEHICLE AND SYSTEMS	3-1
	<u>System General Characteristics</u>	3-1
	<u>Performance Capabilities of AGT Systems</u>	3-1
	<u>Summary of the JASE System Basic Design</u>	3-5
	<u>Propulsion Power Distribution Design</u>	3-10
	<u>Command and Control System</u>	3-11
	GUIDEWAY DESIGN	3-20
	<u>Route Description</u>	3-20
	<u>Structural Design</u>	3-34
	<u>Aesthetic Design</u>	3-38
	<u>Switches and Turnbacks</u>	3-38
	<u>Soils Investigations and Foundation Design</u>	3-44
	<u>Utility and Street Renovations</u>	3-44
	<u>Systems' Interfaces</u>	3-55
	<u>Construction and Fabrication</u>	3-55
	<u>Civil and Structural Criteria</u>	3-58
	STATION DESIGN	3-63
	<u>Station Prototypes</u>	3-63
	<u>Station Site Plans and Development Interfaces</u>	3-67
	<u>Urban Design</u>	3-76
	<u>Elderly and Handicapped Plan</u>	3-77
	<u>Architectural Criteria</u>	3-81
	CONTROL, MAINTENANCE, AND STORAGE AREA	3-86
	<u>General</u>	3-86
	<u>Central Control Center</u>	3-86
4	OPERATIONAL CHARACTERISTICS	4-1
	PATRONAGE FORECASTS	4-1
	<u>Assumptions</u>	4-1
	<u>JASE Segment Alternatives</u>	4-1
	<u>Methodology</u>	4-3
	<u>Bus Lines</u>	4-8
	<u>Patronage</u>	4-14
	<u>Line Link Loadings</u>	4-21
	<u>Station Loadings</u>	4-23
	<u>Conclusions</u>	4-29
	JACKSONVILLE ASE OPERATIONS	4-30
	<u>Service Characteristics</u>	4-30

TABLE OF CONTENTS (CONT.)

<u>CHAPTER</u>	<u>DESCRIPTION</u>	<u>PAGE</u>
4	OPERATIONAL CHARACTERISTICS (Cont.)	
	<u>Operational Scenarios - Full System</u>	4-31
	<u>Operational Scenarios - Initial Segment</u>	4-41
	<u>Failure Management Provisions</u>	4-45
	<u>Emergency Procedures</u>	4-47
	<u>Staffing Requirements</u>	4-48
	<u>Expansion Requirements</u>	4-48
	INTERMODAL OPERATIONS	4-51
	Walk Mode	4-51
	<u>Auto/Taxi Mode</u>	4-51
	Bus Mode	4-51
	<u>Long-Term Bus Network Change</u>	4-52
	SYSTEM SAFETY PROGRAM	4-54
	Risk Assessment	4-55
	<u>Hazard Analyses</u>	4-57
	<u>Action on Identified Hazards</u>	4-59
	<u>Safety During Construction and Testing</u>	4-59
	<u>System Safety Program Plan</u>	4-59
	<u>System Safety Criteria</u>	4-60
	Fire Safety	4-61
	<u>Vehicle Electrical System Safety</u>	4-63
	<u>Emergency Evacuation</u>	4-65
	SYSTEM ASSURANCE	4-67
	<u>System Dependability</u>	4-67
	<u>Dependability Requirements</u>	4-68
	<u>Vehicle and Wayside Availability</u>	4-69
	<u>Evaluation of Potential System Failures</u>	4-69
	<u>Reference</u>	4-69
	JASE SECURITY PROGRAM	4-70
	Security Committee	4-70
	<u>Security Program Requirements</u>	4-71
	<u>Security Program Plan</u>	4-73
	<u>System Security Criteria</u>	4-73
	<u>Reference</u>	4-76
5	ENVIRONMENTAL CONSIDERATIONS	5-1
	IMPACTS OF IMPLEMENTATION	5-1
	Physical and Facilities	5-1
	<u>Design Aesthetics</u>	5-4

TABLE OF CONTENTS (CONT.)

<u>CHAPTER</u>	<u>DESCRIPTION</u>	<u>PAGE</u>
5	ENVIRONMENTAL CONSIDERATIONS (Cont.)	
	<u>Socioeconomic</u>	5-13
	<u>Resource Consumption</u>	5-22
	<u>Energy</u>	5-23
	<u>Terrestrial Ecosystems</u>	5-25
	<u>Aquatic Ecosystems</u>	5-26
	<u>Air Quality</u>	5-26
	<u>Noise and Vibration</u>	5-30
	<u>Summary</u>	5-32
	CONSTRUCTION IMPACTS	5-33
	<u>Physical and Transportation</u>	5-33
	<u>Socioeconomic</u>	5-35
	<u>Natural and Historic</u>	5-40
	EIS PROCESS	5-51
	<u>Notice of Intent</u>	5-51
	<u>Draft Environmental Impact Statement</u>	5-51
	<u>Public Hearing</u>	5-52
	<u>Final Environmental Impact Statement</u>	5-53
	SUMMARY OF EFFECTS	5-53
	<u>Long-Term Beneficial Effects</u>	5-53
	<u>Long-Term Adverse Effects</u>	5-54
	<u>Short-Term Beneficial Effects</u>	5-54
	<u>Short-Term Adverse Effects</u>	5-55
	REFERENCES	5-56

LISTING OF FIGURES

<u>FIGURE</u>	<u>TITLE</u>	<u>PAGE</u>
1-1	Organizational Chart	1-2
2-1	Location Map, Downtown Jacksonville	2-2
2-2	Census Tract Map	2-4
2-3	Regional Rapid Transit System Year 2005 (JUATS)	2-10
2-4	Major Activity Centers	2-11
2-5	Existing Land Use	2-13
2-6	Major Private Investments	2-15
2-7	Adopted Full System Alignment	2-19
2-8	River Crossing ASE	2-21
2-9	Riverside ASE	2-23
2-10	Bus-Only Alternative	2-24
2-11	Bus Routes	2-30
2-12	Westinghouse Vehicle and Guideway - Busch Gardens	2-39
2-13	Disney Mark IV Vehicle and Guideway - Walt Disney World	2-41
2-14	UTDC Vehicle and Guideway - Kingston Text Track	2-42
2-15	Marta-Val Vehicle and Guideway - Lille	2-44
2-16	Niigata Vehicle and Guideway - Test Track	2-45
2-17	Fuji Vehicle and Guideway - Test Track	2-46
2-18	Kawasaki Vehicle and Guideway - Kobe Port Island	2-48
3-1	Proposed AC Power Distribution	3-12
3-2	Proposed DC Power Distribution	3-13
3-3	Hogan Street (State to Church Streets)	3-21
3-4	Hogan Street (Church to Bay Streets)	3-22
3-5	Bay Street (Hogan to Clay Streets)	3-23
3-6	Jefferson Street (Broad Street to SCL RR)	3-24
3-7	Bay Street (Clay to Broad Streets)	3-25
3-8	May Street (SCL RR to CMSA)	3-26
3-9	Acosta Bridge (Riverside)	3-27
3-10	Acosta Bridge (Center)	3-28
3-11	Acosta Bridge (Southside)	3-29
3-12	Mary Street (Acosta Bridge to Flagler Street)	3-30
3-13	Mary Street (Main Street to Hendricks Avenue)	3-31
3-14	Hendricks Avenue to St. Johns Place	3-32
3-15	South Terminal	3-33
3-16	Typical Guideway	3-35
3-17	Typical Guideway	3-36
3-18	Typical Guideway	3-37
3-19	Vehicle Loading Diagram	3-39
3-20	Perspective of Hemming Plaza Station	3-40
3-21	Development Under Hogan Street Guideway	3-41
3-22	Typical Switches	3-42
3-23	Terminal Station Turnback	3-43
3-24	Surface Geology Map	3-45

LISTING OF FIGURES (CONT.)

<u>FIGURE</u>	<u>TITLE</u>	<u>PAGE</u>
3-25	Generalized Subsurface Profile	3-46
3-26	Utility Relocations, Hogan Street	3-48
3-27	Utility Relocations, Bay Street	3-49
3-28	Utility Relocations, Mary Street	3-50
3-29	Street Renovations, Bay Street	3-52
3-30	Street Renovations, Hogan Street	3-53
3-31	Street Renovations, Mary Street	3-54
3-32	Typical Guideway Systems	3-56
3-33	Typical Construction Scene	3-59
3-34	Vehicle Clearance Envelope	3-61
3-35	Prototypical Intermodal Station Design	3-65
3-36	Prototypical Urban Station Design	3-66
3-37	FJC Station Area Site Plan	3-68
3-38	Hemming Plaza Station Area Site Plan	3-69
3-39	Central Station Area Site Plan	3-71
3-40	Jefferson Station Area Site Plan	3-72
3-41	Prudential Station Area Site Plan	3-73
3-42	Gulf Life Station Area Site Plan	3-74
3-43	St. Johns Place Station Area Site Plan	3-75
3-44	Design Vehicles and Minimum Turning Paths	3-78
3-45	Driveways for Parking Lots	3-79
3-46	Control, Maintenance, and Storage Area Site Plan	3-87
3-47	Control and Maintenance Facility	3-88
3-48	Typical Control Center	3-90
4-1	Full Recommended System	4-2
4-2	Patronage Analysis Methodology	4-4
4-3	Regional and Shuttle Lines	4-10
4-4	Replacement Lines	4-11
4-5	Regional Extensions	4-12
4-6	Local Circulation Lines	4-13
4-7	Ridership Profile, 1985, Noon	4-22
4-8	Ridership Profile, 1985, PM	4-24
4-9	Ridership Profile, 1995, Noon	4-25
4-10	Ridership Profile, 1995, PM	4-26
4-11	Jacksonville ASE Guideway Layout	4-32
4-12	Jacksonville ASE Guideway Schematic - Total System	4-34
4-13	North/South Line Degraded Operation Shuttles	4-37
4-14	East/West Line Degraded Operation Shuttle	4-38
4-15	Typical Switchback at Stations with Storage in Station	4-40
4-16	Typical Maintenance and Storage Siding Guideway w/2-Car Storage	4-42
4-17	First Segment Degraded Operation Shuttle	4-44

LISTING OF FIGURES (CONT.)

<u>FIGURE</u>	<u>TITLE</u>	<u>PAGE</u>
5-1	Design Aesthetics Segments	5-5
5-2	Perspective of FJC Station	5-6
5-3	Development Under Hogan Street Guideway	5-7
5-4	Perspective of Hemming Plaza Station	5-8
5-5	Perspective of Central Station	5-9
5-6	Perspective of Jefferson Station	5-10
5-7	Perspective of Prudential Station	5-11
5-8	Perspective of Gulf Life Station	5-12
5-9	Relocation and Property Acquisition	5-14
5-10	Typical Exterior Noise Contours	5-31
5-11	Historic Property	5-44
5-12	Side Entrance on the West Facade of the First Baptist Church	5-47
5-13	The South and West Facades of the St. James Building	5-47
5-14	North and West Facades of the USF&G Building	5-48
5-15	Main Entrance on the West Facade of the Seminole Club	5-48
5-16	Side Entrance on the West Facade of the Levy-Wolf Building	5-49
5-17	South and East Facades of the El Modelo Cigar Factory	5-49
5-18	South Facade of the A.R. Cogswell Building	5-50

LISTING OF TABLES

<u>TABLE</u>	<u>TITLE</u>	<u>PAGE</u>
2-1	Total Employment by Census Tract, Planning Subarea 6	2-3
2-2	Alternatives Evaluation of Long-Term Impacts	2-26
2-3	Alternatives Evaluation of Short-Term Impacts	2-27
2-4	1975 Traffic Volume and Capacity	2-31
2-5	River Crossing ASE, 1985 and 1995 Weekday Patronage by Type	2-33
2-6	River Crossing ASE, Florida Junior College Station to St. Johns Place Station	2-33
2-7	Capital Cost Breakdown, River Crossing ASE	2-36
2-8	1985 O&M Costs	2-37
2-9	Baseline Characteristics	2-49
2-10	Comparison of Equipment with Jacksonville Requirements	2-53
3-1	Summary of Performance Capabilities	3-3
3-2	Passenger Comfort	3-7
3-3	Assumed System Parameters	3-11
3-4	Proposed Design, Electrical	3-14
3-5	Summary of AVP System Actions	3-15
3-6	Vacant	
3-7	River Crossing ASE, Partial Visual Obstructions to Traffic	3-51
3-8	Typical Guideway Construction Sequence and Duration	3-58
3-9	Horizontal and Vertical Design Criteria	3-62
3-10	1995 Peak Period Daily Station Volumes	3-64
3-11	Minimum Average Illumination	3-83
4-1	Development by Subarea and Land Use	4-6
4-2	Total Travel in Study Area by All Modes	4-7
4-3	Transit Lines	4-9
4-4	Preliminary Patronage Summary	4-16
4-5	Percentage of Daily Travel by Market Segment	4-18
4-6	Full System - A, Peak Period and Daily Station Volumes	4-19
4-7	Design G, Peak Period and Daily Station Volumes	4-20
4-8	Comparative JASE Patronage Estimates	4-21
4-9	Jacksonville ASE System Initial Segment	4-28
4-10	Jacksonville ASE System Full Recommended System	4-29
4-11	Initial Segment Performance	4-46
4-12	Jacksonville ASE System Staffing Plan	4-49
4-13	Hazard Probability Rankings	4-56
5-1	Summary of Visual Impacts	5-13
5-2	Proposed Acquisitions and Relocations	5-13
5-3	Employment, Income and Business Activity Induced by ASE	5-19

LISTING OF TABLES (CONT.)

<u>TABLE</u>	<u>TITLE</u>	<u>PAGE</u>
5-4	Line Haul Energy	5-24
5-5	Modal and Program Energy	5-25
5-6	Modal Shifts and Changes in Daily Vehicle-Miles of Travel, 1985	5-27
5-7	Modal Shifts and Changes in Daily Vehicle-Miles of Travel, 1995	5-27
5-8	Decreases in Emissions	5-28
5-9	Results of Microscale Air Quality Modeling	5-29
5-10	Interior Vehicle Noise Levels	5-30
5-11	Business Disturbances, River Crossing ASE Construction	5-36
5-12	Summary of Direct and Indirect-Induced Effects of Construction	5-38
5-13	Typical Construction Equipment Peak Noise Levels	5-41

SUMMARY

INTRODUCTION

This report is intended to provide a convenient and comprehensive reference document covering the project background and summarizing the work effort on the Preliminary Engineering/Environmental Impact Statement phase of the Jacksonville Automated Skyway Express (JASE) System. The chapters which follow are a compilation or condensation of parts of the EIS and the various technical memoranda or formal reports prepared during the two years devoted to the program.

Some parts of the report contain detailed technical information on specific elements of the proposed JASE System. This type of information is provided in only sufficient detail to enable an understanding of the scope of the project and to provide a means for following the decision-making process used in advancing the design of the various segments of the system. Complete copies of the preliminary engineering design drawings, the Environmental Impact Statement, the various technical memoranda and reports, and the other references contained herein are on file with the Jacksonville Transportation Authority or the issuing agency mentioned in the reference section at the end of each chapter.

Preliminary engineering design was initially intended to serve as the basis for a design/construct bid package which would include construction of all physical facilities and acquisition of vehicles, equipment, and support technology for a full 4.4-mile system. (See Figure 2-7). For that reason, the Full System alignment was mathematized in detail, including all stations, turnouts, and storage areas, using the results of a balanced, second-order horizontal and vertical survey. When the prospect for federal funding became remote in early 1981, a decision was made to concentrate the preliminary design effort on the two short segment alternatives covered by the EIS, known as the River Crossing and Riverside Alternatives. This included guideway plan and profile drawings, structural drawings for the guideway and stations, right-of-way plans, station site plans and architectural renderings, maintenance area plans, and plans for utility relocations and street renovations. Preparation of vertical profiles and other preliminary design for the remaining north and east legs of the system were carried to a point that would permit development of a reasonably accurate capital cost estimate, information that is carried in the Technical Memorandum on that subject. The completed program gives the JTA considerable flexibility in planning and programming construction when funding becomes available for any portion of the system, either on an equipment procurement/design and build or design/build concept.

Total effort by the consultant and the various subconsultants on the PE/EIS phase amounted to more than 30,000 man-hours. This does not include the considerable involvement of the JTA staff and the appointed Task Force nor the substantial man-hours contributed by members of the Citizens Advisory Committee and its various subcommittees. Figure 1-1

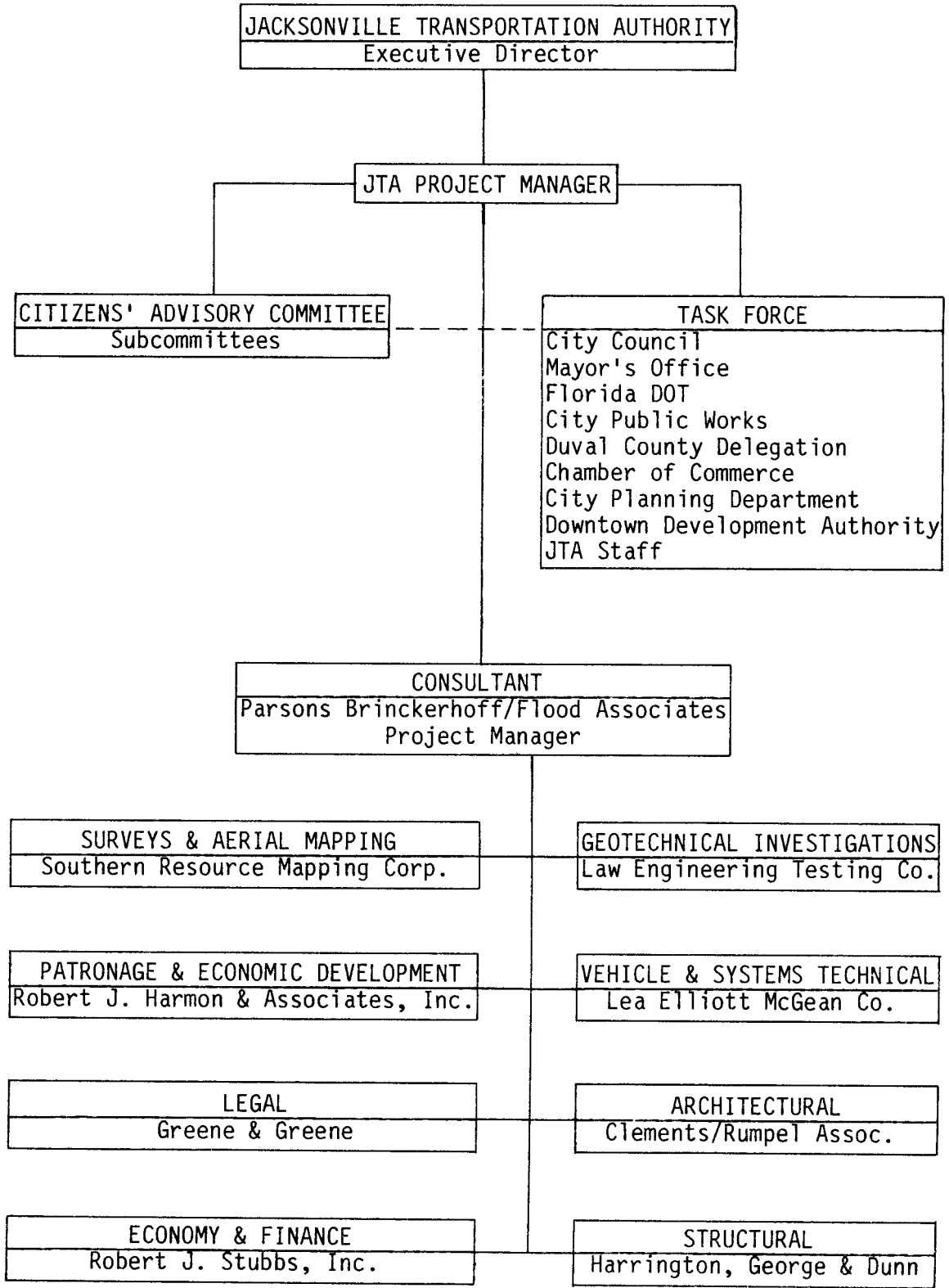

FIGURE 1-1

ORGANIZATIONAL CHART

shows the organization and interaction of the different agencies and groups who have taken part since this phase began in July 1980.

HISTORY OF THE PROJECT

Chapter 2 provides a complete history of the project. It describes studies in the early 1970s applying the technology to Jacksonville followed by a discussion of succeeding studies which led to the PE/EIS program covered by this report. It provides background on Jacksonville and its Downtown area, including transportation aspects, followed by an outline of the citizen involvement program used during the Feasibility Study of 1978 and carried forward through the current project. The alternatives analysis process used in route selection is discussed in detail, major factors affecting system feasibility are presented, and AGT technology selection is summarized.

THE INITIAL SEGMENT

The next chapter is devoted exclusively to the 2.1-mile River Crossing Alternative on which major emphasis was placed during the PE/EIS process. This includes a description of the reference vehicle and systems used for preliminary design purposes, a detailed description of the route, a review of the criteria and standards developed for facilities design, and an overview of the guideway, station, and maintenance area designs, including selected examples of the preliminary engineering design drawings.

PATRONAGE AND OPERATIONS

Chapter 4 deals first with a detailed examination of patronage forecasting assumptions and methodology and then the application of patronage estimates to alternatives analysis and system design. The balance of the chapter presents an explanation of the JASE System operations. This includes system operational scenarios, staffing requirements, bus interfacing, system safety, reliability, and security provisions, and a description of the 4.4-mile Baseline System.

ENVIRONMENTAL CONSIDERATIONS

The last chapter presents a summary of environmental impacts resulting from construction of the system as developed in the Environmental Impact Statement. This is followed by a review of the required steps and the legal requirements of the EIS process.

INTRODUCTION

COMMUNITY FRAMEWORK

Project Background

In 1968, the City of Jacksonville, Florida became consolidated with the county government of Duval County, Florida. The resulting local unit of government, called the City of Jacksonville, governs the jurisdiction formerly governed by the Duval County government, an 840-square mile area including what is now called "Downtown Jacksonville".

Downtown Jacksonville (Figure 2-1) is divided by the St. Johns River. It is the insurance capital of the South as well as the Southeast's leading distribution and manufacturing center. Jacksonville is the location of home or regional offices for 34 insurance companies, 3 major railroads, 40 truck lines, 3 of the 6 largest banks in Florida, and about 600 industries. The port handles 15 million tons of varied commodities annually. The Atlantic Coastline at Jacksonville is the location of numerous resorts and 3 major bases of the U.S. Navy.

The City of Jacksonville's Planning Department maintains current estimates of the population characteristics of each of the City's planning units. Downtown Jacksonville lies in Planning Subarea 6 (PS6). A study of employment conducted by the Jacksonville Planning Department in 1978 showed that the 5-square mile metropolitan area which surrounds Downtown contains one-third of all the jobs in Duval County. The 1970 Census indicates that this area contains about 15% of the total population.

Table 2-1, "Total Employment by Census Tract", identifies the major categories of employment. Downtown Jacksonville lies inside the area bounded by census tracts 8, 9, 10, 17, 18, and 19 (Figure 2-2). These census tracts contain over 70% of the employment in PS6. Census tract 9, which is the principal Downtown commercial area, has over 30% of the total employment and over 60% of all retail jobs in PS6.

The growth of the economy in Jacksonville has been the direct result of coordinated efforts of the public and private sectors. The consolidated government made one of its first priorities the development of a uniform policy for the integration of future development into the Downtown. Downtown Jacksonville is intended to become self-sufficient, a successful city in itself; a place to live, work, and play for all income levels.

In the early 1970s, the need to develop a plan for this redevelopment and rehabilitation effort resulted in the "Plan for Downtown Jacksonville". This plan proposes development along the Downtown riverfront of new employment, residential, and convention "activity centers" and the improvement of transportation linkages between Downtown activity centers. This plan has been followed by public and private interests over the last decade with detailed planning, design, and construction activity focused on such major projects as:

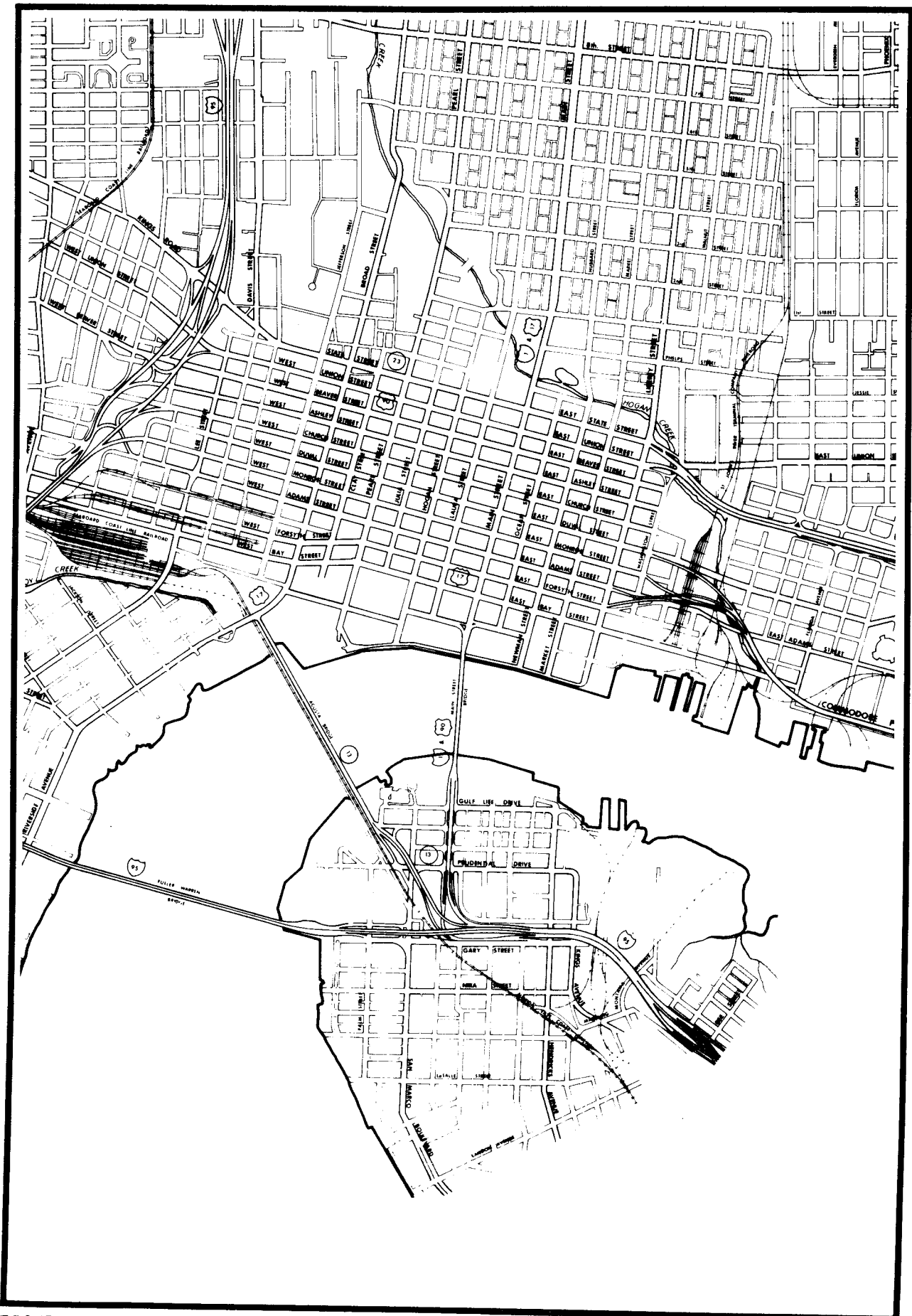

FIGURE 2-1

LOCATION MAP, DOWNTOWN JACKSONVILLE

TABLE 2-1
TOTAL EMPLOYMENT BY CENSUS TRACT*
PLANNING SUBAREA 6

<u>CENSUS TRACT</u>	<u>MANUFACTURING</u>	<u>RETAIL</u>	<u>OTHER</u>	<u>TOTAL EMPLOYMENT</u>
2	1,170	18	3,146	4,334
3	1,673	156	2,062	3,891
4	531	101	1,901	2,533
5	337	275	2,453	3,065
8	209	314	9,958	10,481
9	75	3,913	22,962	26,950
10	1,986	157	6,085	8,228
11	16	28	365	409
12	410	247	1,589	2,246
13	184	109	790	1,083
15	0	60	2,940	3,000
16	16	10	727	753
17	685	28	252	965
18	50	225	2,750	3,025
19	1,202	503	10,891	12,596
29	<u>91</u>	<u>9</u>	<u>513</u>	<u>613</u>
Totals	8,635	6,153	69,384	84,172
Total, Duval County	28,027	43,224	173,119	244,370

*For 2nd quarter 1977; based on state unemployment insurance data files.

SOURCE: Jacksonville Area Planning Board, August 1978.

- * development of a transit system to provide linkage between Downtown business, residential, education, and entertainment activity centers;
- * development of elevated walkways providing improved access between employment and commercial sites at activity centers;
- * redesign of streets leading to the riverfront to incorporate pedestrian parks and outdoor malls;
- * development of new residential communities along the riverfront; and
- * redevelopment of business and entertainment facilities along the transit links between major activity centers.

Today, this planning and development activity Downtown is represented by the construction and renovation of commercial, entertainment, and convention facilities. Studies are underway to evaluate reconstruction of the Acosta Bridge, one of the three bridges linking the north and

CENSUS TRACT MAP

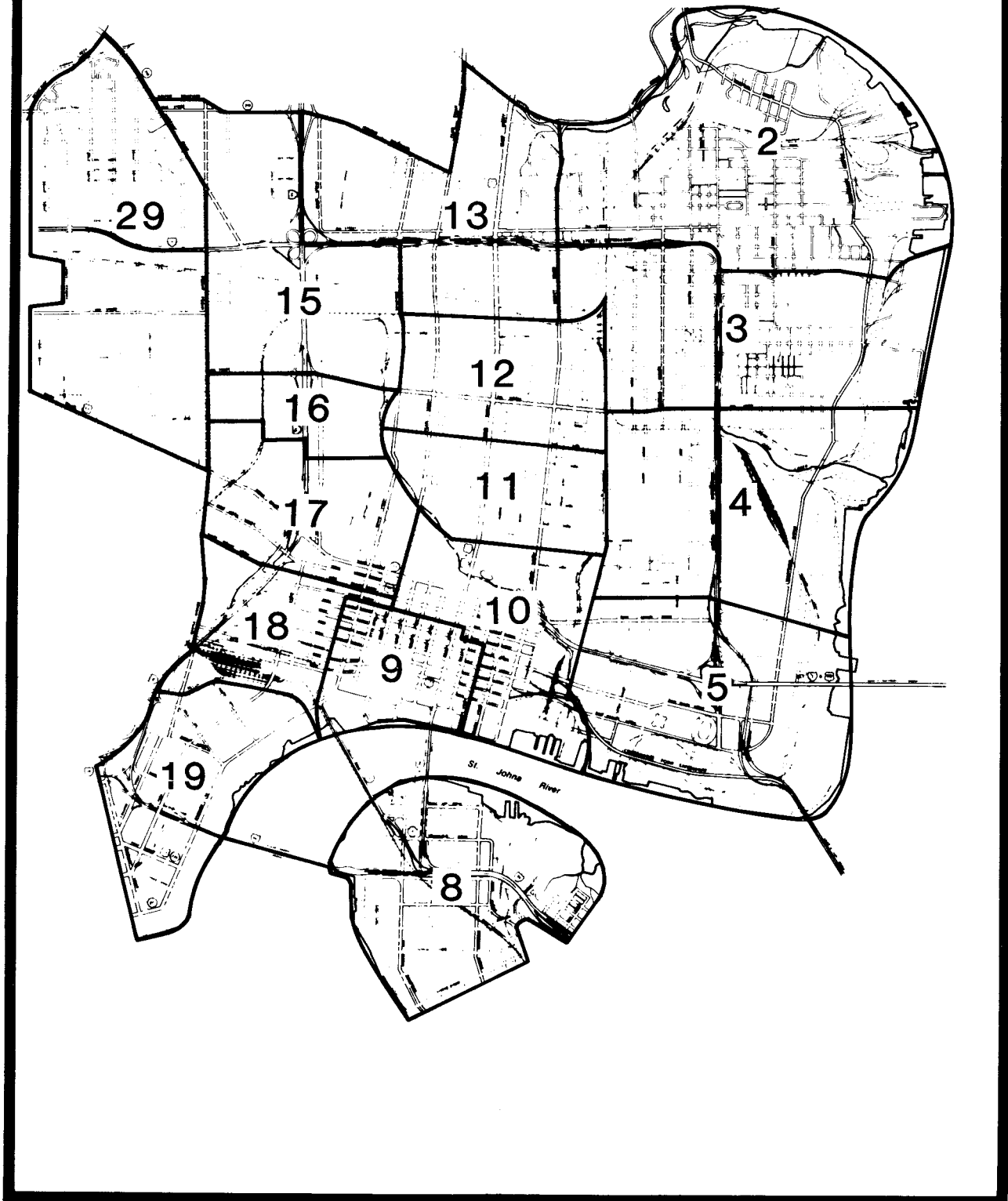

FIGURE 2-2

CENSUS TRACT MAP

south halves of Downtown. The Jacksonville Transportation Authority is expanding and modernizing the City's bus fleet and numerous street improvements are underway.

Planning Framework

New development and rehabilitation in Jacksonville is guided by goals and policies developed by the Jacksonville Planning Department and adopted by the City Council. These policies were included in the City's Comprehensive Plan¹ which guides the growth and development of Downtown Jacksonville. Among the adopted policies for Downtown are:

- * The Downtown area should be developed as a regional center for retail, commercial, residential, and selected industrial activities.
- * The development of offices, retail establishments, hotels, and restaurants Downtown should be promoted.
- * The growth of entertainment and cultural facilities and a diversity of residential environments should be promoted Downtown.
- * A new image for Downtown Jacksonville should be created through open space and recreation that complements the urban environment including open spaces and recreational areas that take advantage of the character and potential of the riverfront. A network of pedestrian linkages relative to the open space and recreational system should be created.
- * Parking capacity adequate to meet the future demand of office and retail activities in major high-intensity clusters at the periphery of the CBD should be provided. Development of long-term parking facilities within the Downtown area should be balanced against the goal of increased transit usage for Downtown work trips.
- * A circulation system which separates automobile and truck movement from pedestrian movements, which defines the hierarchies of movement, and which provides a system of efficient movement of people and goods based upon the demands of activity concentrations, should be established.
- * Automobile dominance and through-traffic within the urban core should be discouraged.
- * Strong pedestrian linkages between retail/office concentrations and functionally-related areas and between centers and functionally-related areas should be developed.
- * Retail activities should be encouraged in areas adjacent to primary pedestrian activity. Office use should be discouraged at grade level directly adjacent to such areas.

This policy is used by City departments and other public and private

interests in their preparation of specific development or rehabilitation proposals or the review and approval of such actions. In addition, guidelines for development at specific locations are stated in the City's formal studies and area plans. Orderly growth is enforced by the City's statutory land use control mechanisms; specifically:

- * Zoning Ordinance and Atlas
- * Subdivision Ordinance
- * Floodplain Ordinance
- * Private Streets and Road Ordinance
- * Building Code

The Jacksonville Planning Department and the Downtown Development Authority have been the principal agencies of the City which have studied the character of Downtown Jacksonville and the neighborhoods surrounding it. They have developed the specific location plans for coordinated development and rehabilitation. The Downtown Development Authority is now in the process of updating and revising earlier plans which guided the scheduling and promotion of specific Downtown projects.^{2,3} The neighborhoods which surround Downtown have received similar study and planning efforts by the Jacksonville Planning Department during the last decade. These plans include the:

- * West-Central Area Study (Riverside and the Blighted Area)
- * Hospital Area Study (Medical Complex and Hogan Creek)
- * Springfield Neighborhood Plan
- * St. Johns River Environmental and Urban Design Study

TRANSPORTATION ASPECTS

JUATS (Jacksonville Urban Area Transportation Study)

A high proportion of all traffic in the Jacksonville urban area moves through Downtown. Future growth and development Downtown is expected to add significantly to this traffic. Numerous alternatives for improving the area's transportation system have been under study. The goal of this transportation planning effort has been to identify and implement the most cost-effective and environmentally acceptable improvements to the transportation system. This planning began in 1965. Called the Jacksonville Urban Area Transportation Study (JUATS), this process became the area's first comprehensive, coordinated, and continuing transportation planning effort. Through JUATS, transportation planning was coordinated with the urban area's long-range comprehensive plan, urban development objectives, and social, economic, environmental, and energy conservation goals and objectives.

The Jacksonville Planning Department and the Jacksonville Transportation Authority have produced numerous documents in the last decade which have molded the current transportation plan element of the City's Comprehensive Plan. These documents have studied vehicle use and transit patronage, capital and operating costs for transportation improvements, and the funding resources available. Among the major transportation planning documents of the JAPD are:

- * Year 2005 Transportation Plan (2/81)
- * Transportation System Management Plan: 1978-82
- * Transportation Improvements Program (Annual Updates)
- * Preferential Treatment for High Occupancy Vehicle Study (3/79)
- * JUATS Bikeway Plan: 1979-85
- * Preliminary 1985 Mass Transportation Plan
- * Duval County Air Quality Control Plan (10/79)

The efforts of the Jacksonville Transportation Authority to improve mass transit are documented in the Jacksonville Area Transit Development Program Annual Updates and the 1980 Jacksonville Area Transition Plan (for the provision of transit access for the handicapped).

These planning efforts have identified feasible alternatives to accommodate present and future traffic demands. The alternatives presently being implemented include major roadway improvements, an expanded mass transit system, and specific short-term and relatively low-cost transportation system management improvements.

Major roadway improvements include safety modifications to I-95 and I-10, HOV lane provisions, and improvements to the major arterials; bikeways along the major growth corridors radiating from Downtown; and the rehabilitation or replacement of the Acosta Bridge connecting the Downtown's north and south halves.⁴

The major need for the mass transit system is expanded service Downtown. The City's approved long-range plan calls for a rapid transit system to move in an exclusive right-of-way, connecting Downtown activity centers with park-n-ride lots in suburban areas, and provide interfaces with local, express, and Downtown shuttle buses.⁵

Transportation system management (TSM) improvements have focused on feasible short-range projects to maximize the efficiency of the existing roadway and transit facilities. The alternatives currently investigated to address specific street and intersection congestion include:

- * preferential treatment for high occupancy vehicles
- * intersection and channelization projects
- * new traffic signals
- * coordinated traffic signal systems
- * preemption signal systems for buses and signal upgradings
- * restrictive on-street parking policies
- * ride-share program

Detailed descriptions of the status of these and other TSM projects may be found in the Transportation System Management Plan : 1978-82.

All of these transportation planning efforts seek to support the "Growth Corridors Concept" for Downtown Jacksonville stated in the Comprehensive Plan.¹ The concept encourages future highway improvements coupled with mass transit improvements to allow more intensive land use development along the major travel corridors which radiate from Downtown.

Regional Interfaces

The issue of transportation linkage is important to the integrity of the plans for development and maintenance of an active Downtown. With efficient and comfortable transportation links between activity centers, growth can be accommodated Downtown. Planning has shown how pedestrian-ways, parks, and residential and office facilities developed through new construction or renovation can further stimulate and maintain the economic vitality of Downtown. However, without efficient and comfortable transportation links, developers will abandon the renovation of existing Downtown buildings for undeveloped sites adjacent to regional transportation corridors. This spread of development beyond Downtown would: (1) reduce the efficiency of the Downtown transit system, (2) prevent the consolidation of office, residential, and entertainment activity centers, (3) encourage further sprawl and branching of services provided by the public sector, and (4) result in the growth of blighted areas as office and retail facilities succumb to age or the lack of adequate exposure to consumer trips.

Transportation system improvements are already needed to meet the demands placed on it by growth of the last decade and the nationwide efforts to reduce air pollution. A recent study for the Jacksonville Urban Area Transportation Study estimated that person-trip generation Downtown is expected to increase from 330,000 (in 1975) to 440,000 trips per day in the year 2005.⁵ Planning efforts have focused on feasible alternatives to accommodate traffic demands and decrease vehicular trips to the Downtown.

The greatest need for improved public transit lies Downtown. In 1980, the transit system was estimated to have intercepted 9% of the person-trips destined for Downtown. Use of numerous interfacing transit loops and designation of one-way streets with exclusive public transit lanes could have enabled the bus transit system to intercept up to 15% of the Downtown person-trips by 1985.³

It is important to note, however, that growth of transit use Downtown after 1985 is not considered possible unless major structural changes are made in the street system and transit mode. By 1985, the existing bus transit system will not be able to accommodate additional ridership without a significant, almost unrealistic, decrease in headways.

A rapid transit system, moving in its own exclusive right-of-way, has been identified as the transit mode which is capable of meeting the transportation needs of Downtown Jacksonville. Such a system could intercept trips between major activity centers Downtown, connect park-n-ride lots on the fringe of Downtown with Downtown employment centers -- decreasing commuter trips Downtown, and provide a system of inter-connecting links between the Downtown and the regional bus transit system which can encourage additional transit use by commuters. The JUATS Major Review recently estimated the intercepted person-trips in the year 2005 for such a rapid transit system as 18.4% of the total trips with origins or destinations Downtown.⁵

The River Crossing Automated Skyway Express System would provide the necessary interface and linkage with the proposed regional rapid transit system as its route coincides with the Downtown segment of the JUATS plan (Figure 2-3).

ECONOMIC AND DEVELOPMENT ASPECTS

CBD Characteristics

Downtown Jacksonville is characterized by high-density commercial, office buildings, some older neighborhoods, warehousing, light and heavy industrial uses, large governmental office buildings, cultural and institutional facilities, and shipyards. The major activity centers Downtown are identified in Figure 2-4. The older urban core of commercial and public facilities on the north side of the St. Johns River is connected to medical, office, and convention facilities with the south side by 3 bridges: Fuller Warren (I-95), Acosta (State Route 13), and Main Street (U.S. 1 and 90). There are four distinct types of activity centers downtown:

- 1) Recreational centers where sports, theatrical, or other exhibitions are conducted such as the Gator Bowl Complex and the Civic Auditorium.
- 2) Commercial centers where employment supports restaurants and shopping such as the retail core around Hemming Plaza and the Independent Life Building.
- 3) Existing development of office and special use facilities which are established landmarks such as the Government Complex east of the retail core, Independent Life Building, Jacksonville Shipyards, Seaboard Coastline Railroad Building, the Florida Times Union Building, Florida Blue Cross/Blue Shield Building, and the Federal Building on the north side and Baptist Medical Center, Prudential Life Building, and Gulf Life Building on the south side.
- 4) New development where vacant or under-utilized land is currently undergoing development such as the Downtown Campus of Florida Junior College, Northbank Development Area, and St. Johns Place.

The concentration of banking and insurance firms in Downtown Jacksonville has made it one of the strongest financial centers in the Southeast. Business activity Downtown is dominated by this financial center and retail trade.

During 1979, retail sales in Jacksonville reached \$2.8 billion.⁶ Projections developed by the Florida Department of Commerce estimate a steady growth in these figures, reaching annual sales of \$3.2 billion by 1985. Figures available from the Florida Department of Revenue on the Local Option (occupancy) Tax indicated that during 1979, hotel/motel occupancy generated \$31.6 million in sales in Jacksonville.

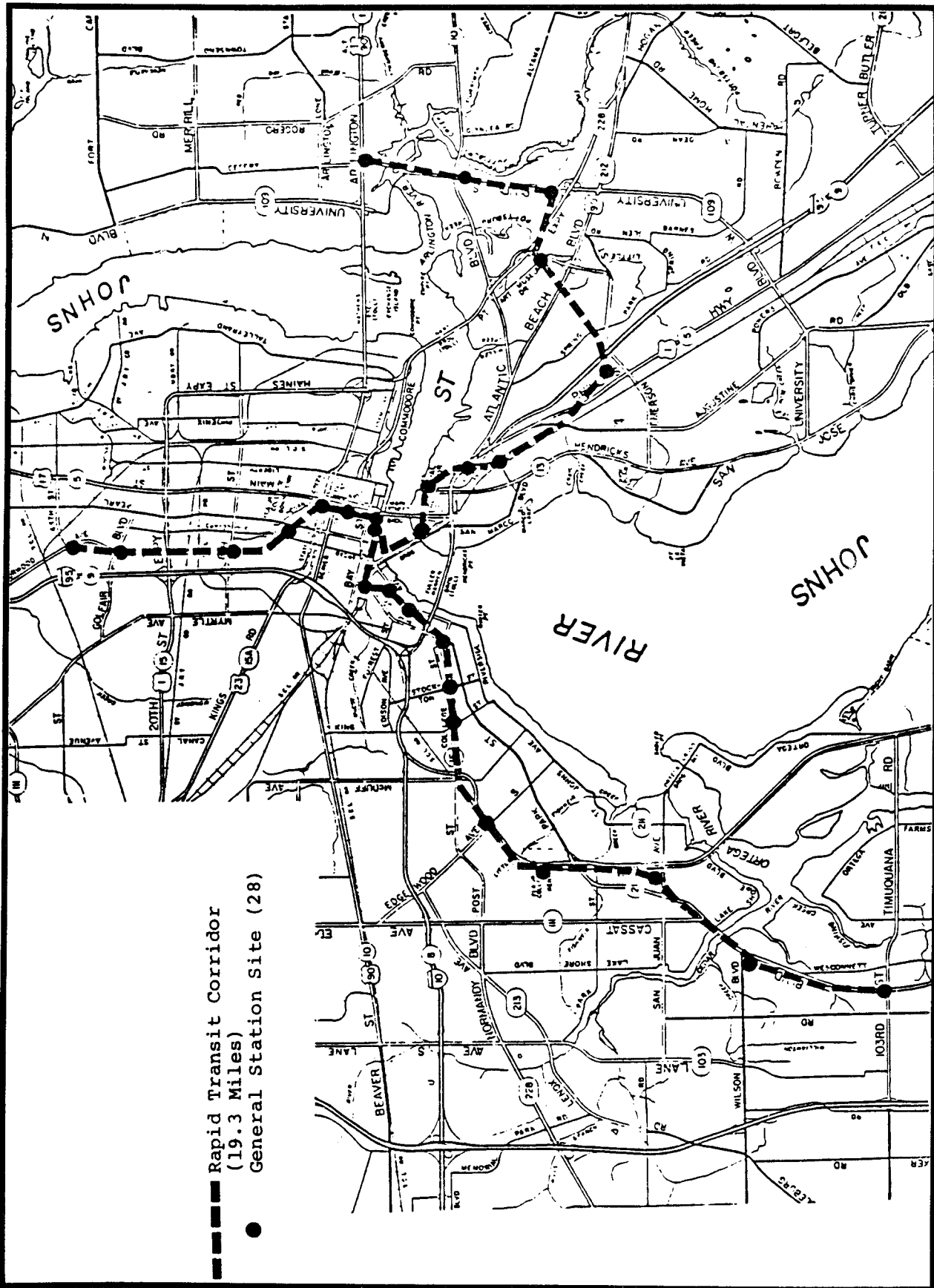

REGIONAL RAPID TRANSIT SYSTEM
YEAR 2005 (JUATS)

FIGURE 2-3

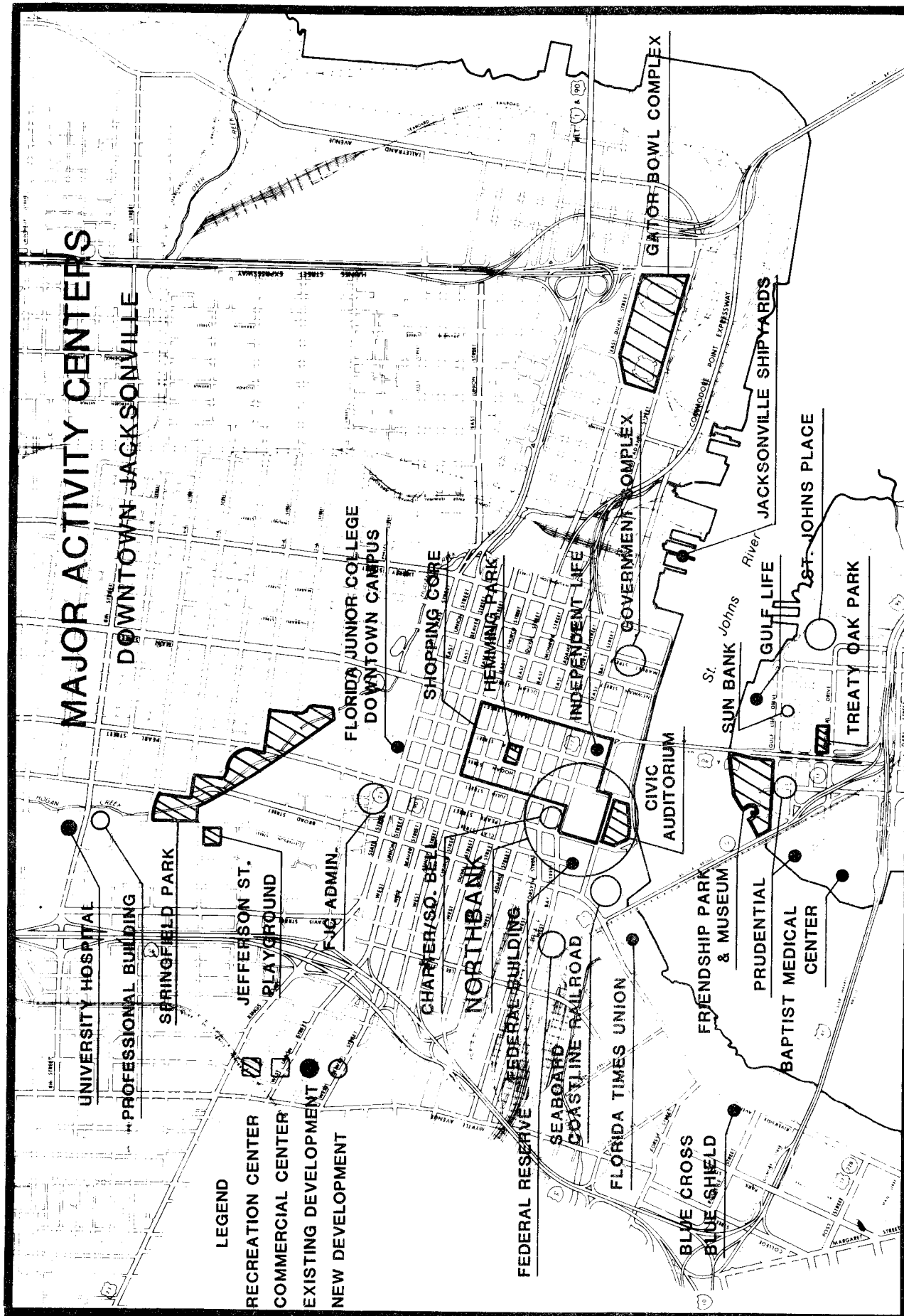

MAJOR ACTIVITY CENTERS

FIGURE 2-4

A massive fire on May 3, 1901 burned over 466 acres of the area north of the St. Johns River and destroyed 2,400 buildings. The recovery period which followed saw 3,000 new buildings erected by 1905. Gone was much of the residential character of Downtown Jacksonville; replaced by commercial and government buildings. However, surrounding the Downtown area within Planning Subarea 6 are still many old single-family homes and churches which predate the fire. The Downtown area has three important characteristics identified by planning studies of the Downtown Development Authority:

"One is dispersal, with relatively long distances between the major activity nodes. Another is the opposite -- concentration -- with the Central Core still attracting major new facilities even as dispersal takes place. The third is a sharp variation that exists in the quality and intensity of development within the area. There are modern new buildings mixed in with obsolete and near vacant structures, spectacular waterfront developments and dreary slums, high intensity blocks and virtually unused open space. A large part of the area is susceptible to change."³

Growth Aspects

Today, 86% of the total area within the City's Planning Subarea 6 which includes Downtown is built upon. The existing land use in this area is shown in Figure 2-5. Non-residential uses, primarily the Downtown, represent 50% of this area. About 25% of the land is residential use and the remainder is roadways and vacant land. The little residential use Downtown is intense, 10 units per acre or more. Industrial land use is located primarily along the St. Johns River and adjacent to highway or rail facilities.

The vacant land Downtown is considered a developable resource by the City. Large tracts of this developable land lie along the riverfront in the Riverside neighborhood and on the south side of the St. Johns River. Parking lots now occupy much of the developable riverfront land on the north side of the St. Johns River. Development of public and private projects on this land is encouraged by the City's Comprehensive Plan. The Plan specifically requires that such projects conform with the concept of "mixed use of similar intensity".² This concept approves of mixed, compatible land uses as long as the intensity or density of development is similar to that of surrounding land use. Such a concept encourages high-rise residential buildings Downtown among the existing office towers. However, it also demands that ground level pedestrian malls around the office towers connect with new open space, gardens, and riverfront plazas around residential structures.

Private investment in new buildings Downtown has exceeded \$347 million since 1971. The 37-story Independent Life Tower on the north side of the St. Johns River is one of the two tallest buildings in Florida and is now the dominant feature of the Downtown skyline. New commercial projects have added office buildings, hotels, and residential high-rise

JACKSONVILLE, FLORIDA

EXISTING LAND USE

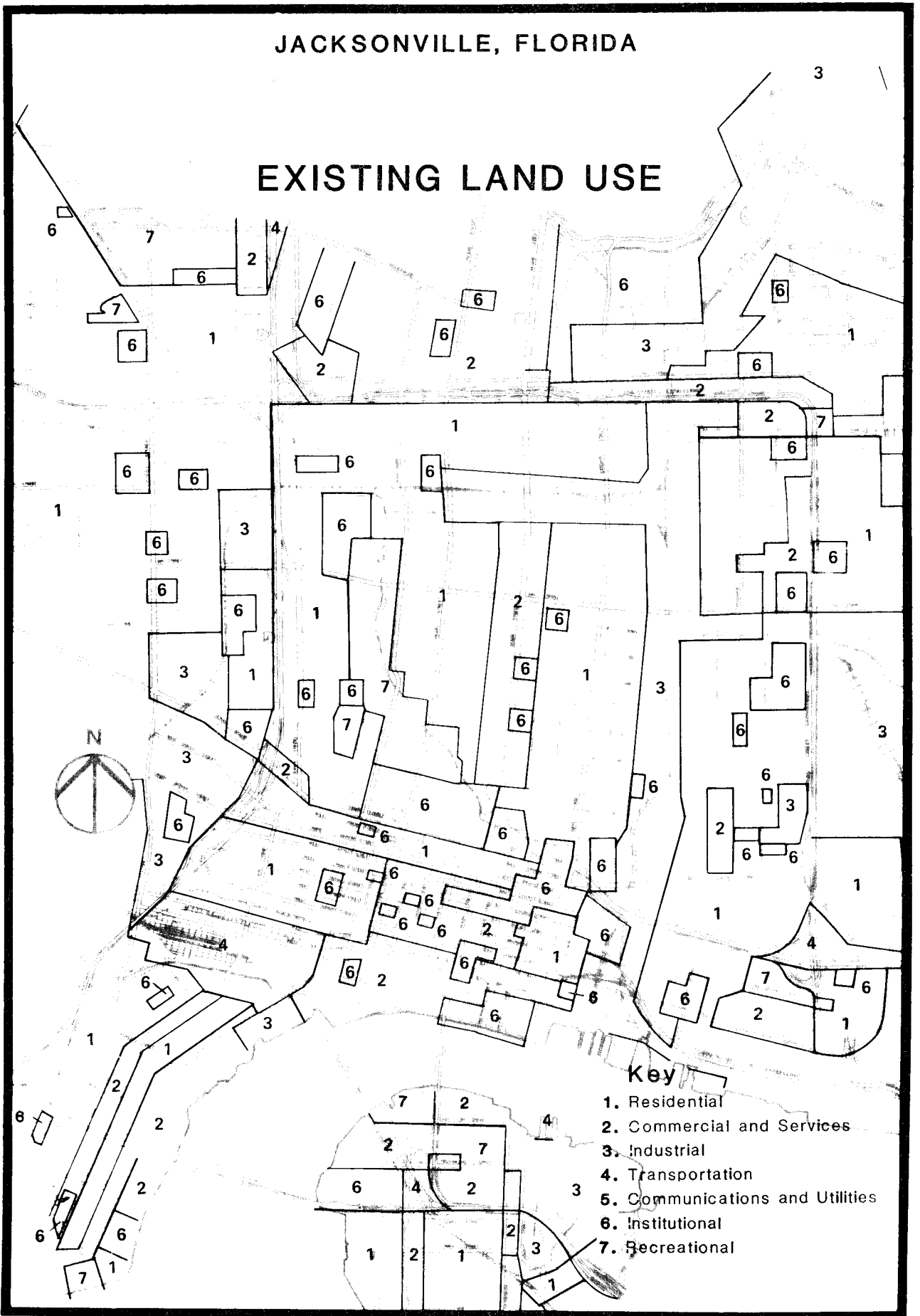

FIGURE 2-5

structures. The location of the major new structures are shown in the "Map of Private Investments", Figure 2-6. In addition to the completed and proposed projects on the map, numerous buildings have been rehabilitated. Since 1971, \$18 million has been spent restoring 12 old buildings Downtown and rehabilitation efforts have been proposed or initiated at 70 old buildings Downtown.

Among the major multi-use projects being planned for development Downtown are "Northbank" and "St. Johns Place". Florida Junior College continues expansion at its Downtown location and adjacent to the Northbank project Seaboard Coastline Industries has just completed a high-rise office tower behind its existing headquarters building on the St. Johns River.

Of the two major multi-use projects, Northbank is the largest with a planned development value of \$200 million. This will place on the riverfront between the Main Street and Acosta Bridges approximately 2,700,000 square feet of office space including the new Southern Bell Telephone Company Building. On the south side of the river, a new riverfront hotel/commercial office complex, known as St. Johns Place, is underway near the Gulf Life Building just east of the Main Street Bridge. The project will contain a 352-room Sheraton Convention Hotel, 700,000 square feet of office space, 50,000 square feet of retail space, and over 750 new residential units with full recreational facilities including a marina. The first phase of this development includes the recently completed hotel, a 1,500-foot riverfront boardwalk containing 20,000 square feet of boutiques, shops, and retail areas, two restaurants of 300 seats each, and a 120,000-square foot office structure.

Downtown Jacksonville is experiencing the greatest development period since the 1901 fire destroyed 80% of the area. The Downtown office market is strong and employment growth averages 1%-3% annually. Much remains to be done to fulfill the goals of the Comprehensive Plan and solve all the problems of traffic control and reduction. However, the planning activity, local government commitments, and massive private investments are all positive forces in making Downtown self-sufficient, a successful city in itself, a place to live, work, and play for all income levels.

PUBLIC INVOLVEMENT

Planning History

Various other transit alternatives falling broadly within the category of automated transit systems have been considered for implementation in Jacksonville over the last decade.⁷

The first such study in Jacksonville, Florida was done in 1972 under the auspices of the Florida Department of Transportation as a direct response to local interest in having such an automated transit alternative. In 1976, this study was updated and modified by the Mayor's Task Force and submitted to Urban Mass Transportation Administration (UMTA)

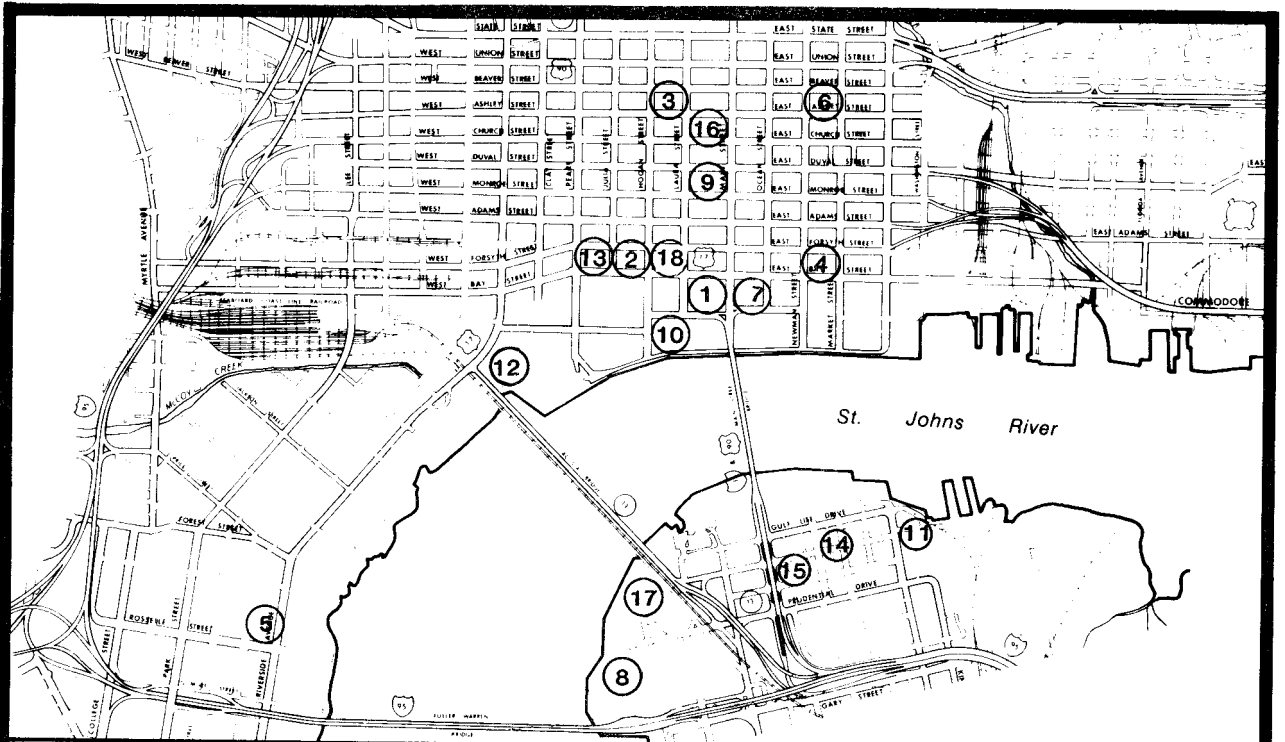

MAJOR PRIVATE INVESTMENTS : DOWNTOWN JACKSONVILLE

LEGEND

1. Independent Life Tower with Office and Retail Space - completed
2. Atlantic Bank Building - completed
3. First Baptist Church Sanctuary (permanent seating capacity 3500) and Elevated Pedestrian Way - completed
4. The Blackstone Building - completed
5. Blue Cross/Blue Shield Center - completed
6. Cathedral Manor Residential Towers - completed
7. Chamber of Commerce Building
8. Baptist Hospital Complex Parking Structure - completed
9. Galleria Office, Restaurant, and Shop - completed
10. Riverfront Convention Hotel and Activity Center - under study
11. Sheraton Hotel and Retail Complex - completed
12. Flagship Bank and Palmer Building - completed
13. Charter Office Building - under construction
14. 1300 Building - completed
15. IBM Building - completed
16. Charter Security Life Building - renovation completed
17. Prudential Life Insurance Expansion - under design
18. Barnett Bank Building - under design

FIGURE 2-6

as a proposal for a demonstration grant to build an automated transit system in Jacksonville. The proposal was of such merit that UMTA supplied funds to assist the Jacksonville Transportation Authority (JTA) in performing a technical/feasibility study.⁸

At the start of the study in 1978, the JTA Board set up two separate organizations -- the Citizens' Advisory Committee (CAC) and a Task Force -- to review and recommend the feasibility of such a system. This would provide the board with objective judgments from representatives of all elements of the community and from state and local agencies. These organizations worked so well during the feasibility study that they were carried forward intact to serve the same purpose during the Preliminary Engineering/Environmental Impact Statement phase which began in July 1980.

Citizens' Advisory Committee

After its initial appointment by the JTA Board, the CAC established itself as an independent body, formulated its own principles to insure impartiality, expanded its membership to all interested citizens, reviewed the work of the JTA staff and consultants, and made its recommendations to the JTA Board.⁹

Soon after its formulation, the CAC decided to organize itself functionally. Due to its increasingly large size (over 200 persons by November 1979), it was necessary to break the CAC into smaller groups to allow participants sufficient input and participation in the discussion of individual aspects of the study. The CAC then established a sub-committee format organized along functional lines to carry on the detailed work of the program. The citizens determined these sub-committees would meet on a weekly or bi-weekly basis as the subject matter required their attendance. The CAC also established regular monthly meetings to review and approve the work of the subcommittees on a periodic and timely basis.

One of the earliest CAC acts was to determine the principles by which it would participate in the program. It determined early that it would encourage an open membership policy, active public participation, bring to the program a neutral approach which would insure its objectivity, and make independent recommendations on the feasibility to the JTA Board. Further, the CAC formulated and implemented their own goals and objectives to judge feasibility and their own public involvement program (PIP) during the course of the study.⁹

The specific concerns of the CAC members with these issues and the measures taken to address these concerns in the development of the alternatives are documented in the final feasibility report on the study⁸ and in the Draft Environmental Impact Statement.¹⁰

Task Force

The Task Force was made up of staff representatives of affected agencies, specifically representatives from the Jacksonville Transportation Authority, the Office of the Mayor, the Florida Department of Transportation, Jacksonville Planning Department, Chamber of Commerce, Downtown Development Authority, City Department of Public Works, City Council, and the Duval County State Legislative Delegation. The Task Force not only supervised the work produced, but also provided data and advice. Political and technical expertise of the individual members served to complement the work being done by the Citizens' Advisory Committee in addition to providing the JTA staff with a highly proficient resource in developing recommendations to the JTA Board.

ALTERNATIVE ANALYSIS

The alternative analysis process to determine the best method of transporting people in Downtown Jacksonville involved many steps which, for the sake of clarity, can be grouped into four major efforts including:

- 1) The formulation of goals, objectives, and standards against which the alternatives were to be measured.
- 2) The formulation of the alternatives to be analyzed.
- 3) The creation and public acceptance of procedures and methods to perform the analysis.
- 4) The actual process by which alternatives were measured and a "best" alternative chosen.

Goals and Objectives

The process began with the formulation of project goals and objectives; the gathering of necessary data on AGT systems, regional planning, and the environment; and the determination of system ridership. In July and August 1978, the goals and objectives system parameters and operational criteria were formulated. These were reviewed, revised, and adopted by the CAC subcommittees and the JTA staff. The various goals and objectives considered to be of paramount importance included:

- 1) Revitalize the Downtown area as a retail and office center.
- 2) Promote increased use of the Downtown area as the cultural, educational, and recreational center of the region.
- 3) Encourage public/private joint development opportunities.
- 4) Minimize the public development costs.
- 5) Strengthen the opportunities for in-town residential development.
- 6) Improve Downtown area access and mobility for all persons, especially low income, the elderly, and the handicapped.
- 7) Provide an efficient, reliable, and pleasurable service.
- 8) Encourage the separation of pedestrian and vehicular traffic.
- 9) Promote increased transit ridership.
- 10) Reduce pollution and consumption of energy and minimize other environmental impacts.

- 11) Create a financially viable ASE System.
- 12) Create a functional and operationally workable ASE System.
- 13) And, of course, to insure an open and responsive planning process and inspire a high level of citizen participation.

In order to objectively measure the relative merits of each of the alternatives, it was necessary to quantify the goals and objectives established by the CAC. Accordingly, an alternatives analysis method entitled "Balance Sheet" was adopted by the CAC for use in the alternatives analysis. The Balance Sheet gave a numerical evaluation of all the alternatives including some which did not readily lend themselves to quantitative analysis. Each of the CAC subcommittees individually reviewed the goals and assigned goal weights for use in the analysis.

At the conclusion of the iteration process that the CAC, Task Force, and JTA staff conducted, a Recommended Full System Alternative was selected for evaluation. Following evaluation of the Recommended Full System, the CAC adopted a resolution in October 1979 establishing the initial feasibility of the system for Jacksonville. A detailed description of the Recommended Full System is provided in the Final Report on Project Feasibility.⁸

A similar system of alternatives analysis was carried out during the Preliminary Engineering/Environmental Impact Statement process even though different sets of goals and objectives was adopted for evaluation.

The preliminary engineering efforts were able to identify detailed siting requirements of the Recommended Full System which would improve accessibility, increase patronage, reduce capital costs, reduce potential displacements, eliminate adverse visual impacts to historic sites, increase joint development potential, as well as satisfy the demands of public and private property owners along the alignment. These decisions included changes in the location of stations along the route, alternative options, and siting fixed facilities such as the location of a guideway or station on a side of a street. This modified alignment, the Adopted Full System, was adopted by the Board of the Jacksonville Transportation Authority in February 1981. A schematic representation of the Adopted Full System alignment is shown in Figure 2-7.

This was not the final task in the planning process, however, as reducing federal funding possibilities led UMTA to request a limitation of the initial system to approximately 2 miles in length. Additional engineering studies, prepared with assistance from the Task Force, developed various short-segment alternatives that ranged in length from 1 to 3 miles and placed weighted values on a common set of characteristics applicable to all. Each alternative was scored and then ranked by numerical total by the Task Force. The CAC, during subcommittee meetings and at a general meeting, also ranked alternatives. These rankings were then presented to the JTA Board which adopted a 2.1-mile alignment connecting the Florida Junior College, north of Downtown, with the St.

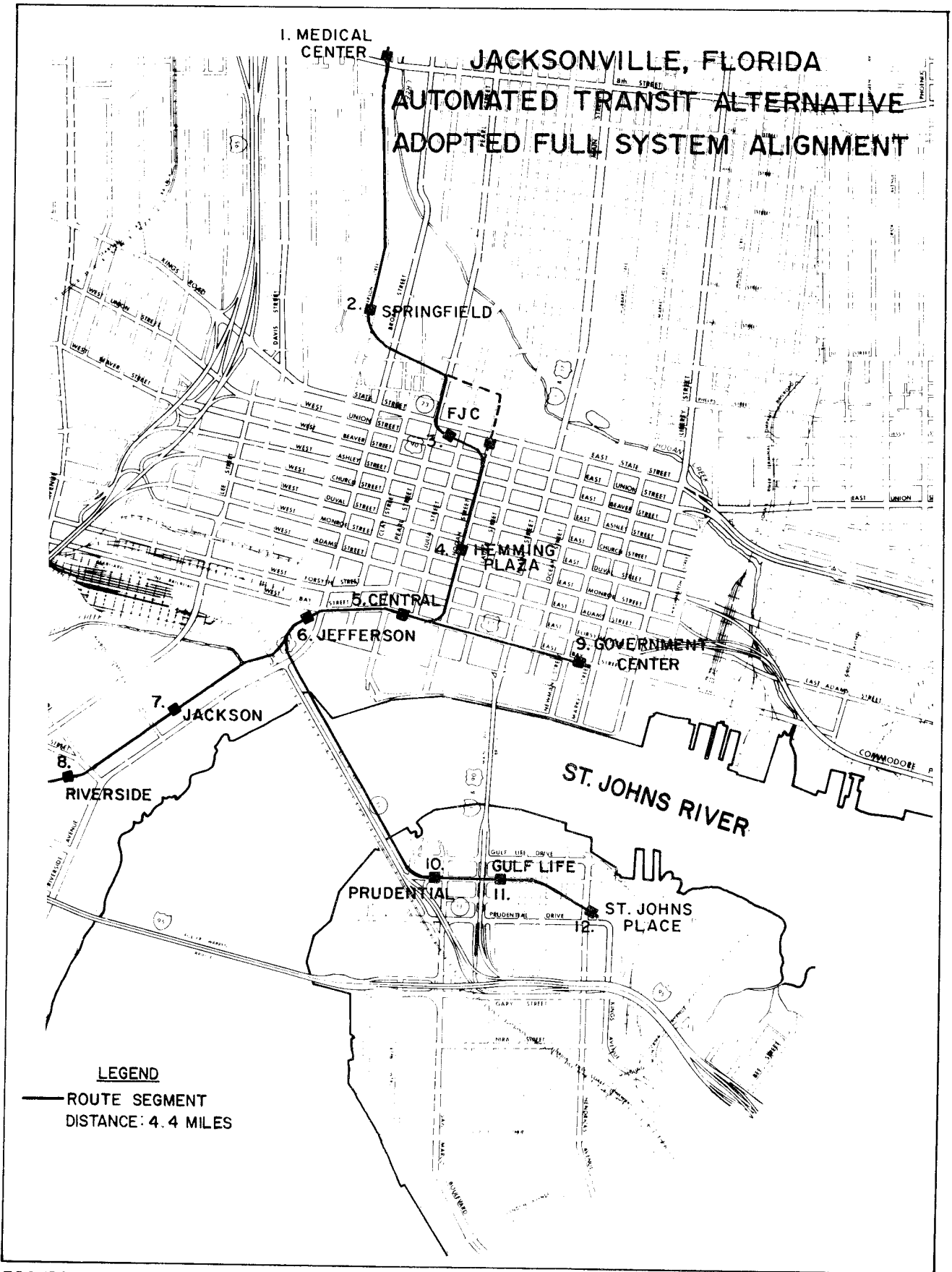

FIGURE 2-7

ADOPTED FULL SYSTEM ALIGNMENT

Johns Place development, south of Downtown, via a reconstructed Acosta Bridge across the St. Johns River, then under study by the Florida DOT (see Figure 2-8). This alternative came to be known as the River Crossing Automated Skyway Express and was the basis for the most intense professional engineering work.

Description of Alternatives

During the PE/EIS planning program, and as a part of the EIS process, four alternatives were developed and considered worthy of further evaluation in connection with meeting the mass transit needs of downtown Jacksonville. They are:

- * The No-Build Alternative
- * The River Crossing ASE Alternative
- * The Riverside ASE Alternative
- * The Bus-Only Alternative

. The No-Build Alternative

The No-Build Alternative proposes that future traffic growth in Downtown Jacksonville be accommodated by the 1985 proposed transportation system presented in the updated JUATS study.¹¹ It consists of updated and modified street networks using existing and future transportation movements in the Downtown area and surrounding origin and destination areas. The transit mode component of the No-Build Alternative maintains the current bus routes with expansion of service and fleet size. Recent cuts in bus service resulting from cuts in federal operating subsidies may have an adverse effect on this alternative. The extent of this effect is beyond the scope of this study.

Bus transit service is provided by the Jacksonville Transportation Authority. The existing fleet consists of 200 transit coaches seating from 30-53 passengers. Three major bus manufacturers are represented in this fleet. The average age of a JTA coach in 1980 is 10 years, with 87 coaches manufactured before 1970 having an average age of more than 16 years. The JTA system operates 172 rush-hour coaches holding 28 in a reserve or maintenance fleet. The No-Build Alternative proposes expansion of the fleet to 341 coaches by 1985.

The JTA bus transit system serves about 52,000 passengers per weekday (9% of the person-trips destined for Downtown³) with 1,000 - 3,000 passengers on each route. Shuttle buses, handling about 400,000 passengers per year, connect park-n-ride lots on the periphery of Downtown with major activity centers.

The No-Build Alternative is estimated to increase bus transit up to 18% of the Downtown person-trips by the implementation of transportation system improvements.⁵ Specific improvements would include the one loop street reconstruction and the Acosta Bridge reconstruction. In addition, bus route and service improvements would include three Downtown shuttle

RIVER CROSSING ASE FJC TO ST. JOHNS PLACE

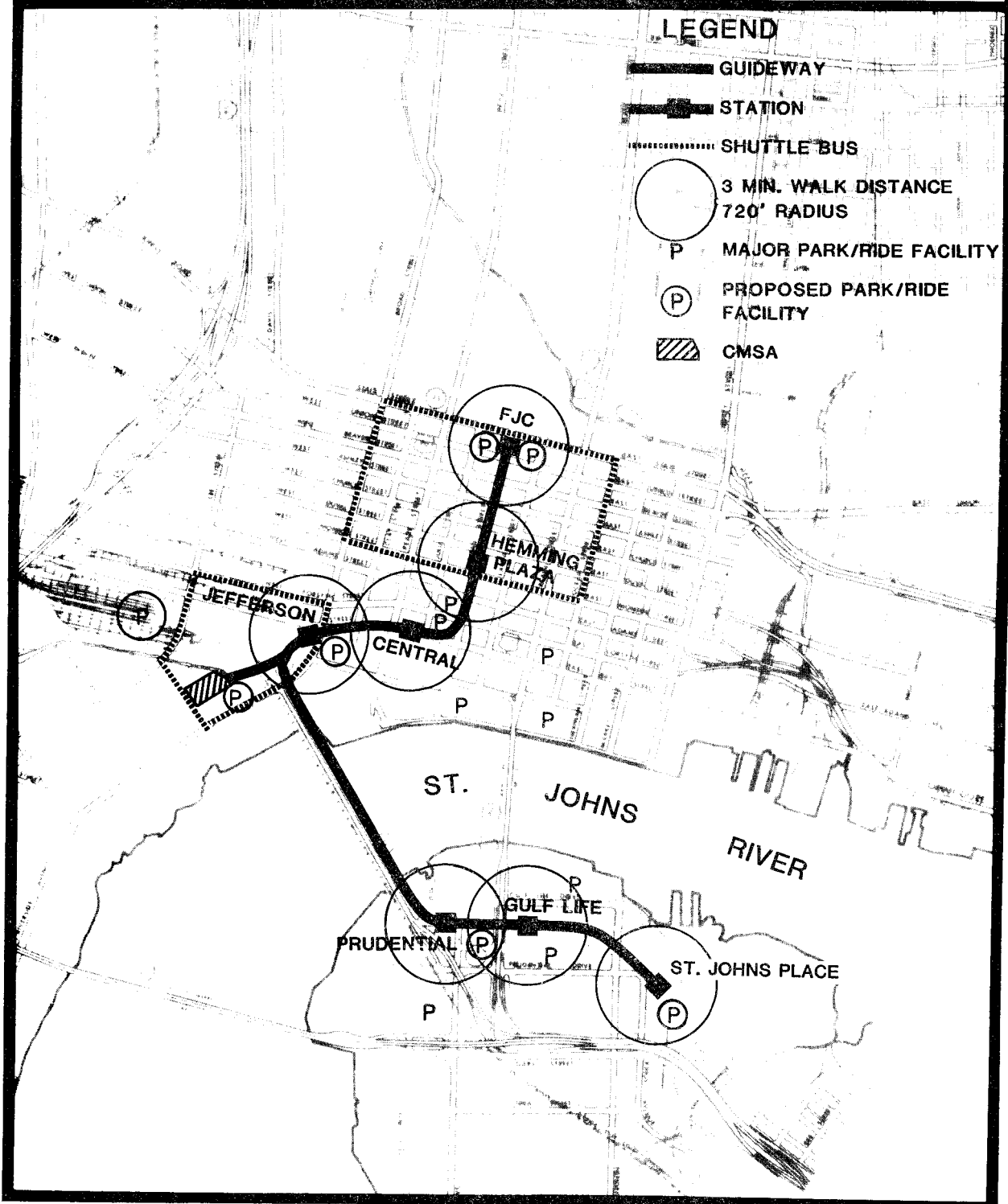

FIGURE 2-8

loops, operating to peripheral parking facilities. Route changes would also include closer headways and additional bus stops Downtown.

. The River Crossing ASE Alternative

The River Crossing Automated Skyway Express (River Crossing ASE) Alternative would be a completely automated circulation and distribution mass transit system providing fast and efficient transportation between major activity centers in Downtown Jacksonville. The system would consist of an elevated double guideway about 2.1 miles long. The geographic layout of the route is shown schematically in Figure 2-8. The system includes 7 on-line stations and can operate with driverless vehicles at 2-minute headways. The round trip travel time is expected to be about 20 minutes.

This alternative would also have bus transfer points at several stations. Nearly all of the existing regional bus routes would be re-directed to these stations in order to reduce the total trip time for JTA patrons. Through-bus patrons would use the ASE to connect with the outgoing buses. A few express flyers and the revised CBD bus shuttle system would still continue into the Downtown areas. This transfer from the regional bus system will free many buses for peak hour service within the region.

. The Riverside ASE Alternative

The Riverside Automated Skyway Express (Riverside ASE) Alternative would be similar to the River Crossing ASE and would provide fast, efficient transportation between major activity centers in the Downtown areas on the north bank of the St. Johns River. The system would consist of an elevated double guideway about 1.52 miles long, or 16,112 linear feet of guideway. The geographical layout of the route is shown schematically in Figure 2-9. The system includes 6 on-line stations, a control, maintenance, and storage area (CMSA), and 6 driverless vehicles operating on approximately a 2-minute service frequency. The round trip travel time would be about 12 minutes.

. The Bus-Only Alternative

The route of the Bus-Only Alternative is shown in Figure 2-10. The system consists of three routes, Southside, Northside, and a Central Business District (CBD) looper. The route structure, like the ASE System, reflects the trip-making desires of Downtown area residents and employees. For this reason, the bus system was designed similar to the ASE System. The route structure takes advantage of the one-way street pattern and available bridges to provide coverage over a wider area. The Acosta and Main Street bridges are utilized to provide adequate volume across the river, as are two pairs of one-way streets in the CBD. Better utilization of one-way street segments is necessary in order for the system to maintain the desired headways. Alterations to the streets would be required. In addition, several other major

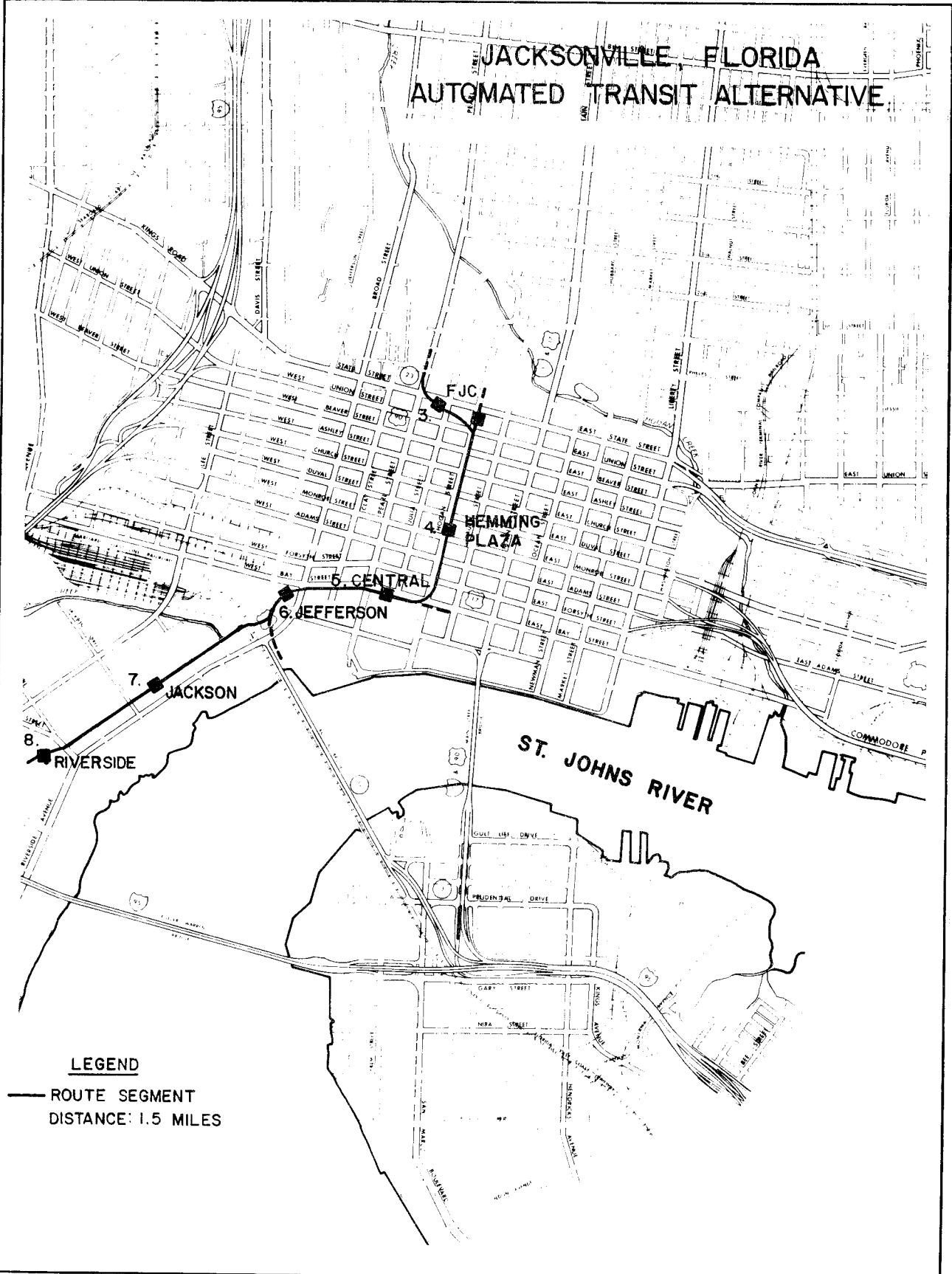

FIGURE 2-9

RIVERSIDE ASE

BUS-ONLY ALTERNATIVE

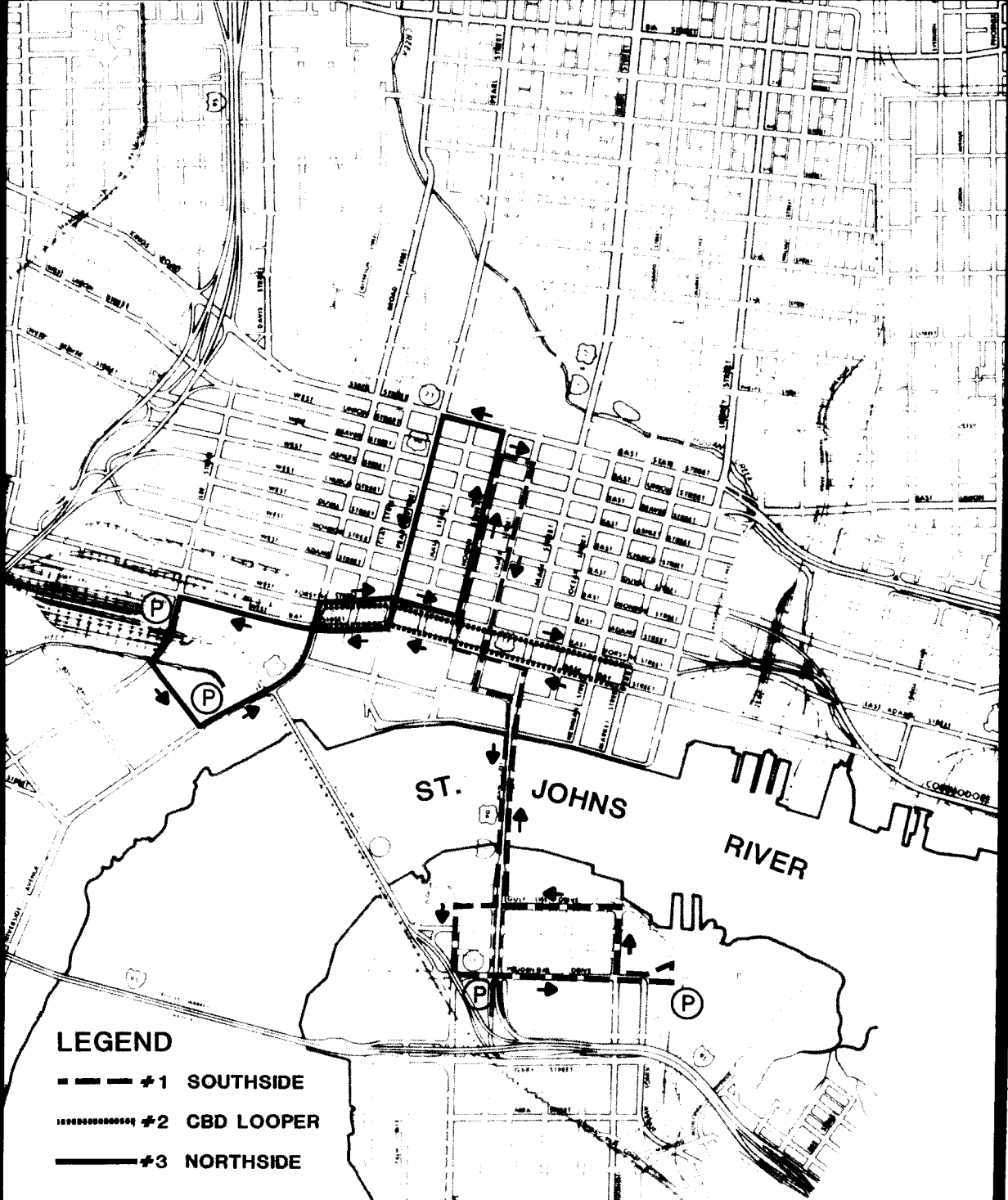

FIGURE 2-10

BUS-ONLY ALTERNATIVE

changes would have to be made to the area including: a completely new signal scheme and new equipment to implement this scheme, redesign and reconstruction of several streets into transit malls and exclusive busways, new bus shelters, and a terminal in the CBD.

The Bus-Only Alternative represents a flexible alternative to an automated guideway transit system in Downtown Jacksonville. Although there currently exists a Downtown bus shuttle system, the route structure represented by the Bus-Only Alternative has been developed based on the same goals as the ASE Systems as set forth by the Citizen's Awareness Committee of the Citizens Advisory Committee. Thus, rather than a simple extension and intensification of the current system, a new approach to Downtown mobility was used to design the Bus-Only Alternative.

Comparison of Alternatives

A comparative evaluation of the four alternatives is summarized in Tables 2-2 and 2-3. Impact issues evaluated in the tables address the various aspects of the human environment requiring consideration. The "Scoping" process identified those impact issues of greatest interest to the public as noise, preservation of historic sites, and recreational resources, air quality, traffic, displacement of people and businesses, and compatibility of the proposed action with the urban design goals for Downtown Jacksonville.

Impacts considered beneficial in evaluating the alternatives include such things as improved travel time and increased economic activity, while adverse impacts include such things as conflict with local planning and development goals and visual intrusion on property. The comments in the table attempt to quantify or summarize the qualitative nature of the impact and, where necessary, identify mitigating actions. The evaluation was done by the JTA, the Task Force, and the Environmental Subcommittee of the CAC.

Recommended Alternative

The Feasibility Study of the Jacksonville system originally identified separate phases of the Recommended System which were physically capable of being fully operational segments.⁸ The Recommended System was restudied at the beginning of the Preliminary Engineering as an iterative planning analysis. During the iteration planning process described in the preceding section, six separate, fully operational segment options were identified. These included:

- 1) Florida Junior College (FJC) Station to St. Johns Place Station
- 2) Florida Junior College (FJC) Station to Riverside Station
- 3) Government Center Station to Riverside Station
- 4) Government Center Station to St. Johns Place Station
- 5) Medical Center Station to Riverside Station
- 6) Medical Center Station to St. Johns Place Station

TABLE 2-2

ALTERNATIVES EVALUATION
OF LONG-TERM IMPACTS

	ALTERNATIVES			
	NO-BUILD	BUS-ONLY	RIVER CROSSING	AUTOMATED TRANSIT RIVERSIDE
<u>LAND USE AND URBAN DEVELOPMENT:</u>				
1. Infrastructure Systems, Facilities, and Services	0	0	0	0
2. Developmental Potential	0	0	+1	+
3. Coordination with Regional and Community Plans	-1	-	+1	+
4. Disruption or Damage to Adjacent Structures	0	0	0	0
5. Historic, Cultural, Archaeological, and Open Spaces Resources	0	0	0	0
6. Environmental Design Aesthetics	0	-	-	-
<u>SOCIOECONOMIC IMPACT:</u>				
1. Displacement of People and Businesses	0	0	0	-1
2. Station Effects on Neighborhoods	0	0	0	0
3. Effects on Special User Groups	0	0	+	+
4. Employment, Income, and Business Activity	-1	0	+1	+
5. Residential Activity	0	0	+1	+1
6. Public Safety	-1	-1	+	+
7. Effects on Property and Other Taxes	-	0	+1	+1
<u>NATURAL ENVIRONMENT:</u>				
1. Resources Consumption	0	-	-1	-1
2. Energy	-1	-1	+1	+
3. Terrestrial Ecosystems	0	0	0	0
4. Aquatic Ecosystems	0	0	0	0
5. Air Quality	-1	-1	+1	+1
6. Noise and Vibration	-1	-1	+1	+1
<u>TRANSPORTATION IMPACTS:</u>				
1. Traffic Circulation and Parking	-1	-	+1	+
2. Accessibility of Facilities, Services, and Jobs	-	0	+1	+1

Beneficial Impact:

Significant = +1
Possibly Significant = +
No Significant Impact = 0

Adverse Impact:

Significant = -1
Possibly Significant = -
No Significant Impact = 0

TABLE 2-3

ALTERNATIVES EVALUATION
OF SHORT-TERM IMPACTS

	ALTERNATIVES			
	NO-BUILD	BUS-ONLY	AUTOMATED TRANSIT	
			RIVER CROSSING	RIVERSIDE
1. Employment, Income, and Business Activity	0	+	+1	+1
2. Effects on Property and Other Taxes	0	0	-	-
3. Resources Consumption	0	-	-	-
4. Traffic Circulation and Parking	0	-1	-1	-
5. Accessibility of Facilities, Services, and Jobs	0	0	0	0
6. Air Quality	0	-	-	-
7. Noise and Vibration	0	-	-1	-1
8. Energy	0	-	-1	-
9. Public Safety	0	-	-	-
10. Disruption or Damage to Adjacent Structures and Land	0	0	0	0

SHORT-TERM IMPACTS DUE TO CONSTRUCTION:

1. Employment, Income, and Business Activity
2. Effects on Property and Other Taxes
3. Resources Consumption
4. Traffic Circulation and Parking
5. Accessibility of Facilities, Services, and Jobs
6. Air Quality
7. Noise and Vibration
8. Energy
9. Public Safety
10. Disruption or Damage to Adjacent Structures and Land

Beneficial Impact:

Significant = +1
Possibly Significant = +
No Significant Impact = 0

Adverse Impact:

Significant = -1
Possibly Significant = -
No Significant Impact = 0

Profiles of the operational characteristics, O&M costs, patronage, capital costs, and environmental considerations were prepared for each of the options listed above. These options were submitted to the same Planning Balance Sheet technique used for the selection of the Recommended System. Subcommittees of the CAC developed weights, goals, measurement criteria, and ranked the various options separately. These rankings were reconciled by the Executive Committee of the CAC. While the rankings were complex, generally the process eliminated 4 of the segment options for policy and functional reasons. Options 5 and 6 were not chosen because of the desire to keep the initial implementation segment to a magnitude which appeared to be fundable in the near future. Options 3 and 4 were not chosen because the extension to Government Center has low patronage on a truncated system and it did not serve the retail shopping core along Hogan Street. Option 1 connects the two halves of the Downtown together crossing the St. Johns River over the Acosta Bridge which is scheduled to be replaced. In the view of the CAC, the JTA Board and most local officials, the automated transit had to cross the river to meet the long-range goals of the community. It was felt this transportation link was necessary to gain the acceptance of the citizens and insure the system's feasibility. Option 2 was also retained as a desirable link and as an alternative first construction phase if the replacement of the Acosta Bridge was delayed. This was followed by the formal adoption of Option 1 FJC to St. Johns Place as the recommended action by the JTA Board at its April 1981 meeting. This option is called the River Crossing Automated Skyway Express Alternative and was the basis for the most intense PE work. A schematic representation of the adopted option is shown in Figure 2-8.

SYSTEM FEASIBILITY

Many factors were taken into consideration during studies to determine system feasibility. The discussion which follows touches on the major factors which were considered during the initial feasibility study and the later PE/EIS work effort.

Transportation and Land Use

There are three major barriers to the transportation system in Jacksonville: the St. Johns River which bisects the urban area, the railroads which run toward a major terminal Downtown, and the industrial land uses along the riverfront which are surrounded by the Downtown office and commercial activity centers. Three major bridges cross the St. Johns River, connecting the north and south halves of Downtown. Two other bridges at the eastern edge of Downtown provide access from the area north of the St. Johns River to eastern suburban residential areas and the Atlantic Coast resorts. These bridges are the major restrictions to traffic movement along the regional highway network and the Downtown roadway network. The Florida East Coast Railway maintains and frequently uses a low level bascule railroad bridge immediately adjacent to the Acosta Bridge which connects to railroad main lines north and south of the St. Johns River.

The Seaboard Coastline Railroad and the Florida East Coast Railroad had an obsolete and abandoned railroad terminal complex along Bay Street, west of Riverside Avenue. This complex and its approaches are a major barrier to the Downtown roadway network. Only three streets (Riverside Avenue, Park Street, and Myrtle Avenue) cross these railroad lines in the 1.5 miles between the St. Johns River and Beaver Street. The railroad terminal is planned to be converted to other land uses.

Industrial land uses Downtown also contribute to traffic problems by producing truck traffic on the Main Street Bridge and the section of Bay and Adams Streets which connect Main Street with Talleyrand Avenue. There are relatively few alleys and off-street loading areas Downtown; so, most goods deliveries take place from designated on-street loading zones. At present, there are many streets Downtown on which on-street loading is restricted during rush hours. It is expected that as traffic congestion Downtown increases, it may be necessary to further restrict on-street loading.

There are also structural problems. The antiquated traffic signalization equipment Downtown contributes to the congestion. The majority of Downtown streets are controlled by a traffic signalization system installed in the 1940s. This system cannot be adapted to relieve the congestion created on individual streets. Also, maintenance of the system has become difficult. Parts for this equipment are no longer available. The City must cannibalize other equipment to keep priority intersections functioning. In the last decade, steps have been taken to replace the antiquated system Downtown with interconnected traffic signalization systems. Today, Main, Pearl, and Julia Streets (running north-south) and State and Union Streets (running east-west) are the major Downtown streets having interconnected signalization equipment.

Traffic volume itself creates congestion. During rush hours (7:00 - 9:00 a.m. and 4:00-6:00 p.m.), traffic volumes on the major Downtown arterials frequently exceed roadway design capacities resulting in "stop-and-go" travel, travel time delays, and increased air pollution.¹²

The transit system contributes to the rush hour traffic congestion Downtown at locations having a large number of transfers, especially the Downtown transit hub at Hemming Plaza (see Figure 2-11). Crossing routes add significantly to traffic congestion at the intersections of Adams and Jefferson Streets, Adams and Julia Streets, and Forsyth and Ocean Streets. The highest bus volumes during the evening rush hour are generated on Laura Street near Hemming Plaza, Forsyth and Ocean Streets, and the Main Street Bridge.

As part of the Downtown traffic analysis conducted by the Downtown Development Authority, a capacity analysis was made of all Downtown streets to verify these traffic congestion problems.³ The results of the analysis are presented in Table 2-4. Those roadway segments with a volume to capacity ratio greater than 1.00, experience traffic volumes in excess of the Level-of-Service C design standards. Capacity deficiencies occur in the Southwest, South, and North travel corridors,

JACKSONVILLE, FLORIDA

BUS ROUTES

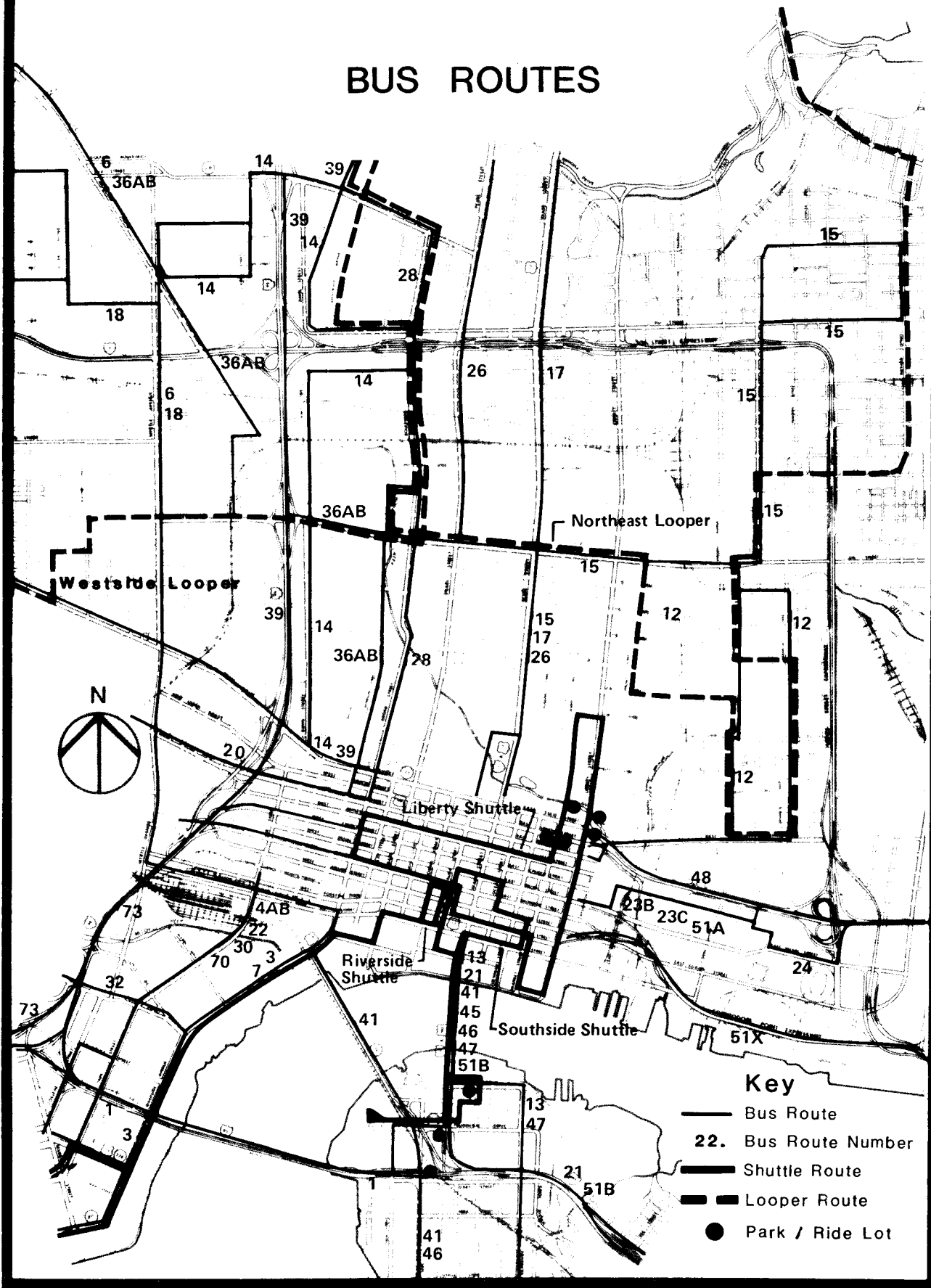

FIGURE 2-11

TABLE 2-4

1975 TRAFFIC VOLUME AND CAPACITY¹

<u>Travel Corridor</u>	<u>Traffic Volume</u>	<u>Existing Capacity</u>	<u>V/C</u>	<u>Travel Corridor</u>	<u>Traffic Volume</u>	<u>Existing Capacity</u>	<u>V/C</u>
North Corridor (North of State Street)				Southwest Corridor (South of I-95)			
I-95	83,700	75,000	1.12	Riverside Avenue	15,000	12,500	1.20
Broad Street	5,000	6,500	0.77	Park Street	9,800	10,500	0.93
Pearl Street	6,800	7,000	0.97	College Street	6,500	8,000	0.81
Laura Street	4,000	9,000	0.44	I-10	96,500	75,000	1.29
Main Street	14,600	17,000	0.86	Forest Avenue	9,000	12,000	0.75
Hubbard Street	4,500	6,500	0.69		<u>136,800</u>	<u>118,000</u>	<u>1.16</u>
Liberty Street	4,000	6,500	0.61				
	<u>122,600</u>	<u>127,500</u>	<u>0.96</u>	West Corridor (West of I-95)			
East Corridor (East of Washington Street)				Myrtle Avenue	9,800	12,500	0.78
U.S. Alt. 90	27,900	30,000	0.93	Church Street	1,500	7,000	0.21
Duval Street	3,000	12,000	0.25	Beaver Street (U.S. 90)	14,400	17,000	0.85
Adams Street	4,900	15,000	0.33	Kings Road (U.S. 1)	12,800	17,000	0.75
Bay Street	8,800	10,000	0.88		<u>38,500</u>	<u>53,500</u>	<u>0.72</u>
Commodore Pt. Xway	7,800	25,000	0.31	Bridges:			
	<u>52,500</u>	<u>92,000</u>	<u>0.57</u>	Fuller Warren (I-95)	54,000	50,000	1.08
South Corridor (South of Gary Street)				Acosta (S.R. 13)	27,000	30,000	0.90
I-95	87,200	72,500	1.16	Main Street (U.S. 1 & 90)	41,400	40,000	1.04
Kings Avenue	8,700	10,000	0.87	I.D. Hart	24,100	50,000	0.48
Hendricks Avenue	11,600	12,500	0.93	J.E. Mathews (Alt. 1 & 90)	44,900	40,000	1.12
San Marco Blvd.	16,900	15,000	1.13		<u>191,400</u>	<u>210,000</u>	<u>0.91</u>
	<u>124,400</u>	<u>110,000</u>	<u>1.13</u>				

¹ Level of Service C

SOURCE: Downtown Jacksonville: A Transportation & Redevelopment Strategy, Downtown Development Authority

principally on the regional highway network and its local access roads. Generally, Downtown arterials maintain an appropriate level of service during the day. However, traffic congestion does occur during operation of the toll and lift bridges (I-95, Acosta, and Main Street Bridges) and the active railroad crossing as well as the morning and evening "rush". The major transportation problems created by the combination of traffic volumes, physical barriers, and structural deficiencies of the transportation system were identified by the capacity analysis as:

- * Exceeded capacity on I-95 and I-10. The most extreme congestion occurring on the northwest boundary of Downtown and at the I-95/I-10 interchange.
- * Exceeded capacity on Riverside Avenue between the northern approach to the Acosta Bridge and I-95.
- * Exceeded capacity on Main Street and Fuller Warren Bridges.
- * Restricted access at both ends of the Acosta Bridge.

Presently, I-95 and I-10 are under construction to alleviate traffic congestion and improve safety at their junction in the Downtown area.

Downtown Jacksonville uses the curb lanes of its streets for on-street parking and loading zones. The value of these curb lanes to provide additional traffic volume stimulated an evaluation of Downtown parking needs.³ This evaluation indicated that all of the curb parking would have to be eliminated to meet traffic needs by 1990. However, parking needs in the growing Downtown area are such that these spaces and additional ones would have to be provided by off-street parking. It is also likely that off-street loading facilities will be required.

The need for Downtown parking spaces is expected to grow to 44,000 in 1990.³ The demand will be generated by long-term parking needs for the new development planned for Downtown as well as additional work force parking, while maintaining accessible short-term parking to serve the needs of Downtown retail and commercial centers. Some of this demand can be accommodated by new development projects Downtown. However, the plans of the Downtown Development Authority also include the diversion of most work force parking to locations along the fringes of Downtown and connecting them to the major activity centers with the transit system.⁵ Downtown demand will be 20,000 new off-street parking spaces by 1990.

Ridership

During the Feasibility Study, the year 1985 was selected as the base year (earliest year of expected full system operation) for revenue estimates. Ridership projections indicate that if the River Crossing ASE is fully operational in 1985, it would carry about 8,000,000 persons annually. The average weekday ridership would be 26,818 as shown in Table 2-5. Of this daily ridership, about 43% would be free transfers

from the regional transit system. The revenue passengers would be about 4.6 million per year.

TABLE 2-5
RIVER CROSSING ASE
1985 AND 1995 WEEKDAY PATRONAGE BY TYPE

<u>YEAR</u>	<u>TRANSIT TRIP</u>	<u>PARK-N-RIDE AUTO CONVERSIONS</u>	<u>CIRCULATION TRIP</u>	<u>TOTAL</u>
1985	11,537	5,261	10,020	26,818
1995	16,032	7,288	19,152	42,472

The ridership estimates show an increase in average weekday patronage by 1995 of 58.3% or 42,472 person-trips with circulation trips providing the largest increase within the CBD. Therefore, the revenue patronage would increase 73% to 7,900,000 annually.

The station loadings for the system were also estimated and are shown in Table 2-6. The link between the Jefferson and Prudential Stations, which is the St. Johns River crossing, is the heaviest with nearly 4,000 in 1995. The most heavily used station is Prudential with over 15,000 persons a day. These volumes were also used in the basis for station design.

TABLE 2-6
RIVER CROSSING ASE
FLORIDA JUNIOR COLLEGE STATION TO
ST. JOHNS PLACE STATION

<u>Station</u>	<u>PM PEAK</u>	<u>NOON PEAK</u>	<u>DAILY TOTAL</u>	<u>1985-95</u>
	<u>1985 - 1995</u>	<u>1985 - 1995</u>	<u>1985 - 1995</u>	<u>%</u>
FJC	1348 - 1810	1309 - 1423	10,893 - 12,975	19.1
Hemming Plaza	1321 - 1464	984 - 1135	9,193 - 10,383	12.9
Central	1002 - 1978	543 - 834	6,143 - 10,848	76.7
Jefferson	501 - 703	557 - 1003	4,213 - 6,957	65.1
Prudential	444 - 1232	923 - 2720	5,445 - 15,583	186.2
Gulf Life	827 - 1113	1034 - 2624	7,523 - 15,207	102.1
St. Johns Pl.	2057 - 2554	568 - 779	10,147 - 12,992	28.1
Totals			53,647 - 84,945	58.3

Environmental and Economics

The feasibility and environmental impact studies for the ASE have shown a net positive impact on the Downtown area and fewer environmental impacts than any of the other alternatives considered. Following is a summary of these effects.

Operation of the River Crossing ASE would produce long-term beneficial effects including:

- * The design of ASE structures, especially along Hogan Street and at the Hemming Plaza Station, would enhance the visual characteristics and pedestrian use of the Downtown area. In addition, the stations and guideway would make available unique views of the Downtown area to the ASE patron.
- * Operation of the River Crossing ASE would induce secondary development worth \$102 million, representing 5,600 additional jobs in the Downtown area by 1995, and a growth in annual income of \$53 million.
- * Operation of the River Crossing ASE would induce additional growth in annual retail sales in the Downtown area equivalent to \$32 million in 1995.
- * The River Crossing ASE would provide access between major hotel and convention centers, the commercial district, and the Florida Junior College Downtown Campus for a total service area employment population of 61,000. About 26,818 person-trips are expected daily by 1985.
- * The 1985 revenue ridership is estimated at 4.4 million annually. At a fare level of \$0.25/ride, this ridership can pay annual operating and maintenance costs.
- * The decrease in travel time possible using the ASE System would allow the elderly and handicapped to significantly expand their mobility and employment access area. In 1970, the Downtown area was estimated to have 3,837 transit-dependent persons.
- * Recent planning efforts by the Downtown Development Authority have identified the River Crossing ASE as a stimulus to residential development plans for the CBD and Southside.
- * The River Crossing ASE is considered by local transportation plans as the necessary central component of any improved system of regional transportation.

Operation of the River Crossing ASE would result in long-term adverse effects, including:

- * There would be displacement of approximately 20 employees and 5 businesses. About 3 acres of private land would be transferred into the public domain.
- * The CMSA would discharge small amounts of sanitary effluent and wastewater containing wash solvents, mud, grease, oil, and gasoline.
- * The guideway, piers, and skywalk system and stations would intrude into some views of CBD structures.

- * The intermodal stations would induce traffic congestion and increase bus activity at their locations.
- * Unless properly located, columns adjacent to street intersections may be a distraction to motorists' sight.

The River Crossing ASE would utilize existing street right-of-way for most of the elevated guideway structure. Private property would be acquired at some stations. These would be irretrievable commitments over the useful life of the facilities, about 50 years.⁷ With respect to land presently used for auto, truck, and bus travel, the ASE would take 2,370 lane feet out of its present use. Stations would take about 3 acres. This taking represents 0.2% of the total land area within Downtown Jacksonville (2 square miles). This would not be a significant long-term commitment of Downtown land.

In addition to this commitment of land to exclusive use by ASE facilities, economic studies of the joint development potential of the ASE System have indicated that the goal of the City to encourage 100% development of Downtown Jacksonville can be furthered by the ASE System. Specifically, the River Crossing ASE has been estimated to have joint development potential for about 2.92 million square feet of office and retail space. The total value of this new construction would be about \$311 million.

Financial and Costs

The capital cost for the River Crossing ASE was estimated at \$62.2 million (1982 constant dollars). The capital costs represent the total cost for procurement and construction of 11,010 feet of elevated double guideway, 7 stations, the Control Maintenance and Storage Area, and 10 vehicles. A breakdown of these costs is shown in Table 2-7.

An estimate of the probable operating and maintenance cost of \$1.09 million (in 1982 dollars) has been made for the River Crossing ASE and is shown in Table 2-8. The operating and maintenance (O&M) costs represents the total anticipated annual operating expenses for the first year of system operation. The only items not included in this estimate are spare parts replacement from initial inventory.

The anticipated revenue producing ridership is expected to generate revenue in excess of the O&M costs.

AGT TECHNOLOGY SELECTION

A range of vehicle capabilities, called a baseline system, was developed to describe the ASE vehicle for Jacksonville. This range of capabilities was determined by review of the characteristics of vehicles presently in revenue service or available from vehicle manufacturers. Therefore, several manufacturers, by modifying their existing production vehicles,

TABLE 2-7
 CAPITAL COST BREAKDOWN
 RIVER CROSSING ASE
 (1982 Dollars x 1,000)

<u>CATEGORY DESCRIPTION</u>	<u>COSTS</u>	
<u>System Requirements</u>		
Maintenance and Guideway Equipment	\$ 4,164	
Vehicles (10)	8,663	
Command and Communications	7,458	
Power	<u>2,693</u>	\$22,978
 <u>Facilities</u>		
Stations (7)	\$ 7,020	
Guideway Structures	14,062	
CMSA	<u>366</u>	\$21,448
 <u>Site Acquisition</u>		
Land Costs	\$ 2,686	
Acquisition Costs	339	
Relocations	<u>40</u>	\$ 3,065
 <u>Design and Management</u>		
Engineering Design and Management	\$ 4,280	
Construction Management	1,903	
JTA Staff Costs	1,311	
Startup and Assurance	<u>2,500</u>	\$ 9,994
 <u>Total Construction</u>		 \$57,485
Contingency		<u>4,749</u>
 <u>PROJECT COSTS</u>		 \$62,234

TABLE 2-8
 JACKSONVILLE ASE
 1985 O&M COSTS
 (1982 Dollars)

<u>CATEGORY DESCRIPTION</u>	<u>COSTS</u>
<u>Personnel</u>	
Administration	\$ 42,480
Operations	39,520
Maintenance	208,040
Overhead	116,016
Sub-total	<u>\$ 406,056</u>
 <u>Energy</u>	
Sub-total	\$ 220,200
 <u>Parts/Supplies/Materials</u>	
Vehicles	\$ 64,700
Guideway	82,000
C&C/Power	73,800
Station	8,400
Sub-total	<u>\$ 228,900</u>
 <u>Contract Services</u>	
Stations	\$ 97,000
Maintenance Facility	20,000
Sub-total	<u>\$ 117,000</u>
 <u>Liability</u>	
Sub-total	<u><u>\$ 114,250</u></u>
 TOTAL O&M COSTS	 \$1,086,406
OR USE	\$1,086,400

could bid competitively on the construction and delivery of the Jacksonville ASE vehicles and control system.

The baseline ASE vehicle developed by the JTA staff and the public involvement program is bottom-supported, electrically-operated, driverless, and capable of transporting a normal load of 90 passengers with 20% seating. The vehicle can be crush-loaded to about 120 passengers during peak operating periods. The vehicle would have doors on both sides. The acceleration and normal deceleration rates would be 2 mphps. The vehicle would be able to attain a maximum speed of 30 mph as a single car, but will be capable of operating as a 2-car train.¹³

Candidate Systems

The AGT industry has been constantly changing since the last report on technology was prepared for this project in August 1979. Since that time, several manufacturers have, for all intents and purposes, left the industry. Others have made more sales and improved their position and there have been new entries as well.

As of June 1982, we have been able to identify three American firms which might provide equipment for the Jacksonville ASE System. There are five foreign suppliers. These suppliers are as follows:

- . Westinghouse
- . CTS/Disney
- . UTDC
- . Engins Matra
- . Niigata
- . Fuji
- . Kawasaki

Other American systems have been deployed in the past but none of these were available at this time.

Detailed descriptions of each supplier's systems which could be considered for Jacksonville follow.

. Westinghouse

Westinghouse uses a large 40-foot vehicle supported from below by two rubber-tired bogies as shown in Figure 2-12. Guide tires under each bogie ride on a guidebeam centered under the vehicle. The cars are designed to be operated individually or in trains.

The Westinghouse systems have been used mainly in airport installations. Two of these are in underground, climate-controlled tunnels; however, in other installations they have been exposed to the elements.

At Miami Airport and Tampa Airport, where the climate is similar to that at Jacksonville Airport, the system runs outdoors exposed to the weather. The Miami Airport system has been in operation 24 hours per



FIGURE 2-12

WESTINGHOUSE VEHICLE AND GUIDEWAY - BUSCH GARDENS

day since it was inaugurated in 1980. The Tampa system also has been operating 24 hours per day since its installation in 1971.

. CTS/Disney

The Disney Monorail is a beam-straddling, bottom-supported train which runs on a very narrow guidebeam. Unlike some other transit systems, it uses the same beam for both support and guidance. Each 6-car train has 12 load tires in the center for support, while side tires in the vehicle skirt provide lateral support and balance for the main load-bearing tires.

Two rails at the lower edge of the guidebeam supply power for the dc electric motors.

The Disney monorail suffers from the switching problems inherent in a monorail design. Because the vehicle straddles both sides of the guidebeam, it is necessary to move the entire beam in order to switch tracks. Disney has recently developed a new switch which replaces a segment of the beam instead of pivoting as had been done by earlier designs. Time to cycle lock-to-lock is 30 seconds. A picture of the vehicle presently used at Disney World, which would have to be modified to meet ASE criteria, is shown in Figure 2-13.

. UTDC

The UTDC Intermediate Capacity Transit System (ICTS) is a steel-wheeled, steel-rail, bottom-supported AGT System which resembles a light rail system, except it is powered by a linear induction motor (LIM). The vehicles are approximately the same size as those of Westinghouse: 40 feet long. They run on standard railroad track using flanged railroad wheels for guidance as shown in Figure 2-14.

The propulsion system is what sets the UTDC System apart from other rail systems. Because it has a LIM, it does not depend on adhesion between the wheel and rail for propulsion and, thus, may be capable of running in conditions that would stop a conventionally powered vehicle. It is different from other AGT Systems because it uses guidance and support technology borrowed from railroad engineering.

The guideway is approximately the same as for conventional light rail transit. UTDC has put extensive work into wheel/rail noise and, through the use of resilient wheels, steerable trucks, and other innovations, claims to have reduced the noise of the system to the low levels of other rubber-tired systems.

. Engins Matra (Otis)

The VAL System in Lille, France is an AGT System with medium-sized, narrow vehicles. It has been operating over the first 2 miles of line through 4 stations since March 1982. When complete, the Lille System

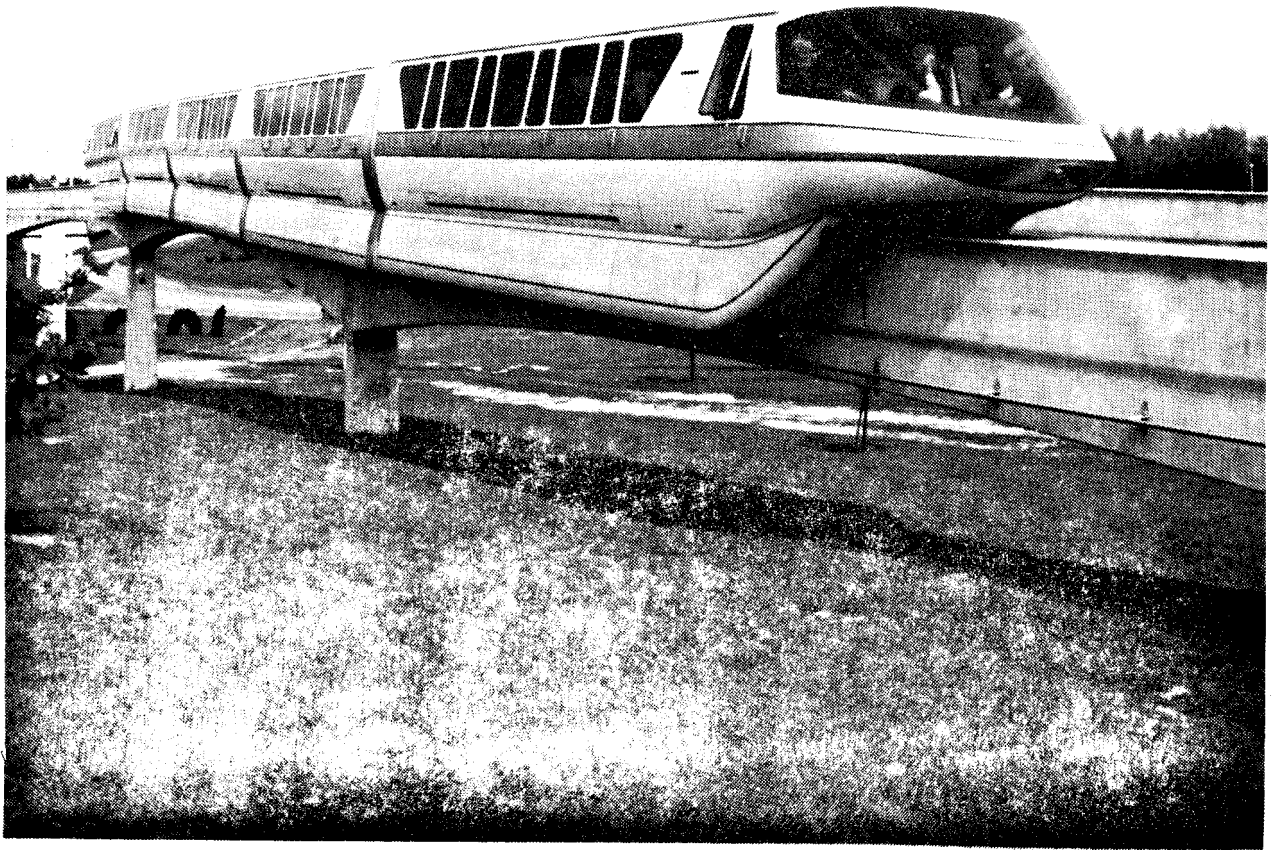

FIGURE 2-13

DISNEY MARK IV VEHICLE AND GUIDEWAY - WALT DISNEY WORLD

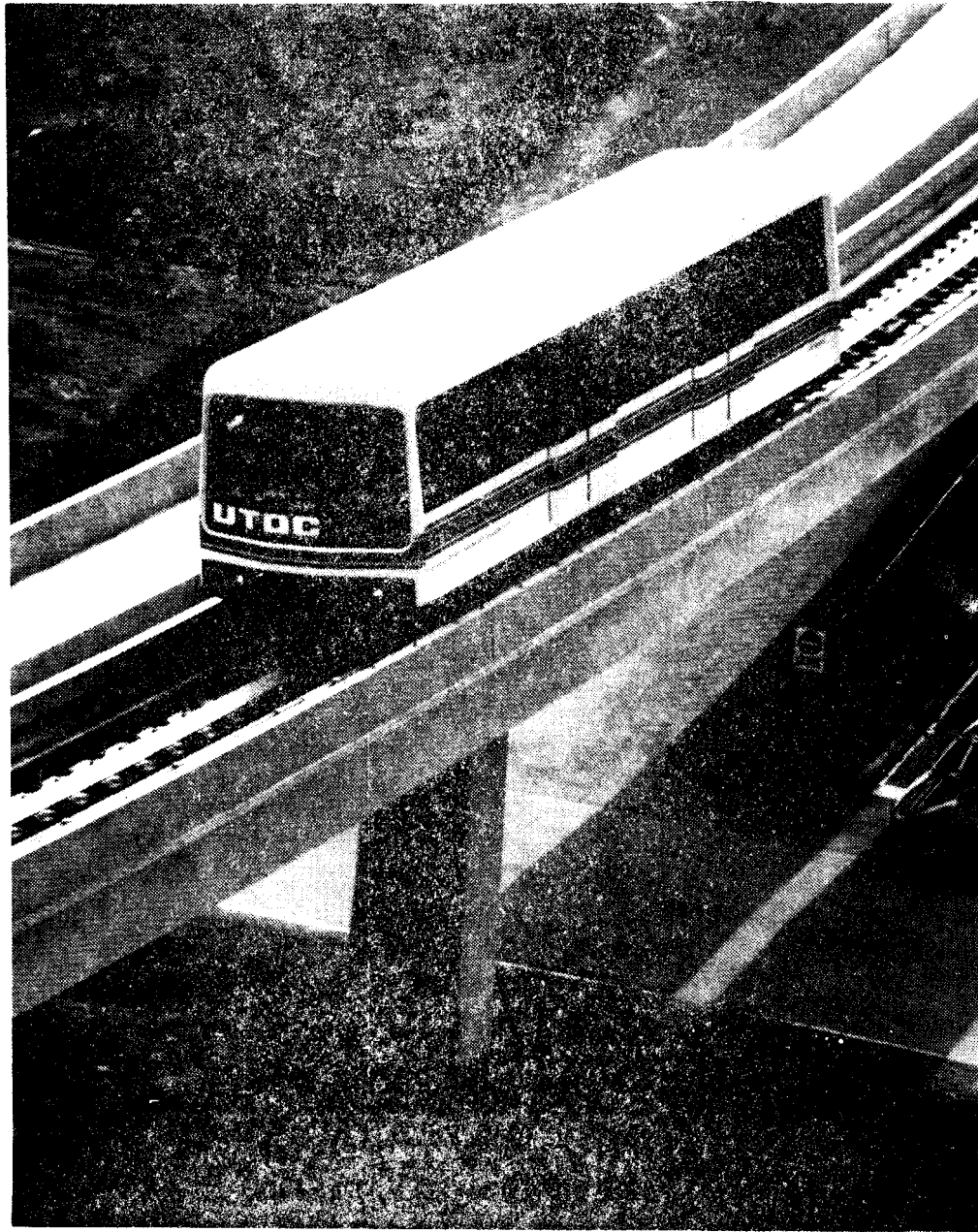

FIGURE 2-14 UTDC VEHICLE AND GUIDEWAY - KINGSTON TEST TRACK

will include 8 miles of double-lane guideway in tunnels, at grade, and will be elevated.

The system has been under development since 1971. A test track was built and two prototype vehicles were tested through 1975. In 1977 construction began on the system in Lille. Line 1 is expected to be complete in 1983.

The vehicle is a rubber-tired, bi-directional married-pair composed of a control unit and a chopper propulsion unit as shown in Figure 2-15. Cars are semi-permanently coupled with a drawbar.

. Niigata, Japan

Niigata obtained a license for Vought's Airtrans technology in 1973. By 1974, they had completed a test track and were running tests on components and systems resulting in commercial demonstration of the technology in 1975.

The system was selected for Nanko Port Island in 1977. Construction was completed in 1981 and operations began in March that year. The line is 4.3 miles long, running between the Osaka subway and a man-made island in the port, serving 40,000 passengers a day with a fleet of 15 4-car trains. The Niigata vehicle is medium-sized, rubber-tired, and designed to run as single cars or coupled into trains of up to six cars (see Figure 2-16). The vehicles run on an elevated U-shaped concrete guideway made of reinforced concrete. Sidewalls are used for vehicle guidance in concert with guidewheels mounted on the cars which act on the vehicle steering mechanism.

. Fuji, Japan

The Fuji Advanced System of Transportation (FAST) System was originally conceived in the U.S. by Bendix-Dashaveyor. The present system has been significantly improved through development and testing which began in 1975. Specific improvements were made in guidance and train control systems.

The vehicles are bottom-supported, riding on four foam-filled rubber tires on two axles per car as shown in Figure 2-17. Fuji will deliver them in three different sizes with one or two motors per car. They can be coupled into trains. The guideway is U-shaped with a flat deck running surface and side walls for guidance.

. Kawasaki, Japan

The Kawasaki system uses rubber-tired vehicles, guided between steel running rails on either side of the vehicle. It is designed for automatic control but initial operations in Kobe will have an attendant on board each vehicle.

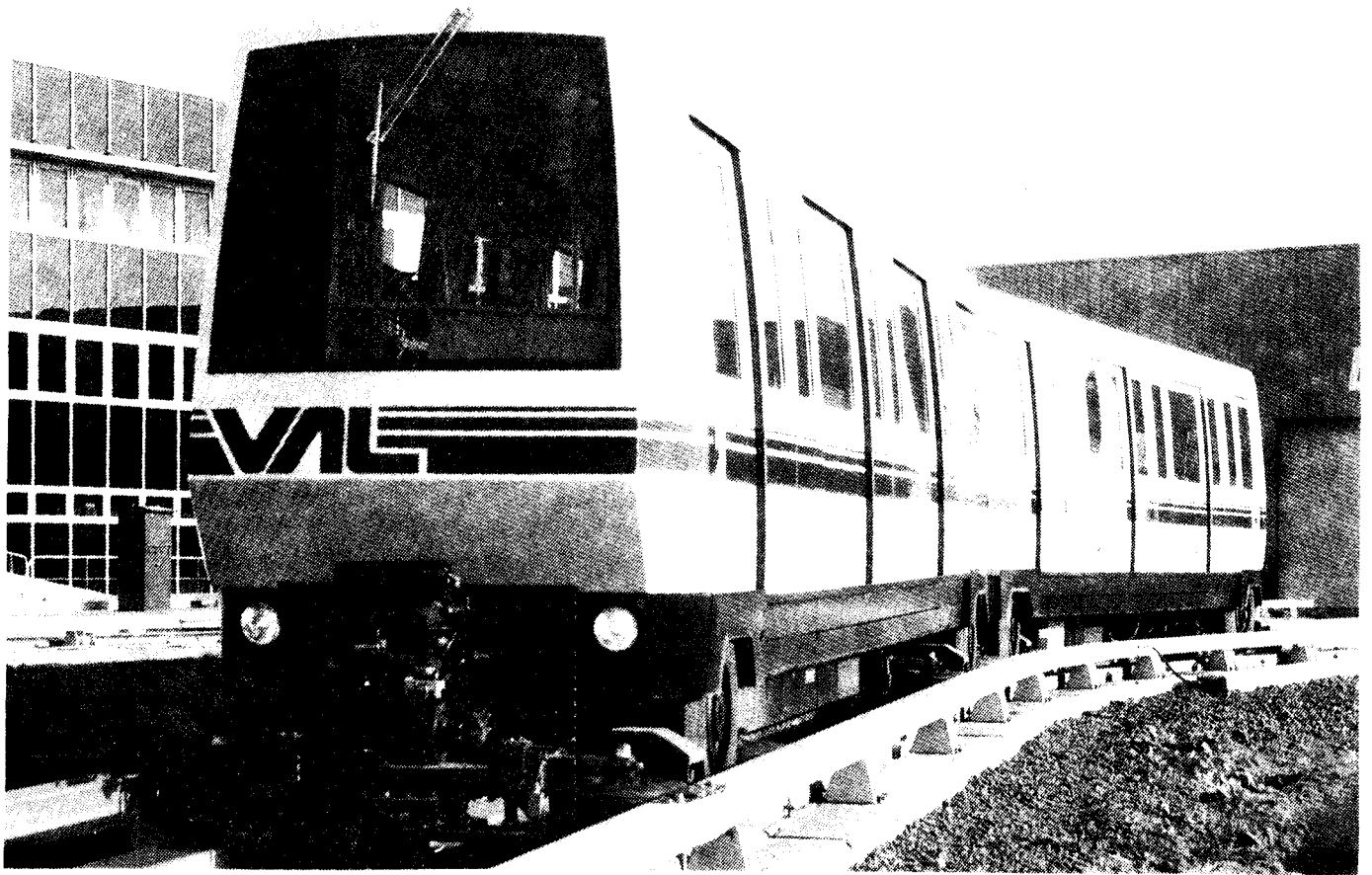

FIGURE 2-15

MATRA-VAL VEHICLE AND GUIDEWAY - LILLE

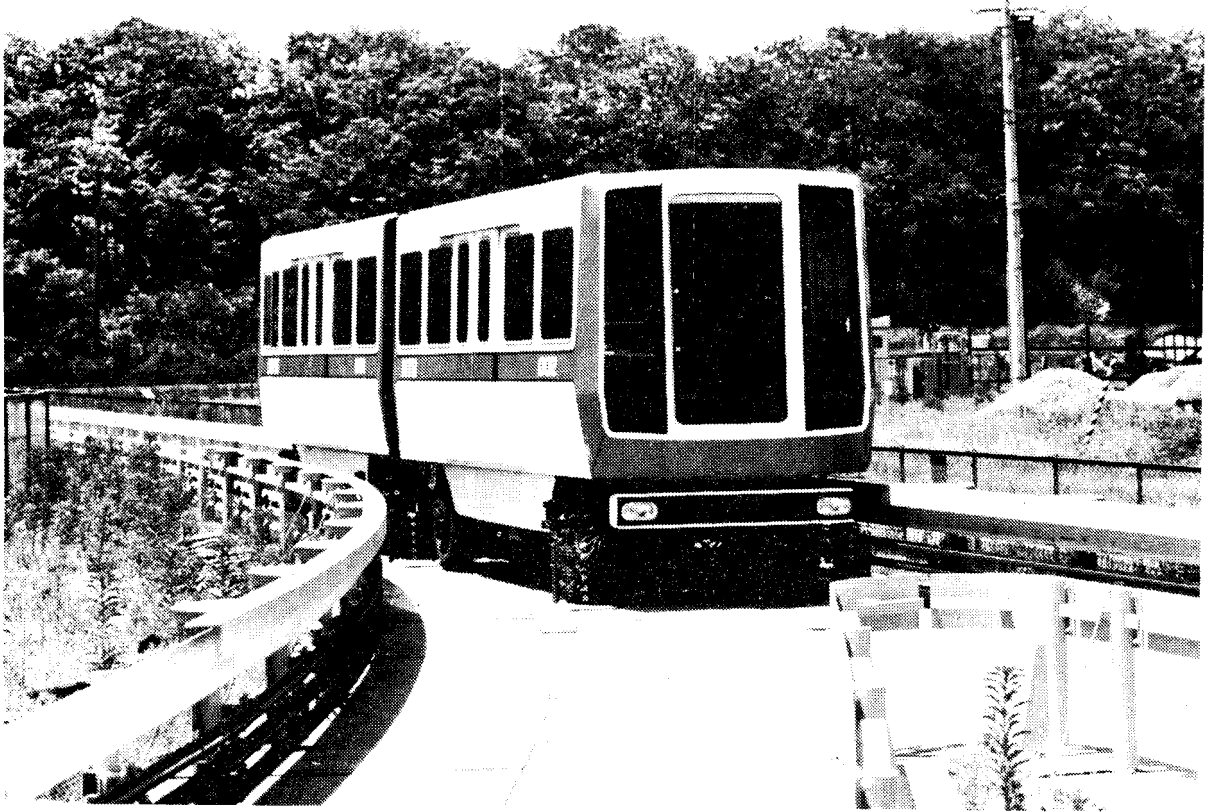

FIGURE 2-16

NIIGATA VEHICLE AND GUIDEWAY - TEST TRACK

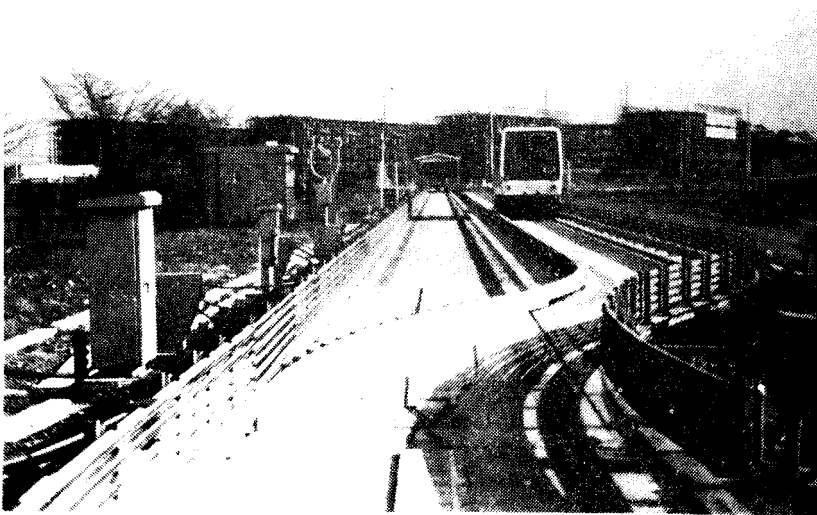
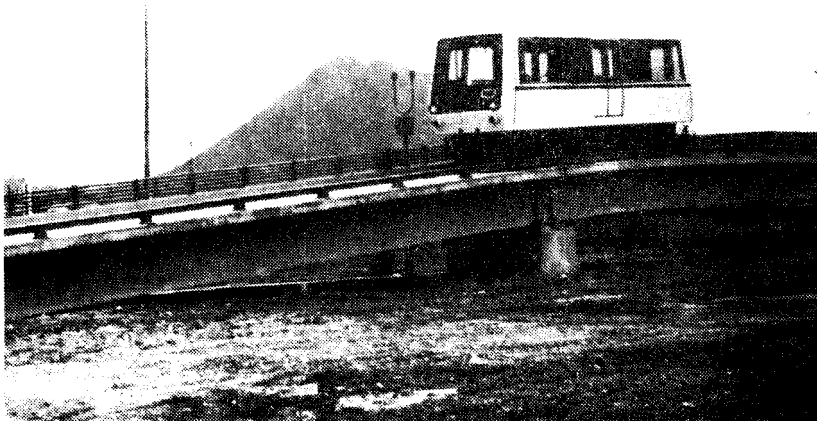

FIGURE 2-17 FUJI VEHICLE AND GUIDEWAY - TEST TRACK

The vehicles are designed to operate singly or in trains of up to 6 cars. They are constructed of aluminum alloy with fiberglass interior paneling. Typical vehicles are shown in Figure 2-18. The guideway consists of two running pads made of concrete surfaced with a layer of epoxy resin. Steel guide rails on either side of the vehicle provide guidance. Switches are straight or curved guide rails which rise from the guideway surface to capture the vehicle and turn it.

Reference System Criteria

To perform preliminary engineering for the ASE System, two types of system information were developed. First, system requirements were generated to reflect site specific needs and assure that the transit system accurately met local objectives. These requirements represent the minimum performance capability which must be met by a potential supplier and served as the basis for development of the system specification.

To proceed with preliminary engineering, such minimum requirements were not in themselves sufficient. To provide design information needed by architects and civil engineers, it was necessary to assume a "baseline" system typical of the type of equipment which might be bid. The baseline system represents typical design characteristics as opposed to minimum or extreme limits set down by the system requirements. The baseline characteristics were used to perform system cost estimates, calculate travel times and energy consumption, design guideways, stations, and maintenance facilities, and size and locate substations.

Some of the more important system requirements are given below, followed in Table 2-9 by the baseline characteristics utilized in preliminary engineering.

. System Operation

The ASE System consists of automatic driverless vehicles which must operate bidirectionally in either a scheduled or demand mode.

. Operation in Trains

The ability to operate in trains is required but each vehicle is to be fully independent and capable of operating as a single unit. No married pairs or permanently coupled units are allowed.

. Switching

Switching capability is required for access to the maintenance area. Switching may also be required for revenue operation at terminals and for degraded operation depending upon the configuration implemented by a particular supplier.

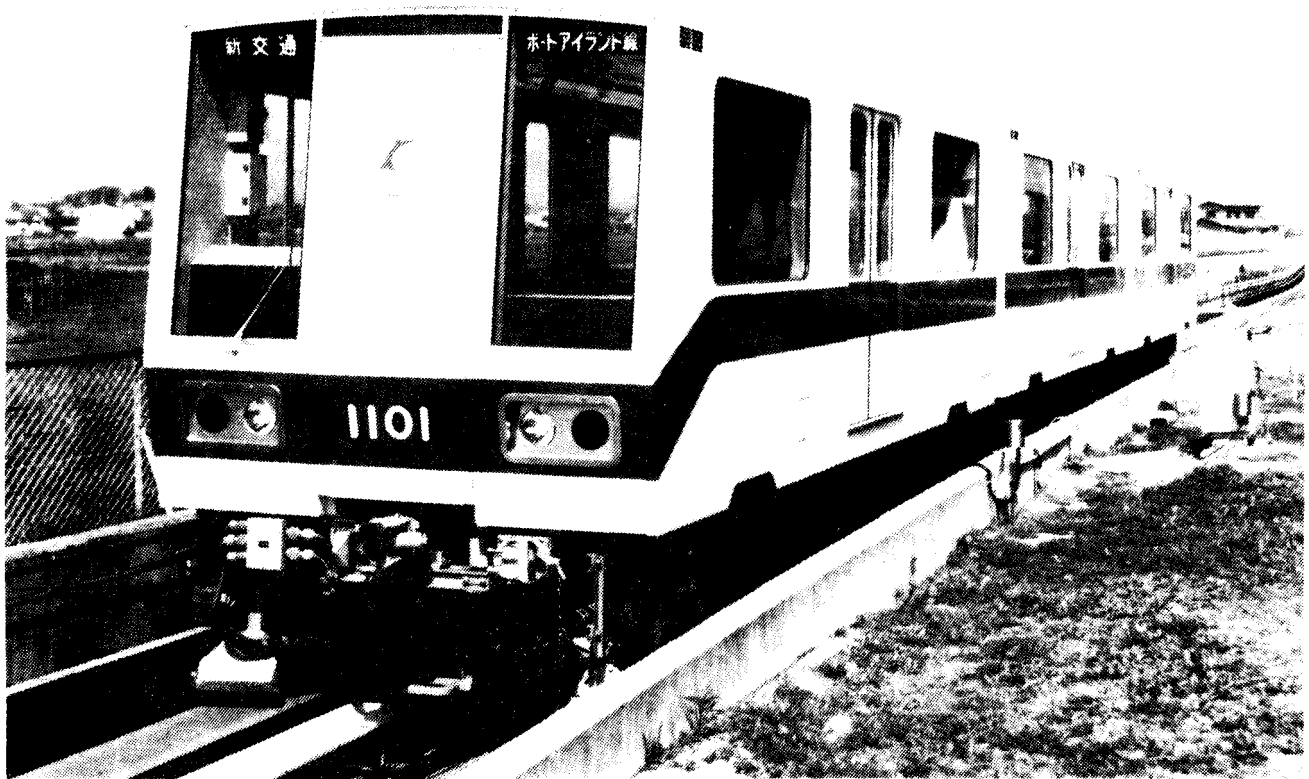

FIGURE 2-18

KAWASAKI VEHICLE AND GUIDEWAY - KOBE PORT ISLAND

TABLE 2-9
BASELINE CHARACTERISTICS

<u>ITEM</u>	<u>VEHICLE CHARACTERISTICS</u>
Type:	Bottom-Supported
Length:	
1-Car Consist	42.0'
2-Car Consist (maximum)	84.0'
Width:	9.33'
Height Above Rolling Surface:	11.1'
Floor Height Above Rolling Surface:	3.5'
Vehicle Weight:	
Empty	27,500#
Normal Load	44,000#
Crush Load	55,700#
Minimum Distance Between Axles:	
Single Vehicle	20.0'
2-Car Consist	15.0'
Minimum Overhang Beyond Axles:	9.5'
Distance Between Centerlines of Main Line Guideways:	12.8'
Distance Between Extreme Edges of Doors for 2-Car Consist:	74.0'
Single Guideway Width:	
Distance Between Lateral Guidance Surface	10.0'
Distance Between Outboard Edges of Tires	8.7'
Maximum Alignment Design Speed	30 mph
Acceleration (Normal Operations):	2 mphps
Deceleration (Normal Braking):	2 mphps
Maximum Grade	
Main Line	8%
Yard Leads	8%
Minimum Main Line Turning Radius	250.0'
Normal Capacity, Single Vehicle:	90 passengers
Crush Capacity, Single Vehicle:	120 passengers

. Level of Service

Level of service requirements are to be as follows:

- * Waiting Time (maximum during peak periods): 2 minutes
- * Station Dwell Time: 12-second nominal, 5-60 seconds range
- * Travel Time: 6.9 minutes, terminal to terminal
- * Transfer: no transfers are to be required

. Line Capacity

A line capacity of 2,100 pphpd is required for the initial segment. However, station platforms will be 100 feet long to accommodate at least two cars and double the line capacity.

. Maximum Speed

A vehicle maximum speed of at least 30 mph is required.

. Availability

System availability is to be at least 99% after one year of operation. A degraded mode must be available so that operation can be maintained if a vehicle fails anywhere along the route.

. Coupling

Automatic mechanical coupling and uncoupling of cars is required. Electrical, pneumatic, and hydraulic connections may be made and broken manually.

. Loading Time

It must be possible to unload a vehicle loaded to its design capacity within 20 seconds using doors on one side of the car only.

. Emergency Evacuation

It must be possible to evacuate passengers at all points in the system. Walkways, egress onto the guideway, or an equivalent alternative are all acceptable.

. Manual Operation

Manual operation must be possible in an emergency from either end of the vehicle.

. Design Life

Design life is to be as follows:

- * Vehicles - 30 years
- * Facilities - civil work - 50 years
- * Electrical/Mechanical - 15 years
- * Power Distribution - 30 years except 10 years for power rails
- * Pavement, Guidance, and Running Rails - 15 years
- * Guideway Civil Work - 50 years

. Elderly and Handicapped

Barrier-free access is required with elevators in all stations and special fare gates for the handicapped.

. Command and Control

Command and control is to be designed to failsafe or checked redundant railroad safety standards.

. Central Control

A central control capability is to be provided equipped to display and monitor system performance and provide an operator with the ability to control and override system operation within limits imposed by the safety system. The operator should be able to automatically dispatch and remove trains and revise route assignments.

. Power

The vehicles are to be electrically-powered by either 3-phase AC or DC power from power rails located along the guideway.

. Grounding

The vehicles are to be continuously grounded at all times by a non-current carrying ground rail or approved equal.

. Vehicle Accommodations

The vehicle must accommodate standees. Seats will be provided for 20% of the passengers.

. Vehicle Weight

A crush-loaded vehicle must not produce a guideway load greater than 1,300 pounds per lane-foot.

. Vehicle Doors

Vehicle doors are to be biparting sliding doors with a maximum force limit, touch edges, and a recycling capability.

. Visibility

Windows must be provided in front and rear and both sides of cars.

. Communications

Two-way radio and a PA system between vehicles and control are required.

Selection Process

Table 2-10 compares the capabilities of representative suppliers' equipment to the Jacksonville mission requirement. An "X" indicates the system meets Jacksonville requirements. Where the system does not exactly meet the requirement, its capabilities have been given. Based upon this table, the following equipment appears to meet all technical requirements:

- * Westinghouse
- * UTDC
- * Fuji

Of these three systems, Westinghouse has a proven history of revenue experience. UTDC is still a test track system but has contracts to install equipment in Vancouver and Detroit and may have revenue experience by the time Jacksonville goes to contract. Fuji is purely a test track system in Japan. It is based on the Bendix-Dashaveyor System. The Bendix System was installed at Toronto Zoo in a nonautomatic version but was limited to test track operation in automated control. The lack of experience with UTDC, and especially with Fuji, should be of concern.

The following systems meet Jacksonville requirements in almost all respects and may be well suited to the ASE mission:

- * Niigata New Tram
- * Kawasaki Kobe Port Island

Among the limitations of this equipment are that on-board attendants have been required for revenue systems now in operation in Japan and headways exceed the 2 minutes required by Jacksonville. There appear to be plans to eventually remove the attendants although this has not yet been demonstrated. There is some concern whether failsafe emergency braking is used on the Kawasaki System. Such a brake is essential for unattended operation. With regard to headway, it is quite likely these systems could be designed to meet the 2-minute headway even though this is not the case in Japan.

TABLE 2-10

COMPARISON OF EQUIPMENT WITH JACKSONVILLE REQUIREMENTS

REQUIREMENT	JACKSONVILLE	WESTINGHOUSE	DISNEY MONORAIL	DISNEY HOUSTON WEDWAY	UMI MINNESOTA ZOO	UTDC ICTS	MATRA VAL	NIIGATA NEWTRANS	FUJI FAST	KAWASAKI KOBE
Type System	Fully Automatic Driverless Bidirectional	X*	Manual Operation	X Unidirectional	Operator Attended Unidirectional	X	X	Operator on Board But Could Run Driverless	X	Operator on Board But Could Run Driverless
Mode	Scheduled or Demand	X	Scheduled	Scheduled	Scheduled	Scheduled	Scheduled	Scheduled	X	Scheduled
Operation in Trains	Required	X	Semipermanently Coupled	X	Semipermanently Coupled	X	X	X	X	X
Vehicles	Fully Independent Single-Car Units	X	Semipermanently Coupled	X	Semipermanently Coupled	X	Married Pairs	X	X	X
Switching	Required	X	Slow Switch	Manual	Horizontal Substitution Segment	X	X	X	X	X
Waiting Time	2 Minutes	X	X	X	X	X	X	135 sec.	X	150 sec.
Line Capacity	4200 pphpd with 100-ft. long trains	X	X	X w/8-car trains	X	X	X	X	X	X
Maximum Speed	30 mph	X	X	12-15 mph	8-15 mph	X	X	X	X	X
Minimum Curve Radius	250 feet	X	May be Marginal	X	X	X	X	X	X	X
Maximum Grade	8%	X	X	X	X	X	X	X	X	X

TABLE 2-10 (Cont.)

REQUIREMENT	JACKSONVILLE	WESTINGHOUSE	DISNEY MONORAIL	DISNEY HOUSTON WEDWAY	UMI MINNESOTA ZOO	UTDC ICTS	MATRA VAL	NIIGATA NEWTRAMS	FUJI FAST	KANSAI KOREE
Coupling	Automatic Mechanical Manual Electric Connections	X	Semipermanently Coupled	Mechanical Drawbar	Semipermanently Coupled	X	Married Pairs can be Coupled into Trains	X	X	X
Loading Time	Unload Full Car in 20 Sec. from One Side	X	X	X	X	35 sec.	X	37 sec.	62 sec.	45 sec.
Emergency Evacuation	Required	X	Cross Car Transfer Only	X	Not Usually Provided	X	X	X	X	X
Manual Operation	Required from Either End of Car	X	X	Not Provided	One End Only	X	X	X	X	X
Heating and Air	Required for Vehicles	X	X	Not Provided	X	X	X	X	X	X
All Weather Operation	Operation in Winds to 45 mph; Survive Winds of 100 mph	X	X	Yes, with some Reduction in Performance	X	X	X	X	X	X
Elderly and Handicapped	Platform Level Barrier Free Loading Required	X	X	X	X	X	X	X	X	X
Power	3Ø AC or DC Power Rails	X	X	X	X	X	X	X	X	X

TABLE 2-10 (Cont.)

REQUIREMENT	JACKSONVILLE	WESTINGHOUSE	DISNEY MONORAIL	DISNEY HOUSTON WEDWAY	UMI MINNESOTA ZOO	UTDC ICTS	MATRA VAL	NIIGATA NEWTRANS	FUJI FAST	KAWASAKI KOBE
Grounding	Vehicles Continuously Grounded through Separate Non-current Carrying Ground Rail or Approved Equal	X	Ground Carries Current	Not Applicable	Ground Carries Current	X	Ground Carries Current	(1)	X	(1)
Accommodations	Must Accommodate Standees; Seats for 20% of Passengers	X	No Standees But Could be Done	X	Not Provided	X	X	X	X	X
Vehicle Weight	Crush-Loaded Car Must Weigh less than 1,300 lbs/ lane foot	X	X	X	X	X	X	Exceeds by 73 lbs/ft.	X	Exceeds by 44 lbs/ft.
Doors	Biparting Sliding Doors with Maximum Force Limit Touch Edges and Recycling Capability	X	Not Provided but Could be Done	X	Not Provided	X	X	X	X	X
Visibility	Windows in Front, Rear and Sides	X	X	X	X	X	X	X	X	X

TABLE 2-10 (Cont.)

REQUIREMENT	JACKSONVILLE	WESTINGHOUSE	DISNEY MONORAIL	DISNEY HOUSTON WEDWAY	UMI MINNESOTA ZOO	UTDC ICTS	MATRA VAL	NIIGATA NEMTRANS	FUJI FAST	KAWASAKI KOBE
Command and Control	Failsafe or Checked Redundant per Railroad Safety Standards	X	X	X	No	X	X	X	X	X
Central Control	Required -- Must Have Displays and be Able to Monitor and Control Performance; Must Have Alarms and Malfunction Reporting	X	Manual Dispatch	X	Manual Dispatch	X	X	X	X	X
Communications	Two-Way Radio Plus PA Between Cars and Central	X	X	X	X	X	X	X	X	X
Overall		Well Suited	Does Not Meet Requirements	Does Not Meet Requirements	Does Not Meet Requirements	Well Suited	Inability to Operate as Single Cars is a Major Limitation	May be Well Suited	Well Suited	May be Well Suited

* An "X" indicates that the system meets the Jacksonville requirements.

** Configurations of power rails could not be ascertained.

The Matra-VAL System is, in many respects, very well suited to Jacksonville's requirements. However, the necessity to operate vehicles as married pairs means twice as many cars will be required to meet the fairly low capacity requirement for the first stage Jacksonville system. This might be judged a significant limitation.

REFERENCES

INTRODUCTION

1. Jacksonville Area Planning Board; 2005 Comprehensive Plan, City of Jacksonville, Florida; as revised June 1980.
2. Downtown Development Authority; The Plan for Downtown Jacksonville; September 1971.
3. Downtown Development Authority; Downtown Jacksonville: A Transportation and Redevelopment Strategy; Part I and II; 1977.
4. Florida Department of Transportation; The Four Area Preferential Treatment HOV Design Study, Jacksonville Corridor; January 1979.
5. JUATS; Major Review, Year 2005 Transportation Plan; 10/10/80.
6. Downtown Development Authority; Jacksonville on the Move; 1980.
7. City of Jacksonville, Florida; Previous Transportation Planning, Jacksonville Downtown People Mover (Proposal); Mayor's People Mover Task Force; June 30, 1976.
8. Jacksonville Transportation Authority; Final Report on Project Feasibility, Jacksonville Downtown People Mover; November 1979.
9. Jacksonville Transportation Authority; Technical Memorandum No. 2. Public Involvement Program; Jacksonville Downtown People Mover Feasibility and Impact Studies; October 1978.
10. Jacksonville Transportation Authority; Transit Improvement Alternatives for the Jacksonville Metropolitan Area, Draft Environmental Impact Statement; August 1981.
11. Jacksonville Area Planning Board; Preliminary 1985 Mass Transportation Plan; Jacksonville Urban Area Transportation Study Update; 1979.
12. JAPB; Air Quality Control Plan - Duval County; op. cit., page II-27.
13. Jacksonville Transportation Authority; Design Criteria and Standards, Jacksonville Automated Skyway Express Project; Preliminary Engineering Studies; January 23, 1981.

SYSTEM DESCRIPTION OF INITIAL SEGMENT

REFERENCE VEHICLE AND SYSTEMS

The Jacksonville Automated Skyway Express (JASE) System is an automated transportation system to be constructed in downtown Jacksonville, Florida. The JASE will provide quiet, timely passenger service between the major business, shopping, medical, educational, and living areas near downtown Jacksonville on both sides of the St. Johns River.

System General Characteristics

The JASE will consist of fully automated, driverless vehicles, operating singly or in trains, traveling along an elevated guideway and stopping at on-line stations. The guideway is to be all double-track using turnbacks at the ends of the line.

For certain types of vehicle systems, single-track loops will be provided at the ends of the route if turnarounds are used. A flat fare will be charged for use of the JASE. The JASE design concept is based upon simplicity and efficiency of operation. Stations will be unattended and, in view of the short waiting times, they will not be heated or air conditioned. Whenever possible, stations will be integrated with the major activity centers they serve and, since Florida is the home for many retirees, the system will stress accessibility to the elderly. It will also be barrier-free with elevators and special fare gates for the handicapped in all stations.

The JASE System includes the following elements:

- 1) Driverless automatically-controlled vehicles, approximately the size of small buses, capable of speeds up to 30 mph.
- 2) Seven stations serving the major downtown business, shopping, medical, educational, and residential districts constructed and integrated into existing buildings and roadways.
- 3) An Automatic Control System (ACS) using proven, fail-safe automatic vehicle protection equipment and a computer-controlled operational system to provide safe, frequent service to users.
- 4) A Central Control facility, manned during all system operational periods, to provide surveillance and assistance.
- 5) A maintenance facility to provide for routine maintenance. Major maintenance such as structural repair, painting, and overhaul will be integrated with JTA bus maintenance.

Performance Capabilities of Representative AGT Systems

This section is a summary of the most significant performance factors

of the individual Automatic Ground Transport (AGT) Systems currently available for application to the Jacksonville Downtown. These parameters were chosen because of their effect on the operating characteristics of the completed Jacksonville system. For example, a system requiring cruise speed of 30 mph cannot use the Disney WEDway equipment as it is currently available.

. Vehicle Speed

Two values are listed for the maximum cruise speed in Table 3-1. The first is the maximum speed demonstrated by each system in regular passenger service and the other is the speed achieved on a test track or that claimed by the manufacturer. The predominant maximum speed for medium-sized vehicles is 30 mph; for large vehicles it is 50 mph.

. Turning Capability

There are two limitations on turning radii: one which is characteristic of the equipment and the other which depends upon not exceeding an allowable lateral g force for passenger safety and comfort. The turning radii based on the latter limitation are those indicated in the descriptions of operational characteristics for the representative systems. These turning radii are site-specific and do not represent the capability of the equipment. The equipment-related turning radius represents the minimum turning radius the equipment is capable of negotiating at very low speeds. This is important because it governs the size of turnarounds, turnout curvatures, and other curves in stations and yards where speeds are low.

. Vehicle Capacity

Capacity has been calculated based on the floor space of each vehicle. Capacities have been calculated using 4.5 sq. ft. for seated passengers and 2.5 sq. ft. per standee for nominal design and 1.5 sq. ft. per standee for crush conditions.

. Maximum Train Length

This has been given by the manufacturer of each system.

. Line Capacity

The capacity of an AGT System depends on a number of factors. These include the vehicle size, the train length (or the number of cars in a consist), the minimum headway, the guideway utilization, and the load factor for the system. The theoretical capacity assumes all vehicles are fully crush-loaded and also presumes vehicles make use of all available guideway space. This is the maximum system capacity

TABLE 3-1
SUMMARY OF PERFORMANCE CAPABILITIES

SUPPLIER	SPEED		MINIMUM TURN RADIUS INSTALLED	MAXIMUM TRAIN LENGTH	LINE CAPACITY	SUSPENSION	SWITCHING	GRADABILITY	MAXIMUM INSTALLED GRADE	REVERSIBLE	PASSENGER EVACUATION
	DEMON- STRATED	CLAIMED									
Westing- house	30	55	96 ft.	4 cars	11,560 pph	Primary - Pneumatic Tire Secondary-Leaf Spring and Air Coil	Track- Based D	10%	1.2%	Yes	Safety Walks
CTS/Disney MEDway	7	30	24 ft.	3 cars	1,660 pph	Primary - Polyurethane- Coated Wheels Secondary- Rubber Mounts Between Frame and Body	Track- Based T	15%	0	No	Center-Guideway Walkway
CTS/Disney Monorail	45	50	250 ft.	6 cars	10,000 pph	Primary- Pneumatic Tire Secondary-Air Bag Cushions	Track- Based T		6%	Yes	Adjacent Vehicle
UMI Minne- sota Zoo	8.7		80 ft.	6 cars	7,680 pph	Primary- Pneumatic Tire	None		2.5%	No	
UTDC		50	115 ft.	6 cars	18,720 pph	Primary- Resilient Steel Wheel	Track- Based T	10%	6%	Yes	Safety Walks
Engins Matra-VAL	48		328 ft.		12,480 pph	Primary- Pneumatic Tire	Track- Based D		7%	Yes	Safety Walks
Niigata	30		65 ft.	6 cars	12,000 pph	Primary- Pneumatic Tire	Track- Based D	2.5%	10%	Yes	Safety Walks

and sets a limit to the maximum number of passengers the system can transport. Line capacities for available vehicles are shown in Table 3-1 for single-car and multi-car operation.

. Suspension

A brief notation of primary and secondary suspension components is listed.

. Switching

Switching for AGT Systems has been designed in a number of ways. The equipment can be track-mounted (for example a standard railroad switch), vehicle-mounted (as is the steering gear in an automobile), or a combination of both.

Not all have been proven in regular passenger service, however. Table 3-1 is a listing for the switching capability; whether it has been proven in passenger service (D), prototyped (T), or whether it is still in the conceptual stage (C).

. Grade

There are two listings under this heading: gradability and the maximum grade which has been installed. Manufacturers' claims for grade-climbing ability do not always match the operating characteristics of their installations or prototypes.

. Reversibility

The configuration of the JASE System will depend very much on whether or not the vehicles are bidirectional. If not, reversing loops will have to be built at the ends to turn the vehicles around. Directionality is listed here.

. Passenger Evacuation

In case of emergency, passengers will have to be safely evacuated from the vehicle. There are several ways this can be done. Safety walks on one side of the guideway are used in some rapid transit tunnels and conventional elevated railroads. Others, such as PATH, evacuate passengers from the end cars onto the guideway between the rails.

An alternate method, used by the Disney Monorail, is to pull another vehicle alongside and evacuate passengers directly from one vehicle into the other.

These options are listed for each system.

Summary of the JASE System Basic Design

This section describes basic preliminary design features of the JASE System. This basic design has been assumed only for preliminary design purposes and for making estimates of costs and operation. Only those aspects of the technological system (vehicle, control, propulsion power distribution, and energy consumption) are included here. Fixed-facilities and structures (guideways and stations) are covered in the following section titled "Guideway Design".

. Vehicle Description and Characteristics

This section summarizes the preliminary engineering requirements for the JASE vehicle. The vehicle shall be automatically controlled and operated without a driver. While multiple vehicle consists may be equipped, if necessary, to meet system requirements, each vehicle shall be fully independent and capable of operation as a single unit. Each vehicle is expected to have an operating life of 30 years assuming annual use of 40,000 miles.

. Dimensions and Weights

For purposes of estimating other system parameters and costs, the basic vehicle dimensions have been assumed as follows:

- * Overall maximum length -- 40'
- * Overall maximum width -- 9.2'
- * Overall maximum height -- 11.5'

The vehicle shall be designed to support loads as follows, allowing 160 lbs. (72.5 kg) for each passenger and a space allocation of 4.5 sq. ft. (0.42 m²) for each seated passenger.

- 1) AW0 - The empty weight of the vehicle; assumed to be approximately 33,000 lbs.
- 2) AW1 - The weight of the vehicle loaded to normal design capacity. Normal design capacity shall be computed by assuming all seats occupied with passengers and adding one standing passenger for each 2.5 sq. ft. (0.2 m²) of floor space in the vehicle available to standees. AW1 is assumed to be approximately 47,400 lbs.
- 3) AW2 - The weight of the vehicle crush-loaded. Crush-load shall be computed by assuming all seats occupied with passengers and adding one standing passenger for each 1.5 sq. ft. (0.14 m²) of floor space in the vehicle available to standees. AW2 is assumed to be approximately 54,600 lbs.

. Capacity

The basic vehicle design is assumed to be 90 passengers, 18 seated and

72 standing, which is based upon a normal line capacity of 5,400 pphpd with 2-car trains and at a headway of 2 minutes. The crush capacity is 135 passengers, 18 seated and 117 standing, which yields a maximum line capacity of 8,100.

. Structural Design

Detailed structural requirements are not anticipated. Structural integrity shall have been previously demonstrated. However, the design shall provide the following characteristics for crash survivability:

- * Collide with an immovable solid object at 3.0 mph and suffer no damage;
- * Collide with an immovable solid object at 5.0 mph with any damage confined to the coupler or other energy absorbing bumper; and
- * Incorporate an anti-climbing feature that prevents one vehicle from climbing over any other vehicle in a collision.

. Vehicle Performance and Passenger Comfort

The vehicles shall have performance and passenger comfort as stated in Table 3-2. Each vehicle shall be provided with two separate air conditioning systems.

. Propulsion and Braking

Vehicle propulsion will be electric-powered and, for purposes of estimating costs and other features, a conventional traction drive system through rubber tires has been assumed.

The duty cycle of the propulsion and braking system shall permit continuous operation of the vehicles over the JASE System guideway loaded to their crush-capacity. In addition, it shall be possible for one crush-loaded vehicle to push or pull another crush-loaded, dead vehicle into the next station in the normal direction of travel where the passengers of both vehicles would be unloaded. Then it shall be possible for both vehicles (now empty) to travel once around the JASE guideway, where speed and acceleration capability may be degraded 50 percent, there be no degradation in service braking of emergency, and emergency braking is always available from both cars.

Service braking is assumed to be provided by both dynamic (motor braking) and friction brakes. Fail-safe emergency braking shall also be provided and is assumed to be combined with friction brakes normally used for service deceleration. The emergency brakes shall be irrevocable; that is, once applied they will remain applied until the vehicle comes to a complete stop. Conditions for resetting the emergency brakes, manual on-board, or by remote signal is dependent upon the safety policies. The emergency brake controls shall be interlocked with propulsion controls in a fail-safe manner so that braking commands dominate.

TABLE 3-2
PASSENGER COMFORT

Heating Comfort	Adjustable from 60-70°F
Cooling System	Adjustable from 74-82°F
Temperature Uniformity	±4°F 1' from inside surface at least one minute after doors close in station
Air Circulation Rate	30 cfm/passenger
Fresh Outside Air	25%
Interior Noise Level	
Vehicle Stationary - Doors Shut	68 dBA
Vehicle Moving 10 mph	70 dBA
Vehicle Moving - Maximum Cruise Speed	75 dBA
Speed	
Maximum	30 mph
Cruise	30 mph
Maximum Sustained Acceleration	
Lateral	±0.1 g
Vertical	±0.03 g with respect to 1 g datum
Longitudinal - Normal	±0.1 g ignoring grade
Emergency	±0.15 g including effect of grade
	±0.25 g including effect of grade
Maximum Rate of Change of Acceleration*	
Lateral	0.06 g/sec
Vertical	0.03 g/sec
Longitudinal	0.05 - 0.1 g/sec (adjustable)
Ride Quality	Center band RMS values of acceleration averaged over any single station-to-station trip must fall below ISO 1 hour reduced comfort boundary curve
Vehicle Illumination Level	30 foot-candles - reading plane
Emergency Illumination Level	5 foot-candles at vehicle floor, doors, and emergency exits

* Lateral acceleration is defined as the vector sum of the centrifugal and gravitational forces applied to a passenger in a plane parallel to the vehicle floor. Longitudinal acceleration is defined as the rate of change of speed and ignores effect of body forces from grades. This value shall not exceed 0.15 g when including the effect of grade.

The vehicle shall also have a fail-safe parking brake which is also assumed to be combined with a friction brake system. The parking brake shall hold a crush-loaded vehicle on the maximum grade of the JASE System under a maximum wind load of 100 mph, without application of power for an indefinite period.

. Doors

Automatic doors shall be provided on both sides of the vehicle. The passenger vehicle is assumed to have two double doors on each side that will permit total loading or unloading of passengers in 20 seconds. Normal door operation shall be controlled by the Automatic Vehicle Operation (AVO) System. Each set of doors shall be independent with no shared components so that failure of one set shall not cause failure of any other set. The doors shall be equipped with sensitive edges and a recycle feature so that they shall recycle open in the event an obstruction as small as a finger is sensed. Closing forces and driving energy shall be limited to values that will not injure passengers.

One door on each side shall be equipped with features to allow it to be opened manually from inside or outside the vehicle. It is assumed that these doors shall also be used for emergency egress. The doors shall be interlocked with the AVO System so that they will not open until the vehicle is at zero speed, is properly aligned in the station, the brakes properly applied, and power removed from the motors. The interlocks shall also inhibit movement of the vehicle unless all doors are closed and locked. In the event that a door is opened while the vehicle is in motion, the vehicle shall be service-braked to a stop and sound an alarm in Central Control.

. Coupling

It is assumed that vehicles will be equipped with mechanical couplers that couple automatically (i.e., will latch mechanically) by moving two vehicles against one another. A positive lock will inhibit uncoupling. While coupling will normally be done in the maintenance area, it will be possible to couple vehicles anywhere on the JASE guideway for purposes of failed vehicle retrieval. Control of uncoupling is assumed to be manual. There shall be no requirement for a person to stand between moving vehicles during coupling or uncoupling. Both coupling and uncoupling shall be performable by one person.

All electrical, pneumatic, and/or hydraulic connections are assumed to be accomplished manually after a coupling event or disconnected manually before uncoupling through the use of multi-pin connectors and quick connects.

. Electrical System

The primary power for the vehicle shall be obtained from power rails in

the guideway via redundant power collectors on board the vehicle. Primary power will be conditioned on board the vehicle to the appropriate voltages for propulsion and auxiliary systems.

Each vehicle will be grounded at all times through a non-fused grounding circuit by a minimum of two grounding brushes.

Each vehicle will be equipped with an emergency power supply (battery) in the event of primary power loss so that the following systems remain fully operational for at least one hour on an uninterrupted basis:

- * 2-way communications with Central Control
- * ventilation to sustain crush-load of passengers at minimum of 5 cfm per passenger
- * emergency interior and exterior lighting
- * any vehicle function necessary for disabled vehicle recovery
- * automatic door operation
- * Automatic Vehicle Protection System
- * alarm and malfunction reporting

Interior vehicle lighting shall be provided at illumination levels given in Table 3-2. Each end of the vehicle will be equipped with marker lights, interlocked with direction of travel.

. Suspension and Guidance

The lateral guidance system shall provide positive mechanical methods for entrapping the vehicle in the lateral direction. Primary vertical suspension is assumed to be by pneumatic tires. The secondary suspension is assumed to be by a combination of air bags and springs. The air bags will provide automatic vertical alignment of the vehicle floor with the platform floor, under all passenger load conditions, within $\pm 7/8$ ". The horizontal gap between the vehicle door sill and platform edge shall not exceed 1.5".

Suitable backup shall be provided to assure that loss of air pressure in any tire will not cause an unsafe condition.

. Flammability and Smoke Emissions and Fire Protection

Vehicle materials will meet the guidelines for flammability, smoke emission, and toxicity issued by the UMTA Office of Safety and Product Qualification. No polyvinyl chloride, polyurethane foam, polystyrene foam, or foam rubber will be used. Each vehicle will have two Class C fire extinguishers.

. Vehicle Interior

Bench seats shall be provided for 20 percent of the design passenger capacity, which is assumed to be 18 seated passengers. All standing passengers shall have access to vertical stanchions.

All windows shall use safety glazing materials approved for use in motor vehicles except windshields shall be per ANSI Z26.1-1966 (R 1973).

. Communications and Passenger Information

Each vehicle will be equipped with a 2-way voice communications system for passengers to communicate with Central Control in emergency conditions.

Each vehicle will be equipped with two multi-colored route maps, one on each inside wall by the doors.

All emergency devices will be suitably marked and include instructions.

. Manual Operation

Each vehicle shall have incorporated a manual mode of operation. These controls shall be located in special locked panels at each end of the vehicle and provided with good forward and rear visibility. This panel will provide braking and propulsion controls, forward and reverse controls, a door control button, and an emergency stop button. The propulsion control shall include a "dead man" feature. Manual operation shall not be subject to any AVP safety restriction.

Propulsion Power Distribution System

This section summarizes preliminary engineering requirements for the propulsion power system. Analysis has been performed for the first stage system running from St. Johns Station to Florida Junior College. Possible expansion to the complete system has also been considered.

. Assumed System Parameters

Table 3-3 summarizes system parameters assumed for the analysis. The vehicle was assumed to be of the basic design described in Chapter 2. Kva for vehicle acceleration, cruising, and idling were taken from data supplied by the manufacturer of Miami's system. In addition, an analysis of a similar DC-powered vehicle was also conducted for purposes of comparison. Line capacity was assumed to be 2,700 pphpd for the first year on the first stage system. Since cars must operate every 2 minutes, the capacity can be satisfied by single 90-passenger vehicles. As a conservative design approach, the worst case condition for calculation of voltage drop was assumed to be operation of 2-car trains. Design according to this requirement also provides the regulation necessary for operation of the Full System at a later date. The total length of guideway in the system was calculated to be 22,310'. Travel time for a round trip is 14.7 minutes.

TABLE 3-3
ASSUMED SYSTEM PARAMETERS

kva per Car		
Accelerating	279 kva	0.8 power factor
Cruising	46 kva	0.95 power factor
Idling	31 kva	0.71 power factor
Vehicle Design Capacity		90 persons
Line Capacity (single vehicle), minimum		2,700 pphpd
Service Frequency Peak Period (design)		2 minutes
Variation in Service Frequency		±30 seconds
Travel Time - Round Trip		
FJC to St. Johns Place		6.9 minutes
St. Johns Place to FJC		6.8 minutes
2 Turnbacks		1.0 minute
Total		<u>14.7</u> minutes

. Assumed Power Parameters

Both AC and DC power distribution systems were analyzed. For AC, the power rail was assumed to be carrying 3 phase power at 600 volts. Minimum permissible voltage at the car was assumed to be 517 volts.

For DC power distribution at nominal 600 volts, third rail resistance was assumed to be 0.00225 ohms/1,000' and the return rail impedance 0.00166 ohms/1,000'. Substation voltage regulation was set at 5 percent.

. Proposed Designs and Voltage Regulation

Figures 3-1 and 3-2 show AC and DC propulsion power designs for the Jacksonville ASE System. The DC design has two substations, one at Gulf Life and one at Hemming Plaza. The AC design requires four substations, one each at Hemming Plaza, Jefferson, Prudential, and Gulf Life. To eliminate the need for a station on the Acosta Bridge, 1,000' lengths of 1,000,000 circular mill cable in a 4" conduit would be laid from the substations at Prudential and Jefferson.

Table 3-4 summarizes the transformational voltage regulation requirements for each design for both 1-car and 2-car consists. Additional transformers would be needed for 2-car operation under either design.

Command and Control System

The Command and Control System shall be automatic and shall regulate the movement of all vehicles excepting those under on-board manual control. This system shall control vehicle separation, routing, speed, precision

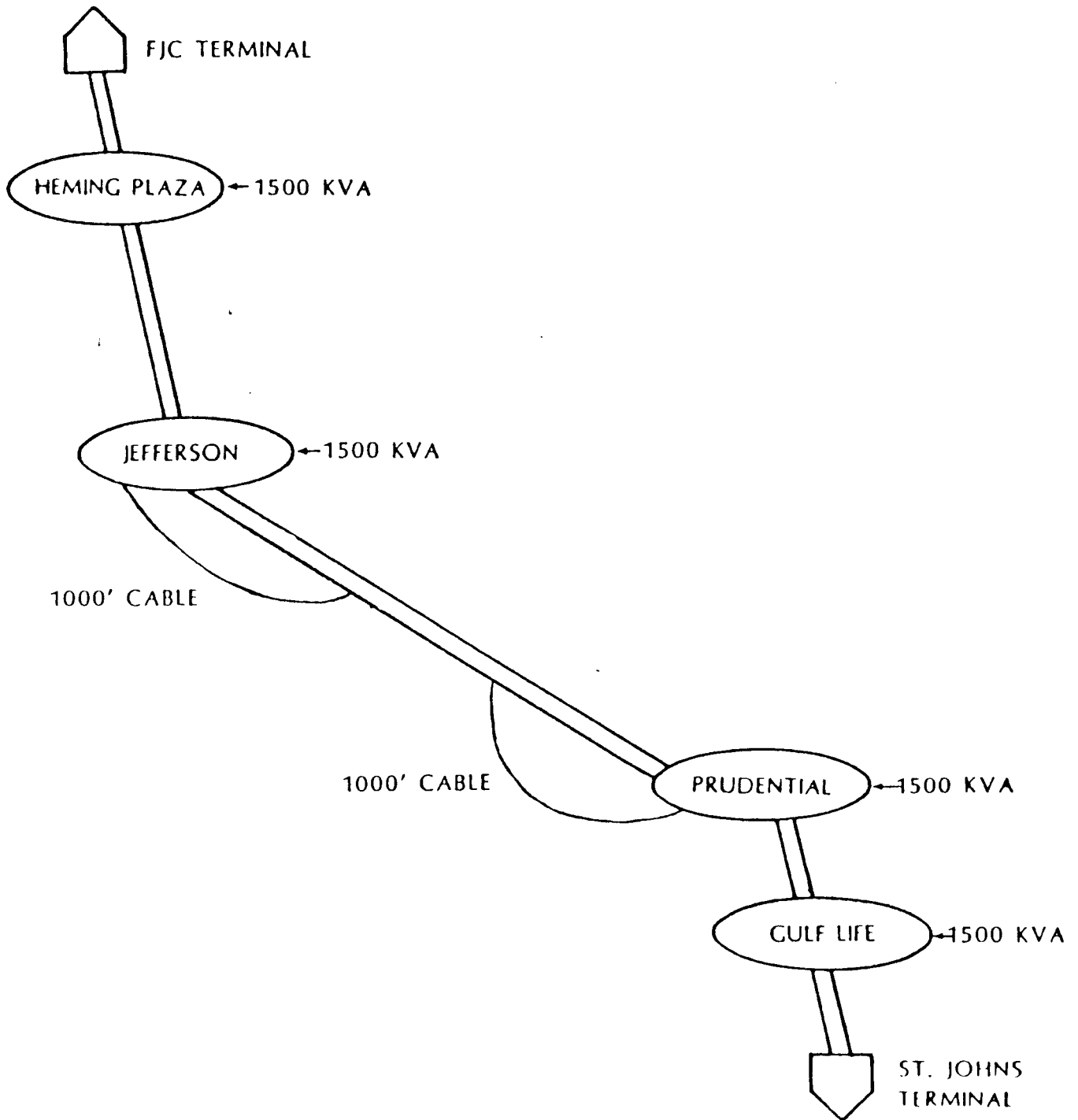

FIGURE 3-1

PROPOSED AC POWER DISTRIBUTION

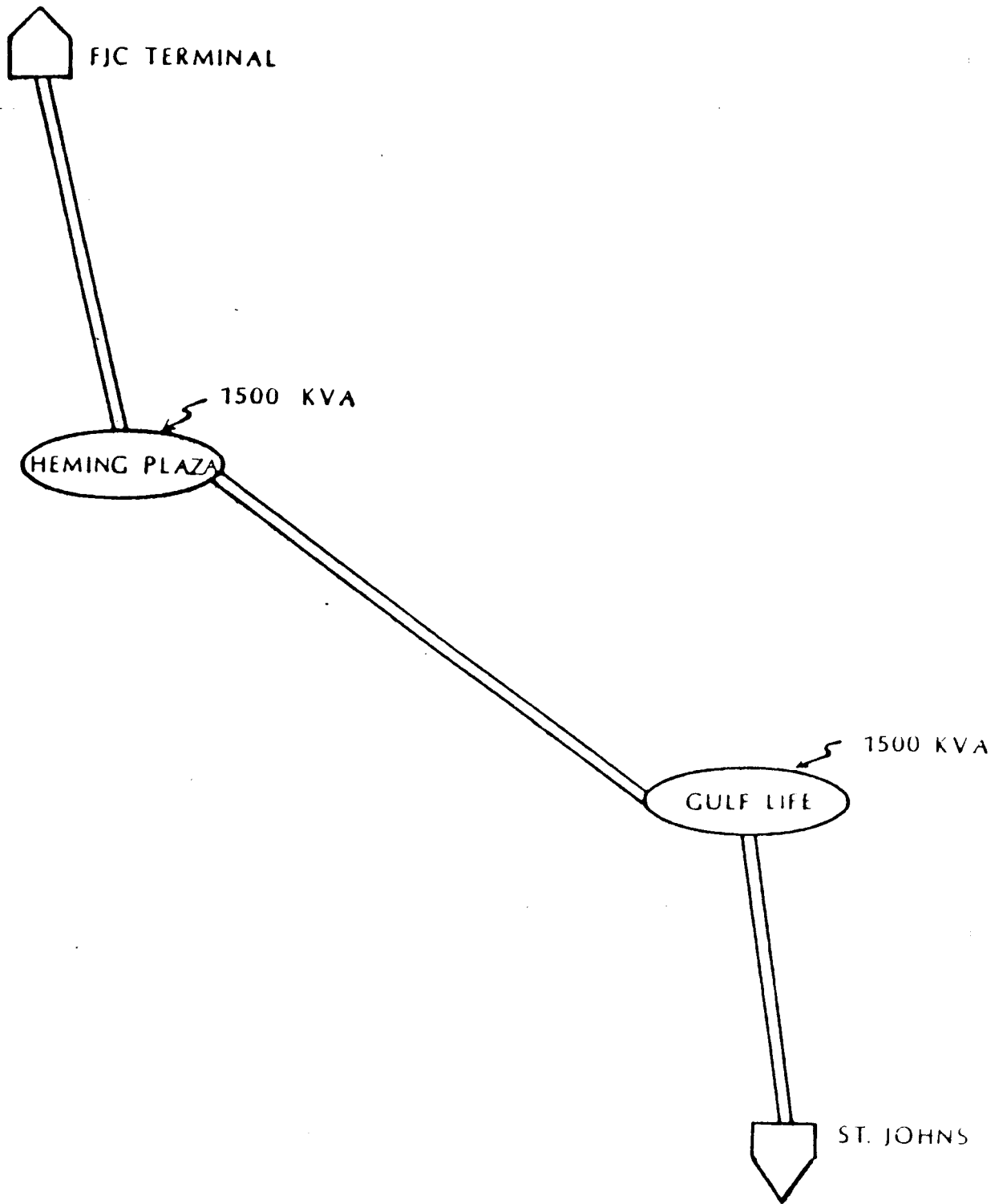

FIGURE 3-2

PROPOSED DC POWER DISTRIBUTION

TABLE 3-4
PROPOSED DESIGN

<u>SUBSTATION LOCATION</u>	<u>DC SYSTEM</u>		<u>AC SYSTEM</u>	
	<u>NUMBER & RATING OF TRANSFORMERS/ RECTIFIERS</u>		<u>NUMBER & RATING OF TRANSFORMERS</u>	
Gulf Life	3 - 500 kva*		2 - 750 kva*	
Prudential			2 - 750 kva*	
Jefferson			2 - 750 kva*	
Hemming Plaza	3 - 500 kva*		2 - 750 kva*	

VOLTAGE REGULATION

<u>LOCATION</u>	<u>DC SYSTEM</u>		<u>AC SYSTEM</u>	
	<u>1-CAR TRAINS</u>	<u>2-CAR TRAINS</u>	<u>1-CAR TRAINS</u>	<u>2-CAR TRAINS</u>
St. Johns/Gulf Life	5.5	6.0	9.4	14.8
Gulf Life/Prudential	6.5	7.9	4.8	6.1
Prudential/Jefferson			8.7	13.4
Jefferson/Hemming Plaza			8.5	13.2
Hemming Plaza/FJC	5.5	6.0	9.6	15.2

* Additional transformers would be added for operation of 2-car trains.

stopping, traffic direction, door operation, acceleration, jerk, velocity envelope, safety interlocks, station graphics and announcements, and, in addition, shall be responsible for monitoring of ASE operations.

The Command and Control system shall consist of equipment located in Central Control, along the wayside, in station areas, at switches and transfer tables, and on board the vehicles. The actual distribution of such equipment will depend upon the specific system installed. The Central Control includes the control and display console, central computers, plus offices for personnel and records management for the JASE System.

From a functional standpoint, the Command and Control system comprises three subsystems:

- . Automatic Vehicle Protection (AVP)
- . Automatic Vehicle Operation (AVO)
- . Automatic Vehicle Supervision (AVS)

The AVP provides protection against collision, switch malfunction, overspeeds, door malfunctions, and other safety-related operational problems. Table 3-5 summarizes AVP System reactions.

TABLE 3-5
SUMMARY OF AVP SYSTEM ACTIONS

<u>SITUATION</u>	<u>SYSTEM REACTION</u>	<u>RECOVERY ACTION</u>
Headway encroachment	Service brake (with emergency brake override)	Vehicle shall automatically proceed when clear
Merge conflict (switch or transfer table)	Service brake (with emergency brake override)	Vehicle shall automatically proceed when clear
Roll-back	Emergency brake	Manual reset or remote restart
Overspeed (or service brake failure)	"Irrevocable" emergency brake	Manual reset or remote restart
Parted consist	Service brake	Manual reset only
Loss of communica- tions	Service brake (with emergency brake override) or emergency brake	Remote restart when communi- cations are established
Unscheduled door opening	Service brake	Manual reset only (unless stopped in station area)
Vehicle not properly aligned in station or vehicle speed not zero or parking brakes not applied	Doors remain closed	Doors open if conditions are corrected; otherwise, vehicle must proceed to next station

The AVO subsystem provides the automatic control for those functions that occur at speeds below the maximum safe speed, providing acceleration, deceleration, and jerk control, station stops, and door operation.

The AVS subsystem is the link between the Central Operator and the JASE System. It provides all pertinent information relative to the system and provides means for the Central Operator to control various functions of the system. The AVS system also provides for system supervision including automatic routing and schedule keeping.

The Central Control Facility (CCF) is the central location where the equipment and personnel involved in the operation of the JASE are housed. The equipment used at the CCF consists of the monitoring and control equipment which comprises the AVS subsystem of the JASE automatic Command and Control system which is described in more detail below.

. Performance Monitoring

Performance displays will provide a visual representation of real-time operating conditions throughout the JASE System. Graphics will display a representation of the JASE guideway system, stations, switches, maintenance facility, and other relevant physical features including, where applicable, signal block boundaries, power feed points, etc. Dynamic graphics will indicate the location and direction of travel of every consist in any part of the JASE System where automatic operation is possible. The display will also indicate the status of all switches; that is, the direction a vehicle would follow through a switch.

In addition, the electrical power system will also be graphically displayed either as an integral part of the guideway display or separately. The power system display will indicate each segment of the guideway which may be individually energized with propulsion power and whether or not the power is activated in each segment. The status of major network protectors, circuit breakers, and electric switches (open, closed, tripped) and the status of the emergency power supply will also be indicated.

In addition, the AVS system will keep a record of the identification number of the vehicles operating in each consist, the operating mode in which the JASE System is functioning, and the route to which each consist is assigned. AVS will also record any unscheduled stoppage or delay including time of occurrence and time of resumption of operation complete with the identification number for the consist affected.

. Performance Control Capabilities

The Central Control Operator will be responsible for initiating certain actions required for normal operation of the system. The following supervisory functions will be under his direct control:

- 1) Consist Dispatch - The Central Control Operator will be responsible for dispatching consists into the system. Consists will be located in storage areas either at the maintenance facility or at the terminal stations. The Central Control Operator will be able to individually insert these consists into revenue service by establishing necessary switch paths and initiating vehicle movement.
- 2) Initiation of Service - The Central Control Operator will be able to initiate service by entering the proper command into the control console. This action will initiate stopping of consists at stations, opening and closing of consist doors, and display of appropriate graphics and audio announcements in stations.
- 3) Termination of Service - Similarly, the Central Control Operator will be able to command the termination of service. This action will cause pre-recorded announcements, indicating an impending system shutdown, to be broadcast at stations and in vehicles along with the display of appropriate graphics. Consists will make one final round trip to allow passengers to get off at their destinations and then proceed to pre-designated storage locations and stop.
- 4) Removal of Consists - During normal revenue service, the Central Control Operator will be able to remove consists from service by entering a command in the Central Control console. The consist affected will follow the same sequence as issued for termination of service. It will be possible to route the consist to maintenance regardless of where it is located. It may also be possible to route the consist to stubend storage.
- 5) Control of Graphics and Audio Announcements - The Central Control Operator will be able to control the dynamic graphics and audio announcements in the stations and the audio announcements in the vehicles either for an individual station or vehicle or simultaneously throughout the JASE System.
- 6) Control of Guideway Power - The Central Control Operator will be able to positively control the application and removal of propulsion power from each individually powered segment of the JASE guideway. In addition, a master control will permit all propulsion power to be shut off to the entire JASE System at once.

In addition, the AVS subsystem will be provided with an automatic "anti-bunching", or schedule keeping, capability to assure that consists are properly spaced throughout the JASE route. This control will limit the maximum variation from established schedules to 2 minutes and will restore the system to equilibrium within 15 minutes after it has been perturbed by a vehicle failure or other anomaly.

. Performance Override Capabilities

To allow for management of the JASE under abnormal conditions, it should be possible for the Central Control Operator to override the normal

operation of the JASE System using a CRT with keyboard or similar control console. The following override capabilities will be required:

- 1) Revise Route Assignment - The Central Control Operator will be able to convert the JASE System between its Normal Mode of operation and the Shuttle Mode of operation used for failure management purposes.
- 2) Stop and Proceed - The Central Control Operator will be able to individually stop any consist in the JASE System for as long a period as necessary.
- 3) Modify Station Dwell - The Central Control Operator will be able to vary the dwell time for each station independently.
- 4) Bypass Station - The Central Control Operator will be able to request that all vehicles proceed without stopping at any station or stations in the JASE System.
- 5) Hold Consists - The Central Control Operator will be able to hold any consist in any station or all consists in all stations.
- 6) Reduce Speed - The Central Control Operator will be able to reduce the speed over any individual guideway segment where this may be necessary. He will also be able to impose a zero speed constraint on any guideway segment, effectively blocking the guideway to traffic.
- 7) Door Overrides - The Central Control Operator will be able to override door commands in order to either open the doors or hold the doors shut. It will also be possible to remotely recycle the doors from Central Control. If the vehicle fails to align properly within the station, the Central Control Operator will have the choice of either allowing the vehicle to proceed without ever having opened its doors or of holding it in the station until a maintenance person can be summoned.

. Alarms and Malfunction Reporting

To assure safe and efficient operation of the JASE, it is necessary that major components throughout the system be automatically monitored for malfunctions and/or failures. Therefore, the Central Control console shall incorporate a Malfunction Display CRT where malfunctions are reported to the Central Control Operators. The occurrence of a malfunction shall be reported on the Malfunction Display CRT, indicating the nature and classification of the malfunction and the identification of the vehicle involved when appropriate; also, an audible alarm shall sound. Each alarm shall be displayed separately and in order of occurrence.

Acknowledgement of the alarm by the Central Control Operator shall cause the audible alarm to cease; however, the malfunction light or CRT shall remain illuminated until the malfunction is cleared.

The number and types of malfunctions and categories will be kept flexible so they can be compatible with a variety of approaches used by various JASE System suppliers.

. Communications

The JASE System will be provided with a public address system permitting the Central Control Operator to communicate with any station or combination of stations in the JASE System. Two-way telephone communications will also be provided between each station and Central Control. The phone will automatically ring when the receiver is lifted in the station and a display at Central will indicate which phone is originating the call.

A full duplex radio communications system will be provided to permit 2-way voice communications throughout the JASE System. The communications system will include separate channels for Maintenance and Operations-related activities. JASE vehicle radios will have access to the Operations and Maintenance channels. In addition, roving Maintenance personnel will be provided with portable, half-duplex handsets with access to all channels. Separate channels will be provided to Central Control and Maintenance personnel to communicate with police and fire service. Passenger-initiated communications from a vehicle will automatically activate the radio link between Central Control and the vehicle; also, the vehicle identification number from which the communication is received will be displayed on the Central Control console.

A closed-circuit television system will be provided to permit the Central Control Operator to monitor passenger activities at all stations in the JASE System. A minimum of two cameras per station will be required, one for the platform and one for the free area.

. Record Keeping

The Central Control system will maintain a historical record of all alarms and acknowledgements, all AVS operator control console commands, and other AVS-initiated activities including identification of vehicles operating and when inserted or withdrawn from service. The record will include time in service and mode of operation (Normal or Degraded Shuttle). The date and time of occurrence for all recorded actions will also be provided. A continuous real-time printout will provide a hard-copy record of these activities. In addition, a floppy disc file will be maintained on which all data is recorded in a format which includes the exact time and which is suitable for random access and manipulation using JTA-supplied management information software.

A single video recorder will be provided on which the Central Control Operator can patch in and record the signal from any of the closed circuit TV cameras. Continuous 24-hour recording of all audio communications to and from Central Control will also be provided.

. Redundancy

To assure reliability, the computer system and essential peripherals will be provided with backup systems operating in an On-line Parallel Mode so that no single failure will interrupt system operation.

GUIDEWAY DESIGN

As part of the preliminary engineering studies conducted for the River Crossing ASE, architectural and engineering drawings have been prepared which define the functions, components, and layout of the guideway, stations, and appurtenant facilities. The graphic representations of these facilities, appearing in this chapter, are shown at a reduced scale in Figures 2-8 and 3-3 through 3-15 on the following pages.

Route Description

The River Crossing ASE basically is a north-south line. On the north, the line would begin on Hogan Street between State and Union Streets at the Florida Junior College, an elevated center platform station with full intermodal facilities: bus transfer, auto, and taxi drop-off zones, and 1,500 park-and-ride spaces. An elevated pedestrian bridge would cross State Street to the FJC buildings. The line would continue south to the center of the Hemming Plaza Station. The distance between the two proposed stations is 1,435'. The Hemming Plaza Station would be an elevated center platform station which allows pedestrian access through a series of 2nd-level walkways lying below and parallel to the guideway structure. This station would provide access to the downtown retail core of Jacksonville and historic Hemming Plaza. The walkway system would be built to connect individual buildings on both sides of Hogan Street and to a skywalk system proposed in development plans of the Downtown Development Authority (DDA).

The guideway would proceed south from the Hemming Plaza Station and, as it approached Bay Street, the guideway would turn west into Bay Street on the south side of the right-of-way and connect with the Central Station. The distance between the Central and Hemming Plaza Stations would be 1,275'. The Central Station would provide access to the Northbank Project, Independent Life Building, and the Civic Auditorium. The Central Station would be accessible primarily to pedestrians via an elevated walkway system. However, there would also be a shuttle bus transfer zone.

From the Central Station, the line then would follow the south side of Bay Street west, pass over Broad Street, and turn southwest to the Jefferson Street Station. The distance between the Central and Jefferson Street Stations would be 1,580'. The Jefferson Street Station would be bounded by Jefferson, Broad, and Bay Streets and the Seaboard Coastline Railroad property. It would provide access to the proposed twin office towers of the Seaboard Coastline, the new Federal Reserve Building, and Jacksonville's Federal Office Building.

PLAN AND PROFILE

AUTOMATED TRANSIT ALTERNATIVE

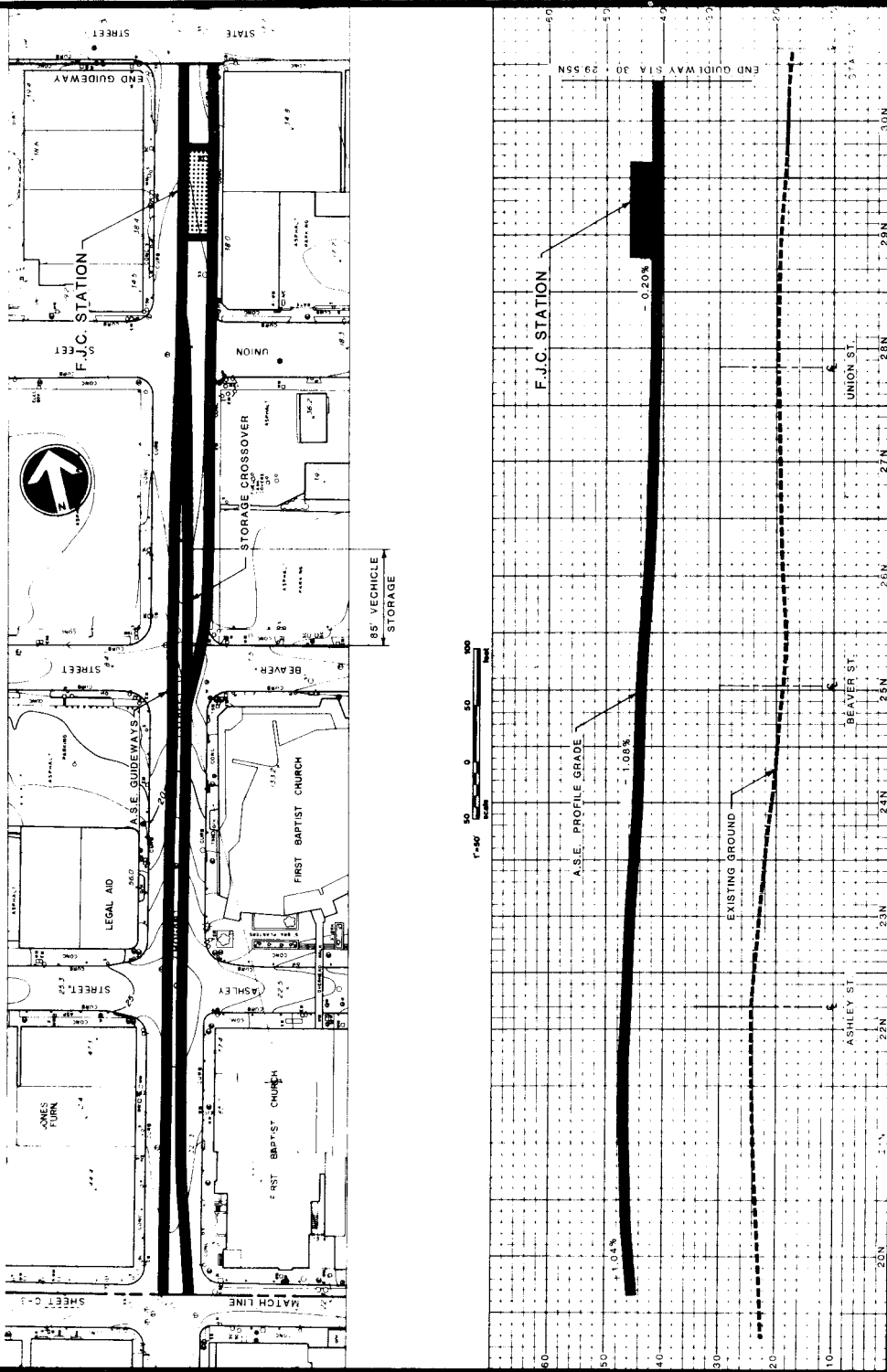

HOGAN STREET (STATE TO CHURCH STREETS)

FIGURE 3-3

PLAN AND PROFILE

AUTOMATED TRANSIT ALTERNATIVE

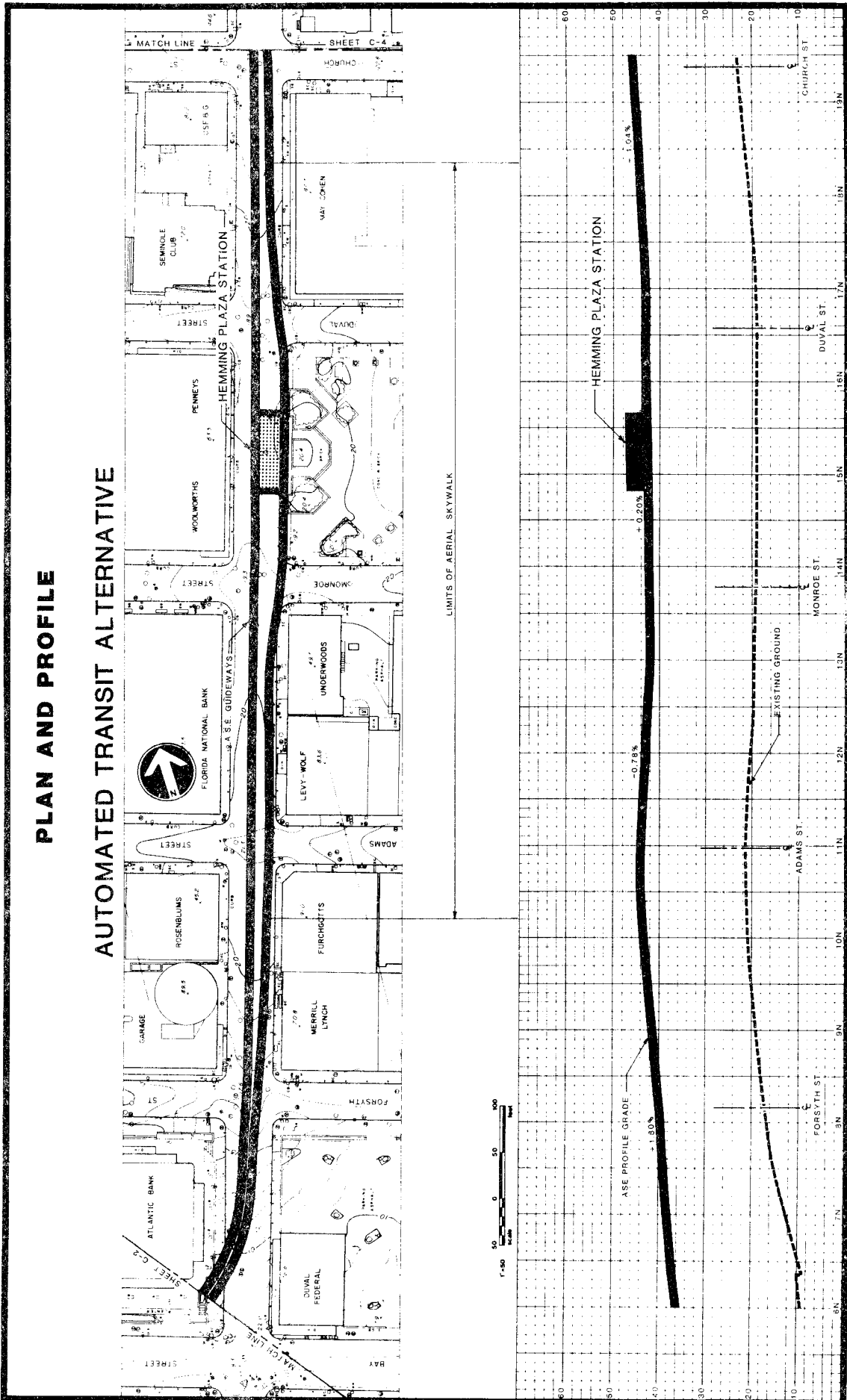

HOGAN STREET (CHURCH TO BAY STREETS)

FIGURE 3-4

PLAN AND PROFILE

AUTOMATED TRANSIT ALTERNATIVE

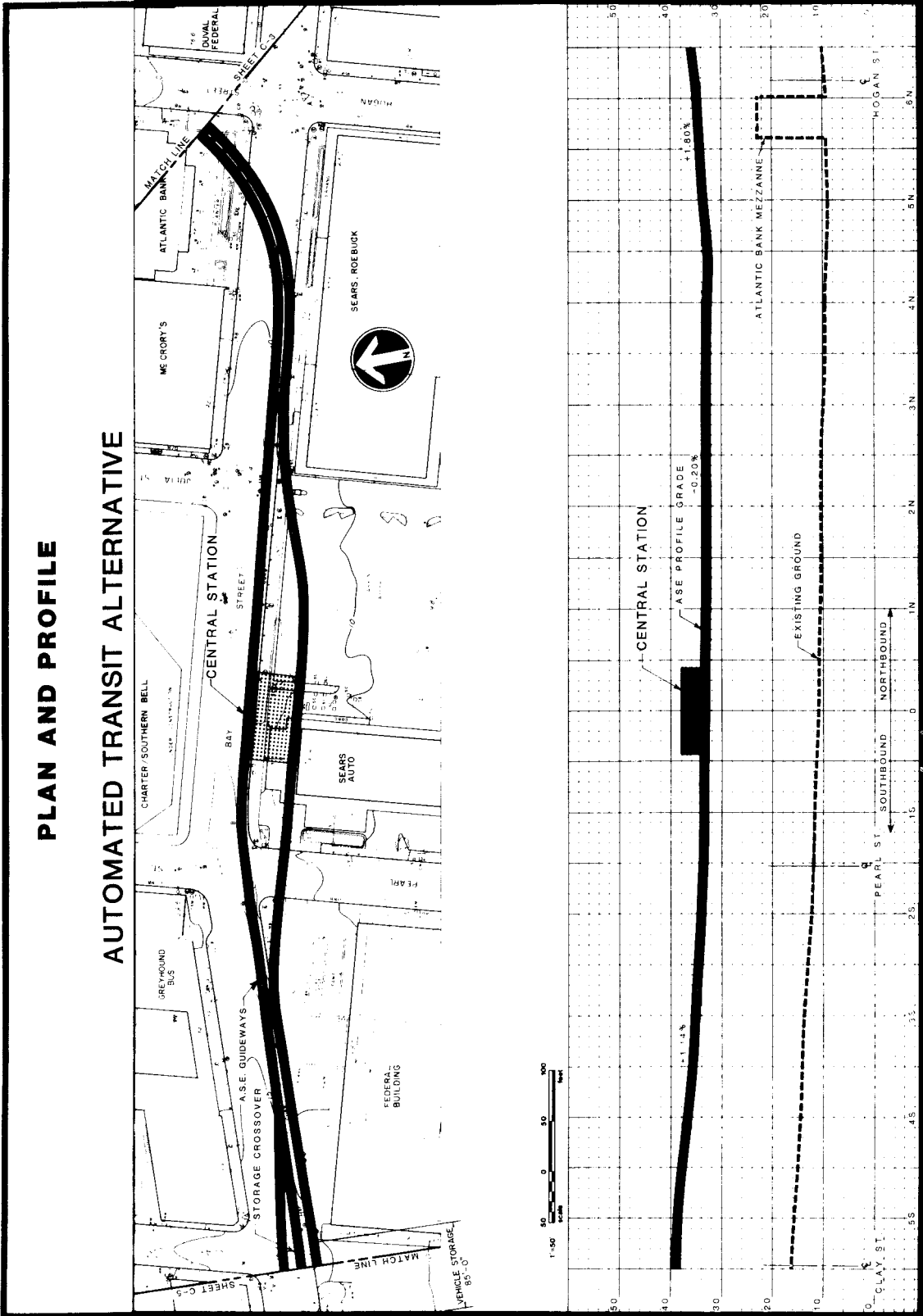

BAY STREET (HOGAN TO CLAY STREETS)

FIGURE 3-5

PLAN AND PROFILE

AUTOMATED TRANSIT ALTERNATIVE

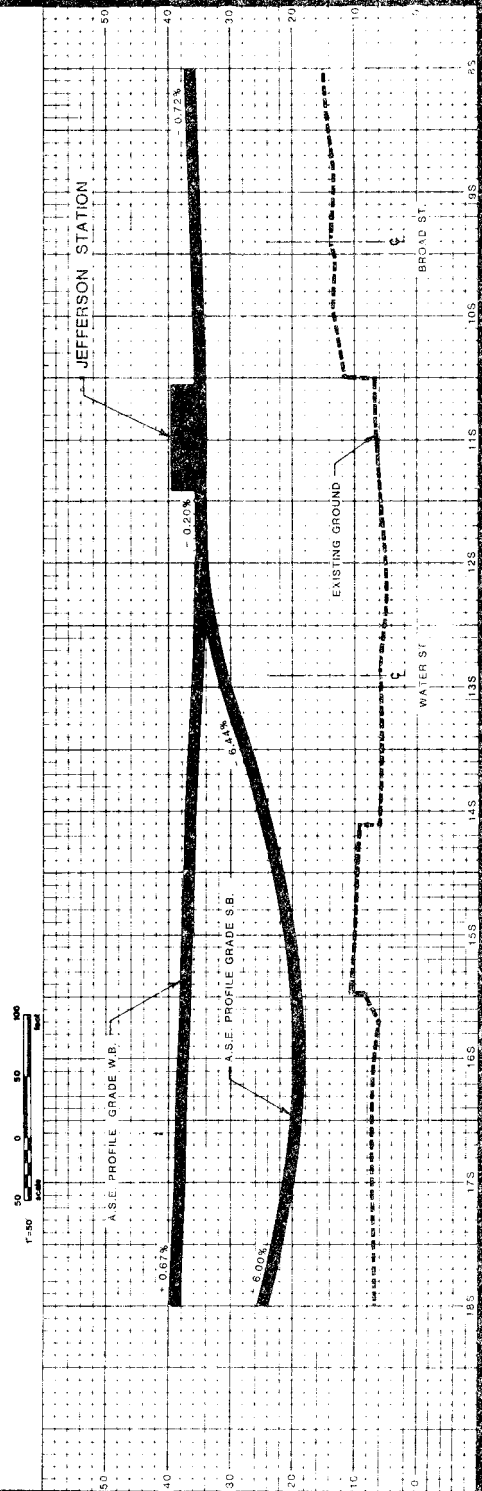
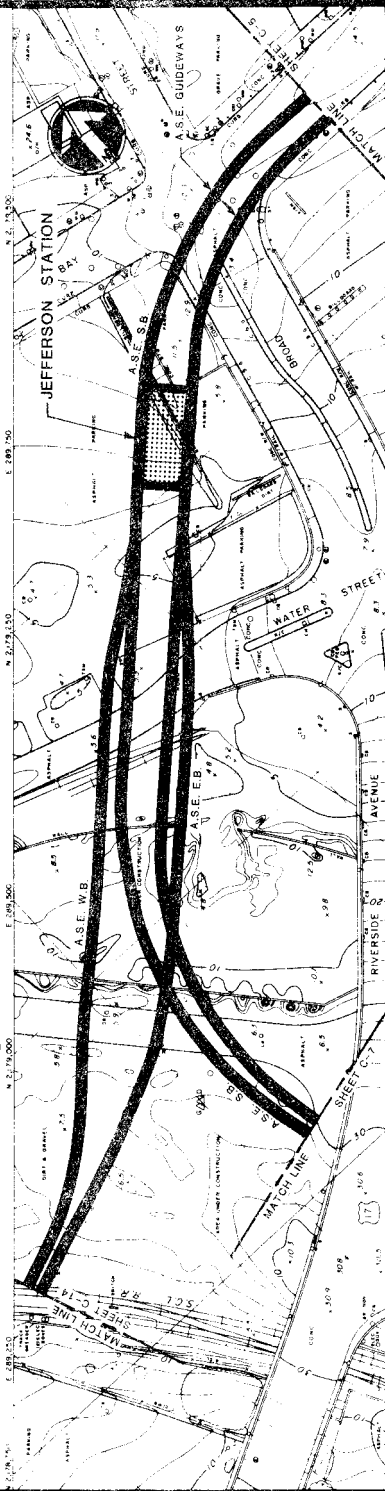

JEFFERSON STREET (BROAD STREET TO SCL RR)

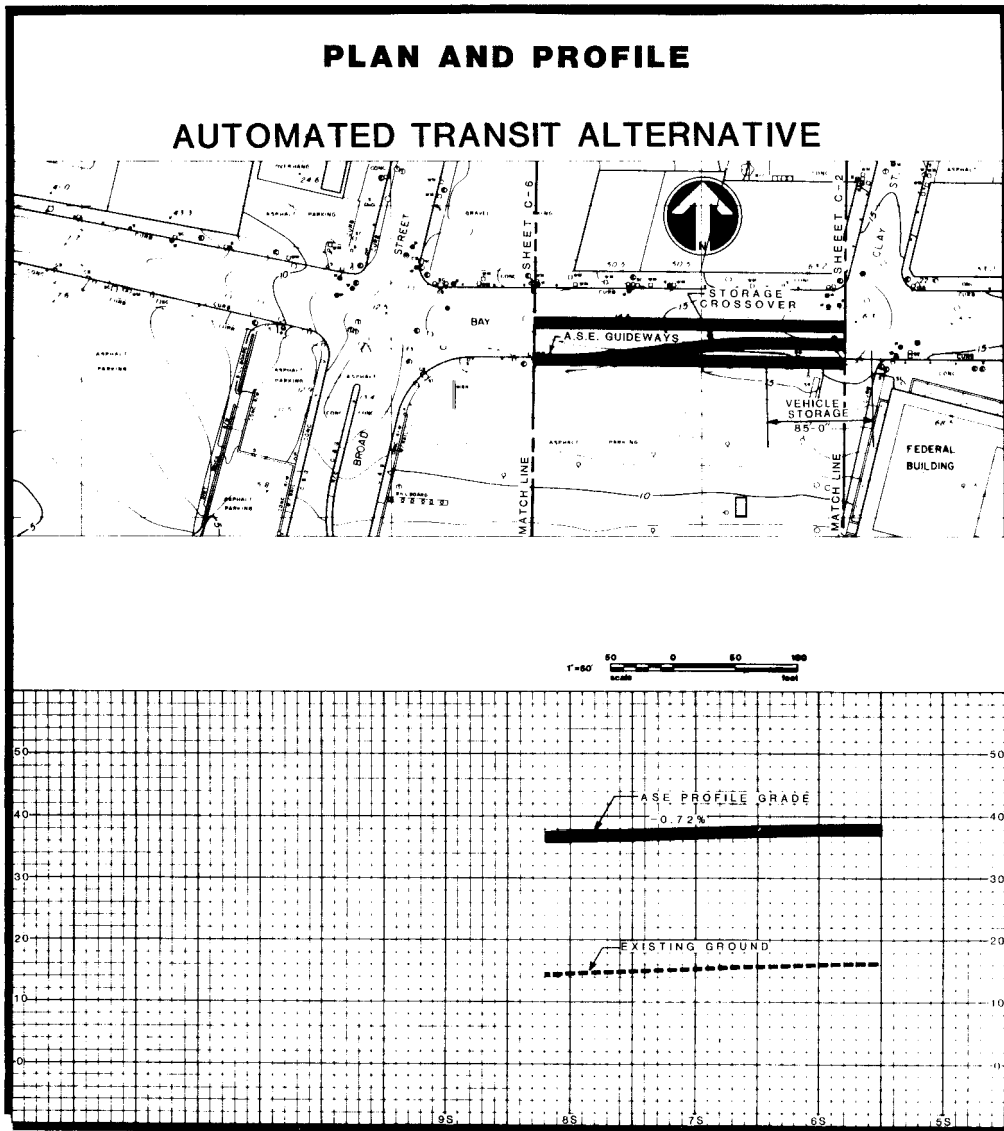

FIGURE 3-7

BAY STREET (CLAY TO BROAD STREETS)

PLAN AND PROFILE

AUTOMATED TRANSIT ALTERNATIVE

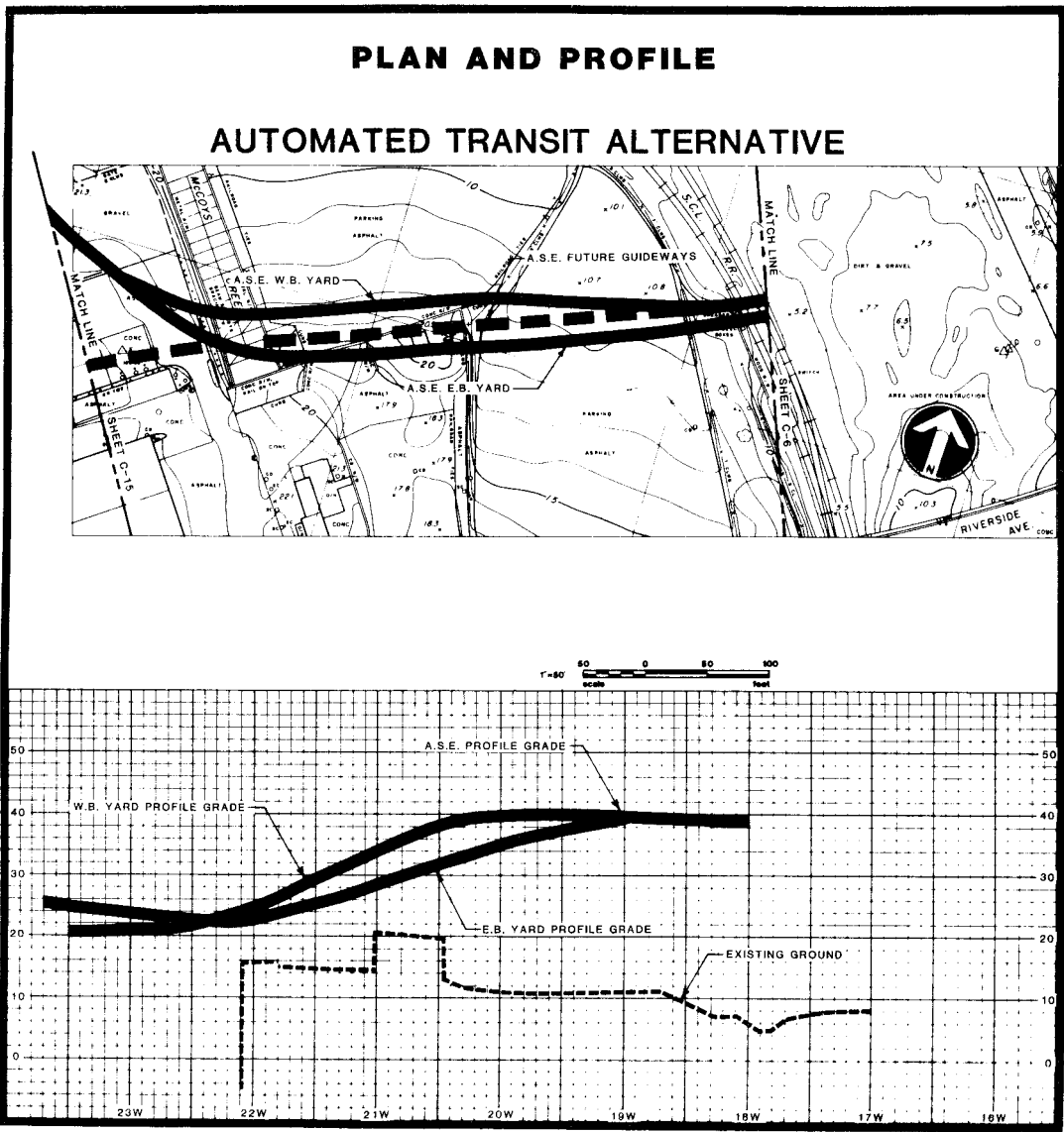

FIGURE 3-8

MAY STREET (SCL RR TO CMSA)

PLAN AND PROFILE

AUTOMATED TRANSIT ALTERNATIVE

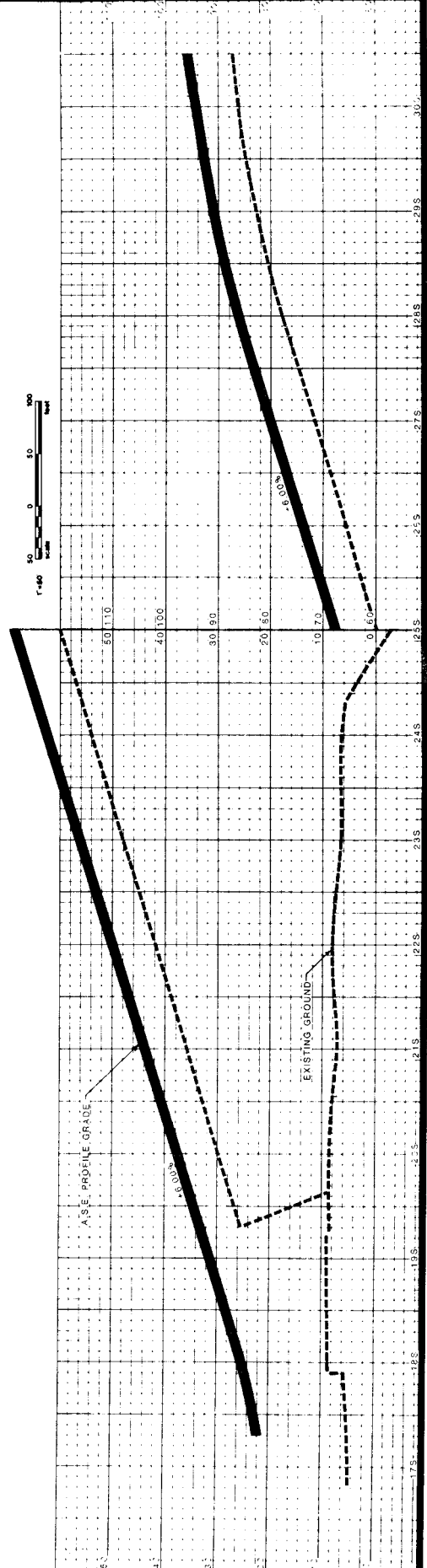
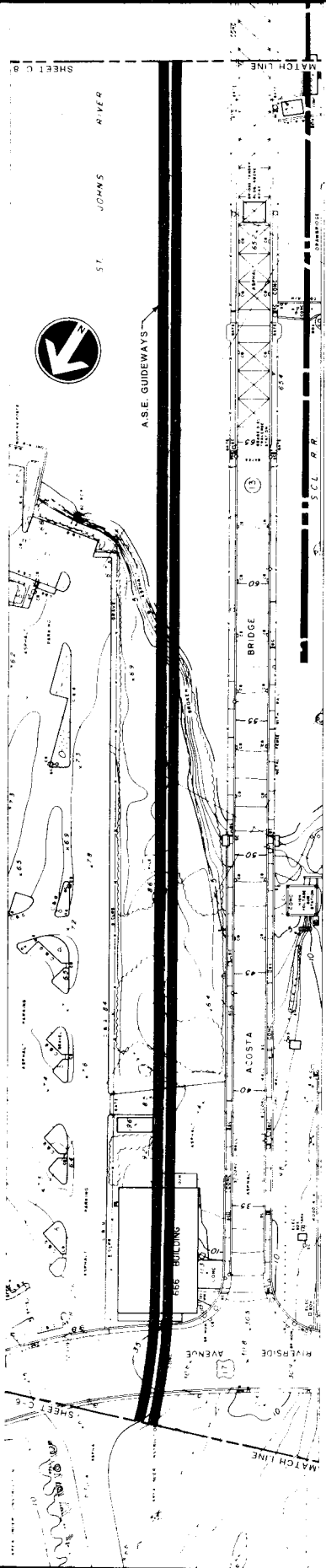

FIGURE 3-9

ACOSTA BRIDGE (RIVERSIDE)

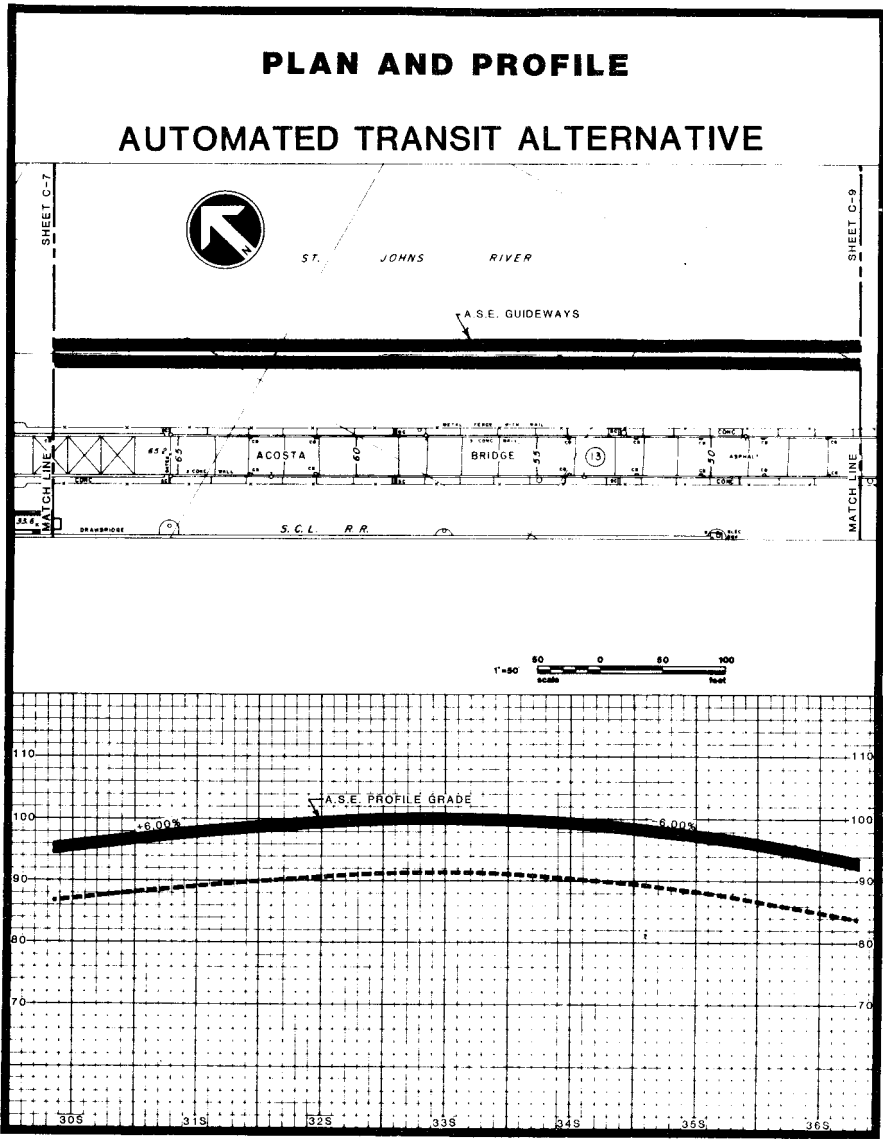
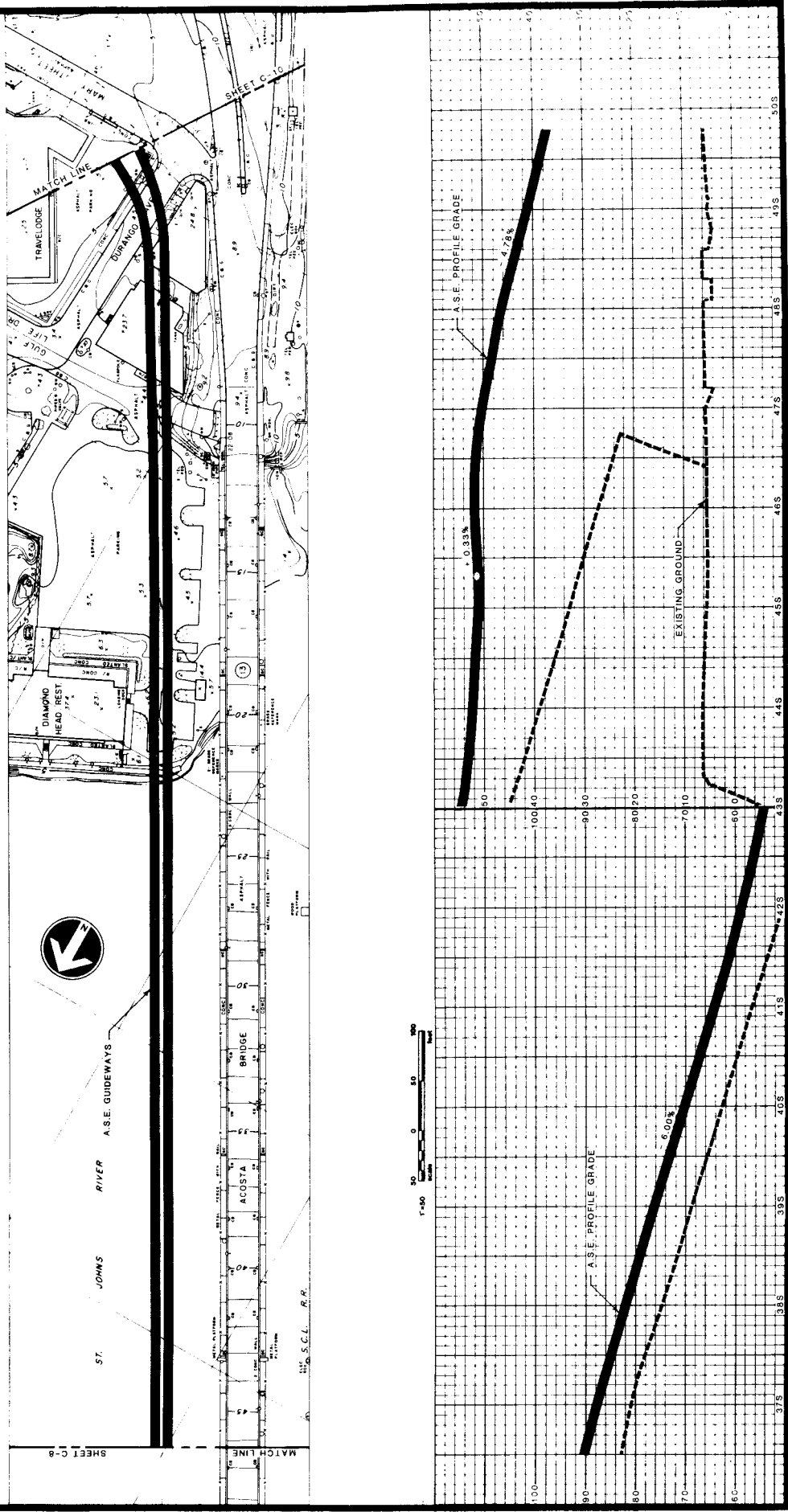

FIGURE 3-10

ACOSTA BRIDGE (CENTER)

PLAN AND PROFILE

AUTOMATED TRANSIT ALTERNATIVE



ACOSTA BRIDGE (SOUTHSIDE)

FIGURE 3-11

PLAN AND PROFILE

AUTOMATED TRANSIT ALTERNATIVE

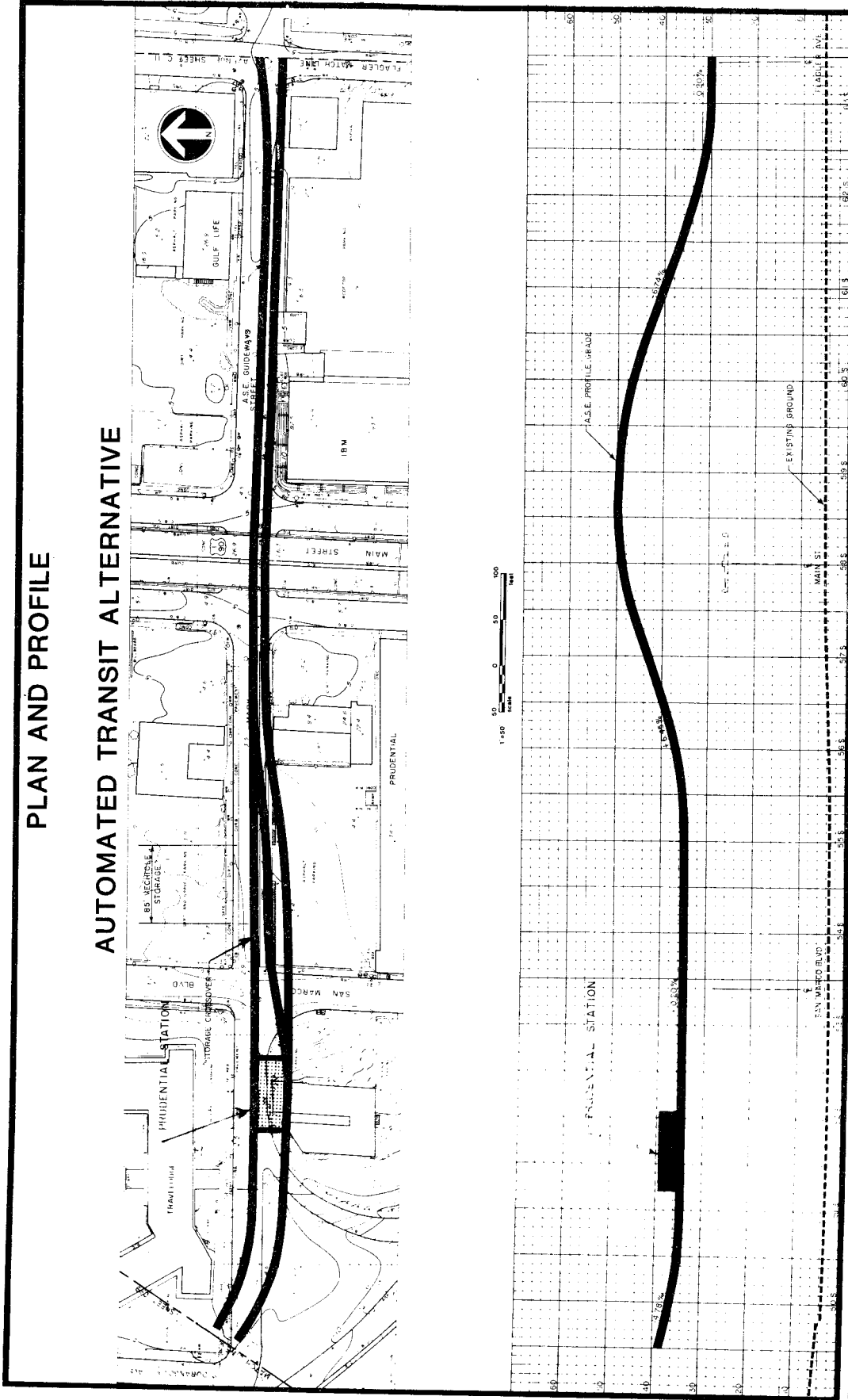

FIGURE 3-12

MARY STREET (ACOSTA BRIDGE TO FLAGLER STREET)

PLAN AND PROFILE

AUTOMATED TRANSIT ALTERNATIVE

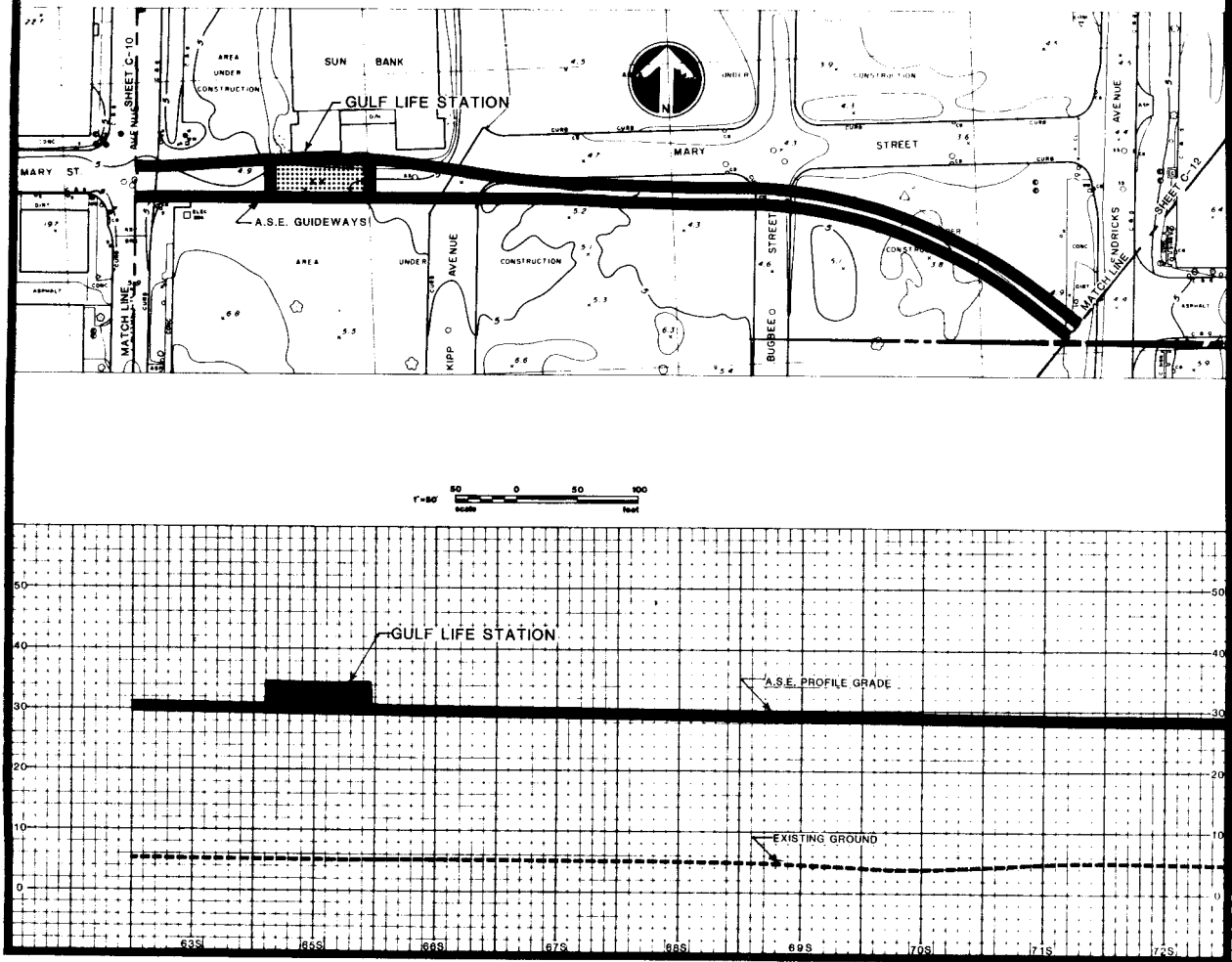

FIGURE 3-13

MARY STREET (MAIN STREET TO HENDRICKS AVENUE)

PLAN AND PROFILE

AUTOMATED TRANSIT ALTERNATIVE

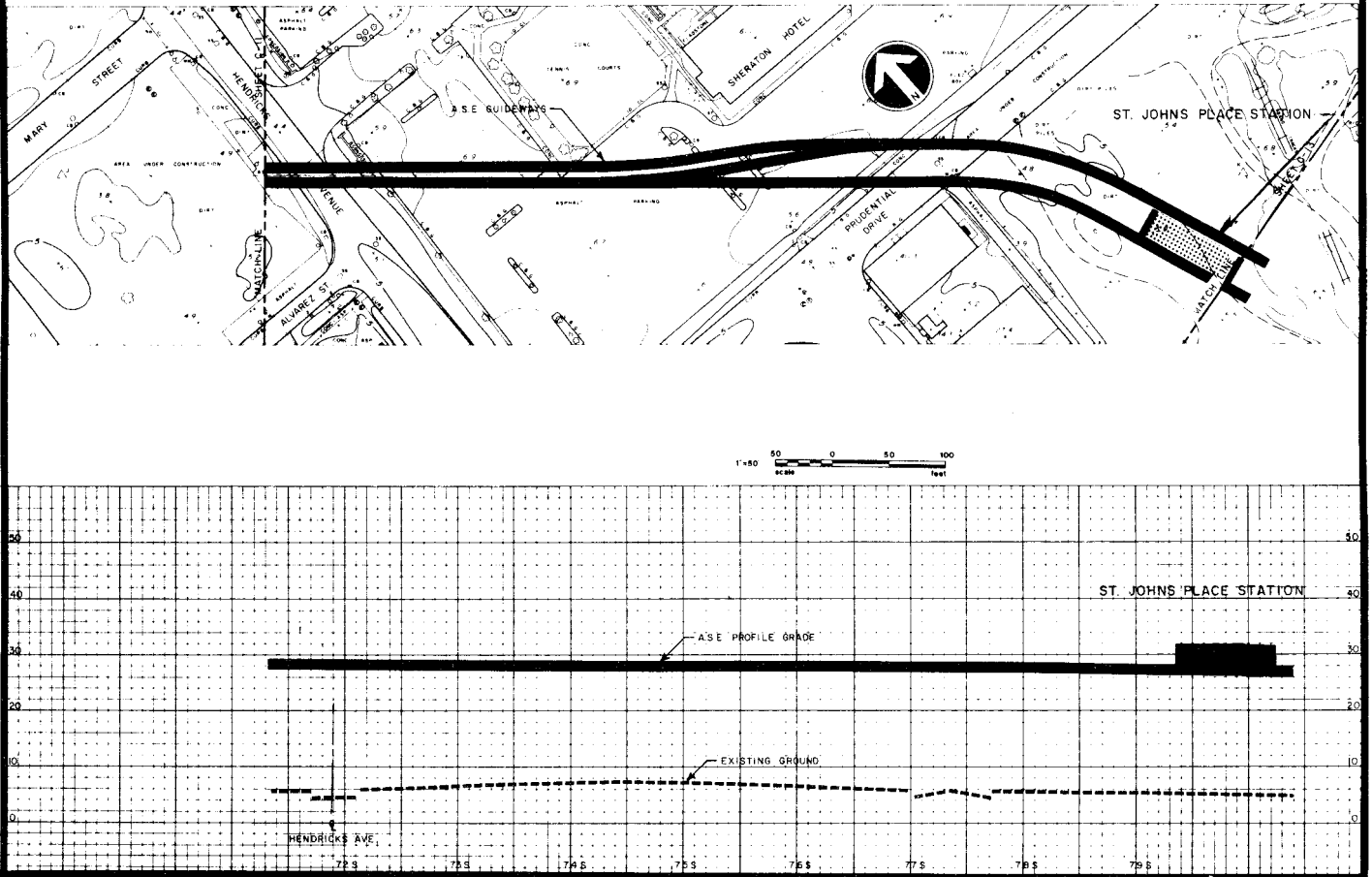

FIGURE 3-14

HENDRICKS AVENUE TO ST. JOHNS PLACE

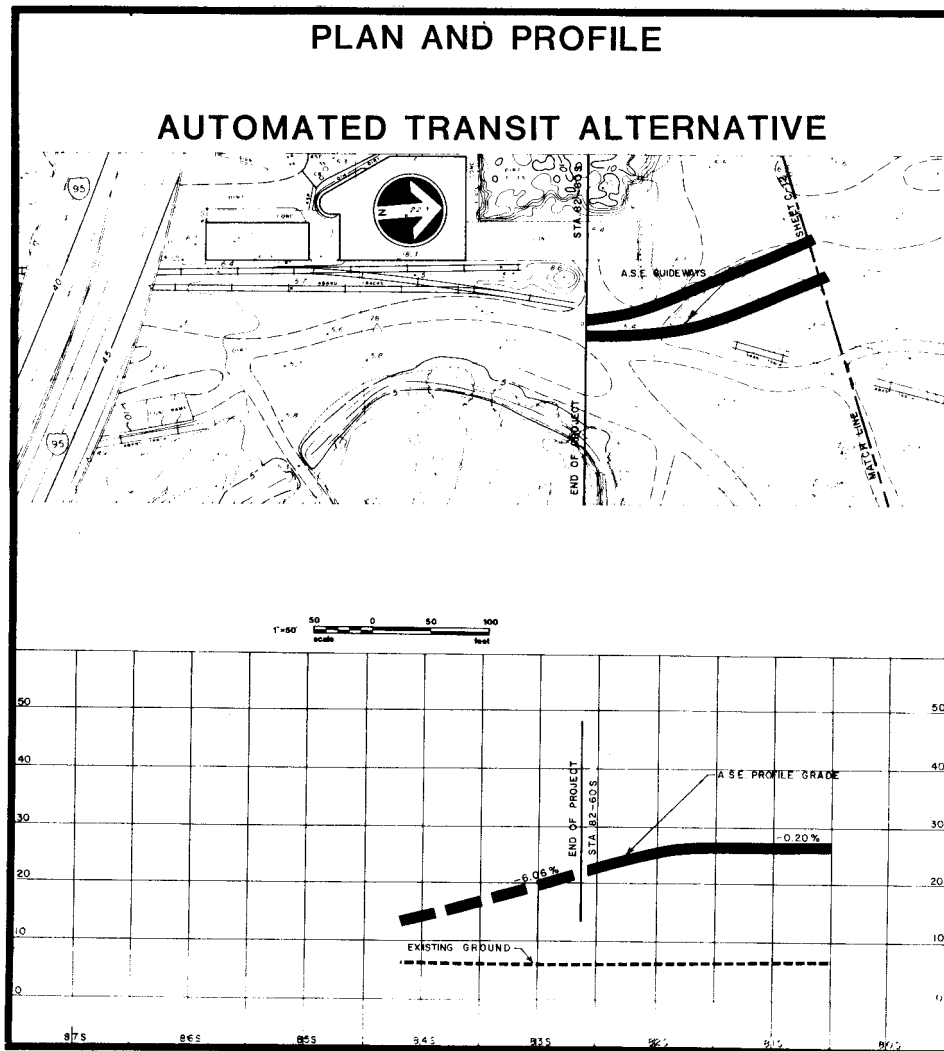

FIGURE 3-15

SOUTH TERMINAL

An elevated dual guideway would proceed southwest from the Jefferson Street Station, separate from the main line, and pass over the railroad lines and enter the old JTA Bus Maintenance and Storage Area. The Control, Maintenance, and Storage Area (CMSA) for the JASE would include a 1,100' guideway to be used as a storage lead, all routine maintenance facilities, equipment, the initial stock of spare parts, and the vehicle storage yard. The Systems Control Facility, together with all necessary communications, computer, and control equipment, would be placed here.

The main line of the elevated dual guideway would proceed from the Jefferson Street Station, rise, and turn southeastwardly into the center of the reconstructed vehicular Acosta Bridge and cross the St. Johns River. As it approached the south foot of the Acosta Bridge, it would turn eastward into the south side of the Mary Street right-of-way and stop west of San Marco Boulevard at the Prudential Station. This link distance would be 3,350'. This would be an urban station adjacent to the proposed Prudential office building. The line would leave the Prudential Station, rise over the Main Street viaduct, and travel 1,070' to the Gulf Life Station, an urban station located on the north side of Mary Street just east of Flagler Street. The line would then curve 1,665' southeastward to the St. Johns Place Station to be located just south of Prudential Drive behind the property fronting on King Street. Here, the line would terminate at an intermodal station with associated parking for 3,000 cars. The outbound (east) guideway would extend 150' further for switchback and storage purposes.

Structural Design

The JASE would use elevated guideways throughout its operational lines. In order to elevate the guideway, three types of guideway support systems were chosen. Figure 3-16 shows the first of these -- a hammer-head design supporting two adjacent guideways on a single pier. This type of guideway support would be used where there are infrequent street crossings or the system travels in an undeveloped area. The piers would be spaced approximately 70' apart and the guideways themselves would be supported by box girders between the piers. The second type of guideway support system is in the form of two single piers. Figure 3-17 shows such a pier system with a walkway. This type of support system would be used wherever there are frequent street crossings or where a walkway is necessary to increase the access from surrounding development to the station. The guideway normally would be sufficiently high to provide a minimum of 17' clear span when crossing streets. Where a walkway would be introduced into the system, the guideways would separate allowing the walkway to rise between them while maintaining a constant elevation on the guideway. The 2-pier support system would also be used at approaches to stations. The third type is located at stations where the guideway support system will take on the form of an H, two single smaller piers connected by a horizontal member would support the floor of the mezzanine level of the station, as shown in Figure 3-18. The approaching walkways would pass between the legs of the joined piers into the mezzanine.

TYPICAL GUIDEWAY

IN STREET
WITHOUT SKYWALK

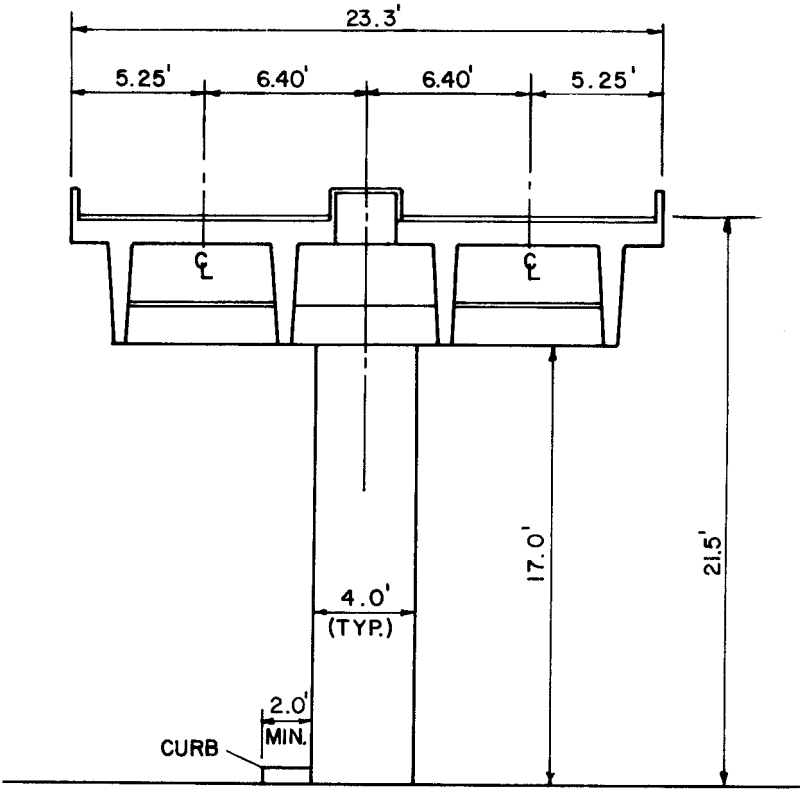

FIGURE 3-16

TYPICAL GUIDEWAY

TYPICAL GUIDEWAY

CROSSING STREET WITH SKYWALK

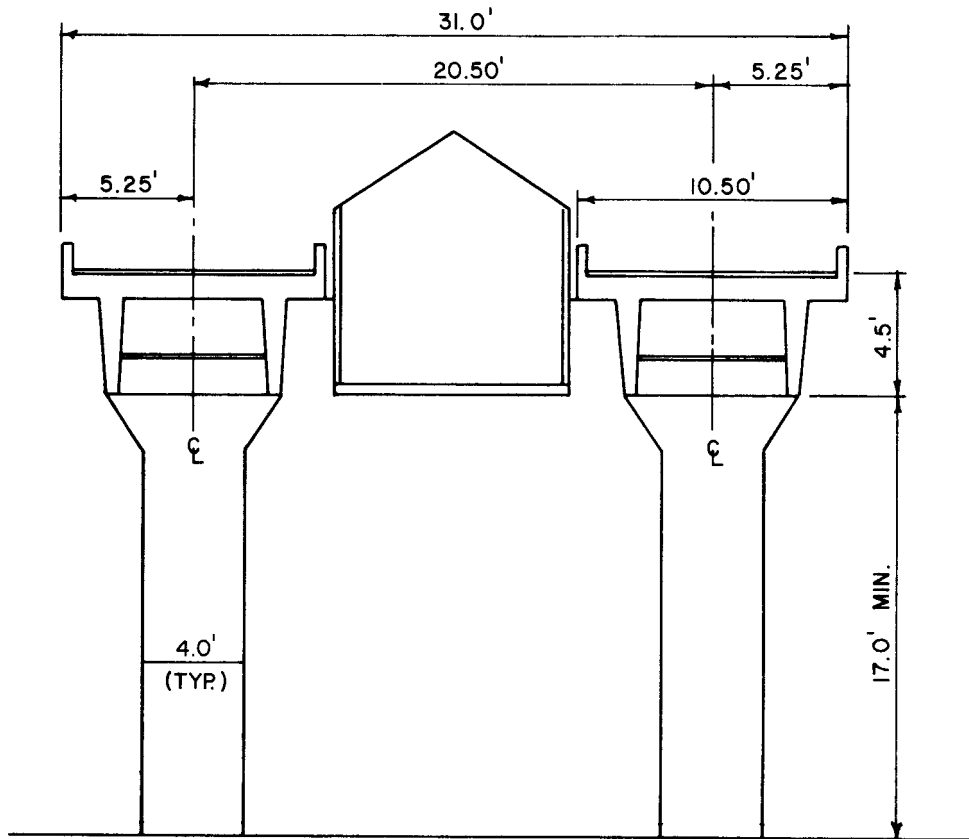
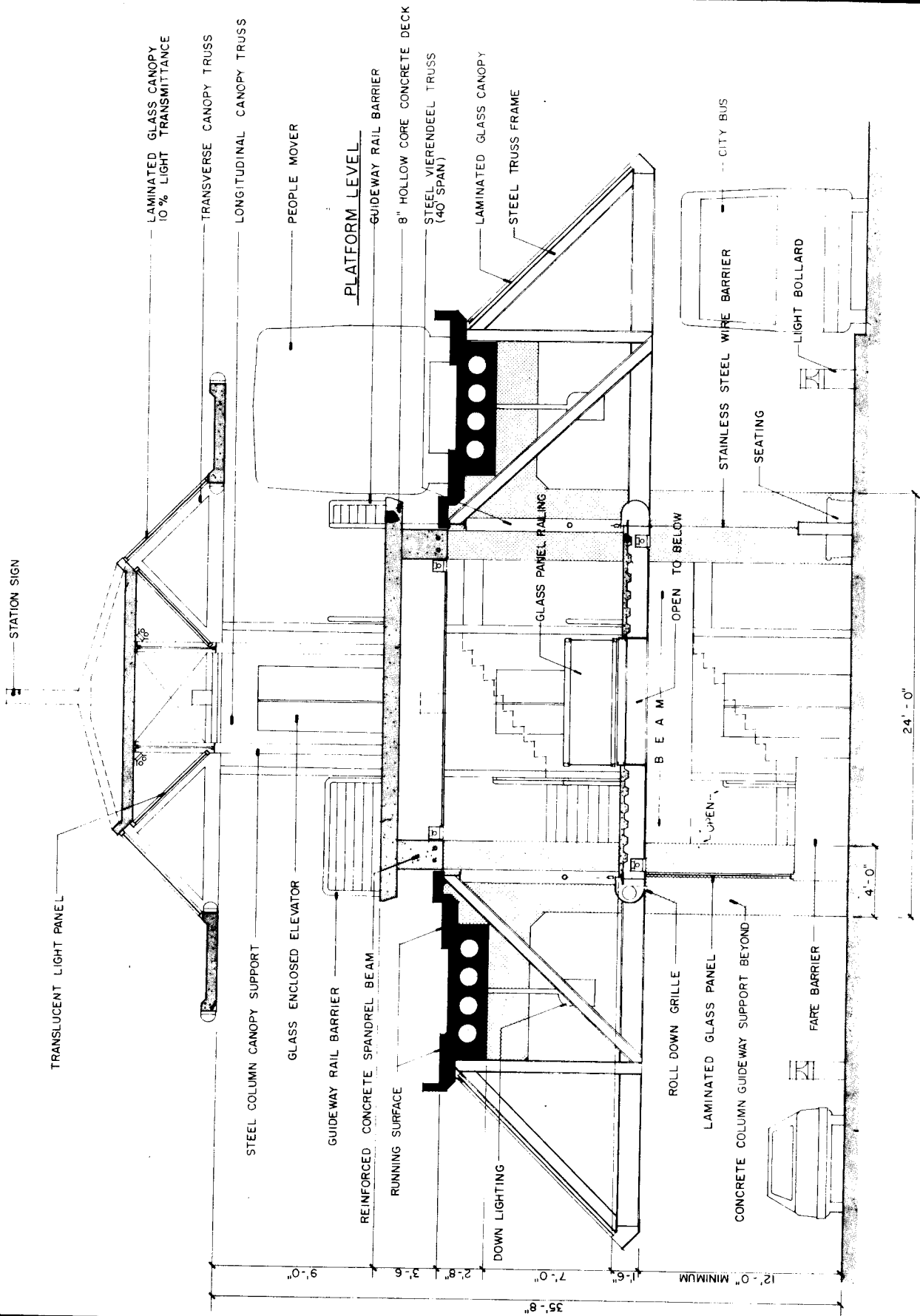

FIGURE 3-17

TYPICAL GUIDEWAY

TYPICAL GUIDEWAY AT STATIONS



TYPICAL GUIDEWAY

FIGURE 3-18

For design purposes, the axle spacing, axle loading, and vehicle spacing would be as shown in Figure 3-19. For deflection, stress, and strength considerations, the vehicle live load would consist of the loads associated with the vehicle loaded to "crush" capacity (see Table 2-9).

The live loads would be applied to realistically represent the actual vehicle load distribution on the guideway structures. Consideration would be given to consist size, vehicle axle spacings, number of axles, magnitude of wheel loadings, and wheel track spacings. Any combination of vehicle loadings, static or dynamic, which produced the critical live loading, would be used for structural design.

Aesthetic Design

The JASE stations, guideways, and facilities will be attractive, inviting, well-lighted, easily cleaned and serviced and, above all, planned with circulation patterns and layouts to enable unassisted movement of vehicles and people in an easy and safe manner. The facilities will be designed such that there are no architectural barriers to prevent access by, and mobility of, the elderly and handicapped.

Transit system lines offer inherent sensory experiences not often found in large-scale building projects. The patron is a captive audience moving through space at high speeds; experiencing transitions and viewing the stations, the line sections, and the many diverse elements within the surrounding exterior environment. The patron entering or exiting the system, and the non-patron, will be subject to the more traditional visual and audio sensations. All transit structures will impart the feelings of dependability, speed, and efficiency which are inherent in a contemporary ASE System. Examples of the designs incorporating these aesthetic features are given in Figures 3-20 and 3-21.

Switches and Turnbacks

The JASE vehicles will travel from one end of each line to the other on independent guideways. This means the elimination of conflict between vehicles traveling in opposite directions and assures convenient, frequent, and uninterrupted service for patrons of the system.

At the ends of the lines, however, it will be necessary to move vehicles from one guideway to the other before making the return trip in the opposite direction. This will be accomplished through same type of at-grade switching mechanism similar to the examples shown in Figure 3-22.

Turnbacks at the ends of the lines will move vehicles from one guideway to the other through switches located ahead of the station so passengers may be unloaded and loaded on the outbound guideway side of the platform. See Figure 3-23. Switches may also be located at intermediate points on the lines to provide crossover points for vehicles in case of breakdowns or for temporary storage of vehicles during off-peak periods.

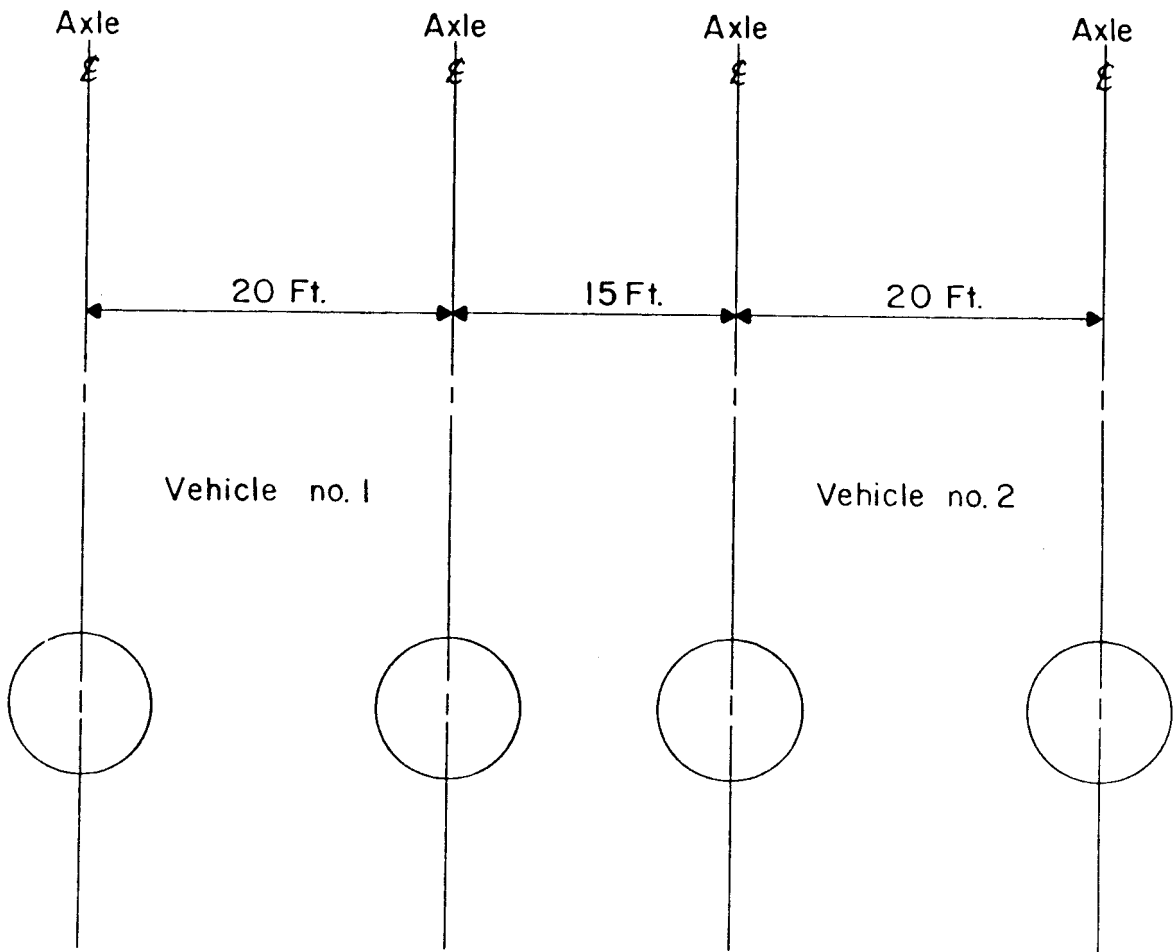

NOTE: For vehicle weights see table 3-A

FIGURE 3-19

VEHICLE LOADING DIAGRAM

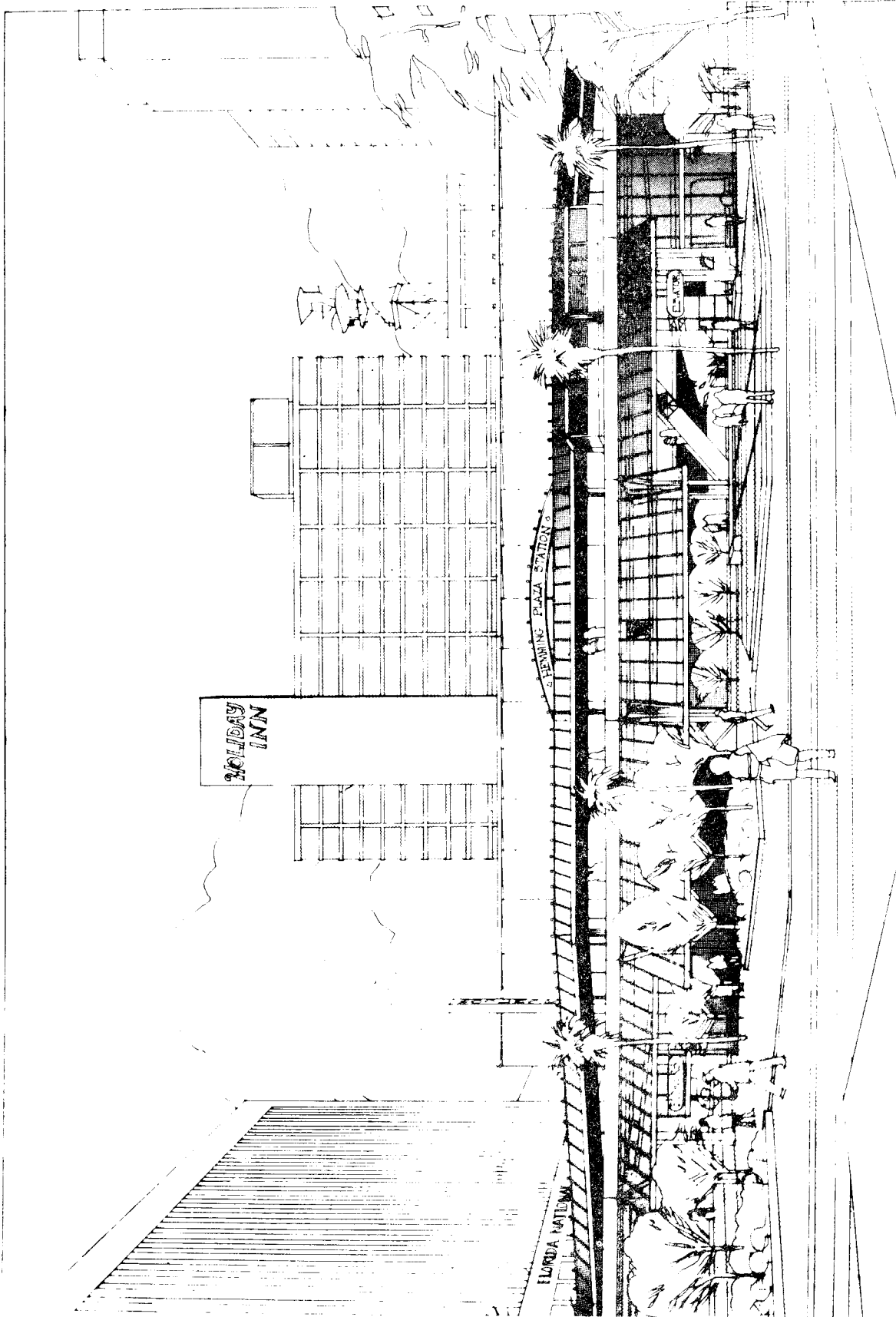

PERSPECTIVE OF HEMMING PLAZA STATION

FIGURE 3-20

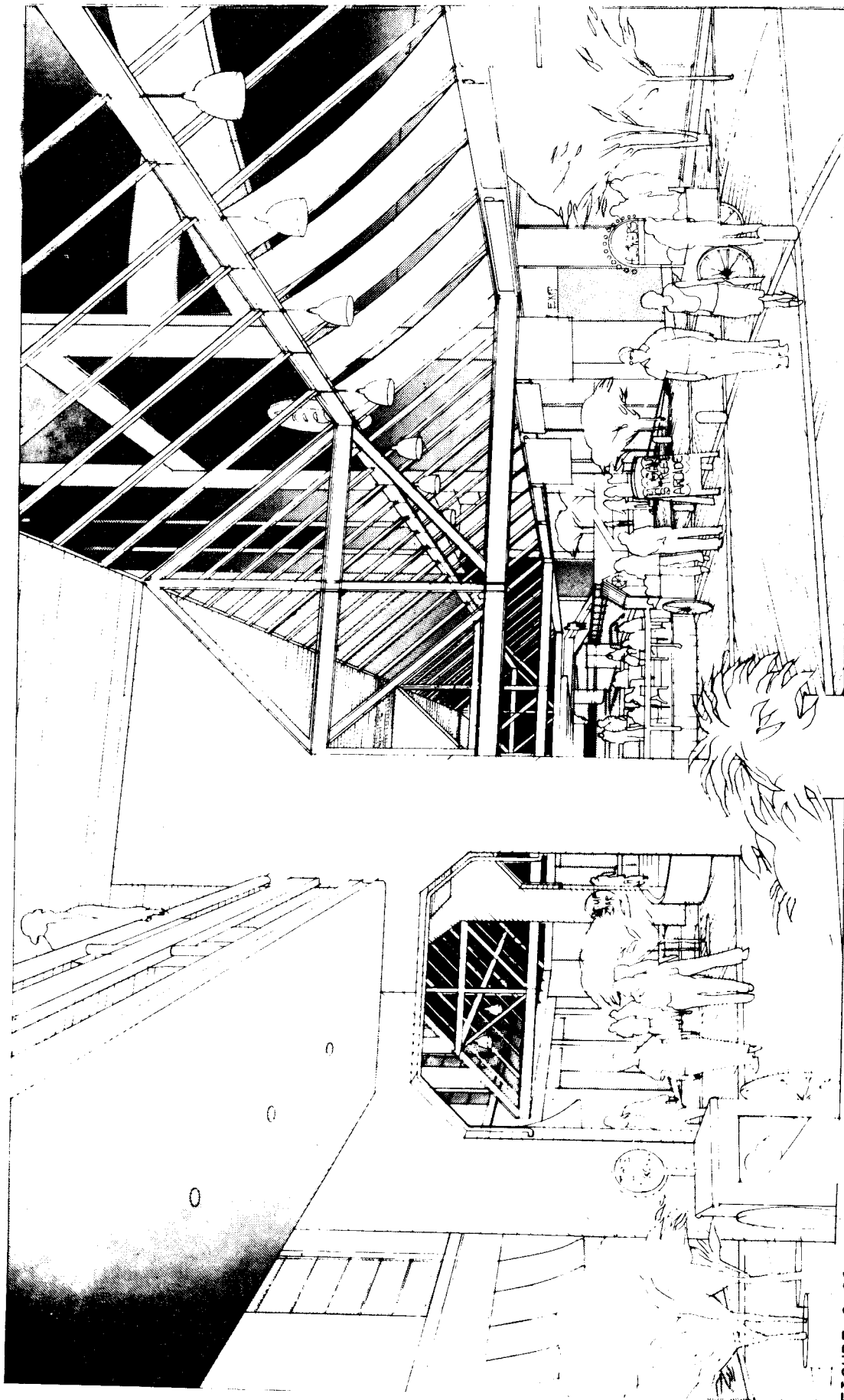

DEVELOPMENT UNDER HOGAN STREET GUIDEWAY

FIGURE 3-21

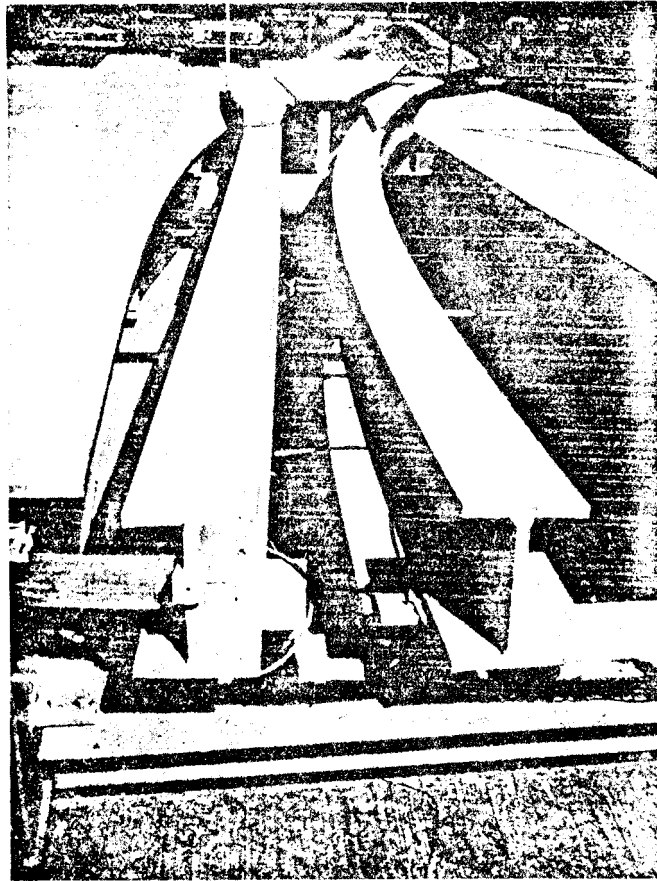

GUIDE BEAM-TYPE SWITCH

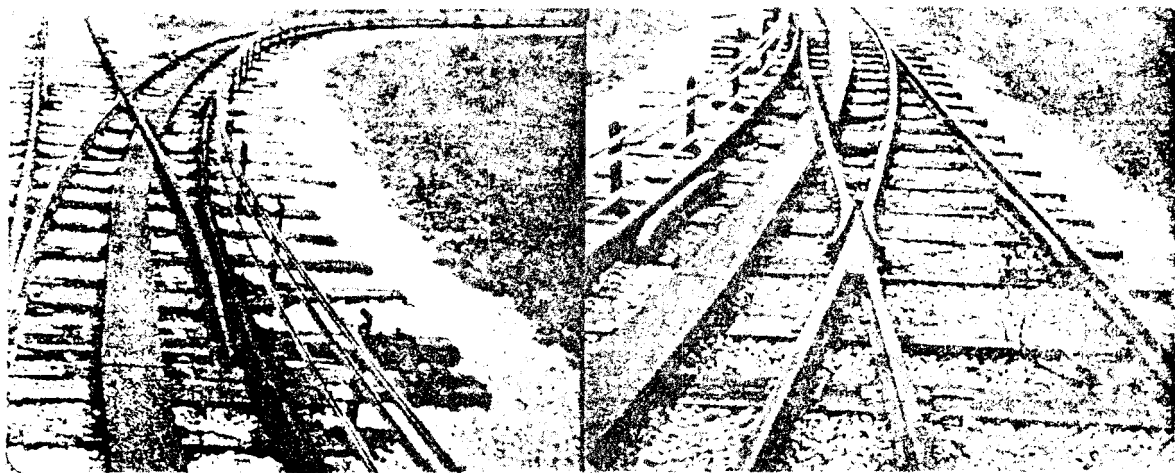

RAIL-TYPE SWITCH

FIGURE 3-22

TYPICAL SWITCHES

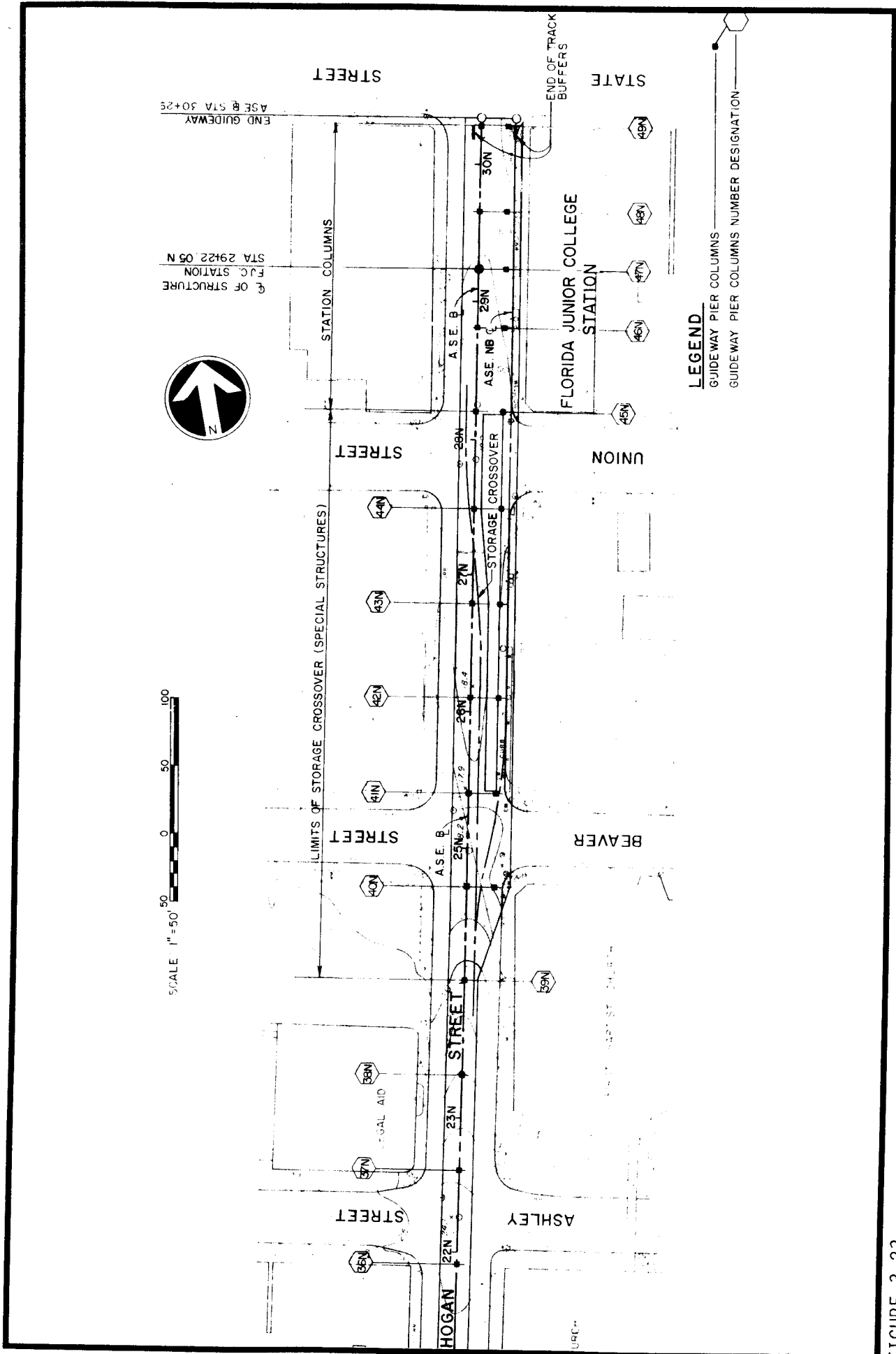

TERMINAL STATION TURNBACK

FIGURE 3-23

Soils Investigations and Foundation Design

Soils investigations included 14 structural borings taken along the proposed route of the 4.4-mile JASE System and a thorough review and compilation of some 3,500 geotechnical explorations completed in the Jacksonville area.

The subsurface soil and rock strata generally found along the JASE alignment consists of an upper layer of overburden soil consisting of loose-to-firm sands or sandy rubble fill which grades into a firm-to-dense fine sand, slightly silty fine sand, or slightly clayey fine sand. These sands generally become increasingly clayey with depth until the underlying limestone formation is encountered. In some areas, a deep deposit of soft-to-firm blue-gray silty clay is encountered directly above the limestone. These overburden soils generally vary in thickness from approximately 25' to 70' along the alignment. The limestone consists of partially-cemented to well-cemented calcareous silty fine sand often with shell fragments and is usually interbedded with loose sand or soft clay layers. An upper, very dense, well-cemented limestone caprock layer is sometimes associated with the underlying limestone foundation. In some areas, the limestone layer is very thin or non-existent. Below the limestone, a deep deposit of hard to very-hard clayey or sandy silt (locally termed marl; Hawthorne Formation) is encountered. This deposit generally extends several hundred feet below the ground surface.

The groundwater level generally fluctuates from an elevation slightly greater than mean sea level (MSL) to over +5' MSL. The groundwater levels are subject to seasonal climatic changes, construction activity, surface water runoff, and tidal fluctuations in the St. Johns River. A pictorial outline of the surface geology along the JASE alignment is shown in Figure 3-24. The generalized subsurface profile of the south half of the river crossing alternate is displayed in Figure 3-25.

Recommended foundation design for the River Crossing Alternative has been divided into 3 types reflecting the underlying soil types and conditions revealed in the geotechnical study.

Structure foundations for the FJC Station and the stations and alignment on Hogan and Bay Streets would be supported by either drilled shaft or auger-grouted pile systems. The Jefferson Street and Prudential Stations and the intervening guideway approaches to the reconstructed Acosta Bridge, including the spur to the CMSA yard, would be supported on a deeper, driven-pile foundation system. Soil conditions along Mary Street to the Gulf Life Station, and from there to the terminal station at St. Johns Place, will permit the use of spread footings following appropriate site preparation work.

Utility and Street Renovations

The determination of possible utility adjustments involved the location

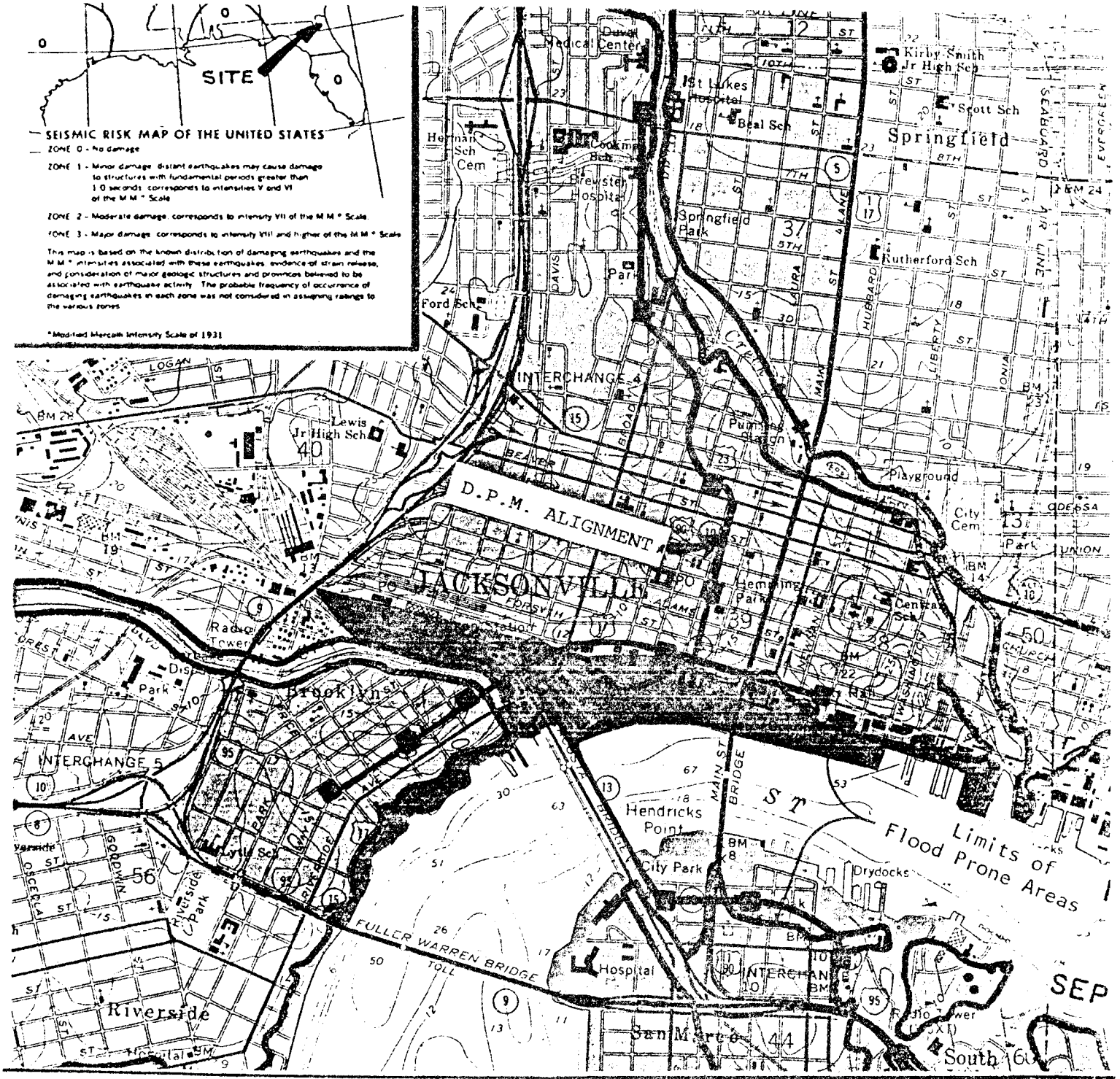

SEISMIC RISK MAP OF THE UNITED STATES

ZONE 0 - No damage

ZONE 1 - Minor damage: distant earthquakes may cause damage to structures with fundamental periods greater than 1.0 seconds; corresponds to intensities V and VI of the M.M. Scale

ZONE 2 - Moderate damage: corresponds to intensity VII of the M.M. Scale

ZONE 3 - Major damage: corresponds to intensity VIII and higher of the M.M. Scale

This map is based on the known distribution of damaging earthquakes and the M.M. intensities associated with these earthquakes, evidence of strain release, and consideration of major geologic structures and provinces believed to be associated with earthquake activity. The probable frequency of occurrence of damaging earthquakes in each zone was not considered in assigning ratings to the various zones.

*Modified Mercalli Intensity Scale of 1931

LEGEND

NOTE: See following detailed soil descriptions.

- 1** Grey, yellow, brown fine sand
- 2** Mixed flood plains soil, silty fine sand, peat
- 3** Man-made landfill over river deposits

SURFACE GEOLOGY MAP	
Downtown People Mover Project	
Jacksonville, Florida	
DRAWN: JMG	
CHECKED: GTM	JOB NO.: J-3168A
DATE: 2/12/81	SCALE: 1"=2000' (Approx)
LAW ENGINEERING JACKSONVILLE, FLORIDA	
SURFACE GEOLOGY MAP	

FIGURE 3-24

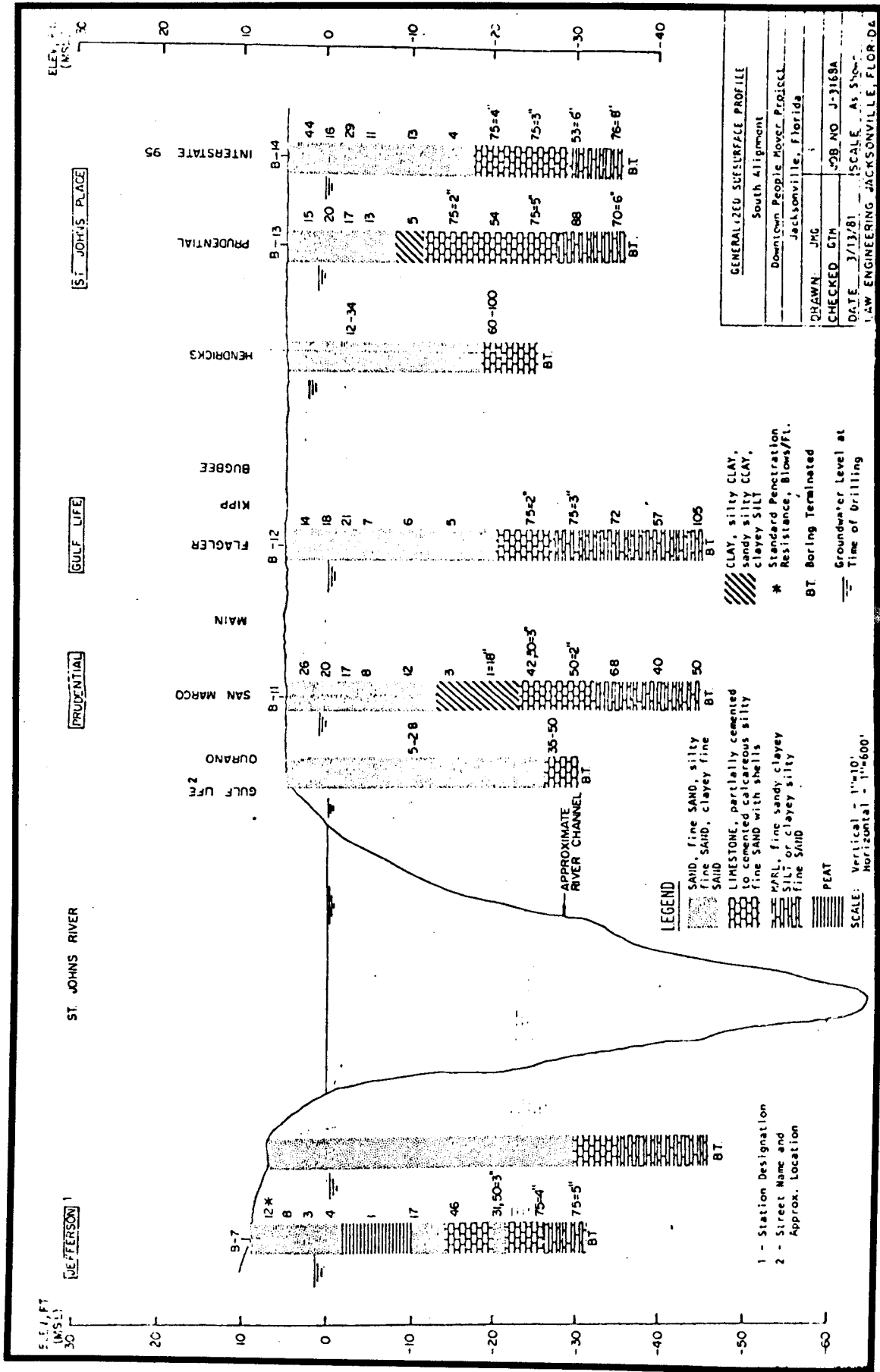

FIGURE 3-25 GENERALIZED SUBSURFACE PROFILE

of utilities through review of plans obtained from the utility companies. By way of correlating the physical location of manholes with the alignments provided by the utility company maps, a set of utility maps was prepared. A preliminary judgment about utilities to be relocated was based upon the proposed location of guideway piers relative to utility locations.

The north side of the St. Johns River contains the heavier concentration of underground utilities and, therefore, the larger number of potential relocations. Underground telephone and electric cables, sanitary sewers, and gas pipelines would be affected moderately while water mains, storm sewers, and underground Western Union cables would be affected only slightly.

On the south side of the St. Johns River, water mains, gas pipelines, underground telephone and electric cables occur in much lower density and would be only minimally affected.

If practical, JASE foundations would be moved or specifically designed to minimize relocation costs. Prior to final design of the facilities, meetings would be held with the appropriate utility companies to obtain comments and cost estimates. Adjustment to foundation design and locations would be made following receipt of comments from the utility companies.

The utility companies that would be affected by construction of the JASE are listed following according to area of responsibility.

- * Jacksonville Electric Authority (electric)
- * Jacksonville Public Works Department (sanitary sewers)
- * Jacksonville Public Works Department (storm sewers)
- * Jacksonville Public Works Department (water mains)
- * Peoples Gas Company (natural gas pipelines)
- * Southern Bell Telephone (telephone cables)
- * Western Union (telegraph lines)

Proposed utility relocations on Hogan, Bay, and Mary Streets are shown in Figures 3-26, 3-27, and 3-28.

Two major streets and one minor street would require renovations to accommodate construction of the JASE. These changes are:

- 1) Hogan Street would be closed between State and Union Street to permit construction of the FJC Station and associated bus interface and kiss-and-ride facilities.
- 2) The remainder of Hogan Street between Bay and Union Streets would be narrowed to 20' in width to serve as a 2-way local service road for commercial delivery and emergency vehicles. The area below the JASE in the eastern half of the street right-of-way would become a pedestrian mall with no vehicular traffic except at cross streets.
- 3) Bay Street would be narrowed in width between Hogan and Broad Streets to 3 lanes of 1-way traffic west (with no parking) by construction of

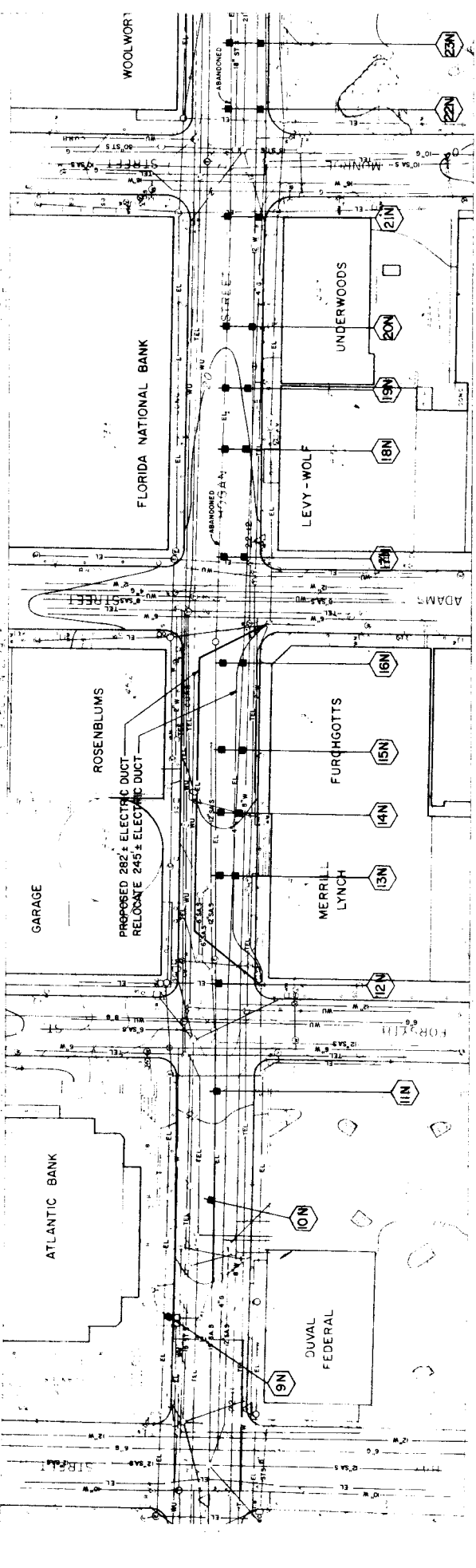

LEGEND

- | | | | |
|--|---|--|---------------------------------|
| | BUILDING | | WATER MANHOLE |
| | BUILDING OVERHANG | | SANITARY SEWER MANHOLE |
| | ROAD | | STORM SEWER MANHOLE |
| | DRIVE, PARKING AREA | | METER (NO I.D.) |
| | CURB | | ELECTRIC METER |
| | CURB AND GUTTER | | WATER METER |
| | GUARD RAIL | | STEEL COVER |
| | FENCE (CHAIN LINK 6" HIGH WITH BARBERS) | | TRAFFIC SIGNAL METER |
| | TREE | | TELEPHONE PEDestal |
| | TREE (PALM) | | TELEPHONE PEDestal |
| | TREE CLUSTER | | CONCRETE SLABS |
| | BRUSH | | RAISED CONCRETE |
| | SIGN | | WALL (CONCRETE BLOCK 4" HIGH) |
| | POLE | | RETAINING WALL (CONCRETE BLOCK) |
| | LIGHT POLE | | 36" REINFORCED CONCRETE PIPE |
| | FIRE HYDRANT | | HEADWALL |
| | POST, PARKING METER | | CATCH BASIN |
| | POLE ANCHOR | | UNDERGROUND ELECTRIC DUCT |
| | VALVE (NO I.D.) | | BURIED ELECTRICAL CABLE |
| | WATER VALVE | | UNDERGROUND TELEPHONE DUCT |
| | GAS VALVE | | BORED TELEPHONE CABLE |
| | MANHOLE (NO I.D.) | | WESTERN UNION CABLE |
| | ELECTRIC MANHOLE | | WATER LINE |
| | TELEPHONE MANHOLE | | SANITARY SEWER |
| | | | STORM SEWER |
| | | | GAS LINE |
| | | | GUIDEWAY PIER COLUMN |
| | | | GUIDEWAY PIER COLUMN |

FIGURE 3-26

UTILITY RELOCATIONS, HOGAN STREET

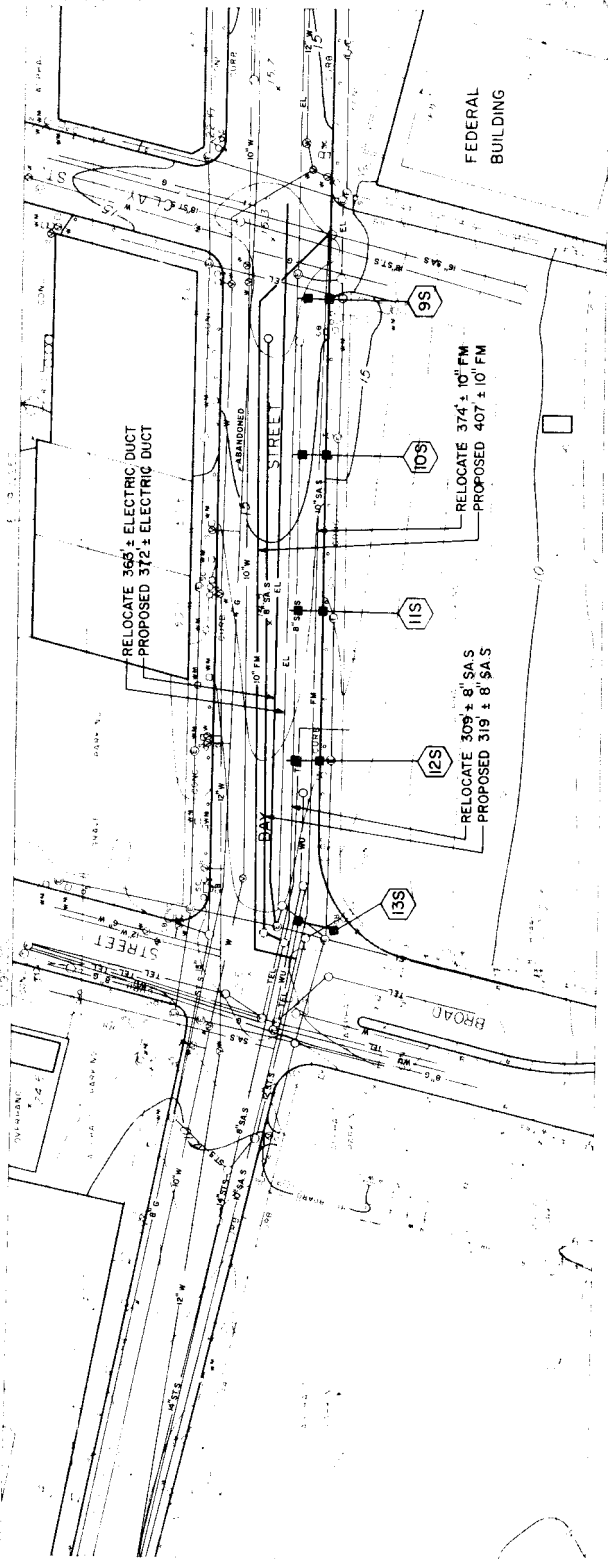
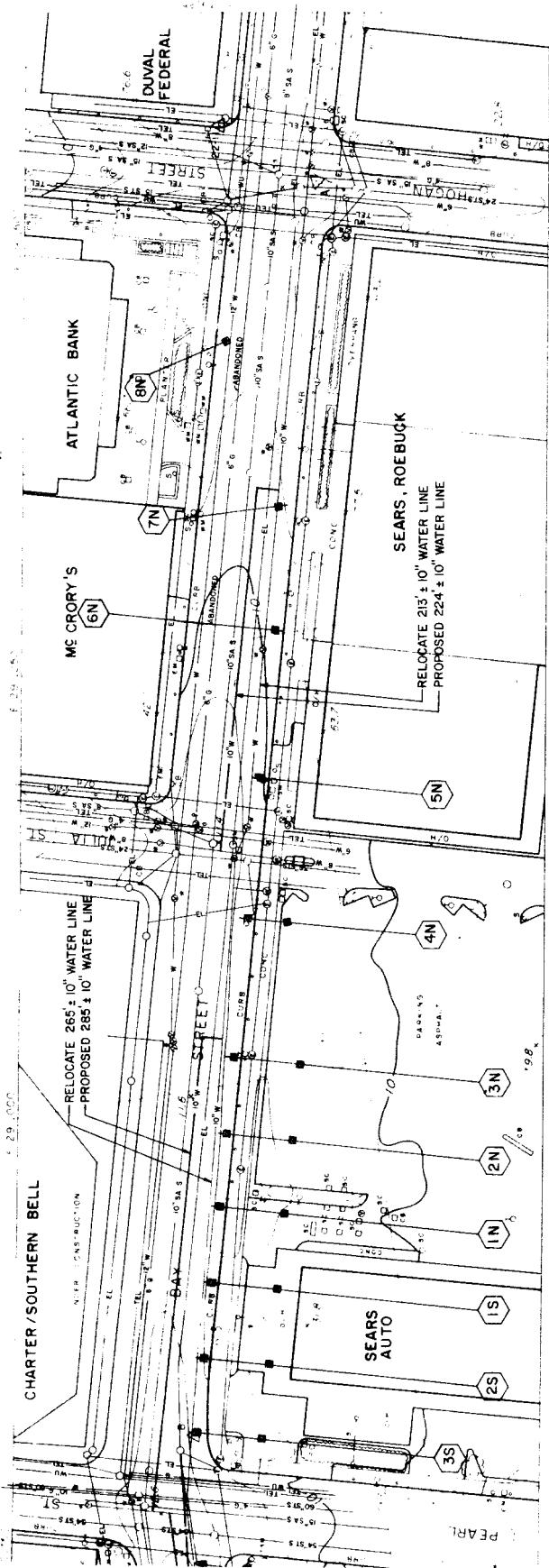
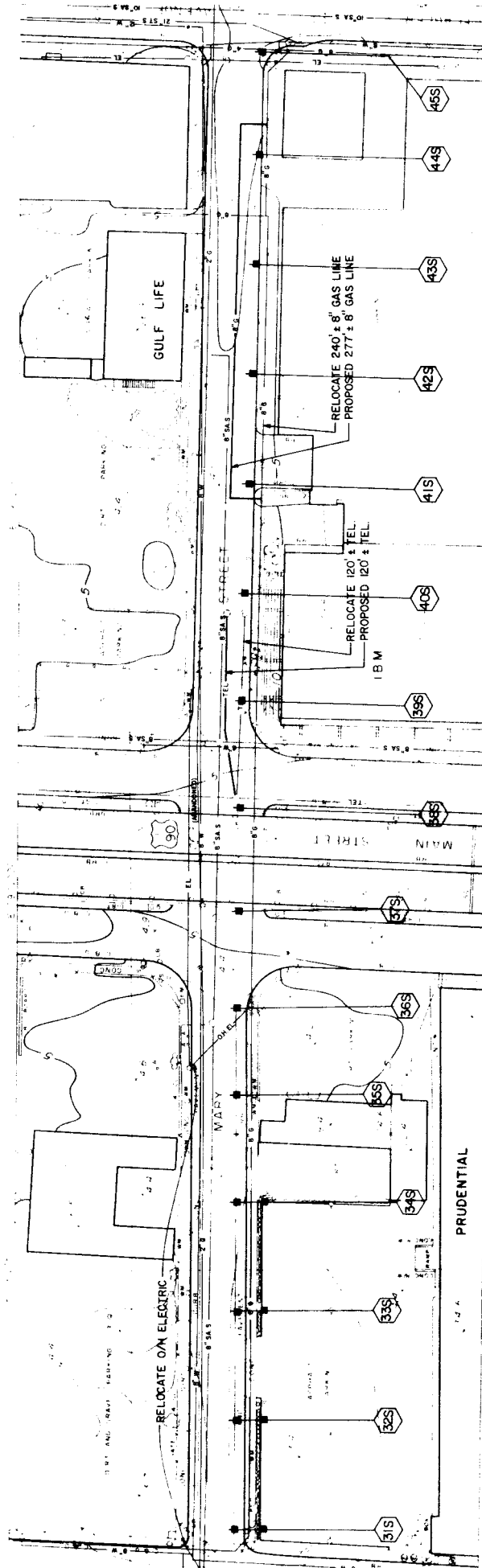

FIGURE 3-27

UTILITY RELOCATIONS, BAY STREET



UTILITY RELOCATIONS, MARY STREET

FIGURE 3-28

a new curb along the southern side of the street to separate the JASE piers from adjacent traffic. The area below the guideway would be used for pedestrian purposes except where sufficient space between piers would permit an indentation of the curb for curb parking.

- 4) Mary Street, south of the St. Johns River, would remain a 2-lane, 2-way street but would lose curb parking by construction of a new curb on the southern side to separate JASE piers from adjacent vehicular traffic. Where possible, the curb would be indented to permit limited curb parking. Intersections with San Marco Boulevard, Main Street, and Flagler Avenue would continue to function as at present.

These changes are graphically displayed in Figures 3-29, 3-30, and 3-31.

The visual impact of pier columns and guideways on motorists would not be significant. There would be partial visibility obstructions for vehicles or pedestrians approaching the intersections tabulated in Table 3-7.

TABLE 3-7
RIVER CROSSING ASE
PARTIAL VISUAL OBSTRUCTIONS TO TRAFFIC

<u>STREET NAME</u>	<u>CROSS STREET</u>	<u>TRAFFIC DIRECTION</u>	<u>TRAFFIC CONTROL</u>	<u>OBSTRUCTION</u>
Hogan	Adams	Westbound	Signal	Pier Columns - Left
Hogan	Duval	Westbound	Signal	Pier Columns - Left
Hogan	Duval	Northbound	Signal	Pier Columns - Right
Hogan	Ashley	Westbound	Signal	Pier Columns - Left
Hogan	Ashley	Northbound	Signal	Pier Columns - Right
Hogan	Beaver	Westbound	Signal	Pier Columns - Left
Hogan	Beaver	Northbound	Signal	Pier Columns - Right
Pearl	Bay	Westbound	Signal	Pier Columns - Left
Broad	Bay	Westbound	Signal	Pier Columns - Left
Bay	Broad	Northbound	Signal	Pier Columns - Right
Mary	San Marco	North and South	None	Pier Columns - Left and Right
San Marco	Mary	East and West	Stop	Pier Columns - Left and Right
Mary	Main	North and South	None	Pier Columns - Right
Main	Mary	Eastbound	Stop	Pier Columns - Right
Main	Mary	Westbound	Stop	Pier Columns - Left
Mary	Flagler	Northbound	None	Pier Columns - Left and Right
Flagler	Mary	Eastbound	Stop	Pier Columns - Right

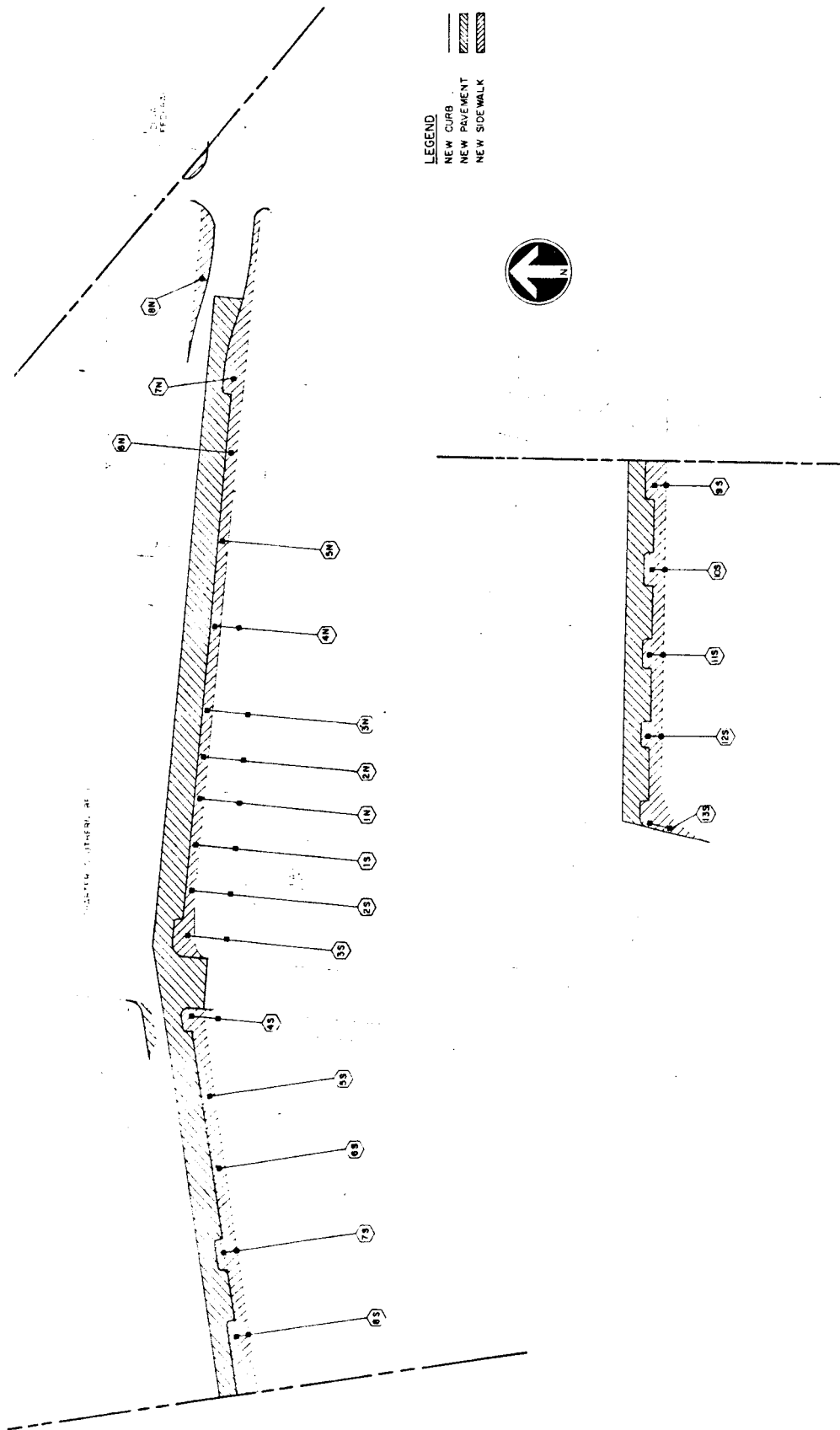

STREET RENOVATIONS, BAY STREET

FIGURE 3-29

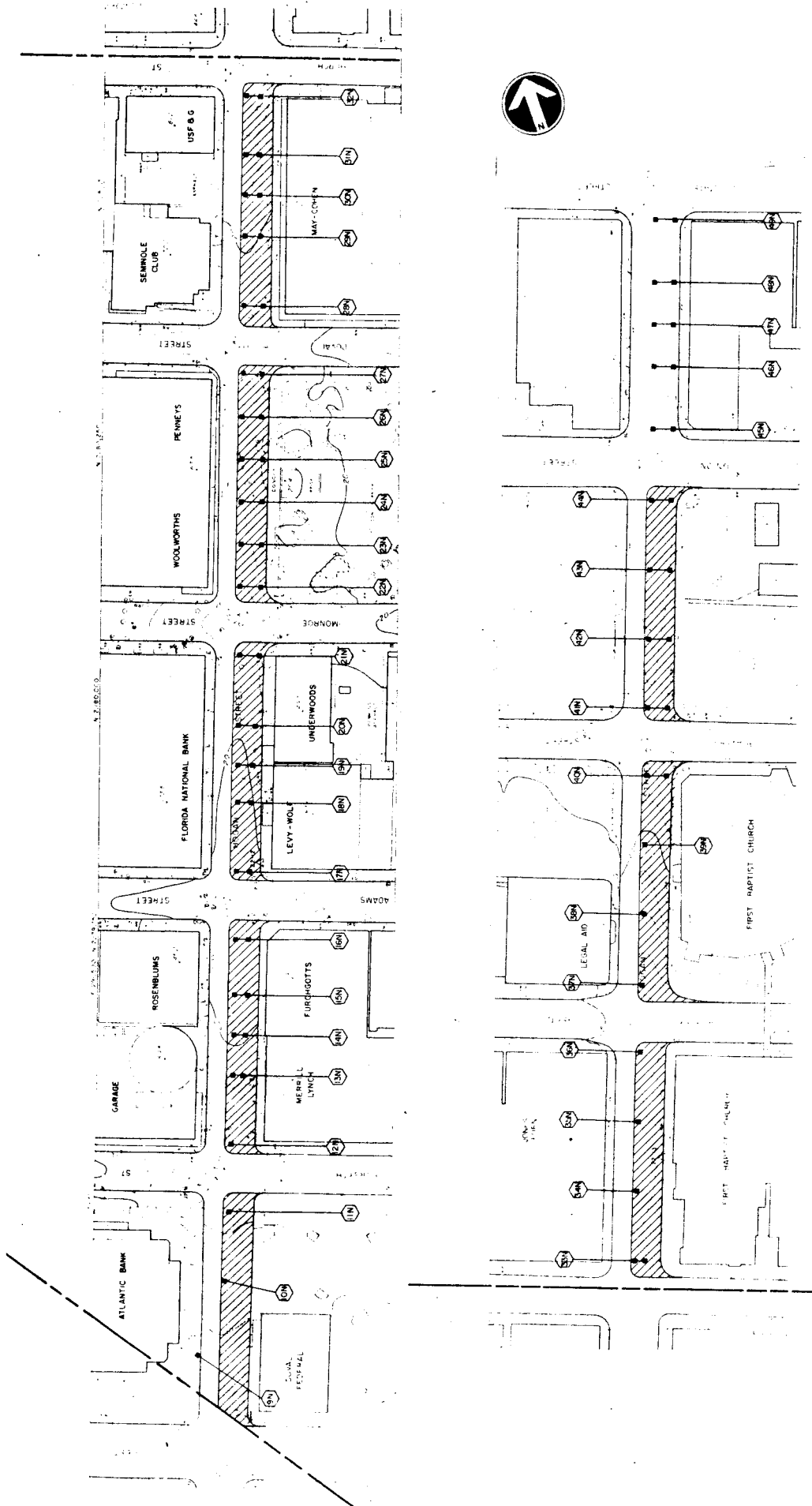

STREET RENOVATIONS, HOGAN STREET

FIGURE 3-30

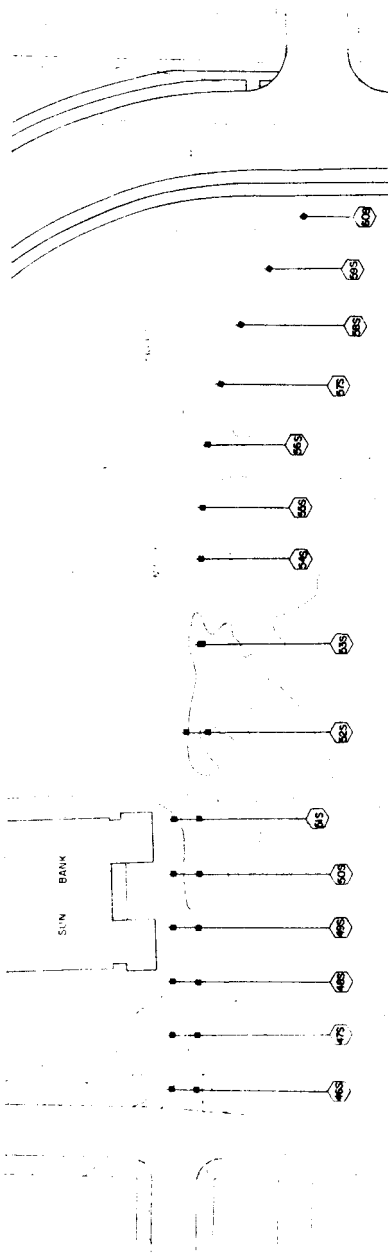
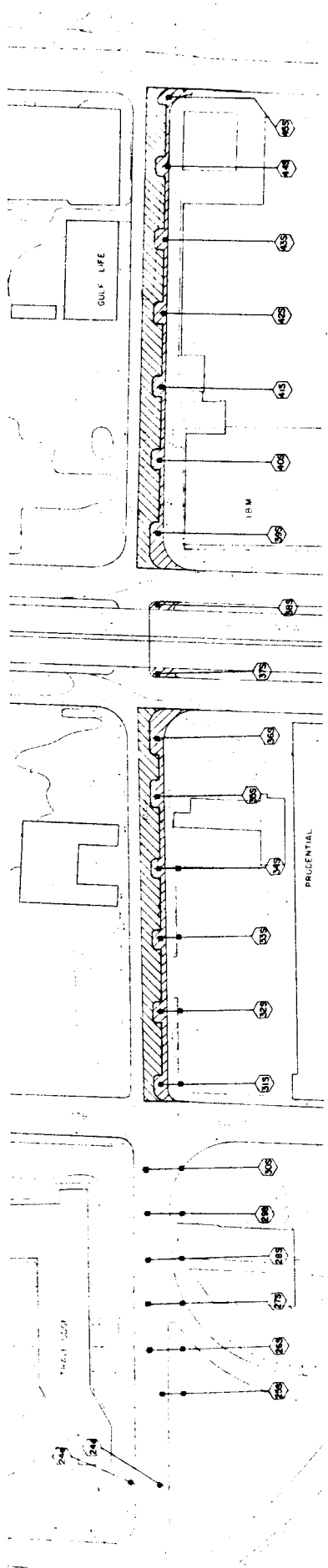

STREET RENOVATIONS, MARY STREET

FIGURE 3-31

Systems' Interfaces

The reference vehicle system discussed in the first section of this Chapter was developed to generally conform to the range of characteristics and capabilities of AGT vehicles presently in revenue service or vehicles of proven technology available from existing manufacturers.

The candidate systems include: beam-riders, either rubber-tired or steel wheel and rail; or beam-straddlers, all of which ride on pneumatic tires. Propulsion power for all systems is electric, utilizing either conventional electric motor drive or the more sophisticated linear induction motor system. Examples of the two guideway systems are shown in Figure 3-32.

All systems will interface with the reference system with only minor guideway and station design modifications, excepting the monorail-type (beam-straddler) systems which will require more substantial design changes. Changes required by the different systems will include platform heights, guide beam, or track placement, turnarounds, and power supply, signal, and communications pickup points.

Construction and Fabrication

Fabrication of standard guideway beams to carry the selected JASE vehicle would be one of the first construction activities to start. This would take place in a fabrication yard conveniently close to the construction site and large enough to store completed beams until the date of scheduled delivery and erection.

Construction of guideway support columns and piers would begin concurrently with fabrication of the beams. At all foundation sites, existing utilities which must be moved to accommodate new construction would be relocated. At the same time, areas would be excavated for column foundations. Street alignment modifications would also begin at this time.

Depending upon the subsurface conditions at each foundation site, either spread footings or piles would be used to support the column foundations. Spread footings are wide, thick, and heavily reinforced concrete slabs that spread the weight of the column over a large area to match the bearing strength of the soil. Piles are clusters of smaller columns driven or placed to bedrock or a depth less than bedrock. Friction of the soil on the sides of the many piles support the concentrated load of the columns.

Once the spread footings or piles are in place, concrete footings or pile caps would be placed on top to which the guideway column supports would be attached. The guideway column supports would be precast concrete or poured-in-place. Some locations would require bents (two single columns joined by a horizontal beam). Where precast columns would be used, they would be brought to the site by truck, lifted onto the foundation with cranes, and fastened in place. T-heads (top section

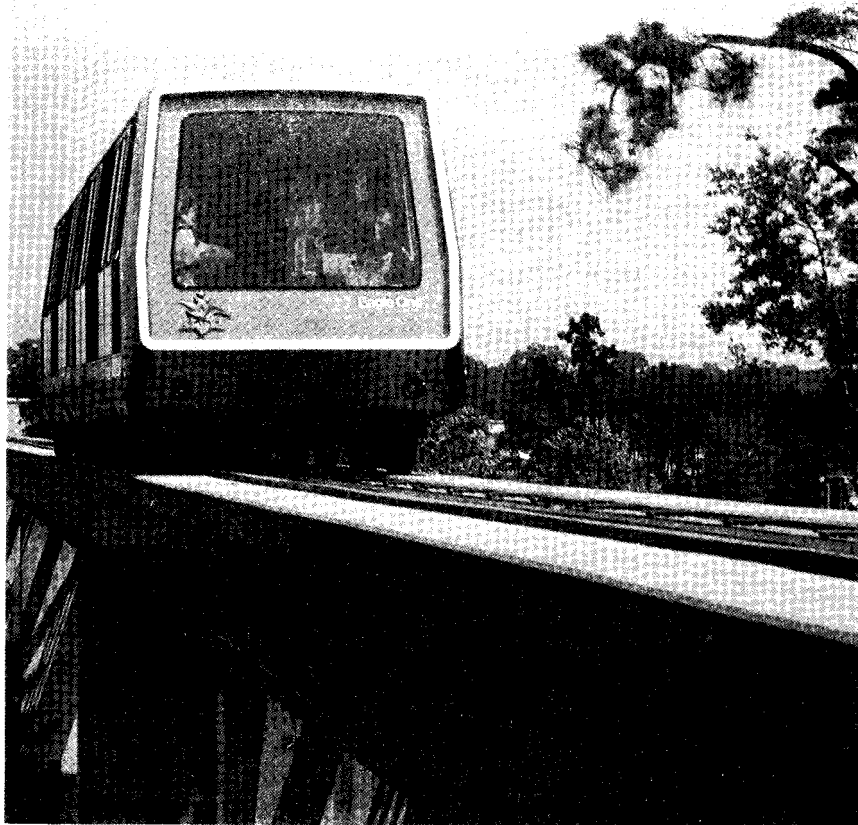

BEAM-RIDER SYSTEM



BEAM-STRADDLER SYSTEM

FIGURE 3-32

TYPICAL GUIDEWAY SYSTEMS

upon which the guideway will rest) would then be placed on the columns. Where poured concrete columns would be used, vertical steel reinforcing would be attached to the foundation, form work would be constructed, and the concrete would be poured.

The next step in the process would be the installation of guideway sections which could be made of steel, precast concrete, or poured concrete, the selection of which would be dependent upon difficulty of fabrication, ease of installation, and detailed design. These selections would be brought in by truck, hoisted into place with cranes, and secured to the T-heads. Where poured-in-place sections are to be used, forms would be constructed, reinforcing steel installed, and concrete poured. Longer construction time and more disruption would be anticipated where poured sections are to be used.

A series of steps would then take place after the guideway sections are installed. Depending upon the technology chosen, a running surface might be poured on top of the guideway. Vehicle guidance systems would then be added. This is done by using guide beams, guide walls, guide rails, or metal plates which would be hoisted up to the guideway, aligned, and installed. The power rail, which supplies power to the vehicles, would be installed on the guideway and connected to electrical substations. Then the connections for train control and communications would be installed, either as brackets or embedded in the concrete guideway. The sequence and duration of these construction steps are summarized in Table 3-8.

Construction of elevated stations would involve many of the same activities as guideway construction. However, once the columns had been installed, station construction would then require the following activities:

- 1) After the station supports had been installed, either steel or precast concrete sections would be placed on top to form the station platform and the joints between sections filled. If sections of a platform must be poured, temporary shoring and forms would be put up, reinforcing added, and the concrete poured.
- 2) Other work would then take place consisting of installing stairs (precast concrete units or poured-in-place), escalators, and elevators which would be assembled, installed, and tested on each site. Also to be constructed at intermodal stations would be access ramps, bus transfer zones, auto and taxi drop-off zones, and auto parking facilities.
- 3) Once the station structure is completed, station systems would be installed including the electrical system, lighting, and communications, fare collection equipment, train control, heating and air conditioning, and plumbing. After the system connections are made, interior finishing would take place such as paneling and painting. Finally to be installed are station graphics and equipment such as turnstiles and lighting fixtures.

TABLE 3-8

TYPICAL GUIDEWAY CONSTRUCTION SEQUENCE AND DURATION*

<u>CONSTRUCTION STEPS</u>	<u>TIME</u>	<u>STREET SIDEWALK DISRUPTION</u>
Place Foundations Restripe Street Close Curb Lane Excavate Footings Drill Piles and Pour Footings Temporary Cover Excavation	4 weeks	Approximately 10-15' from curb and access restricted during entire phase at each column site. Temporary sidewalk disruption and detour.
Erect Guideway Supports Set Steel Construct Forms and Pour Strip Forms Restore Sidewalk	5 weeks	Lane and curb access restricted during entire phase. (Significantly reduced if precast.)
Install Guideway	1 week	Complete sidewalk closure during guideway erection and complete or partial street closure, depending upon particular street involved. (Poured segments require 14 days curing time before removal of forms.)

* Open street segments only

After the guideway and stations are in place, street access would no longer be needed and streets and sidewalks could be permanently improved. New curbs, gutters, sidewalks, and paving would be installed and traffic and street lights moved or installed. Other activities would complete the guideway construction process including landscaping, guideway lighting, and other finish work. A typical construction scene is shown in Figure 3-33.

Construction activities required for the Maintenance facility, as well as the intercepts, include the general tasks of site clearance, grading, general structure work, and interior finishing. No unusual construction practices would be required. What does distinguish the Maintenance facility from other aspects of system construction would be that construction occurs entirely at an off-street site.

Civil and Structural Criteria

The guideway will be designed and installed so that all non-system

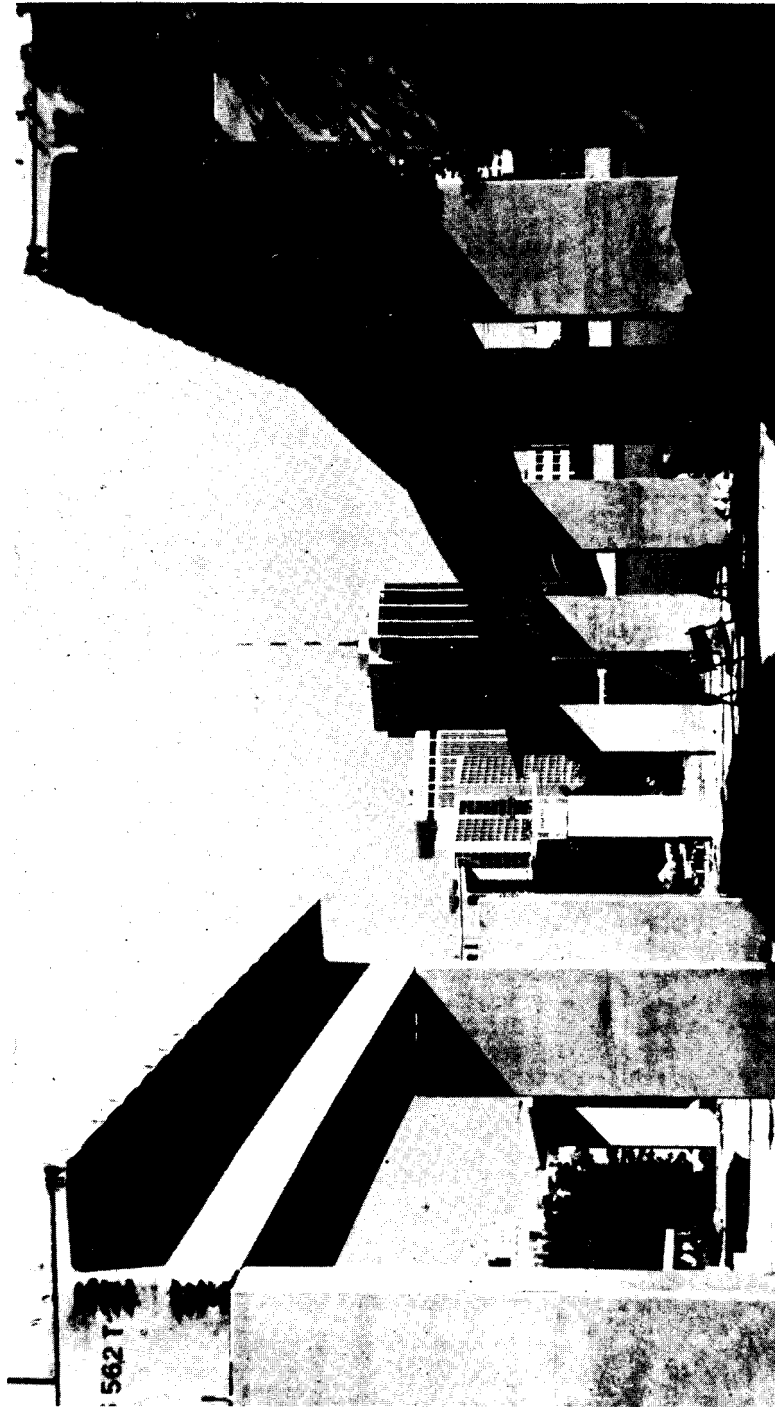

TYPICAL CONSTRUCTION SCENE

FIGURE 3-33

equipment and structures remain outside the vehicle clearance envelope. The vehicle clearance envelope is defined as the space occupied by the dynamic outline of the transit vehicle under worst-case conditions plus a 5" minimum allowance. The worst-case conditions include, but are not limited to, suspension failures, wheel wear, construction tolerances, vehicle overhang on curves, and superelevations, or combinations thereof. The vehicle clearance envelope is shown in Figure 3-34.

In addition, appropriate clearance shall be provided between the vehicle and other system equipment and structures including power rails, guide rails, and undercar clearances to assure proper and safe operation of the JASE System.

Actual design of the guideway alignment and profile is governed by the set of horizontal and vertical design criteria given in Table 3-9. Careful adherence to these standards will insure a smooth and comfortable ride for JASE passengers without any unusual sensations of motion.

The guideway will be designed to prevent puddling or accumulation of water. Storm water runoff on the aerial structure will be channeled to drainage inlets and then discharged through pipes embedded in the pier. Direct connection of these pipes to the storm water system shall be provided except in locations where other disposal is acceptable. Drains and piping shall be designed to accommodate the rainfall from a 50-year storm. The design shall include provisions for overflow drainage.

At locations where the guideway passes over vehicular or pedestrian traversed areas, the guideway shall be designed to entrap any contaminants and protect against dripping or splashing.

Parts of the JASE System will be located within the 100-year flood zone. The system will be designed to survive flood conditions but need not operate under such flooding condition. Where practical, all finished floor elevations of stations and the maintenance facility will be above the 100-year flood elevation. Consideration will be given in the design to protect all JASE equipment from damage due to flooding.

Structures or parts of structures subjected to JASE vehicle loadings will be designed to resist the loads and forces which are imposed. The dead load will consist of the weight of the basic structure and the weight of secondary elements permanently supported by the structure. The dead load will be applied in stages to realistically represent the life history of the design structure.

Horizontal and vertical distribution of loads from foundations of existing structures will also be determined.

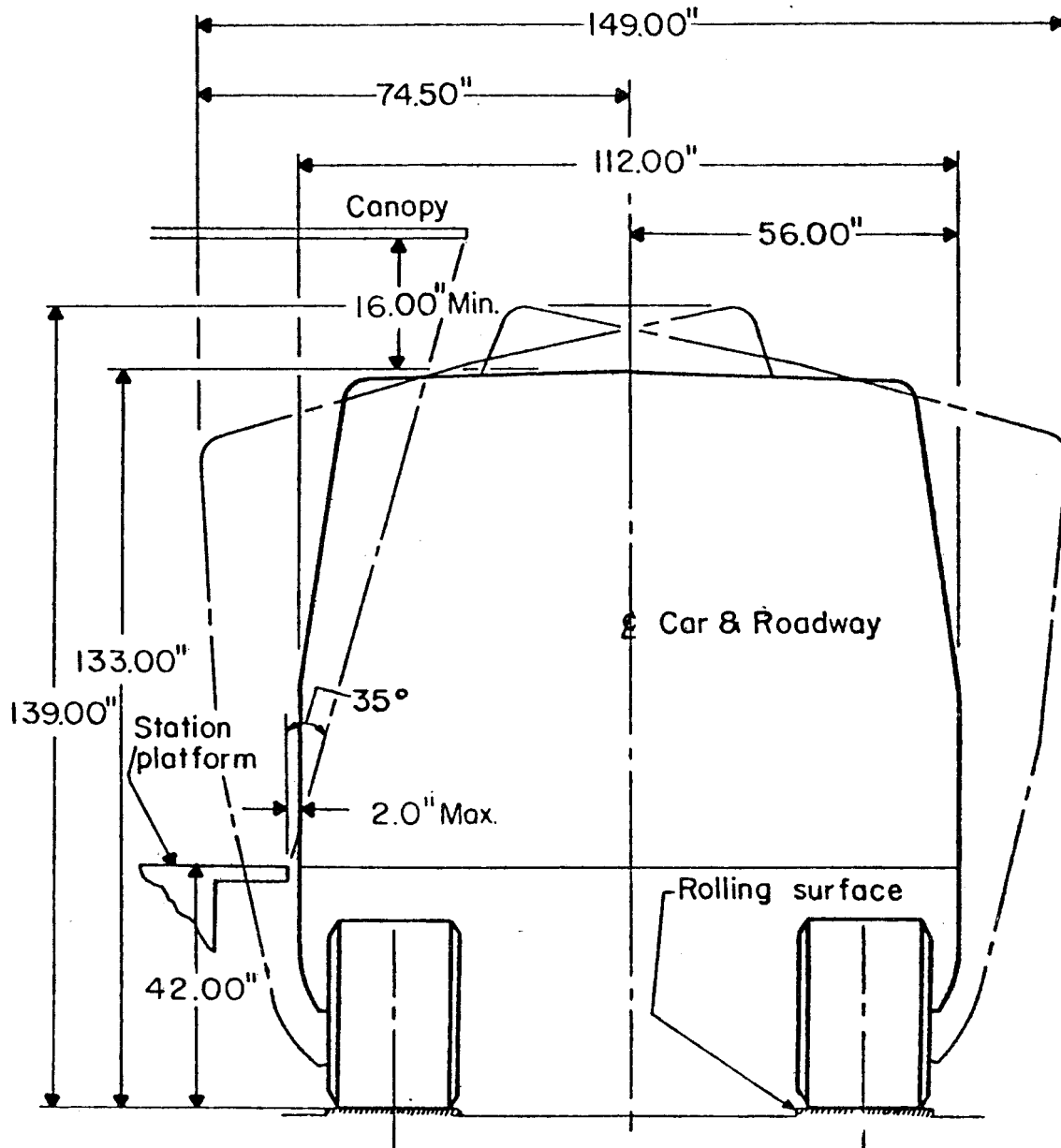

Note: On curves, spirals and super elevations the dynamic clearance envelope should be moved along the guide beam alignment to establish the required clearance lines. For this purpose the vehicle is assumed to have a constant cross section for its total length. The axle pivot points which follow the guide beam alignment and the car geometry are shown on the outline drawing.

FIGURE 3-34

VEHICLE CLEARANCE ENVELOPE

TABLE 3-9

HORIZONTAL AND VERTICAL DESIGN CRITERIA

Minimum Curve Radius	250'
Minimum Tangent Between Curves	45'
Spirals on all Mainline Curves	
Minimum Spiral Length	40'
Spiral Length Shall Limit Lateral Jerk to	0.06 g/sec.
Superelevate when Centrifugal Acceleration Exceeds	0.03 g
SE Rate of Rotation	0.022 ft./ft./sec.
Maximum SE	0.10 ft./ft.
Normal Acceleration and Deceleration	2 mph/sec.
Minimum Vertical Curve Length	150'
Minimum Tangent Between Vertical Curve	50'
Maximum Mainline Grade	8%
Minimum Grade at Stations	0.20%
Limit Vertical Component of Force	
Sags	1.03 g
Crests	0.97 g
Vertical Clearance	
Over Roadways	17'-0"
Under Structures (Clear of Vehicle Envelope)	16"

The following weights shall be used in computing the dead load:

	<u>Pounds per Cubic Foot</u>
Steel	490
Cast Iron	450
Aluminum Alloys	175
Asphaltic Concrete	150
Portland Cement Concrete, Plain or Reinforced	150
Compacted Sand, Earth, or Gravel	120
Timber, Treated or Untreated	60

	<u>Pounds per Linear Foot of Track</u>
Electrification, including Contact Rail System	15

	<u>Pounds per Linear Foot</u>
Parapet, or Acoustics Barrier, including Fastenings	180

For deflection, stress, and strength considerations, the vehicle live load will consist of the loads associated with the vehicle loaded to crush-capacity (see Table 2-9).

The live load will realistically represent the actual vehicle load distribution on the guideway structures. Consideration will be given to consist size, vehicle axle spacings, number of axles, magnitude of wheel loadings, and wheel track spacings.

Any combination of vehicle loadings, static or dynamic, which produces the critical live loading, will be used for structural design.

Structures and substations will be designed for wind loads based on a wind velocity of 120 mph except that wind load on live load will be designed for wind velocity of 80 mph.

Provisions will be made for stresses or movements resulting from variations in temperature. The effects of thermal cambering shall be included. The temperature ranges to be used in design shall be an ambient temperature range of +5°F to +105°F.

Maximum allowable deflections under live load impact shall not exceed AASHTO criteria of $L/800$, where L is span length.

Loading combinations for the design of the guideway structures shall be as specified in the latest edition of the "Standard Specifications for Highway Bridges", of the American Association of State Highway and Transportation Officials (AASHTO), including all interims, Division 1, Section 1.2.22, as follows:

Where the aerial structure crosses streets, highways, or railways, the spacing and location of piers will be controlled by lateral clearance requirements of said roadways or railways as well as the necessity of avoiding existing improvements such as underground utilities whose relocation is not feasible. The minimum horizontal and vertical clearances between the structure and privately- or publicly-owned streets, highways, utility lines, and other structures or property shall satisfy the requirements of the owners. The minimum horizontal clearance for streets and highways shall preferably include a minimum of 2' of lateral clearance between the face of pier and the street right-of-way line.

STATION DESIGN

Station Prototypes

The stations for the JASE are all center platform and will consist of three levels. At the top would be the central type platform, lying between the two guideways. Between the platform level and the street, or ground, level would be a mezzanine level providing access to and from the platform level via ramps and stairs to a walkway connecting with the urban skywalk system proposed for downtown and pedestrian bridges from nearby buildings or opposite sides of the street. The street level entrance to the system would be supplemented by circulation elements such as stairs, escalators, and elevators. The street level would also provide access to, and exit from, the system by bus transfer, auto, and taxi drop-off zones and adjacent parking facilities at certain stations.

There will be three major types of stations: (1) intermodal stations would provide a full range of bus, auto, and parking access facilities at street level; (2) urban stations would provide only that intermodal access available on the existing street system; and (3) a special design allowing for the future requirements of other segments of the Full Recommended System.

Fare collection and vertical circulation equipment at all stations will be provided in sufficient quantity to accommodate the estimated peak 5-minute patronage for the Full System, design year 1995. The typical design elements of these stations are presented in Figures 3-35 and 3-36.

Each station platform will be designed to hold a maximum number of people based upon the peak 5-minute predicted station patronage (see Table 3-10) or the emergency station occupancy load during a 2-minute period, whichever is greater. A recommended assembly space of 4 sq. ft. per person shall be provided with a minimum of 8' between the edge of the platform and obstructions. In addition, platform areas and exits shall be sized to permit complete evacuation of a 2-car consist crush-loaded under emergency conditions within 2 minutes and complete evacuation of the platform area within 4 minutes.

TABLE 3-10
1995 PEAK PERIOD DAILY STATION VOLUMES

<u>STATION</u>	<u>PEAK HOUR</u>	<u>PEAK 5 MINUTES</u>
FJC	1,810	290
Hemming Plaza	1,464	235
Central	1,978	315
Jefferson	703	115
Prudential	1,232	195
Gulf Life	1,113	180
St. Johns Place	2,544	410

A crawl space shall be provided below all platforms at track level to provide a refuge area for a person on the guideway in the event of an oncoming vehicle.

The intermodal station will be designed in a manner that allows the patron to transfer between the JASE and regional buses without passing through the station fare barrier and without monitoring of a transfer device. This requires the fare barriers to be at ground level before entrance to the vertical circulation. This ground level paid area will lead directly through bus gates to the bus stall and waiting platforms outside. These bus gates shall be single direction opening out with panic hardware on the inside in the station paid area. The

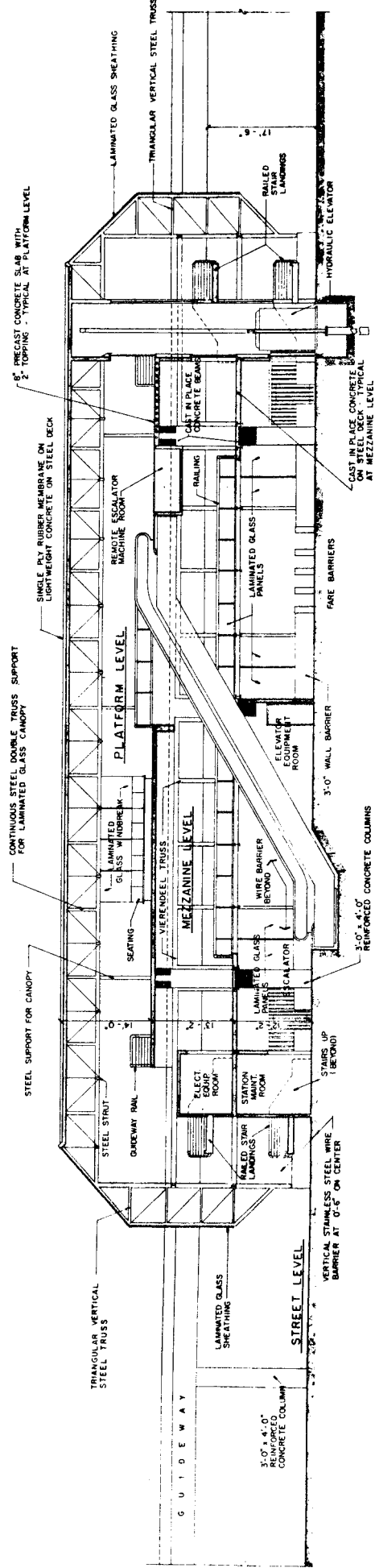
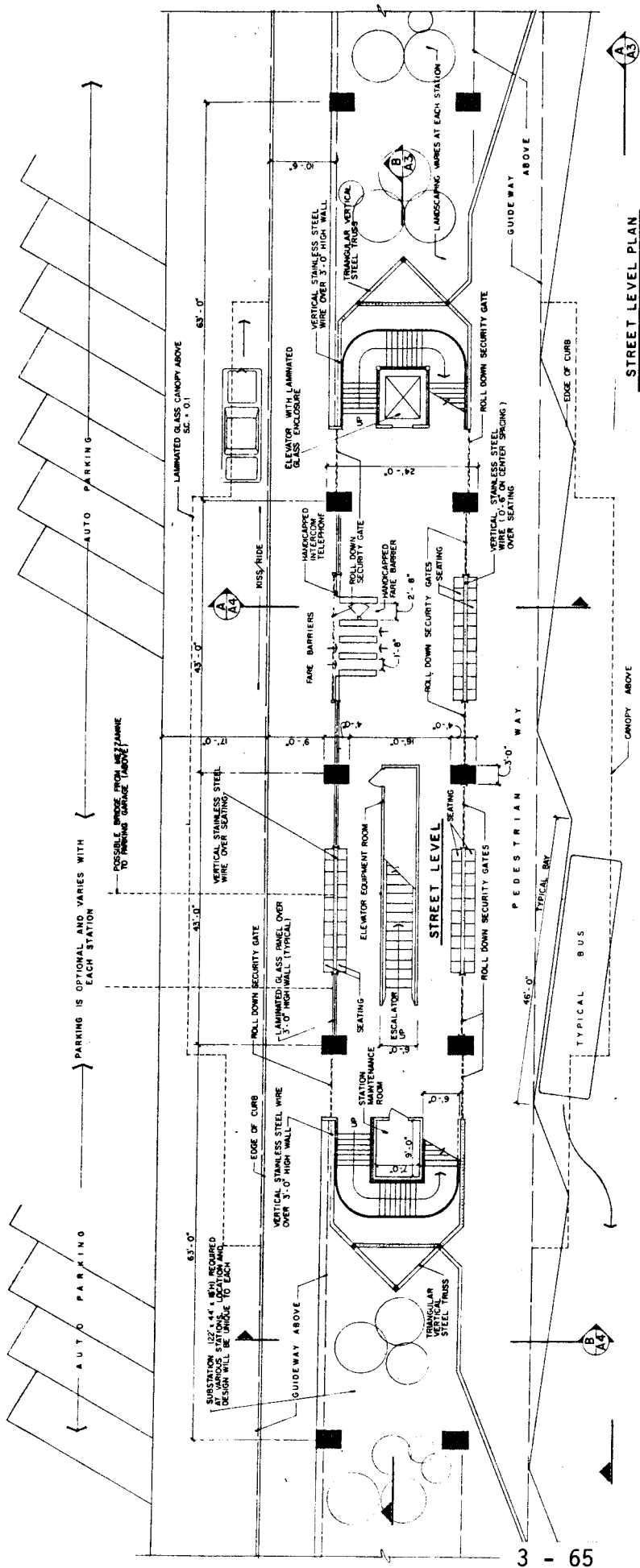

SECTION - INTERMODAL STATION

PROTOTYPICAL INTERMODAL STATION DESIGN

FIGURE 3-35

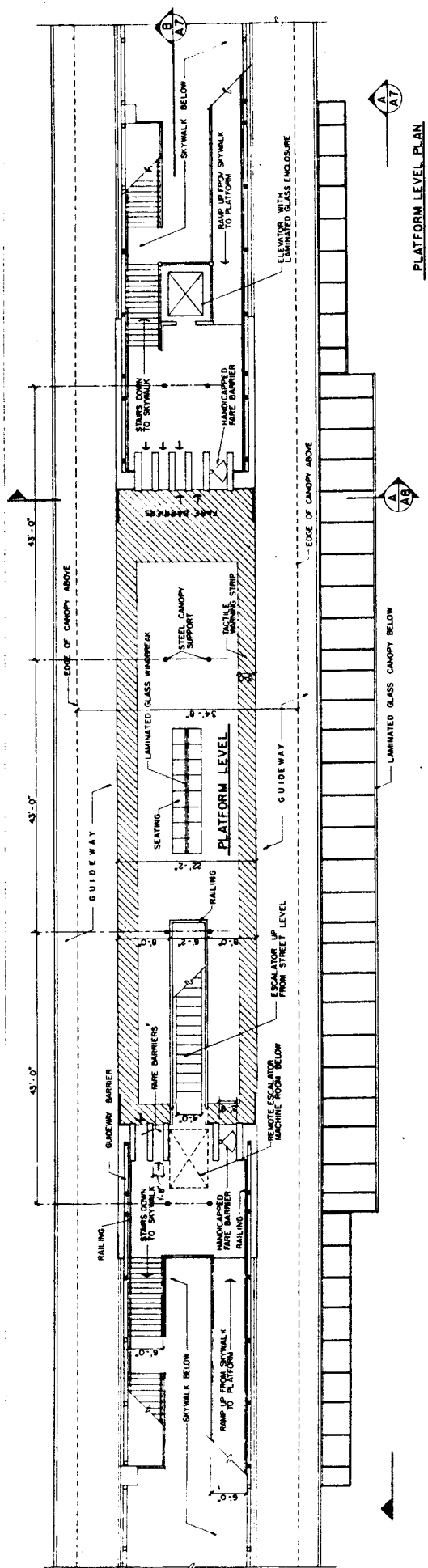

PLATFORM LEVEL PLAN

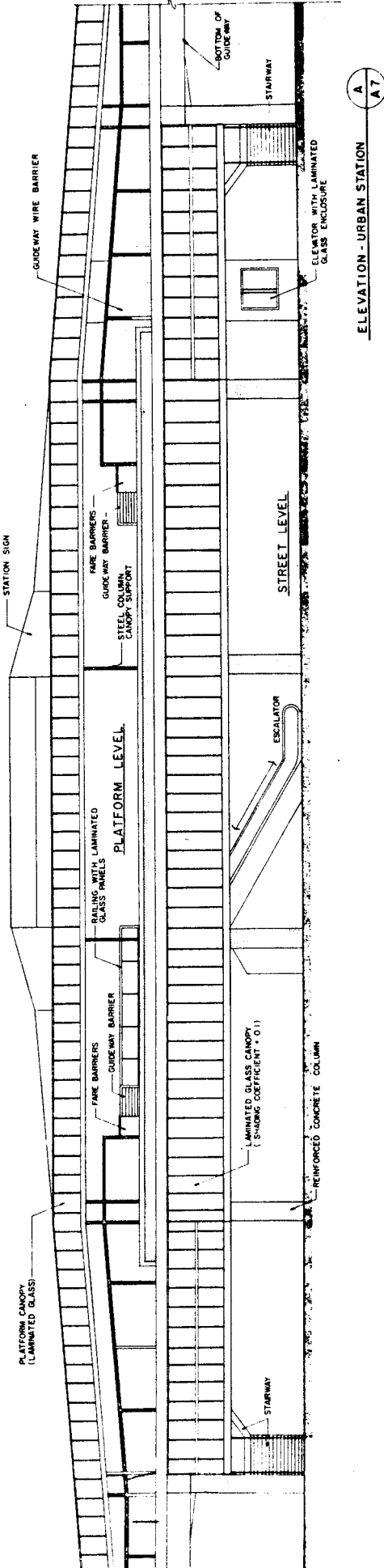

ELEVATION - URBAN STATION

PROTOTYPICAL URBAN STATION DESIGN

FIGURE 3-36

bus gates shall be locked by electric remote-controlled switches which can be activated by the bus driver or Central Control. The outside waiting, queuing areas, and ground level paid area shall be sufficient to accommodate the peak 15-minute design volumes at a 3 sq. ft. per person minimum. There shall be a minimum of 20' between all vertical circulation elements and exterior exits on bus gates.

Urban stations are generally located near high density land uses and restricted sites. They require both higher levels of pedestrian access and flexibility in the location of the "footprints" of the vertical circulation elements. To accommodate this circulation, a second level "spine" walkway has been designed for each urban station which is intended to carry patrons from buildings to JASE stations above ground. Access to spine walkways will be by any combination of ramp, stairs, or escalators anywhere along the guideway. Access from the spine walkways to the station will be by any combination of ramps, stairs, and escalators at the ends of the stations only. An elevator from the ground straight to the platform shall be provided at every urban station. Urban stations will have a special facility for bus, taxi, or auto modes. However, the restricted urban setting may limit the ability to provide unrestricted transfer between other transportation modes and the JASE. All such interface with other modes will be via the existing streets. There shall be no parking spaces provided at urban stations.

Station Site Plans and Development Interface

Construction of JASE stations in the Downtown Jacksonville environment will strongly influence surrounding pedestrian, traffic, and business development activities. Because intermodal stations of the JASE System would be major transfer points for regional bus and auto commuters and pedestrians, the intensity of activity at these stations would be greatest during AM and PM rush hour peaks. Urban stations would be a focus of pedestrian activity throughout the day. The following paragraphs address the effect of proposed station site plans on the immediate neighborhood and how those plans will interface with adjacent developments, existing and proposed.

The Florida Junior College Station area shown in Figure 3-37 under the influence of the JASE System would experience an increase in the demand for parking and bus traffic. No major development is expected to be induced by the JASE System. However, the continuing expansion of Florida Junior College's campus could benefit from the improved circulation with the Downtown and Southside that the JASE will provide. The JASE System would include street and traffic control improvements. A pedestrian bridge would be built between the station and campus. The bridge would make it possible for students and other pedestrian traffic to cross State Street with less hindrance to traffic and with greater safety.

The Hemming Plaza Station area, as shown in Figure 3-38, would have several beneficial changes resulting from the JASE System. Bus traffic around the plaza, especially at the Monroe Street transfer site, would

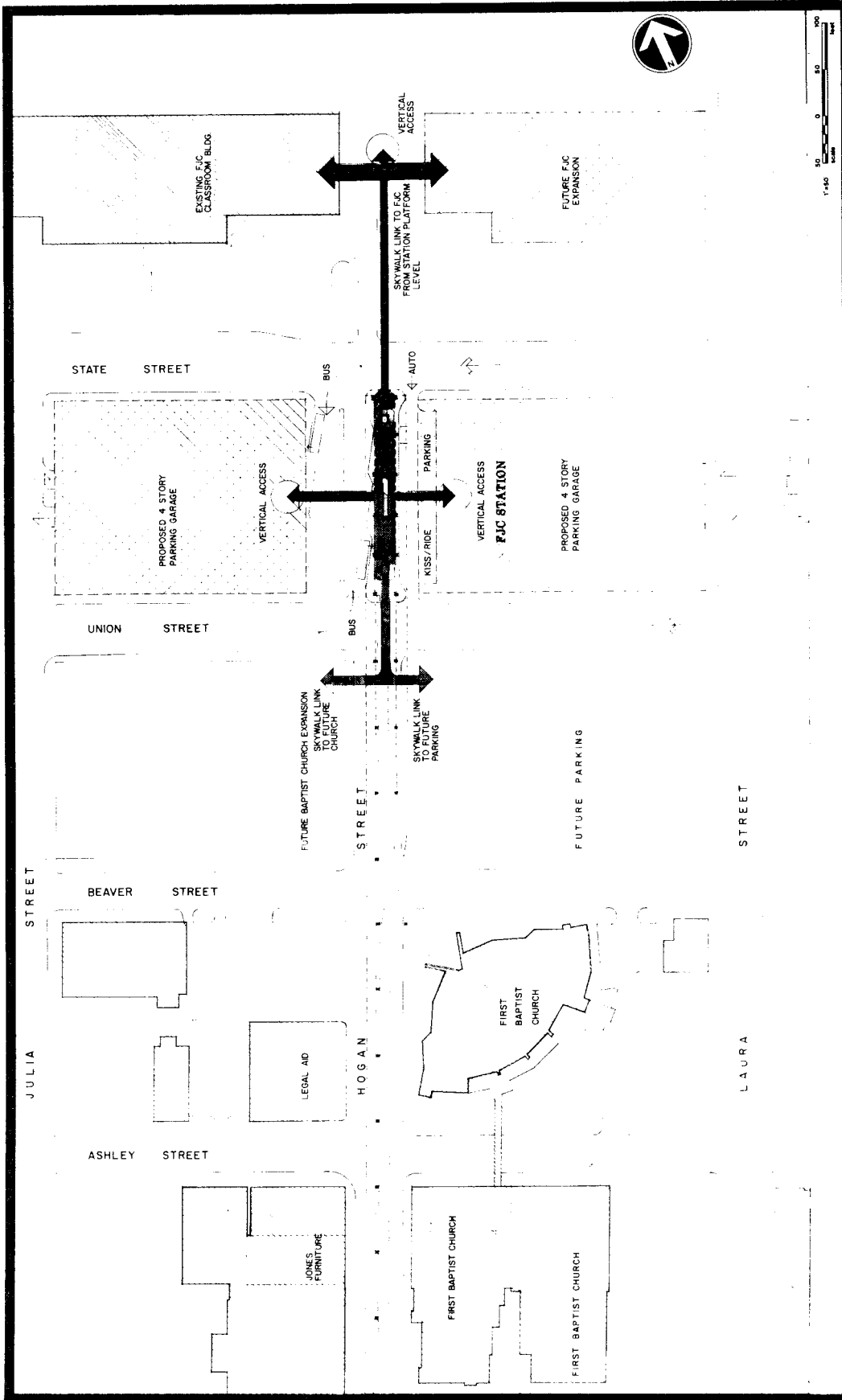

FJC STATION AREA SITE PLAN

FIGURE 3-37

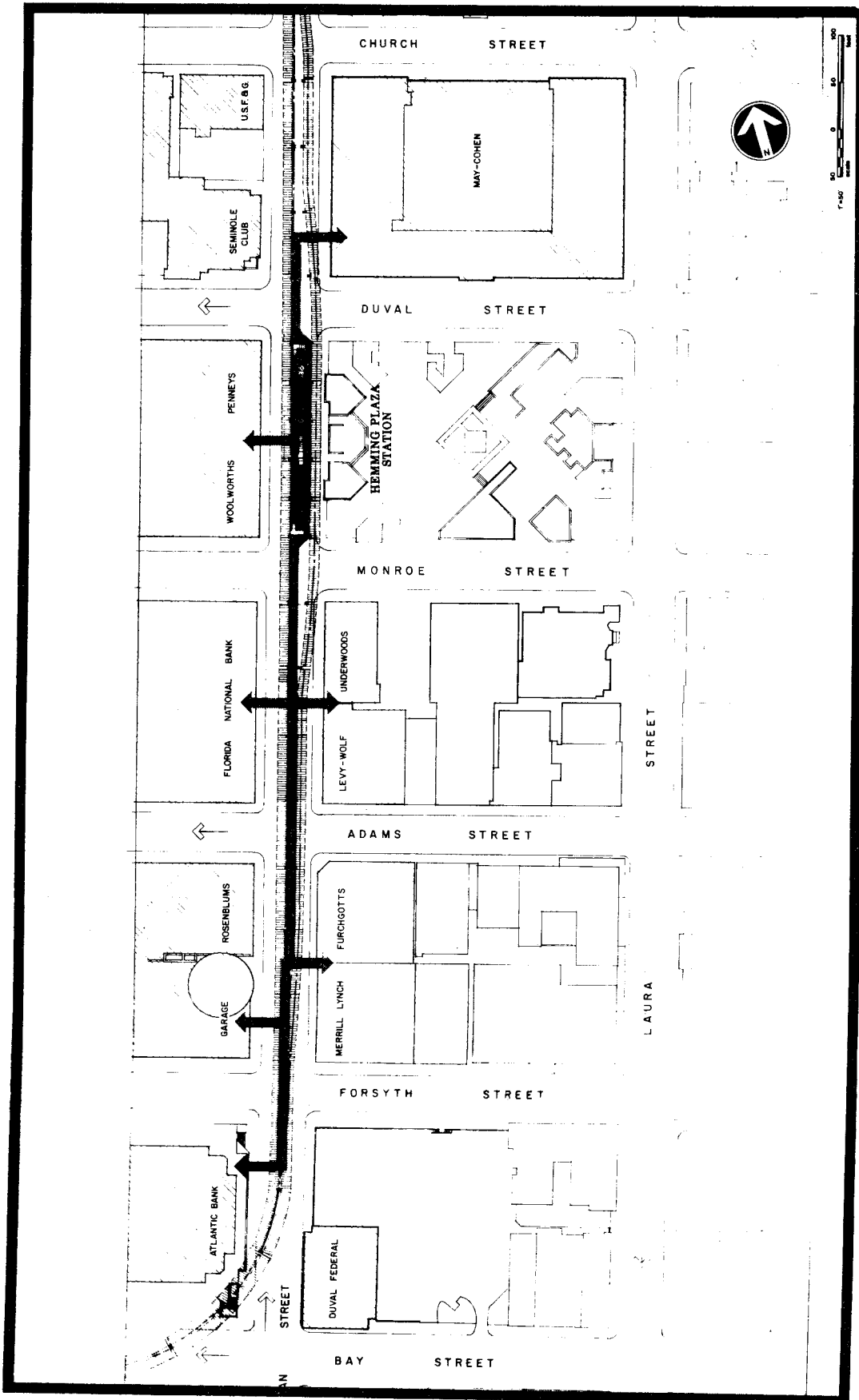

HEMMING PLAZA STATION AREA SITE PLAN

FIGURE 3-38

be terminated. Parking would be eliminated in the station area. Pedestrian movements around the station area would be greater than would have occurred without the JASE. This would be a benefit to the local commercial district around the station. Turning movements onto Hogan Street at cross-streets near the station would be slowed significantly by pedestrian activity on the street and the narrowing of Hogan Street to two lanes.

The Central Station area, as shown in Figure 3-39, is expected to be one of the most active urban stations. Bay Street would be maintained at three lanes at the location of the station and no traffic congestion would occur. Bus traffic by JTA buses would be eliminated in this area because of the presence of the JASE. Future development of the Quad-block by the Charter Corporation could incorporate the JASE into its design and site layout, benefiting from the improved Downtown circulation provided pedestrians by the JASE. The anticipated increase in pedestrian activity at this station area would require traffic improvements to safely separate vehicular and pedestrian traffic.

The Jefferson Street Station area, as shown in Figure 3-40, would experience an increase in bus and auto traffic resulting from the commuters using the intermodal station. This area would undergo development and redevelopment and the station would support this activity. The area is already used for parking by commuters to local offices. The JASE could reduce the level of parking demand by diverting the local commuters to remote parking stations such as St. Johns Place and Florida Junior College. Improvements of pedestrian crossings on adjacent streets would be needed to safely move JASE patrons to local offices. This station could serve as a temporary intermodal station for some bus routes and still provide some short-term parking.

The Prudential Station area, as shown in Figure 3-41, is a site with current public and private development plans. The immediate station area would change to office use under the influence of the expansion of the Prudential Life Insurance Company. The urban station at this location would improve circulation within the Downtown area and would reduce the parking concentration and traffic congestion that must otherwise occur around this new development.

The Gulf Life Station area, as shown in Figure 3-42, would be in primarily vacant land planned for development by the Downtown Development Authority as residential and office buildings. The station would support development of this area by providing residents and workers with convenient public transportation services. It would help to reduce traffic congestion brought about by future development. However, parking could become concentrated here. The area already provides parking for office workers and the JASE would divert workers commuting from Northside. Future development of this area must consider means to improve pedestrian movement around the station and limit street parking to local residents and workers.

The St. Johns Place Station area, as shown in Figure 3-43, is surrounded by vacant land and low-use development. Current development

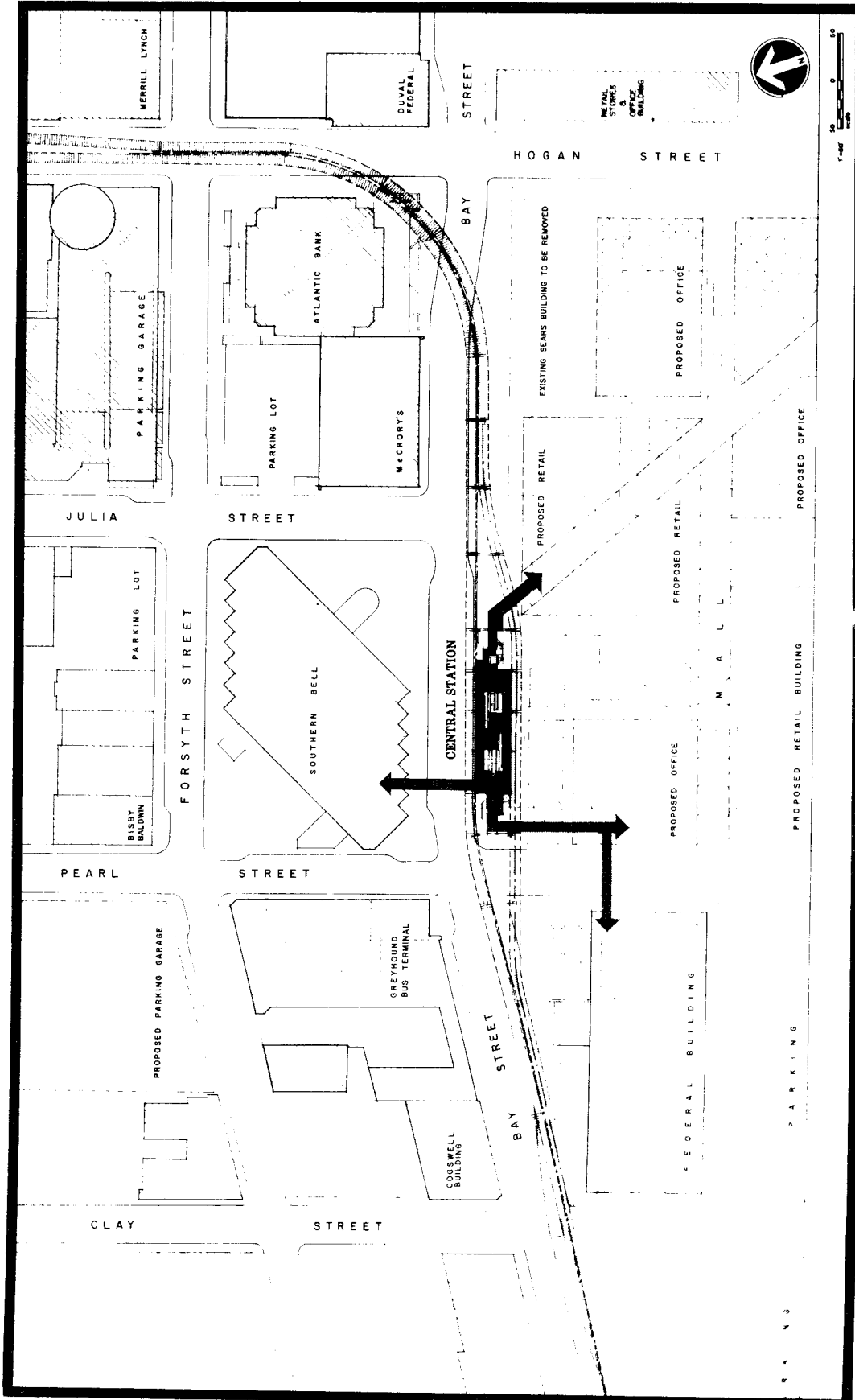

CENTRAL STATION AREA SITE PLAN

FIGURE 3-39

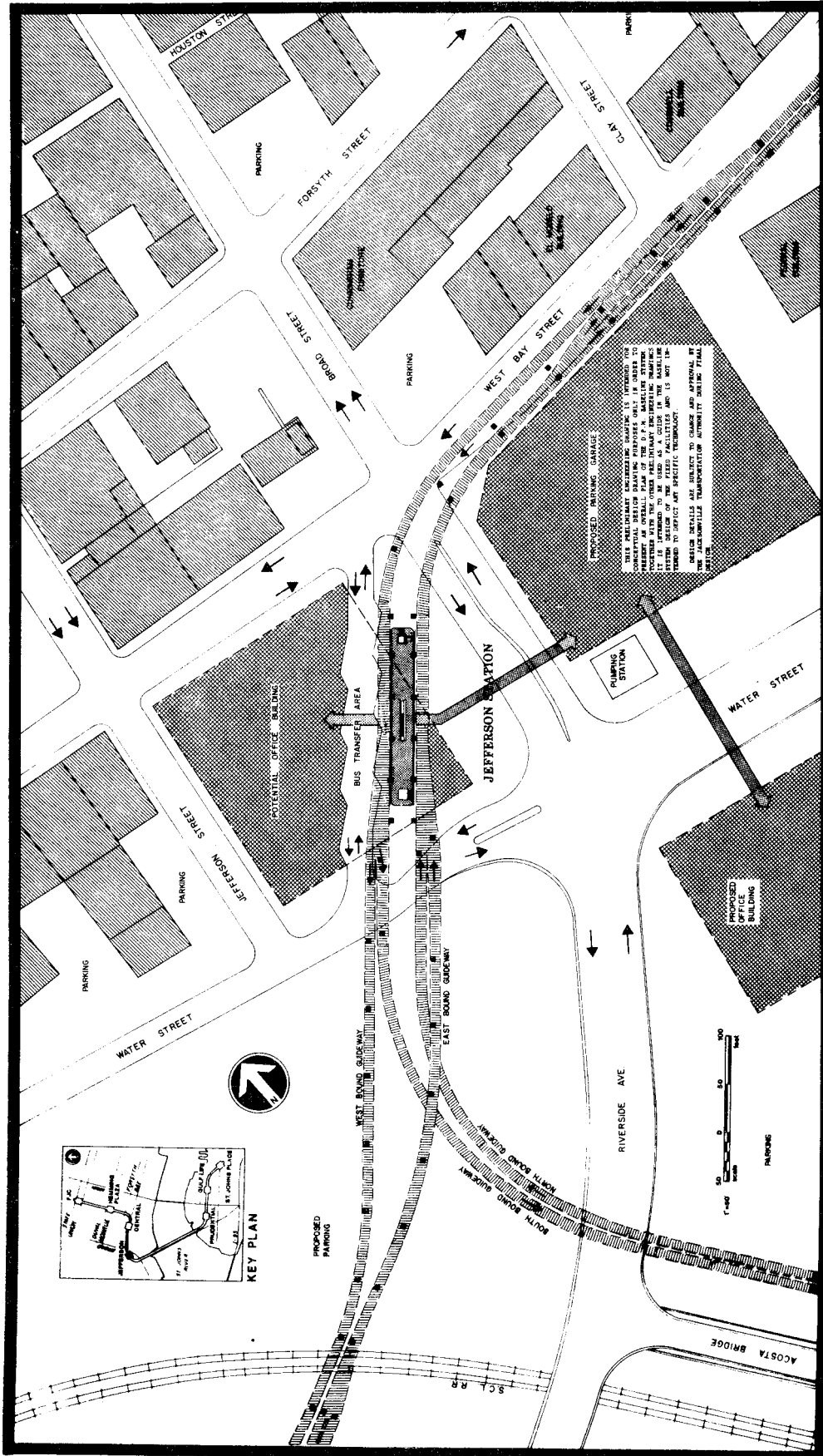

JEFFERSON STATION AREA SITE PLAN

FIGURE 3-40

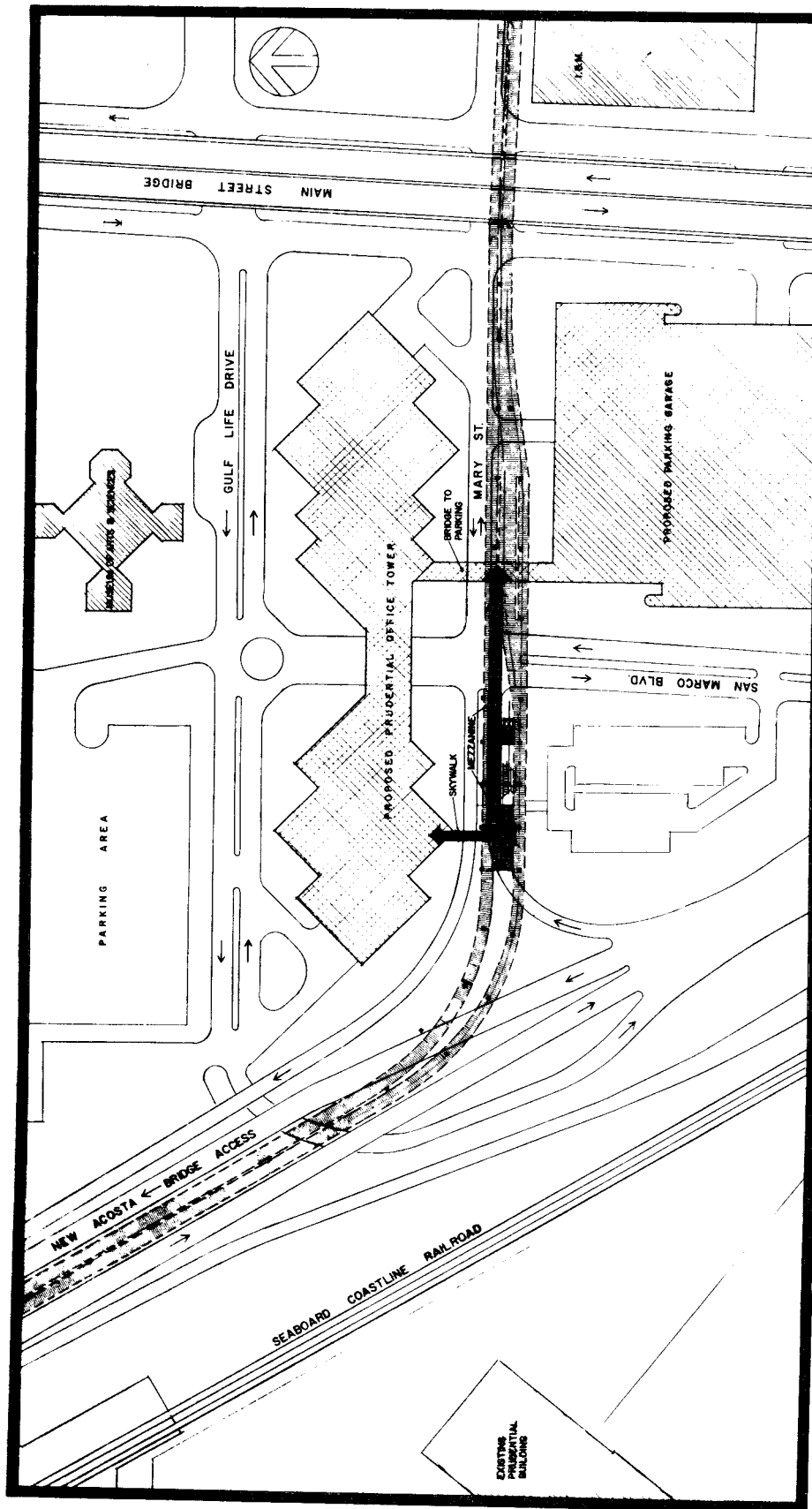

PRUDENTIAL STATION AREA SITE PLAN

FIGURE 3-41

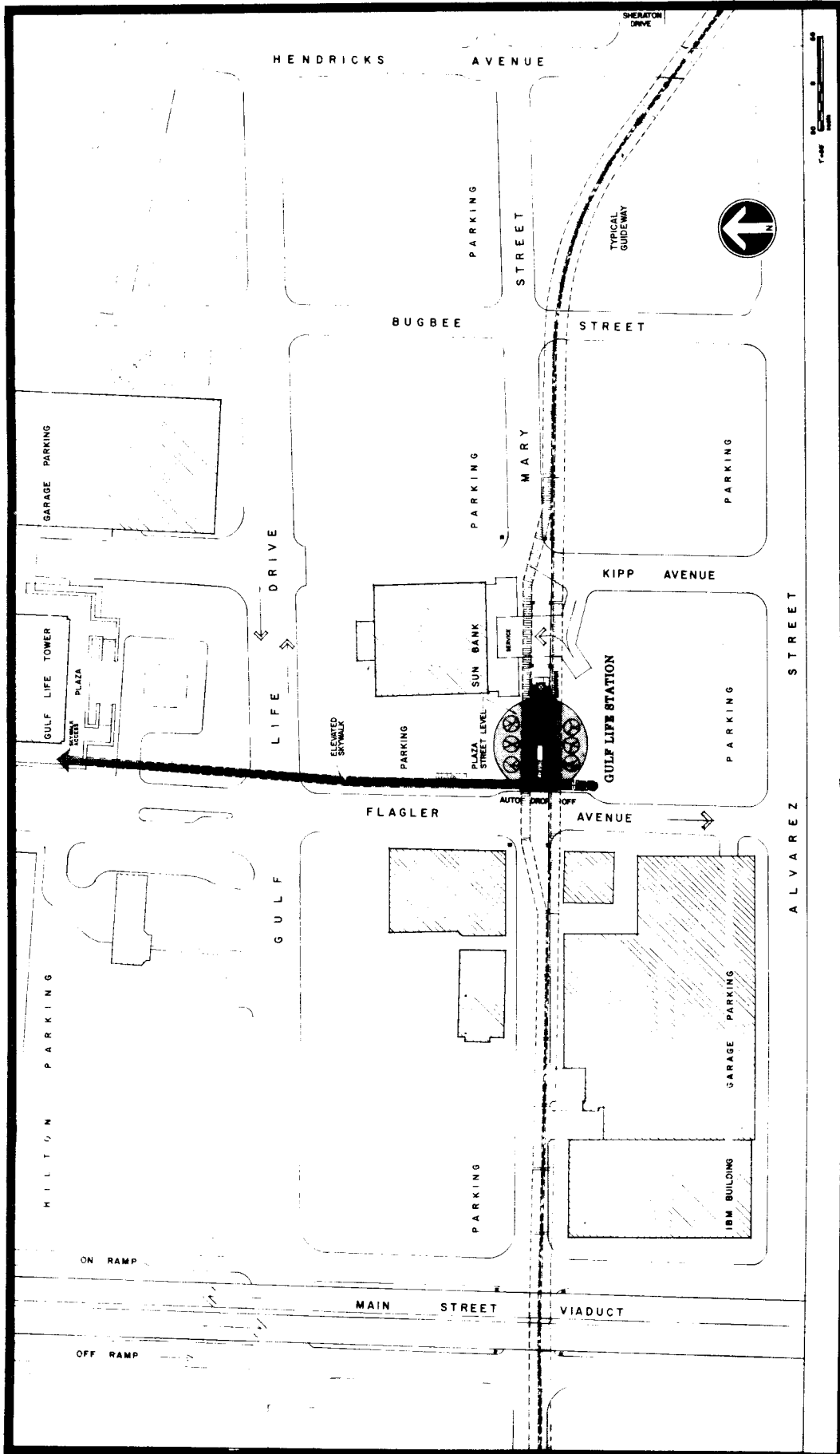

GULF LIFE STATION AREA SITE PLAN

FIGURE 3-42

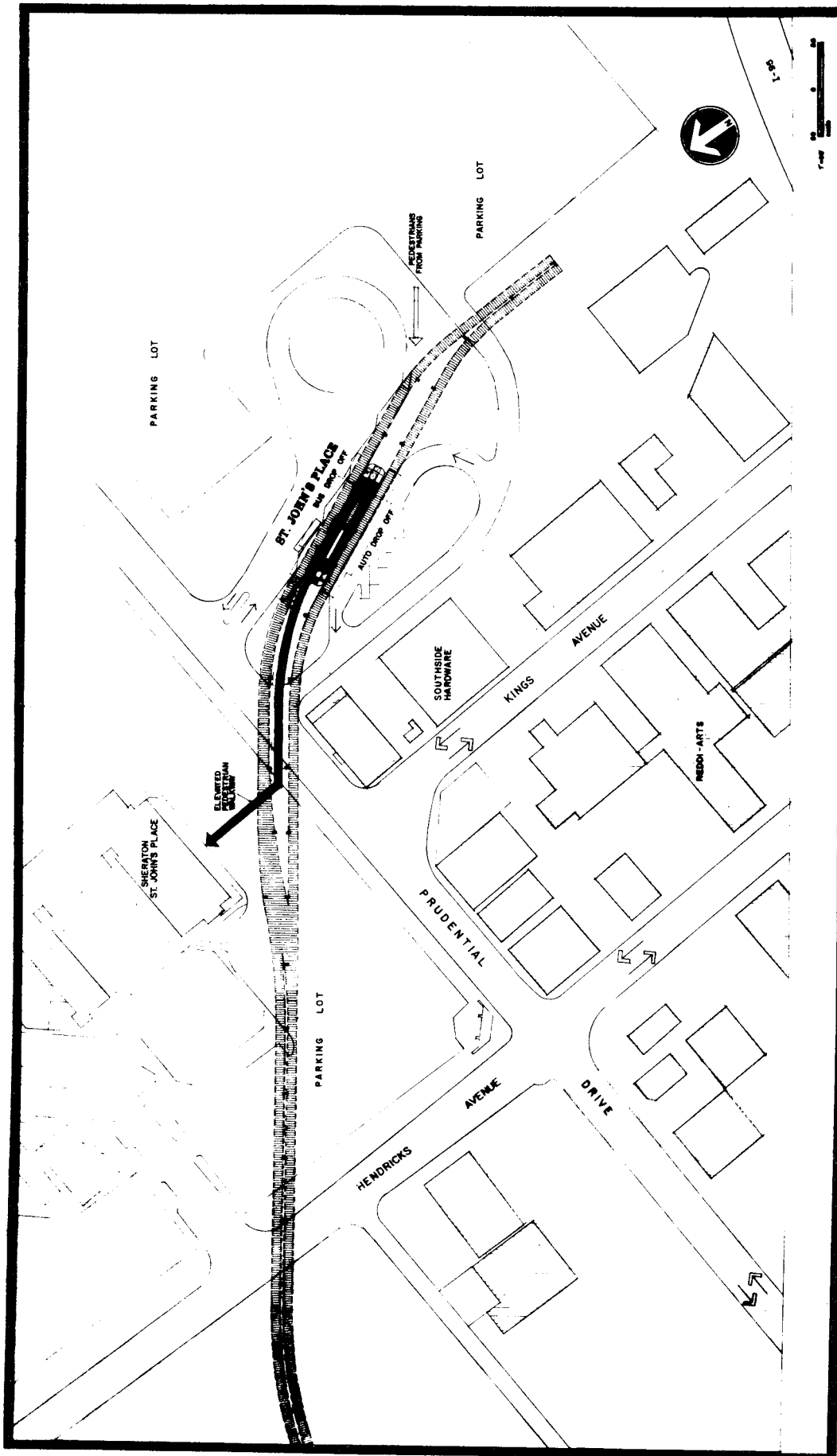

FIGURE 3-43

ST. JOHNS PLACE STATION AREA SITE PLAN

activity in the area is hotel and office buildings. The JASE would support the development and redevelopment in the area. The intermodal station would attract auto and bus commuters and improve the mobility of local workers and hotel guests. It would also be a focus for decreasing traffic congestion and regional parking demand.

Urban Design

Urban design encompasses all elements of the interface between the proposed JASE System and the existing urban environment. The purpose of urban design is to ensure that the physical design of the JASE is one which is aesthetically pleasing, becoming an integral part of surrounding development, and promoting Jacksonville's visual appearance.

The JASE guideway is aligned along some of the highest density development in Jacksonville's Central Business District. It will significantly affect the urban environment from the point of view of a pedestrian and motorist. The basic design philosophy has been to incorporate the guideway and station structures into existing and programmed buildings as often as practical.

Guideway piers are the most obvious structural element for the pedestrian. Their integration with the sidewalk, adjacent buildings, and the street is extremely important from an urban design point of view. Single piers are the least obtrusive and, consequently, the most desirable for Downtown Jacksonville; however, they are generally much larger in size. A reasonable balance between pier size and spacing will be determined and used.

Pier spacing will be coordinated with existing building facades, building entrances, service entrances, station columns, and crossing of intersections where necessary to achieve a solution which is sensitive to the surrounding area. Otherwise, pier size and span length will be optimized and uniform pier spacings used whenever possible to minimize system cost.

Pier location must allow for smooth pedestrian and vehicular flow. This will be achieved by using the parking lane along most streets of the alignment, leaving the sidewalks and moving lanes undisturbed. A safety curb will be constructed along the roadway edge to divert cars away from the piers. A minimum 24" clearance between face of column and curb will be required.

Appearance of the piers will be softened by careful coordination of the pier location with adjoining support systems. Two examples of this coordination are:

- 1) Landscaping - The semi-tropical character of North Florida and its importance as a tourist image, warrants the generous use of plant material to soften the rigidity of all fixed elements. Small street trees will be used to enhance the pedestrian areas beneath the guideway superstructure; ground cover may be used at certain

locations as transition between the piers and the ground plane. Native and salt-resistant plants will be used whenever possible.

- 2) Lighting, Graphics, and Signage - In order to obtain a more unified urban fabric, the guideway superstructure and pier design will allow the incorporation of such street furniture as traffic signals, lighting, signage, and other information systems. In addition, the street furniture should conform to the general design established by the DDA for its street improvement programs.

The spine walkway, as an access element, has important and critical implications on the interface or integration of certain stations with adjacent development. The spine walkway may be a principal tool to the promotion and flexibility of joint development and value capture efforts of the JTA. The designers will integrate the spine walkway concept into the functional and physical design of certain stations. All stations on the River Crossing ASE appear to have significant potential development adjacent to the site.

A final element in good urban design is the interface between the JASE and other transportation modes. Bus and auto access to intermodal stations will be designed for smooth vehicular movements and a pleasing appearance. Figures 3-44 and 3-45 give examples of criteria used in designing these facilities.

Elderly and Handicapped Plan

The JASE System will be planned and designed to provide for safety, full accessibility, mobility, and usability by the elderly and the handicapped. Special consideration will be given to architectural and travel barriers so as not to impede the disabled from having full access to station facilities.

The passenger information system will be designed with the goal of eliminating "blind spots" in the communication of information to the handicapped. The information system will maintain the orientation of the handicapped passenger throughout the use of the system (i.e., it should be "reaffirming").

Except for stations where public parking is provided, handicapped parking spaces will not be required. However, provisions will be made so as not to restrict persons in wheelchairs by interrupted or abrupt changes in surface levels.

Where handicapped parking spaces are provided, they will be a minimum of 12'-0" wide and located as near as possible to the station entrances. The spaces for the use of the handicapped will be clearly marked by signs. A minimum of one handicapped space will be provided and at least one space for each 50 additional spaces will be designated for the handicapped. The handicapped spaces will be located on a level surface, suitable for wheeling and walking, and in a manner so as not to compel individuals in wheelchairs to wheel behind parked cars. These

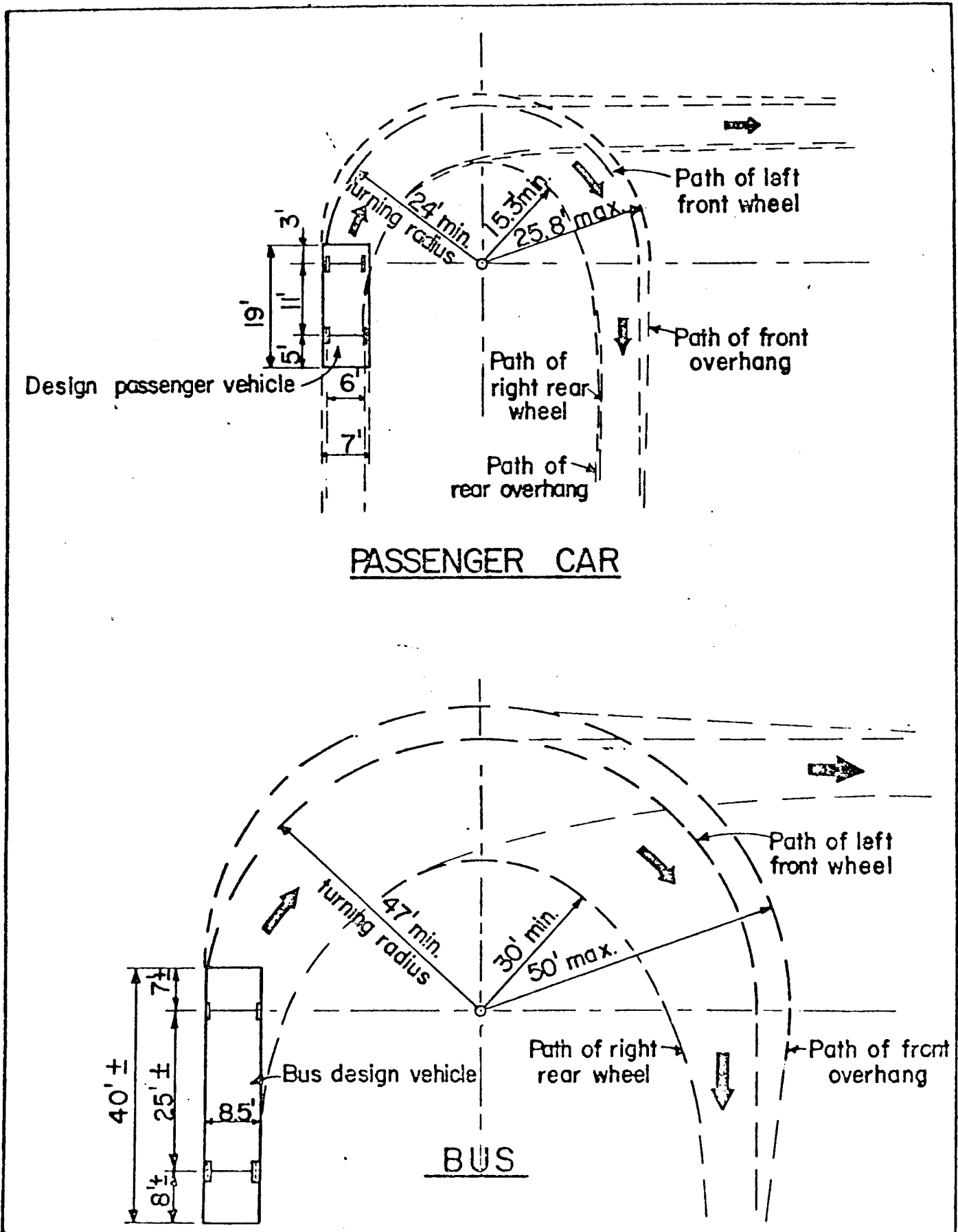
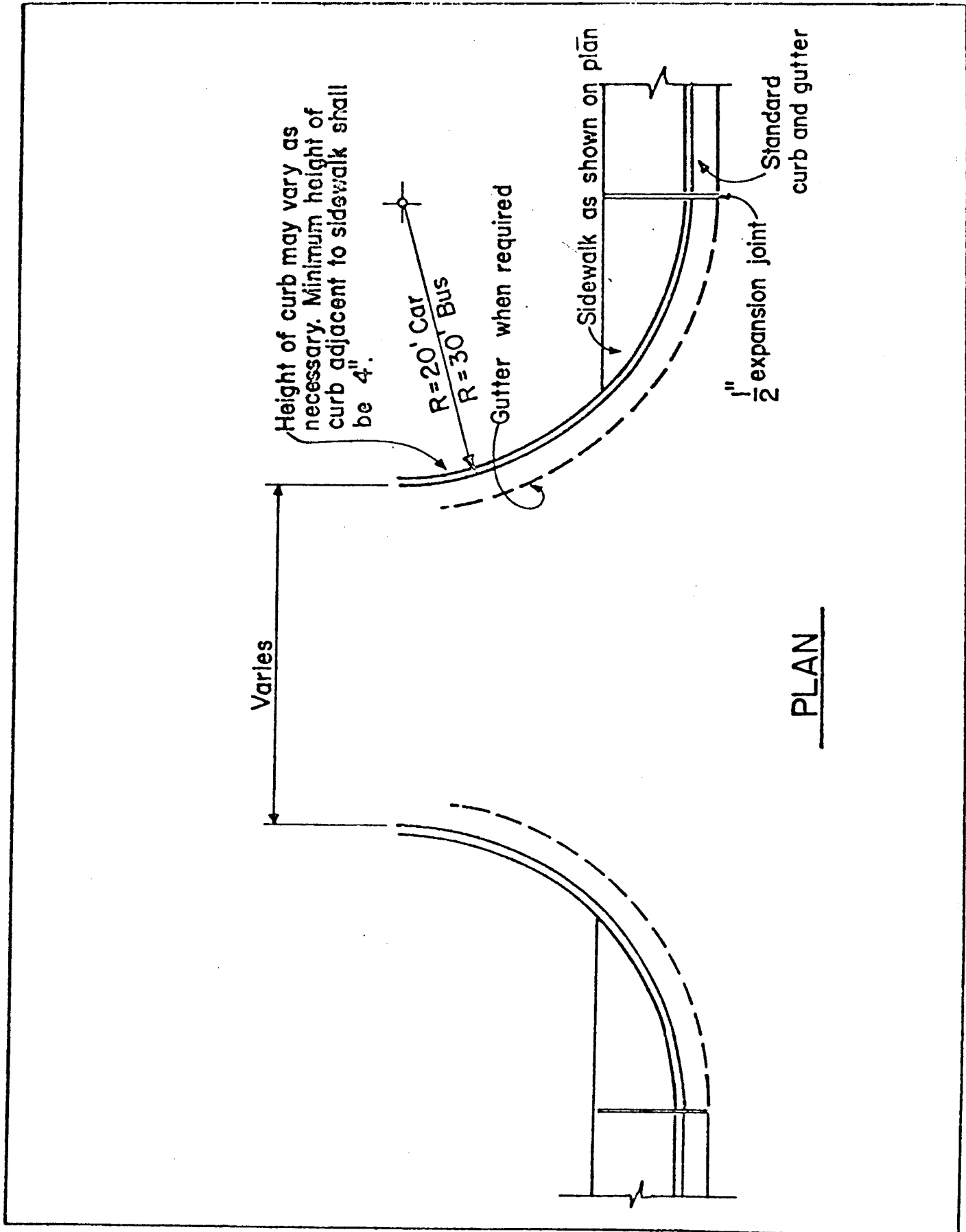

FIGURE 3-44

DESIGN VEHICLES AND MINIMUM TURNING PATHS



DRIVEWAYS FOR PARKING LOTS

FIGURE 3-45

requirements also apply to parking for the Control, Maintenance, and Storage Areas.

Vertical circulation will be provided by means of elevators designed for safe operation by persons in wheelchairs or with other physical disabilities. Stairs will be designed with special considerations for elderly and handicapped.

Elevators shall be accessible to and usable by the physically disabled on the level that they use to enter the JASE stations and at levels normally used by the general public. Elevators will meet the "Minimum Passenger Requirements for the Handicapped", Chapter 399.035, Department of Business Regulation, Bureau of Elevator Inspection, State of Florida, as well as ANSI A117.1, "Specifications for Making Building and Facilities Accessible to and Usable by Physically Handicapped People", 1980.

Where ramps are necessary, they will be a minimum of 44" wide and shall have a slope no greater than 8.33%, with a slope of 1:20 preferred. Ramps shall have handrails that are 32" in height, measured vertically from the surface of the ramp; they shall be smooth and extend 1'-0" beyond the top and bottom of the ramp. Ramps shall have a smooth but slip-resistant surface, a 6'-0" straight level surface at the bottom, and a level platform at 30'-0" intervals, or where turns occur in the ramp.

The JASE stations shall provide a service gate for the physically handicapped. Operation of the gate shall be controlled from the system's Central Control with closed-circuit camera supervision. The gate will be 3'-8" wide. Those eligible will be issued a fare card by JTA. Otherwise, the elderly or handicapped passenger will use the phone provided to contact Central Control.

Flooring materials used in the vicinity of the JASE stations shall not present an obstacle to wheelchair movement or to individuals with walking disabilities. Flooring within the JASE stations shall have a non-slip surface and the floors adjacent to unprotected areas of danger, such as platform edges, shall have a different texture than that used on the remainder of the platform.

Identification signs shall be mounted to permit recognition by the partially sighted at a height between 4'-6" and 5'-6". Tactile labels with raised or recessed letters and numerals shall be used; braille letters and numbers may be used in addition. Elevators shall also contain provisions for those with sighted disability.

A 2-way telephone shall connect each station with Central Control. This telephone shall be located near fare collection equipment separating the free and paid area and shall be within reach from a wheelchair requiring the use of only one hand. The 2-way telephone shall be accessible from both paid and unpaid areas. A sign shall be provided in braille advising the blind to contact Central Control for assistance in use of the system. A sign in English shall advise other patrons concerning use of this phone.

All walks crossing driveways or streets used by the physically handicapped will taper down to a common level by the use of curb cuts. Cuts will be located where it is impossible for them to be obstructed by cars and shall have a textured, non-slip surface. The minimum width for a curb cut shall be 40" and shall have a slope of 8.3% or 1" in 12".

Architectural Criteria

. General Criteria

The Jacksonville ASE will include 7 stations, each to be built at a different location within Downtown Jacksonville (see Figure 2-8). The basic size, configuration, and function will be similar throughout the various stations. The Central Station and the Jefferson Street Station will be transfer stations. All stations are of the single-level central platform design.

The stations will be accessible and barrier-free to the elderly and handicapped. Stations will be designed so that a station agent will not be required. Stations will not be heated or air conditioned.

Each station will have a "free" area which will be accessible from public sidewalks and pedestrian bridges. The free area will be separated from the paid area by a fare collection barrier which will include fare collection equipment, fixed parapets, balustrades, and special elderly and handicapped fare gates.

. Specific Criteria

(1) Horizontal Alignment

Stations will be integrated, wherever possible, into existing or planned structures. For all stations, the guideway facing the street will be kept tangent. "S" curves will be used to offset the guideway on the building side to provide clearance for the center platform.

(2) Vertical Alignment

Typically, intermodal type JASE stations shall have two levels: an entrance level at grade and a platform level as shown in Figure 3-35; an optional mezzanine level is shown for potential accommodation of a second-level walkway. A minimum street clearance of 17'-0" is required. Typically, urban JASE stations shall have three levels: an entrance level at grade, a second level pedestrian walkway, and a platform level as shown in Figure 3-36.

The station platform area shall be protected from the sun and inclement weather by a permanent roof. This roof and all appurtenances should remain outside the vehicle clearance envelope (see Figure 3-34). The

roof shall extend over the guideway so as to provide protection to patrons on the platform from rain driven at a 35° angle to the vertical.

(3) Guideway/Station Interface

The guideway and station structure will be structurally isolated from adjacent structures and property to minimize vibration transmission and facilitate joint development potential.

(4) Station Entry and Exit

Special consideration will be given to the station's integration with proposed and established pedestrian traffic patterns. Walkways, ramps, and stairs will be the primary means of access to all stations. Special access provisions for bus transfer will be provided at intermodal stations including the FJC and St. Johns Place Stations. Pedestrian directional signs will be located at the farthest point of access to the walkways and ground level pedestrian areas to guide the patrons in successive steps to their destination. Such design techniques as subtle changes in paving and the use of color, will supplement the graphics and communications system to identify entrances to station areas as well as other station elements of importance to the pedestrian.

(5) Queuing Area and Fare Purchase

Queuing areas must be provided at all areas where patrons may be required to wait in groups. Such places include the top and bottom of all vertical circulation elements, heavy traffic points at grade or on the walkways, at the free side of the fare barrier, and at the principal loading points on the platform. Such queuing areas shall be designed to facilitate and not interfere with the smooth pedestrian flow within the station. Queuing spaces will not overlap but may be included in other lesser used spaces.

(6) Auto and Taxi Zones

Provisions for a drop-off zone for buses and taxis will be provided at intermodal type stations only. These areas will be clearly identified and within easy access to the station's entrance and information center at street level. Provisions will be made for curb cuts, ramps, and drop-off areas of adequate size and protection, as appropriate, to accommodate the handicapped.

(7) Bus Interface

One of the main purposes of the JASE System is to facilitate the transfer of bus passengers to the JASE System at the ends of the line in order to reduce patron travel time, streamline bus operations, and

reduce congestion in the city core. Therefore, special considerations will be incorporated into all intermodal type stations to transfer patrons from bus to the JASE and from the JASE to the bus in the most direct way possible. A typical JTA bus has two doors on the right side and is about 41' long by 8'-5" wide by 10'-5" high with 10" mirrors on both sides. All canopies and station features shall be designed to meet these dimensions.

(8) Heating, Ventilating, and Air Conditioning

Stations will be open structures; consequently, there will be no provisions for air conditioning. However, each station may require platform windscreens designed to adequately provide protection from the sun and wind-driven rain. There shall be no provisions for heating but power ventilation may be required.

(9) Lighting

Lighting in the JASE stations will be such as to enhance safety, security, and comfort; facilitate passenger circulation; and assure no sudden transitions from light to dark areas. Station illumination will be accomplished with a limited system of lighting fixtures and lamp types to simplify maintenance and minimize storage of spare parts and lamps. As a minimum, the various areas of the stations shall be illuminated to the minimum average maintained levels indicated in Table 3-11, measured in a horizontal plane at the floor level.

TABLE 3-11

MINIMUM AVERAGE ILLUMINATION

<u>STATION AREA</u>	<u>RANGE OF MINIMUM AVERAGE MAINTAINED (foot-candles)</u>
Station and Escalator Entrances	20-25
Stairs and Escalators	20-25
Interior of Elevators	20-25
Fare Collection, Change Machines, Information	30-40
Platform/Concourse	15-20
Electrical/Mechanical Rooms	20-25*
Central Control	30-40*
Battery Rooms	10-15*
Train Control Rooms	30-40*

* Non-public areas on a horizontal plane 30" above the finished floor

(10) Materials and Interior Finish

As a general design philosophy, each station will be given its own visual identity by the use of surface material and interior finishes. A list of representative material will be prepared to guide the designer. The use of such materials in order to implement the correct design are:

- * Use and placement of materials will be designed to resist vandalism and promote pride in the system.
- * Materials will be selected for cost-effectiveness, durability, ease of replacement, and low maintenance.
- * The design of the station will attempt to reflect the positive character or at least blend and not conflict with it.
- * Interior finishes and design will facilitate the use of the system by the elderly and the handicapped.

Concrete is the appropriate and readily available material for this area. Because of the construction-associated savings, local availability, speed and relative ease of erection, and quality control benefits, serious consideration should be given to precast concrete as the primary structural and skin material.

The stations will have materials and devices which attenuate internally-generated noise and absorb and limit reverberation time of noise from all sources. The placement of these materials and devices will be such as to allow normal conversation and provide for good intelligibility of public address announcements throughout the station area.

(11) Station Graphics

All graphic messages will be in English. Passenger information and directions will be provided at certain locations such as station entrance elevators and fare collection areas and shall meet all elderly and handicapped requirements. The graphics will use international symbols along with the verbal information. The location of directional graphics will be in advance of decision-making points so that alternatives can be quickly recognized and patrons can proceed with confidence and minimum hesitation. Since station functional arrangements shall be uniform, the station graphic locations will be standardized to minimize patron confusion at various stations.

(12) Passenger Information System

Informational graphics, such as system maps, diagrams, and instructional displays for all patrons, including the blind or partially sighted, will be provided and located both at platform and street levels, separate from the primary circulation routes so as not to interfere with the patron's normal flow. Signs in the station visible from within the vehicle or on the station platform will clearly indicate the name of each station.

(13) Fare Barriers

Each station will provide for one or more fare barriers. Each fare barrier will contain a minimum of two fare gates. The location and number of these barriers shall be such as to provide ready access to the JASE stations for patrons approaching the station from any anticipated source and insure the payment of fares. Each barrier will fill the total horizontal space separating the free and paid areas.

Access for the elderly and handicapped shall be provided through special E&H gates which will contain fare collection equipment. The fare gate will be 3'-8" wide and the height of the fare collection console 30". The gate will be remotely controlled by Central Control for the payment of the correct fare.

(14) Stairs

Two stairs will be provided at each station. One stair will be located at each end of the station platform. Stair location design is intended to encourage their use by patrons as a primary means of vertical circulation. The stairs will be open so that visual contact and surveillance from street level can be maintained at all times.

(15) Elevators

Elevators shall be accessible to and usable by the physically disabled on the level they enter the JASE stations and at levels normally used by the general public. One elevator will be provided for vertical circulation in each JASE station. Signs will give priority to elderly and handicapped patrons.

(16) Escalators

All stations will be provided with at least one escalator. Escalators will be operated at a speed of 90' per minute, reversible. A minimum of 3 flat steps will be provided at the top and bottom landings to facilitate use by the handicapped and elderly.

Escalator treads will be either 32" wide or 48" wide, heavy-duty, self-contained units. Each escalator will be equipped with an emergency stop button. They will be of weather-proof design and will allow for thermal expansion and contraction. All exterior steel on the escalators will be stainless steel. A 12' minimum queuing area will be provided at entrance to all escalators.

(17) Landscaping

Vegetation is an integral part of the open-station concept. It is one of the essential elements in achieving a pleasant setting for the

patrons. Landscaping will be confined to the ground level in built-in planters. Native plant materials will be used wherever possible to assure hardy, low-maintenance results.

CONTROL, MAINTENANCE, AND STORAGE AREA

General

The Control, Maintenance, and Storage Area (CMSA) for the JASE System will include three functional areas: shops, the Central Control facility, and storage yards. The shops would be an enclosed area where the JASE vehicles would be taken off-line to receive routine maintenance, repair, inspections, and overhaul. Major maintenance, such as body repair and painting, would be done in the bus maintenance shops of the JTA by removing the vehicles from the tracks and transporting them over the public streets. Adjacent to the shops would be located a main yard to store vehicles overnight or when out-of-revenue service. A schematic of the site plan and functional layout of the CMSA appears in Figures 3-46 and 3-47.

Maintenance activities performed at the facility include:

- * Service - The replacement of consumables, e.g., oil and grease.
- * Cleaning - Interior and exterior cleaning of accumulated trash and soil.
- * Inspection - Periodic inspection of all parts, appurtenances, and subsystems subject to deterioration and failure.
- * Repair - The repair or replacement of parts that have failed or are nearing the end of their life cycle.

Powered guideway is provided to accommodate the movement of vehicles both into, out of, and within the CMSA. A test track and equipment required for vehicle departure testing will also be provided at the CMSA.

Central Control Center

The Central Control Facility for the JASE System will be located in the same building as the maintenance shops at the CMSA. The Central Control Facility will include electronic control and monitoring equipment, manned during operation of the JASE System, and offices for personnel and records management. From the Central Control Facility, an operator could command the driverless vehicles and station signing, lighting, and surveillance by using advanced communications systems and computers. This computer equipment will also allow automatic control of the system operation; such activities include vehicle routing, acceleration, stopping, door operation, and standard announcements. Computers will continuously monitor the operation of the system for instances of improper operation and failure. Display equipment at the Central Control Facility will also allow the operator to monitor dynamic system operation and provide him with 2-way voice communications with each JASE vehicle and station. In addition, closed-circuit television will allow

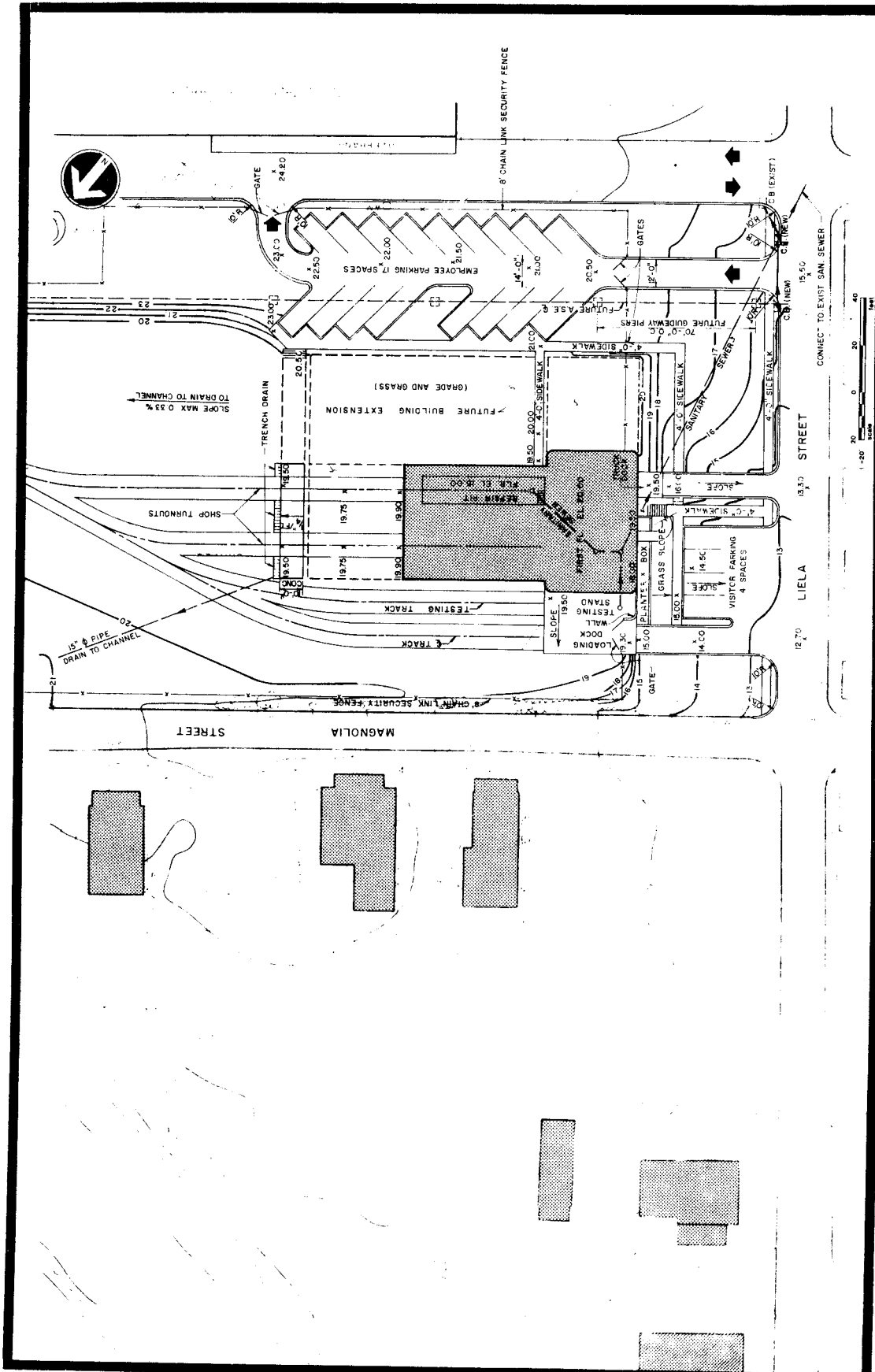
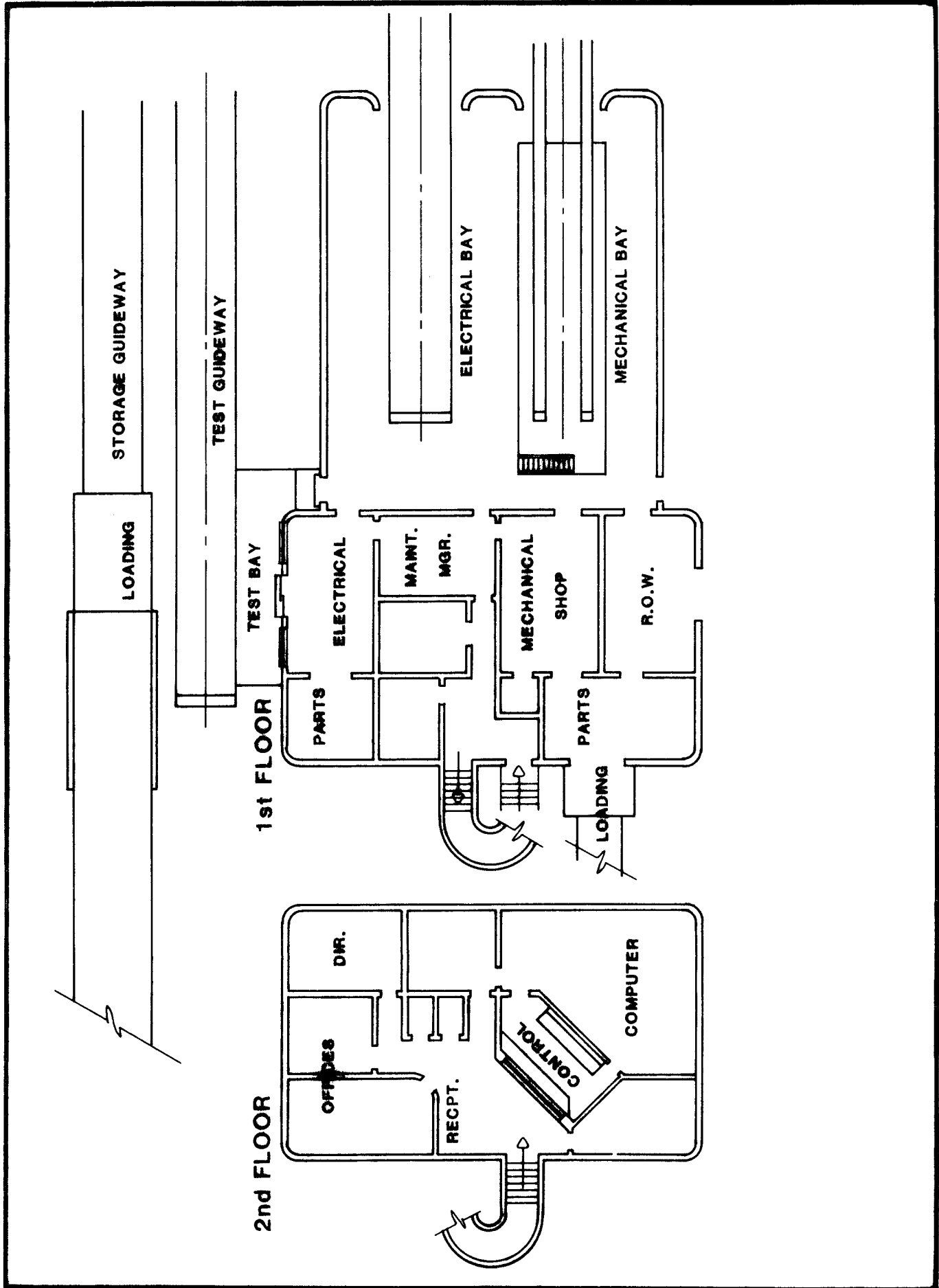

FIGURE 3-46 CONTROL, MAINTENANCE, AND STORAGE AREA SITE PLAN



CONTROL AND MAINTENANCE FACILITY

FIGURE 3-47

the Central Control Operator to observe activities in each station. During periods when the JASE System will not be in operation and the Central Control Facility is unmanned, the security of the JASE facilities will be monitored by ultrasonic or video-activated intrusion alarms connected to a 24-hour-a-day manned security center. A typical control center is shown in Figure 3-48.

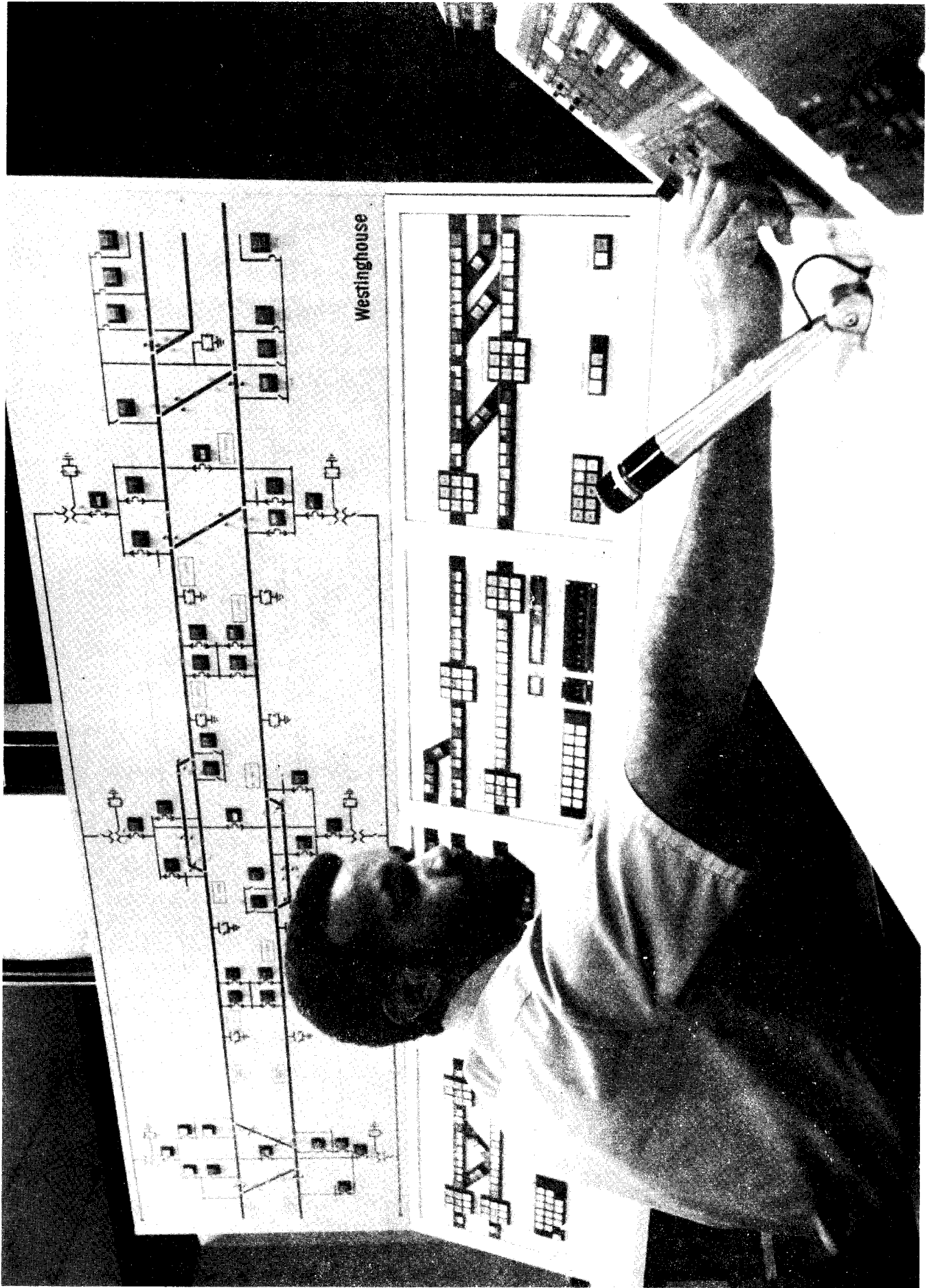

TYPICAL CONTROL CENTER

FIGURE 3-48

OPERATIONAL CHARACTERISTICS

PATRONAGE FORECASTS

Patronage is at the heart of expected JASE performance and is the primary measure of required capacity. It influences nearly all other design requirements. It also serves as the base that determines system design, operational scenarios, costs, revenues, funding schemes, development forecasts, and many technical decisions. In addition, the patronage of a system reflects the vitality of its transportation setting and economic environment and, to some extent, the suitability of this type of transit system for this particular deployment. The process of transportation forecasting is well developed and the basic travel characteristics of most people are predictable. The ridership projections given here are accurate from both a technical and a practical standpoint.

Assumptions

The assumptions used in the projections were adopted by the JASE Task Force, CAC, and JTA Board and include:

- 1) 2-minute peak period headways; 14 hours, 7-day-a-week operation;
- 2) \$0.25 fare with free transfer bus-to-JASE in 1982 dollars;
- 3) most regional bus lines terminate at JASE transfer points and the regional transit system remains the same;
- 4) 4 downtown shuttle bus lines on 8-minute headways;
- 5) 1985 CBD parking of 175% of 1968 charges;
- 6) all monetary values are based on constant dollars for cost of travel with no increase for gasoline or basic changes in auto access policies; and
- 7) no special events are included, nor are convention, tourist or joyriding trips, and no increased pedestrian access due to the skywalk system is assumed.

These assumptions were adopted to insure conservative estimates of the JASE patronage. Of all the assumptions, the travel costs, including fuel, represent the greatest unknown and therefore were held constant. However, any sharp increase in gasoline cost will produce a corresponding increase in JASE travel demand. It will also affect fare elasticity since a high gasoline cost will reduce the resistance to fare increases and their effect on ridership.

JASE Segment Alternatives

In the first phase of the patronage analysis, seven different variations of the JASE System were under study. The Full Recommended System, Segment A, has two lines: one (N/W) from the Medical Center to Park-Riverside and the other (S/E) from Government Center to St. Johns Place (Figure 4-1). The other six systems are shorter versions of this system. The purpose of evaluating the other systems is to determine

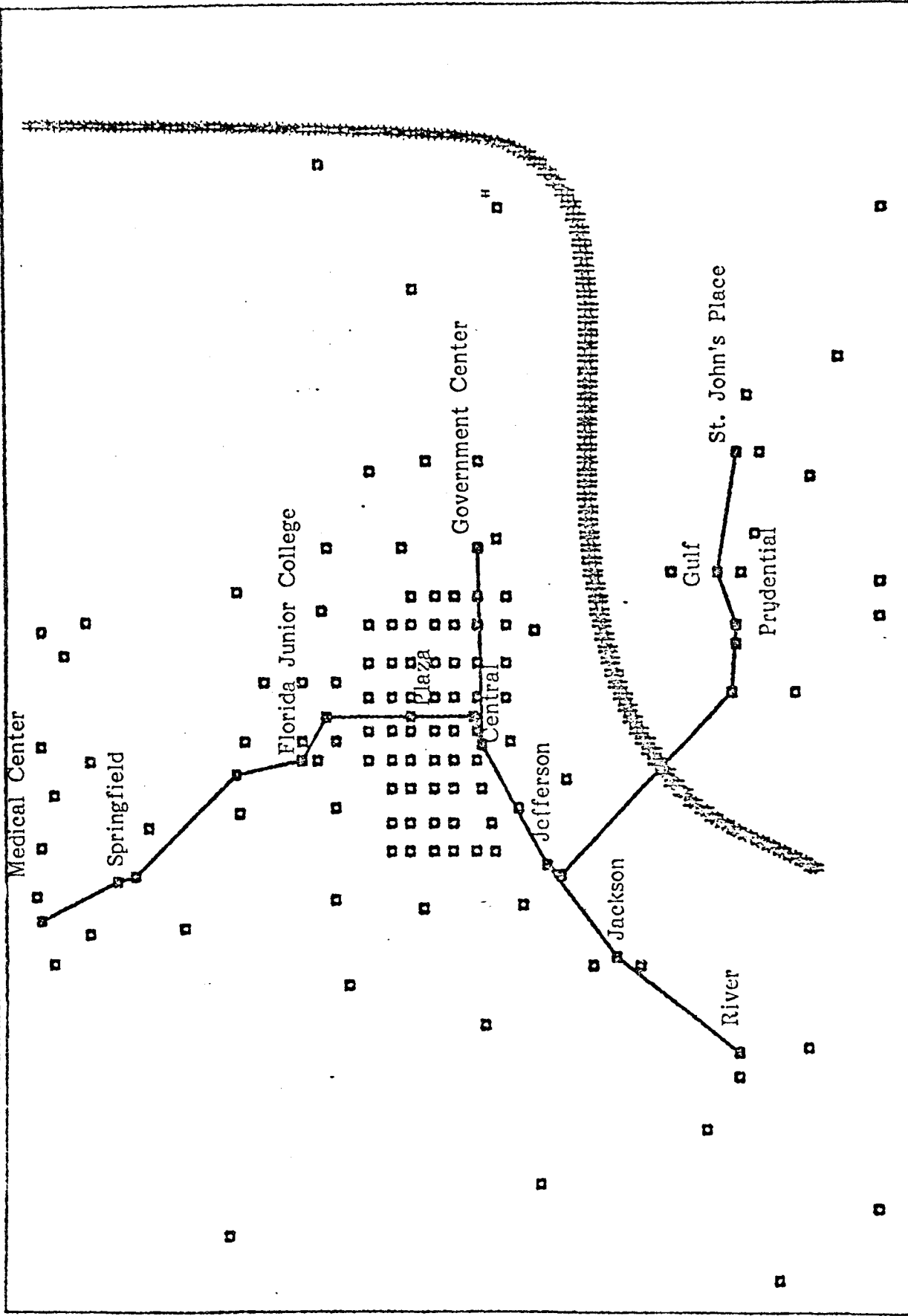

DESIGN 1 BASE NETWORK

SOURCE: Robert J. Harmon & Associates, Inc.

FIGURE 4-1

FULL RECOMMENDED SYSTEM

which portion of the Full System is the best to build as the initial segment.

The B Segment has one line running from Medical Center to Riverside Station. Segment C has one line running from Government Center to St. Johns Place.

The next two segments test switching the terminal stations of the two lines in the Full System. Segment D runs from the Medical Center to St. Johns Place and Segment E starts at Government Center and ends at Riverside Station.

The final two segments start at the Florida Junior College (FJC) and run to the two alternate southern termini. Segment F runs from FJC to Riverside and Segment G goes from FJC to St. Johns Place.

Methodology

The methodology of this study consisted of three major phases: (1) alteration of existing trip tables to reflect the most recent information concerning future land use; (2) preliminary estimates of ridership for the Full Recommended System and the six shorter segments; and (3) detailed patronage estimates of the Full Recommended System and the chosen Initial Segment. Each major phase consisted of several specific steps which are diagrammed in Figure 4-2.

Origin and destination matrices, which give the number of people traveling between any two zones and are based upon land use, were available from the updated Jacksonville Urban Area Transportation Study. Six market segments had been identified as being of primary importance in predicting the number of people using the system. These are circulation, transit, and highway trips during both the noon and PM peak hours. Therefore, there were six origin and destination matrices reflecting the six market segments.

Since new information concerning predicted land uses had been developed, revision of these tables was necessary. Factors to reflect the changed estimates were developed to redistribute the origins and destinations of trips both within the study area and on a regional basis. Using these factors, the tables were factored using a program in the Planpack computer package supported by the Federal Highway Administration.

These adjusted tables were then input to the Transit Network OPTimization (TNOP) package which assigns trips to paths using a probabilistic assignment algorithm. This model assigns pedestrian and transit trips to paths using combinations of three modes: bus, JASE, or pedestrian trips on the local street system. Park-n-ride trips are also assigned as either bus, JASE, or highway trips. The summation of the three types of trips on the three modes was disaggregated to determine ridership by mode.

The following sections of this report explain each of these steps in

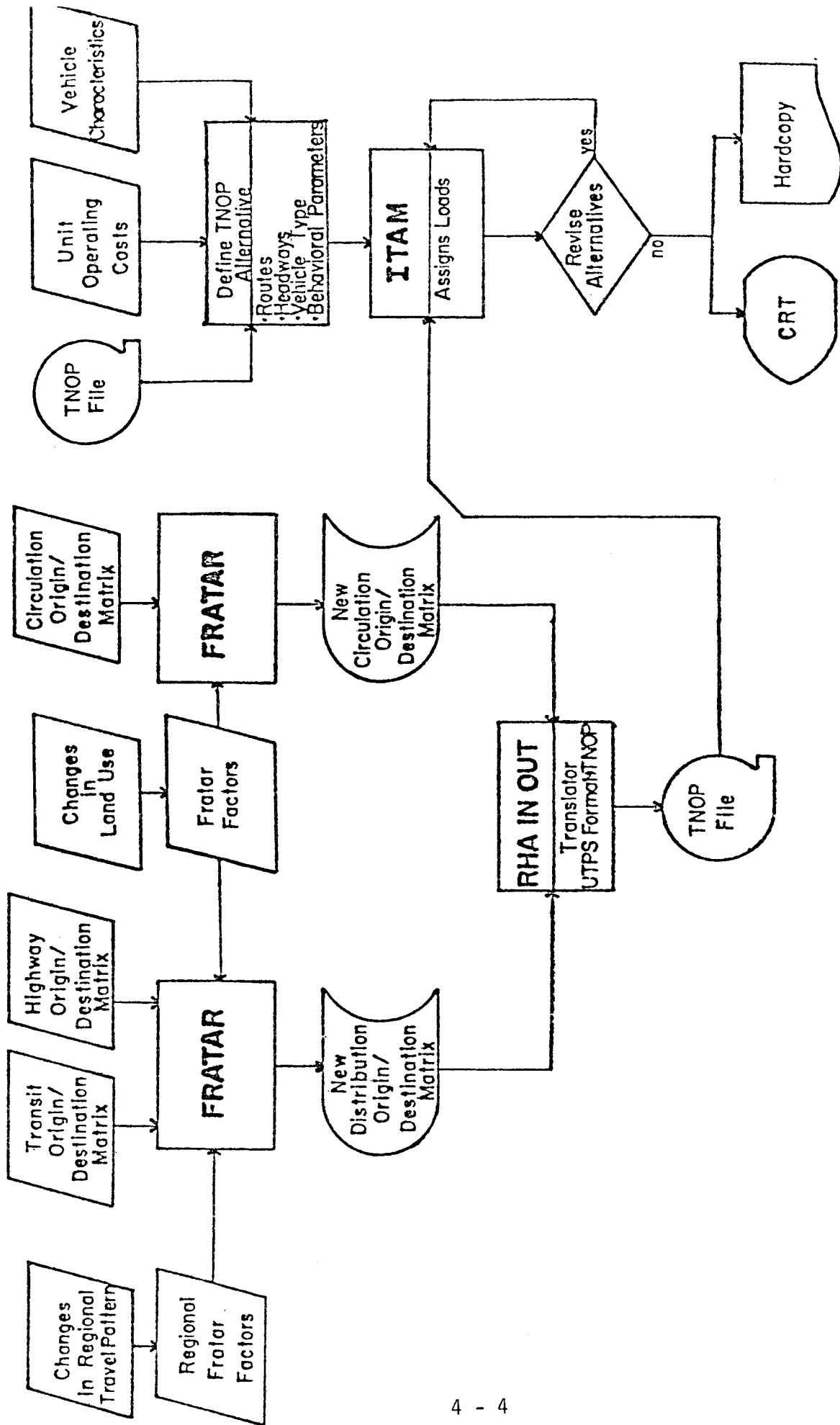

SOURCE: Robert J. Harmon & Associates, Inc. (RIIA)

FIGURE 4-2

further detail, presenting both the assumptions made in the step and the pertinent results.

. Land Use Estimation

As a first step in determining the change in travel patterns between 1978 and the two target years, Robert J. Harmon & Associates, Inc. reviewed and revised the 1978 land use files to reflect current development plans. Field survey data collected on potential joint development projects were compared with previous estimates of joint development and with earlier economic projections.

The 1978 land use file provides an accurate base-year estimate of land use by space use category and JASE zone. Land use was adjusted and added to the file for the two target years, 1985 and 1995. The development projects included are assumed to be built and occupied by these target years. These projects, in fact, are expected to occur during these time periods as the Jacksonville market and local office space demand requires and financing commitments allow.

This update only reallocates previous estimates of future development among JASE zones and reflects refined developer plans for projects within Downtown Jacksonville. Subarea land use control totals (Table 4-1) remain unchanged from the Feasibility Study and no new economic or demographic projections have been prepared to update and/or revise the control total projections. Changes in Downtown space demand and recent changes in the economic climate in Jacksonville indicate that regional growth projections must also be changed, as discussed in the following section.

Further detail may be found in two recent RHA technical memoranda: Jacksonville Downtown People Mover: Revised Land Use File, March 6, 1981 and Identification and Classification of Potential Joint Development Projects, January 26, 1981.

. Alterations to Trip Tables

Twelve trip tables were provided to RHA for 1985 and 1995 for circulation, bus, and highway trips for the noon hour and the PM peak hour. These trip tables were developed based on projections of land use made during the Feasibility Study. Since that study, joint development projects have been tabled, new ones proposed, and others moved so alteration of the trip tables was necessary. However, since the total amount of development in Downtown Jacksonville was judged to be relatively unchanged, the total number of trips was assumed to remain constant (Table 4-2). Fratar factors, commonly used as a method to simulate new trips associated with future development, were developed to redistribute the trips in a manner which reflects the changes in land use predictions.

TABLE 4-1
DEVELOPMENT BY SUBAREA AND LAND USE CATEGORY
DOWNTOWN JACKSONVILLE 1978 - 1995

AREA USE CATEGORY	SQUARE FEET (000)		
	1978	1995	1995
TOTAL			
Office	6,700	8,307	12,129
Retail	4,050	4,250	4,474
Lodging	675 (rooms)	1,500	2,200
Residential	900 (units)	936	2,186
Other	0	136	266
CORE			
Office	5,200	6,507	8,394
Retail	3,450	3,616	3,761
Lodging	250 (rooms)	800 (rooms)	1,200 (rooms)
Residential	900 (units)	936 (units)	1,236 (units)
Other	0	106	235
SOUTHBANK			
Office	1,100	1,340	3,030
Retail	250	281	349
Lodging	425 (rooms)	700 (rooms)	1,000 (rooms)
Residential	0 (units)	0 (units)	750 (units)
Other	0	0	0
PARK-RIVERSIDE			
Office	400	460	705
Retail	350	353	364
Lodging	0 (rooms)	0 (rooms)	0 (rooms)
Residential	0 (units)	0 (units)	200 (units)
Other	0	30	30

SOURCE: Robert J. Harmon & Associates, Inc. (RHA)

TABLE 4-2

JACKSONVILLE ASE STUDY

TOTAL TRAVEL IN STUDY AREA BY ALL MODES

	<u>1985</u>	<u>1995</u>	<u>RATIO</u> <u>1995/1985</u>
Noon Hour			
Highway(1)	17,091	19,963	1.168
Transit(2)	2,203	2,545	1.155
Circulation	<u>32,356</u>	<u>40,181</u>	1.242
	<u>51,650</u>	<u>62,689</u>	1.214
PM Peak Hour			
Highway(1)	38,468	54,105	1.406
Transit(2)	6,896	8,751	1.269
Circulation	<u>9,113</u>	<u>10,754</u>	1.180
	<u>54,477</u>	<u>73,610</u>	1.351

Notes:

- (1) Highway trips include only trips with at least one end in the study area.
- (2) Transit trips include all trips beginning, ending, or passing through JASE study area.

SOURCE: Robert J. Harmon & Associates, Inc. (RHA)

The factors were developed by calculating the percentage increase in land use between 1978 and 1985 and 1985 and 1995. This percentage was then adjusted to reflect changes in the predominant type of land use in the zone and the trip generation rates associated with that type of land use. For example, a zone which changed from predominantly low-density retail to predominantly high-density office would not experience an increase in trip ends proportionate to the increase in land use, since office space generates fewer trips per square foot than does retail space. This is because trips from office space are generated primarily by office workers, whereas the trips from retail space are generated by shoppers who are far more active.

It was also necessary to develop Fratar factors to redistribute the 1995 external/internal and internal/external transit and highway trips to reflect changes in development in the area of Jacksonville surrounding the study area. This was done by taking a weighted average of the percentage change in trip ends by purpose in each external zone (outside the JASE study area) and applying the weighted average to the results.

. Transit Network Development

The alignment for the JASE, regional bus lines, and shuttle buses were originally decided as part of the earlier Feasibility Study. For this study, the JASE alignment was modified to accommodate the relocation of stations and the addition of parking lots and bus transfer points, interim changes that had been determined by the citizens' committee, and JTA. The regional buses accommodate connections between the transfer stations and the service area beyond the JASE study area. The shuttle bus routes are designed to complement the JASE and connect it with parts of the study area beyond normally acceptable walking distances.

The location and service parameters for the various bus lines were virtually unchanged from the earlier study for the simulation of the Full Recommended System, designated as Segment A in this study of implementation phase options. The Full System is shown in Figure 4-1. At the direction of UMTA and the JTA, analyses were made of six additional segments of the Full Recommended System for purposes of selecting a shorter initial segment of the JASE as a viable starter line.

As part of this analysis of implementation segments, a series of bus lines were developed for connection to the JASE at appropriate transfer points and to provide service in those areas deprived by the elimination of a previously proposed JASE segment. The definition of these lines, according to JTA policy of connecting each regional line to a JASE station at the closest appropriate transfer point and maintaining 1979 service levels, are described in Table 4-3 and shown in Figures 4-3, 4-4, 4-5, and 4-6. Figure 4-3 indicates the regional bus lines and shuttle lines developed during the earlier Feasibility Study and incorporated into the current analysis. Figure 4-4 includes the bus service proposed to replace the missing segments of the JASE during simulation of phased options of the partial system. Figure 4-5 indicates the regional extensions prepared to provide connections between the regional bus system and the alternative starter line segments tested at the beginning of the study. Figure 4-6 shows those lines which are necessary to provide reasonably convenient service when portions of the JASE are eliminated. Table 4-8 is a list of each of the JASE alternatives (A - G) and the regional commuter bus lines, local shuttle bus lines, and local bus replacement service included in each of the alternatives.

Bus Lines

Eleven bus lines were defined in the Feasibility Study and are used in this study as well. Eight of these are regional connectors which tie areas outside the JASE study area to the JASE System. In Table 4-3, these are lines 11 through 18. Most of the lines come from an external node directly to a transfer node. These lines have headways of two minutes, reflecting the JTA policy of minimizing waiting times. Lines 13 and 16 travel along the local street system. To simulate the fact that these lines would not be used for local service, the headways have been increased to 90 minutes. Since those trips going to the external

TABLE 4-3

TRANSIT LINES

LINE	TYPE	DESCRIPTION	HEADWAY (minutes)	LENGTH (miles)	ALTERNATIVES												
					A	B	C	D	E	F	G						
A1	JASE	Medical Center to River	3	1.75	X												
A2	JASE	Government Center to St. Johns Place	3	2.27	X												
B	JASE	Medical Center to River	3	1.75		X											
C	JASE	Government Center to St. Johns Place	3	2.27			X										
D	JASE	Medical Center to St. Johns Place	3	2.77				X									
E	JASE	Medical Center to St. Johns Place	3	1.26					X								
F	JASE	Government Center to River	3	1.08						X							
G	JASE	FJC to St. Johns Place	3	2.10							X						
3	Shuttle Bus	Northside	8	3.43	X	X	X	X	X	X	X	X	X	X	X	X	X
4	Shuttle Bus	Crosstown to Hemming Plaza	8	1.62	X	X	X	X	X	X	X	X	X	X	X	X	X
5	Shuttle Bus	East End Loop	8	1.36	X	X	X	X	X	X	X	X	X	X	X	X	X
6	Shuttle Bus	Park-Riverside	8	2.92	X	X	X	X	X	X	X	X	X	X	X	X	X
7	Shuttle Bus	Liberty Street	8	2.28	X	X	X	X	X	X	X	X	X	X	X	X	X
8	Shuttle Bus	Southside - Cross River	8	3.13	X	X	X	X	X	X	X	X	X	X	X	X	X
11	Regional Bus	NAS	2	-	X	X	X	X	X	X	X	X	X	X	X	X	X
12	Regional Bus	Beaver Street	2	-	X	X	X	X	X	X	X	X	X	X	X	X	X
13	Regional Bus	Westside	90	-	X	X	X	X	X	X	X	X	X	X	X	X	X
14	Regional Bus	Northwest	2	-	X	X	X	X	X	X	X	X	X	X	X	X	X
15	Regional Bus	Northeast	2	-	X	X	X	X	X	X	X	X	X	X	X	X	X
16	Regional Bus	Eastern	2	-	X	X	X	X	X	X	X	X	X	X	X	X	X
17	Regional Bus	Beach	90	-	X	X	X	X	X	X	X	X	X	X	X	X	X
18	Regional Bus	Southside	2	-	X	X	X	X	X	X	X	X	X	X	X	X	X
21	Regional Connector	Park-Riverside to Jefferson Street	90	2.39													
22	Local Circulation	Park-Riverside to Southside	90	3.83													
31	Regional Connector	Beaver Street to Downtown	90	1.70	X	X	X	X	X	X	X	X	X	X	X	X	X
42	Local Circulation	Crosstown to Hemming Plaza	90	2.72													
51	Regional Connector	Northwest	90	2.26													
52	Local Circulation	Northwest Downtown	90	2.44													
61	Regional Connector	Northwest	90	2.10													
62	Local Circulation	Northeast	90	2.30													
81	Regional Connector	Beach to Downtown	30	2.77													
91	Regional Connector	Southside to Downtown via Main Street	30	1.86	X	X	X	X	X	X	X	X	X	X	X	X	X
92	Local Circulation	Southside to Downtown via Acosta Bridge	30	2.78	X	X	X	X	X	X	X	X	X	X	X	X	X

SOURCE: Robert J. Harmon & Associates, Inc.

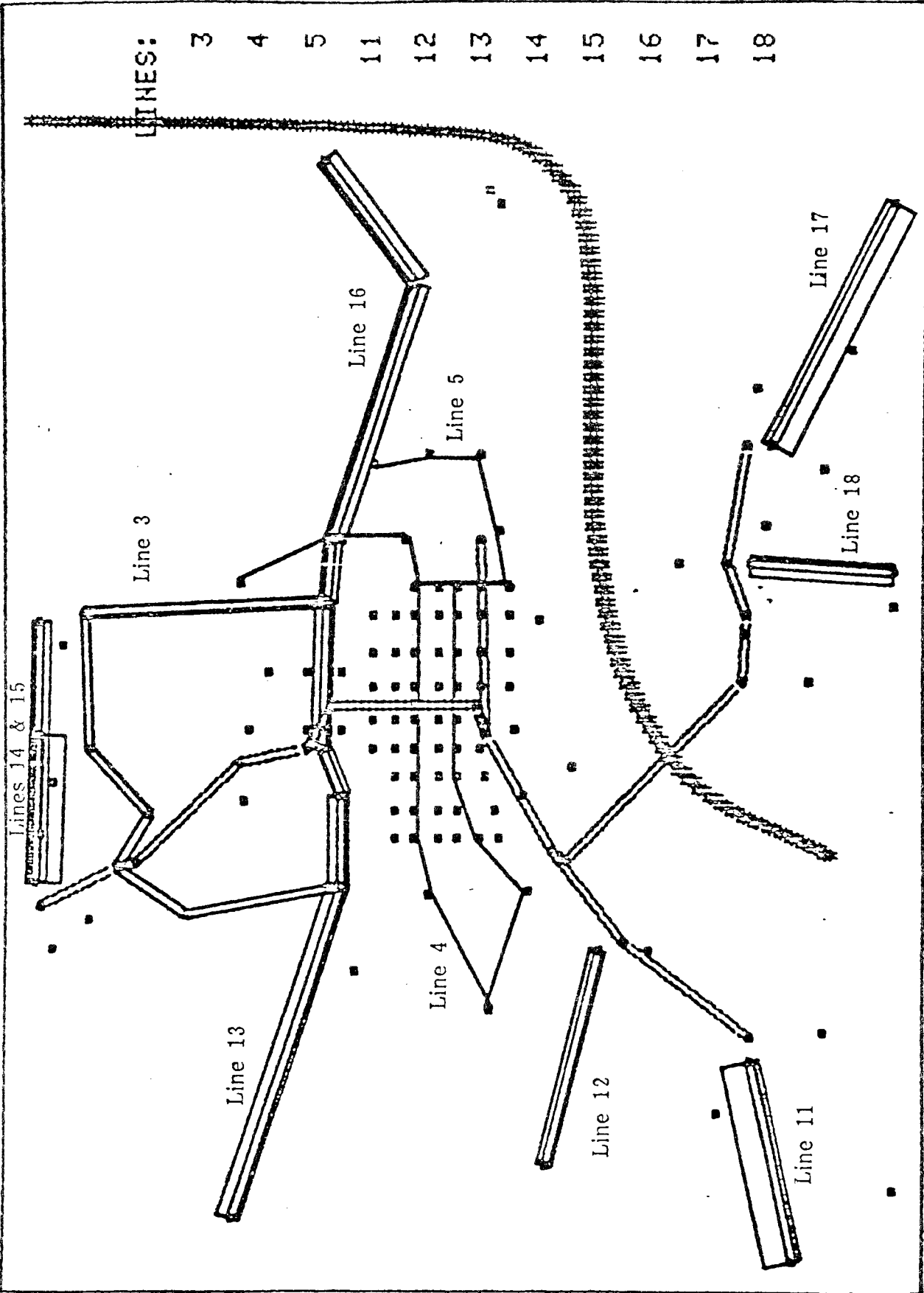

SOURCE: Robert J. Harmon & Associates, Inc.

FIGURE 4-3

RHA - JACKSONVILLE - 1995 - HOON TRANSIT - 4/20/81

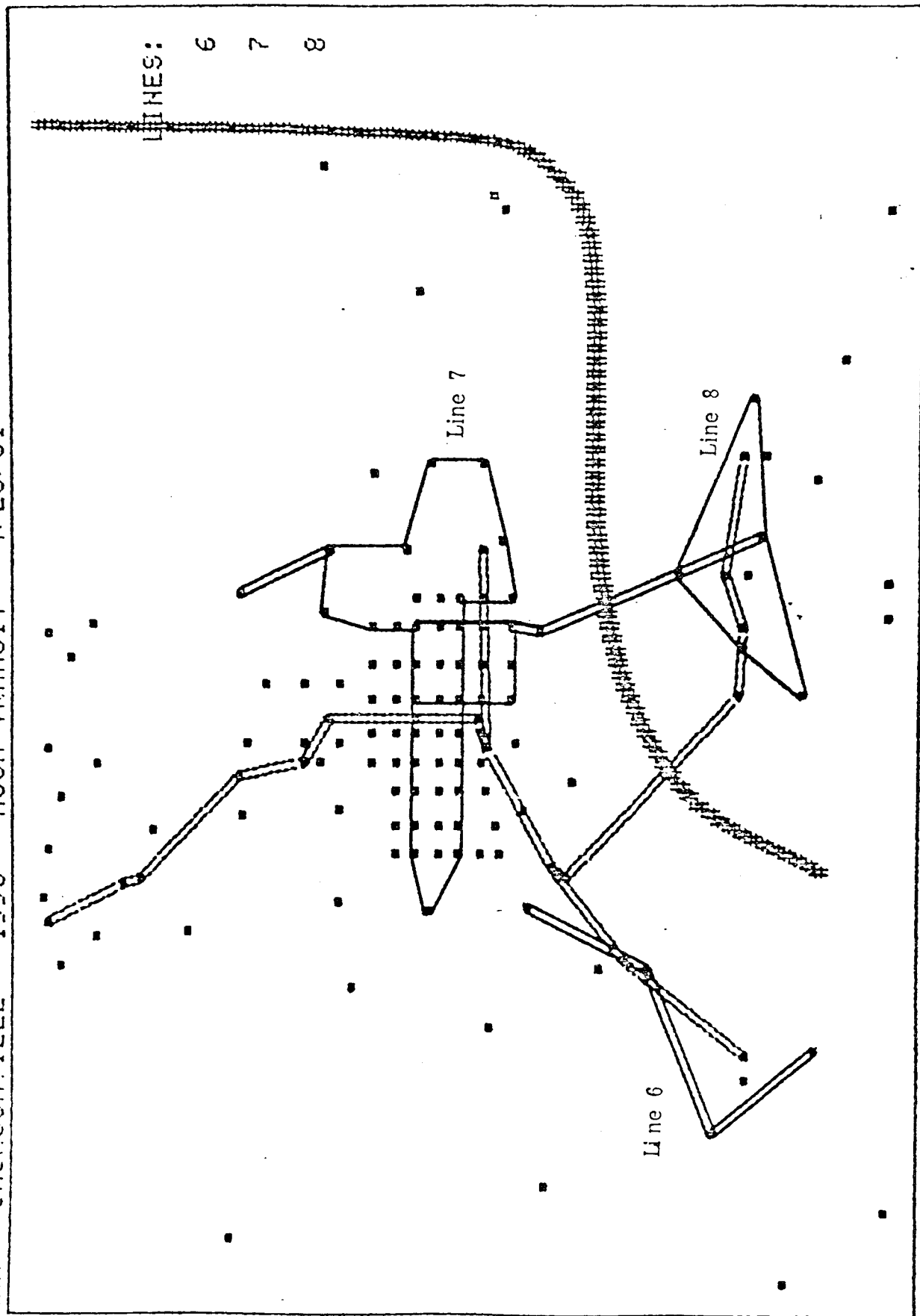

DESIGN 4 TRANSIT LINE LOADINGS

1000 TRIPS

SOURCE: Robert J. Harmon & Associates, Inc.

FIGURE 4-4

REPLACEMENT LINES

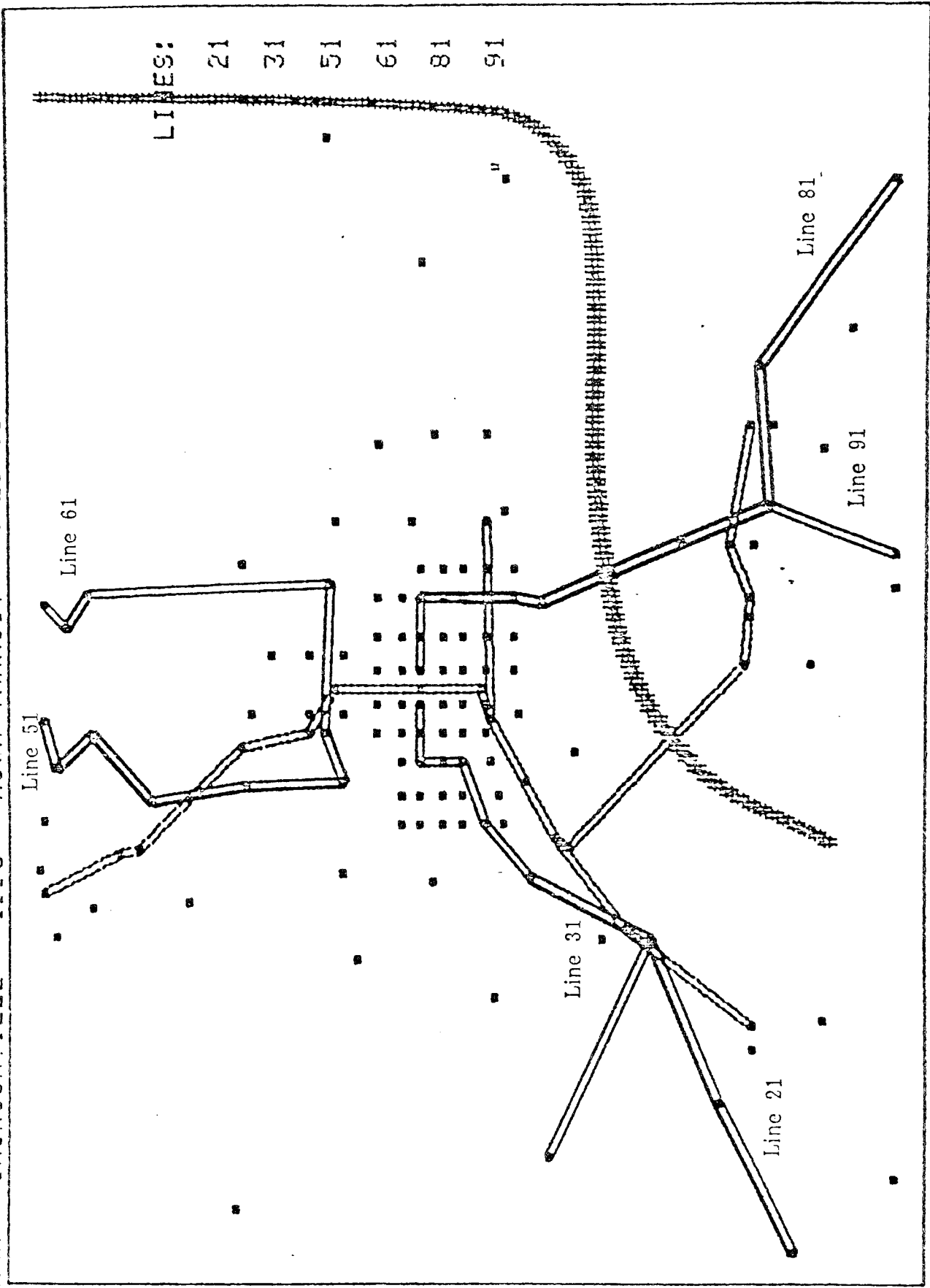

DESIGN 4 TRANSIT LINE LOADINGS 1000 TRIPS

SOURCE: Robert J. Harmon & Associates, Inc.

FIGURE 4-5

REGIONAL EXTENSIONS

RHA - JACKSONVILLE - 1995 - NOON TRANSIT

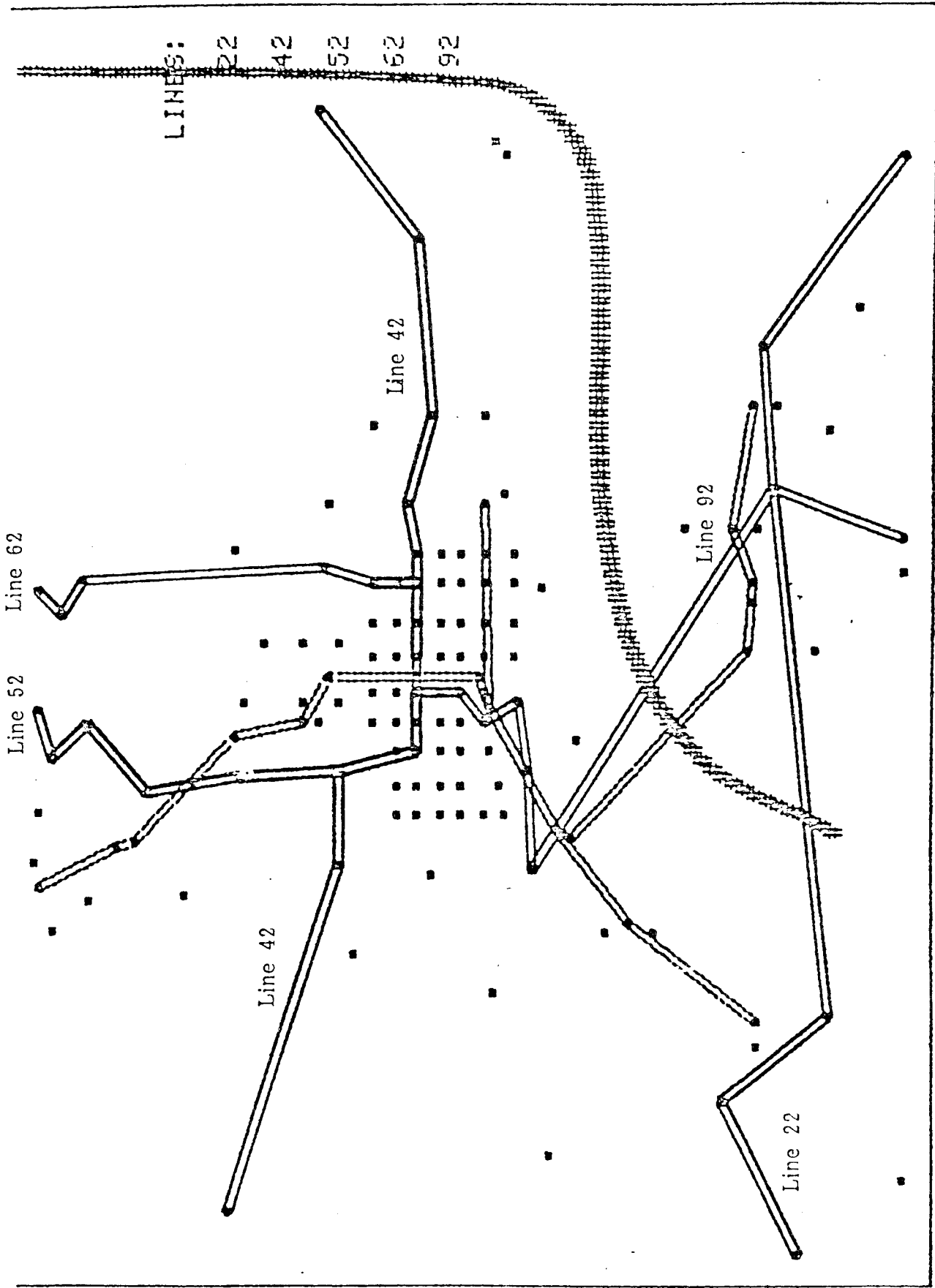

DESIGN 4 TRANSIT LINE LOADINGS

1000 TRIPS

SOURCE: Robert J. Harmon & Associates, Inc.

FIGURE 4-6

LOCAL CIRCULATION LINES

zones have no choice but to use these lines, patronage is not affected and local service is excluded.

The other three of the 11 original lines are shuttle buses feeding into the JASE from the Downtown. Line 3 loops through the northern portion of the CBD, connecting with the JASE at both the Springfield and Florida Junior College Stations. Line 4 serves the western portions of the CBD, parts of the eastern section, and the Hemming Plaza Station. Line 5 serves the far eastern portion of the CBD and connects with the JASE at Government Center.

In those systems which do not run to Government Center, access to the JASE from the east side would require a transfer between lines 4 and 5, if these were the only shuttle buses provided. It would also be impossible to cross the river on certain systems and impossible to get to Park-Riverside on others. For these systems, the additional shuttle buses shown in Figure 4-4 were created. Line 6 links Park-Riverside to the Downtown. Line 7 covers the same route as lines 4 and 5 and eliminates the need for a transfer. Line 8 provides circulation on the Southside and connects it to the Downtown.

The regional connectors, shown in Figure 4-5, connect the areas outside the study area to the shortened JASE. Lines 21 and 31 provide service from the east to the Downtown when the Park-Riverside section of the JASE is eliminated. Lines 51 and 61 provide service from the north to the Florida Junior College Station when the rail system is cut back to that station. Lines 81 and 91 connect the Southside to the Downtown when the JASE does not.

As the JASE is cut back, the difficulty of making certain trips will increase to the point that they will probably not be made. However, the methodology assumes that the trip-making patterns induced by the Full System are inviolate. To avoid unrealistically high patronage estimates on the JASE, bus lines were provided to serve those trips which would otherwise have to transfer between the JASE and one or more bus lines to travel within the study area.

Figure 4-6 presents these routes. Line 22 provides service between Park-Riverside and the Southside in those systems where either the Park-Riverside or Southside JASE is eliminated. Lines, 42, 52, and 62 provide service when the line to the north is eliminated. Line 92 provides service to Downtown from the Southside when the JASE does not cross the river.

Patronage

Estimates of the ridership on the seven JASE segments were done in two phases: a preliminary estimate for all seven segments and a detailed estimate for the Full System and the Initial Segment. For both phases, the Transit Network OPTimization system was used to assign trips to alternate paths through the network. This model has a probabilistic assignment algorithm which assumes that all paths with equal time are

considered to be equally likely to be used. Longer paths have lower probabilities which are determined by weights given to walking, waiting, and riding times.

The first step in the process was to make general estimates of the patronage on all seven segments by analyzing the use by the three major market areas: circulation, transit, and park-n-ride trips. These trips were expanded to predict full-day patronage.

From these estimates and other pertinent data, JTA and the Task Force selected one of the shorter segments for detailed analysis. The segment selected was FJC to St. Johns Place, Segment G, the shortest line that crosses the river and serves bus transfers. Detailed analysis of this segment, as well as the Full System, was then done by analyzing origin-destination matrices representing six market areas: noon circulation, highway, and transit trips and PM circulation, transit, and highway trips.

. Preliminary Estimates

Table 4-4 shows a comparison of the patronage on all seven segments for the two planning horizon years, 1985 and 1995. Between 1985 and 1995, the ridership on the Full System rises 40 percent due to changes in land use. This is in comparison to the 35 percent increase in total travel during the same time period. Almost half of the additional 22,800 riders are making circulation trips, reflecting the new development which will be in place by 1995 and which will be well served by the JASE.

Segment C, which with Segment B makes up the Full System, will carry 72 percent more riders in 1995 than in 1985. This is because Segment C crosses the St. Johns River into Southside and will have significantly more development by 1995. The increase on Segment B will be much less: 26 percent more riders in the year 1995 than in 1985.

This segment serves the existing Downtown development well, but does not serve a significant amount of new development. Therefore, the 1985 ridership is relatively large, but does not increase greatly by 1995. Segment D also crosses the river but does not experience as large an increase in ridership as Segment C. The patronage increases only 43 percent between 1985 and 1995. This percentage is deceptively low because Segment D serves the market well in both 1985 and 1995. In both years, it carries more riders than any of the other shortened segments so, despite the fact that the patronage increase of 17,246 persons is the largest experienced by any of the segments, the percentage increase is low.

The increase on Segment E is very small, 25 percent. This segment does not serve the market well in either plan year and carries the fewest passengers of any of the segments.

TABLE 4-4
 JACKSONVILLE ASE STUDY PRELIMINARY PATRONAGE SUMMARY
 1ST YEAR FORECASTS

<u>SEGMENT ALTERNATIVE</u>	<u>TRANSIT PM PK</u>	<u>TRIPS DAILY</u>	<u>DAILY AUTO</u>	<u>CIRCULATION</u>		<u>DAILY TOTAL</u>
				<u>NOON HR.</u>	<u>DAILY</u>	
A (2 lines)	4,729	24,902	12,351	4,347	19,740	56,993
B MEDC/RIVR	3,239	17,241	8,017	2,681	12,038	37,296
C GOVT/STJP	1,820	9,688	4,497	1,828	8,208	22,393
D MEDC/STJP	3,383	18,008	8,220	2,908	13,057	39,285
E GOVT/RIVR	1,332	7,090	3,297	1,435	6,443	16,830
F FJC/RIVR	1,806	9,613	4,470	1,982	8,899	22,982
G FJC/STJP	2,063	11,537	5,261	2,271	10,020	26,818

10TH YEAR FORECASTS

<u>SEGMENT ALTERNATIVE</u>	<u>TRANSIT PM PK</u>	<u>TRIPS DAILY</u>	<u>DAILY AUTO</u>	<u>CIRCULATION</u>		<u>DAILY TOTAL</u>
				<u>NOON HR.</u>	<u>DAILY</u>	
A (2 lines)	6,803	34,121	14,416	7,081	31,289	79,826
B MEDC/RIVR	4,475	21,783	10,721	3,360	14,671	47,175
C GOVT/STJP	2,829	13,965	6,874	4,055	17,706	38,545
D MEDC/STJP	4,911	24,243	11,421	4,779	20,867	56,531
E GOVT/RIVR	1,796	8,742	4,303	1,842	8,043	21,088
F FJC/RIVR	2,530	12,315	6,061	2,469	10,781	29,163
G FJC/STP	3,220	16,032	7,288	4,450	19,152	42,472

SOURCE: Robert J. Harmon & Associates, Inc.

If the patronage on Segments B and C is summed, it is greater than that on the Full System. However, if the patronage on Segments D and E is summed, it is less than that on the Full System. This occurs because both Segments B and C serve portions of cross-river trips. Segment B brings people from the northern portion of Downtown to the feeder bus which crosses the river. These same trips from the north will use feeder buses to access Segment C for cross-river trips. Therefore, certain trips are being double-counted. In contrast, Segment D serves both the northern CBD and the Southside while Segment E serves no major market areas. Therefore, the double-counting of trips does not occur.

Segment F does not cross the river but serves portions of the northern CBD and is a shortened version of Segment B. Its patronage increase is also similar, 27 percent between 1985 and 1995. Segment G, a shortened version of Segment D, which serves the same portions of the northern CBD and crosses the river, has a patronage increase of 58 percent during the same time period. Since this segment does not serve the market as well as Segment D, it carries only about 2/3 as many people in 1985. However, as the market shifts to the south, Segment G becomes more attractive and its patronage grows to 3/4 of Segment D by 1995.

. Detailed Estimates

The total patronage figures for both segments A and G are shown in Tables 4-5 through 4-7. The patronage by market segment for each system is shown in Table 4-8. Table 4-5 shows the percentage of the total trips in each market segment utilizing the JASE. Table 4-6 shows the station volumes for Segment A while Table 4-7 exhibits the same statistics for Segment G.

In both horizon years for both segments, park-n-ride patronage is the smallest segment of total patronage, despite the fact that auto trips are the largest segment of the total trips being assigned. This is initially due to capacity constraints on the park-n-ride lots. However, if capacity is not constrained, the number of people driving to the JASE rather than into the city does not increase greatly due to the assumption on gas prices and availability. The park-n-ride patronage on the Full System represents 5 to 6 percent of the total auto trips coming into the CBD. On the Segment G, 3 percent of the drivers change modes to take advantage of the reduced parking costs. On both segments, the proportion of drivers being diverted to transit drops between 1985 and 1995.

Circulation trips are the largest segment of the riders of both estimates during the noon hour, the time when most of the circulation trips are made for the purposes of shopping and eating. During the PM peak, fewer circulation trips are made. In 1985 on the Full Recommended System, 12 percent of all circulation trips travel by JASE while 15 percent use the JASE in 1995. On the Initial Segment, the percentage rises from 6 to 9 percent of all circulation trips.

Transit trips, while a small portion of all trips in the noon period, are a fairly large portion in the PM peak, reflecting commuter travel. The proportion of transit trips using the JASE is very large: 2/3 for the Full Recommended System and over 1/3 for the Initial Segment. This is due to the JTA's proposed policy of running most bus routes to the CBD and terminating most at JASE stations.

TABLE 4-5
 PERCENTAGE OF DAILY TRAVEL
 BY MARKET SEGMENT

	NOON		PM		TOTAL	
	<u>1985</u>	<u>1995</u>	<u>1985</u>	<u>1995</u>	<u>1985</u>	<u>1995</u>
<u>Full System (A)</u>						
Highway	1.3%	1.1%	7.4%	6.3%	5.6%	4.9%
Transit	59.6%	63.1%	68.6%	77.7%	66.4%	74.4%
Circulation	<u>13.4%</u>	<u>17.6%</u>	<u>6.2%</u>	<u>6.9%</u>	<u>11.9%</u>	<u>15.3%</u>
TOTAL	11.4%	14.2%	15.0%	14.9%	13.2%	14.5%
<u>Starter Line (G)</u>						
Highway	0.02%	0.3%	3.8%	3.4%	3.3%	2.6%
Transit	31.1%	29.1%	29.9%	36.8%	30.2%	35.1%
Circulation	<u>7.0%</u>	<u>11.1%</u>	<u>2.6%</u>	<u>3.3%</u>	<u>6.0%</u>	<u>9.4%</u>
TOTAL	5.7%	8.4%	6.9%	7.4%	6.3%	7.8%

TABLE 4-6
 JACKSONVILLE ASE STUDY
 FULL SYSTEM - A
 PEAK PERIOD AND DAILY STATION VOLUMES

	1985			1995		
	<u>PM PEAK</u>	<u>NOON</u>	<u>DAILY</u>	<u>PM PEAK</u>	<u>NOON</u>	<u>DAILY</u>
MEDC	2,197	1,188	13,912	2,889	1,465	17,685
SPFD	156	277	1,916	177	307	2,122
FJC	1,145	1,015	8,867	1,294	1,121	9,884
PLZA	2,348	1,566	16,006	2,753	1,735	18,192
JACK	757	593	5,378	956	989	7,762
RIVR	1,681	1,454	12,651	2,222	1,691	15,636
GOVT	778	570	5,369	893	670	6,200
PRU	564	1,020	6,299	1,451	2,880	17,093
GULF	1,357	1,119	9,989	1,218	2,745	16,266
STJP	1,721	687	9,717	2,692	909	14,266
CENT (trfrs)	3,413 (735)	2,046 (635)	21,969 (6,417)	5,083 (1,025)	2,785 (801)	31,160 (7,436)
JEFF (trfrs)	2,038 (902)	1,846 (976)	16,086 (7,756)	2,697 (1,364)	2,868 (1,536)	22,739 (11,818)

Note: Volumes include boardings and exits in both directions.
 SOURCE: Robert J. Harmon & Associates, Inc. (RHA)

TABLE 4-7
 JACKSONVILLE ASE DESIGN G
 FLORIDA JUNIOR COLLEGE TO ST. JOHNS PLACE

PEAK PERIOD & DAILY STATION VOLUMES
 1985

<u>STATION</u>	<u>PM PEAK HOUR</u>	<u>NOON HOUR</u>	<u>DAILY TOTAL</u>
FJC	1,348	1,309	10,983
PLZA	1,321	984	9,193
CENT	1,002	543	6,143
JEFF	501	557	4,213
PRU	444	923	5,445
GULF	827	1,034	7,523
STJP	2,057	568	10,147

PEAK PERIOD & DAILY STATION VOLUMES
 1995

<u>STATION</u>	<u>PM PEAK HOUR</u>	<u>NOON HOUR</u>	<u>DAILY TOTAL</u>
FJC	1,810	1,423	12,975
PLZA	1,464	1,135	10,383
CENT	1,978	834	10,848
JEFF	703	1,003	6,957
PRU	1,232	2,720	15,583
GULF	1,113	2,624	15,207
STJP	2,544	779	12,992

Note: Volumes include boardings and exits in both directions.
 SOURCE: Robert J. Harmon & Associates, Inc. (RHA)

TABLE 4-8
 JACKSONVILLE ASE STUDY
 COMPARATIVE JASE PATRONAGE ESTIMATES

PATRONAGE	NOON		PM		DAILY	
	<u>1985</u>	<u>1995</u>	<u>1985</u>	<u>1995</u>	<u>1995</u>	<u>1995</u>
Full System (A)						
Park-n-Ride	225	228	2,862	3,428	12,351	14,416
Transit	1,313	1,605	4,729	6,803	24,902	34,121
Circulation	4,347	7,081	568	737	19,740	31,289
TOTAL	<u>5,885</u>	<u>8,914</u>	<u>8,159</u>	<u>10,968</u>	<u>56,993</u>	<u>79,826</u>
Starter Line (G)						
Park-n-Ride	3	69	1,454	1,850	5,261	7,288
Transit	685	740	2,063	3,220	11,537	16,032
Circulation	2,271	4,450	233	352	10,020	19,152
TOTAL	<u>2,959</u>	<u>5,259</u>	<u>3,750</u>	<u>5,422</u>	<u>26,818</u>	<u>42,472</u>

SOURCE: Robert J. Harmon & Associates, Inc. (RHA)

Although the Initial Segment is less than half as long as the Full Recommended System, it carries slightly more than half the riders. As can be seen from Tables 4-6 and 4-7, the Initial Segment includes six of the seven busiest stations on the Full System. Obviously, cutting back on the extent of the system causes a reduction in the number of trips which can be served. Trips with either end on the eliminated sections must either transfer between modes or find other ways of traveling. Apparently, the Initial Segment will serve a large portion of the demand on the Full System and certain trips not directly served will continue to use the system by walking further or riding a bus.

Line Link Loadings

The design of the system is based on the number of patrons it must carry at the maximum single level of patronage. Since the riders access the system through the stations and travel varying distances, the trip demand between stations is called line links. These line links are two-directional with riders traveling in both directions. Figure 4-7 shows the line link ridership for the Initial Segment in its first year of operation, 1985. The individual line loads are shown in the boxes adjacent to the line links with the total in the bottom box. The park-n-ride transit and circulation diversions are also indicated.

FIGURE 4-7
 JACKSONVILLE ASE STUDY
 RIDERSHIP PROFILE

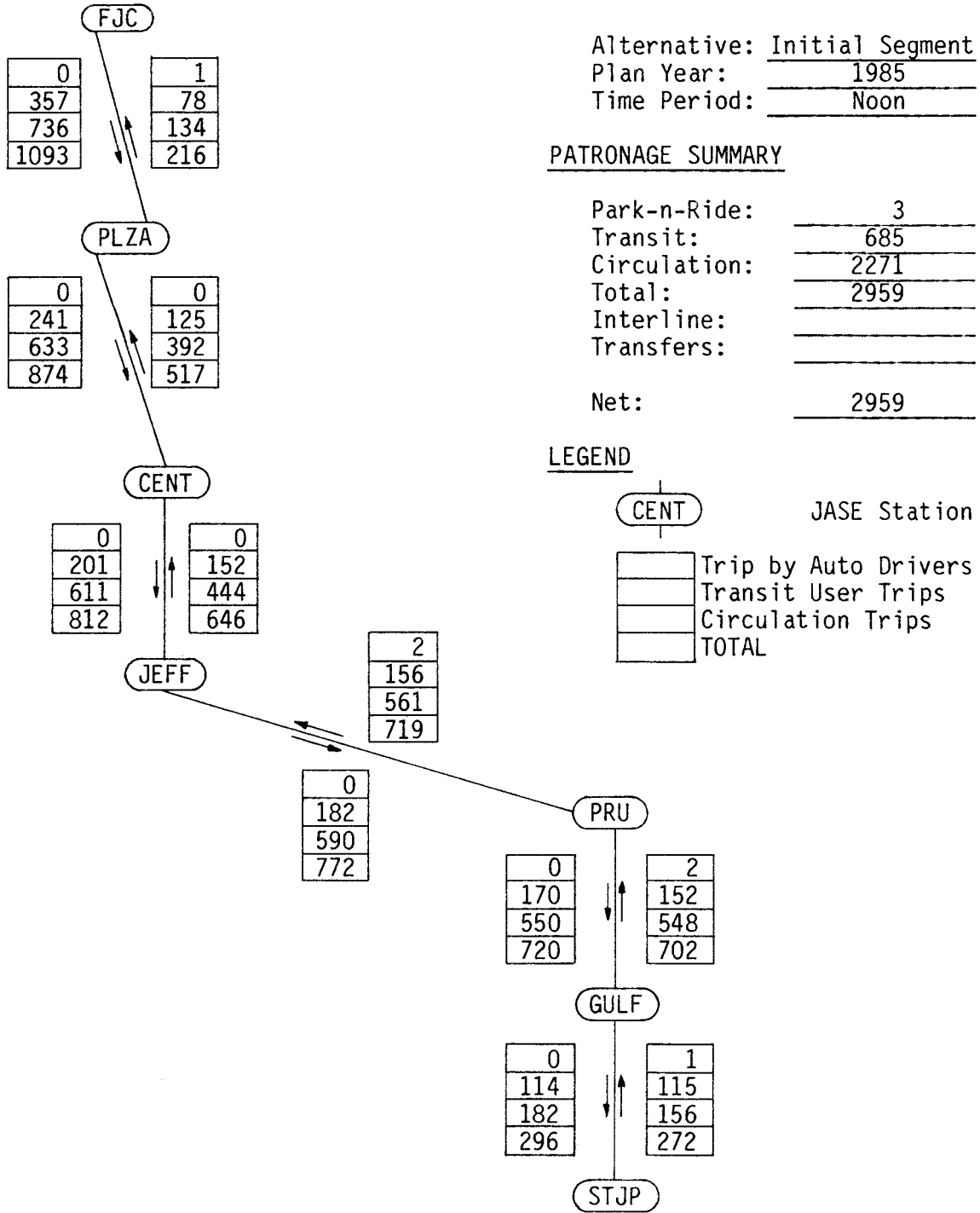

The critical design factor is the maximum link load which for the 1985 noon period is 1,093 in the southbound line link between FJC and Hemming Plaza Station. Figure 4-8 shows the relative link link loadings for the Initial Segment during the 1985 PM period. Here the maximum loading is 2,031 in the river crossing link between Jefferson Station and Prudential Station.

The JASE vehicle will have normal loading capacity of 90 persons -- 18 seated and 72 standing. It could be crush-loaded to about 100 persons with 10 additional standees. The operational assumptions given at the beginning of the Operations Section call for 2-minute frequencies during peak rider periods and 5- to 10-minute frequencies during off-peak. This means that during rush hours, 30 vehicles will be available within each line link in both directions. This is expressed as 2,700 to 3,000 persons per hour per direction (2700 pphd). Therefore, there would be more than enough system capacity to meet 1985 patronage requirements.

After 10 years of operation, both the amount and location of maximum line link loading will have changed. The 1995 noon peak hour maximum line link load will be 1,550 for the southbound line link between Prudential and Gulf Life Stations as shown in Figure 4-9. However, the opposite link is very nearly the same and there are seven line links larger than the 1985 maximum line link.

During the 1995 PM peak period, the river crossing link still carries the maximum load and all the heaviest links are southbound from Central Station (Figure 4-10). The system at 2-minute headways with single vehicle will still have sufficient capacity at all times of the day except during a brief time in the PM peak southbound line across the St. Johns River when a slight crush loading condition (3 to 4 additional riders) may be required. This can be alleviated by decreasing the headways from 120 seconds (2 minutes) to 112 seconds. This is easily within the computer and operational capabilities of the system and would not require any more vehicles. This change in headways would not add significantly to the cost and would increase the system capacity to about 2,900 pphd to 3,200 pphd. At these projected patronage levels, the JASE System would be more than capable of meeting operational demands. Vehicles can also be trained in consists to provide significant additional capacity.

Station Loadings

The stations are the access points for the system and are the interchanges between the JASE and adjacent development. At intermodal stations, bus riders will enter the station through the intermodal gates, pass through the paid area to vertical circulation elements, and directly to the platform. These bus patrons will not have to pay a fare since they will already have done so on the buses. Other patrons will also enter at the ground level, pass through fare gates, and then to vertical circulation elements. Others will use the second level pedestrian walkways to enter the station and will pass through the fare gate to the platform. At urban stations, the access is freer, less

FIGURE 4-8
 JACKSONVILLE ASE STUDY
 RIDERSHIP PROFILE

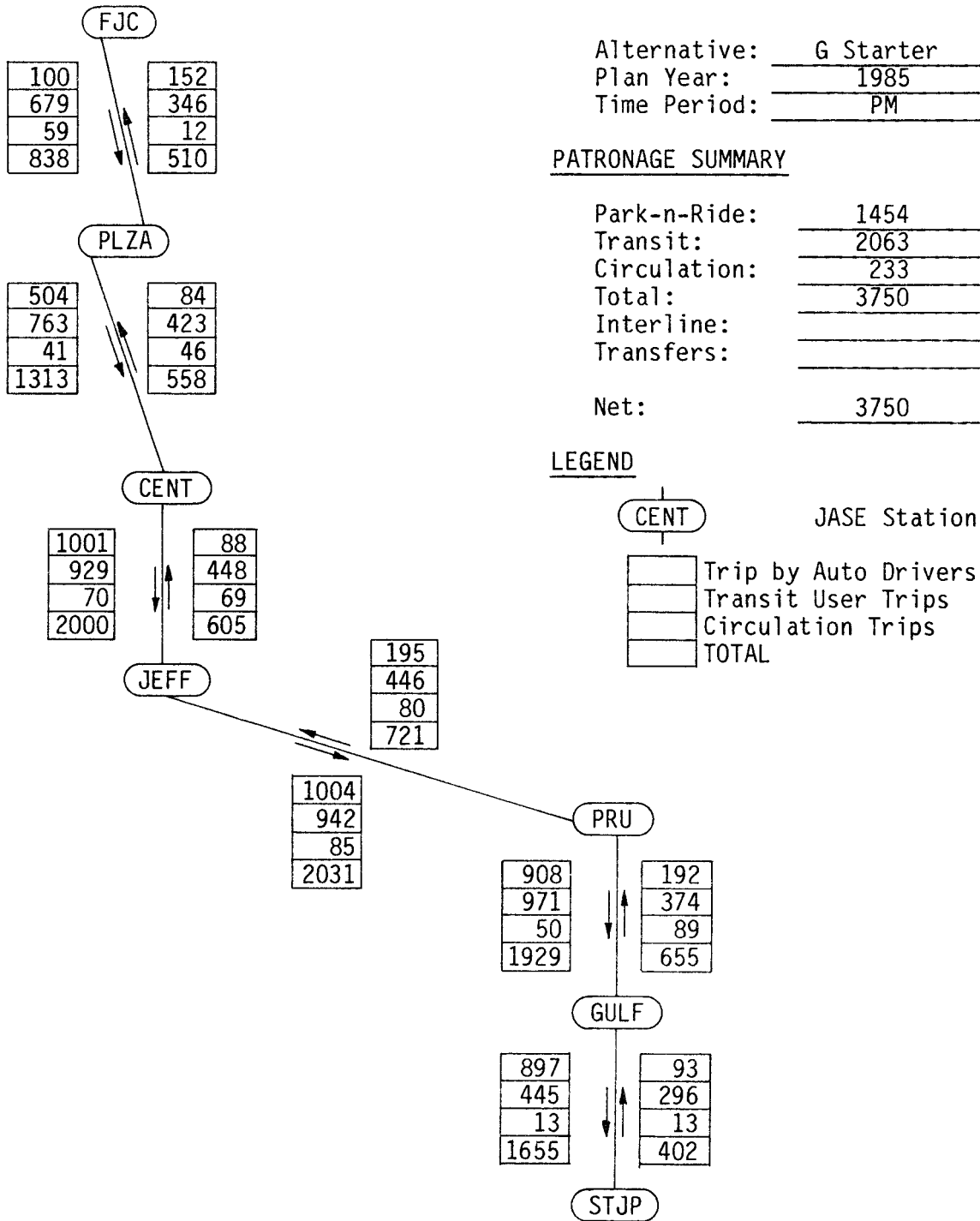

FIGURE 4-9
 JACKSONVILLE ASE STUDY
 RIDERSHIP PROFILE

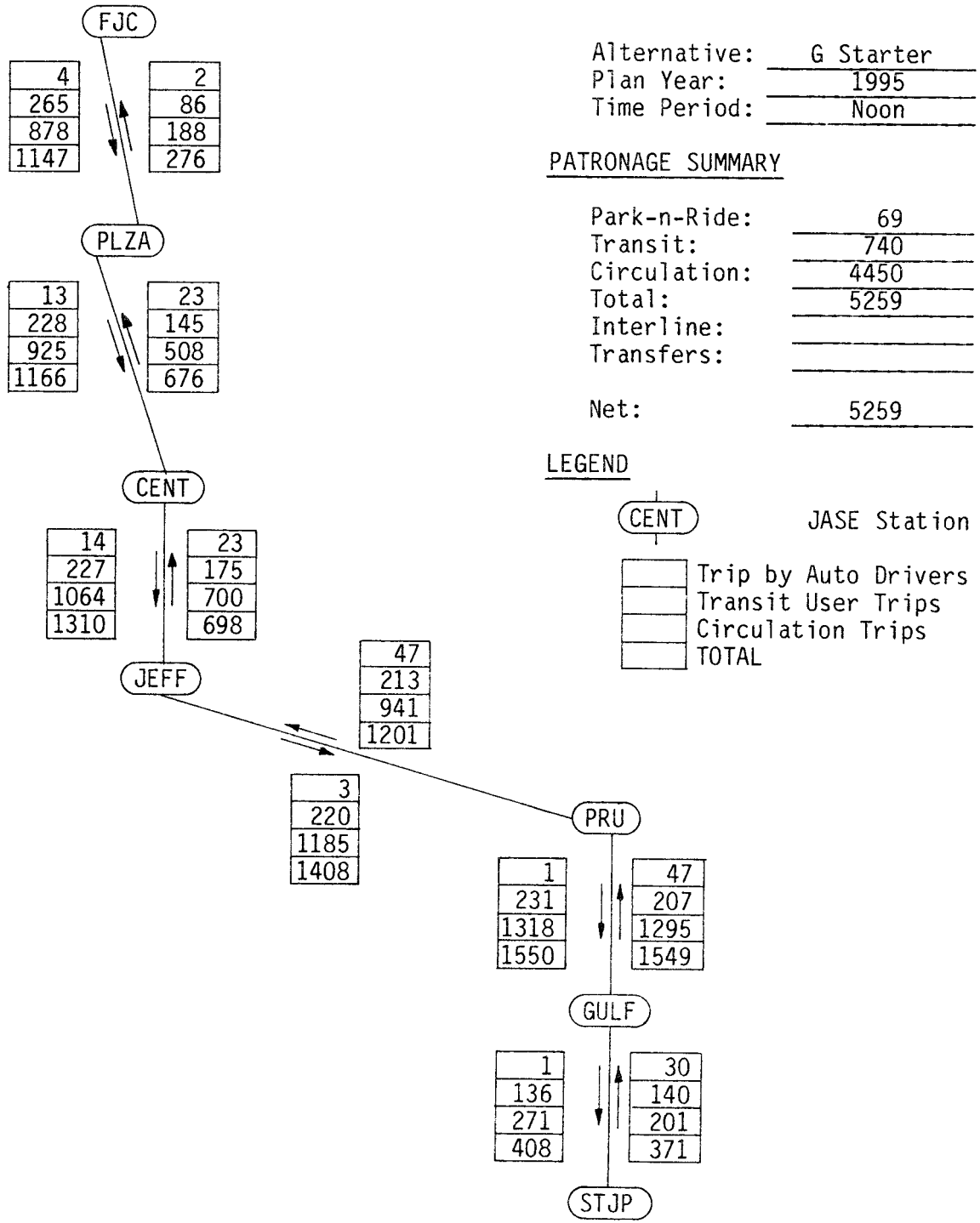
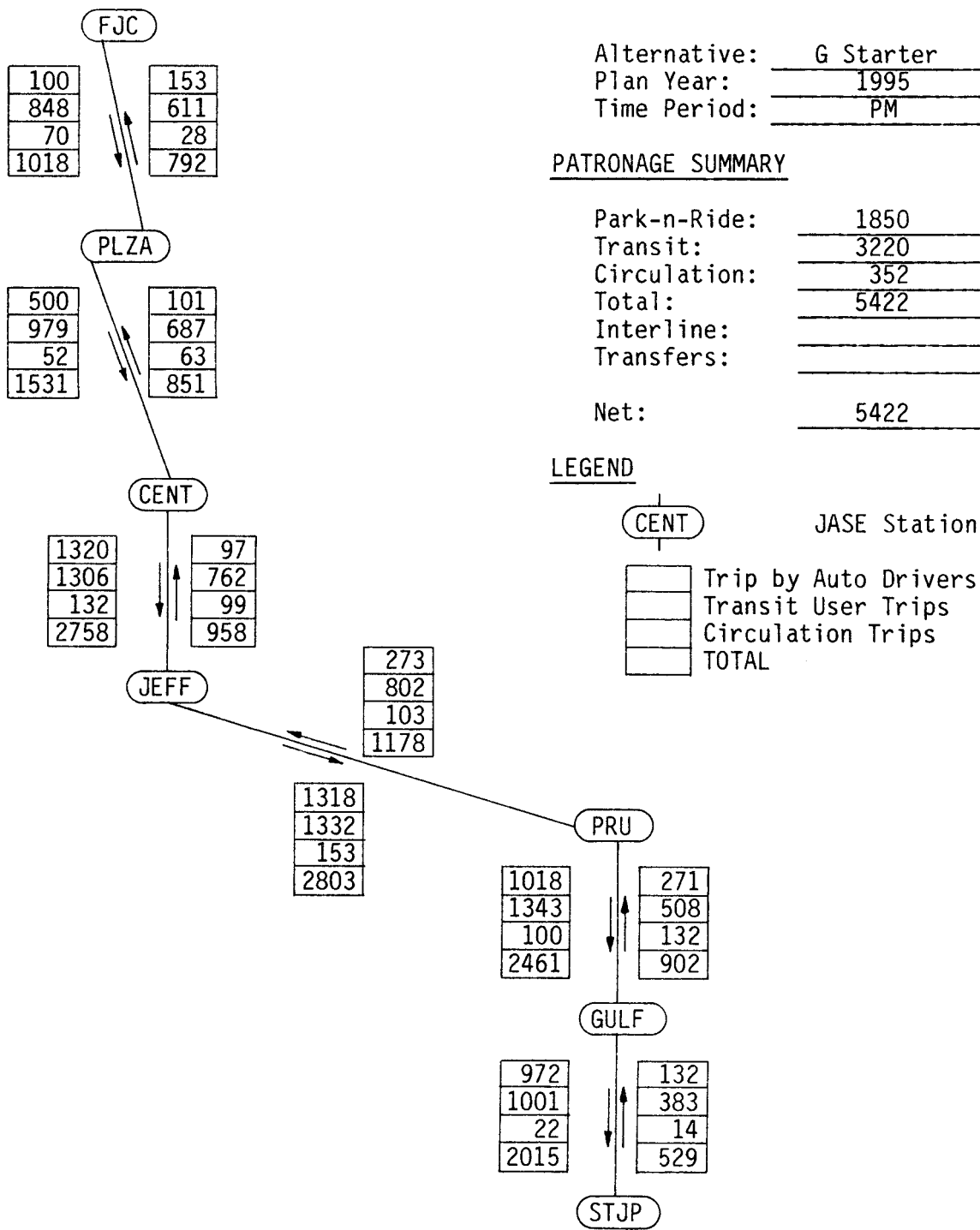

FIGURE 4-10
 JACKSONVILLE ASE STUDY
 RIDERSHIP PROFILE



controlled, and multi-directional. Patrons will enter the system from the ground, along second level walkways directly to the ends of the platforms and, in some cases, from access points above the station. In order to accommodate these diverse entry points, the fare collection barriers have been located at the ends of the platforms. Debarking patrons will reverse the process. The patrons wait on the platform for the next available vehicle; therefore, the platform must be sized to accommodate the maximum load.

The amount of patrons expected to use the station at any given time is critical to the design. Therefore, the station flow was estimated for each station in the Initial Segment. These estimates were developed by successive steps. First, the trip lengths were estimated for 1985 and 1995 for noon and PM peak hours. Second, these were stratified into auto-transit and circulation access modes by station and time period. Third, the movements on to and off the vehicles were estimated for each station, each time period, and each access and departure mode. Fourth, these ons and offs were expanded into daily totals for each station. These steps were followed for both the 1985 and 1995 design years. Table 4-9 shows the station volumes for both the 1985 and 1995 peak and daily periods. As expected, the end stations show the greatest volumes since this is where the bus transfer points will be located. FJC Station is the heaviest used in 1985 with 10,983 daily patrons while St. Johns Place will be the heaviest in 1995 with 12,992. It is from these estimates that the capacities of the vertical access and platforms were designed for 1995. The sizing criteria developed early in the preliminary engineering program were used as the correct design standards.

The Southside area is expected to develop at a faster pace than the Northside. Due to the increased development, circulation trips are estimated to increase faster than the other market areas. This is the reason the Prudential and St. Johns Place Stations would have the greatest daily volumes by 1995. The circulation patronage also increases markedly from 37.3 percent of the total daily 1985 patronage to 45.1 percent of the daily 1995 patronage. Since these estimates were developed, new developments, such as the new Prudential office complex, are already committed to the downtown area.

These estimates produce the basic dimensions of the system. In design of the system, the maximum short-time loadings give the minimum capacities needed in the system. These capacities are tempered by other requirements. As an example, the platforms require sufficient waiting space for the maximum number of patrons expected to wait there between trips. In terms of the raw patronage, the Prudential Station, in the Initial Segment during the 1995 noon peak period, should be the critical station platform to be sized. Using the 2-minute single vehicle operational requirements, there must be enough space to hold 25 patrons southbound and 18 patrons northbound every 2 minutes. In addition, there will be 20 patrons exiting the southbound trains and 29 exiting northbound trains. On the average, there will be 92 patrons using this Prudential platform every 2 minutes. The criteria calls for 4 square feet per person which yields 368 square feet of platform space needed. However, patrons do not arrive or depart in steady flow and

TABLE 4-9

JACKSONVILLE ASE SYSTEM INITIAL SEGMENT
FLORIDA JUNIOR COLLEGE TO ST. JOHNS PLACE

PEAK PERIOD AND DAILY STATION VOLUMES
1985

<u>STATION</u>	<u>PM PEAK HOUR</u>	<u>NOON HOUR</u>	<u>DAILY TOTAL</u>
FJC	1,348	1,309	10,983
Plaza	1,321	984	9,193
Central	1,002	543	6,143
Jefferson	501	557	4,213
Prudential	444	923	5,445
Gulf Life	827	1,034	7,523
St. Johns PL	2,057	568	10,147

PEAK PERIOD AND DAILY STATION VOLUMES
1995

<u>STATION</u>	<u>PM PEAK HOUR</u>	<u>NOON HOUR</u>	<u>DAILY TOTAL</u>
FJC	1,810	1,423	12,975
Plaza	1,464	1,135	10,383
Central	1,978	834	10,848
Jefferson	703	1,003	6,957
Prudential	1,232	2,720	15,583
Gulf Life	1,113	2,624	15,207
St. Johns PL	2,544	779	12,992

Note: Volumes include boardings and exits in both directions.

SOURCE: Robert J. Harmon & Associates, Inc. (RHA)

infrequently vehicles will be delayed for up to 5 minutes. This means the platforms must hold about 2.5 times their expected capacity. Beyond that period, the vertical circulation elements must be designed to evacuate the entire platform within 2 minutes for safety reasons. Vertical circulation elements must be designed to accommodate this exit demand which far exceeds the normal circulation requirements of that particular station during the peak demand periods.

Moreover, the system must be designed to accommodate future expansion of the system. Table 4-10 shows the expected loadings for the Full Recommended System for peak period and for the design years 1985 and 1995. Due to the more extensive system, Hemming Plaza becomes the most heavily used destination station although the others have increased as well except for FJC which decreases because many of the bus transfers

TABLE 4-10

JACKSONVILLE ASE STUDY FULL RECOMMENDED SYSTEM
PEAK PERIOD AND DAILY STATION VOLUMES

STATION	1985			1995		
	PM PEAK	NOON	DAILY	PM PEAK	NOON	DAILY
MEDC	2,197	1,188	13,912	2,889	1,465	17,685
SPFD	156	277	1,916	177	307	2,122
FJC	1,145	1,015	8,867	1,294	1,121	9,884
PLZA	2,348	1,566	16,006	2,753	1,735	18,192
JACK	757	593	5,378	956	989	7,762
RIVR	1,681	1,454	12,651	2,222	1,691	15,636
GOVT	778	570	5,369	893	670	6,200
PRU	564	1,020	6,299	1,451	2,880	17,093
GULF	1,357	1,119	9,989	1,218	2,745	16,266
STJP	1,721	687	9,717	2,692	909	14,266
CENT	3,413	2,046	21,969	5,083	2,785	31,160
(trfrs)	(735)	(635)	(6,417)	(1,025)	(801)	(7,436)
JEFF	2,038	1,846	16,086	2,697	2,868	22,739
(trfrs)	(902)	(976)	(7,756)	(1,364)	(1,536)	(11,818)

Note: Volumes include boardings and exits in both directions.

SOURCE: Robert J. Harmon & Associates, Inc. (RHA)

would now occur at Medical Center Station which intercepts buses further out from the center of the Downtown area.

With the Full Recommended System, patrons will have an opportunity to transfer in other directions at the Central and Jefferson Stations. At Central Station, the daily volumes have increased 119 percent plus the 7,436 transferring passengers. The large increases are due to the heavy new development expected to occur in the area. Jefferson Station only increases 70 percent in the same 10-year period but it will handle substantially more transferees than Central. Jefferson Station would also lose its intermodal facilities under this concept and, therefore, reducing its transit intercept patronage. This transit intercept would be done at Riverside Station.

Conclusions

The Full System serves many of the major development projects predicted for Jacksonville in the next 15 years. It will satisfy the demand generated between the large projects south of the river and the older portions of the city. The joint development projects to the west of the city are also served, as are the park-n-ride lots to the north,

south, and west of the CBD. In 1995, almost 15 percent of the trips within Downtown Jacksonville will be utilizing the JASE.

The Full System has over 10 percent more riders than the system selected in the Feasibility Study. The increase is due to changes in the number and location of stations and to updates in the prediction of future land use. In this study, the Full Recommended System is predicted to carry 56,993 people in 1985 and 79,826 people in 1995. The increase in ridership indicates that the land use changes support the need for the JASE.

The Initial Segment also links the activity centers to the south of the river with the CBD. Although it does not serve the park-n-ride lots to the north and west of the city, and it does not serve development to the west, the ridership is still greater than might be expected with half the system eliminated. It appears to be a reasonable starting point for constructing the Full System in stages.

Based upon preliminary patronage estimates of the 6 shortened versions of the Full System and other related considerations (e.g., environmental, socioeconomic, etc.), JTA and the JTA Board selected one system for further study. This line runs from the Florida Junior College (FJC) to St. Johns Place. It was chosen, at least partially, because it is the shortest line which joins the key market areas of the existing Downtown with the extensive new development scheduled for the Southside. This alternative is about half the length of the Full System.

JACKSONVILLE ASE OPERATIONS

Service Characteristics

. Service Hours

JASE passenger service will be provided 14 hours daily from 6:00 AM to 8:00 PM. Service will be provided from any station to any other station with a single transfer provided at the Central or Jefferson Stations for patrons desiring to go from one leg of the system to another. During peak periods (morning, noon, and evening), service will be provided at each station every 2 minutes. During weekday off-peak periods, service will be provided at each station every 5 minutes, or less. During evenings and weekends, service will be provided every 10 minutes, or less.

. Passenger Amenities

The JASE System is intended to provide a high level of passenger service and facilities. Among the amenities to be provided to passengers are:

- 1) Covered, comfortable waiting areas. Climate-controlled, clean vehicles.

- 2) Two-way radio communications from the vehicles and stations to the Central Control personnel which can be initiated by the passengers or Central Controllers.
- 3) Emergency call buttons on every vehicle and emergency doors for emergency egress from the vehicles.
- 4) Station public address system in every station for communicating system operational information to waiting passengers.
- 5) Closed-circuit television monitoring of the JASE stations to enhance passenger security and safety.
- 6) Audio and/or visual graphics in the vehicles and stations providing passengers with user information and direction.

Operational Scenarios - Full System

. Construction Phasing

Although the JASE will be constructed in segments, it is essential that the construction and operational integration of subsequent segments be accomplished without significant interruption to the operating system. In order to accomplish this, the Initial Segment design, construction, and implementation will include all capabilities required to perform the transportation functions for the Full System. Any hardware/software needed to assure minimal interruption of service during construction and integration of subsequent segments will be provided in the Initial Segment. The detailed system description which follows is consistent with that approach; that is, the Full System is discussed first and Initial Segment requirements are then identified. The Full System alignment is shown in Figure 4-11.

. Central Control

The central control for the JASE System contains the primary operational control equipment and the operators responsible for the day-to-day operation of the system. The Automatic Vehicle Supervision (AVS) equipment provides the interface between the system and the operators.

Through audio and visual displays, information will be presented at Central Control describing the status of the system on a real-time basis. This information will allow operating personnel to continually assess conditions throughout the system and to take actions as necessary to assure a safe and efficient operation. Using a pushbutton console, the Central Control Operators may issue commands to initiate system operations, terminate system operations, override any normal operating modes, and perform other system management functions.

Functions and capabilities of the Automatic Vehicle Supervision system will include:

- MEDICAL CENTER STA. 1
- SPRINGFIELD STA. 2
- FJC STA. 3
- HEMING PLAZA STA. 4
- CENTRAL STA. 5
- JEFFERSON STA. 6
- JACKSON STA. 7
- RIVERSIDE STA. 8
- GOVT. CENTRAL STA. 9
- PRUDENTIAL STA. 10
- GULF LIFE STA. 11
- ST. JOHNS PLACE STA. 12

LEGEND

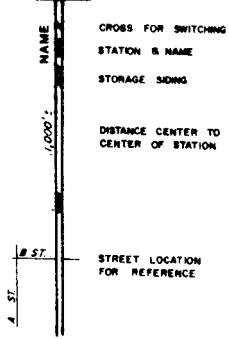

NOT TO SCALE
JANUARY, 1981

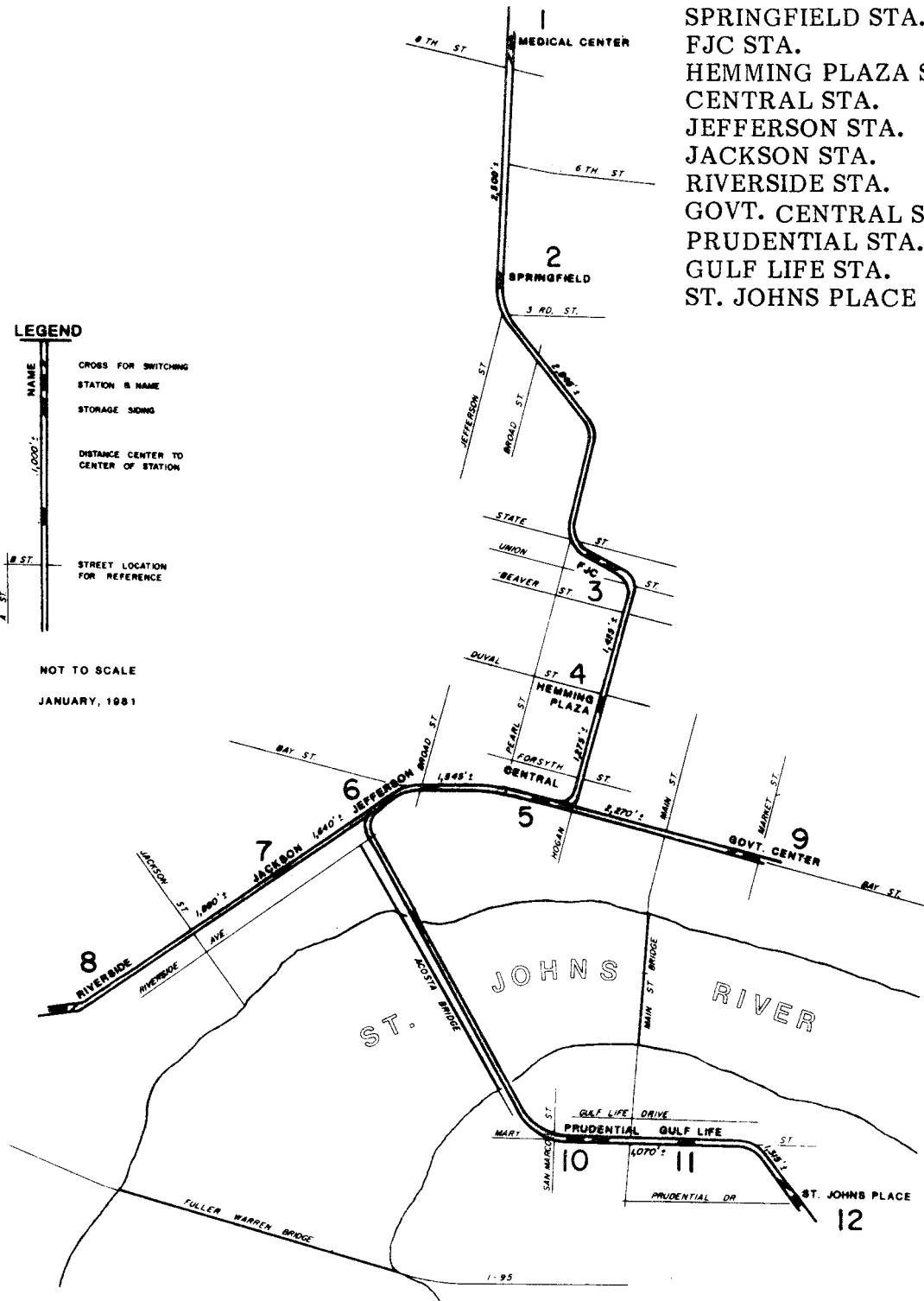

FIGURE 4-11

JACKSONVILLE ASE GUIDEWAY LAYOUT

- * Performance display capabilities
- * Performance monitoring capabilities
- * Performance control and override capabilities
- * Alarms and malfunction reporting
- * Communications
- * Record keeping and management functions

All of the AVS activities represent only requests for action and are subject to the safety constraints imposed by the Automatic Vehicle Protection (AVP) system. In no case can an AVS command override the AVP system.

. Normal Operation

Normal operation of the JASE is defined as failure-free system operation providing the required passenger transportation services. There are two modes of Normal Operation; Peak Mode and Off-Peak Mode.

The JASE System will be capable of automatically switching from Peak Mode to Off-Peak Mode and back to Peak Mode by command from the Central Control Operator within a maximum time of 10 minutes.

(1) Peak Mode for Full Recommended System

Peak Mode is identified as system operation with the full complement of trains operating to provide required service levels. This operational mode will provide the specified system passenger capacity and associated trip times. Figure 4-12 shows the guideway schematic for the Full System with segments, switches, and sidings numbered to assist in the explanation of system operation.

The JASE will operate as two independent dual guideway lines. Each line will terminate with a switchback where vehicles can cross to the adjacent guideway. One line will run from north of Downtown to the south; the other line will run from east of Downtown to the west. The north-south line will be identified as the N/S line and the east-west line will be identified as the E/W line.

For the N/S line, trains will operate automatically, equally spaced in time in a counterclockwise pinched-loop serving each station on the line in succession. Station graphics will inform waiting passengers of the arriving train's destination and an audio vehicle station arrival notification will inform on-board passengers of station arrivals. Audio and visual graphics will inform passengers of the need to transfer at the Central or Jefferson Stations to reach destinations on the E/W line.

The E/W line will operate in a similar manner with trains automatically spaced in time in a counterclockwise pinched-loop serving each station on the line in succession. Station graphics will have similar functions.

The N/S and E/W lines will occupy the same double trackage from just

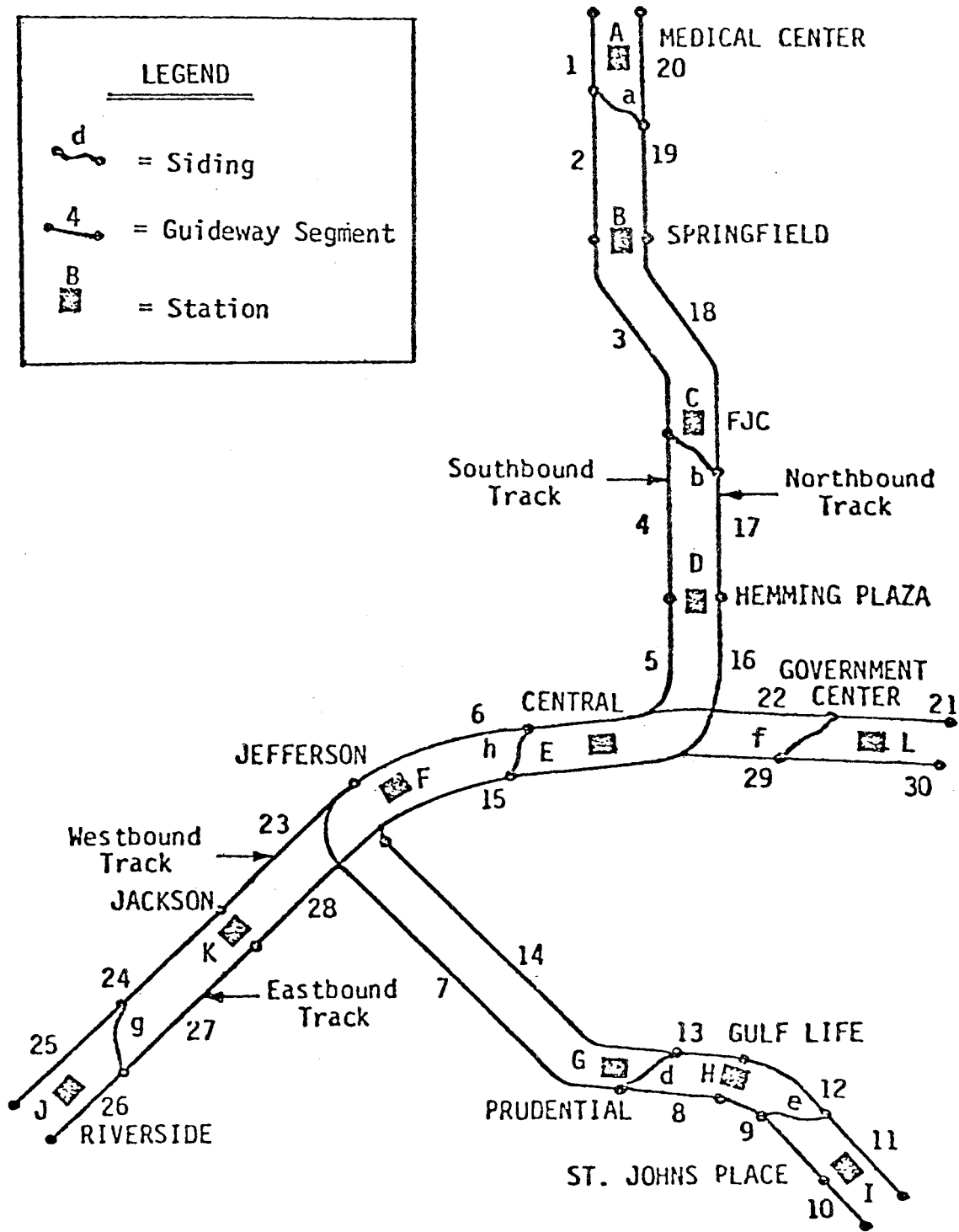
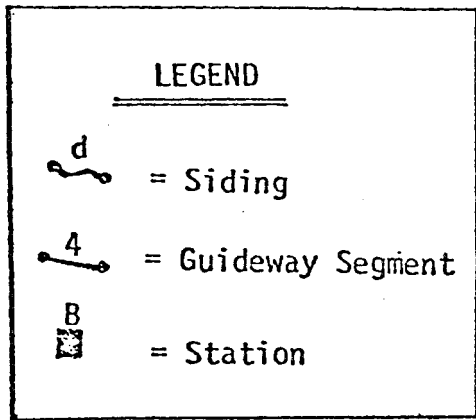

FIGURE 4-12

JACKSONVILLE ASE GUIDEWAY SCHEMATIC TOTAL SYSTEM

west of Jefferson Station to just east of Central Station. Switches will be used to integrate the two lines. All trains will stop at both the Jefferson and Central Stations. Center platform transfers will be provided and audio and visual graphics will inform the passengers of the need to transfer.

A typical pinched-loop operation for the N/S line will begin in guideway Segment 1 with a train loading at Station A. The train will proceed through guideway Segments 2 through 9 stopping for off-loading and loading at Stations B, C, D, E, F, G, and H in succession. The train will then proceed through Crossover e, stopping at Station I in guideway Segment 11 to off-load and load. While stopped at Station I, the train will reverse direction. The train will then proceed through guideway Segments 12 through 19 stopping for off-loading and loading at Stations H, G, F, E, D, C, and B in succession. The train will then proceed through Crossover a into guideway Segment 1, stopping at Station A for off-loading. The train will reverse direction and the process will be repeated.

A typical pinched-loop operation for the E/W line will be similar. The operation will begin in guideway Segment 21 with a train loading at Station L. The train will proceed through guideway Segments 22, 6, 23, and 24 stopping for off-loading and loading at Stations E, F, and K in succession. The train will proceed through Crossover g, stopping at Station J in guideway Segment 26 to off-load and load. While stopped at Station J, the train will reverse direction. The train will then proceed through guideway Segments 27, 28, 15, and 29, stopping for off-loading and loading at Stations K, F, and E in succession. The train will then proceed through Crossover f into guideway Segment 21, stopping at Station L for off-loading. The train will reverse direction and the process will be repeated.

For each of the two lines, the Automatic Train Control system will keep the trains equally spaced in time on each of the lines independently. It will be necessary that the two lines be synchronized on the common guideway between the Central and Jefferson Stations.

(2) Off-Peak Mode

Off-Peak Mode is defined as the operation of a reduced number of vehicles/trains to provide reduced service levels; that is, lower capacity and longer waiting times than the Peak Mode. There are no specified capacity requirements for the Off-Peak Mode but waiting times must not exceed 5 minutes during weekday off-peak periods and 10 minutes during evening and weekend off-peak periods. The JASE will operate in the same manner for Off-Peak Mode as for Peak Mode except fewer vehicles will be operated on the two lines. Passenger service will be the same as the Peak Mode except for longer waiting times due to a reduced number of trains on each line.

. Degraded Operation

From time to time during Normal Operation, it will be necessary to interrupt the Normal Operation due to system/vehicle failures or to accomplish maintenance on the guideway or vehicles. During such times, as determined by the Central Control Operator, the JASE System will be capable of operating in the following Degraded Mode.

For the N/S line, 4 trains will be operated as shuttles for approximately 1/4 lengths of the N/S line as shown in Figure 4-13. One train will operate as a shuttle on the Southbound track between Stations A and C. A second train will operate on the Northbound track between Stations C and E. A third train will operate on the Southbound track between Stations E and G. The fourth train will operate on the Northbound track between Stations G and I. Each of the four shuttles will stop at each of their 3 stations in succession, in each direction, and appropriate graphics will be provided. Passengers will have to transfer across the center platform at the C, E, and G Stations. Automatic visual and audio directions will be provided for these passengers. The 4 shuttles will be synchronized and the 4 trains will depart the transfer stations at approximately the same time. There will be a sufficient common dwell to accommodate the required transfers. This Degraded Mode operation will also be possible utilizing the Southbound and Northbound tracks reversed.

For the E/W line, one train will be operated as a shuttle for approximately 1/2 length of the E/W line as shown in Figure 4-14. That is; the train will operate as a shuttle on the Eastbound or Westbound track between Stations J and F. Because of potential interference between trains on the common guideway, service to/from the Government Center Station will be discontinued during Degraded Mode Operation.

The JASE System will be capable of automatically changing from Normal Mode to Degraded Mode by command from the Central Control Operator.

. Override Operations

Override Operations is defined as the condition where the Normal Operating Mode of the system is modified by an override command from Central Control. In most cases, this mode will result in a reduction in the level of service provided by the system.

System overrides may be imposed for any one of the following reasons:

- * System or vehicle failure
- * System emergency
- * Unusual situations such as inclement weather
- * Routine systems management strategies

At these times, the operator shall be able to:

- * Temporarily hold consists in stations
- * Divert some (or all) consists from one operating route to the other (consistent with minimum headway limitations)

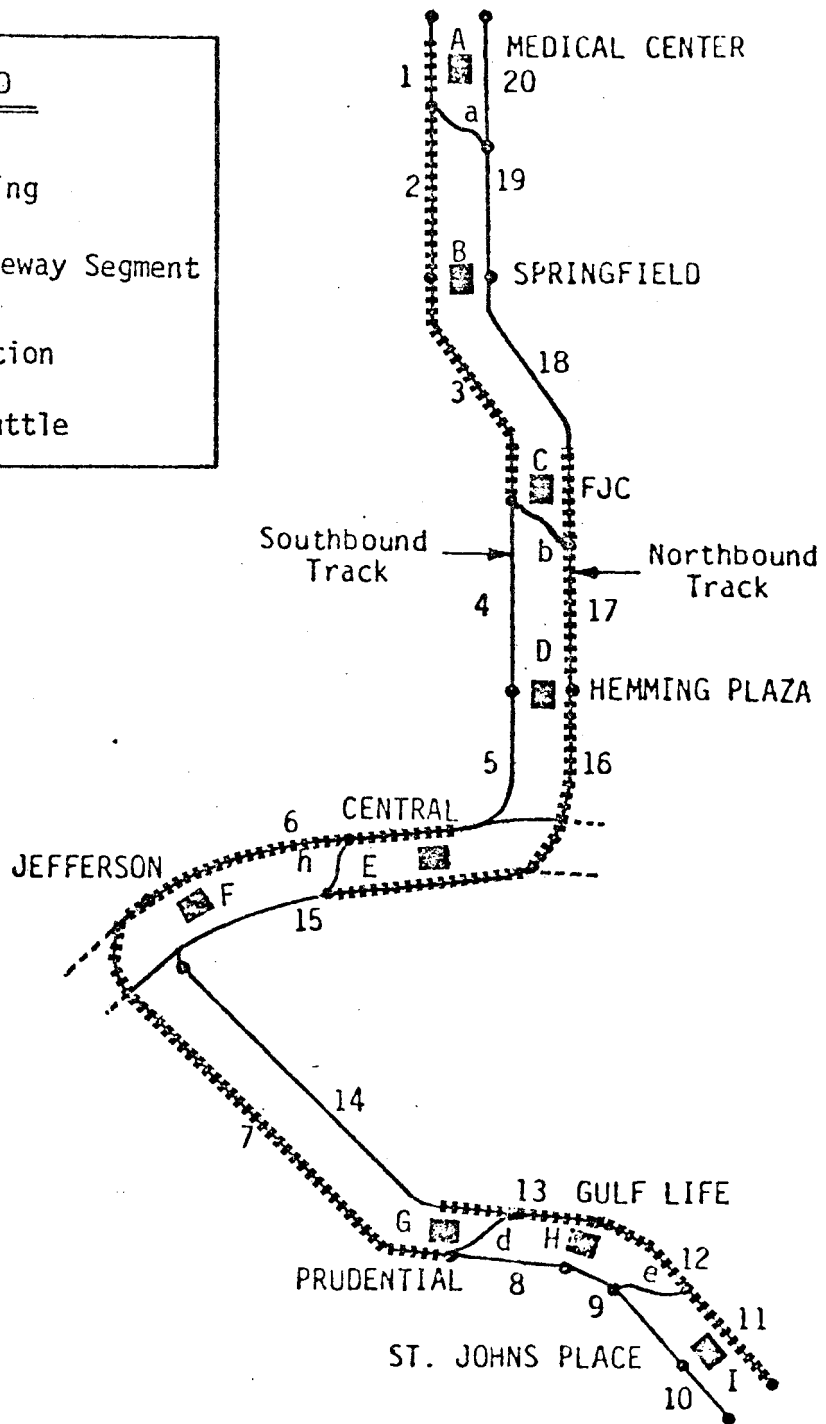
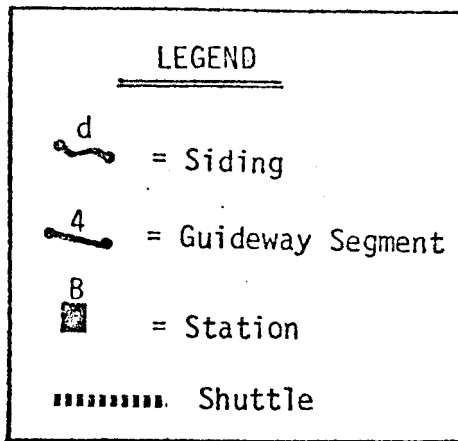

FIGURE 4-13

NORTH/SOUTH LINE DEGRADED OPERATION SHUTTLES

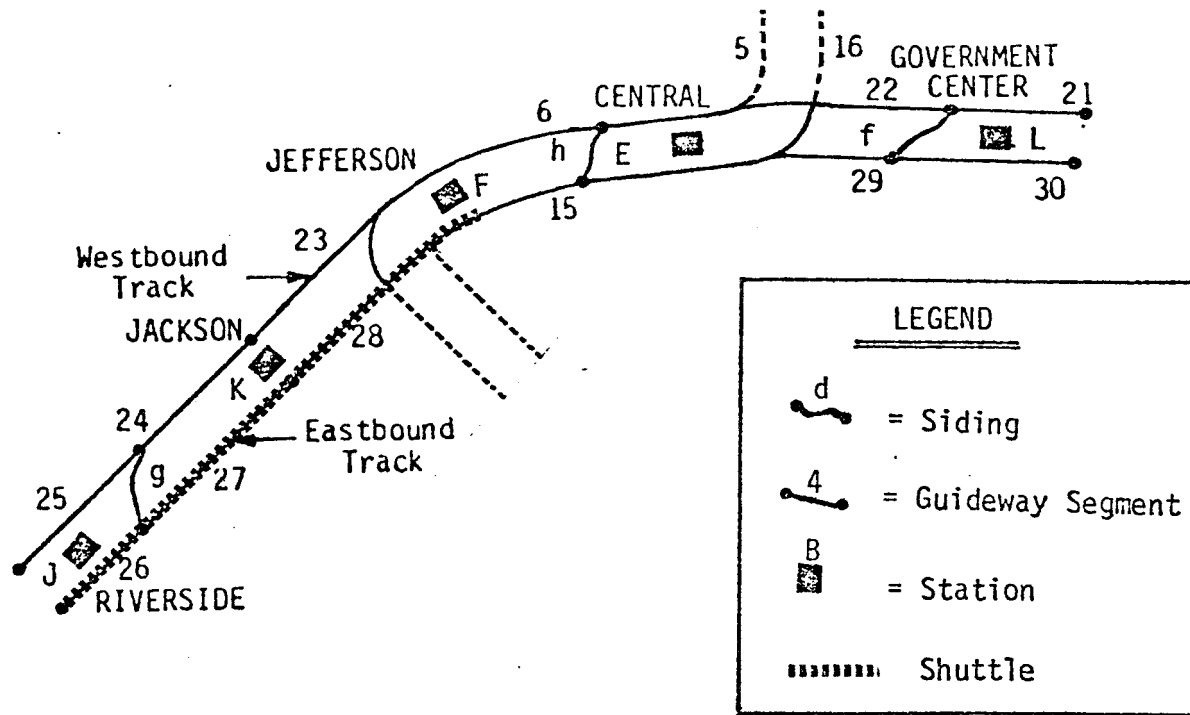

FIGURE 4-14

EAST/WEST LINE DEGRADED OPERATION SHUTTLE

- * Remove some consists from service
- * Discontinue system service

The JASE System shall be designed so that, in the above circumstances, all equipment and subsystems shall respond automatically to the override command(s). Thereafter, the system shall immediately begin operating in accordance with the override commands in effect, making whatever adjustments may be necessary to comply with the altered operational scenario. In no instance will the operator be able to override safety and fail-safe provisions.

. Guideway and Switching Operation

In order to provide the Normal and Degraded Modes Operations described above, there are certain operational capabilities which the guideway and switching crossovers must exhibit. The automatic signaling and control system will be designed to allow for one-directional guideway shuttle operation during Degraded Mode Operation. This signaling and control capability will be fail-safe to assure safe, automatic train operation for both operational modes.

(1) Switching Operational Provisions

The switching crossovers "a", "b", "d", "e", "f", "g", and "h" shown on Figure 4-12 must provide certain operational capabilities to assure smooth system operation. To explain these capabilities, it is necessary to differentiate between the two types of crossovers utilized in the JASE System. Switchbacks "a", "e", "f", and "g" are the switchbacks utilized in Normal Operation for pinched-loop operations. Sidings "b", "d", and "h" are maintenance/storage sidings which are not used in the system operation except for train storage.

(2) Switchback Operation

The switchback shown in Figure 4-15 will be used during Normal Operations. Train movements will be automatic from Section 1 on Track No. 2, over Switch No. 1 in the left diverge direction, through Section 5, through Section 6, through Section 7, over Switch No. 2, and into Section 8. After the train stops at the station and automatically reverses, the train will continue automatic movement from Section 8, over Switch No. 2 in the right diverge (straight-through) direction, and will continue through Section 9 on Track No. 1.

During Degraded Operation, the system will be able to function in the Shuttle Mode on either Track No. 1 and/or Track No. 2 and Switch No. 1 and Switch No. 2 will remain in the right diverge (straight-through) position for back and forth train movements. Switch No. 1 and Switch No. 2 will be capable of being thrown in both reverse and normal direction by the Central Control Operator when not used in the shuttle

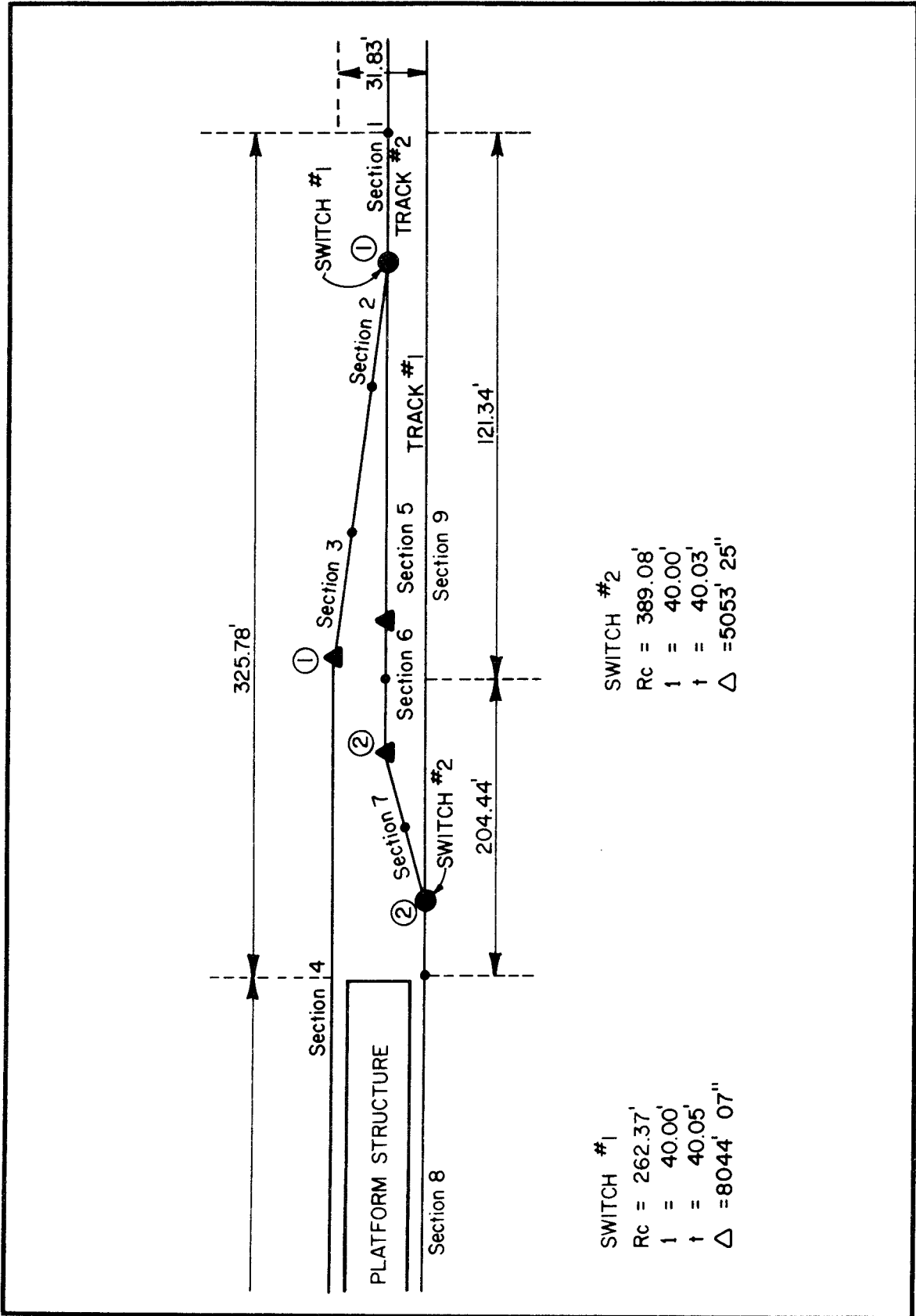

FIGURE 4-15 TYPICAL SWITCHBACK AT STATIONS WITH STORAGE IN STATION

operation. This feature will be used to afford traffic movements for disabled vehicles or desired vehicle management.

During off-peak hours, the vehicle will be stored on Track No. 2 in Section 4. This area will also be used for disabled vehicle storage and emergency or security unloading. Train movements will be from Section 1, through Switch No. 1, through Section 2, Section 3, and on to Section 4. In order to move the vehicles from Section 4, the operator will reverse the vehicles run through Section 2, Section 3, and over Switch No. 1 in reverse. The vehicles will be stopped, reversed again, and pass through Switch No. 1 into Section 5 in the same manner as Normal Operations. The operational capabilities explained above for switchback "a" are also typical for switchbacks "d", "e", and "f".

(3) Maintenance/Storage Siding Operation

Maintenance/storage sidings "b", "d", and "h", as shown in Figure 4-16, will be used for emergency maintenance and storage of trains incapable of service due to equipment failure. They would not be involved in the Normal Operation of the system. Switch No. 1 and Switch No. 2 will always be in the right diverge (straight-through) direction during Normal and Degraded Operations. Switch No. 1 and Switch No. 2 will only be set to the left diverge position by the Central Control Operator when manual operation of a train is desired into or out of Section 4; that is, to/from Section 2 and Section 6. Section 4 will be capable of storing one 2-car train.

Since all operations into and out of Section 4 is manual, no automatic operation capability for train movements on Section 4 need be provided. However, as in the other guideway sections of the JASE System, occupancy indication of Section 4 will be integrated with the Automatic Train Control Subsystem and provided at Central Control. Provisions will be made such that the manual operation of trains into and out of Section 4 will be made safely with respect to the position of Switches No. 1 and/or No. 2. Guideway Sections 2 and 7 (switch blocks) must be signaled and controlled to provide train separation consistent with the overall Automatic Vehicle Protection system.

Operational Scenarios - Initial Segment

The Initial Segment of the JASE System will consist of the portion of the N/S line from FJC to St. Johns Place. The Central Control operation will be the same as described for the Full System. For the Initial Segment, siding "b" will be a switchback siding.

. Normal Operation

Normal Operation of the Initial Segment is the same as described for the N/S line except the service extends from Station C (FJC) to Station I (St. Johns Place).

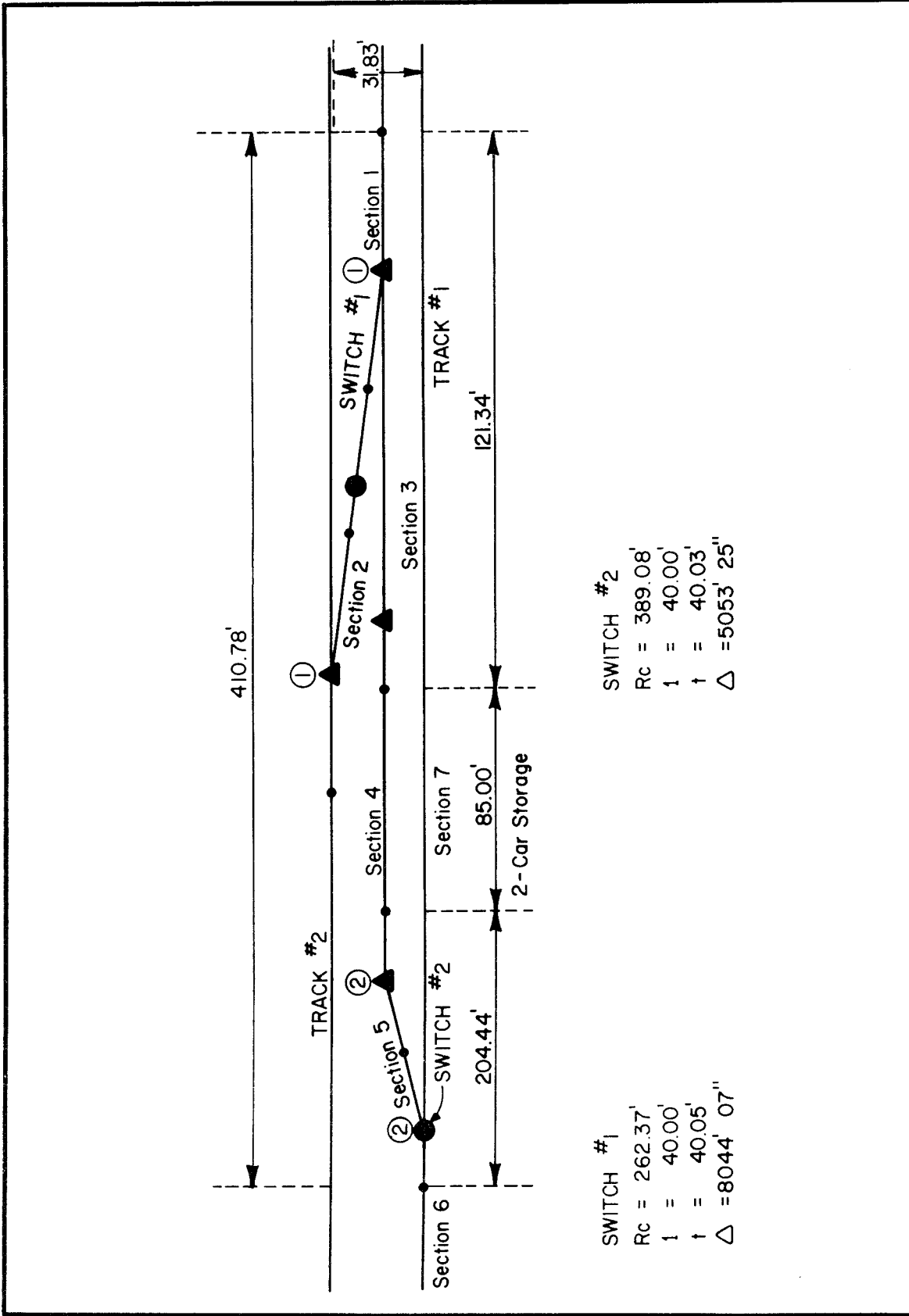

FIGURE 4-16 TYPICAL MAINTENANCE AND STORAGE SIDING GUIDEWAY WITH 2-CAR STORAGE

(1) Peak Mode

Peak Mode operation for the Initial Segment is the same as described for Peak Mode of the Full System except for the following differences:

- * Peak Mode will involve 8 vehicles.
- * Stations A and B are not included in the Initial Segment and crossover "b" will operate as a switchback identical to switchback "a" in the Full System.

(2) Off-Peak Mode

Off-Peak Mode operation for the Initial Segment is the same as described for Off-Peak Mode of the Full System except for the following differences:

- * Off-Peak Mode operations will operate with 3 vehicles for the Initial Segment.
- * Mode changing criteria from Peak Mode to/from Off-Peak Mode will be similar to the Full System criteria except the change must be completed within a maximum time of 8 minutes.

. Degraded Operation

Degraded Operation of the Initial Segment will consist of the operation of three shuttles on the N/S line; one shuttle between Stations C and E; a second shuttle between Station E and G; and a third shuttle between Stations G and I. Figure 4-17 illustrates this Degraded Operation. Alternating southbound and northbound tracks will be used similar to the description for the N/S line. Synchronized train departures from the transfer stations will be provided and Central Control Operator control of the operation will be similar to that described for the Full System.

. Override Operations

Override Operations for the Initial Segment are the same as described for the Full System.

. Guideway and Crossover Operation

Similar to the Full System, the automatic signaling and control system for the Initial Segment must be designed fail-safe and must allow for 1-directional guideway operation during Normal Operation and bi-directional guideway operation during Degraded Operation.

. System Performance

The tentative guideway alignment and station locations for the Initial

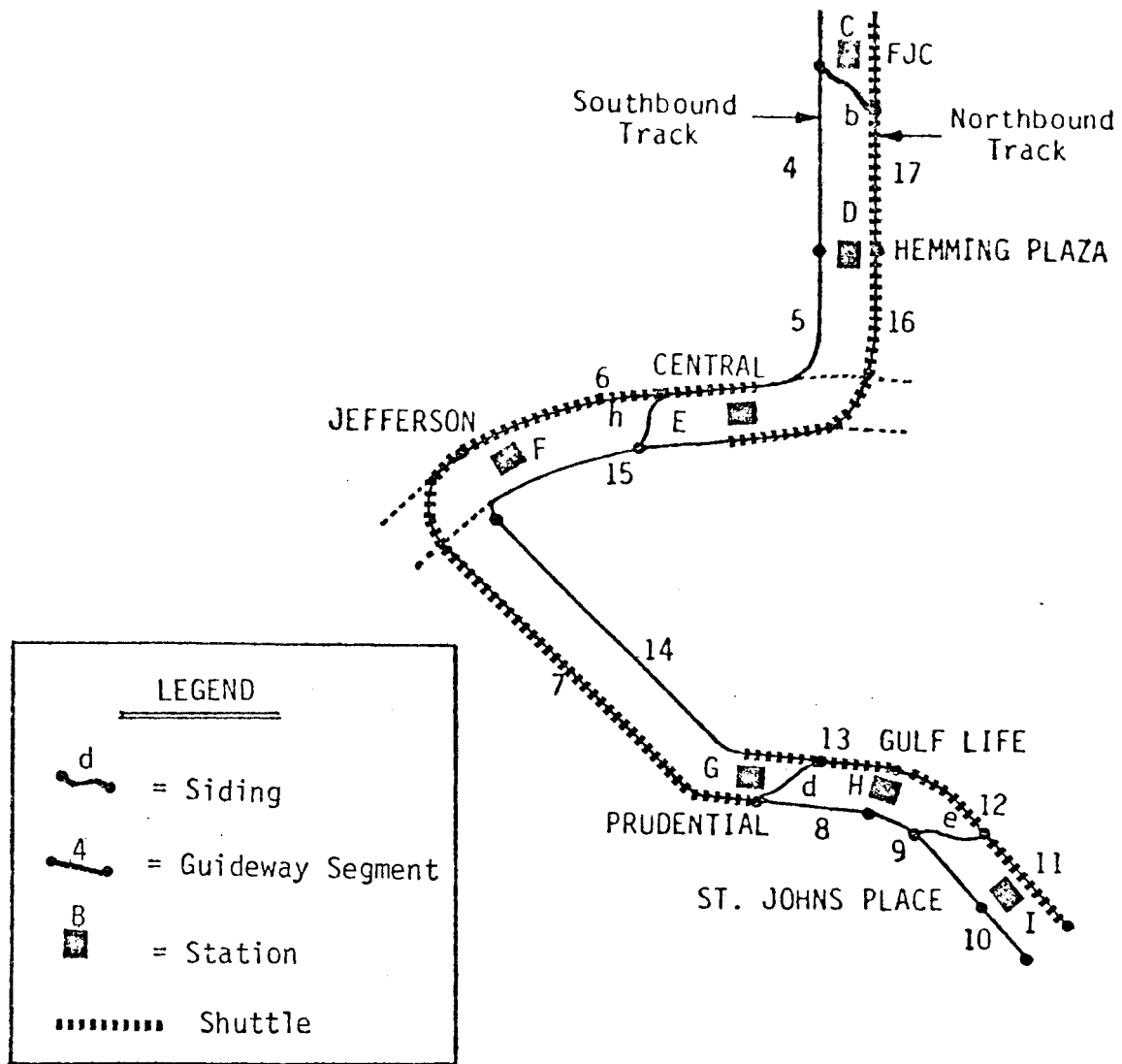

FIGURE 4-17

FIRST SEGMENT DEGRADED OPERATION SHUTTLES

Segment were utilized to develop the expected system performance characteristics for the line.

Table 4-11 summarizes the performance to determine the total round trip time to be expected on the Initial Segment. Note that the dwell time was assumed to be 12 seconds at each of the 12 station stops on the round trip. If it is subsequently determined that a longer dwell time is required to process large numbers of riders, the round trip time will increase accordingly.

(1) Peak Mode Operation

During Peak Mode Operation of the Initial Segment, it is desired that service be provided at each station at 2-minute intervals, or less. Considering a round-trip time of 14.7 minutes, 8 trains will be required to provide the desired service. Using 8 trains, the service to each station in each direction will be, on the average, every 1.8 minutes.

(2) Off-Peak Mode Operation

During Off-Peak Mode Operation of the Initial Segment, it is desired that service be provided at each station at 5-minute intervals, or less. Considering a round-trip time of 14.7 minutes, 3 trains will be required to provide the desired service. With 3 trains operating, the service at each station in each direction will be, on the average, every 4.9 minutes.

Failure Management Provisions

Failure Management involves the capabilities to be utilized by the JASE operation and maintenance personnel to react to system anomalies and restore system operation.

In order to respond to system failures in a timely manner and restore the system to service, certain capabilities and provisions will be incorporated in the system design/deployment. Central Control will have the capability to reset minor anomalies which result from intermittent failures in the automated control system on-board the vehicles or in the wayside equipment. On-board maintenance personnel will have the capability to manually operate vehicles when automatic operation is not possible due to automatic equipment failure. Vehicle propulsion equipment will have the capability to provide manually operated push/pull power to move a stranded vehicle. The design of the vehicle structure will allow it to be pushed or pulled by another vehicle using a coupling tow bar. Explicit procedures will be used to strictly control all vehicle manual operations. The maintenance/storage sidings will provide off-system storage of failed vehicles during Failure Management Activities.

TABLE 4-11

INITIAL SEGMENT PERFORMANCE

<u>STATIONS</u>	<u>DISTANCE IN FEET</u>	<u>TRAVEL TIME IN SECONDS</u>	<u>DWELL TIME IN SECONDS</u>
Florida Junior College (C) Link C-D	1,403	48.1	30.0*
Hemming Plaza (D) Link D-E	1,519	51.3	12.0
Central (E) Link E-F	1,094	42.0	12.0
Jefferson (F) Link F-G	4,069	120.0	12.0
Prudential (G) Link G-H	1,326	46.7	12.0
Gulf Life (H) Link H-I	1,344	46.3	12.0
St. Johns Place (I) Link I-H	1,344	48.3	30.0*
Gulf Life (H) Link H-G	1,326	48.3	12.0
Prudential (G) Link G-F	4,069	113.8	12.0
Jefferson (F) Link F-E	1,094	41.6	12.0
Central (E) Link E-D	1,519	51.1	12.0
Hemming Plaza (D) Link D-C	1,403	48.1	12.0
Florida Junior College (C)	<u>0</u>	<u>0</u>	<u>0</u>
TOTALS	21,510	704.1	180.0

TOTAL ROUND TRIP TIME = 884.1 seconds = 14.7 minutes

* Dwell time includes reversing the vehicle and switching guideways.

The approach to effective Failure Management for the JASE System will involve a hierarchical response directed by the Central Controller. Anomalies affecting system operation/service are classified as "vehicle" related or "other system equipment" related. Five typical scenarios for Failure Management of the JASE are described in the following paragraphs.

For minor vehicle or other system equipment anomalies, the system can be restored to Normal Operation by simply resetting a vehicle or system equipment intermittent failure from Central Control. Such system interruptions will generally result in only momentary service interruptions unknown to most users.

For anomalies which cannot be reset by the Central Controller, maintenance personnel will be dispatched to the vehicle or wayside equipment rooms. In many instances, the system operation will be restored by the on-site resetting of the equipment fault. When the resetting attempts fail to restore automatic vehicle operation, responding maintenance personnel will assume responsibility and control of the failed vehicle using the manual control capability. The vehicle will be manually driven and, after off-loading passengers at the next available station, removed from the system. System interruption resulting from this restoration process will be approximately 10-15 minutes.

In the event that a stalled vehicle has a failure which precludes manual operation, the responding maintenance personnel will remove the vehicle from service by using the next upstream vehicle in the system to push the failed vehicle; then it will be removed from the operating system. This process of system restoration will require 15 minutes or longer to complete and system service will be provided through Degraded Operation.

Catastrophic vehicle failures, such as wheel lock-up, broken axle, and power pick-up/rail damage, are failures which will cause lengthy interruptions. Guideway blockage, power failure, and control system failure are other system equipment failures which are not easily correctable. Such events will generally require Degraded Operation until the situation is corrected.

The response time of maintenance personnel to any system equipment location will be no longer than 5 minutes. During peak periods, roving maintenance personnel will be strategically stationed along the route to assure the 5-minute response.

Emergency Procedures

It will be possible to evacuate passengers in an emergency that requires immediate evacuation. Emergency doors in the vehicle will be provided to discharge passengers onto the guideway. The guideway will have walls, fencing, or handrails of sufficient height and strength to protect persons from hazards due to the elevation of the guideway and will have a solid running surface free of any open areas. An emergency walkway will be provided. The walkway will be equipped with a railing of

sufficient height and strength to protect persons from hazards due to the elevation of the guideway.

Regardless of the technique, opening of emergency doors or unscheduled opening of regular doors will automatically transmit an alarm to Central Control and power will be removed from all segments between the vehicle and the next station in both directions. The design of the system will include provisions to enable the timely and unsupervised evacuation of patrons and personnel from all fixed structures and facilities. Emergency evacuation of ambulatory passengers out of a crush-loaded vehicle anywhere in the system will be accomplished within 2 minutes. The emergency illumination level will be a minimum of 1 foot-candle at pavement level for nighttime use of all walkways or other emergency egress routes.

The UMTA report, Evacuation and Rescue in Automated Guideway Transit, Volumes I and II (Report No. UMTA-MA-06-0048-79-2 and UMTA-MA-06-0048-79-3, dated May 1979), will be used as a guideline for emergency rescue procedures.

Staffing Requirements

A major operations and maintenance (O&M) cost in any transportation system is for salaries of the O&M personnel. An advantage that the JASE System has over conventional mass transit systems is that the JASE System will be operated using driverless, unattended vehicles.

There will be three basic areas of responsibility in the operation and maintenance of the JASE: management/administration, operations, and maintenance. The estimated number of personnel identified for each identified position was determined by making the following assumptions:

- 1) The JASE System will be operated 14 hours/day, 7 days/week. Sufficient O&M personnel to cover 2 shifts/day, 7 days/week will be required.
- 2) Management/administration of the Operations personnel will be accomplished by the Director.
- 3) The Central Control Operators will be utilized on a shared half-time basis with other duties but are available to reset the JASE System when needed. This is reflected in reducing the 4 operators to 2 operators for the Initial Segment.

Personnel requirements for both the Initial Segment and the Full System are shown in Table 4-12.

Expansion Requirements

The Jacksonville ASE System, as presently planned, will be designed, constructed, and deployed in segments starting with the Initial Segment,

TABLE 4-12

JACKSONVILLE ASE SYSTEM STAFFING PLAN
OPERATIONS AND MAINTENANCE

<u>POSITION/TITLE</u>	<u>INITIAL SEGMENT (2.1 miles)</u>	<u>TOTAL SYSTEM (4.4 miles)</u>
<u>Management/Administration</u>		
Director	1	1
Safety, Assurance, Quality Control Engineer		1
Secretaries/Clerical	$\frac{1}{2}$	$\frac{1}{3}$
Sub-total	$\frac{1}{2}$	$\frac{1}{3}$
<u>Operations</u>		
Operations Manager		1
Control Center Operator	2 (4 @ 1/2	4
Sub-total	$\frac{2}{2}$ time)	$\frac{4}{5}$
<u>Maintenance</u>		
Maintenance Manager	1	1
Lead Mechanical Technician		1
Mechanical Technician A	2	2
Mechanical Technician B	1	2
Lead Electrical/Electronic Technician		1
Electrical/Electronic Technician A	2	2
Electrical/Electronic Technician B	1	2
Facilities Technician	3	4
Hosteler	1	2
Sub-total	<u>11</u>	<u>17</u>
TOTAL O&M STAFFING	15	25

Segment I, the south part of the N/S line; expanding with Segment II, the west line; continuing with Segment III, the northern section of the N/S line; and completing the total system by the addition of the eastern section of the E/W line from Hogan Street to the Government Center Station. To assure an orderly expansion process, there are certain provisions which must be included in the design and construction of the Segment I system.

. Vehicles

The vehicles for the Phase I JASE System will be designed to permit future expansion of consist size to a maximum consist length capable of operation within the platform length of 87'.

. Graphics

In designing the passenger information system for the Segment I JASE stations, an integrated station graphics and passenger information plan for the Total System will be developed. This plan will include both static and dynamic graphics equipment compatible with the Total System graphics.

. Guideway

In developing the structural design for the Segment I JASE guideway, analyses and allowances for future consist densities associated with the Total System will be made.

All space necessary for future switching equipment will be incorporated in the Segment I guideway as well as for the future mounting of power and communication rails on both sides of the guideway, if necessary.

. Power Distribution System

Future primary power sources will be identified and the Segment I power distribution system will be designed compatible with the identified primary power services for the Total System.

. Control System

The automatic control system for the Segment I system will be designed to permit operational headways of 75 seconds without violating the limits of the Automatic Vehicle Protection subsystem. The Automatic Vehicle Operation subsystem for Segment I will be designed to accommodate the 75-second operational headways while permitting only minor modifications when the system is expanded. All Central Control display equipment, the computer hardware, and the computer software will be designed accordingly.

. Maintenance Facility

The Maintenance Facility, including the Maintenance Building and the associated test/storage guideway, will be sized to accommodate the total JASE System but only equipment necessary for Segment I will be initially provided.

INTERMODAL OPERATIONS

There are three modes that patrons utilize to arrive or depart from a JASE station: walk, auto/taxi, and bus mode. Each of these presents a different operational requirement on the JASE System and must be accounted for in the design.

Walk Mode

Some of the entry trips and nearly all the departing trips by JASE patrons will be by the walk mode. Walking patrons enter the JASE System at random time periods. The major period of walking entries are made in the noon peak hour as opposed to the morning or afternoon rush periods. During the noon period, the JASE System will serve as a circulation system for specialized trips within the Downtown area such as shopping, lunch, or deliveries. The proportion of walk entries is 10 or 12 noon trips to every AM or PM trip. The station entry has been designed to separate these walk trips and make access easy for patrons. A series of second-level walkways would enter the station at the mezzanine level. Escalators and elevators would also be available to take people from the ground level to the platforms. During commuter peak periods in the morning and afternoon, walk entry trips are relatively small and fortunately do not compete for access with the other entry modes.

Auto/Taxi Mode

A significant number of patrons will arrive or depart at a station from automotive vehicles. During the commuter peak periods, these patrons represent about a third of all arrivals at the end stations. Many of these patrons will park their autos for the day and complete their commuter trip on the JASE. These patrons will also arrive at random but generally more predictable times and at greater concentrations. Operationally, the JASE must adapt to these short demand spurts during the high ridership density peaks in commuter periods.

Bus Mode

As a matter of assumed JTA policy, regional buses are to be brought to the end stations of the JASE and patrons will transfer to the JASE. The exceptions are those bus routes where the total travel time would be greater by forcing the bus patrons to transfer. The JASE will also facilitate the movement of cross-town bus patrons by concentrating the possible bus routes in a more central location and speeding the transfer time. Operationally, the bus patrons do not arrive in a random pattern as do the other two modes. The buses are scheduled and their arrival can be timed to fit both the JASE demands and bus transfer possibilities. Since the bus rider often is half of the arrivals or departures from the stations, this ability to schedule the flow of patrons to and from the JASE System is an important operational advantage. However, the buses will also load and unload the JASE in rather large blocks of

patrons that may sometimes match the total capacity of the JASE trains. Therefore, accommodating the bus mode represents the most difficult intermodal problem for the JASE. The remainder of this section will discuss the adaptations studied and recommended for all these modes with emphasis on the bus.

Long-Term Bus Network Change

The existing regional bus network is radial, with nearly all routes ending in the Downtown area within about a 3-block radius of Hemming Plaza. This puts a heavy traffic and pedestrian burden on the most densely developed areas, especially during rush hours. One of the earliest concepts of the JASE was to divert the incoming buses to the ends of the JASE lines, which are beyond the dense core area but still within the Downtown. This concept would remove buses from the core congestion, reduce total travel time of the bus commuter, and reduce the vehicle mileage of the bus, allowing more service for the regional bus system.

During 1979, and again early in 1981, the bus diversions were conceptualized for the JASE ridership estimations. These mathematical diversions gave estimated daily and peak period (three each weekday) bus diversion estimates to help size the station platforms and vertical circulation elements. This patronage also determined the operational characteristics of the system, especially headways and link volumes, and determined fleet size for the JASE vehicles. These estimates were sufficient for the feasibility and conceptual design effort. However, the preliminary engineering and environmental impact statement required more detailed information on the rate of buses entering each of the intermodal stations.

The general methodology used was to accept the existing schedules for the regional bus system and add the new bus routes and frequencies required by the 1985 and 1995 forecasts for bus patronage from the Updated JUATS Plan. In addition, the bus routes were diverted from their existing routes into the nearest intermodal station. The schedule time for the affected bus routes was adjusted to reflect the usually much shorter distance and time. There are three intermodal stations on the 2.1-mile Initial Segment of the JASE System, including:

- 1) FJC Station which would have 23 different bus routes diverted to it, including four new 1995 bus routes. This station intercepts most of the routes from northern, northwestern, and eastern areas of Jacksonville.
- 2) Jefferson Station which would have 10 different bus routes diverted to it, including one new 1995 route. This station would intercept buses from the western and southwestern areas of Jacksonville.
- 3) St. Johns Place Station which would have 11 different bus routes diverted to it. This station would intercept buses from the southern and eastern areas of Jacksonville.

There would be a number of express buses and Downtown loopers that would continue to serve the Downtown core without being intercepted by the intermodal station because the requirement to transfer to the JASE System would increase the riders' overall travel time. The steps in the analysis included listing all arrivals at the intercept station for each bus on each route from the start of service in the morning to 8:30 AM on a weekday. This represents the full morning peak period. The arrival schedules were taken from existing bus schedules and adjusted for the shorter trip to the intermodal station. Then, all arrivals were listed chronologically regardless of bus route. It was assumed that a bus could enter the station, park at its appropriate marked stall or bay, unload both doors, load waiting passengers, and leave the intermodal area within 5 minutes. Therefore, the gross arrival schedules were accumulatively bracketed with 5-minute time spans to determine the raw number of buses which would be in the station within successive 5-minute periods throughout the AM peak period.

These arrival brackets were then compared to the expected 1985 and 1995 peak hour bus ridership. The JASE System concept also assumed that there would be no waiting for bus patrons. There, the total number of average riders for each bus from each route was accumulated and compared to the capacity of the JASE vehicles operating on 2-minute headways to carry these transferring bus riders. If necessary, certain bus schedules were adjusted to spread arrivals into adjoining 5-minute brackets to prevent schedule bias. The final result was a net number of buses which must be in the intermodal facility at the peak time. This, then, represented the number of bus bays to be provided.

The AM peak period was chosen for design and operational analysis because its arrivals were more concentrated and less adjustable than the PM peak period. In the PM peak period, the number of riders reaching the buses would be entirely dependent on the capacity and frequency of the JASE vehicles and, therefore, controllable. In both cases, there would have to be complete integration between the bus and JASE schedules. The intolerance for schedule deviation would be much greater for the bus operator. The design implications for each of the intermodal stations is discussed in the following paragraphs.

. FJC Station

The FJC Station is by far the most heavily used of the intermodal stations. Not only would it have the largest number of bus routes serving it, but it would also have many of the highest rider densities and the greatest frequency of service. The analysis showed that it would require as many as 9 bus stalls at this station to meet the 1985 bus schedules. Moreover, the 1985 bus riders would occupy most of the AM/PM peak period capacity of the JASE vehicles operating at 2-minute headways. The Northside and Arlington buses would both use this facility. There is a heavy cross-town transfer between these lines. Some of the ridership from this line would not use the JASE System but would transfer within the intermodal bus facility. This

is the only intermodal station where this heavy intermodal transfer would occur.

Another peculiar feature of this station is that by 1995, it is assumed that the JASE alignment would be extended further north to Eighth Street and at least 7 of the bus routes serving FJC in 1985 would be transferred to the Medical Center Station in 1995 to reduce travel time. The number of bus stalls at FJC, therefore, would be reduced to 8. However, more riders would now be using the JASE for portions of their trip and the JASE capacity would have to be markedly increased.

. Jefferson Station

The Jefferson Station would have much lighter bus traffic, both in frequency and levels of ridership. The maximum number of bus bays needed to serve the 10 routes would be 3. By 1995, the intermodal facility would no longer be needed if the JASE were extended to Riverside Station. If it is not extended, then 4 bays would be needed. If the Initial Segment went from FJC to Riverside Stations, then the Jefferson Station intermodal facility would not be needed at all.

. St. Johns Place Station

The St. Johns Place Station would have 11 routes using 4 bays in 1985. There would be an increase of 42 percent in bus ridership by 1995. However, the 1985 bus frequency is relatively well spaced and only twice during the peak period would it require 4 bays. With some judicious scheduling, the number of bays would only increase to 5.

SYSTEM SAFETY PROGRAM

The principal objective of the JASE System safety program is to ensure that safety, consistent with system performance requirements, is designed into all elements of the system and to ensure further that safety considerations are planned and integrated into all phases of the JASE System life cycle including design, development, evaluation, fabrication, construction, and operation.

The successful contractor will be required to develop a formal safety program that stresses early hazard identification and elimination or control. The emphasis on timeliness is required to minimize:

- 1) The schedule and cost disruptions that could result from redesign efforts, and
- 2) The potential dependence upon operating procedures rather than inherent design to control hazards.

The contractor's safety program will be established, implemented, and maintained during all phases of JASE System development in order to:

- 1) Ensure that the JASE System achieves the highest practical level of safety for people, property, and the environment during system construction and operation.
- 2) Establish a disciplined approach to methodically identify safety critical JASE subsystems and control system safety characteristics so that conformance with the system performance requirements is ensured without compromising safety.
- 3) Plan, integrate, and coordinate system safety criteria with other major system performance requirements and criteria such as, but not limited to, system assurance or elderly and handicapped provisional requirements.
- 4) Identify, coordinate, and control safety interfaces between JASE program participants including subcontractors and major subsystem suppliers.
- 5) Incorporate appropriate JASE System safety characteristics to ensure compliance with all local and regional safety codes and regulations.
- 6) Optimize JASE System safety features to ensure coordination of these features with local fire, police, and emergency medical service agencies.
- 7) Incorporate appropriate JASE System safety characteristics to ensure compliance with federal, state, and local regulations requiring a safe working environment for construction personnel during system construction and maintenance personnel during system operation.

Risk Assessment

As a part of the safety program, the contractor will develop a risk assessment procedure to determine the severity and probability of occurrence of hazards which will establish priorities for corrective action and resolution of identified hazards.

. Hazard Severity

Hazard severity categories will be defined to provide a qualitative measure of the worst potential consequences resulting from personnel error, environmental conditions, design inadequacies, procedural deficiencies, system, subsystem, or component failure, or malfunction. Hazard severity shall be categorized as follows:

- 1) Category I - Catastrophic - may cause death or system loss.
- 2) Category II - Critical - may cause severe injury, severe occupational illness, or major system damage.
- 3) Category III - Marginal - may cause minor injury, minor occupational illness, or minor system damage.

4) Category IV - Negligible - will not result in injury, occupational illness, or system damage.

To assist in categorization, the following definitions are to be used:

- 1) "Severe injury" includes any injury to passengers, operations, and maintenance personnel, and/or persons in proximity to the system which:
 - a) requires hospitalization for more than 48 hours, or
 - b) involves lacerations which cause severe hemorrhages, nerve, and muscle or tendon damage, or
 - c) involves injury to any internal organ, or
 - d) involves second or third degree burns or any burns affecting 5 percent or more of the body surface.

- 2) "Major system damage" includes:
 - a) Damage accrued to JASE System/equipment and/or property resulting in more than \$5,000 for cost of repair or replacement in kind, or
 - b) Any damage accrued to non-JASE System equipment and/or property due to JASE operations resulting in more than \$2,000 for cost of repair or replacement in kind.

. Hazard Probabilities

The probability that a hazard will occur during the planned life expectancy of the JASE System shall be described in potential occurrences per unit of time, number of passengers, or other measure. A qualitative hazard probability may be derived from research, analysis, or evaluation of historical safety data from operational systems similar to the JASE. Supporting rationale for assigning an operational hazard probability shall be documented in hazard analysis reports. Table 4-13 is an example of a qualitative probability ranking.

TABLE 4-13
HAZARD PROBABILITY RANKINGS

<u>DESCRIPTIVE WORD</u>	<u>LEVEL</u>	<u>SPECIFIC INDIVIDUAL ITEM</u>
Frequent	A	Likely to occur frequently
Reasonably Probable	B	Will occur several times in life of an item
Occasional	C	Likely to occur sometime in life of an item
Remote	D	So unlikely it can be assumed that this hazard will not be experienced
Extremely Improbable	E	Probability of occurrence cannot be distinguished from zero
Impossible	F	Physically impossible to occur

Hazard Analyses

Hazard analyses will be performed to identify hazardous conditions and to effect their control during all system life cycle phases. Analyses shall be made to systematically examine the JASE System, subsystems, facilities, components software, personnel, and their interrelationship including logistics, training, maintenance, test, modification, and operational environment. The analyses shall be accomplished to do the following:

- * Identify hazards, determine any needed corrective actions, and establish corrective action priorities.
- * Determine and evaluate safety considerations in tradeoff studies.
- * Determine and evaluate appropriate safety design and procedural requirements.
- * Provide documented evidence of compliance with specified safety tasks, objectives, and design requirements.

The selection of specific methods and techniques for performing these analyses shall be based on the level of complexity of the system element under consideration. The hazard analyses methods and techniques selected for the system safety program should provide for continuity throughout the system life cycle and the interfacing of results from one analysis to another to ensure identified hazards are corrected.

As a minimum, the contractor shall perform the following hazard analyses:

- * Preliminary Hazard Analysis (PHA)
- * Subsystem Hazard Analysis (SSHA)
- * System Hazard Analysis (SHA)
- * Operating and Support Hazard Analysis (OSHA)

. Preliminary Hazard Analysis (PHA)

A PHA will be performed to obtain an initial risk assessment of the JASE System as a whole. The purpose of a PHA is to identify safety critical areas, evaluate hazards, and identify the safety design criteria to be used. The PHA effort will be started during the initial phase of the program so that safety considerations are included in tradeoff studies and design alternatives. Based on the best available data, hazardous conditions associated with the proposed design or function should be evaluated for hazard severity, hazard probability, risk, and operational constraint. The information will be used in the developing system safety requirements and in preparing subsystem performance and design specifications. The PHA should consider the following for identification of hazards:

- * Hazardous components

- * Safety-related interface considerations among various elements of the system
- * Environmental constraints including the normal operating environments
- * Operating, test, maintenance, and emergency procedures (e.g., human error, analysis of operator functions), tasks, and requirements; effect of environmental factors such as equipment layout and lighting requirements on human performance, emergency evacuation, and rescue
- * Facilities, support equipment, and training
- * Safety-related equipment, safeguards, and possible alternate approaches

. Subsystem Hazard Analysis (SSHA)

SSHA will be performed to identify hazards associated with component failure modes and functional relationships of components and equipment comprising each subsystem. Such analysis would identify all components and equipment whose performance, performance degradation, functional failure, or inadvertent functioning could result in hazard. The analysis would include a determination of the modes of failure including all single point failures and the effects on safety when failures occur in subsystem components.

. System Hazard Analysis (SHA)

A SHA will be performed on subsystem interfaces to determine the safety problem areas of the Total System. Techniques similar to those used for the SSHA would be used. Such analyses would include a review of subsystems' interrelationships for:

- * Compliance with safety criteria.
- * Possible independent, dependent, and simultaneous failures that could present a hazardous condition including failures of safety devices.
- * Degradation in the safety of a subsystem or the Total System from normal operation of another subsystem.
- * Changes that occur within subsystems so that the system hazard analysis can be updated accordingly.

. Operating and Support Hazard Analyses (OSHA)

OSHA analyses will be performed to identify and control hazards and determine safety requirements for personnel, procedures, and equipment used in construction, installation, maintenance, testing, modification,

transportation, storage, operation, emergency escape, egress, rescue, training, and disposal during all phases of intended use. The analyses will also address hazards to the system that may be induced by maintenance personnel.

Action on Identified Hazards

The safety program will include procedures for the elimination or minimization of hazards revealed by analyses or related engineering efforts. Catastrophic critical or marginal hazards will be eliminated or controlled.

Safety During Construction and Testing

The contractor's safety program will include provisions for the elimination or minimization of hazards during the JASE System construction and testing periods. Program emphasis will include safety considerations for the general public located in close proximity to the JASE System as well as construction and system maintenance or operating personnel.

System Safety Program Plan

Within 90 days after Notice to Proceed, the contractor will prepare and submit for review and approval by the JTA a JASE System Safety Program Plan (SSPP) to describe the following:

- 1) The methodology, process, and procedures by which the contractor proposes to meet the JASE System safety program requirements.
- 2) The contractor's safety organization including responsibilities and functions of those directly associated with system safety policies and implementation of the program will be clearly defined.
- 3) The contractor's plans, schedule, and procedures for the conduct of periodic status reviews for the purpose of evaluating the overall effectiveness of the system safety effort.
- 4) The contractor's methods and procedures to be used to assess risks and for analyzing hazards so as to ensure their control during all JASE System life cycle phases.
- 5) The methods and procedures by which hazards, which have been revealed, are to be eliminated or minimized. Methods for the incorporation of design changes shall be described.
- 6) The contractor's plans to eliminate or minimize hazards during system construction and testing periods. Indicate how the general public, construction personnel, and system operations and maintenance personnel will be protected from hazards. Provide information on

strategies to be used to protect the environment from excessive noise and/or other pollutants particularly during system construction.

System Safety Criteria

The following items comprise the system safety criteria to be met during the design, construction, and implementation of the JASE System.

. Safety Principles

There are two principles of safety that shall be used in the design of all safety critical ASE subsystems, including the Automatic Vehicle Protection (AVP) system, the brake system, automatic doors, and the switching system. One or the other or both of these principles must be used to insure safety. These principles are the fail-safe principle and the checked-redundancy principle as described in the following paragraphs.

(1) Fail-Safe Principle

The fail-safe principle applies to hardware configurations and states that the occurrence of any frequent failure of a hardware element (as defined by the Component/Equipment Failure List), or any combinations of such failures, shall not result in an unsafe condition.

(2) Checked-Redundancy Principle

The checked-redundancy principle refers to either hardware or software configurations and states that the probability of any frequent failure, or combinations of such failures (as defined by the Component/Equipment Failure List), that can result in an unsafe condition shall be controlled to produce a risk comparable to that associated with traditional fail-safe design.

The checked-redundancy control configuration, whether it comprises hardware or software elements, incorporates at least two parallel control units processing a common system basic behavioral characteristic and a means of comparing the output of the control units. If there is "agreement" from the comparison, then the vehicle is allowed to respond in accordance with the output of the control units. If there is "dis-agreement" and the vehicle is in motion, the emergency brakes should be applied. If the vehicle is not in motion, it shall not be allowed to move.

. Component/Equipment Failure List

In design of a fail-safe configuration, components shall be selected so that the occurrence of any failure or combination of failures listed

in the Component/Equipment Failure list shall not result in an unsafe condition.

In a checked-redundancy configuration involving hardware components, the Component/Equipment Failure List shall be used to define the elements subject to failure. Each of the components has a probability of failure which must be taken into account to determine the probability of failure of the checked-redundancy configuration.

In a checked-redundancy configuration involving software applied to a computer, the probability of an error in the software program shall be considered to determine the probability of an unsafe condition occurring in the configuration.

. Operational Safety Criteria

The system design must minimize the dependence of system safety during normal operations upon correctness of actions taken or not taken by operating or maintenance personnel.

During service disruptions or other abnormal conditions, particular wayside elements or vehicle control elements will be depended upon for safety. The fact that these elements are seldom used shall not be employed to justify unsafe design.

In cases where the safety of system design may be degraded by environmental extremes or excessive stresses on equipment, procedures shall be provided for preventing system operation until safe operation is ensured.

Fire Safety

The JASE System will be designed to minimize fire hazards in the vehicles, stations, and the maintenance facility. Fire safety criteria for the design of the JASE System equipment is presented below.

. Vehicle Fire Protection

Each vehicle shall be equipped with two dry powder type fire extinguishers, clearly visible to the passengers. Thermal overload protection shall be provided for propulsion motors, compressor motors, and other large motors. Temperature sensors to warn of overheating shall also monitor the motor controller compartments and brake friction surfaces. Smoking will not be permitted in vehicles.

No polyvinyl chloride, polyurethane foam, polystyrene foam, or foam rubber will be used in the vehicles.

No flammable oils or hydraulic fluids except as required for normal lubrication needs would be used.

Seat cushions and thermal and acoustical insulation will be capable of passing the ASTM E162-78 "Radiant Panel Test" with a flame propagation index (I_s) not exceeding 25.

Exterior vehicle shell, wall, and ceiling panels, wind screens, seat frames, seat stands, partitions, and ducting will be capable of passing the ASTM E162-78 "Radiant Panel Test" with a flame propagation index (I_s) not exceeding 35, with the added provision that there will be no flaming dripping.

Upholstery material will be tested by FAA Regulation 25.853, "Crash-worthiness Standard", Vertical Test, Appendix F(b) with modifications.

Carpeting or other material used as floor covering will be tested with its padding, if the latter is to be used, and will be capable of passing test method NFPA Standard No. 253-78, "Critical Radiant Flux of Floor Covering Systems Using a Radiant Heat Energy Source", with a minimum critical radiant flux of 3.2W/in^2 (0.5W/cm^2).

Windows and lighting diffusers will be capable of passing the ASTM E162-78, "Radiant Panel Test", with a flame propagation index (I_s) not exceeding 100.

Flooring of nonsuspended vehicles and roofing of suspended vehicles will be capable of withstanding the requirements of ASTM E119-79, "Fire Tests of Building Construction and Materials", when exposed to either a nominal test period or a minimum test period, whichever is greater, at up to 1400°F (760°C) on their respective underside or topside surfaces.

The nominal test period will be twice the maximum expected period of time under normal circumstances necessary for a vehicle to come to a complete, safe stop from maximum speed, plus the time necessary to evacuate all passengers from a vehicle to a safe area.

Elastomers will be capable of passing the requirements of ASTM C542-76, "Standard Specification for Lock-Strip Gaskets", with the added requirement that there be no flaming dripping.

All materials will be tested for smoke emissions in accordance with NFPA Standard No. 258-76, "Test Method for Measuring the Smoke Generated by Solid Materials". The optical density, D_s , in both flaming and non-flaming modes, and the maximum specific optical density (D_m), determined in accordance with the test.

As a guideline for further consideration of the selection of electrical wire insulation, the following report will be used: UMTA-MA-06-0025-79-2, "Toxicity", December 1978.

In cases of fire on board vehicles, the vehicle will ordinarily be routed to the next station for evacuation if it can be safely moved. If the vehicle cannot be safely moved, alternate evacuation procedures will be used.

. Station Fire Protection

Fire detection and prevention equipment, including smoke alarms, heat alarms, hydrants, standpipes, and sprinklers, shall be provided as necessary within the station facilities. A temperature sensor with rate of rise detection is required at each passenger station and will transmit an alarm to Central Control and to the Fire Department. The provisions for fire detection, prevention, and control systems will be in compliance with local requirements. At a minimum, portable fire extinguishers will be provided at the mechanical/electrical rooms and adjacent to the elevators.

The stations will conform to local fire code requirements. Materials and finishes utilized will have minimum combustibility, toxicity, flammability, burning rates, and smoke generation rates.

A lightning protection system will be provided for each station and for the maintenance facility in order to minimize the probability of building damage, guideway rail damage, or electrical shock hazard caused by a lightning strike.

In case of fire in a station, the Central Control Operator will use the public address system to effect an orderly evacuation of the station via the public exits. In addition, electric power in the station may be disconnected by operations or maintenance personnel. The Operator will dispatch the consist at the affected station and block entry of other vehicles into the station area. Proper authorities will be notified by the Operator.

. Maintenance Facility Fire Protection

Fire extinguishers will be provided in the Maintenance Facility as recommended by NFPA. An electrically supervised, closed circuit, selective codes fire alarm system will be provided. Manual fire alarm stations that are readily identifiable and easily accessible to all personnel shall be provided. Automatic devices, such as fixed-temperature fire detectors, combination smoke and fixed-temperature detectors shall be installed as required by fire code standards. Audible and visual alarms and indications will be provided at local points as necessary. Annunciators will be strategically located. An automatic sprinkler system will be provided.

Provisions will be made for automatic shutdown of air conditioning systems and instructions posted for the closing of fire doors and performance of other functions as required in the area of an alarm.

Vehicle Electrical System Safety

The primary power for the vehicle shall be obtained from power rails in the guideways and conditioned on-board the vehicle to the appropriate voltage for propulsion and housekeeping functions.

All electrical and electronic systems located in the passenger compartment shall be enclosed in locked compartments accessible only to authorized personnel. Wiring shall be installed so it is inaccessible to passengers.

Circuit breakers and interrupts shall be provided for all circuits to guard against overloads.

In the event of loss of prime power, an on-board emergency power system shall automatically provide for all control functions required to bring the vehicle to a safe stop and to maintain fail-safe braking in an "on" condition. The brakes shall remain in an "on" condition, even if the battery is degraded.

In addition, the on-board emergency power system shall provide, for a period of at least one hour, for the following functions:

- 1) Continuous 2-way communication with Central Control;
- 2) Provision of sufficient ventilation to sustain a crush load of passengers (a minimum of 5 cfm per person);
- 3) Emergency interior lights;
- 4) Any vehicle function required for disabled vehicle recovery;
- 5) All vehicle exterior lighting; and
- 6) Vehicle automatic door operation.

. System Emergency Power

An uninterruptable emergency power system shall be provided from batteries and shall include a battery charger and voltage converter. If batteries are used, a battery charger normally powered by the propulsion power distribution system shall be provided. If required, power conditioning equipment to convert battery power to voltages required by JASE equipment shall be provided.

The emergency power supply must provide power for a period of up to 1 hour for the following equipment:

- 1) The primary control subsystem including vehicle presence detection and other safety systems;
- 2) The communications subsystem;
- 3) The Central Control facility;
- 4) The public address system; and
- 5) Safety and surveillance systems.

In addition, self-activated emergency power systems must be provided for stations and maintenance areas. Emergency power for stations and the maintenance area shall be through either a self-contained or rechargeable power supply located within the particular facility and shall be available for a period of at least 4 hours. The intention of these provisions is for continuous system operation in the event of loss of power at any one station.

. Grounding

The grounding equipment portion of the electric power systems for the wayside power rails, on the vehicles, and in any passenger and service facilities shall comply with the following requirements.

Automatic phase-to-phase and phase-to-ground fault, overload, and phase-imbalance protection shall be provided at the secondary of each main power transformer and on all individual circuits. The fault and overload protection system shall be selective, i.e., all protective devices shall be properly coordinated such that any fault or overload condition shall result in tripping of the smallest isolatable portion of the system.

All electric power circuits whose voltage exceeds hazardous levels shall originate from solidly grounded power sources.

Ground current detectors shall be provided between power circuits and ground on the wayside power system to monitor ground current. The detectors shall initiate the interruption of that part of the electric power system in which excessive leakage current and/or ground fault currents are detected.

A non-current carrying ground rail, parallel to the power rails, shall be provided to afford proper continuous grounding of the vehicle. The metal structural elements of the passenger station and guideway, and the exposed metal at the passenger interface, shall be connected periodically to the ground rail at intervals not exceeding 100 feet with connections having a minimum cross-section electrically equivalent to a 4/0 copper conductor. The ground resistance (resistance to earth) shall not exceed 5 ohms when measured in accordance with ANSI Standard C114.1-73, "IEEE Recommended Practice for Grounding of Industrial and Commercial Power Systems".

For DC power distribution systems, the current carrying return rail shall have no more than one single point ground on the system and there shall be guaranteed cathodic protection to other structures and utilities in the region of the ground.

Emergency Evacuation

It shall be possible to evacuate passengers in an emergency in one of the following ways.

- 1) Emergency doors in the vehicle may be provided to discharge passengers onto the guideways. The guideway shall have personnel restraining devices (walls, fencing, handrails) of sufficient height and strength to protect persons from hazards due to the elevation of the guideway and shall have a continuous running surface.
- 2) An emergency walkway may be provided. The walkway shall be equipped with a railing of sufficient height and strength to protect persons from hazards due to the elevation of the guideway.

3) An alternative evacuation technique may be proposed.

Regardless of the technique, opening of emergency doors or unscheduled opening of regular doors shall automatically transmit an alarm to Central and power shall be removed by the Central Control Operator from all segments between the vehicle and the next station in both directions. Furthermore, the following criteria must be met.

- 1) The design of the system shall include provisions to enable the timely and unsupervised evacuation of patrons and personnel from all fixed structures and facilities. Emergency evacuation of ambulatory passengers out of a crush-loaded vehicle anywhere in the system shall be accomplished within 2 minutes; there shall be emergency evacuation procedures meeting this requirement for use in the event guideway power is not available.
- 2) As a general policy, vehicle evacuation required due to conditions which do not pose an immediate threat to the health, safety, or security of the patrons or staff shall be accomplished only under the direct supervision of emergency or system personnel.
- 3) Emergency evacuations required by conditions which pose an immediate threat to the patrons or employees, such as fire, toxic fumes, or flooding, shall be accomplished under the supervision of the staff of the Command and Control Center when on-site aid is not available.
- 4) Facilities, equipment, and instructions shall be provided to insure self-evacuation in conditions where contact with the Command and Control staff is impossible. These provisions for self-rescue shall be such that their use is discouraged except when immediate evacuation is imperative.
- 5) In addition, the design of the system shall include provisions and procedures for the supervised and orderly evacuation of all passengers, including the elderly and handicapped, from vehicles located anywhere in the system in a safe and timely manner.
- 6) As a minimum, provisions shall be included in the design to safeguard patrons and system personnel anywhere on an evacuation route from hazards created by the following:
 - . power distribution system;
 - . moving vehicles;
 - . potential for falls from any structure; and
 - . potential for "tripping".
- 7) The emergency illumination level shall be a minimum of 1 foot-candle at pavement level for nighttime use of all walkways or other emergency egress routes.

The report, Evacuation and Rescue in Automated Guideway Transit, Volumes I and II, is recommended as a guideline for emergency rescue procedures.

SYSTEM ASSURANCE

System Dependability

System dependability is the measure of a system's effectiveness both in providing vehicles in a timely manner to all patrons and in transporting these patrons to their destinations with minimum delays. The chosen approach does not attempt to quantify dependability by means of a single number, but rather to indicate dependability through a series of readily measurable quantities. These quantities are line availability, Degraded Mode line availability, and schedule adherence; which, taken together, provide a measure of the degree to which the system provides service in accordance with the performance specification when subjected to static and dynamic system failures.

. Definitions

The following definitions are pertinent to the assessment of system dependability.

"Downtime Event" - A downtime event is one or more system-related problems which cause unscheduled stoppage of one or more vehicles on any portion of the guideway for a period in excess of one minute.

"Line Downtime" - This is the accumulated time of all downtime events for the system. A downtime event will include all time from when a vehicle movement was interrupted until the fault was cleared and the first vehicle stopped by the failure has resumed movement for patronage services. Line downtime shall be measured separately for each line. Operation in the Degraded Shuttle Mode shall be considered as line downtime.

"Degraded Mode Downtime" - This is the accumulated time of all downtime events resulting in inability to operate in the Degraded Shuttle Mode. The operation of the Degraded Mode is described in the "Operation Plan".

"Operating Hours (Scheduled)" - The periods of normal system operation during which the system is scheduled to operate.

"Operating Hours (Actual)" - The actual number of hours during which the system or line provides service during an operating period. For each line, this is the number of scheduled operating hours less cumulative Line or Degraded Mode downtime for that period.

"Availability (Line and Degraded Mode)" - The ratio of actual operating hours to scheduled operating hours.

"Successful Vehicle Cycles (Trips)" - The number of vehicle cycles around each line completed without interruption or delay due to a downtime event during one operating period. Unscheduled stoppages resulting from the causes listed as "exclusions" shall not be counted.

"Scheduled Vehicle Cycles (Trips)" - The number of vehicle cycles around each line scheduled during an operating period.

"Scheduled Adherence" - The ratio of successful vehicle cycles to scheduled vehicle cycles during an operating period.

"Scheduled Service" - The time sequence of vehicle arrivals and departures on the line resulting from the planned number of vehicles following their planned trajectories.

"Peak Period" - The time interval of heavy system patronage demand.

. Exclusions

The following events are not attributable to the system itself. Delays due to these exclusions are not to be used in evaluating schedule adherence nor system nor line availability.

- * Willful passenger-induced interruptions
- * Interruptions caused by unauthorized intrusions of persons or animate or inanimate objects into the system
- * Interruptions caused by non-system-induced loss of service (e.g., loss of utility service, vehicle diversion resulting from intended security provisions, etc.)
- * Periods of scheduled operating times when the specified environmental limits are exceeded (this includes periods when specified degraded service under high wind conditions is provided).

Dependability Requirements

The entire JASE System shall demonstrate a schedule adherence as defined above of at least 0.93 at the start of revenue service and 0.97 after one year of operation.

The line availability shall be not less than 0.95 at the start of revenue service and not less than 0.99 after one year of operation. This requirement shall apply separately both to the peak periods and to all scheduled operating hours.

The Degraded Mode availability shall be not less than 0.995 at the start of revenue service and not less than 0.999 after one year of operation. During all scheduled operating hours, adequate records shall be kept to assess the occurrence and duration of downtime events and the number of successful vehicle cycles (trips).

Whenever the interval between consecutive vehicle departures exceeds the scheduled value by more than one minute, a downtime event shall be charged (except for exclusions).

Line downtime shall be recorded and accumulated. Degraded Mode downtime shall be similarly recorded and accumulated whenever a downtime event causes an inability to operate a line in the Degraded Mode.

Vehicle and Wayside Availability

Sufficient vehicles shall be available to provide the scheduled service with specified spares during scheduled operating hours. If lack of sufficient vehicles permits only a fraction of the scheduled service on a line, successful vehicle trips, and hence schedule adherence, will be degraded.

Evaluation of Potential System Failures

To assure that the Jacksonville ASE System provides a safe environment for passengers, it is necessary that potential system failures are identified and that the system is designed to properly handle the resulting situations.

. Potential System Interruptions

The operational requirements for the JASE include provisions for system operation in a Degraded Mode in those periods when Normal Mode Operation is not possible due to system failures. In addition, the Degraded Mode is available for use when emergencies not attributed to system failures occur. Generally, the Degraded Mode Operation procedures do not differentiate between system failures and emergencies not attributed to system failures.

. Mitigation of System Interruptions

All of these service interruptions will necessitate timely, effective reactions from the Central Control personnel and the Maintenance support personnel. The system contractor must develop carefully thought-out procedures to effectively mitigate these adverse situations.

The Technical Provisions of the JASE System's "Procurement Document" will include specific requirements for Degraded System Operation. Both Abnormal (Override) Mode and Failure Mode operational requirements will be included outlining the procedures for handling the various degraded conditions.

Reference

For more detailed information on the system safety and assurance provisions, refer to the technical report, prepared under the preliminary engineering phase, entitled System Safety, Assurance, and Security Plan, December 1981, written by Lea, Elliott, McGean & Company and available through the Jacksonville Transportation Authority.

JASE SECURITY PROGRAM

The principal objective of the JASE System security program is to assure that all persons within the transit system will be safeguarded at all times. This includes passengers, system employees, and even unauthorized persons such as trespassers. Security protection must be provided on-board the vehicles, in the stations, along the guideway, in the parking lots, and in the maintenance facilities.

Security Committee

To achieve this goal, a Security Committee will be formed at the outset to influence the design of the system and its facilities with an emphasis on user and employee security. The Committee will also be concerned with security at construction sites and of material storage during the construction phase of the work.

Coordination by the Committee will involve monitoring the design and determining policy in the following areas:

- 1) Evaluate potential JASE crime and vandalism based on experienced Jacksonville Central Business District (CBD) patterns.
- 2) Develop JASE user security philosophy, guidelines, and practices.
- 3) Influence JASE System design from a security standpoint.
- 4) Determine procedures for surveillance and communication within the JASE System.
- 5) Establish interfaces with law enforcement agencies and define functions and responsibilities for law enforcement agencies relative to the JASE System.
- 6) Organize a public relations program to promote a positive attitude toward the JASE.
- 7) Promote a positive attitude toward the JASE among media.
- 8) Assure that the contractor properly coordinates security at construction sites.
- 9) Develop a training program for Central Control staff to prepare them for safely and expeditiously handling security-related situations they may encounter in the best interests of the system users.
- 10) Periodically review security problems that may be encountered and, when resolved, include corrective measures in operating procedures and/or design features (e.g., bomb threats, hostage situations, or terrorism, etc.).

. Organization

The Security Committee will be comprised of representatives from JTA, the City of Jacksonville, CAC, the contractor, and the Jacksonville Police/Fire Departments. The JTA shall assign an individual who will serve as chairman of the Security Committee and have total responsibility for system security. Security Committee activity will continue after the system is in revenue service. Contractor involvement will terminate upon final acceptance.

. Security Program Policies

The following guidance is presented to aid the Security Committee in achieving its goals:

- 1) The JASE System, including stations, guideway, and maintenance and storage facility shall be designed and constructed to assure a high perception, as well as a real level, of user, employee, and fixed-facility security.
- 2) This security shall be accomplished with a minimum of manpower by utilizing automatic electronic surveillance and communication means.
- 3) JASE surveillance shall be performed solely from JASE Central Control by JTA employees. Roving JTA system operations and maintenance personnel shall not be vested with any police powers whatsoever.
- 4) First priority for use of the surveillance and communications systems shall be for security functions; second priority shall be to provide personal services for users including giving directions and assisting the elderly and handicapped.

Security Program Requirements

. Jacksonville Transportation Authority

JTA is responsible for forming the Security Committee and monitoring the JASE security program. Responsibilities will include utilizing the security philosophy, guidelines, and practices outlined herein; and monitoring, reviewing, and evaluating facilities and surveillance and communications systems through participation in design reviews to ensure the effective and timely implementation of the Security Committee's program.

. Contractor

The contractor will be responsible for establishing a security program and preparing a program schedule. As part of this program, the contractor will be responsible to JTA for the following:

- 1) Active participation of his organization and that of his subcontractors and professional design consultants in Security Committee meetings and documentation of the minutes thereof. Active participation entails familiarity with transit industry security practices as related to the JASE System to enable effective and practical recommendations and critiques.
- 2) Development and documentation of standard security operating rules and procedures consistent with the Security Committee's guidelines for application when the system goes into revenue service.
- 3) Development and documentation of construction phase procedures consistent with the Security Committee's guidelines.
- 4) Implementation of Security Committee's guidelines in the design of the JASE surveillance and communications systems.
- 5) The preparation of progress and status reports.

. City of Jacksonville Police and Fire Departments

The City of Jacksonville Police and Fire Departments will be active participants in the Security Committee. Their participation will include: (1) inputs regarding the Jacksonville CBD crime and vandalism problems relatable to the JASE Systems equipment, stations, guideway, and maintenance and storage facility; and (2) judgments on planning in design of these facilities to reduce the security risks. The City of Jacksonville Police Department will also provide roving patrol of the JASE System and facilities on a continuing basis as a part of their routine patrol of the city streets and shall respond when summoned by JASE Central Control when the potential for an act of crime or vandalism is detected or such an act has taken place.

. Security Program Schedule

The security program shall be scheduled to coordinate with the overall program schedule. Milestones in the security program shall be proposed by the contractor to coordinate with the overall JASE program.

. Design Review

The contractor and JTA will consider security issues during the system design review and facility design approval processes. These organizations will supply inputs and will review comments, tradeoffs, recommendations, and evidence of security design guideline conformance as an integral part of the design review process.

Security Program Plan

The security program requirements presented herein shall be addressed in the JASE System safety program plan to be prepared by the contractor and submitted within 90 days after Notice to Proceed. Included in the plan shall be an explanation of the coordination between the safety program and the security program.

System Security Criteria

This section discusses some of the special requirements imposed on the JASE System to assure the security of passengers and transit property. A source document for guidance on design and operating implications of the security problem is the "Transit Security Guidelines Manual", prepared by the American Public Transit Association under contract to UMTA. Other recommended sources are: Passenger Safety and Convenience Services in Automated Guideway Transit, Volumes I and II, Security Countermeasures, and Perceived Security. General security procedures and contingency plans to handle bomb threats and hostage or terrorist situations will also be developed.

. Surveillance and Communications

Central Control will be expected to utilize its capability to hold and/or reroute vehicles to assist in the apprehension of individuals suspected of vandalism or other unlawful actions. Vehicles can be rerouted to facilitate rendezvous with security staff and can be held or delayed enroute pending the arrival of security officers. To implement effective apprehension procedures will require coordination between Central Control and Security staff utilizing radio and telephone communications.

The Jacksonville ASE communications system will be tied into the police and fire departments via Central Control and the maintenance shop. Central will have the ability to patch vehicle communications directly to the police or fire department by throwing one switch so these officials can obtain information directly from the source when necessary.

. Fencing of Accessible Right-of-Way and Facilities

The following factors should be included in the system design:

- 1) The system design shall be such that unauthorized persons or vehicles are denied access via overhanging or adjacent structures or roads to the guideway running surface, maintenance area, power distribution stations, or other operating or hazardous areas.
- 2) Any at-grade guideway shall be protected against vandalism by the installation of fencing. Gates shall be provided at strategic

locations for controlled access to the guideway and to allow contingent evacuation of passengers.

- 3) Vehicle storage areas, yards, and maintenance areas shall be protected by a fence to guard against vandalism.

. Station Security

Station security requirements include the following:

- 1) Stations shall be designed to minimize nooks, crannies, or hiding places. Turns or angles at stairwells should be avoided.
- 2) Proper and adequate lighting is a prerequisite for security in stations and maintenance and storage areas.
- 3) All station areas, including entry and exit locations, shall be securable.
- 4) Stations shall be designed to provide for natural surveillance. For example, entrances, exits, and platforms should be located so that they may be seen by as large a number of natural observers as possible (e.g., passersby, shoppers, passengers, etc.).
- 5) Commonality between station layouts shall be employed so that public familiarity with one station can be integrated to familiarity with all stations.
- 6) Exit corridors shall be clearly marked.
- 7) Where possible, station exits shall be designed to provide egress into an area of the neighborhood that is familiar, well lighted, generally perceived as amicable, and which has a great degree of natural surveillance.
- 8) Closed circuit TV shall be connected to Central Control.

. Employee Security Considerations

To prevent theft of tools, employee parking shall be separated from work areas by a fence with access at controlled points and shall also be separated from passenger parking and shipping/receiving areas. Interior design of transit system administrative and maintenance buildings shall be arranged so that employees of one department do not normally have reason for passing through the area of other departments.

. Vehicle Security Considerations

Doors and windows shall provide good visibility out of the front, rear, and both sides of the vehicle.

Doors and windows in the vehicle shall use only safety glazing materials approved for use anywhere in motor vehicles except windshields per ANSI Z26.1-1966 (R1973), "Safety Code for Safety Glazing Materials for Glazing Motor Vehicles Operating on Land Highways".

Windows shall be neutral gray tinted to have approximately 50 percent visible ray light transmission and shall be at least 1/4" (6.4 mm) in thickness. The window units shall have an airtight seal.

In addition, walls and ceilings shall meet, at a minimum, the graffiti resistance rating of 2 as specified in "Transit Security Guidelines Manual", Section 21, with the walls preferably having a rating of 1.

. Command and Control Subsystems

The Central Control room and Command and Control equipment shall be protected from vandalism and unauthorized personnel intrusion by means of security doors, intrusion alarms, and bullet-proof glass.

. Maintenance and Storage Facility

The maintenance and storage facility shall be protected from vandalism, unauthorized entry, and pilferage by limiting the number of accesses to the building and outfitting them with security doors and intrusion alarms. Windows shall be secured as necessary to prevent illegal entry.

. Power Stations

Entrance to enclosures, rooms, etc., containing power distribution services shall be provided with locks and shall be posted with suitable warning signs and secured from public admittance.

. Wayside Facilities

Wayside facilities shall be protected by tamper-resistant covers on switch machines and controls and vandal-resistant electrical connections.

. Power and Communications

Power supply, telephone communications, CCTV, and electronic security lines entering Central Control and each of the stations will be located unobtrusively to discourage vandalism. Cables above ground will be in galvanized rigid conduit.

. Landscaping

Landscaping of facilities shall conform to security requirements by the use of vegetation which will not afford protection to miscreants nor interfere with electronic or visual surveillance of the site.

. Lighting

Minimum levels of illumination recommended for specific areas are given in Table 3-11. Luminaires shall be vandal-resistant, weather-resistant, and integrated with the exposed canopy structure of each station. The illumination system shall be standardized to allow for simplified maintenance and minimize storage of spare parts.

Reference

For more information on system security, refer to the technical report prepared under the preliminary engineering phase and entitled System Safety Assurance and Security Plan, December 1981, by Lea, Elliott, McGean & Company and available through the Jacksonville Transportation Authority.

ENVIRONMENTAL CONSIDERATIONS

IMPACTS OF IMPLEMENTATION

Physical and Facilities

. Traffic Circulation and Parking

Completion of the River Crossing Automated Skyway Express System (ASE) would have a positive impact on traffic circulation in the Downtown area. Patronage estimates¹ reflect a 3% diversion of CBD auto trips to the JASE through park-n-ride facilities at the Florida Junior College (FJC) and St. Johns Place Stations. In addition, regional and regional connector bus routes would not enter the CBD for route transfers, but would interface with the JASE at St. Johns Place and FJC Stations for through and CBD-bound passengers. Patronage distribution from the JASE would be handled by a single shuttle bus route for passengers not served by the JASE. The elimination of approximately fifty (50) bus routes from the CBD should have a noticeable effect on traffic congestion, particularly during peak travel periods.

The visual impact of pier columns and guideways on motorists would not be significant. An on-site inspection of the route did not disclose any areas of major impact, either along the route or at major intersections. There would be partial visibility obstructions for vehicles or pedestrians approaching the intersections tabulated in Table 3-7, all of which are signalized.

Pier columns for the JASE are not located in existing sidewalks and should not interfere with pedestrian traffic. Where columns would encroach on sidewalks and in areas where heavy pedestrian traffic may be expected -- around stations and at major street intersections -- additional sidewalk area would be provided, either back of new curbs separating the columns from adjacent vehicular traffic or under the guideway itself.

During construction approximately 150 curb parking spaces would be lost, 102 of these on Bay and Hogan Streets and the balance on Mary Street south of the St. Johns River. On completion of the JASE, approximately 55 spaces would be regained by indentations in the curb and parallel spaces under the guideway; 35 of these along Bay Street and 20 along Mary Street, for a net loss of 95 spaces. This loss amounts to approximately 5% of all curb spaces in the Downtown area but would be offset by park-n-ride spaces and additional off-street spaces now being planned.

The net effect from operation of the River Crossing ASE should be: increased mobility for both workers and shoppers; near-term reduction in traffic congestion in the CBD; and a long-term reduction in parking needs.

. Utility Relocations

The determination of utility adjustments involved the location of utilities through review of plans obtained from the utility companies. By correlating the manholes with the utility company maps, a set of utility maps was prepared. A preliminary judgment about utilities to be relocated was based upon the proposed location of guideway piers relative to utility locations.

The north side of the St. Johns River contains the heavier concentration of underground utilities and, therefore, the larger number of potential relocations. Underground telephone cables, sanitary sewers, and gas pipelines would be impacted moderately, while water mains, storm sewers, and underground Western Union cables would be impacted only slightly.

On the south side of the St. Johns River water mains, gas pipelines, underground telephone cables, and underground electric cables occur in much lower density and would be only minimally impacted.

If practicable, foundations would be moved or specifically designed to minimize the relocation costs. Prior to final design of the facilities, meetings would be held with the appropriate utility companies to obtain comments and cost estimates. Adjustment to foundation design and locations would be made following receipt of comments from the utility companies. Impacts to utilities would be short-term and confined to the construction phase.

The utility companies that would be affected by construction of the JASE are listed below according to area of responsibility:

- * Jacksonville Electric Authority (electric)
- * Jacksonville Public Works Department (sanitary sewer)
- * Jacksonville Public Works Department (storm sewer)
- * Jacksonville Public Works Department (water main)
- * Peoples Gas Company (natural gas pipelines)
- * Southern Bell Telephone (telephone cables)
- * Western Union (telegraph lines)

Only minor short-term adverse impacts on utilities should result from construction. Long-term impacts would include financing costs for the relocation and the probable deferral of other needed utility construction projects due to the involvement during the relocation.

. Drainage Control

Minor modifications to the drainage system may be required due to the placement of pier foundations. Relocation of existing and placement of new storm water catch basins would be required due to modifications of the at-grade transportation network and to improve existing storm water runoff characteristics. Removal of storm water from elevated structures would be done by down spouts connecting directly to the existing and modified storm sewer network and, therefore, would not contribute to

at-grade street water flow. Operation of the stations, guideways, and CMSA facility would have an insignificant impact on the storm water runoff and the existing drainage system in the project area. Since the project area contains little open ground, the new facilities would not increase the amount of storm water runoff.

. Refuse Collection

The elevated station and guideways, and the narrowing of traffic lanes on Hogan Street, would not reduce maneuverability of refuse collection vehicles and accessibility to some store front collection points.

. Delivery and Loading Zones

The long-term impacts of the River Crossing ASE to deliveries and loading zones would be most pronounced in the Central Business District along Hogan Street. The degree of impact is dependent upon whether Hogan Street will be a 1-way pair of lanes or a 2-lane, 2-way street. Under the 1-way alternative, one lane could be used as a loading zone and the other as a thru-traffic lane. The 2-way alternative would provide for loading zones under the guideway structure.

. Fire Protection and Emergency Service

Adverse impacts to police, fire, and emergency services would be predominantly related to impedance of access in the Central Business District along Hogan Street. As Hogan Street would become a 2-lane roadway with either limited 1-way or 2-way traffic, traffic congestion could greatly increase the response time of emergency vehicles. This adverse impact could be reduced by strong enforcement of no parking and no unattended vehicle ordinances along Hogan Street. If the 2-way traffic alternative is selected, the enforcement of these ordinances would be especially effective. The width, location, and elevation of the guideway and stations could present a serious handicap to firefighting operations along Hogan Street. These adverse impacts include preventing positioning firefighting vehicles in the optimum location for combating a particular structure fire and restricting placement of ladders for both firefighting and building excavation.

. Accessibility of Facilities, Services, and Jobs

The River Crossing ASE would connect the major employment census tracts Downtown and would be in a direct 3-minute walk of a 1995 projected employment population of about 60,000. In addition, the shuttle bus services between the JASE and the surrounding activity and fringe parking of Downtown would provide access to the employment in Census Tracts Nos. 8, 9, 10, 18, and 19 for a total service area projected employment population of 89,900.

The exclusive right-of-way for transit on the JASE System would allow headways of no more than 2 minutes with total travel time from the Florida Junior College Station to the St. Johns Place Station of 7 minutes. The eight vehicles on the first stage system would be able to move over 5,000 passenger-miles per hour during the rush hour peak. Anticipated 1985 ridership, calculated using sophisticated mathematical models, would be 26,818 persons daily. The JASE would attract 5,261 auto diversions and 11,537 bus diversions daily. There would be 10,020 circulation trips daily.

Design Aesthetics

The impact of an elevated fixed-guideway system, such as the JASE, on the environmental design aesthetics of Downtown Jacksonville would depend on the design and integration of the JASE into the existing visual environment. During the planning for the JASE, commitments to design standards rather than final design drawings have been made. Therefore, an evaluation of the environmental design aesthetics has been made based more on the "worst case" physical characteristics of the fixed facilities rather than abstract issues of form and integration.

In order to evaluate the impacts generated by the JASE facilities, the alignment of the River Crossing ASE has been divided into six segments as shown in Figure 5-1. Each of these segments was considered with and without the JASE facilities. Existing visual elements of the segments were identified, including significant long-range views, typically channel vistas, and short-range views, typically historically or architecturally significant buildings. The visual impacts on environmental design aesthetics introduced by the JASE facilities were then determined through an evaluation of anticipated appearance, light, shadow, and the views which would be eliminated or added.

The setting with the JASE facilities is evaluated from the perspective of the pedestrian and the JASE patron. Typically, this is represented by a visual field along a roadway corridor and lateral to it. The lateral visual field would be up to a half-block deep on each side of the alignment. Where the area adjacent to the alignment would open a lateral visual field to the limit of sight for the JASE patron, this visual impact is evaluated.

Each of the evaluation criteria applied to the six JASE segments has resulted in judgments as to the significance of adverse or beneficial impact. These judgments are noted in the following matrix of impact, Table 5-1.

Perspectives showing the visual impact of the JASE at various locations are shown in Figures 5-2 through 5-8. Generally, the beneficial impacts outweighed the adverse impacts on all of the segments except one.

ENVIRONMENTAL DESIGN AESTHETICS ALIGNMENT SEGMENTS 1 - 7

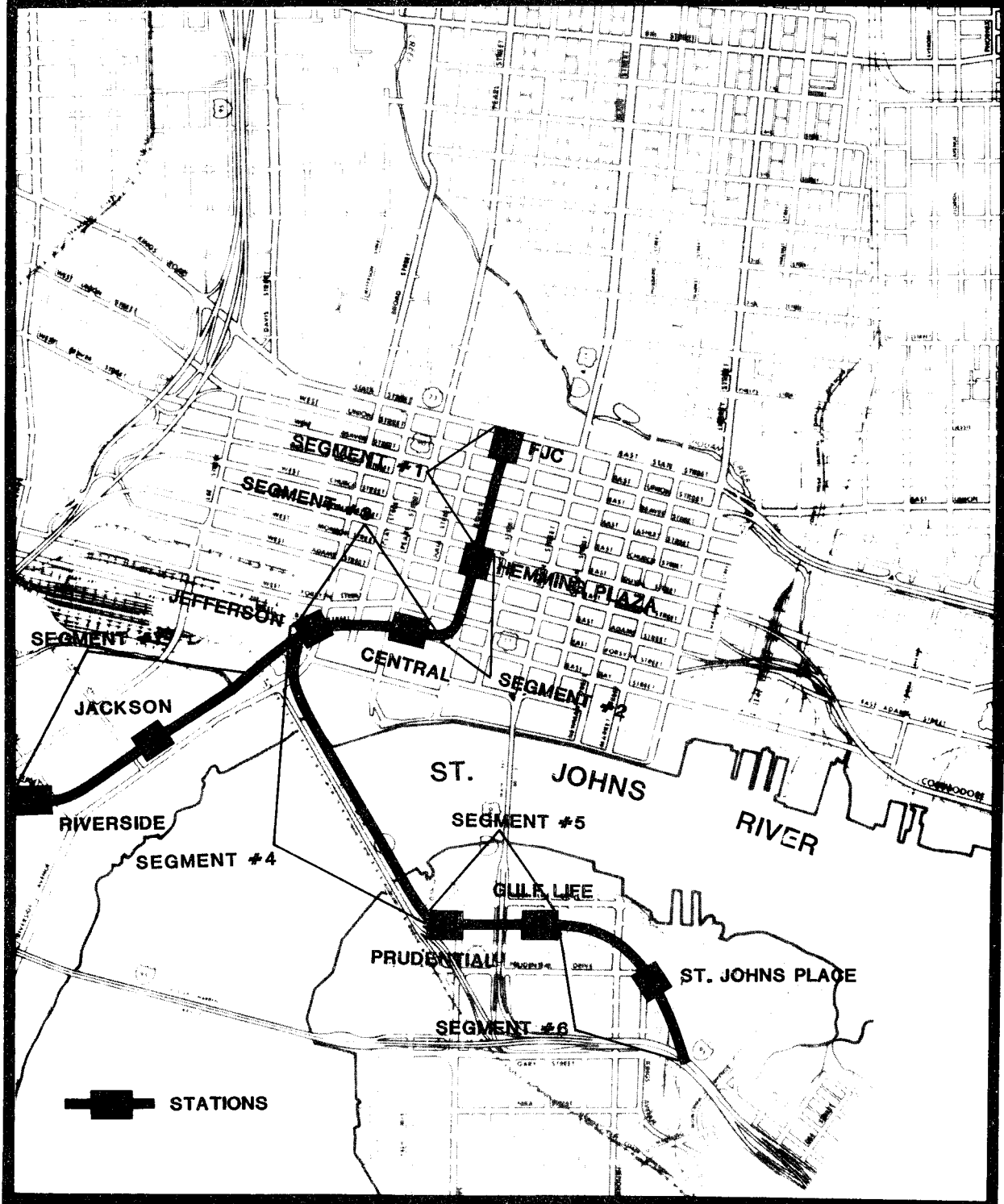

FIGURE 5-1

DESIGN AESTHETICS SEGMENTS



FIGURE 5-2

PERSPECTIVE OF FJC STATION

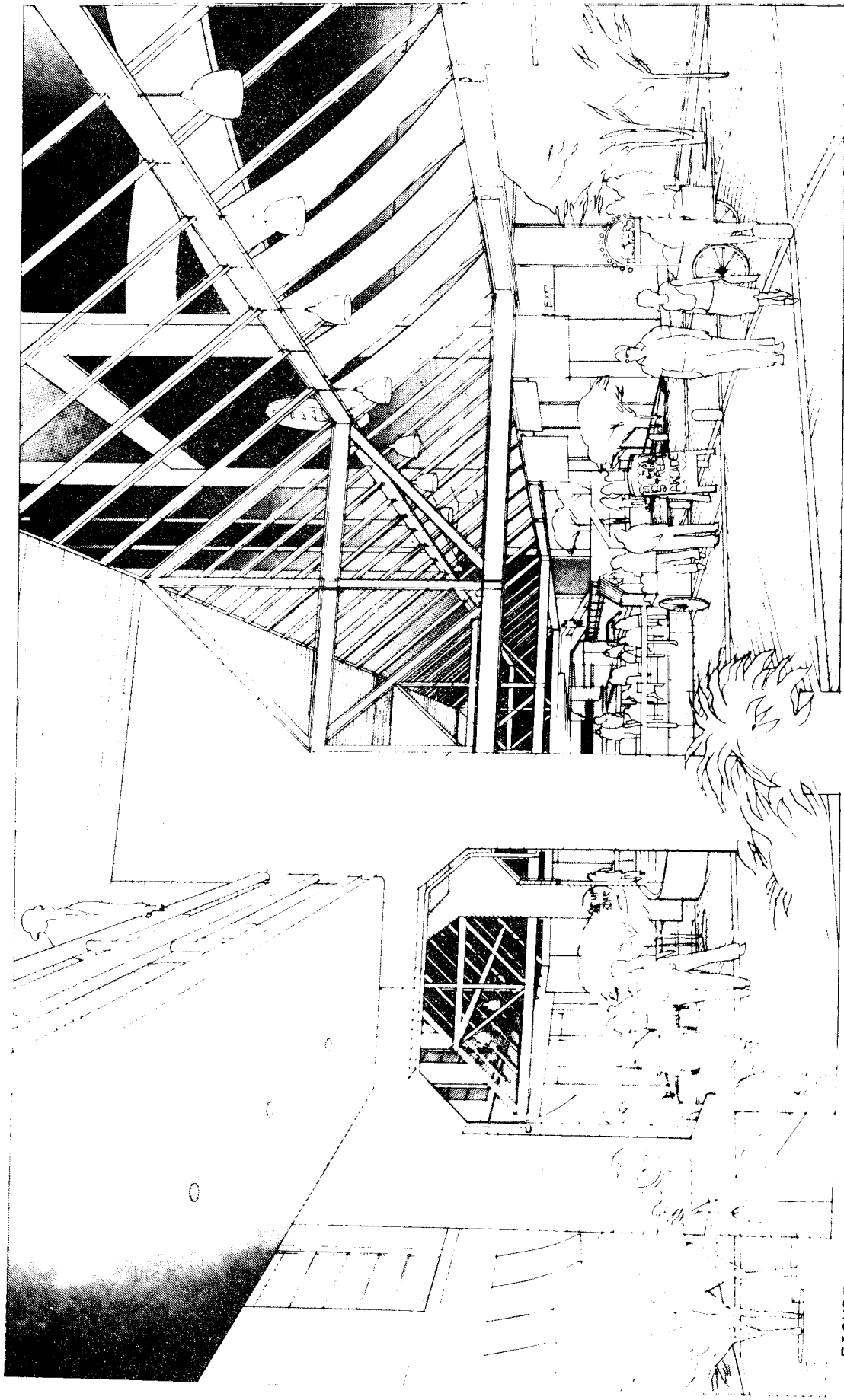

DEVELOPMENT UNDER HOGAN STREET GUIDEWAY

FIGURE 5-3

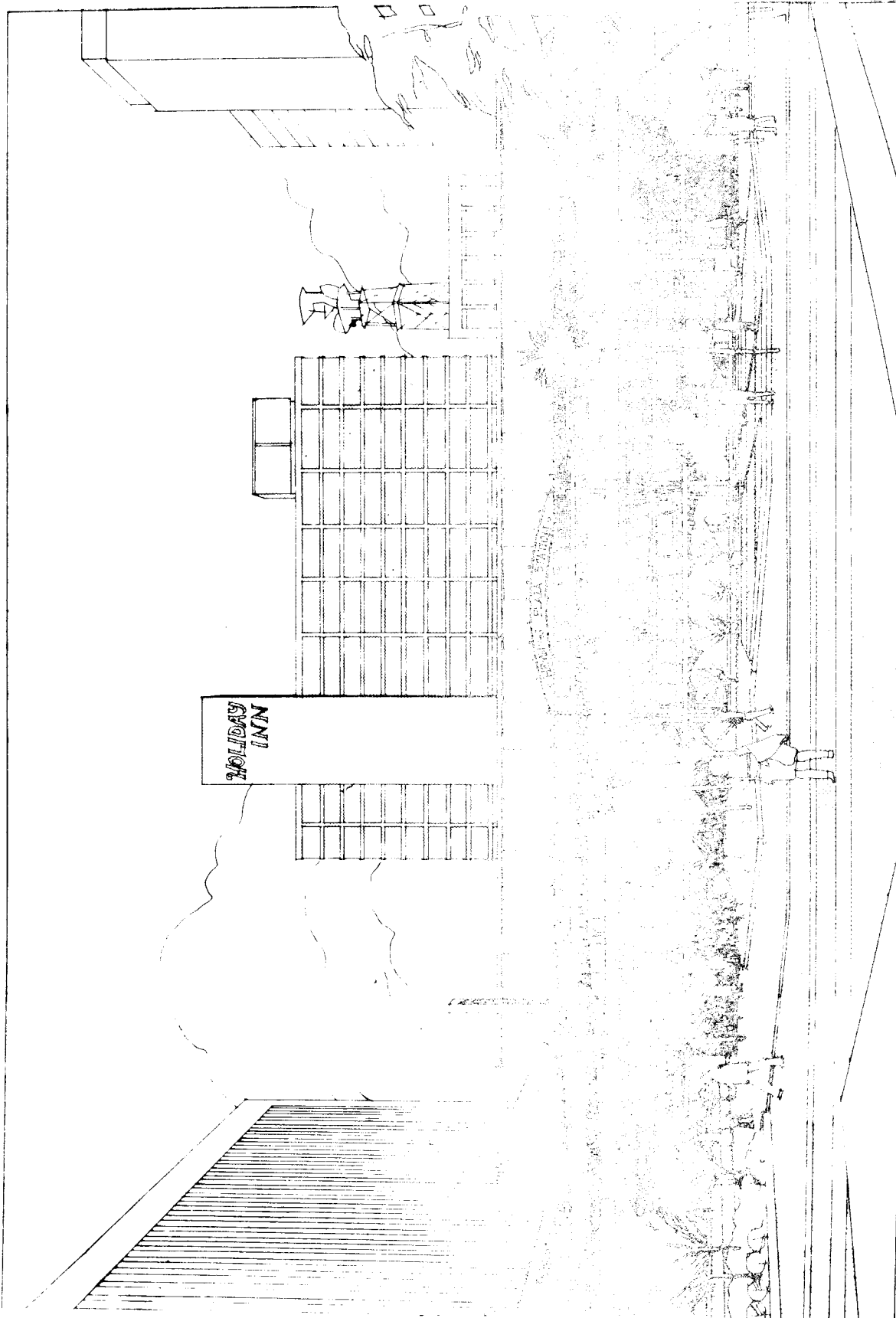

PERSPECTIVE OF HEMMING PLAZA STATION

FIGURE 5-4

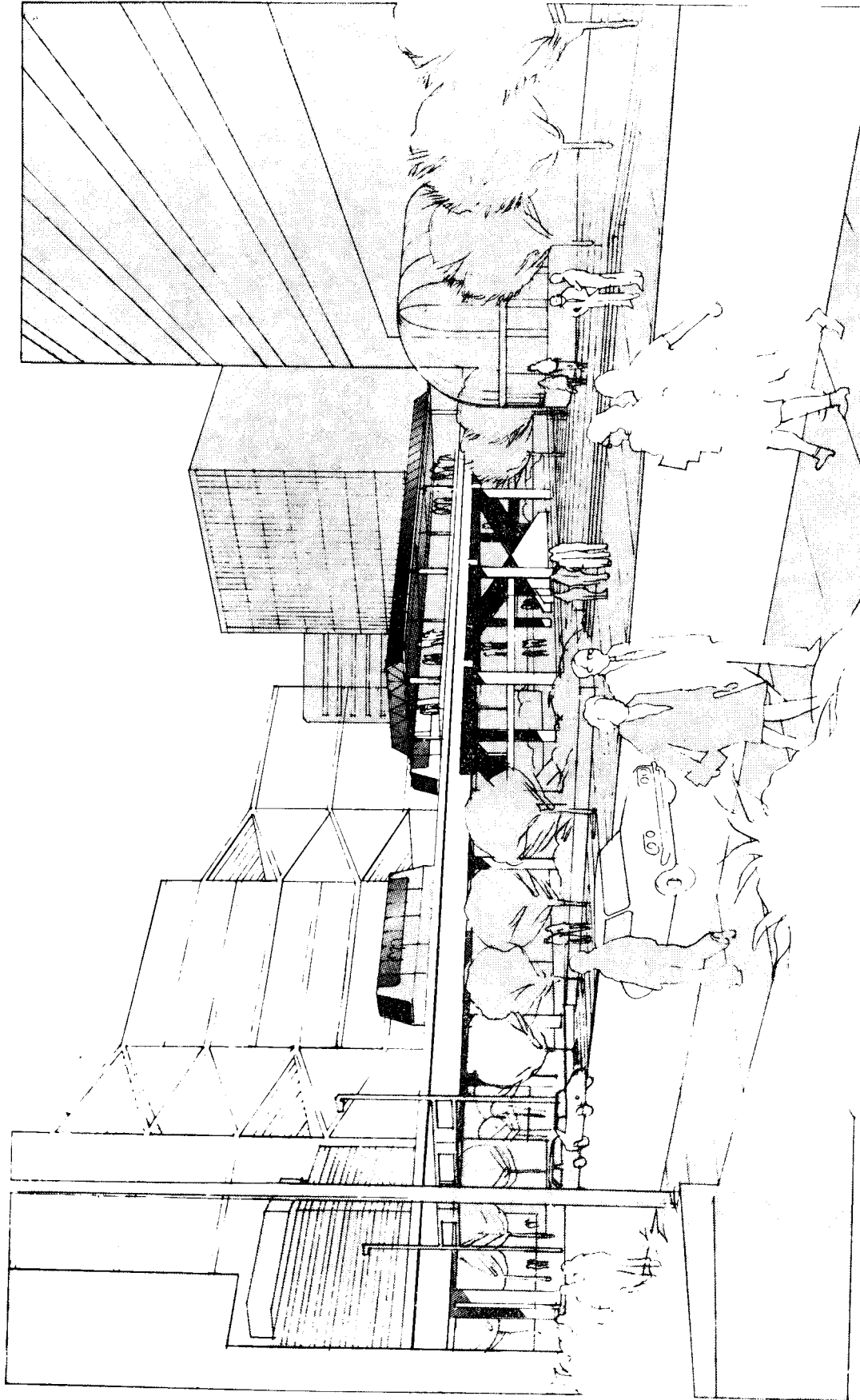

PERSPECTIVE OF CENTRAL STATION

FIGURE 5-5

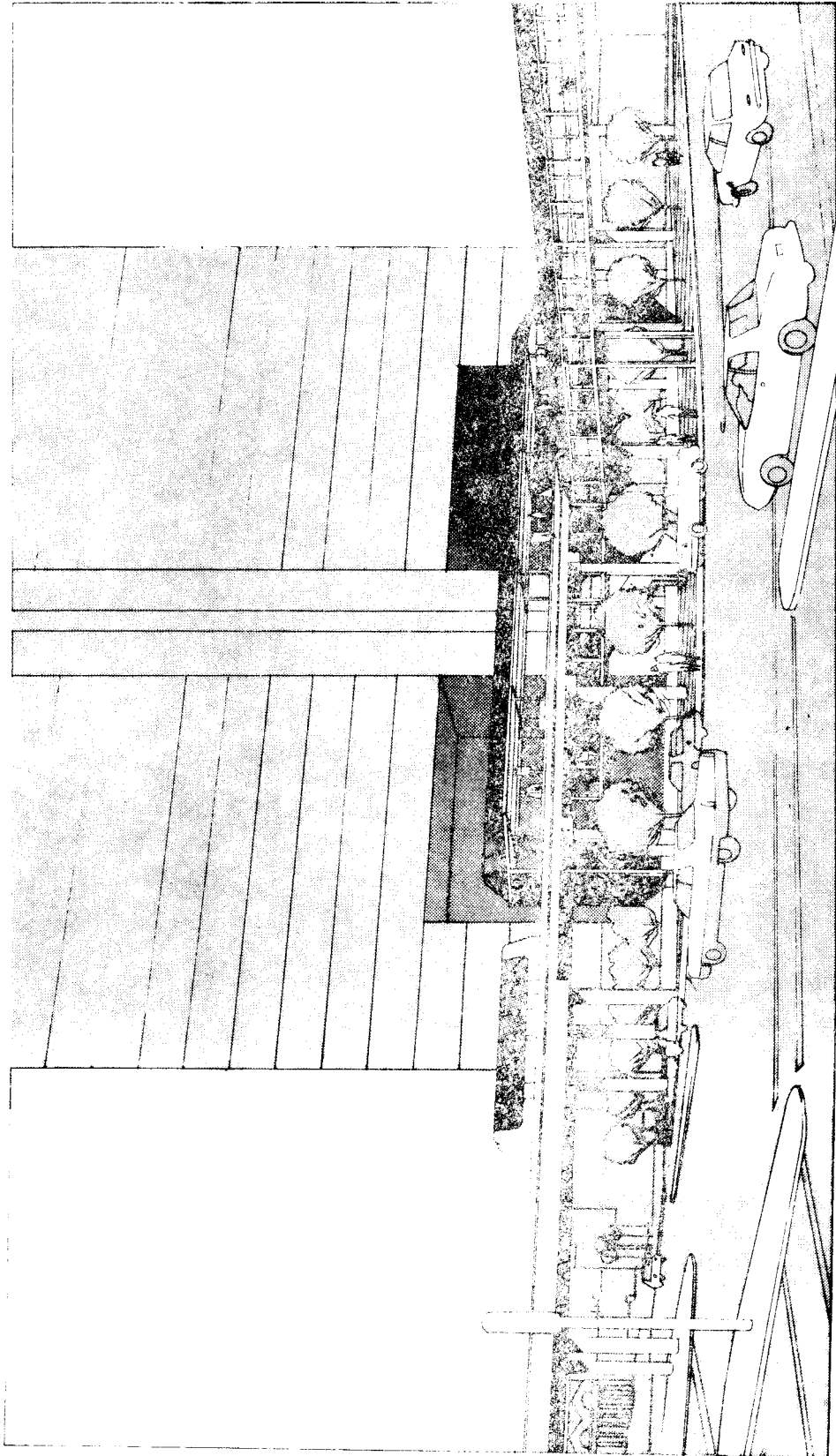

PERSPECTIVE OF JEFFERSON STATION

FIGURE 5-6

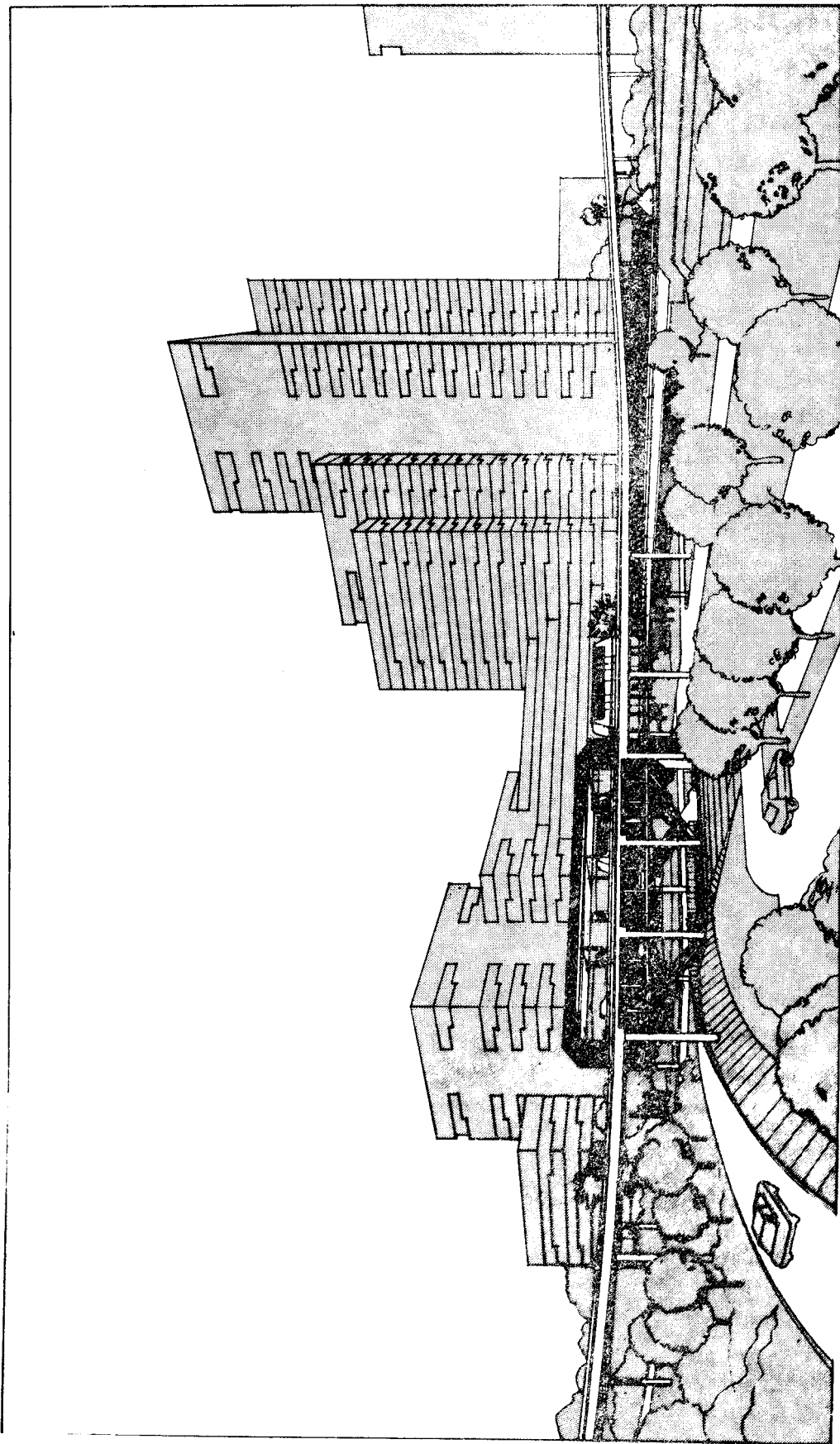

PERSPECTIVE OF PRUDENTIAL STATION

FIGURE 5-7

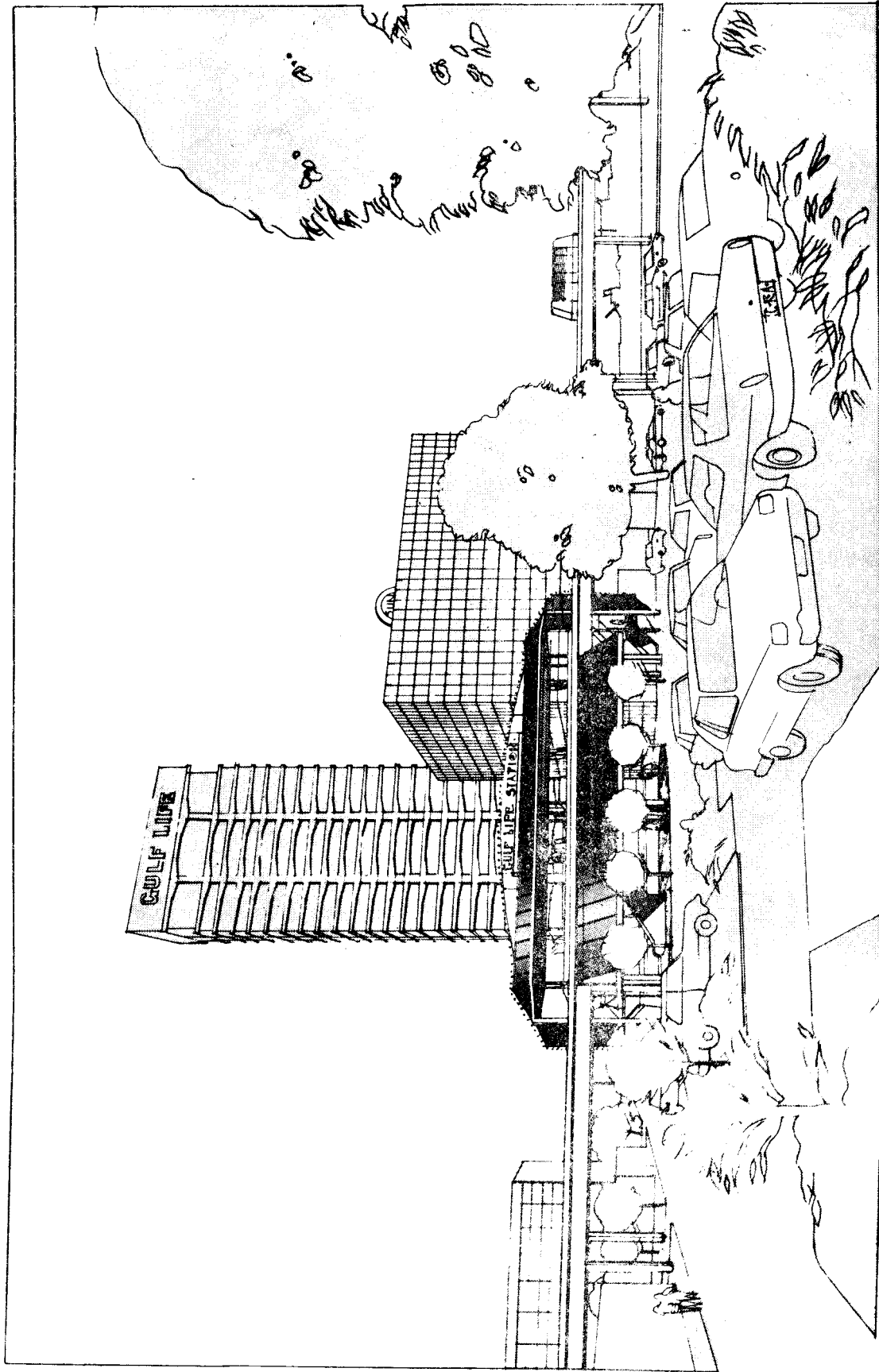

PERSPECTIVE OF GULF LIFE STATION

FIGURE 5-8

TABLE 5-1
SUMMARY OF VISUAL IMPACTS
JACKSONVILLE AUTOMATED SKYWAY EXPRESS ALTERNATIVE

<u>VISUAL IMPACT ISSUES</u>	<u>JASE ALIGNMENT</u>					
	<u>#1</u>	<u>#2</u>	<u>#3</u>	<u>#4</u>	<u>#5</u>	<u>#6</u>
Appearance - Scale Compatibility	-	+	0	+	0	+
Appearance - Cohesion	-	0	+	+	0	0
Long-Range Views Eliminated	-	-	-	0	0	0
Short-Range Views Eliminated	0	-	0	0	0	-
Views from JASE	+	+	+	+	+	+
Light	0	+	0	0	0	0
Shadow	0	+	0	0	0	0

LEGEND:

- + : Significant Beneficial Impact
- : Significant Adverse Impact
- 0 : No Significant Impact

Socioeconomic

. Displacement of People and Businesses

The majority of the JASE alignment would be located within existing street rights-of-way and public property, thus minimizing disruption to the community. Minimum private property acquisition was a design goal. Only minor additional property would be acquired along alignment segments because of space limitations. Property acquisition and relocation is displayed on Figure 5-9 and described in Table 5-2.

TABLE 5-2
PROPOSED ACQUISITIONS AND RELOCATIONS
RIVER CROSSING ASE

<u>TYPE</u>	<u>STATUS</u>	<u>ESTIMATED RESIDENTS OR FULL-TIME EMPLOYEES</u>
Business - Attorney	Leased	4
Business - Office Equipment	Leased	4
Business - Trophies	Leased	3
Business - Auto Repair	Leased	6
Business - Restaurant	Leased	3

ATA ALTERNATIVE RELOCATION AND PROPERTY ACQUISITION

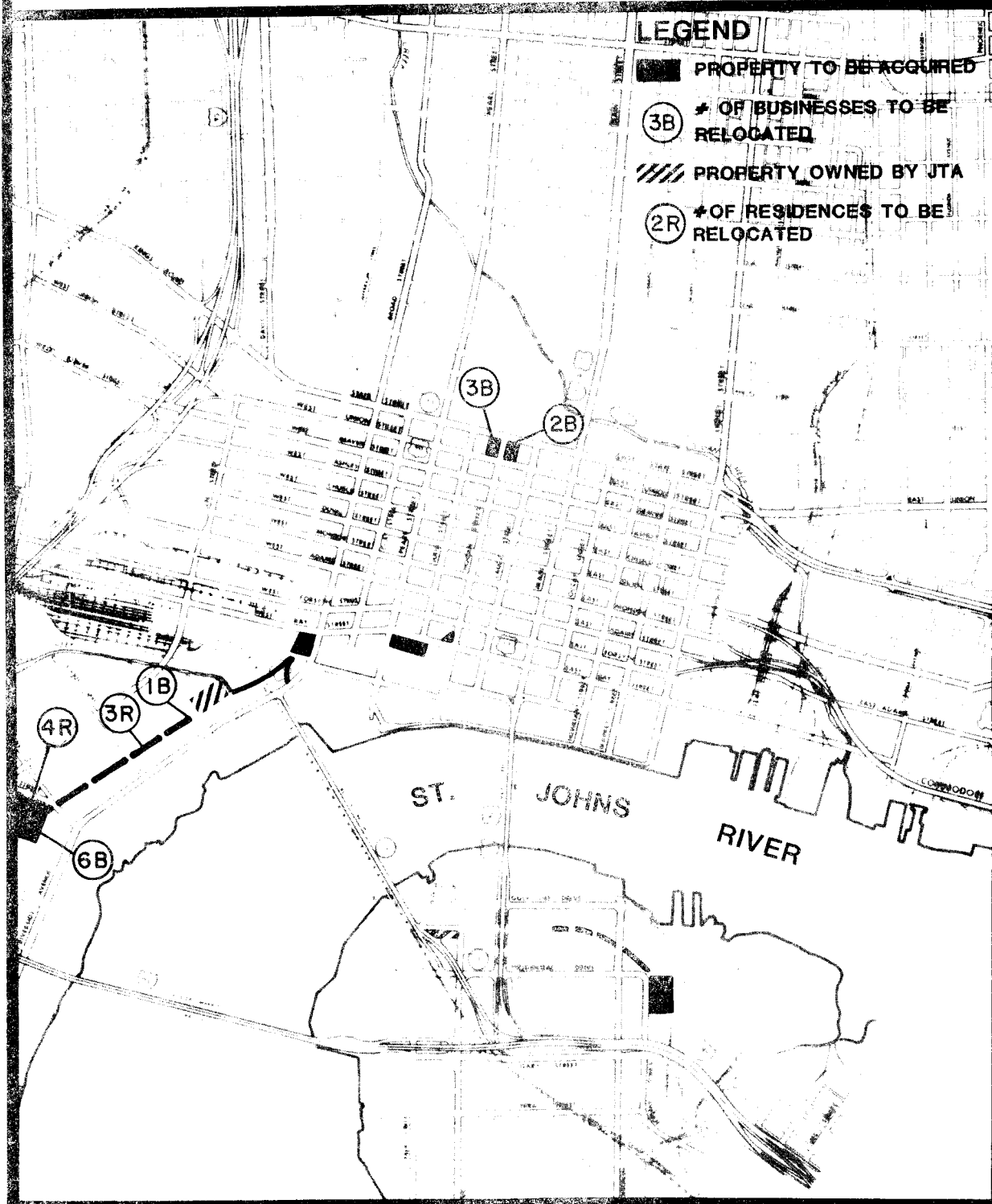

FIGURE 5-9

RELOCATION AND PROPERTY ACQUISITION

The first of these segments runs north-south between State Street and Union Street, parallel to and west of the right-of-way of Hogan Street. The construction of bus, auto, and taxi drop-off facilities at the FJC intermodal station would require the acquisition of property on both sides of the streets. On the west side, it would be necessary to acquire two 1-story commercial structures which would require relocation. Along this segment, the alignment would displace approximately five business units contained in single-story structures. The businesses in these structures are not believed to have any special needs dependent on these locations, nor are they highway-oriented. Therefore, no significant adverse impact on these businesses or their employees is anticipated.

The second segment runs east-west between Julia Street and Pearl Street, parallel to and south of the right-of-way of Bay Street. The construction of the Central Station at this location would require the acquisition of the land 40 feet in from the street right-of-way on the north end of the intervening block. Along this segment, the station facilities would displace surface parking spaces and a sign identifying the Sears Roebuck property. Sears left this site in Spring 1981. No residential or business displacements would result and no significant adverse impact on future development potentials would be anticipated. The property acquisition would be needed to maintain three lanes of traffic on Bay Street, a major one-way corridor, at Central Station.

The third segment would run north-south between Bay Street and the northside approach to the Acosta Bridge, parallel to and west of the right-of-way of Broad Street and Riverside Avenue. The construction of the Jefferson Street Station would require the acquisition of all or portions of lots 39H and 40H of the Old Creek Bed block of the Z. Hogan Grant. Along this segment, the station and guideway facilities would displace surface parking spaces and billboards. No residential or business displacements would result and no significant adverse impact on future development potentials would be anticipated. The property acquisition would be required to make the turn on Broad Street and for the connection with the CMSA and the Acosta Bridge.

The fourth segment would run west to east between Flagler Avenue and Hendricks Avenue, parallel to and south of Mary Street. Acquisition of private property between Flagler Street and Kipp Avenue (formerly Mary Street right-of-way) would be required for the construction of the Gulf Life Station. East of the station, the guideway makes a curve south away from Mary Street. This would require the guideway to cross private property. Land lots in the Central Business District addition to South Jacksonville would be acquired, including all or portions of Lots 1, 13, 14, 15, and 16 of Block 10; Lots 1 through 8 of Block 9; Lots 4 and 5 of Block 8; and Lots 4 through 6 of P&T Realty Company's subdivision. Along this segment, the station and guideway would displace surface parking spaces and cleared vacant land. No residential or business displacements would result and no significant adverse impact on future development potentials is anticipated.

The fifth segment would run northwest to southeast between Hendricks Avenue and the area south of Prudential Drive and east of Kings Avenue.

The guideway would curve across the parking lots of the Sheraton Hotel property at St. Johns Place, cross over Prudential Avenue, and enter the St. Johns Place Station which stands on vacant land behind low-rise buildings which front on Kings Avenue south of Prudential Drive. All or portions of Lots 7, 8, 9, 16, and 17 of Block 1, Lots 9 through 12 of Block 2, and Lot 1 of Block 3 of the Reeds subdivision and portions of Lot 80076-0000 of the Hendricks Grant would be acquired for JASE facilities. No residential or business units would be displaced and the construction of the guideway and station would not produce any adverse impacts on future development potentials.

The CMSA would be located entirely on property owned by the JTA which is bound by Oak, Leila, and May Streets and McCoy Boulevard. Both McCoy Boulevard and a portion of May Street are closed to traffic. The JTA previously used this property for vehicle storage. These facilities are not currently in use. There would be no displacements in this segment.

Requirements pertaining to property acquisition and relocations for projects funded by the Urban Mass Transportation Administration are described in UMTA Circular C4530.1.²

General guidelines of the Jacksonville Transportation Authority pertaining to land acquisition and relocation are included in their "Right-of-Way and Relocation Manual".³

. Station Effects on Neighborhoods

The station area impacts in the Downtown Jacksonville environment which would be of social concern relate to the changes in pedestrian, vehicular, and parking activity brought about by the location and layout of the station and its functional design. Development or redevelopment of the land around the station induced by the JASE System would also be a factor in identification of impacts. Because intermodal stations of the JASE System would be major transfer points for regional bus and auto commuters and pedestrians, the intensity of activity at these stations would be great during AM and PM rush hour peaks. Urban stations would be a focus of pedestrian activity throughout the day. The following discussion identifies the impacts anticipated at each station area, typically an area about one city block or within 400 feet of each station.

The Florida Junior College Station area, under the influence of the JASE System, would experience an increase in the demand for parking and bus traffic. No major development is expected to be induced by the JASE System. However, the continuing expansion of Florida Junior College's campus would benefit from the improved circulation with the Downtown and Southside provided by the JASE. The JASE System would include street and traffic control improvements. A pedestrian bridge could be built between the station and campus. The bridge would make it possible for students and other pedestrians to cross State Street with less hindrance to traffic and greater safety.

The Hemming Plaza Station area would have several beneficial changes resulting from the JASE System. Bus traffic around the plaza, especially at the Monroe Street transfer site, would be terminated. Parking would be limited in the station area. Pedestrian movements around the station area would be greater than would have occurred without the JASE. This would be a benefit to the local commercial district around the station. Turning movements onto Hogan Street at cross streets near the station would be slowed significantly by pedestrian activity on the street and the narrowing of Hogan Street to two lanes.

The Central Station area is expected to be one of the most active urban stations. Bay Street would be maintained at three lanes at the location of the station and no traffic congestion would occur. JTA bus traffic would be eliminated in this area because of the presence of the JASE System. Future development of the Quad-block by the Charter Corporation could incorporate the JASE System into its design and site layout, benefiting from the improved circulation provided pedestrians by the JASE. The anticipated increase in pedestrian activity at this station area would require traffic improvements to safely separate vehicular and pedestrian traffic.

The Jefferson Street Station area would experience an increase in bus and auto traffic resulting from the commuters using the intermodal station. The station area would undergo development and redevelopment and the station would support the development activity. The area is already used for parking by commuters to local offices. The system could reduce the level of parking demand by diverting the local commuters to remote parking stations such as St. Johns Place and Florida Junior College. Improvements of pedestrian crossings on adjacent streets would be needed to safely move JASE patrons to local offices.

The Prudential Station area is the site of current public and private development plans. The immediate station area would change to office use under the influence of the expansion of the Prudential Life Insurance Company. The urban station at this location would improve circulation and would reduce the parking concentration and traffic congestion that would otherwise occur around this new development.

The Gulf Life Station area would be in primarily vacant land planned for development by the Downtown Development Authority as residential and office buildings. The station would support and enhance development of this area by providing residents and workers with convenient public transportation services. It would help to reduce traffic congestion brought about by future development. However, parking could become concentrated here. The area already provides parking for office workers and the JASE would divert workers commuting from the Northside. The Gulf Life area would offer numerous opportunities for parking by regional commuters seeking to use the JASE System and avoid traffic congestion and parking demand problems. Future development of this area must consider means to improve pedestrian movement around the station and limit street parking to local residents and workers.

The St. Johns Place Station area is surrounded by vacant land and low

use development. Current development activity in the area is in hotel and office buildings. The JASE System would support the development and redevelopment in this area. The intermodal station would attract auto and bus commuters with destinations in the Northside and improve the capability of local workers and hotel guests. It would also be a focus for increasing traffic congestion and regional parking demand.

. Effects on Special User Groups

The JASE System will provide access to most major activity centers and the largest employment census tracts for the handicapped at a significant decrease in travel time. It would also open up a greater area of Downtown in which the handicapped would be able to attain mobility and more complete access to facilities by eliminating many physical barriers. More information on this subject is contained in the Technical Memorandum on the Elderly and Handicapped Plan.⁴

. Employment, Income, and Business Activity

In conjunction with the planning of the automated skyway express alternative for Jacksonville, forecasts for future development within the study area were prepared by the economic consultant on the design team.^{5,6} These forecasts assert, among other things, that:

- 1) the JASE System would have a substantial effect on the amount of development in the Downtown area of Jacksonville;
- 2) it would have a significant effect on the location and, therefore, the density of such development;
- 3) the automated transit alternative would attract new development to the Downtown area which otherwise might not be there; and
- 4) that development which the JASE does not create, it would serve and stimulate to a marked degree.

The studies indicated that the majority of benefits induced directly by the JASE alternative would be received by those businesses within a 3-minute walk (1 to 2 blocks) of stations. The benefits to business activity were expected to be growth of retail sales and increased value of property. The growth induced in retail sales and property value by the JASE would result from increased shopping activity along the alignment. This increase in shopping would be from:⁵

- * additional Downtown employees from JASE-induced development;
- * increased volume of Downtown lodging guests induced by JASE accessibility; and
- * a modest increase in per capita expenditures of Downtown employees (from \$1,065 per year to \$1,155 per year in 1978 dollars) resulting from increased accessibility afforded by the JASE.

This increase in business activity, employment, and income induced by the JASE is summarized in Table 5-3 for the first and tenth year of operation.

TABLE 5-3
 EMPLOYMENT, INCOME, AND BUSINESS ACTIVITY
 INDUCED BY THE AUTOMATED SKYWAY EXPRESS ALTERNATIVE
 IN DOWNTOWN JACKSONVILLE
 RIVER CROSSING ASE

YEAR	EMPLOYMENT	ANNUAL INCOME ¹	BUSINESS ACTIVITY			
			NEW DEVELOPMENT (sq. ft.)			ANNUAL
			OFFICE	RETAIL	HOTEL ²	RETAIL SALES ³
1985	1,100	\$10,458,000	160,000	80,000	30,000	\$ 7,000,000
1995	5,560	\$52,859,000	995,000	286,000	75,000	\$32,175,000

- 1 1977 dollars; based on a per capita income of \$9,507 (assumes 1.3 employed persons per household and \$11,774 median household income in Jacksonville/Duval County in 1977).
- 2 Number of rooms multiplied by an average of 300 square feet per room (includes hallways).
- 3 1981 dollars.

Total growth of commercial space in Downtown Jacksonville between 1981 and 1995 was projected to be about 7.5 million square feet. In addition, 1.356 million square feet are expected to be induced by development of the River Crossing ASE. This induced development is expected to have a construction value of about \$102 million (in 1981 dollars), or about 1.6 times capital cost of the River Crossing ASE.

Employment patterns follow development closely. By 1995, with the JASE in place, employees in the study area are projected to be 103,000. Without the JASE System, employment is projected to increase to only 96,300 workers.⁷ Only long-term primary employment that is directly attributable to the Downtown area is considered here. Because the JASE is expected to generate development of office, retail, and hotel space, an increase in employment for these businesses is anticipated. Retail employment and hotel employment increases are expected to be the result of increased spending from areas outside the region. Therefore, some of these jobs would be new jobs for the region. By 1995, the JASE is expected to add 4,890 office jobs, 570 retail jobs, and 100 hotel jobs.

The jobs in Downtown Jacksonville induced by the JASE would also increase the income base of Downtown. Using the 1977 median household income for Jacksonville of \$11,774, the increase in annual income for employees Downtown can be calculated. Assuming that each household has

1.3 persons with income, the annual income induced by the JASE is about \$10.5 million (1977 dollars) in the first year of operation of the system. This would increase to almost \$53 million (1977 dollars) by the tenth year of system operation, or almost 0.9 times the cost of the River Crossing ASE.

The induced employment and income growth in the Downtown area is important because residents of the Downtown area are currently among the lowest income group in the County.⁸ The office, retail, and hotel jobs induced by the JASE, whether new to the region or captured from areas outside of the Downtown area, would expand employment opportunities for the residents of the Downtown area.

The retail sales stimulated by the JASE System are expected to be substantial, yet modest relative to the anticipated sales for all of Downtown. Retail sales in the Downtown area are expected to rise from \$238 million in 1978 to about \$300 million in 1985. The JASE project is expected to account for \$7 million of this increase. By 1995, the JASE is expected to stimulate annual sales revenue by \$32 million. This growth in sales is based on the continuation of past trends which have seen the retail sales per square foot of retail space grow about 2.5% per year.⁵

. Residential Activity

The River Crossing ASE would serve a planned residential development on the Southside through its Gulf Life Station. Present DDA plans for this area indicates that 3,020 dwelling units would be built by 1995 in the immediate station service area. About 1,520 of these units would be at high density and about 1,560 at moderate densities, or a construction value of approximately \$100,000,000 in 1982 dollars.

. Economic Benefits

The economic benefits accruing to Downtown Jacksonville from construction of the JASE System occur in four major areas: additional employee income resulting from induced employment; additional retail sales stimulated by increased Downtown mobility; additional commercial building activity drawn to the Downtown area by improved accessibility; and additional residential activity as Downtown becomes a more desirable place to live.

. Effects on Property and Other Taxes

An operating ASE System in Jacksonville would produce two effects on tax revenues. One effect would be to slightly reduce the amount of property on the tax rolls as the result of property acquisition for the exclusive use of the public transit facilities. The other effect would be to greatly increase the assessed value of property near the JASE facilities as a result of private investment in or rehabilitation of the property.

The JASE System would utilize existing street right-of-way for the majority of the land area committed to its use. Some taxable private property would be acquired for JASE use. This would include land for the FJC and the St. Johns Place Stations, portions of Central Station and the Jefferson Station, and portions of the elevated guideway between the Gulf Life and St. Johns Place Stations. The total amount of private land acquired is about three acres, or about \$1,215,000 in value.

Economic studies of Downtown Jacksonville have been conducted as part of the feasibility study of the JASE System. These studies have been updated to identify the potential for new development Downtown induced directly by the first stage segment of the JASE System. The economic development programs of the City have been projected to generate development and rehabilitation of private property Downtown. By 1995, this development is estimated to represent a construction cost (in 1980 dollars) of about \$950 million. This revitalization of Downtown would produce 10.7 million square feet of modern office space, 4.3 million square feet of modern retail space, and 2,350 modern hotel rooms. The JASE System is expected to directly induce the development of an additional 1.3 million square feet of office space, 300,000 square feet of retail space, and 250 new hotel rooms.⁷ This induced development is expected to have a construction value of about \$102 million (in 1981 dollars).

For this new Downtown development, between 1978 and 1995, it can be assumed that the office, retail, and hotel space would be able to generate similar levels of annual operating income per square foot. Therefore, the increase in the total space of a specific type which is induced by the JASE System would be directly proportional to the JASE-induced increase in tax revenue (derived according to the income method of assessed valuation). By 1995, the JASE System would have increased tax revenues from Downtown office property by 12%, from retail property by 7%, and from hotel property by 11%. In addition, 11% induced growth in hotel rooms should generate an increase in the local option (hotel occupancy) tax.

In addition to these anticipated increases in the general tax revenues of the consolidated government of Jacksonville/Duval County and the Duval County School Board, the City and the Jacksonville Transportation Authority seek to identify a means of capturing that value added to business activity adjacent to the JASE System, especially stations, as an indirect result of the increased clientele derived from JASE patrons. The purpose of these special tax measures would be to dedicate the tax revenue earned to defer the cost of operating the system and to retire at a faster rate the local portion of the construction cost debt paid from the general tax revenues of the City.

. Public Safety

The safety benefits to motorists and pedestrians resulting from the operation of an elevated, exclusive transit system, are obvious. Diversion of motorists to the system and the practical elimination of surface

transit vehicles would reduce congestion and conflict on heavily-traveled streets for remaining auto users and would give patrons a swifter, surer, and less stressful means of transportation. Mechanical and design safety and security considerations for operation of the JASE System have been defined in the JASE System Safety and Assurance Plan.⁹

The design of the JASE structure and supports would discourage loitering in the vicinity of stations. Stairways, ramps, and escalators would not create blind spots that might offer hiding places to criminals and derelicts. The intensity of lighting would be sufficient to discourage criminal activity. The materials used in vehicles and stations would be selected to limit the potential for vandalism and graffiti.

During JASE operations, random police patrols would be employed and closed circuit television surveillance of station areas would be provided. Station communications would be designed for direct verbal communication between all stations and a central control to minimize emergency response time. Suitable on-board radio equipment would be installed to ensure the security of patrons on moving vehicles. Intrusion alarms would be provided for all sensitive or hazardous areas closed to the public.

The River Crossing ASE has seven stations and 11,100 feet of dual guideway. About 2,700 feet of this dual guideway is on the Acosta Bridge and remote from pedestrian traffic.

Resource Consumption

. Land Use

The River Crossing ASE would utilize existing street rights-of-way for most of the elevated guideway structure. Private property would be acquired at some stations. These would be irretrievable commitments over the useful life of the facilities, about 50 years.¹⁰ With respect to commitment of land presently used for auto, truck, and bus travel, the JASE would take 2,370 lane-feet out of its present use. Stations would take about 3 acres. This taking represents 0.2% of the total land area within Downtown Jacksonville (2 square miles). This would not be a significant long-term commitment of Downtown land.

In addition to this commitment of land to exclusive use by JASE facilities, economic studies of the joint development potential of the JASE System have indicated that the goal of the City to encourage 100% development of Downtown Jacksonville can be significantly furthered by the JASE System. Specifically, the River Crossing ASE has been estimated to have joint development potential for about 2.92 million square feet of office and retail space. The total value of this new construction would be about \$311 million.

. Labor

The River Crossing ASE would need 15 person-years of labor annually.

. Materials

No significant material consumption would result from the operation of the River Crossing ASE System.

Energy

. Line Haul Energy

Line haul energy is the total energy per passenger-mile required to construct, maintain, and operate a transportation system. In addition to vehicle propulsion energy, it includes energy required for stations (lighting, escalators, turnstiles, etc.), energy required for maintenance facilities and operations, and construction energy of vehicles, guideway, and stations.

Station and maintenance energy were estimated from preliminary engineering specifications. The station energy requirement is greater for the JASE because of the high density of stations per guideway-mile compared to most rail systems and, because all stations are elevated, making elevators and escalators necessary for access.

Intermediate values developed for the Congressional Budget Office have been used in this study.¹¹ A lifespan of fifty years for guideways and thirty years for vehicles was assumed in calculating construction energy per passenger-mile. Table 5-4 shows estimates for various components of line haul energy.

. Modal Energy

Modal energy is the energy efficiency measure most appropriate to use in comparing the energy requirements of trips utilizing different transportation modes. In addition to line haul energy, it includes energy required for access to the transportation system. This is an important factor to consider in assessing a system like the Jacksonville ASE. Most commuting trips into and out of Downtown Jacksonville would use the JASE for only a relatively small portion of the total distance. Trips using autos for access (park-n-ride trips) would require considerably more energy than trips using buses for access. In calculating modal energy, trip circuitry, the length of the total trip relative to the most direct possible route, would be taken into account. This corrects for the less direct routes often followed by transit trips compared to automobile trips. Automobile trips are considered to have a circuitry factor of 1 (no circuitry).

TABLE 5-4

LINE HAUL ENERGY

	RIVER CROSSING AUTOMATED SKYWAY EXPRESS	
	<u>1985</u>	<u>1995</u>
Propulsion Energy (Btu/passenger-mile)	2135	1505
Station and Maintenance Energy (Btu/passenger-mile)	2114	1346
Vehicle Manufacturing Energy (Btu/passenger-mile)	44	28
Construction Energy (Btu/passenger-mile)	534	341
Total - Line Haul Energy (Btu/passenger-mile)	4829	3220

Circuitry Factors: 1.1 for bus access trips, 1.2 for ASE trips.

Comparative modal energies are shown in Table 5-5. The 20% drop for the River Crossing ASE modal energy from 1985 to 1995 results both from increased occupancy of the JASE and a decreasing proportion of automobile access trips.

. Program Energy

Program energy is the net change in transportation energy consumption resulting from operation of a transportation system. It is calculated by taking the difference between the modal energy of trips utilizing the system and the modal energies of the same trips as they would be made in the absence of the transit alternative. If a system would attract riders who would otherwise use transportation modes with higher modal energies (e.g., automobiles), there would be a net savings of transportation energy and a positive program energy. On the other hand, if a system would attract riders who would have walked or not made the trip at all without the system, then there would be a net increase in transportation energy consumption and a negative program energy.

Table 5-5 shows the program energy calculation. Note that while JASE program energies are negative, indicating a net increase in transportation energy consumption, this is entirely due to "new" trips. These are trips which result from the facilitation of circulation and increase in development within Downtown Jacksonville produced by the JASE System. If these trips are omitted from the calculation, and we consider only those trips where the JASE is substituting for existing transportation modes, the program energies are positive. This indicates that the JASE is at least as efficient or more energy-efficient than the transportation modes it replaces.

TABLE 5-5

MODAL AND PROGRAM ENERGY
(Btu/Passenger-Mile)

		UNDER THE RIVERSIDE ASE		UNDER THE RIVER CROSSING ASE	
		<u>1985</u>	<u>1995</u>	<u>1985</u>	<u>1995</u>
MODAL ENERGY	No-Build Alternative	6315	6811	6941	7218
	No-Build Alternative (including new trips*)	4547	4972	4720	4764
	ASE System Energy	6315	5904	6467	5202
	Bus-Only Alternative	9328	6931	9328	6931
<hr/>					
PROGRAM ENERGY	ASE Alternative	-1741	- 932	-1747	- 438
	ASE Alternative (excluding new trips*)	0	+ 907	+ 474	+2016
	Bus-Only Alternative	-2387	+ 119	-2387	+ 119

* New trips result from the facilitation of circulation and the increase in development in Downtown Jacksonville produced by the JASE System.

Terrestrial Ecosystems

The River Crossing ASE would be entirely in an urban setting. No mature trees would be removed to erect the stations and guideway. Ornamental shrubs that would be eliminated during construction lie in the land lots to be acquired. About six acres of habitat would be lost to animal species. However, because of the active presence of man at these locations, it is not likely that many animals have permanent nests there. It is expected that these displaced animals would be able to find other nesting areas sufficient to support them within several hundred feet of the system.

Losses of available habitat for common bird and rodent species of Downtown Jacksonville would be mitigated by the planting of trees and shrubs along the route of the proposed action in accordance with a landscaping plan. As a matter of fact, the design criteria for the JASE has proposed "generous use of plant material" along the guideway and at stations, including small street trees and native and salt-resistant

shrubs and ground covers.¹⁰ Such plantings would enhance the recreational and commercial values of the corridors. These plantings would also provide opportunity for feeding and shelter for common animal species. This would improve the habitat's desirability of the areas adjacent to the route of the proposed action and increase the likelihood of more animal life than exists now.

The Florida Department of Transportation maintains a current listing of animal and plant species which are considered by the federal government, the State of Florida, and the Audobon Society as being endangered, threatened, or of special concern. None of these species would find suitable habitats for nesting or feeding during migration through Downtown Jacksonville. It is also unlikely that any of the plant species listed could exist within the urban area outside of protected areas in public and private gardens.

Aquatic Ecosystems

There would be no wetlands within any of the service areas and no significant water quality degradation would occur as a result of construction or operation of the River Crossing ASE.

It is intended that the River Crossing ASE Alternative would use the reconstructed Acosta Bridge for access across the St. Johns River. Any operational impacts on aquatic ecosystems resulting from the St. Johns River crossing would be negligible. Impacts generated by reconstruction of the Acosta Bridge are discussed in detail in the Environmental Impact Statement for the Acosta Bridge Reconstruction Project. Such impacts would be the same for the bridge construction whether or not it would provide transit-dedicated lanes.

Air Quality

. Regional and Mesoscale Air Quality Impact

Operation of the River Crossing ASE would affect regional mobile source emissions by decreasing the total vehicle-miles traveled (VMT) within the area. This occurs because:

- * Some automobile and bus trips to the CBD would be shortened by intercepting them at intermodal facilities on the edge of the CBD.
- * The JASE would be used as a substitute for automobiles and buses for many circulation trips within the CBD.
- * Some automobile trips to the CBD would be replaced by a combination of express bus and JASE service.

Tables 5-6 and 5-7 show, for 1985 and 1995, projected modal shifts and their effects on vehicle-miles traveled. Note that shifts from

automobile trips to express bus JASE trips account for a large proportion of the change in VMT despite the relatively small number of such shifts projected. If a greater percentage of automobile commuters would be mass transit (bus/JASE) for their trips to the CBD, the total change in area-wide vehicle-miles of travel could be considerably greater.

TABLE 5-6

MODAL SHIFTS AND CHANGES IN DAILY VEHICLE-MILES OF TRAVEL
1985 PROJECTIONS
RIVER CROSSING ASE

OLD MODE	NEW MODE	NUMBER OF TRIPS	CHANGES IN VMT			
			AUTO		BUS	
			CBD	NON-CBD	CBD	NON-CBD
Auto	Auto/JASE	4,900	-4,900			
Auto/Bus	Auto/JASE	700			- 60	
Auto	Bus/JASE	500	- 400	-3,200		+ 200
Bus	Bus/JASE	7,500			- 600	
Auto	JASE	500	- 500			
Bus	JASE	2,400			- 200	
No Trip or Walk	JASE	<u>7,300</u>				
TOTAL		24,100	-5,800	-3,200	- 860	+ 200

TABLE 5-7

MODAL SHIFTS AND CHANGES IN DAILY VEHICLE-MILES OF TRAVEL
1995 PROJECTIONS
RIVER CROSSING ASE

OLD MODE	NEW MODE	NUMBER OF TRIPS	CHANGES IN VMT			
			AUTO		BUS	
			CBD	NON-CBD	CBD	NON-CBD
Auto	Auto/JASE	6,300	-6,300			
Auto/Bus	Auto/JASE	1,000			- 100	
Auto	Bus/JASE	2,600	-2,300	-1,300		+1,100
Bus	Bus/JASE	10,300			- 800	
Auto	JASE	1,000	- 900			
Bus	JASE	4,200			- 300	
No Trip or Walk	JASE	<u>13,000</u>				
TOTAL		24,100	-9,500	-1,300	-1,200	+1,100

The changes in VMT projected in Tables 5-6 and 5-7 would result in the total, area-wide, decreases in emissions shown in Table 5-8.

TABLE 5-8
DECREASES IN EMISSIONS
RIVER CROSSING ASE

	<u>1985</u>	<u>1995</u>
Hydrocarbons	9.0 tons/yr.	9.5 tons/yr.
Carbon Monoxide	99.5 tons/yr.	174.5 tons/yr.
Nitrogen Oxides	11.7 tons/yr.	12.9 tons/yr.

As Tables 5-6 and 5-7 show, a large percentage of the decrease in VMT would be in trips and portions of trips within the CBD. This would amount to a decrease in 2-3% in vehicle-miles traveled within the CBD. Over 90% of the decrease in VMT is in peak hour/peak direction traffic: cars and buses coming into the CBD in the morning rush hour and leaving the CBD in the evening rush hour. These are the periods when high traffic volumes, congestion, low speeds, and "stop-and-go" traffic result in the highest CO emissions. Furthermore, much of this decrease would be in traffic links often identified as key bottlenecks -- the river crossings and their approaches. In 1985, about 700 peak hour/peak direction river crossings would be intercepted by the River Crossing ASE. This is equivalent to about 20% of the current peak hour/peak direction traffic on the Main Street and Acosta bridges.

. Microscale Air Quality Impacts

(1) Introduction

While the area-wide effect of the River Crossing ASE on air quality would be beneficial, there might be some local negative effects in the areas surrounding the intermodal stations: St. Johns Place at the south end of the line and Florida Junior College at the north end. At these locations there would be park-n-ride facilities built by others for automobile riders who wish to transfer to the JASE. Bus routes would also connect to the JASE at these stations. Local carbon monoxide concentrations would increase due to increased automobile and bus traffic on the surrounding roadways, emissions from automobiles entering and exiting parking lots, and buses stopping to pick up and discharge passengers. To assess the impact of the intermodal stations on local CO levels, microscale modeling techniques were employed.

(2) Methodology

The modeling procedure used in performing the carbon monoxide analysis for the intermodal station areas is based on the EPA's indirect source review procedures given in United States Environmental Protection Agency guidelines.¹² The indirect source review guidelines summarize procedures for estimation of carbon monoxide concentrations due to motor vehicle activity associated with the operation of indirect sources based on application of the EPA HIWAY and SRI APRAC air pollution models.

Estimates of peak 1-hour and 8-hour carbon monoxide concentrations were calculated for six distinct situations: 1985 "No-Build" Alternative, 1995 "No-Build" Alternative, 1985 JASE operation with projected usage, 1995 JASE operation with projected usage, 1985 JASE operation at maximum capacity of parking facility, and 1995 JASE operation at maximum capacity of parking facilities.

(3) Results

The results of the microscale air quality modeling are shown in Table 5-9. Predicted maximum 1-hour and 8-hour concentrations would not violate the National Ambient Air Quality Standards for carbon monoxide at both sites. In all cases, predicted 1995 concentrations are lower than predicted by 1985 concentrations. This is because the replacement of older vehicles with relatively clean, newer vehicles more than compensates for the increases in traffic volumes.

TABLE 5-9
RESULTS OF MICROSCALE AIR QUALITY MODELING
MAXIMUM 1-HOUR AND 8-HOUR CARBON MONOXIDE CONCENTRATIONS
RIVER CROSSING ASE

	MAXIMUM 1-HOUR CONCENTRATION (ppm)		MAXIMUM 8-HOUR CONCENTRATION (ppm)	
	<u>1985</u>	<u>1995</u>	<u>1985</u>	<u>1995</u>
St. Johns Place				
No-Build	7.7	7.0	5.2	4.7
Projected Usage	8.2	7.6	5.3	4.9
Capacity Usage	8.8	8.0	5.4	5.0
Florida Junior College				
No-Build	9.2	8.3	6.2	5.5
Projected Usage	9.4	8.4	6.3	5.5
Capacity Usage	10.1	8.7	6.4	5.7

Noise and Vibration

. Passby Noise

The operational maximum speed of the Jacksonville ASE vehicle would be 30 mph. At this speed, the vehicle would generate a maximum noise level of 75 dBA at a distance of 50 feet from the guideway centerline. For a vehicle traveling at 10 mph there would be a maximum noise level of 63 dBA at 50 feet. Typical exterior noise contours are shown in Figure 5-10. In sections of the alignment where the guideway would be separated by a station or walkway, noise levels would be lowered significantly from worst-case levels by the greater distance of the far track from the point of noise impact. The addition of a 2.5-foot high parapet along the side of the guideway structure could reduce maximum noise levels more than 6 dBA. Most curved sections of the guideway would not likely generate maximum noise levels due to the reduction of vehicle speed.

In comparison to the lowest estimated background (L_{dn} of 67 dBA) at the corner of King and Prudential, the worst-case JASE noise level (L_{dn} of 59.4 dBA at 30 mph and 50 feet) is insignificant and, when added logarithmically, would raise the background by only .7 dBA. Human perception is 3 dBA change. The peak hour (L_{eq}) is estimated to be 62.6 dBA at 50 feet and 30 mph. In the case of Hogan Street, noise levels would be lowered with the planned decrease of vehicular traffic.

. Interior Vehicle Noise

Performance specifications for the JASE System establish interior vehicle noise level limits which are not to be exceeded under normal operating conditions with all equipment, including air conditioning, operating. See Table 5-10.

TABLE 5-10
INTERIOR VEHICLE NOISE LEVELS
AUTOMATED SKYWAY EXPRESS ALTERNATIVE

<u>CONDITION</u>	<u>MAXIMUM ALLOWABLE INTERIOR NOISE LEVEL</u>
Vehicle Stationary (doors shut)	68 dBA
Vehicle Moving	
at 10 mph	70 dBA
at maximum cruise speed	75 dBA

TYPICAL EXTERIOR NOISE CONTOURS FOR ATA OPERATIONS AT 10 M.P.H.

(Passby Duration Approximately 5.25 Seconds)

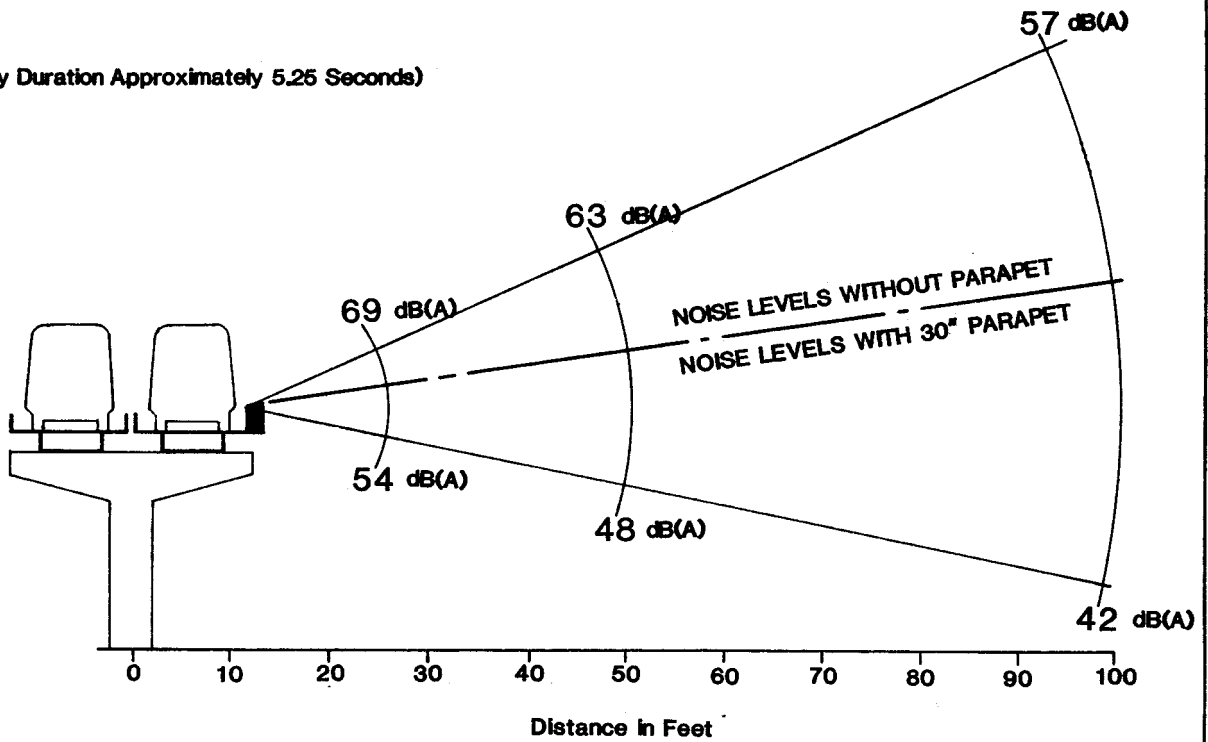

TYPICAL EXTERIOR NOISE CONTOURS FOR ATA OPERATIONS AT 30 M.P.H.

(Passby Duration Approximately 1.75 Seconds)

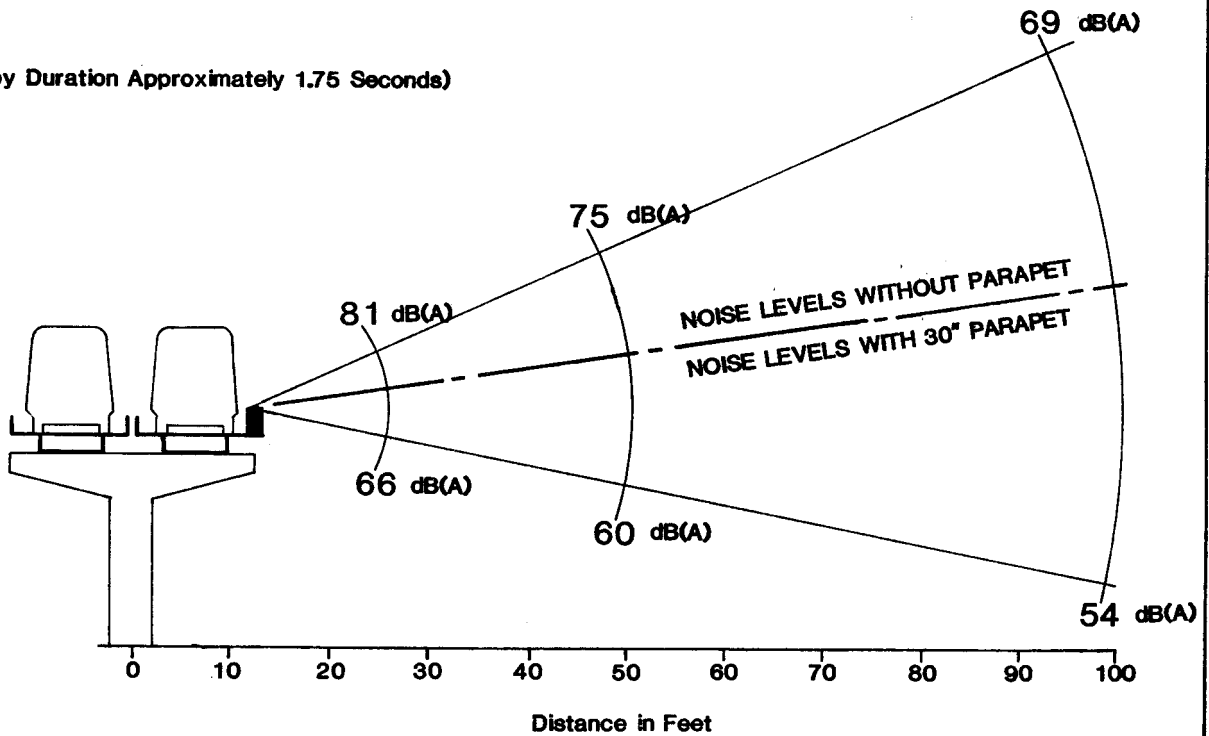

FIGURE 5-10

TYPICAL EXTERIOR NOISE CONTOURS

. Vibration

Vehicle performance design criteria specify vibration levels that are imperceptible as per ISO and APTA vibration and shock limits. Vibration from the JASE vehicle would be less than that caused by a street vehicle of equivalent weight. However, instead of originating from the roadway surface, vibration would radiate from the foundation of the guideway support structure. There would be no measurable vibration impacts.

Summary

. Short-Term Impacts

Construction of the River Crossing ASE would result in several temporary adverse impacts which cannot be avoided, including:

- * Temporary traffic congestion and pedestrian inconvenience would occur during construction of JASE foundations, piers, and erection of guideway aerial elements. Some side street parking would be temporarily lost as a result of JASE construction.
- * Construction activity and related pedestrian barriers would temporarily affect adjacent businesses.
- * Construction would increase noise levels, vibration, and air pollution around pier locations and station areas.
- * The presence of construction activity and the incremental development of the JASE System would intrude into the existing visual setting along the alignment. The construction impacts would be present for relatively short periods, the longest being at station areas.
- * Short-term impacts on the natural environment would be minor including the generation of spoil material, increases in erosion and sedimentation, and increases in emissions from construction equipment.
- * Deployment of the ASE alternative would require a capital investment of approximately \$62.2 million.

. Long-Term Impacts

Operation of the River Crossing ASE would result in additional long-term unavoidable adverse impacts, including:

- * There would be displacement of approximately 20 employees and 5 businesses. About 3 acres of private land would be transferred into the public domain.
- * The CMSA would discharge small amounts of sanitary effluent and wastewater containing wash solvents, mud, grease, and oil.

- * The guideway, piers, and skywalk system and stations would appear in some views of some CBD structures.
- * The intermodal stations might produce traffic congestion and increase bus activity at their locations.

Contrasted against these short-term and long-term impacts would be the ability of the River Crossing ASE to enhance and accelerate the goals for urban productivity adopted by the City of Jacksonville. It is the adopted policy of the City to encourage development in Downtown Jacksonville which would revitalize the urban core as the major commercial, recreational, and residential area of the jurisdiction. In order to achieve this end, numerous area plans have been prepared which specify site development opportunities. These plans have been developed with the assumption that Downtown transit circulation would be greatly improved. All these plans approve of the JASE System as the mode alternative for circulation improvement and identify the reinforcing aspects of such a system on community plans and growth.

A recent study of the induced development potential of the River Crossing ASE has shown that the JASE System could increase investment in new development Downtown by more than 10%. Specifically, by 1995, total commercial and retail growth Downtown would be equivalent to \$950 million. Additional development induced by the JASE would be equivalent to \$102 million.

CONSTRUCTION IMPACTS

Physical and Transportation

. Traffic Circulation and Parking

Disruptions to traffic during construction would be localized and short-term in nature. Except for the permanent changes to Hogan Street described below, there would be no reduction in the number of lanes available to traffic in any of the areas traversed by the JASE. Detours should not be necessary at any time during the construction period, although temporary lane closing might be required adjacent to particular construction activities.

Three lanes of traffic would be maintained on Bay Street except for temporary lane closings during construction of pier footings, pier elements, and erection of guideway beams.

With the reduction in the Hogan Street pavement width from 50' to 20' and the reduction of through-traffic, the majority of existing traffic would permanently relocate to adjoining northbound streets. Construction disruptions to emergency and service vehicles during construction on Hogan Street should be minor.

Two lanes of 2-way traffic would be maintained on Mary Street, south of the river, except for temporary lane closings during footing and pier construction and the erection of guideway elements. Crossings of Bay Street, Broad Street, Hendricks Avenue, and Prudential Drive would lead to temporary lane closings during erection of guideway elements, but normal traffic patterns could be expected otherwise.

The contractor's work adjacent to major traffic arteries would be scheduled to minimize interference with traffic during anticipated peak travel periods. If feasible, work that would normally disrupt traffic would be performed during off-peak hours (at mid-day, at night, or on weekends).

Minor changes to bus routes might be required in the Downtown area to avoid construction activities and insure the safety of system patrons. Buses now using Hogan Street would be shifted to adjacent streets and a new bus transfer point to replace the Hemming Plaza transfer area would be developed by JTA staff. Bus patrons might experience some inconvenience and delay during temporary lane closings on streets affected by JASE construction.

Existing curb parking on Hogan Street, Bay Street, and Mary Street would be eliminated during the construction period. Traffic lanes would be shifted and barriers would be erected to separate construction activities from the adjacent traffic. Approximately 150 curb spaces would be lost. Replacement parking for shoppers would be available in adjacent public and private off-street parking along Hogan and Bay Streets while employees might use existing shuttle buses serving park-n-ride lots at Liberty and State Streets, Prudential Drive, San Marco Avenue, and Hendricks Avenue.

. Accessibility of Facilities, Services, and Jobs

Changes to the existing street system and traffic patterns resulting from construction of the River Crossing ASE would include the following:

- * Hogan Street would be closed between State and Union Streets to permit construction of the FJC Station and associated bus interface and kiss-n-ride facilities.
- * The remainder of Hogan Street between Bay and Union Streets would be 2-way as a local service road for commercial delivery and emergency vehicles. The area below the JASE in the eastern half of the street right-of-way would become a pedestrian mall with no vehicular traffic except at cross streets.
- * Bay Street would be narrowed in width between Hogan and Broad Streets to three lanes of 1-way traffic west (with no parking) by construction of a new curb along the south side of the street to separate the JASE piers from adjacent traffic. Area below the guideways would be used for pedestrian purposes except where sufficient space between piers would permit an indentation of the curb for curb parking.

- * Mary Street, south of the St. Johns River, would remain a 2-lane, 2-way street, but would lose curb parking by construction of a new curb on the south side to separate JASE piers from adjacent vehicular traffic. Where possible, the curb would be indented to permit limited curb parking. Intersections with San Marco Boulevard, Main Street, and Flagler Avenue would continue to function as at present.

Businesses which would have temporary disruption are listed in Table 5-11. There would be 23 businesses affected by the JASE. Eighteen of the businesses are along Hogan Street and would be the ones most impacted. All corner businesses would have ample loading facilities on side streets. Six businesses have storefront only on Hogan Street and 3 presently have loading facilities. Pedestrian access would be maintained during all business hours so the pedestrian access impedence would not be significant. The Atlantic Bank Parking Garage exit is on Hogan Street, but is on the side opposite the guideway construction so there should be no significant impact. There would be temporary interruption to the IBM Building and Devane Printing loading zones, but this should be minimized by careful scheduling of construction activities.

Socioeconomic

. Employment, Income, and Business Activity

(1) Adverse Impacts

Construction of the River Crossing ASE carries with it the potential for disrupting commerce in the vicinity of the guideway, stations, and/or construction staging area. The nature and severity of such impacts would be a function of the timing and duration of construction and the construction techniques employed. Such disruption would occur when construction conditions inhibit deliveries of goods and access by customers, employees, clients, or vendors. Such construction conditions include:

- * Loss of parking due to elimination of off-street parking or temporary blockage of entrances to parking lots/structures.
- * Interruption of pedestrian access due to sidewalk closures, construction barriers, etc.
- * Inhibited goods movement (shipments and deliveries) due to rerouting of traffic, blockage of loading ramps, etc.
- * Obstruction to storefronts due to dust, barriers, etc.
- * General inconvenience to customers, clients, and motel/hotel guests as a result of noise, traffic rerouting, and perceptions of confusion, clutter, congestion, uncertainty, etc.

In general, the time period of disruption on any single block along the route (3-4 months) would be sufficiently short to preclude the

TABLE 5-11

BUSINESS DISTURBANCES

RIVER CROSSING ASE CONSTRUCTION

NAME AND LOCATION	RELATION TO ASE			ACCESS DISTURBANCE		
	FRONT	REAR	SIDE	PEDESTRIAN	AUTO	LOADING
Legal Aid Society	X			X		
Jones Furniture	X			X		X
Western Union	X			X		X
Cokesbury Book Store	X			X		
May Cohens Dept. Store			X	X		
Physicians and Surgeons	X			X		
Baker's Shoe Store	X			X		
U. S. Hair	X			X		
Eastern Airlines	X			X		X
Convention & Visitors Bureau	X			X		X
Florsheim Shoes	X			X		
Underwood Jewelry			X			
Lahn's	X			X		
Desert Rider Sandwich	X			X		
Levy Wolf			X	X		X
Furchgott's Clothing	X			X		X
Unoccupied (Rosenblum's)			X	X		
Atlantic Bank Garage		X			X	X
Atlantic Bank	X			X	X	X
Unoccupied (Sears)	X			X	X	X
Greyhound Bus Co.			X		X	X
IBM Building			X		X	X
Devane Printing			X		X	X

likelihood of any permanent adverse impacts on any established business operations, if during the construction period, continued access to businesses was maintained and there would be no long-term interruption of utilities and other public services.

While individual retail stores and businesses might experience a temporary loss in customer and sales volume, the net effect on Downtown Jacksonville would be reduced by internal transfers of sales. The losses incurred by one establishment would yield gains to other establishments not subject to disruption. The shift would be virtually complete for eating establishments and others catering primarily to Downtown employees. Employees would not stop eating lunch because of JASE construction. Retail specialty stores with regional clientele or employees could suffer temporary losses. Given the small magnitude of expected revenue losses and the short time period involved, it is not anticipated that any employment loss in continuing businesses would arise from the disruptions caused by construction or that any business would move or cease to operate because of disruption impacts.

(2) Beneficial Impacts

(a) General

Costs of labor and materials for construction of the River Crossing ASE are estimated at \$62.2 million. Approximately 88% of this \$62.2 million, or \$54.6 million, can be described as "new money" to Jacksonville/Duval County. It is estimated that \$38.8 million, or 71% of the total \$54.6 million in "new money" construction cost, would be spent in Jacksonville/Duval County. The cumulative regional impact of this new investment in the local economy would include increases in local business activity, employment, and household income which are summarized in Table 5-12.

(b) Business Activity

The \$38.8 million of "new money" for the River Crossing ASE construction to be spent in Jacksonville/Duval County has been broken down as follows:

- * Construction Labor - \$19.9 million
- * Materials and Supplies - \$7.4 million
- * Engineering and Management - \$7.0 million
- * Contingencies - \$4.5 million

Applying a 2.242 output multiplier for construction projects in Florida, the indirect local gain attributable to the initial purchases of labor and material required to construct the project has been estimated at \$48.2 million.¹¹

Considering both direct and indirect gains, the cumulative regional impact on business activity of the JASE investment would be approximately \$87.0 million. Expressed as a dollar ratio, this indicates that

TABLE 5-12

SUMMARY OF DIRECT AND INDIRECT-INDUCED EFFECTS OF
CONSTRUCTION ON JACKSONVILLE/DUVAL COUNTY
FROM THE RIVER CROSSING ASE

<u>ITEM</u>	<u>DIRECT EFFECT</u>	<u>INDIRECT/ INDUCED EFFECT</u>	<u>TOTAL EFFECT</u>	<u>RATIO OF TOTAL EFFECT TO DIRECT EFFECT</u>
Business Activity	\$38.8 million	\$48.2 million	\$87.0 million	2.24*
Household Income	\$25.1 million	\$28.7 million	\$53.8 million	2.14**
Employment	731 person/yr.	1650 person/yr.	2381 person/yr.	3.25**

* From State of Florida Input-Output Model, Florida Department of Commerce, 1976 Economic Report of the Governor.

** These ratios represent maximum multiplier effect in accordance with the assumptions of the accompanying text. Local leakage interaction effect and expenditure timing could produce lower multipliers.

for every dollar invested by a 10% local support of the total capital costs of the JASE System, approximately \$14.4 million in economic activity would be generated in Jacksonville/Duval County.

(c) Household Income Effect

Of the \$38.8 million for JASE construction to be spent in the local economy, approximately \$31.4 million would be spent in the form of wages, salaries, and fringe benefits. This would include \$19.9 million for labor, \$7.0 million for engineering and management, and \$4.5 million for the contingency budget. Allowing for a non-income fringe benefit of 20%, the total direct impact of JASE construction on regional household income would be approximately \$25.1 million.

Indirect gains in household income are expressed as a percentage of indirect gains in business activity. Assuming this percentage to be 70%, approximately \$33.7 million of the total indirect gains in business activity would be in the form of wages and salaries. Allowing for a slightly lower non-income fringe benefit of 15%, the total indirect impact of JASE construction on regional household income would be approximately \$28.7 million.

Considering both direct and indirect gains, the cumulative regional impact on household income of the JASE investment would be approximately \$53.8 million. The household income multiplier for the JASE project, expressed as the ratio of \$53.8 million total induced household income to \$38.8 million direct expenditure in the local economy, is estimated to be 1.39.

(d) Employment Effect

Construction of the River Crossing ASE would result in direct household income expenditures of \$25.1 million. Assuming a January 1985 (mid-point of construction) average hourly salary rate (including fringe benefits) of \$16.50, JASE construction would generate 731 person-years of employment.

Induced indirect gains in household income resulting from JASE construction have been estimated at \$28.7 million. Assuming a 1985 North Florida average household income of \$22,613 and 1.3 employees per household, it is estimated that this gain would produce at least 1,650 additional person-years of employment in Jacksonville/Duval County.

Considering both direct and indirect employment gains, the \$38.8 million local construction expenditure for the JASE would produce a total of 2,381 man-years of employment.

(e) Effects on Property and Other Taxes

The ASE alternative would cause an increase in tax revenues as an indirect result of the new capital resources invested in the region for the construction of the fixed facilities identified. Some of the wages and profits derived from construction of fixed facilities would be invested in the improvement of personal and business property. The increase in tax revenues would be the direct result of the increase in assessed valuation of the improved property.

(3) Resource Consumption

(a) Construction Labor

The construction of the ASE alternative would generate a need for about 731 person-years of employment. The basis for this estimate is provided above. Using the same basis for calculation, the \$5.2 billion of private and public funds to be expended on construction projects around Jacksonville in the 1980s would generate a need for over 60,000 person-years of construction labor. Persons making their living in Duval County from construction employment (SIC Codes 15, 16, and 17) number about 16,000. Therefore, the River Crossing ASE would not generate a significant demand for growth of construction labor in Duval County, Florida.

(b) Construction Materials

The major construction materials used on the River Crossing ASE would be steel, cement, aggregate, lumber, bitumen, and petroleum products. These materials are common to most new construction. The materials' value of the fixed facilities construction for the River Crossing ASE would be less than \$12 million. The materials' value of public and private construction projects proposed for the 1980s would be about \$3.12 billion. The River Crossing ASE would represent 0.4% of the total irretrievable demand for construction materials in the Jacksonville area in the next decade. This would be an insignificant long-term commitment of these materials.

(4) Public Safety

Extensive safety procedures and precautions would be taken to reduce to the lowest practical level the possibility of hazard or risk to construction workers and the general public during the construction period while the elevated facilities and their stations and appurtenances are being constructed. A comprehensive construction safety program is spelled out in the ASE System Safety and Assurance Plan.

Natural and Historic

. Air Quality

Construction of the JASE would have the following impacts on air quality: dust from construction sites; emissions from construction equipment and vehicles; and increased emissions due to construction-related traffic congestion. None of these impacts would be severe.

Construction of the JASE elevated guideway would not require extensive street excavation or earth moving and would not be likely to generate large volumes of fugitive dust. Contractors would be required to take appropriate measures for dust abatement, such as watering exposed surfaces, restricting traffic on unpaved areas, and use of tarpaulins on loaded trucks. Also, all construction equipment would have appropriate emission control devices.

Street level construction activities would require temporary partial or complete closings of some streets. This may increase traffic congestion and might result in increased local carbon monoxide concentrations. This effect could be mitigated by appropriate traffic control measures, including efficient and well-publicized rerouting of traffic and scheduling construction activities to minimize interference with peak-hour traffic.

. Noise and Vibration

(1) Noise

Construction of the proposed JASE would have a short-term noise impact on sensitive receptors in the immediate vicinity of the construction sites.

The extent of the construction-associated noise impacts would depend upon the nature of the individual track segment, the construction schedule, and noise characteristics of the construction equipment. In general, construction noise impacts would occur only during daytime working hours of 7:00 a.m. to 7:00 p.m. The noisiest equipment likely to be employed in the construction activities would be earth moving equipment (backhoes, tractors, scrapers, graders, and other heavy-duty diesel trucks). Noise levels for typical construction equipment, measured in dBA at 50', are presented in Table 5-13.

TABLE 5-13

TYPICAL CONSTRUCTION EQUIPMENT PEAK NOISE LEVELS

<u>EQUIPMENT TYPE</u>	<u>NO. MFRS. IN SAMPLE</u>	<u>TOTAL NO. MODELS IN SAMPLE</u>	<u>PEAK NOISE LEVELS (dBA)</u>	
			<u>RANGE</u>	<u>AVERAGE</u>
Cranes	7	17	70-94	79
Backhoes	5	6	74-92	83
Front Loaders	5	50	75-96	85
Dozers	8	41	65-95	85
Graders	3	15	72-92	84
Scrapers	2	27	76-98	87

Reference: Reagan, Jerry A. and Charles A. Grant, Highway Construction Noise: Measurement, Prediction and Mitigation, Special Report HEV-21, U.S. Department of Transportation, Federal Highway Administration, Office of Environmental Policy, Washington, DC, 1977.

(2) Vibration

Ground-borne vibration produced by construction activities would be attributable to intermittent use of heavy equipment. Vibrations generated by this equipment would travel through the soil to adjacent buildings and would result in structural vibrations and secondary radiation. Since this equipment is the same as would be used in ordinary street or underground utility work, no serious or long-term negative impacts would be expected to result from ground-borne vibration produced during construction of the River Crossing ASE.

. Disruption or Damage to Adjacent Structures and Land

(1) Subsidence

Adjacent structures might incur a negligible impact from subsidence or settlement during the construction activities. This determination would be based upon a soils investigation, proposed foundation design, and proposed construction methods. The design of the foundations for the elevated station and guideway piers would be based upon recommendations from a geotechnical investigation. Adherence to these recommendations should insure that foundation loads would not cause adverse subsidence due to soil consolidation. Excavation for construction of spread footings and pile footings would be relatively shallow and require limited lowering of the groundwater level, if any. Subsidence, which would be attributable to drawdown of the groundwater table, should be of no consequence. Shallow foundations would be of the spread footing type when permitted by soil conditions and existing utilities. Where deep foundation systems are dictated, piles would be utilized. Acceptable vibration and noise level would be established by preconstruction studies for pile driving. For areas in which pile driving noise and vibration is unacceptable, auger-grouted piles or drilled shafts would be utilized.

Anticipated settlement of non-pile supported JASE structures north of the St. Johns River should be on the order of 1 inch to 1-1/2-inch while long-term settlement south of the river should range from 1/2 inch to 1 inch, according to the geotechnical report.¹³

A preconstruction crack survey should be conducted on all existing structures likely to be affected by the proposed construction. The survey would document significant structural defects (cracks) prior to and following the construction activities to afford a basis for resolving damage claims. A monitoring program should also be established to insure pre-established limits for vibration and noise are not exceeded.

(2) Flooding

Flooding, and damage caused by flooding, to adjacent structures and property during construction would be negligible as only minor modifications to the storm sewer network would be anticipated during the period of construction. The effect of flooding on the facility during construction would be minimal as excavations for foundations would be shallow.

(3) Corrosion and Stray Electrical Current

Electrical currents used during the construction period would be low voltage for construction tools and equipment and would have no corrosive effect on underground utilities and structures due to electrolysis.

(4) Combustible Materials and Toxic Gases

The impact on adjacent structures and land from the use and storage of hazardous materials related to construction of the proposed JASE System would be minimal. The hazardous materials such as acetylene, gasoline, diesel fuel, and cleaning compounds would be the same as used in commercial and municipal construction in developed areas. Compliance with applicable codes and placement of effective barriers and shields where required would insure the safety of persons and property during construction. Actual construction materials for the stations, guideways, and vehicles would be non-toxic and non-combustible. Storage of chemical compounds and reagents would be in locations and by methods approved by the Jacksonville Fire Department and the City of Jacksonville Insurance Underwriters.

. Historic Property

Between September 7 and 13, 1980, the Florida Division of Archives, History, and Records Management conducted a survey in Downtown Jacksonville to identify National Register and eligible properties that had the potential to be affected by JASE facilities. The survey identified 45 properties in Downtown Jacksonville that had the potential to meet the National Register eligibility criteria. Some of these sites were already listed on the National Register. Of these, the following properties share a property line with an urban street along which the facilities of the automated skyway express alternative would be constructed:

Listed on the National Register

- | | |
|----------------------------|---------------------|
| 1. St. James Building | 117 W. Duval Street |
| 2. El Modelo Cigar Factory | 513 W. Bay Street |

Eligible for the National Register

- | | |
|---------------------------------|---------------------|
| 3. First Baptist Church | N. Hogan Street |
| 4. Seminole Club | 400 N. Hogan Street |
| 5. U.S. Fidelity & Guaranty Co. | 425 N. Hogan Street |
| 6. Levy-Wolf Building | 135 W. Adams Street |
| 7. A. R. Cogswell Building | 433 W. Bay Street |

The location of the properties is shown schematically in Figure 5-11. A letter requesting a determination of eligibility for the properties listed above was forwarded to the Department of Interior June 1, 1981. The Keeper of the National Register of Historic Places, on June 18, 1981, determined that the five sites identified above are eligible for listing in the National Register.

The impact of the JASE System on the historic properties along the

HISTORIC PROPERTY

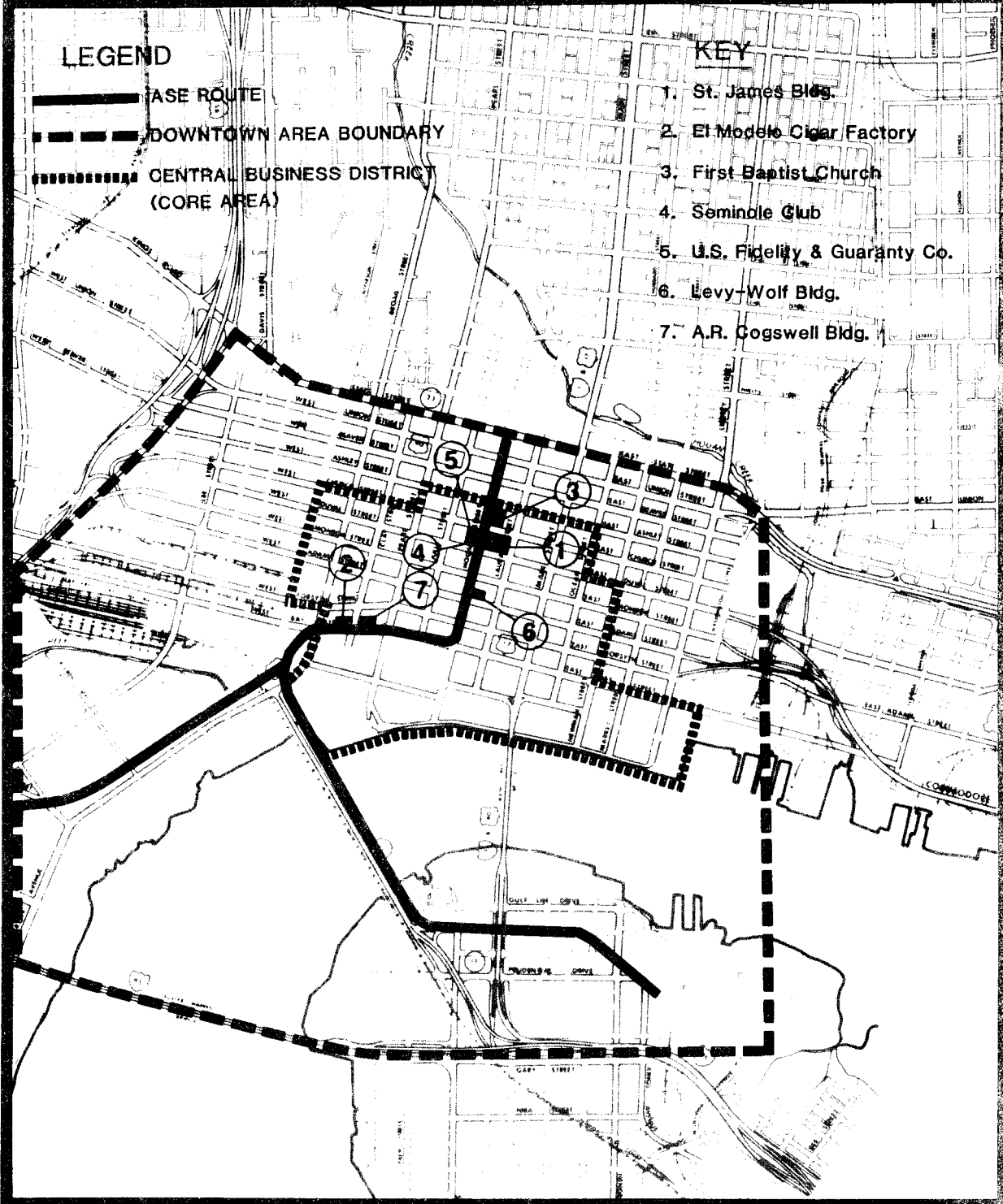

FIGURE 5-11

alignment depends on the facility's design and integration in the existing street setting. Since abstract issues are involved, it was decided to utilize the past decisions of the Florida SHPO, other SHPOs, and the ACHP as documented in previous federally-approved projects as the basis for development of impact evaluation criteria.

In the evaluation of impact of JASE facilities on historic properties, it is necessary to determine whether or not the JASE facilities will have an effect upon the setting or environment surrounding the property. The absolute distance between the historic properties and JASE facilities is the first criterion for evaluation of impact. A review of the final EIS for similar systems in Detroit, Miami, and Los Angeles indicated that the SHPOs in Michigan, Florida, and California, as well as the ACHP, agreed that ASE facilities could only have an effect on historic properties where the property was within 100' of the edge of ASE facilities.

In the same documentation, the Michigan, Florida, and California SHPOs, as well as the ACHP, agreed that roadways create a functional barrier and the visual edge is not altered by structures on the opposite side of the roadway from an historic property. Therefore, the Michigan, Florida, and California SHPOs, as well as the ACHP, accepted the determination of ASE planners that guideway or station facilities across an urban street from an historic property would not generate an adverse effect.

The ACHP has developed criteria to determine whether a proposed project, called an "undertaking", will have an effect on a National Register or determined eligible historic property, and published the criteria in 36 CFR 800.3(a):

"An undertaking shall be considered to have an effect whenever any condition of the undertaking causes or may cause any change, beneficial or adverse, in the quality of the historical, architectural or archaeological or cultural characteristics that qualify the property to meet the criteria of the National Register."

The ACHP also developed and published criteria for use in the evaluation of whether or not an undertaking has an adverse effect upon a 106 property. These criteria include, but are not limited, to:

"1) Destruction or alteration of all or part of a property; 2) Isolation from or alteration of the property's surrounding environment; 3) Introduction of visual, audible, or atmospheric elements that are out of character with the property or alter its setting; 4) Neglect of a property resulting in its deterioration or destruction; 5) Transfer or sale of property without adequate conditions or restrictions regarding preservation, maintenance, or use."

The Criteria of Adverse Effects have been applied in consultation with the Florida SHPO to the historic properties along the route of the JASE alternative. The properties include:

- * First Baptist Church
- * St. James Building
- * U.S. Fidelity and Guaranty Company
- * Seminole Club
- * Levy-Wolf Building
- * El Modelo Cigar Factory
- * A.R. Cogswell Building

It has been determined that there would not be any adverse effect on any of these properties according to criteria 1), 4), or 5) of Adverse Effects for the following reasons:

- 1) No part or any of the properties would be altered or destroyed;
- 4) The proposed action would not contribute to the neglect of any of the properties resulting in a property's deterioration or destruction. The project could act as a stimulus in the rehabilitation or use of these properties; and
- 5) The proposed action would not require the transfer or sale of any of these projects.

Criterion 2), isolation from or alteration of the property's surrounding environment, has also been applied and the potential impacts of the project in this regard are not considered to be significant.

Under Criterion 3), the proposed action would not produce any atmospheric elements that would be out of character or alter the setting of any of the remaining properties.

Current photographs of each of the seven (7) historic properties affected by the JASE construction are shown on Figures 5-12 through 5-18.

The State Historic Preservation Officer has determined that the Automated Skyway Express will have no adverse effect on sites listed or eligible for listing in the National Register of Historic Places or otherwise of national, state, or local significance. The letter dated February 8, 1982 from the Deputy SHPO is included in the EIS.

The proposed JASE for Central Jacksonville has received overwhelming support from public agencies, civic groups, and interested citizens. The route was selected through an extensive public participation process. During numerous public meetings, these groups have expressed the desire to preserve and protect Jacksonville's historic properties. The alignment of the dual guideway is specifically designed and placed to minimize adverse effects to historic properties there. The Citizens Advisory Committee on the proposed undertaking approved the routes at a public meeting held in April 1981 after considering through its appropriate subcommittees alternative routes, design approaches, and potential environmental impacts including adverse effects on historic



FIGURE 5-12 SIDE ENTRANCE ON THE WEST FACADE OF THE FIRST BAPTIST CHURCH



FIGURE 5-13 THE SOUTH AND WEST FACADES OF THE ST. JAMES BUILDING

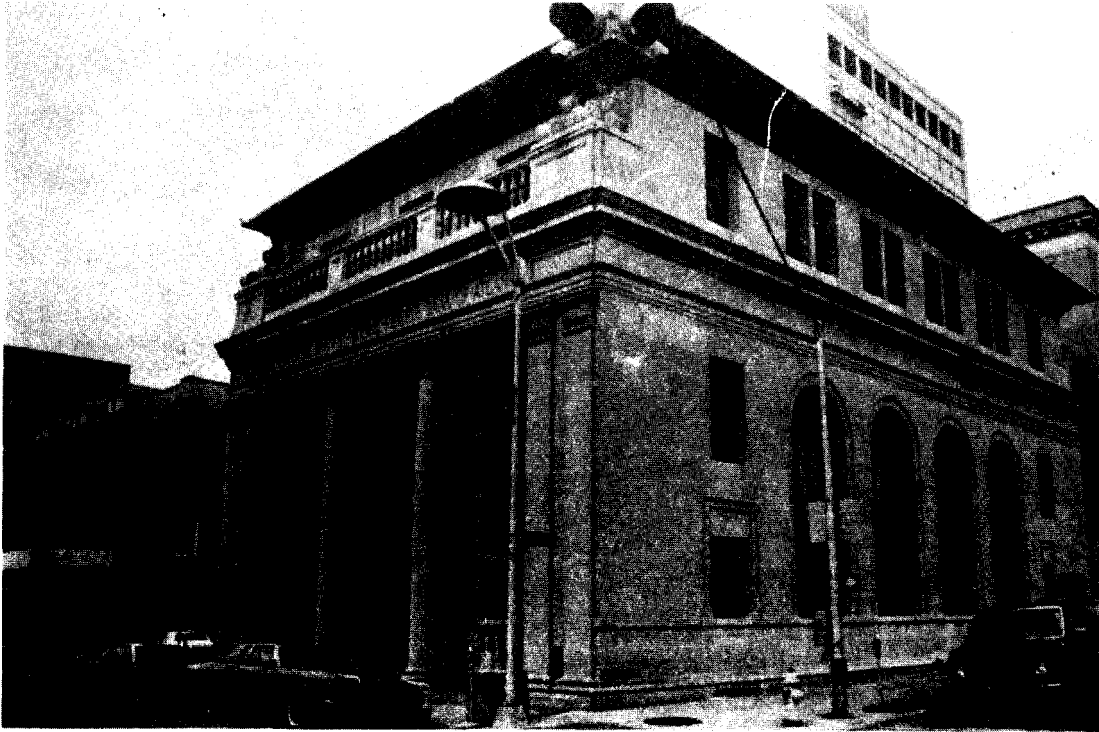

FIGURE 5-14 THE NORTH AND WEST FACADES OF THE U.S. FIDELITY AND GUARANTY BUILDING

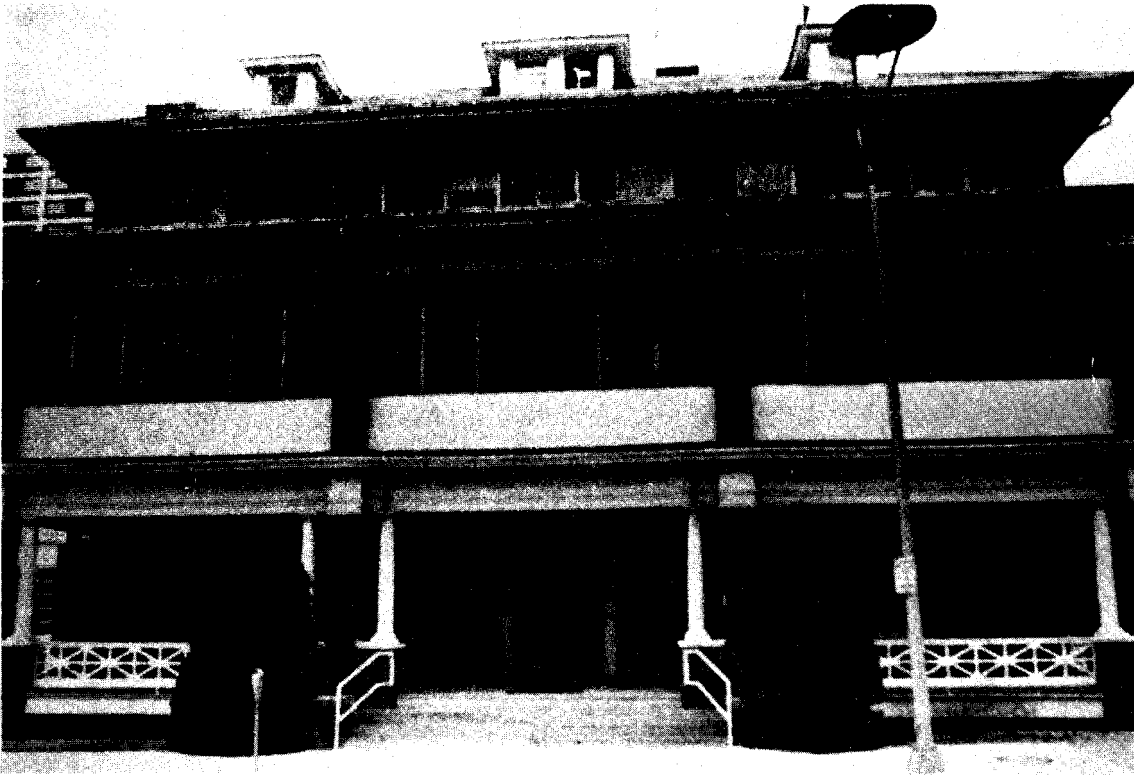

FIGURE 5-15 MAIN ENTRANCE ON THE WEST FACADE OF THE SEMINOLE CLUB



FIGURE 5-16 SIDE ENTRANCE ON THE WEST FACADE OF THE LEVY-WOLF BUILDING



FIGURE 5-17 SOUTH AND EAST FACADES OF THE EL MODELO CIGAR FACTORY



FIGURE 5-18 SOUTH FACADE OF THE A.R. COGSWELL BUILDING

properties. The SHPO staff commended the JTA's and CAC's effort to mitigate possible negative effects on historic sites.

EIS PROCESS

The purpose of the EIS process is to assure that possible adverse economic social and environmental effects resulting from construction and implementation of the proposed JASE System are fully considered and that the final decisions on the project are compatible with related federal, state, and local government plans, actions, and policies. The primary product of the process is the Final Environmental Impact Statement which must conform to federal, state, and local requirements and guidelines and which will reflect comments received from all interested parties during the draft EIS review period and following the required public hearing.

Notice of Intent

The first step in the process, after it is determined that an EIS is required by federal and state regulations, is the publication of a Notice of Intent in the Federal Register followed by an appropriate similar notice at the local level. Included at this step is the holding of a scoping meeting to permit interested and affected agencies and governmental bodies to be involved in identification of the range of alternatives and impacts and the significant issues to be addressed in compliance with statutory requirements.

Draft Environmental Impact Statement

Preparation of the draft EIS follows closely the study of project alternatives and, in this case, the preliminary engineering for those alternatives considered feasible for inclusion in the draft EIS. The draft EIS intended to:

- 1) Provide a detailed description of the JASE project, its purposes, locations, costs, and potential benefits including maps, diagrams, and photographs as needed.
- 2) Include a complete environmental description of the area before start of the project covering natural and physical aspects (in relation to the area's geology, hydrology, biology, land use, and environmental quality) and human aspects (population levels and distributions and human activity patterns).
- 3) Describe the temporary and permanent effects to the natural, physical and human environment due to construction.
- 4) Describe the overall effects to the natural, physical, and human environment due to existence, operation, or use and maintenance of project facilities and/or structures.

- 5) Explore and describe primary and secondary possible environmental effects of the project in terms of industrial and commercial development, population levels and distribution, modes and use of transportation, general patterns of living, and use of municipal and/or federal facilities.
- 6) Include a review of energy-related matters including energy requirements, conservation measures and environmental significance.
- 7) Review visual quality factors of the project.
- 8) Identify historic and cultural resources affected by project (i.e., historic and cultural structures, sites, and districts; archaeological sites and structures).
- 9) Cite applicable state and/or federal air and water quality standards and discuss how air and water quality before, during, and after construction of the project compares to these standards.
- 10) Describe applicable local zoning and other regulatory measures and assess their compatibility with the JASE project. Delineate those permits and approvals necessary for the project.
- 11) Provide adequate determination that the project is consistent with official plans for the comprehensive development of the Downtown area.
- 12) Provide scientific and engineering support for all conclusions reached on environmental consequences of the project and supply, where deemed necessary, copies of complete analyses used in development of such support.

The completed draft EIS is reviewed first by the sponsoring local agency and then is forwarded to the Urban Mass Transit Administration for federal review. When approved by UMTA as being in compliance with the National Environmental Protection Act, authorization is granted for distribution of copies to all interested agencies, organizations, and individuals for review and comments. Availability is announced by a notice in the Federal Register at least 30 days before the required public hearing. In addition to announcing availability of the draft EIS, the required local and Federal Register notices will state the date, time, and location of the public hearing; will establish a time period of at least 45 days for return of comments; and will identify the location where comments are to be sent. Local notice was given in a major newspaper 30 days and again 14 days (with 1/4 page ad) prior to public hearing.

Public Hearing

The purpose of the public hearing is to allow local citizens, organizations, and agencies an opportunity to receive a verbal and pictorial presentation on the draft EIS and to raise questions or other comments

on the findings included in the draft EIS. The interested parties are also advised of locations where the draft EIS is available and encouraged to submit further written comments.

Final Environmental Impact Statement

At the conclusion of the statutory time period allowed for receiving comments on the draft EIS, a final EIS is prepared. This document includes all material contained in the draft EIS, corrected to reflect comments received during the public hearing and review period, and will also identify the preferred alternative, discuss substantive comments received on the draft EIS, and all reasonable alternatives considered, summarize citizen involvement, and include, when appropriate, a description of the procedures to be followed to assure that all environmental mitigation measures are implemented.

The signature of the UMTA approving official on the title page of the final EIS constitutes: UMTA authorization to circulate the final EIS; compliance with Section 14 of the UMT Act; and fulfillment of the grant application requirements of Section 3(d)(1) and (2) and Section 5(h) and 5(i) of the UMT Act. The approval of the final EIS does not commit UMTA to approval of any grant request for future funding of the preferred alternative.

The initial printing of the final EIS will be in sufficient quantity to meet the request for copies which can be reasonably expected from agencies, organizations, and individuals.

SUMMARY OF EFFECTS

Long-Term Beneficial Effects

Operation of the River Crossing ASE would produce long-term beneficial effects, including:

- * The design of ASE structures, especially along Hogan Street and at the Hemming Plaza Station, would enhance the visual characteristics and pedestrian use of the Downtown area. In addition, the stations and guideways would make available unique views of the Downtown area to the ASE patron.
- * Operation of the River Crossing ASE would induce secondary development worth \$102 million, representing 5,600 additional jobs in the Downtown area by 1995 and a growth in annual income of \$53 million.
- * Operation of the River Crossing ASE would induce additional growth in annual retail sales in the Downtown area equivalent to \$32 million in 1995.
- * The River Crossing ASE would provide access between major hotel and convention centers, the commercial district, and the Florida Junior

College Downtown Campus for a total service area employment population of 61,000. About 26,818 person-trips are expected daily by 1985.

- * The 1985 revenue ridership is estimated at 4.4 million annually. At a fare level of \$0.25/ride, this ridership can pay annual operating and maintenance costs.
- * The decrease in travel time possible using the JASE System would allow the elderly and handicapped to significantly expand their mobility and employment access area. In 1970, the Downtown area was estimated to have 3,837 transit-dependent persons.
- * Recent planning efforts by the Downtown Development Authority have identified the River Crossing ASE as a stimulus to residential development plans for the CBD and Southside.
- * By 1995, the River Crossing ASE would increase tax revenues from office property by 12%, from retail property by 7%, and from hotel property by 11%. In addition, 11% induced growth in hotel rooms should generate a similar magnitude of increase in the local option (hotel occupancy) tax.
- * The River Crossing ASE is considered by local transportation plans as the necessary central component of any improved system of regional transportation.

Long-Term Adverse Effects

Operation of the River Crossing ASE would result in long-term adverse effects, including:

- * There would be displacement of approximately 20 employees and 5 businesses. About 6 acres of private land would be transferred into the public domain.
- * The CMSA would discharge small amounts of sanitary effluent and wastewater containing wash solvents, mud, grease, oil, and gasoline.
- * The guideway, piers, and skywalk system and stations would intrude into some views of CBD structures.
- * The intermodal stations would induce traffic congestion and increase bus activity at their locations.
- * Unless properly located, columns adjacent to street intersections may be a distraction to motorists.

Short-Term Beneficial Effects

The short-term beneficial effects of the River Crossing ASE are related to the construction period. During the construction period, about

\$62.2 million would be invested in the local economy to construct the JASE. This investment would directly produce about 731 person-years of construction employment and increase household income by about \$28.7 million. In addition to these direct gains, indirect gains in business activity, employment, and household income would be realized. These indirect gains would be equal to or greater than the initial direct gains.

Short-Term Adverse Effects

Construction of the River Crossing ASE would result in several short-term adverse effects, including:

- * Temporary traffic congestion and pedestrian inconvenience would occur during construction of piers and erection of guideway aerial elements. Some side street parking would be lost as a result of construction.
- * Construction activity and related pedestrian barriers would temporarily affect adjacent businesses.
- * Construction would increase noise levels, vibration, and air pollution around pier locations and station areas.
- * The presence of construction activity would intrude into the existing visual setting along the alignment. The construction impacts would be present for relatively short periods, the longest being at station areas.
- * Short-term impacts on the natural environment would be minor, including the generation of spoil material, increases in erosion and sedimentation, and increases in emissions from construction equipment.
- * Deployment of the River Crossing ASE would require a capital investment of approximately \$62.2 million.

REFERENCES

ENVIRONMENTAL CONSIDERATIONS

1. Robert J. Harmon & Associates, Inc., "Jacksonville ASE Study, Patronage Estimation", August 1981.
2. U.S. Department of Transportation, Urban Mass Transportation Administration; "Land Acquisition and Relocation Assistance Under the Urban Mass Transportation Act of 1965, as amended (Circular C4530.1)", March 1978.
3. Jacksonville Transportation Authority; "Right-of-Way and Relocation Manual"; June 1974.
4. Jacksonville Transportation Authority; Technical Memorandum on the Elderly and Handicapped Plan; Jacksonville Automated Skyway Express, Preliminary Engineering Studies; March 1982.
5. Jacksonville Transportation Authority; Downtown Jacksonville Employment and Development Forecast by Sub-Area and Use Category; Technical Memorandum on P.E. Subtask 8.2, Jacksonville Automated Skyway Express Project; Robert J. Harmon & Associates, Inc., January 26, 1981.
6. Jacksonville Transportation Authority; Identification and Classification of Potential Joint Development Projects, 1981-1995; Technical Memorandum on P.E. Subtask 8.2, Jacksonville Automated Skyway Express Project; Robert J. Harmon & Associates, Inc.; January 26, 1981.
7. Jacksonville Transportation Authority; Final Report on Project Feasibility, Jacksonville Downtown People Mover; November 1979.
8. Jacksonville Transportation Authority; Technical Report No. 5, Environmental Baseline Survey, Jacksonville Downtown People Mover Fasibility and Impact Study; 12/78.
9. Jacksonville Transportation Authority; Technical Report, System Safety, Assurance and Security Plan; Jacksonville Automated Skyway Express Project; Lea, Elliott, McGean & Company; December 1981.
10. Jacksonville Transportation Authority; Design Criteria, Jacksonville Automated Skyway Express Project; January 1981.
11. Congressional Budget Office, Urban Transportation and Energy: The Potential Savings of Different Modes; December 1977.

12. U.S. Environmental Protection Agency, Office of Air and Waste Management; "Guidelines for Air Quality Maintenance Planning and Analysis, Volume 9 (Revised); Evaluating Indirect Sources"; Publication No. EPA-450/4-78-001, Research Triangle Park, North Carolina, 1978.
13. Jacksonville Transportation Authority; Preliminary Geotechnical Exploration; Jacksonville Automated Skyway Express Project; Law Engineering Testing Company; April 1981.

