	GLOBAL STANDARD	Page 1 of 54
	LOW VOLTAGE CONCENTRIC CABLES WITH RATED VOLTAGE $U_0/U(U_m)$ 0,6/1,0 (1,2) kV	GSCC014 Rev. 00 12/2020

**LOW VOLTAGE CONCENTRIC CABLES  
WITH RATED VOLTAGE  $U_0/U(U_m)$  0,6/1,0 (1,2) kV**

Countries I&N	
Argentina	F. Cetrangolo
Brazil	R. Alves
Chile	D. Gonzalez
Colombia	J. C. Gomez
Italy	L. Giansante
Peru	R. Sanchez
Romania	V. Obrejan

	Elaborated by	Verified by	Approved by
Global I&N – O&M/NCS	Filippo Gentili	Jean Pierre Goossens	Maurizio Mazzotti

*This document is intellectual property of ENEL Group distribution companies; reproduction or distribution of its contents in any way or by any means whatsoever is subject to the prior approval of the above mentioned companies which will safeguard their rights under the civil and penal codes. This document is for Internal Use.*

Revision	Date	List of modifications
00	12/2020	First emission

	GLOBAL STANDARD	Page 2 of 54
	LOW VOLTAGE CONCENTRIC CABLES WITH RATED VOLTAGE $U_0/U(U_m)$ 0,6/1,0 (1,2) kV	GSCC014 Rev. 00 12/2020

## INDEX

<b>1</b>	<b>SCOPE.....</b>	<b>5</b>
<b>2</b>	<b>LIST OF COMPONENTS – COMMON LIST.....</b>	<b>5</b>
<b>3</b>	<b>REFERENCE LAWS AND STANDARDS.....</b>	<b>5</b>
<b>3.1</b>	<b>Laws.....</b>	<b>5</b>
<b>3.2</b>	<b>European &amp; International Standards.....</b>	<b>6</b>
<b>3.3</b>	<b>Local Standards.....</b>	<b>7</b>
<b>3.4</b>	<b>Replaced Local Standards.....</b>	<b>7</b>
<b>4</b>	<b>CABLES CLASIFICACION.....</b>	<b>8</b>
<b>5</b>	<b>DESIGN AND MANUFACTURING.....</b>	<b>10</b>
<b>5.1</b>	<b>Conductor.....</b>	<b>10</b>
<b>5.2</b>	<b>Insulation.....</b>	<b>10</b>
5.2.1	Colors.....	11
<b>5.3</b>	<b>Fillers.....</b>	<b>12</b>
5.3.1	Central Fillers.....	12
5.3.2	Overall Fillers.....	12
<b>5.4</b>	<b>Inner covering.....</b>	<b>12</b>
<b>5.5</b>	<b>Concentric Neutral Conductor.....</b>	<b>12</b>
5.5.1	Tape over concentric conductor.....	13
<b>5.6</b>	<b>Outer Sheath.....</b>	<b>13</b>
<b>5.7</b>	<b>Constructive aspects.....</b>	<b>14</b>

	GLOBAL STANDARD	Page 3 of 54
	LOW VOLTAGE CONCENTRIC CABLES WITH RATED VOLTAGE $U_0/U(U_m)$ 0,6/1,0 (1,2) kV	GSCC014 Rev. 00 12/2020

5.7.1	Phase conductor.....	14
5.7.2	Concentric Conductor.....	14
5.7.3	Dimensions.....	15
<b>5.8</b>	<b>Ampacity and Short-circuit rating.....</b>	<b>16</b>
<b>5.9</b>	<b>Cable designation and Markings .....</b>	<b>16</b>
5.9.1	Cable designation .....	16
5.9.2	Markings .....	16
<b>6</b>	<b>TEST CLASSIFICATION.....</b>	<b>16</b>
<b>6.1</b>	<b>Acceptance tests .....</b>	<b>16</b>
6.1.1	Routine tests: .....	16
6.1.2	Sample test .....	17
6.1.3	Sampling and acceptance criteria.....	17
<b>6.2</b>	<b>Type test .....</b>	<b>18</b>
<b>6.3</b>	<b>Tests list .....</b>	<b>19</b>
<b>6.4</b>	<b>Local regulatory requirements .....</b>	<b>24</b>
<b>7</b>	<b>GUARANTEE .....</b>	<b>24</b>
<b>8</b>	<b>CONDITIONS OF SUPPLY.....</b>	<b>24</b>
<b>9</b>	<b>TECHNICAL CHECK-LIST .....</b>	<b>25</b>
<b>9.1</b>	<b>Technical check-list examples .....</b>	<b>27</b>
9.1.1	Type I 1x10+6C cable .....	27
9.1.2	Type II 2x16+10C cable .....	29
9.1.3	Type III 3x25+16C cable .....	31
	<b>LOCAL SECTION A – E-DISTRIBUZIONE (ITALY), E- E-DISTRIBUTIE (ROMANIA).....</b>	<b>33</b>

	GLOBAL STANDARD	Page 4 of 54
	LOW VOLTAGE CONCENTRIC CABLES WITH RATED VOLTAGE $U_0/U(U_m)$ 0,6/1,0 (1,2) kV	GSCC014 Rev. 00 12/2020

<b>LOCAL SECTION B - CODENSA (COLOMBIA)</b> .....	<b>37</b>
<b>LOCAL SECTION C - ENEL DISTRIBUCIÓN CHILE</b> .....	<b>41</b>
<b>LOCAL SECTION D - EDESUR (ARGENTINA)</b> .....	<b>45</b>
<b>LOCAL SECTION E - ENEL DISTRIBUCIÓN PERÚ</b> .....	<b>47</b>
<b>LOCAL SECTION F - ENEL DISTRIBUIÇÃO (BRASIL)</b> .....	<b>50</b>
<b>10 COMMON LIST</b> .....	<b>53</b>

	GLOBAL STANDARD	Page 5 of 54
	LOW VOLTAGE CONCENTRIC CABLES WITH RATED VOLTAGE $U_0/U(U_m)$ 0,6/1,0 (1,2) kV	GSCC014 Rev. 00 12/2020

## 1 SCOPE

This document aims to provide technical requirements for the supply of low voltage concentric cables to be used in the aerial and underground distribution networks in Enel Group Distribution Companies, listed below:

<i>Codensa</i>	<i>Colombia</i>
<i>Enel distribución Perú</i>	<i>Perú</i>
<i>Edesur</i>	<i>Argentina</i>
<i>e-distributie Banat</i>	<i>Romania</i>
<i>e-distributie Dobrogea</i>	<i>Romania</i>
<i>e-distributie Muntenia</i>	<i>Romania</i>
<i>e-distribuzione</i>	<i>Italy</i>
<i>Enel distribución Chile</i>	<i>Chile</i>
<i>Enel Distribuição Ceará</i>	<i>Brazil</i>
<i>Enel Distribuição Rio</i>	<i>Brazil</i>
<i>Enel Distribuição Goiás</i>	<i>Brazil</i>
<i>Enel Distribuição São Paulo</i>	<i>Brazil</i>

This standard specifies the construction, dimensions and test requirements that shall be accomplished by unarmored cables with XLPE insulation, single or multi-core with concentric conductor with rated voltage  $U_0/U(U_{max})= 0,6/1 (1,2)$  kV used in distribution systems by the utilities mentioned above.

This standard replaces all the local standards used up to now by all the Distribution Companies, as long as local regulation allows it.

## 2 LIST OF COMPONENTS – COMMON LIST

The list of components with the main requirements, which is an integral part of the present document, is reported attached at the end of the document.

## 3 REFERENCE LAWS AND STANDARDS

### 3.1 Laws

Brazil

- NR-10 - Segurança em Instalações e Serviços em Eletricidade

Chile

- Pliegos Técnicos Normativos RPTD 1 al 16.
- NCh Elec. 4/2003 Instalaciones de consumo en Baja Tensión.

	GLOBAL STANDARD	Page 6 of 54
	LOW VOLTAGE CONCENTRIC CABLES WITH RATED VOLTAGE $U_0/U(U_m)$ 0,6/1,0 (1,2) kV	GSCC014 Rev. 00 12/2020

#### Colombia

- RETIE, Reglamento Técnico de Instalaciones Eléctricas.
- Código Eléctrico Colombiano, NTC 2050

#### Peru

- Código Nacional de Electricidad – Suministro 2011.
- Norma Técnica de Calidad de los servicios eléctricos (NTCSE)

### 3.2 European & International Standards

- EN 50575 “Power, control and communication cables - Cables for general applications in construction works subject to reaction to fire requirements”
- HD 603 S2 “Distribution cables of rated voltage 0,6/1 kV”
- HD 605 S2 “Electric cables - Additional test methods”
- IEC 60228: “Conductors of insulated cables”
- IEC 60332-1-2 “Tests on electric and optical fibre cables under fire conditions - Part 1-2: Test for vertical flame propagation for a single insulated wire or cable - Procedure for 1 kW pre-mixed flame”
- IEC 60502-1:” Power cables with extruded insulation and their accessories for rated voltages from 1 kV up to 30 kV – Part 1: cables for rated voltages of 1 kV and 3 kV”
- IEC 60811-100 “Electric and optical fibre cables - Test methods for non-metallic materials-Part 100: General”
- IEC 60811-201 “Electric and optical fibre cables - Test methods for non-metallic materials-Part 201: General tests - Measurement of insulation thickness”
- IEC 60811-202 “Electric and optical fibre cables - Test methods for non-metallic materials-Part 202: General tests - Measurement of thickness of non-metallic sheath”
- IEC 60811-203 “Electric and optical fibre cables - Test methods for non-metallic materials-Part 203: General tests - Measurement of overall dimensions”
- IEC 60811-401 “Electric and optical fibre cables - Test methods for non-metallic materials-Part 401: Miscellaneous tests - Thermal ageing methods - Ageing in an air oven”
- IEC 60811-402 “Electric and optical fibre cables - Test methods for non-metallic materials-Part 402: Miscellaneous tests - Water absorption tests”
- IEC 60811-403 “Electric and optical fibre cables - Test methods for non-metallic materials-Part 403: Miscellaneous tests - Ozone resistance tests on cross-linked compounds”
- IEC 60811-409 “Electric and optical fibre cables - Test methods for non-metallic materials Part 409: Miscellaneous tests - Loss of mass test for thermoplastic insulations and sheaths

	GLOBAL STANDARD	Page 7 of 54
	LOW VOLTAGE CONCENTRIC CABLES WITH RATED VOLTAGE $U_0/U(U_m)$ 0,6/1,0 (1,2) kV	GSCC014 Rev. 00 12/2020

- IEC 60811-501 “Electric and optical fibre cables - Test methods for non-metallic materials-Part 501: Mechanical tests - Tests for determining the mechanical properties of insulating and sheathing compounds”
- IEC 60811-502 “Electric and optical fibre cables - Test methods for non-metallic materials Part 502: Mechanical tests - Shrinkage test for insulations
- IEC 60811-504 “Electric and optical fibre cables - Test methods for non-metallic materials-Part 504: Mechanical tests - Bending tests at low temperature for insulation and sheaths”
- IEC 60811-505 “Electric and optical fibre cables - Test methods for non-metallic materials-Part 505: Mechanical tests - Elongation at low temperature for insulations and sheaths”
- IEC 60811-506 “Electric and optical fibre cables - Test methods for non-metallic materials-Part 506: Mechanical tests - Impact test at low temperature for insulations and sheaths”
- IEC 60811-507 “Electric and optical fibre cables - Test methods for non-metallic materials-Part 507: Mechanical tests - Hot set test for cross-linked materials”
- IEC 60811-605 “Electric and optical fibre cables - Test methods for non-metallic materials-Part 605: Physical tests - Measurement of carbon black and/or mineral filler in polyethylene compounds”
- IEC 61034-2 “Measurement of smoke density of cables burning under defined conditions - Part 2: Test procedure and requirements”
- IEC 60754-1 “Test on gases evolved during combustion of materials from cables - Part 1: Determination of the halogen acid gas content”
- IEC 60754-2 “Test on gases evolved during combustion of materials from cables - Part 2: Determination of acidity (by pH measurement) and conductivity”
- IEC 62230 Electric cables - Spark-test method
- ISO 2859-0 “Sampling procedures for inspection by attributes -- Part 0: Introduction to the ISO 2859 attribute sampling system”
- ISO 2859-1 “Sampling procedures for inspection by attributes -- Part 1: Sampling schemes indexed by acceptance quality limit (AQL) for lot-by-lot inspection”

### 3.3 Local Standards

See Local Section.

### 3.4 Replaced Local Standards

See Local Section.

#### 4 CABLES CLASIFICATION

In the following chart a brief description of the different types of cables depicted in this technical specification is given.

TYPE	DESCRIPTION	Layout
I	Single-core concentric cables with aluminum phase conductor, cross-linked polyethylene insulation (XLPE) and polyolefin outer sheath.	Figure 1
II	Two-core concentric cables with aluminum phase conductor, cross-linked polyethylene insulation (XLPE) and polyolefin outer sheath.	Figure 2
III	Three-core concentric cables with aluminum phase conductor, cross-linked polyethylene insulation (XLPE) and polyolefin outer sheath.	Figure 3

**Table 1: Types of Cables**

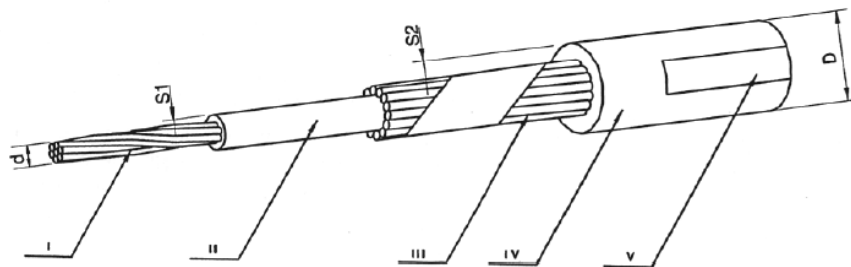

**Key**

- |                            |                |
|----------------------------|----------------|
| I conductor                | IV outersheath |
| II insulation              | V marking      |
| III - concentric conductor |                |

**Figure 1 Type I Single-core LV concentric cables**



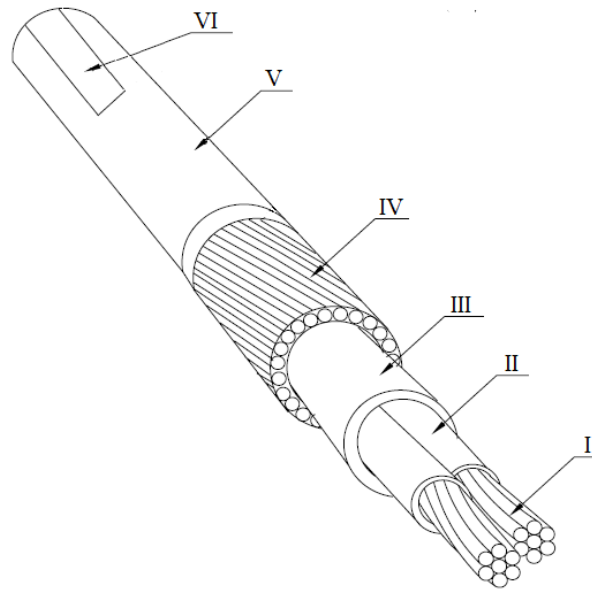

**Key**

- |                                 |                          |
|---------------------------------|--------------------------|
| I. Conductor                    | IV. Concentric conductor |
| II. insulation                  | V.. outersheath          |
| III. Fillers and inner covering | VI. marking              |

**Figure 2 Type II Two-core LV concentric cables.**

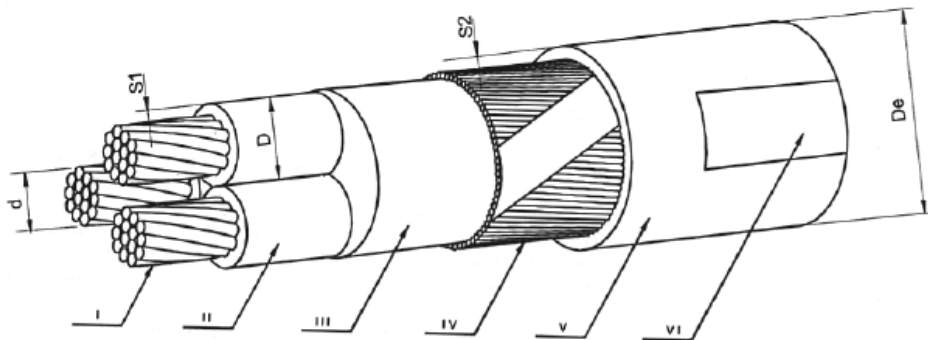

**Key**

- |                                |                         |
|--------------------------------|-------------------------|
| I conductor                    | IV concentric conductor |
| II insulation                  | V outersheath           |
| III fillers and inner covering | VI marking              |

**Figure 3 Type III Three-Core LV concentric Cable.**

**Note: Figures are for illustrative purposes only.**

## 5 DESIGN AND MANUFACTURING

### 5.1 Conductor

For cable types (I, II and III), with a cross-section of 10 mm<sup>2</sup> or less, the aluminum conductors shall be rounded solid class 1, for the other cable cross-sections, the aluminum conductors shall be stranded compacted circular class 2, complying with all the features specified herein and in standard IEC 60228. The conductor material shall be AA-1350 i.e., 99, 5% aluminum content.

For **Codensa** cables the conductor material shall be AA-8000 series and special considerations (See local section).

The conductor shall be regular and exempt from defects, in Table 2 aluminum conductors main features are depicted.

Nominal cross-section [mm <sup>2</sup> ]	Minimum number of wires	Diameter of conductors [mm]		Maximum resistance of conductor at 20°C [Ω/km]
		Minimum	Maximum	
6*	1	2,7	2,9	4,61 <sup>1</sup>
10*	1	3,4	3,7	3,08
16	6	4,6	5,2	1,91
25	6	5,6	6,5	1,20
50	6	7,7	8,6	0,641
95	15	11,0	12,0	0,320
150	15	13,7	15,0	0,206
240	30	17,6	19,2	0,125

(\*) Al. rounded solid class 1

**Table 2 Aluminum conductor characteristics according to IEC 60228.**

### 5.2 Insulation

The insulation shall be applied by a suitable extrusion process, and shall form a compact and homogenous body, it shall not penetrate beyond the external layer of the conductor. In addition, it shall be possible to remove without creating any damage to the conductor.

<sup>1</sup> NM 280:2011 Standard

The insulating material shall be cross-linked polyethylene (XLPE), compliant with the characteristics required herein this document.

The insulation must allow maximum conductor temperatures of 90 °C in normal operation and 250 °C under short circuit condition by at least 5 seconds.

The minimum thickness of insulation measured and accepted at any point of the cable shall not be less than 90% of the nominal value minus 0,1 mm. In addition, the average of all these measures should not be less than the nominal thickness.

$$t_{min} \geq 0,9 t_n - 0,1$$

Where:

$t_{min}$ : minimum insulation thickness in millimeters

$t_n$ : nominal thickness in millimeters

Cross-section [mm <sup>2</sup> ]	Type I Cable		Type II and III Cables	
	Insulation nominal thickness [mm]	Insulation minimum thickness [mm]	Insulation nominal thickness [mm]	Insulation minimum thickness [mm]
6	1,2	0,98	0,7	0,53
10	1,2	0,98	0,7	0,53
16	1,2	0,98	0,7	0,53
25	1,2	0,98	0,9	0,71
35	--	--	0,9	0,71
50	--	--	1	0,8
95	--	--	1,1	0,89
150	--	--	1,4	1,16
240	--	--	1,7	1,43

**Table 3 XLPE insulation thickness**

### 5.2.1 Colors.

See Local Section.

### 5.3 Fillers

#### 5.3.1 Central Fillers

It shall consist of non-hygroscopic textile yarn or by a combination of an extruded compound based on non-vulcanized elastomeric material with textile yarn and that not contaminating insulation and easy to be removed from the cores. The central filler is mandatory for conductor cross-section greater than 25 mm<sup>2</sup>

#### 5.3.2 Overall Fillers

It shall consist of an extruded compound based on non-vulcanized elastomeric material non -hygroscopic and that not contaminating insulation and easy to be removed from the cores. It shall be penetrate between the cores and must allow easy separation of the concentric conductor wires and cover the laid up cores without gaps. It could be replaced by the inner covering

### 5.4 Inner covering

Over the cores assembly shall be applied an inner covering consisting of a cylindrical layer of extruded compound. It shall be based on a non-vulcanized non-hygroscopic elastomeric material and may be extruded or lapped. Optionally, a synthetic tape may be applied helically over the laid up of cores.

### 5.5 Concentric Neutral Conductor.

The concentric conductor shall consist of plain annealed copper wires, with an equalizing plain annealed copper tape, mandatory for Type II and III cables, optional for Type I cables. The minimum number of wires and electrical characteristics for copper is specified in Table 4.

Nominal Cross-section [mm <sup>2</sup> ]	Minimum number of Copper wires [n°]	Minimum diameter of each wire [mm]	Maximum resistance of conductor at 20°C [ohm/km]
6	18	0,5	3,08
10	18	0,6	1,83
16	18	0,7	1,15
25	20	---	0,727
35	30	---	0,524
50	35	---	0,387
95	45	---	0,193

**Table 4 Copper concentric conductor characteristics**

### 5.5.1 Tape over concentric conductor

A non-hygroscopic synthetic tape may be helically applied between the concentric conductor and outer sheath.

### 5.6 Outer Sheath.

The outer sheath shall be resistant to moisture, abrasion and UV. In addition, it shall be free from heavy metals or volatile hydrocarbons.

The outer sheath material shall be polyolefin compliant with the characteristics required herein.

The minimum thickness of the outer sheath measured and accepted at any point of the cable shall not be less than 80% of the nominal value minus 0,2 mm. In addition, the average of all these measures should not be less than the nominal thickness.

$$t_{min} \geq 0,8 t_n - 0,2$$

Where:

$t_{min}$ : minimum insulation thickness in millimeters

$t_n$ : nominal thickness in millimeters

Core Cross-section [mm <sup>2</sup> ]	Type I Cable		Type II Cable		Type III Cable	
	Sheath nominal thickness [mm]	Sheath minimum thickness [mm]	Sheath nominal thickness [mm]	Sheath minimum thickness [mm]	Sheath nominal thickness [mm]	Sheath minimum thickness [mm]
6	1,2	0,76	1,2	0,76	1,4	0,92
10	1,2	0,76	1,2	0,76	1,4	0,92
16	1,4	0,92	--	--	2,0	1,4
25	1,6	1,08	--	--	2,0	1,4
35	--	--	--	--	2,0	1,4
50	--	--	--	--	2,0	1,4
95	--	--	--	--	2,0	1,4
150	--	--	--	--	2,2	1,56
240	--	--	--	--	2,4	1,72

**Table 5 PO Outer sheath thickness**

Unless otherwise indicated in the local sections and common list the outer sheath color shall be black.

## 5.7 Constructive aspects.

### 5.7.1 Phase conductor

#### 5.7.1.1 Laying up of cores

For Type II and III cables, cores shall be helically assembled with left hand lay. The pitch being:

- for cables having conductor section up to and including 25 mm<sup>2</sup>: not more than 15 times the maximum outer cable diameter specified ( $D_e$  fig 3 )
- For cables with a higher conductor cross-section, not less than 1.3 times the concentric conductor pitch.

### 5.7.2 Concentric Conductor

For cables having a phase conductor cross-section up to and including 50 mm<sup>2</sup>, the concentric wires shall be applied in the form of a continuous helix or in the form of helix with a sense of rotation periodically inverted having a pitch not exceeding 15 times the outer maximum cable diameter ( $D_e$  fig 3, D fig 1). The ratio between the length of straightened wires and the length of the cable shall be greater than 1,03 for Type II and Type III cables or 1,02 for Type I cables.

For cable having a phase conductor cross-section higher than 50 mm<sup>2</sup>, the concentric wires shall be applied in the form of a helix with a sense of rotation periodically inverted: the period of the resulting sinusoids shall not be greater than table 6.2

Formation	Stranding Type	Period of the resulting sinusoids
1 x 6 + 6 C	UNIDIRECTIONAL (1)	160 mm
1 x 10 + 6 C		160 mm
1 x 16 + 10 C		200 mm
1 x 25 + 16 C		220 mm
2 x 10 + 6C		250 mm
2 x 16 + 10C		300 mm
3 x 10 + 6 C		300 mm
3 x 16 + 10 C		350 mm
3 x 25 + 16 C		400 mm
3 x 50 + 25 C		500 mm

**Table 6.1 Referential Period of the resulting sinusoids**

(1): The concentric wires can also be applied in the form of a helix with a sense of rotation periodically inverted, with a ratio between the length of straightened wires and the corresponding cable length  $\geq 1,03$ .

Formation	Stranding Type	Period of the resulting sinusoids
3 x 95 + 35 C	CEANDER (2)	450 mm
3 x 150 + 50 C		500 mm
3 x 240 + 95 C		500 mm

**Table 6.2 Period of the resulting sinusoids**

(2): With wire  $\varnothing \geq 0,8$  mm and wire length ratio straightened and the corresponding cable length  $\geq 1,05$ .

The equalizing tape, if any, shall be applied helically. For helically applied concentric wires it should be in the opposite direction.

### 5.7.3 Dimensions

The reference dimensions are shown in tables 7, 8 and Figures 4, 5, and 6.

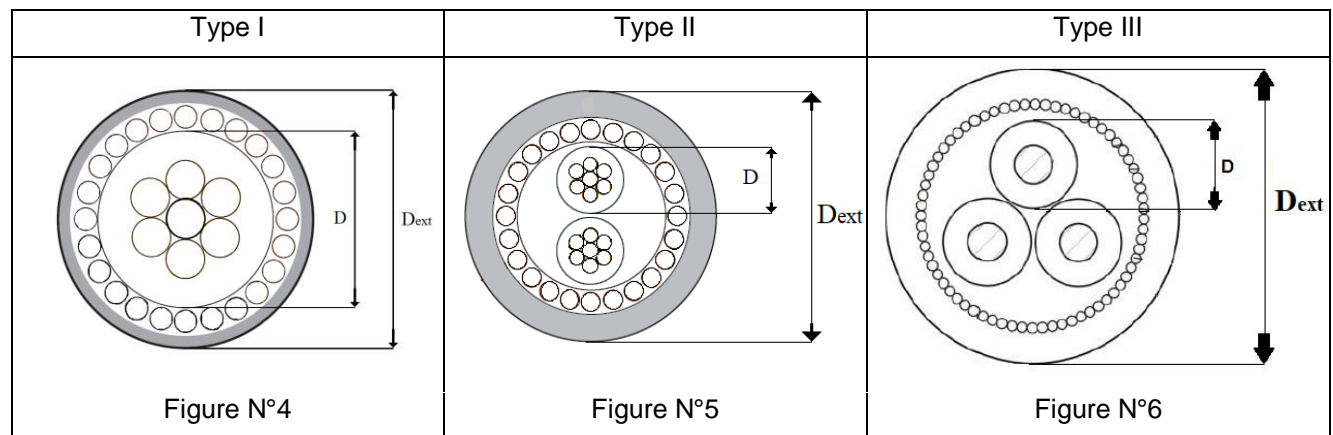

Cable Type	Formation [n° x mm <sup>2</sup> ]	D [mm]	Outer Diameter ( $D_{ext}$ )		Total Mass [kg/km]
			Min [mm]	Max [mm]	
Type I	1 X 6 + 6C	5.1	8.6	12.3	160
	1 X 10 + 6C	5,9	9.4	13.2	170
	1 X 16 + 10C	7.3	10.7	14.5	220
	1 x 25 + 16C	8.5	12.3	16.2	380

**Table 7 referential dimensions and referential weight**

Cable Type	Formation [n° x mm <sup>2</sup> ]	D [mm]	Outer Diameter ( $D_{ext}$ )		Total Mass [kg/km]
			Min [mm]	Max [mm]	
Type II	2 x 10 + 6C	5,0	12,0	14,3	310
	2 x 16 + 10C	6,3	14,8	17,7	400
Type III	3 x 10 + 6C	5,0	17,1	21,0	440
	3 x 16 + 10C	6,3	21,6	25,9	700
	3 x 25 + 16C	7,8	25,1	29,6	1000
	3 x 50 + 25C	10,1	30,2	34,7	1500
	3 x 95 + 35 C	13,6	37,9	42,4	2500
	3 x 150 + 50 C	17,0	46,6	51,5	3650
	3 x 240 + 95 C	21,7	58,7	64,3	6000

**Table 8 referential dimensions and referential weight**

## 5.8 Ampacity and Short-circuit rating

See local section

## 5.9 Cable designation and Markings

### 5.9.1 Cable designation

See Local Section.

### 5.9.2 Markings

The marking shall be indelible, easily legible and carried out by engraving or in relief above the surface of the outer sheath in a continuous way.

## 6 TEST CLASSIFICATION

### 6.1 Acceptance tests

Acceptance tests (routine tests and sample tests) shall be carried out in the Supplier's facilities.

#### 6.1.1 Routine tests:

Routine tests shall be performed at 100% of delivered spools



	GLOBAL STANDARD	Page 17 of 54
	LOW VOLTAGE CONCENTRIC CABLES WITH RATED VOLTAGE $U_0/U(U_m)$ 0,6/1,0 (1,2) kV	GSCC014 Rev. 00 12/2020

### 6.1.2 Sample test

Sample tests are carried out over samples taken from a complete cable (See Table 6 in sub-clause 6.1.3 for sampling).

### 6.1.3 Sampling and acceptance criteria

The supplier shall perform the sampling tests following a single sampling plan for normal inspection, AQL=1,5%, Level I in compliance with standard ISO 2859-1, as long as the resulting minimum number of samples (8) does not exceed 25% of the total lot size. In such case, the number of samples shall be 25% of the total lot size rounded down to the nearest unit.

The routine tests shall be performed at 100% of delivered spool.

Tests performed during the production process on semi-finished products may also be considered valid, as acceptance test, if:

- the tests are performed as required by the relevant technical specifications and technical standards;
- the sampling plans adopted by the Supplier are in compliance with the aforementioned ones;
- the performed test results are properly recorded;
- The supplier demonstrates that the low voltage concentric cable features do not vary during further production phases after the test.

The reports of the acceptance tests performed by the supplier shall be prepared and retained, for a possible verification by Enel inspectors.

The supplier shall be available to repeat the tests in the presence of Enel's Inspector, on a "reduced" sample of the supply lot, defined as follows:

- Routine test: the minimum between a single sampling plan for normal inspection, AQL=1%, Level I and 1/3 of the total number of delivered spools (rounded down to the nearest unit);
- Sample test: 1/2 of the sampling (rounded down to the nearest unit) already adopted for the sample test independently performed by the supplier (Enel inspector can choose to perform the test on spools already tested by the Supplier or on others from the lot).

In case of repetition of routine test attended by Enel Inspector, the spark test is not applicable

The negative result of a single test will result in the rejection of the lot or, when possible, in the repetition of the test on all the units, in order to accept only the compliant ones. If only a single spool is purchased, it shall be tested according to what is indicated for a single sample.

	GLOBAL STANDARD	Page 18 of 54
	LOW VOLTAGE CONCENTRIC CABLES WITH RATED VOLTAGE $U_0/U(U_m)$ 0,6/1,0 (1,2) kV	GSCC014 Rev. 00 12/2020

On a spool among those subjected to the electrical resistance measurement, shall be performed the verification of the total length of the cable, that shall be not shorter than that declared by the supplier by more than 0,5 m.

## 6.2 Type test

Type tests shall be performed before supplying a type of cable covered by this standard in order to demonstrate satisfactory performance characteristics to meet the intended application.

Cable samples to be submitted to type test must have passed positively all routine and sample test.

When type tests have been successfully performed on one type cable covered herein with a specific cross-section and construction characteristics, the type approval shall be accepted as valid for as long as the following conditions are met:

- a) The conductor cross-section is not larger than that of the tested cable.
- b) The cable as similar constructions as that of the tested cable, i.e. utilizes same materials, (conductor, insulation, outer sheath) and the same manufacturing process.

When design, materials or manufacturing process of the cable are changed (which might affect the performance characteristics of the cable), type approval shall be repeated.

**Cables shall undergo type tests and acceptance tests** for type approval.

### 6.3 Tests list

N°	Test	Requirements	Test Method	R	S	T
1	Electrical resistance of phase conductor	Table 2	IEC 60502-1 Sub-Clause 15.2	X	-	-
2	Electrical resistance <sup>2</sup> of concentric conductor on a complete cable length	Table 5 when tested according to HD 605 Sub-clause 3.1.1 and 110 % of the same value when tested according to HD 605 Sub-clause 3.1.4.2	HD 605 Sub-Clause 3.1.4/3.1.1	X	-	-
3	Voltage Test on complete cable Test voltage Voltage applied duration Test Result	4 kV 15 min No breakdown	IEC 60502-1 Sub-Clause 15.3.3	X	-	-
4	Outer sheath voltage test (Spark test) during manufacturing	No breakdown	IEC 62230	X	-	-
5	Conformity to the approved type	See clause 5	Constructional characteristics, markings colors, and phase identification shall be inspected by visual examination. Dimensions, thickness, pitches and diameters shall be measured according to IEC 60811 parts 201, 202 and 203.	-	X	-

<sup>2</sup> The electrical resistance shall be measured according to both Sub-clauses 3.1.1 and 3.1.4.2 of HD 605

	GLOBAL STANDARD	Page 20 of 54
	LOW VOLTAGE CONCENTRIC CABLES WITH RATED VOLTAGE $U_0/U(U_m)$ 0,6/1,0 (1,2) kV	GSCC014 Rev. 00 12/2020

N°	Test	Requirements	Test Method	R	S	T
6	Conductor mass per unit length Test carried out on a phase conductor	The value shall be recorded	HD 605 sub-clause 2.1.13.1 or equivalent standard	-	-	X
7	Durability of markings	Markings shall be durable	HD 605 sub-clause 2.5.4	-	X	-
8	Compression test on the complete cable	No breakdown shall occur during the voltage test	HD 605 sub-clause 2.2.3	-	X	-
9	Mechanical properties of XLPE Before ageing Minimum tensile strength Minimum elongation at break	12,5 Mpa 200%	IEC 60811-501	-	X	-
10	XLPE mechanical properties After ageing Temperature Duration T1 Minimum tensile strength Maximum variation T1/T0 Minimum elongation at break Maximum variation T1/T0	135 °C 168 h ±25% ±25%	IEC 60811-501 IEC 60811-401	-	-	X
11	Hot set test of XLPE Temperature Duration Mechanical stress Maximum elongation under load Maximum residual elongation	200 °C 15 min 0,2 Mpa 175% 15%	IEC 60811-507	-	X	-
12	Insulation resistance at 20 °C Water immersion duration Insulation constant $K_i$ [ $M\Omega \cdot km$ ]	1 h $\geq 10^4$	IEC 60502-1 sub-clause 17.1	-	X	-
13	Insulation resistance at 90 °C Water immersion duration Volume resistivity [ $\Omega \cdot cm$ ]	2 h $\geq 10^{12}$	IEC 60502-1 sub-clause 17.2	-	-	X
14	XLPE Shrinkage test Duration Temperature Maximum shrinkage	1 h 130 °C 4%	IEC 60811-502	-	-	X

N°	Test	Requirements	Test Method	R	S	T
15	XLPE Water absorption test (Gravimetric method) Temperature Duration Maximum variation of mass	85 °C 336 h 5 mg/cm <sup>2</sup>	IEC 60811-402	-	-	X
16	PO Mechanical properties Before ageing on sample Minimum tensile strength Minimum elongation at break	12,5 MPa 300%	IEC 60811-501	-	X	-
17	PO mechanical properties After ageing on sample Temperature Duration <i>Minimum Tensile strength</i> Maximum variation T1/T0 <i>Minimum elongation at break</i> Maximum variation T1/T0	110±2 °C 168 h ±25% ±25%	IEC 60811-501 IEC 60811-401	-	-	X
18	PO pressure test at high temperature Duration Temperature Coefficient k Maximum depth of indentation	6 h 105±2 °C 0,6/0,7 50%	IEC 60811-508	-	-	X
19	PO test at low temperature When cable D>12,5 mm Elongation test Temperature Minimum elongation When cable D≤12,5 mm Bending test Temperature	-15±2°C 20% -15±2°C	IEC 60811-505 IEC 60811-504	-	-	X
20	PO Water absorption test (Gravimetric method) Temperature Duration Maximum variation of mass	85±2 °C 336 h 5 mg/cm <sup>2</sup>	IEC 60811-402	-	-	X

N°	Test	Requirements	Test Method	R	S	T
21	PO UV ray resistance test Tensile strength max variation Elongation at break max variation Decoloration	15% 15% Low	HD 605 Sub clause 2.4.23	-	-	X
22	PO tear resistance test Temperature Minimum resistance	20±5 °C 9 N/mm	HD 605 Sub clause 2.2.2.2	-	-	X
23	PO loss of mass test Temperature Duration Maximum loss of mass	100±2 °C 168 h 0,5 mg/cm <sup>2</sup>	IEC 60811-409	-	-	X
24	PO Heavy metals content test Lead	<0,5%	Spectrophotometer	-	-	X
25	PO halogen acid gas content	≤ 5 mg/g	IEC 60754-1	-	-	X
26	PO gas acidity and conductivity Minimum pH Maximum conductivity	4,3 10 μS/mm,	IEC 60754-2	-	-	X
27	Special bending test  Sample length : 3,5 times the bending diameter Preconditioning temperature: (0 ± 3) °C for a time in min not less than twice the cable diameter in mm, with a minimum of 1 h. It is allowed to precondition. The cable sample just bent on the cylinder.  Cylinder diameter: 16(D + d); tolerance: (0 ± 5) % D = diameter of cable d = diameter of conductor  Electrical test: after the bending cycles the cable shall be bent in U form then immersed in water and submitted to AC test at 4U <sub>0</sub> + 2,5 kV for 10 min leaving the cable ends in air.	No breakdown shall occur during the voltage test. After the electrical test, starting from the center of the sample length, a length of 18D shall be carefully taken apart and examined. No breaks of the insulated conductors, of the concentric conductors, of the insulation and of the over sheath shall be found	HD 605 2.4.1.1	-	-	X

	GLOBAL STANDARD	Page 23 of 54
	LOW VOLTAGE CONCENTRIC CABLES WITH RATED VOLTAGE $U_0/U(U_m)$ 0,6/1,0 (1,2) kV	GSCC014 Rev. 00 12/2020

N°	Test	Requirements	Test Method	R	S	T
28	Cold impact test (Complete cable)  Temperature  Test Result	-15±2 °C  No cracks	IEC 60811-506	-	-	X
29	Shrinkage test (Complete cable)  L Duration Temperature Maximum shrinkage	200 mm 5 x 5 h 80±2 °C 4%	IEC 60811-503	-	-	X
30	Non contamination test (Complete cable) XLPE Insulation  Temperature Duration T2 <i>Tensile strength</i> Max variation T2/T0 <i>Elongation at break</i> Max variation T2/T0  PO Mechanical properties Temperature Duration T1 <i>Minimum elongation at break</i> Maximum variation T1/T0	100 °C 168 h  ±25%  ±25%  110±2 °C 168 h ±25%	IEC 60811-501 IEC 60811-401 sub clause 4.2.3.4	-	-	X
31	Carbon black content	2,5%±0,5%	IEC 60811-605	-	-	X
32	High voltage test (On complete cable)  Sample length approx. Duration of immersion Test voltage Voltage applied duration Test result	≥ 5 m 24 h 2,4 kV 30 min No breakdown	IEC 60502-1, Sub-clause 17.3 by water immersion as applicable. The test voltage shall be applied between all conductors in parallel and water	-	-	X

	GLOBAL STANDARD	Page 24 of 54
	LOW VOLTAGE CONCENTRIC CABLES WITH RATED VOLTAGE $U_0/U(U_m)$ 0,6/1,0 (1,2) kV	GSCC014 Rev. 00 12/2020

N°	Test	Requirements	Test Method	R	S	T
33	Reaction to fire test (Complete cable)  Upper limit Lower limit	$E_{ca}$ for Europe.  $\geq 50$ mm $\geq 540$ mm	EN 50575  IEC 60332-1-2	-	-	X
34	Measurement of smoke density (Complete cable) Minimum light transmittance	60%	IEC 61034-2	-	-	X
R: Routine test S: Sample test T: Type test						

#### 6.4 Local regulatory requirements

See Local Section.

#### 7 GUARANTEE

Requirement of warranty will be indicated in the bid request, including periods and standards.

#### 8 CONDITIONS OF SUPPLY

See in Local Section



	GLOBAL STANDARD	Page 25 of 54
	LOW VOLTAGE CONCENTRIC CABLES WITH RATED VOLTAGE $U_0/U(U_m)$ 0,6/1,0 (1,2) kV	GSCC014 Rev. 00 12/2020

## 9 TECHNICAL CHECK-LIST

The following chart indicates the minimum technical information that suppliers shall give before the tender.

Item	Description	Unit	Required	Offered
<b>1</b>	<b>GENERAL INFORMATION</b>			
1.1	Supplier	-	Manufacturer information	Manufacturer information
1.2	Country	-	Manufacturer information	Manufacturer information
1.3	Factory	-	Manufacturer information	Manufacturer information
<b>2</b>	<b>MAIN FEATURES</b>			
2.1	Distribution Company and Country	-		
2.2	Country Code	-		
2.3	GS Type Code			
2.4	Rated Voltage $U_0/U$ ( $U_{max}$ )	[kV]		
2.5	Type	-		
2.6	Disposition	[n xmm <sup>2</sup> ]		
<b>3</b>	<b>PHASE CONDUCTOR</b>			
3.1	Material	-		
3.2	Nominal cross-section	[mm <sup>2</sup> ]		
3.3	Stranding Type			
3.4	Minimum Number of Wires of Conductor	-		
3.5	Minimum diameter	[mm]		
3.6	Maximum diameter	[mm]		
3.7	Maximum resistance of conductor at 20°C	[Ω/ km]		
<b>4</b>	<b>INSULATION</b>			
4.1	Material	-		
4.2	Nominal thickness	[mm]		
4.3	Minimum thickness	[mm]		
4.4	Color (Core 1 / Core 2 / Core 3)	-		
4.5	Minimum insulation resistance at 20 °C	MΩ x m		
4.6	Minimum elongation at break Before ageing	%		
4.7	Minimum tensile strength Before ageing	MPa		

	GLOBAL STANDARD	Page 26 of 54
	LOW VOLTAGE CONCENTRIC CABLES WITH RATED VOLTAGE $U_0/U(U_m)$ 0,6/1,0 (1,2) kV	GSCC014 Rev. 00 12/2020

Item	Description	Unit	Required	Offered
5	<b>CONCENTRIC CONDUCTOR</b>			
5.1	Material	-		
5.2	Nominal section	[mm <sup>2</sup> ]		
5.3	Minimum number of wires	-		
5.4	Minimum diameter of each wire	mm		
5.5	Maximum resistance D.C. 20°C	Ω/km		
6	<b>OUTER SHEATH</b>			
6.1	Material	-		
6.2	Nominal thickness	[mm]		
6.3	Minimum thickness	[mm]		
6.4	Minimum elongation at break Before ageing	%		
6.5	Minimum tensile strength Before ageing	MPa		
6.6	Color			
7.5	Carbon black content	%		
7	<b>ADDITIONAL INFORMATION</b>			
7.1	Maximum total diameter	[mm]		
7.2	Ampacity (See clause 5.7 for conditions)	[A]		
7.3	Weight per unit of length	[kg/km]		
7.4	Bending Radius	[m]		
7.5	Fire resistance Class			
8	<b>CONDITION OF SUPPLY</b>			
8.1	Package type			
8.2	Drum Type	-		
8.3	Total length	[m]		
8.4	Total Weight	[Kg]		

	GLOBAL STANDARD	Page 27 of 54
	LOW VOLTAGE CONCENTRIC CABLES WITH RATED VOLTAGE $U_0/U(U_m)$ 0,6/1,0 (1,2) kV	GSCC014 Rev. 00 12/2020

## 9.1 Technical check-list examples

### 9.1.1 Type I 1x10+6C cable

Item	Description	Unit	Required	Offered
<b>1</b>	<b>GENERAL INFORMATION</b>			
1.1	Supplier	-	Manufacturer information	Manufacturer information
1.2	Country	-	Manufacturer information	Manufacturer information
1.3	Factory	-	Manufacturer information	Manufacturer information
<b>2</b>	<b>MAIN FEATURES</b>			
2.1	Distribution Company and Country	-	EE-ROMANIA	
2.2	Country Code	-	330022	
2.3	GS Type Code		GSCC014/003	
2.4	Rated Voltage $U_0/U$ ( $U_{max}$ )	[kV]	0.6/1.0	
2.5	Type	-	Type I	
2.6	Disposition	[n xmm <sup>2</sup> ]	1x10+6C	
<b>3</b>	<b>PHASE CONDUCTOR</b>			
3.1	Material	-	Aluminum	
3.2	Nominal cross-section	[mm <sup>2</sup> ]	10	
3.3	Stranding Type		Rounded solid class 1	
3.4	Minimum Number of Wires of Conductor	-	1	
3.5	Minimum diameter	[mm]	3,4	
3.6	Maximum diameter	[mm]	3,7	
3.7	Maximum resistance of conductor at 20°C	[Ω/ km]	3,08	
<b>4</b>	<b>INSULATION</b>			
4.1	Material	-	XLPE	
4.2	Nominal thickness	[mm]	1,2	
4.3	Minimum thickness	[mm]	0,98	
4.4	Color (Core 1 / Core 2 / Core 3)	-	Black	
4.5	Minimum insulation resistance at 20 °C	MΩ x m	≥10 <sup>4</sup>	
4.6	Minimum elongation at break Before ageing	%	200	
4.7	Minimum tensile strength Before ageing	MPa	12,5	

	GLOBAL STANDARD	Page 28 of 54
	LOW VOLTAGE CONCENTRIC CABLES WITH RATED VOLTAGE $U_0/U(U_m)$ 0,6/1,0 (1,2) kV	GSCC014 Rev. 00 12/2020

Type I 1x10+6C cable (continuation)

Item	Description	Unit	Required	Offered
5	<b>CONCENTRIC CONDUCTOR</b>			
5.1	Material	-	Copper	
5.2	Nominal section	[mm <sup>2</sup> ]	6	
5.3	Minimum number of wires	-	18	
5.4	Minimum diameter of each wire	mm	0,5	
5.5	Maximum resistance D.C.,20°C	Ω/km	3,08	
6	<b>OUTER SHEATH</b>			
6.1	Material	-	PO	
6.2	Nominal thickness	[mm]	1,2	
6.3	Minimum thickness	[mm]	0,76	
6.4	Minimum elongation at break Before ageing	%	200	
6.5	Minimum tensile strength Before ageing	MPa	12,5	
6.6	Color		Gray	
7.5	Carbon black content	%	2,5%±0,5	
7	<b>ADDITIONAL INFORMATION</b>			
7.1	Maximum total diameter	[mm]	Informative	
7.2	Ampacity (See clause 5.7 for conditions)	[A]	Calculated	
7.3	Weight per unit of length	[kg/km]	Informative	
7.4	Bend Radius	[m]	Informative	
7.5	Fire resistance Class		Eca	
8	<b>CONDITION OF SUPPLY</b>			
8.1	Package type		Informative	
8.2	Drum Type	-	Informative	
8.3	Total length	[m]	Informative	
8.4	Total Weight	[Kg]	Informative	

	GLOBAL STANDARD	Page 29 of 54
	LOW VOLTAGE CONCENTRIC CABLES WITH RATED VOLTAGE $U_0/U(U_m)$ 0,6/1,0 (1,2) kV	GSCC014 Rev. 00 12/2020

### 9.1.2 Type II 2x16+10C cable

Item	Description	Unit	Required	Offered
<b>1</b>	<b>GENERAL INFORMATION</b>			
1.1	Supplier	-	Manufacturer information	Manufacturer information
1.2	Country	-	Manufacturer information	Manufacturer information
1.3	Factory	-	Manufacturer information	Manufacturer information
<b>2</b>	<b>MAIN FEATURES</b>			
2.1	Distribution Company and Country	-	ED-PERU	
2.2	Country Code	-	330017	
2.3	GS Type Code		GSCC014/6	
2.4	Rated Voltage $U_0/U(U_{max})$	[kV]	0.6/1.0	
2.5	Type	-	Type II	
2.6	Disposition	[n xmm <sup>2</sup> ]	2x16+10C	
<b>3</b>	<b>PHASE CONDUCTOR</b>			
3.1	Material	-	Aluminum	
3.2	Nominal cross-section	[mm <sup>2</sup> ]	16	
3.3	Stranding Type		Compacted circular class 2	
3.4	Minimum Number of Wires of Conductor	-	6	
3.5	Minimum diameter	[mm]	4,6	
3.6	Maximum diameter	[mm]	5,2	
3.7	Maximum resistance of conductor at 20°C	[Ω/ km]	1,91	
<b>4</b>	<b>INSULATION</b>			
4.1	Material	-	XLPE	
4.2	Nominal thickness	[mm]	0,7	
4.3	Minimum thickness	[mm]	0,53	
4.4	Color (Core 1 / Core 2 / Core 3)	-	Black/Blue	
4.5	Minimum insulation resistance at 20 °C	MΩ x m	≥10 <sup>4</sup>	
4.6	Minimum elongation at break Before ageing	%	200	
4.7	Minimum tensile strength Before ageing	MPa	12,5	

	GLOBAL STANDARD	Page 30 of 54
	LOW VOLTAGE CONCENTRIC CABLES WITH RATED VOLTAGE $U_0/U(U_m)$ 0,6/1,0 (1,2) kV	GSCC014 Rev. 00 12/2020

Type II 2x16+10C cable (Continuation)

Item	Description	Unit	Required	Offered
5	<b>CONCENTRIC CONDUCTOR</b>			
5.1	Material	-	Copper	
5.2	Nominal section	[mm <sup>2</sup> ]	10	
5.3	Minimum number of wires	-	18	
5.4	Minimum diameter of each wire	mm	0,7	
5.5	Maximum resistance D.C.,20°C	Ω/km	1,83	
6	<b>OUTER SHEATH</b>			
6.1	Material	-	PO	
6.2	Nominal thickness	[mm]	1,4	
6.3	Minimum thickness	[mm]	0,92	
6.4	Minimum elongation at break Before ageing	%	200	
6.5	Minimum tensile strength Before ageing	MPa	12,5	
6.6	Color		Black	
7.5	Carbon black content	%	2,5%±0,5	
7	<b>ADDITIONAL INFORMATION</b>			
7.1	Maximum total diameter	[mm]	Informative	
7.2	Ampacity (See clause 5.7 for conditions)	[A]	Calculated	
7.3	Weight per unit of length	[kg/km]	Informative	
7.4	Bend Radius	[m]	Informative	
7.5	Fire resistance Class		Eca	
8	<b>CONDITION OF SUPPLY</b>			
8.1	Package type		Informative	
8.2	Drum Type	-	Informative	
8.3	Total length	[m]	Informative	
8.4	Total Weight	[Kg]	Informative	

	GLOBAL STANDARD	Page 31 of 54
	LOW VOLTAGE CONCENTRIC CABLES WITH RATED VOLTAGE $U_0/U(U_m)$ 0,6/1,0 (1,2) kV	GSCC014 Rev. 00 12/2020

### 9.1.3 Type III 3x25+16C cable

Item	Description	Unit	Required	Offered
<b>1</b>	<b>GENERAL INFORMATION</b>			
1.1	Supplier	-	Manufacturer information	Manufacturer information
1.2	Country	-	Manufacturer information	Manufacturer information
1.3	Factory	-	Manufacturer information	Manufacturer information
<b>2</b>	<b>MAIN FEATURES</b>			
2.1	Distribution Company and Country	-	ED-ITALIA	
2.2	Country Code	-	330023	
2.3	GS Type Code		GSCC014/8	
2.4	Rated Voltage $U_0/U(U_{max})$	[kV]	0,6/1,0	
2.5	Type	-	Type III	
2.6	Disposition	[n xmm <sup>2</sup> ]	3x25+16C	
<b>3</b>	<b>PHASE CONDUCTOR</b>			
3.1	Material	-	Aluminum	
3.2	Nominal cross-section	[mm <sup>2</sup> ]	25	
3.3	Stranding Type		Compacted circular class 2	
3.4	Minimum Number of Wires of Conductor	-	6	
3.5	Minimum diameter	[mm]	5,6	
3.6	Maximum diameter	[mm]	6,5	
3.7	Maximum resistance of conductor at 20°C	[Ω/ km]	1,2	
<b>4</b>	<b>INSULATION</b>			
4.1	Material	-	XLPE	
4.2	Nominal thickness	[mm]	0,9	
4.3	Minimum thickness	[mm]	0,71	
4.4	Color (Core 1 / Core 2 / Core 3)	-	Black/Brown/Ligth Blue	
4.5	Minimum insulation resistance at 20 °C	MΩ x m	≥10 <sup>4</sup>	
4.6	Minimum elongation at break Before ageing	%	200	
4.7	Minimum tensile strength Before ageing	MPa	12,5	

	GLOBAL STANDARD	Page 32 of 54
	LOW VOLTAGE CONCENTRIC CABLES WITH RATED VOLTAGE $U_0/U(U_m)$ 0,6/1,0 (1,2) kV	GSCC014 Rev. 00 12/2020

Item	Description	Unit	Required	Offered
5	<b>CONCENTRIC CONDUCTOR</b>			
5.1	Material	-	Copper	
5.2	Nominal section	[mm <sup>2</sup> ]	16	
5.3	Minimum number of wires	-	18	
5.4	Minimum diameter of each wire	mm	Informative	
5.5	Maximum resistance D.C.,20°C	Ω/km	1,83	
6	<b>OUTER SHEATH</b>			
6.1	Material	-	PO	
6.2	Nominal thickness	[mm]	2,0	
6.3	Minimum thickness	[mm]	1,4	
6.4	Minimum elongation at break Before ageing	%	200	
6.5	Minimum tensile strength Before ageing	MPa	12,5	
6.6	Color		Gray	
7	<b>ADDITIONAL INFORMATION</b>			
7.1	Maximum total diameter	[mm]	Informative	
7.2	Ampacity (See clause 5.7 for conditions)	[A]	Calculated	
7.3	Weight per unit of length	[kg/km]	Informative	
7.4	Bend Radius	[m]	Informative	
7.5	Carbon black content	%	2,5%±0,5	
8	<b>CONDITION OF SUPPLY</b>			
8.1	Package type		Informative	
8.2	Drum Type	-	Informative	
8.3	Total length	[m]	Informative	
8.4	Total Weight	[Kg]	Informative	



	GLOBAL STANDARD	Page 33 of 54
	LOW VOLTAGE CONCENTRIC CABLES WITH RATED VOLTAGE $U_0/U(U_m)$ 0,6/1,0 (1,2) kV	GSCC014 Rev. 00 12/2020

### LOCAL SECTION A – E-DISTRIBUZIONE (ITALY), E- E-DISTRIBUTIE (ROMANIA)

ITEM	TITLE	DESCRIPTION																																						
3.3	Local Standards	<p><u>e-distribuzione (Italy), e-distributie (Romania)</u></p> <ul style="list-style-type: none"> <li>Standard PVR 006 Operational Note Vendor Rating Control: BARCODES Warranty and Traceability of Enel Distribution Materials.</li> <li>GUI 102 “Bobine per il trasporto di cavi elettrici, cavi ottici e conduttori per le linee elettriche di media e bassa tensione”</li> </ul>																																						
3.4	Replaced Local Standards	<p><u>e-distribuzione (Italy), e-distributie (Romania)</u></p> <ul style="list-style-type: none"> <li>DC4125/DC4125 RO</li> <li>DC4126/DC4126 RO</li> </ul>																																						
5.7	Ampacity and Short-circuit rating	<p><u>e-distribuzione (Italy), e-distributie (Romania)</u></p> <p>The ampacity and short-circuit rating <b>estimated</b> values shall be given for network design purposes.</p> <p>Such currents shall be calculated in steady state condition when installed in air using the following operational conditions:</p> <ul style="list-style-type: none"> <li>Maximum phase conductor temperature 90 °C</li> <li>Maximum concentric conductor temperature 90 °C</li> <li>Ambient air temperature 40 °C</li> <li>Ground temperature 20 °C</li> <li>Wind speed 2 km/h</li> <li>Solar radiation intensity <math>10^3</math> W/m<sup>2</sup></li> <li>Depth of laying 0,8 m</li> <li>Soil thermal resistivity 1,5 K m/W</li> </ul> <p>For short-circuit capacity the following reference values could be used:</p> <table border="1" style="width: 100%; border-collapse: collapse;"> <thead> <tr> <th rowspan="2">Formation [n° x mm<sup>2</sup>]</th> <th colspan="2">Short circuit rating</th> </tr> <tr> <th>Central Conductor [kA]</th> <th>Concencentric conductor [kA]</th> </tr> </thead> <tbody> <tr><td>1x10+6C</td><td>0,9</td><td>0,8</td></tr> <tr><td>1x25+16C</td><td>2,4</td><td>2</td></tr> <tr><td>3x10+6C</td><td>0,8</td><td>0,8</td></tr> <tr><td>3x25+16C</td><td>2,2</td><td>2,0</td></tr> <tr><td>3x50+25C</td><td>3,5</td><td>2,5</td></tr> <tr><td>3x95+35C</td><td>8,4</td><td>4,0</td></tr> <tr><td>3x150+50C</td><td>13,8</td><td>5,2</td></tr> <tr><td>3x240+95C</td><td>22,1</td><td>10,0</td></tr> </tbody> </table> <p>The short circuit capacities are determined using the following parameters:</p> <table border="1" style="width: 100%; border-collapse: collapse;"> <thead> <tr> <th>Conductor Type</th> <th>Conductor initial temperature</th> <th>Conductor final temperature:</th> </tr> </thead> <tbody> <tr> <td>Central Conductor</td> <td>90°C</td> <td>250°C</td> </tr> <tr> <td>Concentric Conductor</td> <td>85°C</td> <td>160°C</td> </tr> </tbody> </table> <p>Short circuit duration: 1 s</p>	Formation [n° x mm <sup>2</sup> ]	Short circuit rating		Central Conductor [kA]	Concencentric conductor [kA]	1x10+6C	0,9	0,8	1x25+16C	2,4	2	3x10+6C	0,8	0,8	3x25+16C	2,2	2,0	3x50+25C	3,5	2,5	3x95+35C	8,4	4,0	3x150+50C	13,8	5,2	3x240+95C	22,1	10,0	Conductor Type	Conductor initial temperature	Conductor final temperature:	Central Conductor	90°C	250°C	Concentric Conductor	85°C	160°C
Formation [n° x mm <sup>2</sup> ]	Short circuit rating																																							
	Central Conductor [kA]	Concencentric conductor [kA]																																						
1x10+6C	0,9	0,8																																						
1x25+16C	2,4	2																																						
3x10+6C	0,8	0,8																																						
3x25+16C	2,2	2,0																																						
3x50+25C	3,5	2,5																																						
3x95+35C	8,4	4,0																																						
3x150+50C	13,8	5,2																																						
3x240+95C	22,1	10,0																																						
Conductor Type	Conductor initial temperature	Conductor final temperature:																																						
Central Conductor	90°C	250°C																																						
Concentric Conductor	85°C	160°C																																						

LOCAL SECTION A – E-DISTRIBUZIONE (ITALY), E- E-DISTRIBUTIE (ROMANIA)

ITEM	TITLE	DESCRIPTION													
5.2.1	Insulation Color	<p><u>e-distribuzione (Italy), e-distributie (Romania)</u></p> <p><b>Core identification:</b> According to HD-603 section 4 standard.</p> <p>The identification colors of the cross-linked polyethylene insulation material should be:</p> <table border="1" style="margin-left: auto; margin-right: auto;"> <thead> <tr> <th>Cable Type</th> <th>Core</th> <th>Color</th> </tr> </thead> <tbody> <tr> <td>Type I</td> <td>1</td> <td>Black</td> </tr> <tr> <td rowspan="3">Type III</td> <td>1</td> <td>Light Blue</td> </tr> <tr> <td>2</td> <td>Brown</td> </tr> <tr> <td>3</td> <td>Black</td> </tr> </tbody> </table>	Cable Type	Core	Color	Type I	1	Black	Type III	1	Light Blue	2	Brown	3	Black
Cable Type	Core	Color													
Type I	1	Black													
Type III	1	Light Blue													
	2	Brown													
	3	Black													
5.6	Outer Sheath Color	<p><u>e-distribuzione (Italy), e-distributie (Romania)</u></p> <p>The color of Outer sheath must be <b>Grey</b>.</p>													
5.8.1	Cable designation	<p><u>e-distribuzione (Italy), e-distributie (Romania)</u></p> <p>The cable designation shall be the following:</p> <ul style="list-style-type: none"> <li>• Aluminum conductor: <b>A</b></li> <li>• Single wire: <b>U</b> or Stranded compacted circular conductors: <b>R</b></li> <li>• Cross-linked polyethylene insulation: <b>E4</b></li> <li>• Cores joined together for round cable: <b>O</b></li> <li>• copper concentric conductor: <b>C</b></li> <li>• Polyolefin sheath: <b>E</b></li> <li>• Assigned voltage of the cable expressed in kV: U<sub>0</sub>/U</li> <li>• Formation and nominal cross-section of the conductors</li> </ul> <p>Examples:</p> <p><b>ARE4*CE-0,6/1 kV 1x25+16C</b>  <b>AUE4*OCE-0,6/1 kV 3x10+6C</b>  <b>ARE4*OCE-0,6/1 kV 3x95+35C</b></p>													
5.8.2	Markings	<p><u>e-distribuzione (Italy), e-distributie (Romania)</u></p> <p>The distance between the end of the mark and the beginning of the next identical mark does not exceed 550 mm.</p>													

	GLOBAL STANDARD	Page 35 of 54
	LOW VOLTAGE CONCENTRIC CABLES	GSCC014 Rev. 00 12/2020

LOCAL SECTION A – E-DISTRIBUZIONE (ITALY), E- E-DISTRIBUTIE (ROMANIA)

ITEM	TITLE	DESCRIPTION
5.8.2	Markings (Continuation)	<p><u>e-distribuzione (Italy), e-distributie (Romania)</u></p> <p>Cables shall be provided with a marking consisting of:</p> <ul style="list-style-type: none"> <li>Property name: <b>e-distribuzione or e-distributie Banat, e-distributie Dobrogea, e-distributie Muntenia</b></li> <li>Cable designation: see 5.8.2</li> <li>Reaction to fire class (<b>CPR</b>)</li> <li>Manufacturer name or trademark: <b>XXXXX</b></li> <li>Identification of the production plant with a different letter of the alphabet: <b>B</b></li> <li>Project index: to choose exponentially (<b>00, 01, 02, 03</b>). This index must be modified with every construction variation of the single core (phase or neutral).</li> <li>Year and month of manufacturing (<b>2020 12</b>): It could be marked over a different generatrix (position) in relation to the other parameters as long as the maximum step of 1 meter is respected. In such case ink stamping could be used.</li> <li>Fire class reaction ("<b>CPR</b>")</li> <li>Metric marking (<b>0000</b>)</li> </ul> <p><b><u>Marking examples</u></b></p> <p>a) Type I cable 1x25+16C configuration</p> <p><b>e-distribuzione ARE4*CE-0,6/1 kV 1x25+16C XXXXX B 01 2018 12 CPR Xxx<sup>3</sup> - 0000</b></p> <p>b) Type III cable 3x10+16C configuration</p> <p><b>e-distribuzione AUE4*OCE-0,6/1 kV 3x10+6C XXXXX B 01 2018 12 CPR Xxx<sup>3</sup> - 0000</b></p> <p>c) Type III cable 3x95+35C configuration</p> <p><b>e-distribuzione ARE4*OCE-0,6/1 kV 3x95+35C XXXXX B 01 2018 12 CPR Xxx<sup>3</sup> - 0000</b></p>

<sup>3</sup> CPR classification

	GLOBAL STANDARD	Page 36 of 54
	LOW VOLTAGE CONCENTRIC CABLES	GSCC014 Rev. 00 12/2020

LOCAL SECTION A – E-DISTRIBUZIONE (ITALY), E- E-DISTRIBUTIE (ROMANIA)

ITEM	TITLE	DESCRIPTION																											
8	CONDITIONS OF SUPPLY	<p><u>e-distribuzione (Italy), e-distributie (Romania)</u></p> <p>The maximum length and reel type for each configuration of cable are depicted in the following table:</p> <table border="1"> <thead> <tr> <th>Formation [n° x mm<sup>2</sup>]</th> <th>Maximum Length [m]</th> <th>Coil Type (GUI 102)</th> </tr> </thead> <tbody> <tr> <td>1x10+6C (*)</td> <td>1000</td> <td>08</td> </tr> <tr> <td>1x25+16C</td> <td>1000</td> <td>10</td> </tr> <tr> <td>3x10+6C</td> <td>1000</td> <td>12</td> </tr> <tr> <td>3x25+16C</td> <td>500</td> <td>14</td> </tr> <tr> <td>3x50+25C</td> <td>500</td> <td>14</td> </tr> <tr> <td>3x95+35C</td> <td>500</td> <td>16</td> </tr> <tr> <td>3x150+50C</td> <td>500</td> <td>20</td> </tr> <tr> <td>3x240+95C</td> <td>500</td> <td>25</td> </tr> </tbody> </table> <p>The admitted tolerance is equal to <math>\pm 3\%</math> of the length indicated in the order. Coils with total length less than indicated in the table above are permitted, as long as such reels constitute up a maximum to 10% of the cables forming the deliver batch (same transport document). However, each coil shall contain at least 100m, excluding the sample sizes whose length was reduced during the acceptance test.</p> <p>The far end of the cables shall be protected against the moisture.</p> <p>Due to traceability in the network a bar code shall be applied on the drum. Such bar code shall be in compliance with technical specification PVR006.</p> <p>Reels shall be made in compliance with the standard GUI102/GUI 102 RO.</p> <p>Following standard EN 50575, the CE marking and labelling shall be in accordance with the general principles set out in Article 30 of regulation (EC) No. 765/2008 and shall be affixed visibly, legibly and indelibly to the product labels affixed to the reels, coils or drums.</p> <p>In compliance with standard EN 50575 in particular annex V of the EU Construction Products Regulation n° 305/2011 (CPR) the supplier shall elaborate a Declaration of performance (DoP) and shall dispose a CE marking in function of the assessment and verification of constancy of performance (AVCP).</p> <p>(*) At ENEL's request, it is also possible to supply circular hanks with a length between 100 m and 110 m, without any tolerance; these must comply with the minimum bending radius requirement established for the laying of cables CEI 11-17 § 2.3.03.</p> <p>In this case, several skeins of the same type of cable can be supplied on the same pallet, suitably anchored for their handling. Formation and nominal cross-section of the conductors</p>	Formation [n° x mm <sup>2</sup> ]	Maximum Length [m]	Coil Type (GUI 102)	1x10+6C (*)	1000	08	1x25+16C	1000	10	3x10+6C	1000	12	3x25+16C	500	14	3x50+25C	500	14	3x95+35C	500	16	3x150+50C	500	20	3x240+95C	500	25
Formation [n° x mm <sup>2</sup> ]	Maximum Length [m]	Coil Type (GUI 102)																											
1x10+6C (*)	1000	08																											
1x25+16C	1000	10																											
3x10+6C	1000	12																											
3x25+16C	500	14																											
3x50+25C	500	14																											
3x95+35C	500	16																											
3x150+50C	500	20																											
3x240+95C	500	25																											

### LOCAL SECTION B – CODENSA (COLOMBIA)

ITEM	TITLE	DESCRIPTION																		
3.4	Replaced Local Standards	<p><b>E-BT-003 Rev 4.</b> Especificación Técnica: Cables Concéntricos Para Baja Tensión.  <b>ET-112 rev 2</b> Cable de cobre para acometidas trifásicas  <b>ET-113 rev 3</b> Cable de cobre trenzado para derivación a caja de conexión de acometidas</p>																		
5	Conductor	<p>For Codensa, there is a particular configuration that is described below:</p> <p><b>Phase conductor:</b> Annealed plain copper, the copper conductors shall be stranded compacted circular class 2, complying with all the features specified herein and in standard IEC 60228 with the following characteristics:</p> <table border="1" style="margin-left: 40px;"> <thead> <tr> <th rowspan="2">Nominal cross-section [mm<sup>2</sup>]</th> <th rowspan="2">Minimum number of wires</th> <th colspan="2">Diameter of conductor [mm]</th> <th rowspan="2">Maximum resistance of conductor at 20°C [Ω/km]</th> </tr> <tr> <th>Min</th> <th>Max</th> </tr> </thead> <tbody> <tr> <td style="text-align: center;">35</td> <td style="text-align: center;">6</td> <td style="text-align: center;">6,6</td> <td style="text-align: center;">7,5</td> <td style="text-align: center;">0,524</td> </tr> </tbody> </table> <p><b>Concentric conductor:</b> For all effects, use the definition described in section 5.7.2. by adding the following description in Table 6.1</p> <table border="1" style="margin-left: 40px;"> <thead> <tr> <th>Formation</th> <th>Stranding Type</th> <th>Period of the resulting sinusoids</th> </tr> </thead> <tbody> <tr> <td style="text-align: center;">3x35+25C</td> <td style="text-align: center;">UNIDIRECCIONAL (1)</td> <td style="text-align: center;">400 mm</td> </tr> </tbody> </table>	Nominal cross-section [mm <sup>2</sup> ]	Minimum number of wires	Diameter of conductor [mm]		Maximum resistance of conductor at 20°C [Ω/km]	Min	Max	35	6	6,6	7,5	0,524	Formation	Stranding Type	Period of the resulting sinusoids	3x35+25C	UNIDIRECCIONAL (1)	400 mm
Nominal cross-section [mm <sup>2</sup> ]	Minimum number of wires	Diameter of conductor [mm]			Maximum resistance of conductor at 20°C [Ω/km]															
		Min	Max																	
35	6	6,6	7,5	0,524																
Formation	Stranding Type	Period of the resulting sinusoids																		
3x35+25C	UNIDIRECCIONAL (1)	400 mm																		
5.2.1	Insulation Color	<p><b>Core identification:</b> According to HD-603 section 4 standard.</p> <p>To satisfy RETIE requirements, the identification colors of the cross-linked polyethylene insulation material should be:</p> <table border="1" style="margin-left: 40px;"> <thead> <tr> <th>Cable Type</th> <th>Core</th> <th>Color</th> </tr> </thead> <tbody> <tr> <td rowspan="2">Type I</td> <td style="text-align: center;">1</td> <td style="text-align: center;">Black</td> </tr> <tr> <td style="text-align: center;">2</td> <td style="text-align: center;">Blue</td> </tr> <tr> <td rowspan="3">Type III</td> <td style="text-align: center;">1</td> <td style="text-align: center;">Blue</td> </tr> <tr> <td style="text-align: center;">2</td> <td style="text-align: center;">Red</td> </tr> <tr> <td style="text-align: center;">3</td> <td style="text-align: center;">Yellow</td> </tr> </tbody> </table>	Cable Type	Core	Color	Type I	1	Black	2	Blue	Type III	1	Blue	2	Red	3	Yellow			
Cable Type	Core	Color																		
Type I	1	Black																		
	2	Blue																		
Type III	1	Blue																		
	2	Red																		
	3	Yellow																		

	GLOBAL STANDARD	Page 38 of 54
	LOW VOLTAGE CONCENTRIC CABLES	GSCC014 Rev. 00 12/2020

LOCAL SECTION B – CODENSA (COLOMBIA)

ITEM	TITLE	DESCRIPTION
5.6	Outer Sheath Color	The color of Outer sheath must be <b>Black</b> .
5.7	Ampacity and Short-circuit rating	<p>The ampacity estimated values shall be given for network design purposes. Such currents shall be calculated in steady state condition, when installed in open air and in duct using the following operational conditions:</p> <ul style="list-style-type: none"> <li>• Maximum conductor temperature 90 °C</li> <li>• Ambient air temperature 35 °C</li> </ul>
5.8.1	Cable designation	<p>Conductor:</p> <ul style="list-style-type: none"> <li>• Concentric cable: CC</li> </ul> <p>Phase conductor material:</p> <ul style="list-style-type: none"> <li>• Aluminum conductor (AL/A8000) or cooper (Cu)</li> </ul> <p>Concentric neutral material:</p> <ul style="list-style-type: none"> <li>• Cooper: Cu</li> </ul> <p>Insulation material:</p> <ul style="list-style-type: none"> <li>• Cross-linked polyethylene insulation: XLPE</li> </ul> <p>Outer sheath material</p> <ul style="list-style-type: none"> <li>• Polyolefin: PO</li> </ul> <p>Rated voltage:</p> <ul style="list-style-type: none"> <li>• 0,6/1(1,2) kV</li> </ul> <p>Nominal cross-sectional area (Phase and neutral):</p> <ul style="list-style-type: none"> <li>• XXX mm<sup>2</sup></li> </ul> <p>Example: CC AL/A8000-CU-XLPE PO 0,6/1 (1,2) kV 1x16+10 mm<sup>2</sup></p>
5.8.2	Markings	<p>The cable shall be marked on the outer sheath every meter of length with the following information:</p> <ul style="list-style-type: none"> <li>• Name of distribution company (ENEL CODENSA)</li> <li>• Name of the manufacturer (NNN)</li> <li>• Cable designation (#####)</li> <li>• Maximum operating temperature</li> <li>• Manufactured year and month (MM/YYYY)</li> <li>• Sequential meters markings m (%%)</li> </ul> <p>Example: ENEL CODENSA NNN CC AL/A8000-CU-XLPE PO 0,6/1 (1,2) kV 1x16+10 mm<sup>2</sup> 90°C 09/2017 %% m</p>
6.4	Local regulatory requirements	<p><u>REGULATORY REQUIREMENTS</u></p> <p>The supplier shall do the "Product Conformity Certification with RETIE" process, with both the follow-up audits and the expiration date of the certificate in force against the estimated date of entry into the country.</p>

LOCAL SECTION B – CODENSA (COLOMBIA)

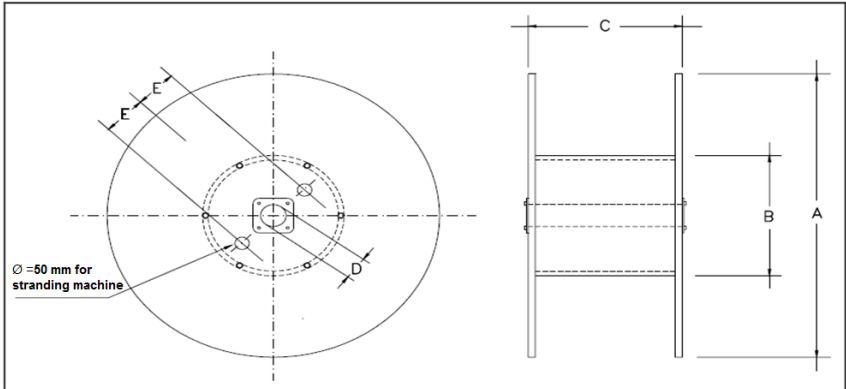
8	CONDITIONS OF SUPPLY	<p><b>PACKAGING AND LABELING</b></p> <p>The cable shall be delivered by the manufacturer on a wooden or metal spool, which will not be returned, as per maximum and minimum dimensions indicated in Table B.1 and in accordance with Figure 7.</p> <p>The total length of the driver given on each reel may not be less than requested in the purchase order and shall not exceed by more than 1%. The maximum gross weight of the reel is packed 1,500 kg.</p> <p>It should protect the ends of each cable reel with caps to prevent moisture ingress and must be internally secured to the spool ends, and must be mechanically protected against possible damages from the handling and transport of each reel, leaving both accessible through the use of internal helix or conch in each reel ends.</p> <p>There must be a minimum of 10 cm from the last turn of the cable to the edge of the reel to avoid damage to the cable during handling and transport.</p> <p>The wooden spools will be treated according to international requirements for pest control, avoiding the compound " Pentachlorophenol " and " Creosote ". Treatment should include, at least: high toxicity to decay organisms, high penetration and holding power, chemical stability, non-corrosive to metals and substances affecting physical characteristics of the wood and weather protection</p> <p>Note: The purchase order could specify a maximum length of cable in drum.</p> <div style="text-align: center;">  <p>Figure N°7 Trial type</p> <table border="1" style="margin-left: auto; margin-right: auto;"> <thead> <tr> <th>A<sup>(1)</sup></th> <th>B</th> <th>C<sup>(1)</sup></th> <th>D<sup>(2)</sup></th> <th>E</th> </tr> <tr> <th>mm</th> <th>mm</th> <th>mm</th> <th>mm</th> <th>mm</th> </tr> </thead> <tbody> <tr> <td>1730</td> <td>(3)</td> <td>1120</td> <td>80</td> <td>(4)</td> </tr> </tbody> </table> <p>Table B.1 Trial dimension</p> </div> <p>Notes:  (1) Maximum value.  (2) Minimum value  (3) EI Double the minimum cable curvature radius for transportation, in accordance with Manufacturer specifications.  (4) 300 or 180 mm, in accordance with the type of spool (large or small, respectively)</p>	A <sup>(1)</sup>	B	C <sup>(1)</sup>	D <sup>(2)</sup>	E	mm	mm	mm	mm	mm	1730	(3)	1120	80	(4)
A <sup>(1)</sup>	B	C <sup>(1)</sup>	D <sup>(2)</sup>	E													
mm	mm	mm	mm	mm													
1730	(3)	1120	80	(4)													

	GLOBAL STANDARD	Page 40 of 54
	LOW VOLTAGE CONCENTRIC CABLES	GSCC014 Rev. 00 12/2020

LOCAL SECTION B – CODENSA (COLOMBIA)

8	<p>CONDITIONS OF SUPPLY (continuation)</p>	<p>The reels must:</p> <ol style="list-style-type: none"> <li>1) Be protected by wooden staves on the exterior, which are to be secured to the wooden spools. An equivalent system is to be used on the metal spools. The staves are to be fastened by steel or plastic bands.</li> <li>2) Show the correct direction for unwinding the spools, by means of an arrow located on the sides.</li> <li>3) Have a rustproof nameplate on each side of the spool. Each nameplate will show the following information (as a minimum), in the language of the country where the cable is to be used: <ul style="list-style-type: none"> <li>• Name of distribution company</li> <li>• Name of the manufacturer</li> <li>• Country of origin of the item</li> <li>• Country code</li> <li>• Description of item</li> <li>• Year and month of manufacture</li> <li>• Number of the spool within the delivered batch.</li> <li>• Cable length, in meters.</li> <li>• the metric initial (m)</li> <li>• the metric final (m)</li> <li>• Manufacture standard</li> <li>• Purchase Order N°</li> <li>• Contract N°</li> <li>• Rated Voltage (0,6/1(1,2 kV)</li> <li>• Insulation material and type</li> <li>• Conductor caliber (mm<sup>2</sup>)</li> <li>• Net weight and gross weight in kg.</li> <li>• Weight of the spool in kg</li> <li>• Weight of one meter of cable in kg</li> <li>• Cable type</li> <li>• Cable length, in meters.</li> <li>• Spool dimension in mm.</li> </ul> </li> </ol>
---	--	---



	GLOBAL STANDARD	Page 41 of 54
	LOW VOLTAGE CONCENTRIC CABLES	GSCC014 Rev. 00 12/2020

### LOCAL SECTION C – ENEL DISTRIBUCIÓN CHILE

ITEM	TITLE	DESCRIPTION													
3.4	Replaced Local Standards	<b>E-BT-003 Rev 4.</b> Especificación Técnica: Cables Concéntricos Para Baja Tensión.													
5.2.1	Insulation Color	<p><b>Core identification:</b> According to HD-603 section 4 standard.</p> <p>The identification colors of the cross-linked polyethylene insulation material should be:</p> <table border="1" style="margin-left: auto; margin-right: auto;"> <thead> <tr> <th>Cable Type</th> <th>Core</th> <th>Color</th> </tr> </thead> <tbody> <tr> <td>Type I</td> <td>1</td> <td>Black</td> </tr> <tr> <td rowspan="3">Type III</td> <td>1</td> <td>Blue</td> </tr> <tr> <td>2</td> <td>Black</td> </tr> <tr> <td>3</td> <td>Red</td> </tr> </tbody> </table>	Cable Type	Core	Color	Type I	1	Black	Type III	1	Blue	2	Black	3	Red
Cable Type	Core	Color													
Type I	1	Black													
Type III	1	Blue													
	2	Black													
	3	Red													
5.6	Outer Sheath Color	The color of Outer sheath must be <b>Black</b> .													
5.7	Ampacity and Short-circuit rating	<p>The ampacity estimated values shall be given for network design purposes. Such currents shall be calculated in steady state condition, when installed in open air and in duct using the following operational conditions:</p> <ul style="list-style-type: none"> <li>• Maximum conductor temperature 90 °C</li> <li>• Ambient air temperature 35 °C</li> </ul>													
5.8.1	Cable designation	<p>Conductor:</p> <ul style="list-style-type: none"> <li>• Concentric cable: CC</li> </ul> <p>Phase conductor material:</p> <ul style="list-style-type: none"> <li>• Aluminum conductor (AL)</li> </ul> <p>Concentric neutral material:</p> <ul style="list-style-type: none"> <li>• Cooper: Cu</li> </ul> <p>Insulation material:</p> <ul style="list-style-type: none"> <li>• Cross-linked polyethylene insulation: XLPE</li> </ul> <p>Outer sheath material</p> <ul style="list-style-type: none"> <li>• Polyolefin: PO</li> </ul> <p>Rated voltage:</p> <ul style="list-style-type: none"> <li>• 0,6/1(1,2) kV</li> </ul> <p>Nominal cross-sectional area (Phase and neutral):</p> <ul style="list-style-type: none"> <li>• XXX mm<sup>2</sup></li> </ul> <p>Example: CC 1X16AL+ 10CU mm<sup>2</sup> XLPE-PO 0,6/1 (1,2) kV</p>													

	GLOBAL STANDARD	Page 42 of 54
	LOW VOLTAGE CONCENTRIC CABLES	GSCC014 Rev. 00 12/2020

LOCAL SECTION C – Enel Distribución Chile

5.8.2	Markings	<p>The cable shall be marked on the outer sheath every meter of length with the following information:</p> <ul style="list-style-type: none"> <li>• Name of distribution company (<b>ENEL DISTRIBUCION CHILE</b>)</li> <li>• Name of the manufacturer (NNN)</li> <li>• Cable designation (#####)</li> <li>• Maximum operating temperature</li> <li>• Manufactured year and month (MM/YYYY)</li> <li>• Sequential meters markings m (%%)</li> </ul> <p>Example: ENEL DISTRIBUCION CHILE NNN CC 1X16AL+ 10CU mm2 XLPE-PO 0,6/1 (1,2) kV 90°C 09/2017 %% m</p>
8	CONDITIONS OF SUPPLY	<p>PACKAGING AND LABELING FOR <b>TYPE I “Single-core concentric cables”</b></p> <p>The cable must be packed in rolls, wrapped in plastic with a length of up to 200m complying with a maximum weight of 25kg (maximum weight established in legislation for one person load)</p> <p>Each roll should be labeled with the following information:</p> <ul style="list-style-type: none"> <li>• Name of distribution company: <b>“ENEL Distribución Chile”</b></li> <li>• Name of the manufacturer</li> <li>• Country of origin of the item</li> <li>• Country code</li> <li>• Description of item</li> <li>• Year and month of manufacture</li> <li>• Cable length, in meters.</li> <li>• Manufacture standard</li> <li>• Purchase Order N°</li> <li>• Rated Voltage (0,6/1(1,2 kV))</li> <li>• Insulation material and type</li> <li>• Conductor caliber (mm<sup>2</sup>)</li> <li>• Weight of the rolls in kg</li> <li>• Weight of one meter of cable in kg</li> <li>• Cable type</li> <li>• Cable length, in meters.</li> </ul>

LOCAL SECTION C – Enel Distribución Chile

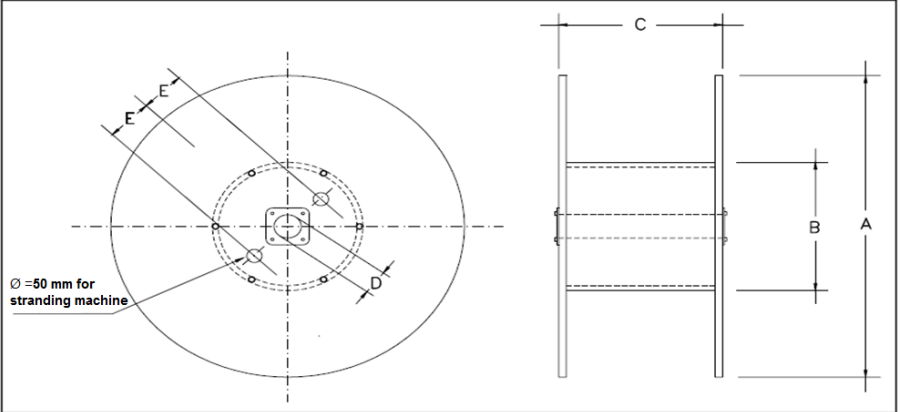
8	CONDITIONS OF SUPPLY	<p><b>PACKAGING AND LABELING FOR TYPE III “Three-core concentric cables”</b></p> <p>The cable shall be delivered by the manufacturer on a wooden or metal spool, which will not be returned, as per maximum and minimum dimensions indicated in Table C.1 and in accordance with Figure 8.</p> <p>The total length of the driver given on each reel may not be less than requested in the purchase order and shall not exceed by more than 1%. The maximum gross weight of the reel is packed 1,500 kg. It should protect the ends of each cable reel with caps to prevent moisture ingress and must be internally secured to the spool ends, and must be mechanically protected against possible damages from the handling and transport of each reel , leaving both accessible through the use of internal helix or conch in each reel ends.</p> <p>The wooden spools will be treated according to international requirements for pest control, avoiding the compound " Pentachlorophenol " and " Creosote ". Treatment should include, at least: high toxicity to decay organisms, high penetration and holding power, chemical stability, non-corrosive to metals and substances affecting physical characteristics of the wood and weather protection</p> <p>Note: The purchase order could specify a maximum length of cable in drum.</p> <div style="text-align: center;">  </div> <p style="text-align: center;">Figure N°8 Trial type</p> <table border="1" style="margin-left: auto; margin-right: auto;"> <thead> <tr> <th style="text-align: center;">A<sup>(1)</sup></th> <th style="text-align: center;">B</th> <th style="text-align: center;">C<sup>(1)</sup></th> <th style="text-align: center;">D<sup>(2)</sup></th> <th style="text-align: center;">E</th> </tr> <tr> <th style="text-align: center;">mm</th> <th style="text-align: center;">mm</th> <th style="text-align: center;">mm</th> <th style="text-align: center;">mm</th> <th style="text-align: center;">mm</th> </tr> </thead> <tbody> <tr> <td style="text-align: center;">1730</td> <td style="text-align: center;">(3)</td> <td style="text-align: center;">1120</td> <td style="text-align: center;">80</td> <td style="text-align: center;">(4)</td> </tr> </tbody> </table> <p style="text-align: center;">Table C.1 Trial dimension</p> <p>Notes:</p> <ul style="list-style-type: none"> <li>(1) Maximum value.</li> <li>(2) Minimum value</li> <li>(3) EI Double the minimum cable curvature radius for transportation, in accordance with Manufacturer specifications.</li> <li>(4) 300 or 180 mm, in accordance with the type of spool (large or small, respectively)</li> </ul>	A <sup>(1)</sup>	B	C <sup>(1)</sup>	D <sup>(2)</sup>	E	mm	mm	mm	mm	mm	1730	(3)	1120	80	(4)
A <sup>(1)</sup>	B	C <sup>(1)</sup>	D <sup>(2)</sup>	E													
mm	mm	mm	mm	mm													
1730	(3)	1120	80	(4)													

	GLOBAL STANDARD	Page 44 of 54
	LOW VOLTAGE CONCENTRIC CABLES	GSCC014 Rev. 00 12/2020

LOCAL SECTION C – Enel Distribución Chile

8	CONDITIONS OF SUPPLY	<p>The reels must:</p> <ol style="list-style-type: none"> <li>1) Be protected by wooden staves on the exterior, which are to be secured to the wooden spools. An equivalent system is to be used on the metal spools. The staves are to be fastened by steel or plastic bands.</li> <li>2) Show the correct direction for unwinding the spools, by means of an arrow located on the sides.</li> <li>3) Have a rustproof nameplate on each side of the spool. Each nameplate will show the following information (as a minimum), in the language of the country where the cable is to be used: <ul style="list-style-type: none"> <li>• Name of distribution company: <b>"ENEL Distribución Chile"</b></li> <li>• Name of the manufacturer</li> <li>• Country of origin of the item</li> <li>• Country code</li> <li>• Description of item</li> <li>• Year and month of manufacture</li> <li>• Number of the spool within the delivered batch.</li> <li>• Cable length, in meters.</li> <li>• the metric initial (m)</li> <li>• the metric final (m)</li> <li>• Manufacture standard</li> <li>• Purchase Order N°</li> <li>• Rated Voltage (0,6/1(1,2 kV))</li> <li>• Insulation material and type</li> <li>• Conductor caliber (mm<sup>2</sup>)</li> <li>• Net weight and gross weight in kg.</li> <li>• Weight of the spool in kg</li> <li>• Weight of one meter of cable in kg</li> <li>• Cable type</li> <li>• Cable length, in meters.</li> <li>• Spool dimension in mm.</li> </ul> </li> </ol>
---	-------------------------	---

	GLOBAL STANDARD	Page 45 of 54
	LOW VOLTAGE CONCENTRIC CABLES	GSCC014 Rev. 00 12/2020

### LOCAL SECTION D –EDESUR (ARGENTINA)

ITEM	TITLE	DESCRIPTION						
3.3	Local Standards	<ul style="list-style-type: none"> <li>• <b>DNEG02.</b></li> <li>• <b>IRAM 63001.</b></li> </ul>						
3.4	Replaced Local Standards	<b>DBEE13</b> CABLES PARA ACOMETIDA AEREA DE ALUMINIO CON NEUTRO CONCENTRICO AISLADOS CON XLPE PARA TENSIONES NOMINALES HASTA U0/U = 0,6/1 KV						
5.2.1	Insulation Color	<p><b>Core identification:</b> According to HD-603 section 4 standard.</p> <p>The identification colors of the cross-linked polyethylene insulation material should be:</p> <table border="1" style="margin-left: auto; margin-right: auto;"> <thead> <tr> <th>Cable Type</th> <th>Core</th> <th>Color</th> </tr> </thead> <tbody> <tr> <td>Type I</td> <td>1</td> <td>Black</td> </tr> </tbody> </table>	Cable Type	Core	Color	Type I	1	Black
Cable Type	Core	Color						
Type I	1	Black						
5.6	Outer Sheath Color	The color of Outer sheath must be <b>Black</b> .						
5.7	Ampacity and Short-circuit rating	<p>The ampacity estimated values shall be given for network design purposes. Such currents shall be calculated in steady state condition, when installed in open air and in duct using the following operational conditions:</p> <ul style="list-style-type: none"> <li>• Maximum conductor temperature 90 °C</li> <li>• Ambient air temperature 35 °C</li> </ul>						
5.8.1	Cable designation	<p>Enel Global Standard Type:</p> <ul style="list-style-type: none"> <li>• "GSCC014/X –" (See Common list)</li> </ul> <p>Country Code:</p> <ul style="list-style-type: none"> <li>• "0101-0511 -" (See Common list)</li> </ul> <p>Conductor:</p> <ul style="list-style-type: none"> <li>• Concentric cable: CC</li> </ul> <p>Phase conductor material:</p> <ul style="list-style-type: none"> <li>• Aluminum conductor (AL)</li> </ul> <p>Concentric neutral material:</p> <ul style="list-style-type: none"> <li>• Cooper: Cu</li> </ul> <p>Insulation material:</p> <ul style="list-style-type: none"> <li>• Cross-linked polyethylene insulation: XLPE</li> </ul> <p>Outer sheath material</p> <ul style="list-style-type: none"> <li>• Polyolefin: PO</li> </ul> <p>Rated voltage:</p> <ul style="list-style-type: none"> <li>• 0,6/1(1,2) kV</li> </ul> <p>Nominal cross-sectional area (Phase and neutral):</p> <ul style="list-style-type: none"> <li>• XXX mm<sup>2</sup></li> </ul> <p>Example: GSCC014/3 - 0101-0511 - CC 1X16AL+ 10CU mm<sup>2</sup> XLPE-PO 0,6/1 (1,2) kV</p>						

	GLOBAL STANDARD	Page 46 of 54
	LOW VOLTAGE CONCENTRIC CABLES	GSCC014 Rev. 00 12/2020

LOCAL SECTION D –EDESUR (ARGENTINA)

5.8.2	Markings	<p>The cable shall be marked on the outer sheath every meter of length with the following information:</p> <ul style="list-style-type: none"> <li>• Name of distribution company (<b>EDESUR</b>)</li> <li>• Name of the manufacturer (NNN)</li> <li>• Cable designation (#####)</li> <li>• Maximum operating temperature</li> <li>• Manufactured year and month (MM/YYYY)</li> <li>• Sequential meters markings m (%%)</li> </ul> <p>Example: EDESUR NNN GSCC014/3 - 0101-0511 - CC 1X16AL+ 10CU mm2 XLPE-PO 0,6/1 (1,2) kV 90°C 09/2017 %% m</p>
8	CONDITIONS OF SUPPLY	<p>The cables will be packed and delivered in rolls according to the local standard <b>DNEG02</b>, with 200 meters rolls, tolerance of +/- 5%.</p> <p>The identification of the rolls shall be carried out according to <b>IRAM 63001</b> standard.</p>

	GLOBAL STANDARD	Page 47 of 54
	LOW VOLTAGE CONCENTRIC CABLES	GSCC014 Rev. 00 12/2020

## LOCAL SECTION E – ENEL DISTRIBUCIÓN PERÚ

ITEM	TITLE	DESCRIPTION											
3.4	Replaced Local Standards	<b>E-BT-003 Rev 4.</b> Especificación Técnica: Cables Concéntricos Para Baja Tensión.											
5.2.1	Insulation Color	<p><b>Core identification:</b> According to HD-603 section 4 standard.</p> <p>The identification colors of the cross-linked polyethylene insulation material should be:</p> <table border="1" style="margin-left: auto; margin-right: auto;"> <thead> <tr> <th>Cable Type</th> <th>Core</th> <th>Color</th> </tr> </thead> <tbody> <tr> <td>Type I</td> <td>1</td> <td>Black</td> </tr> <tr> <td rowspan="2">Type II</td> <td>1</td> <td>Black</td> </tr> <tr> <td>2</td> <td>Blue</td> </tr> </tbody> </table>	Cable Type	Core	Color	Type I	1	Black	Type II	1	Black	2	Blue
Cable Type	Core	Color											
Type I	1	Black											
Type II	1	Black											
	2	Blue											
5.7	Ampacity and Short-circuit rating	<p>The ampacity estimated values shall be given for network design purposes. Such currents shall be calculated according to “CNE Ssuministro 2011” using the following conditions:</p> <ul style="list-style-type: none"> <li>• Maximum conductor temperature 90 °C</li> <li>• Ambient air temperature 35 °C</li> </ul>											
5.6	Outer Sheath Color	The color of Outer sheath must be <b>Black</b> .											
5.8.1	Cable designation	<ul style="list-style-type: none"> <li>○ Phase conductor : Aluminum (AL)</li> <li>• Concentric Conductor : Copper wires (CU)</li> <li>○ Cross-linked polyethylene insulation: XLPE</li> <li>• Outer sheath: polyolefin (PO)</li> <li>• Nominal cross-sectional area: XXX mm<sup>2</sup></li> <li>• Rated voltage: 0,6/1(1,2) kV</li> </ul> <p>Example: 2X10AL+ 6CU mm<sup>2</sup> XLPE-PO 0,6/1 (1,2) kV</p>											
5.8.2	Markings	<p>The cable shall be marked on the outer sheath every meter of length with the following information:</p> <ul style="list-style-type: none"> <li>• Name of distribution company (<b>ENEL DISTRIBUCIÓN PERÚ</b>)</li> <li>• Name of the manufacturer (NNN)</li> <li>• Cable designation (#####)</li> <li>• Maximum operating temperature</li> <li>• Manufactured year and month (MM/YYYY)</li> <li>• Sequential meters markings m (%%)</li> </ul> <p>Example: ENEL DISTRIBUCIÓN PERU NNNNNNN 2X10AL+ 6CU mm<sup>2</sup> XLPE-PO 0,6/1 (1,2) KV 90°C 09/2017 %% m</p>											

LOCAL SECTION E – Enel Distribución Perú

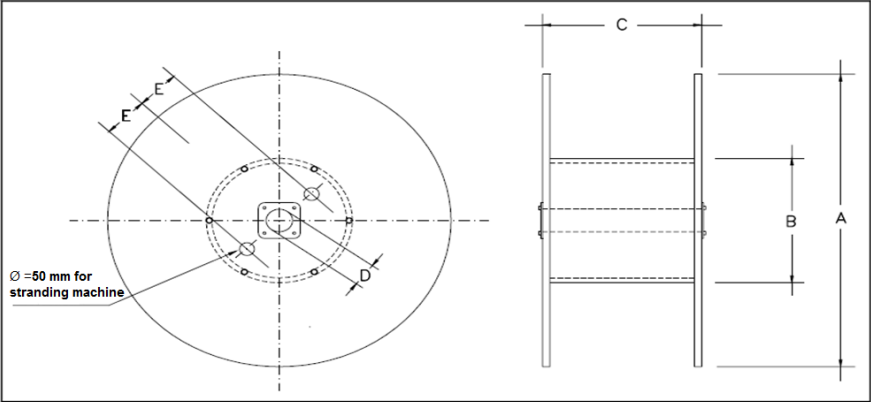
8	CONDITIONS OF SUPPLY	<p><b>PACKAGING AND LABELING</b></p> <p>The cable shall be delivered by the manufacturer on a wooden or metal spool, which will not be returned, as per maximum and minimum dimensions indicated in Table E.1 and in accordance with Figure 9.</p> <p>The total length of the driver given on each reel may not be less than requested in the purchase order and shall not exceed by more than 1%. The maximum gross weight of the reel is packed 1,500 kg.</p> <p>It should protect the ends of each cable reel with caps to prevent moisture ingress and must be internally secured to the spool ends, and must be mechanically protected against possible damages from the handling and transport of each reel , leaving both accessible through the use of internal helix or conch in each reel ends.</p> <p>The wooden spools will be treated according to international requirements for pest control, avoiding the compound " Pentachlorophenol " and " Creosote ". Treatment should include, at least: high toxicity to decay organisms, high penetration and holding power, chemical stability, non-corrosive to metals and substances affecting physical characteristics of the wood and weather protection</p> <p>Note: The purchase order could specify a maximum length of cable in drum.</p> <div style="text-align: center;">  </div> <p style="text-align: center;">Figure N°9 Trial type</p> <table border="1" style="margin-left: auto; margin-right: auto;"> <thead> <tr> <th style="text-align: center;"><math>A^{(1)}</math></th> <th style="text-align: center;">B</th> <th style="text-align: center;"><math>C^{(1)}</math></th> <th style="text-align: center;"><math>D^{(2)}</math></th> <th style="text-align: center;">E</th> </tr> <tr> <th style="text-align: center;">mm</th> <th style="text-align: center;">mm</th> <th style="text-align: center;">mm</th> <th style="text-align: center;">mm</th> <th style="text-align: center;">mm</th> </tr> </thead> <tbody> <tr> <td style="text-align: center;">1730</td> <td style="text-align: center;">(3)</td> <td style="text-align: center;">1120</td> <td style="text-align: center;">80</td> <td style="text-align: center;">(4)</td> </tr> </tbody> </table> <p style="text-align: center;">Table E.1 Trial dimension</p> <p>Notes:            (1) Maximum value.            (2) Minimum value            (3) EI Double the minimum cable curvature radius for transportation, in accordance with Manufacturer specifications.            (4) 300 or 180 mm, in accordance with the type of spool (large or small, respectively)</p>	$A^{(1)}$	B	$C^{(1)}$	$D^{(2)}$	E	mm	mm	mm	mm	mm	1730	(3)	1120	80	(4)
$A^{(1)}$	B	$C^{(1)}$	$D^{(2)}$	E													
mm	mm	mm	mm	mm													
1730	(3)	1120	80	(4)													



LOCAL SECTION E – Enel Distribución Perú

8	<p>CONDITIONS OF SUPPLY (continuation)</p>	<p>The reels must:</p> <ol style="list-style-type: none"> <li>1) Be protected by wooden staves on the exterior, which are to be secured to the wooden spools. An equivalent system is to be used on the metal spools. The staves are to be fastened by steel or plastic bands.</li> <li>2) Show the correct direction for unwinding the spools, by means of an arrow located on the sides.</li> <li>3) A plate/label (stainless or polyethylene) shall be applied in both flanges and shall have the following information (in Spanish): <ul style="list-style-type: none"> <li>• Name of distribution company: “ENEL Distribución Perú”</li> <li>• Name of the manufacturer</li> <li>• Country of origin of the item</li> <li>• Country code</li> <li>• Description of item</li> <li>• Year and month of manufacture</li> <li>• Number of the spool within the delivered batch.</li> <li>• Cable length, in meters.</li> <li>• the metric initial (m)</li> <li>• the metric final (m)</li> <li>• Manufacture standard</li> <li>• Purchase Order N°</li> <li>• Rated Voltage (0,6/1(1,2 kV))</li> <li>• Insulation material and type</li> <li>• Conductor caliber (mm<sup>2</sup>)</li> <li>• Net weight and gross weight in kg.</li> <li>• Weight of the spool in kg</li> <li>• Weight of one meter of cable in kg</li> <li>• Cable type</li> <li>• Cable length, in meters.</li> <li>• Spool dimension in mm.</li> </ul> </li> </ol> <p><b>Note:</b> The plate/label used shall be resistant to UV rays, tearing, and chemical substances. The dimension will be at least: Height: 230 mm and Width: 140 mm.</p> <p>The size of the letters should be: Width: 4.5 mm; Height: 10 mm.</p> <p>An example is given in the following figure:</p> <div style="display: flex; justify-content: space-around; align-items: flex-start;"> <div style="border: 1px solid black; padding: 5px; width: 45%;"> <p style="text-align: center; border: 1px solid black; margin-bottom: 5px;">NOMBRE DEL PROVEEDOR</p> <table border="1" style="width: 100%; border-collapse: collapse;"> <tr><td style="font-size: small;">Cliente</td><td><input type="text"/></td></tr> <tr><td style="font-size: small;">Fabricante</td><td><input type="text"/></td></tr> <tr><td style="font-size: small;">País de Origen</td><td><input type="text"/></td></tr> <tr><td style="font-size: small;">Código de País</td><td><input type="text"/></td></tr> <tr><td style="font-size: small;">Descripción</td><td><input type="text"/></td></tr> <tr><td style="font-size: small;">Mes/Año de</td><td><input type="text"/></td></tr> <tr><td style="font-size: small;">Matrícula de Carrete</td><td><input type="text"/></td></tr> <tr><td style="font-size: small;">Punta Inicial</td><td><input type="text"/></td></tr> <tr><td style="font-size: small;">Punta Final</td><td><input type="text"/></td></tr> <tr><td style="font-size: small;">Cantidad (m)</td><td><input type="text"/></td></tr> <tr><td style="font-size: small;">Sección del Conductor (mm<sup>2</sup>)</td><td><input type="text"/></td></tr> <tr><td style="font-size: small;">Fase:</td><td><input type="text"/></td></tr> </table> </div> <div style="border: 1px solid black; padding: 5px; width: 45%;"> <table border="1" style="width: 100%; border-collapse: collapse;"> <tr><td style="font-size: small;">Tipo de Cable / Aislamiento</td><td><input type="text"/></td></tr> <tr><td style="font-size: small;">Norma de Fabricación</td><td><input type="text"/></td></tr> <tr><td style="font-size: small;">Tensión Uo/U (Umax)</td><td><input type="text"/></td></tr> <tr><td style="font-size: small;">Orden de Compra</td><td><input type="text"/></td></tr> <tr><td style="font-size: small;">Peso Neto (kg)</td><td><input type="text"/></td></tr> <tr><td style="font-size: small;">Peso metro de cable</td><td><input type="text"/></td></tr> <tr><td style="font-size: small;">Peso de carrete (kg)</td><td><input type="text"/></td></tr> <tr><td style="font-size: small;">Dimensiones de</td><td><input type="text"/></td></tr> <tr><td style="font-size: small;">Peso Bruto (kg)</td><td><input type="text"/></td></tr> </table> </div> </div>	Cliente	<input type="text"/>	Fabricante	<input type="text"/>	País de Origen	<input type="text"/>	Código de País	<input type="text"/>	Descripción	<input type="text"/>	Mes/Año de	<input type="text"/>	Matrícula de Carrete	<input type="text"/>	Punta Inicial	<input type="text"/>	Punta Final	<input type="text"/>	Cantidad (m)	<input type="text"/>	Sección del Conductor (mm <sup>2</sup> )	<input type="text"/>	Fase:	<input type="text"/>	Tipo de Cable / Aislamiento	<input type="text"/>	Norma de Fabricación	<input type="text"/>	Tensión Uo/U (Umax)	<input type="text"/>	Orden de Compra	<input type="text"/>	Peso Neto (kg)	<input type="text"/>	Peso metro de cable	<input type="text"/>	Peso de carrete (kg)	<input type="text"/>	Dimensiones de	<input type="text"/>	Peso Bruto (kg)	<input type="text"/>
Cliente	<input type="text"/>																																											
Fabricante	<input type="text"/>																																											
País de Origen	<input type="text"/>																																											
Código de País	<input type="text"/>																																											
Descripción	<input type="text"/>																																											
Mes/Año de	<input type="text"/>																																											
Matrícula de Carrete	<input type="text"/>																																											
Punta Inicial	<input type="text"/>																																											
Punta Final	<input type="text"/>																																											
Cantidad (m)	<input type="text"/>																																											
Sección del Conductor (mm <sup>2</sup> )	<input type="text"/>																																											
Fase:	<input type="text"/>																																											
Tipo de Cable / Aislamiento	<input type="text"/>																																											
Norma de Fabricación	<input type="text"/>																																											
Tensión Uo/U (Umax)	<input type="text"/>																																											
Orden de Compra	<input type="text"/>																																											
Peso Neto (kg)	<input type="text"/>																																											
Peso metro de cable	<input type="text"/>																																											
Peso de carrete (kg)	<input type="text"/>																																											
Dimensiones de	<input type="text"/>																																											
Peso Bruto (kg)	<input type="text"/>																																											

	GLOBAL STANDARD	Page 50 of 54
	LOW VOLTAGE CONCENTRIC CABLES	GSCC014 Rev. 00 12/2020

## LOCAL SECTION F – ENEL DISTRIBUIÇÃO (BRASIL)

ITEM	TITLE	DESCRIPTION																		
3.4	Replaced Local Standards	<p><b>E-BT-003 Rev 4.</b> Especificación Técnica: Cables Concéntricos Para Baja Tensión.</p> <p><b>PM-BR 217.22</b> Cabo concêntrico bipolar de cobre (fase/neutro)</p> <p><b>PM-BR 210.13</b> Cabo Concêntrico Bipolar de Alumínio (Fase/Neutro)</p>																		
5.2.1	Insulation Color	<p><b>Core identification:</b> According to HD-603 section 4 standard.</p> <p>The identification colors of the cross-linked polyethylene insulation material should be:</p> <table border="1" style="margin-left: auto; margin-right: auto;"> <thead> <tr> <th>Cable Type</th> <th>Core</th> <th>Color</th> </tr> </thead> <tbody> <tr> <td>Type I</td> <td>1</td> <td>Black</td> </tr> <tr> <td rowspan="2">Type II</td> <td>1</td> <td>Black</td> </tr> <tr> <td>2</td> <td>White</td> </tr> <tr> <td rowspan="3">Type III</td> <td>1</td> <td>White</td> </tr> <tr> <td>2</td> <td>Red</td> </tr> <tr> <td>3</td> <td>Black</td> </tr> </tbody> </table>	Cable Type	Core	Color	Type I	1	Black	Type II	1	Black	2	White	Type III	1	White	2	Red	3	Black
Cable Type	Core	Color																		
Type I	1	Black																		
Type II	1	Black																		
	2	White																		
Type III	1	White																		
	2	Red																		
	3	Black																		
5.6	Outer Sheath Color	The color of Outer sheath must be <b>Black</b> .																		
5.7	Ampacity and Short-circuit rating	<p>The ampacity and short circuit rating must be informed buy the supplier at least for overhead installation, into duct in wall and underground (1m). Any case, the temperature of the insulation and cover cannot be overcome.</p> <p>The ambient air temperature must be 35 °C and time for short-circuit rating teste must be 5 seconds</p>																		
5.8.1	Cable designation	<ul style="list-style-type: none"> <li>• Phase conductor : Aluminum (AL)</li> <li>• Concentric Conductor : Copper wires (CU)</li> <li>• Cross-linked polyethylene insulation: XLPE</li> <li>• Outer sheath: polyolefin (PO)</li> <li>• Nominal cross-sectional area: XXX mm2</li> <li>• Rated voltage: 0,6/1(1,2) kV</li> </ul> <p>Example: 2X10AL+ 6CU mm2 XLPE-PO 0,6/1 (1,2) kV</p>																		

	GLOBAL STANDARD	Page 51 of 54
	LOW VOLTAGE CONCENTRIC CABLES	GSCC014 Rev. 00 12/2020

LOCAL SECTION F – ENEL DISTRIBUIÇÃO (BRASIL)

5.8.2	Markings	<p>The cable shall be marked on the outer sheath every meter of length with the following information:</p> <p>Name of distribution company (<b>ENEL DISTRIBUIÇÃO BRAZIL</b>) STANDARD Name of the manufacturer (NNN) Cable designation (#####) (See 5.8.1) Maximum operating temperature Manufactured year and month (MM/YYYY) Sequential meters markings m (%%) Example:</p> <p>ENEL DISTRIBUIÇÃO BRASIL GSCC014 - SUPPLIER NAME - 2X10AL+ 6CU mm2 XLPE-PO 0,6/1 (1,2) KV 90°C 09/2021 %%m</p>
8	CONDITIONS OF SUPPLY	<p><b>PACKAGING AND LABELING</b></p> <p>The conductor will be delivered by the manufacturer in wood or metal drum, which will not be returned, according to maximum and minimum dimensions shown in Table F.1 and according to the total length of the driver given on each reel may not be less than requested in the purchase order and shall not exceed by more than <math>\pm 5\%</math>. The maximum gross weight of the reel is packed 2,000 kg.</p> <p>It should protect the ends of each cable reel with caps to prevent moisture ingress and must be internally secured to the spool ends, and must be mechanically protected against possible damages from the handling and transport of each reel , leaving both accessible through the use of internal helix or conch in each reel ends.</p> <p>The manufacture shall ensure moisture protection of both visible ends of the conductor, mechanical protection and careful handling of the reels.</p> <p>The wooden spools will be treated according to international requirements for pest control, avoiding the compound " Pentachlorophenol " and " Creosote " . Treatment should include, at least : high toxicity to decay organisms , high penetration and holding power , chemical stability, non-corrosive to metals and substances affecting physical characteristics of the wood and weather protection</p>

LOCAL SECTION F – ENEL DISTRIBUIÇÃO (BRASIL)

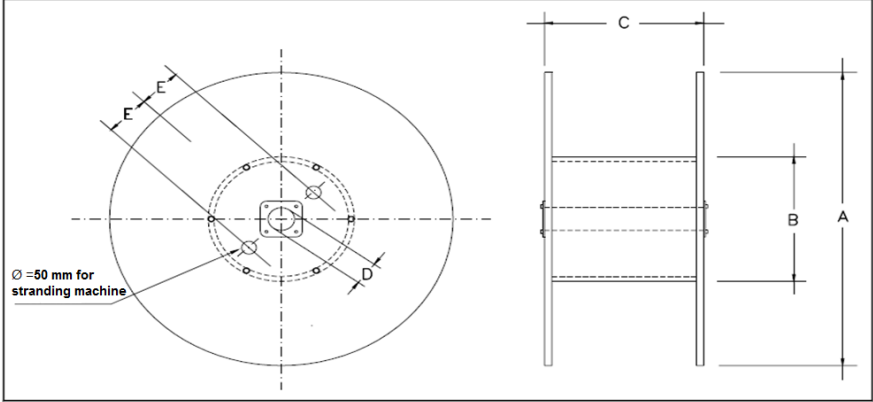
8	<p>CONDITIONS OF SUPPLY (continuation)</p>	<p>Note: The purchase order could specify a maximum length of cable in drum</p>  <p style="text-align: center;">Figure N°10 Trial type</p> <table border="1" style="margin-left: auto; margin-right: auto;"> <thead> <tr> <th style="text-align: center;">A<sup>(1)</sup></th> <th style="text-align: center;">B</th> <th style="text-align: center;">C<sup>(1)</sup></th> <th style="text-align: center;">D<sup>(2)</sup></th> <th style="text-align: center;">E</th> </tr> <tr> <th style="text-align: center;">mm</th> <th style="text-align: center;">mm</th> <th style="text-align: center;">mm</th> <th style="text-align: center;">mm</th> <th style="text-align: center;">mm</th> </tr> </thead> <tbody> <tr> <td style="text-align: center;">1730</td> <td style="text-align: center;">(3)</td> <td style="text-align: center;">1120</td> <td style="text-align: center;">80</td> <td style="text-align: center;">(4)</td> </tr> </tbody> </table> <p style="text-align: center;">Table F.1 Trial dimension</p> <p>Notes:</p> <p>(1) Maximum value.  (2) Minimum value  (3) El Double the minimum cable curvature radius for transportation, in accordance with Manufacturer specifications.  (4) 300 or 180 mm, in accordance with the type of spool (large or small, respectively)</p> <ul style="list-style-type: none"> <li>• Name of distribution company: <b>“ENEL Distribución BRAZIL”</b></li> <li>• Name of the manufacturer</li> <li>• Country of origin of the item</li> <li>• Country code</li> <li>• Description of item</li> <li>• Year and month of manufacture</li> <li>• Number of the spool within the delivered batch.</li> <li>• Cable length, in meters.</li> <li>• the metric initial (m)</li> <li>• the metric final (m)</li> <li>• Manufacture standard</li> <li>• Purchase Order N°</li> <li>• Rated Voltage (0,6/1(1,2 kV))</li> <li>• Insulation material and type</li> <li>• Conductor caliber (mm<sup>2</sup>)</li> <li>• Net weight and gross weight in kg.</li> <li>• Weight of the spool in kg</li> <li>• Weight of one meter of cable in kg</li> <li>• Cable type .</li> <li>• Spool dimension in mm.</li> </ul> <p>The information indicated also shall be presented in a <b>QR CODE</b>.</p>	A <sup>(1)</sup>	B	C <sup>(1)</sup>	D <sup>(2)</sup>	E	mm	mm	mm	mm	mm	1730	(3)	1120	80	(4)
A <sup>(1)</sup>	B	C <sup>(1)</sup>	D <sup>(2)</sup>	E													
mm	mm	mm	mm	mm													
1730	(3)	1120	80	(4)													

## 10 COMMON LIST

GS Type Code	Distribution Company and Country	Country Code	Rated Voltage U <sub>0</sub> /U [kV]	Type of Cable	Formation [n° x mm <sup>2</sup> ]	Phase conductor Cross-section [mm <sup>2</sup> ]	Phase Conductor material	Minimum Number of Wires of Conductor	Minimum conductor diameter [mm]	Maximum conductor diameter [mm]	Insulation Material	Insulation nominal thickness [mm]	Insulation minimum thickness [mm]	Phase Colour	Concentric conductor Cross-section [mm <sup>2</sup> ]	Concentric Conductor material	Minimum Number of Wires of Conductor	Sheath Material	Sheath nominal thickness [mm]	Sheath minimum thickness [mm]	Sheath Colour
GSCC014/001	ED-CHILE	330026	0,6/1,0	I	1 x 6 + 6 C	6	ALUMINUM	1	2,7	2,9	XLPE	1,2	0,98	Black	6	COOPER	18	PO	1,2	0,76	Black
GSCC014/001	RJ/CE/GO/SP -BRAZIL	T330028	0,6/1,0	I	1 x 6 + 6 C	6	ALUMINUM	1	2,7	2,9	XLPE	1,2	0,98	Black	6	COOPER	18	PO	1,2	0,76	Black
GSCC014/001	ED-ARGENTINA	0101-0513	0,6/1,0	I	1 x 6 + 6 C	6	ALUMINUM	1	2,7	2,9	XLPE	1,2	0,98	Black	6	COOPER	18	PO	1,2	0,76	Black
GSCC014/002	ED-ITALY	330026	0,6/1,0	I	1 x 10 + 6 C	10	ALUMINUM	1	3,4	3,7	XLPE	1,2	0,98	Black	6	COOPER	18	PO	1,2	0,76	Gray
GSCC014/002	ED-ROMANIA	330020	0,6/1,0	I	1 x 10 + 6 C	10	ALUMINUM	1	3,4	3,7	XLPE	1,2	0,98	Black	6	COOPER	18	PO	1,2	0,76	Gray
GSCC014/002	ED-CHILE	330025	0,6/1,0	I	1 x 10 + 6 C	10	ALUMINUM	1	3,4	3,7	XLPE	1,2	0,98	Black	6	COOPER	18	PO	1,2	0,76	Black
GSCC014/002	RJ/CE/GO/SP -BRAZIL	T330126	0,6/1,0	I	1 x 10 + 6 C	10	ALUMINUM	1	3,4	3,7	XLPE	1,2	0,98	Black	6	COOPER	18	PO	1,2	0,76	Black
GSCC014/002	ED-ARGENTINA	0101-0512	0,6/1,0	I	1 x 10 + 6 C	10	ALUMINUM	1	3,4	3,7	XLPE	1,2	0,98	Black	6	COOPER	18	PO	1,2	0,76	Black
GSCC014/002	ED-PERU	330019	0,6/1,0	I	1 x 10 + 6 C	10	ALUMINUM	1	3,4	3,7	XLPE	1,2	0,98	Black	6	COOPER	18	PO	1,2	0,76	Black
GSCC014/003	ED-CHILE	330024	0,6/1,0	I	1 x 16 + 10 C	16	ALUMINUM	6	4,6	5,2	XLPE	1,2	0,98	Black	10	COOPER	18	PO	1,4	0,92	Black
GSCC014/003	RJ/CE/GO/SP -BRAZIL	T330125	0,6/1,0	I	1 x 16 + 10 C	16	ALUMINUM	6	4,6	5,2	XLPE	1,2	0,98	Black	10	COOPER	18	PO	1,4	0,92	Black
GSCC014/003	ED-ARGENTINA	0101-0511	0,6/1,0	I	1 x 16 + 10 C	16	ALUMINUM	6	4,6	5,2	XLPE	1,2	0,98	Black	10	COOPER	18	PO	1,4	0,92	Black
GSCC014/003	ED-COLOMBIA	330032	0,6/1,0	I	1 x 16 + 10 C	16	ALUMINUM	6	4,6	5,2	XLPE	1,2	0,98	Black	10	COOPER	18	PO	1,4	0,92	Black
GSCC014/004	ED-ITALY	330025	0,6/1,0	I	1 x 25 + 16 C	25	ALUMINUM	6	5,6	6,5	XLPE	1,2	0,98	Black	16	COOPER	18	PO	1,6	1,08	Gray
GSCC014/004	ED-ROMANIA	330022	0,6/1,0	I	1 x 25 + 16 C	25	ALUMINUM	6	5,6	6,5	XLPE	1,2	0,98	Black	16	COOPER	18	PO	1,6	1,08	Gray
GSCC014/004	RJ/CE/GO/SP -BRAZIL	T330124	0,6/1,0	I	1 x 25 + 16 C	25	ALUMINUM	6	5,6	6,5	XLPE	1,2	0,98	Black	16	COOPER	18	PO	1,6	1,08	Black
GSCC014/005	ED-PERU	330018	0,6/1,0	II	2 x 10 + 6C	10	ALUMINUM	1	3,4	3,7	XLPE	0,7	0,53	Black/Blue	6	COOPER	18	PO	1,2	0,76	Black
GSCC014/005	RJ/CE/GO/SP -BRAZIL	T330123	0,6/1,0	II	2 x 10 + 6C	10	ALUMINUM	1	3,4	3,7	XLPE	0,7	0,53	Black/Blue	6	COOPER	18	PO	1,2	0,76	Black
GSCC014/006	ED-PERU	330017	0,6/1,0	II	2 x 16 + 10C	16	ALUMINUM	6	4,6	5,2	XLPE	0,7	0,53	Black/Blue	10	COOPER	18	PO	1,4	0,92	Black
GSCC014/006	RJ/CE/GO/SP -BRAZIL	T330122	0,6/1,0	II	2 x 16 + 10C	16	ALUMINUM	6	4,6	5,2	XLPE	0,7	0,53	Black/Blue	10	COOPER	18	PO	1,4	0,92	Black
GSCC014/007	ED-ITALY	330024	0,6/1,0	III	3 x 10 + 6 C	10	ALUMINUM	1	3,4	3,7	XLPE	0,7	0,53	Black/Brown/Ligth Blue	6	COOPER	18	PO	1,4	0,92	Gray
GSCC014/007	ED-ROMANIA	330023	0,6/1,0	III	3 x 10 + 6 C	10	ALUMINUM	1	3,4	3,7	XLPE	0,7	0,53	Black/Brown/Ligth Blue	6	COOPER	18	PO	1,4	0,92	Gray
GSCC014/007	RJ/CE/GO/SP -BRAZIL	T330121	0,6/1,0	III	3 x 10 + 6 C	10	ALUMINUM	1	3,4	3,7	XLPE	0,7	0,53	White/Red/Black	6	COOPER	18	PO	1,4	0,92	Black
GSCC014/007	ED-CHILE	330023	0,6/1,0	III	3 x 10 + 6 C	10	ALUMINUM	1	3,4	3,7	XLPE	0,7	0,53	Blue/Black/Red	6	COOPER	18	PO	1,4	0,92	Black
GSCC014/008	RJ/CE/GO/SP -BRAZIL	T330120	0,6/1,0	III	3 x 25 + 16 C	25	ALUMINUM	6	5,6	6,5	XLPE	0,9	0,71	White/Red/Black	16	COOPER	18	PO	2,0	1,4	Black
GSCC014/008	ED-ITALY	330023	0,6/1,0	III	3 x 25 + 16 C	25	ALUMINUM	6	5,6	6,5	XLPE	0,9	0,71	Black/Brown/Ligth Blue	16	COOPER	18	PO	2,0	1,4	Gray
GSCC014/008	ED-ROMANIA	330024	0,6/1,0	III	3 x 25 + 16 C	25	ALUMINUM	6	5,6	6,5	XLPE	0,9	0,71	Black/Brown/Ligth Blue	16	COOPER	18	PO	2,0	1,4	Gray
GSCC014/008	ED-COLOMBIA	330031	0,6/1,0	III	3 x 25 + 16 C	25	ALUMINUM	6	5,6	6,5	XLPE	0,9	0,71	Blue/Red/Yellow	16	COOPER	18	PO	2,0	1,4	Black

COMMON LIST

GS Type Code	Distribution Company and Country	Country Code	Rated Voltage U <sub>0</sub> /U [kV]	Type of Cable	Formation [n° x mm <sup>2</sup> ]	Phase conductor Cross-section [mm <sup>2</sup> ]	Phase Conductor material	Minimum Number of Wires of Conductor	Minimum conductor diameter [mm]	Maximum conductor diameter [mm]	Insulation Material	Insulation nominal thickness [mm]	Insulation minimum thickness [mm]	Phase Colour	Concentric conductor Cross-section [mm <sup>2</sup> ]	Concentric Conductor material	Minimum Number of Wires of Conductor	Sheath Material	Sheath nominal thickness [mm]	Sheath minimum thickness [mm]	Sheath Colour
GSCC014/009	ED-ITALY	330022	0,6/1,0	III	3 x 50 + 25 C	50	ALUMINUM	6	7,7	8,6	XLPE	1	0,8	Black/Brown/Ligth Blue	25	COOPER	20	PO	2,0	1,4	Gray
GSCC014/009	ED-ROMANIA	330025	0,6/1,0	III	3 x 50 + 25 C	50	ALUMINUM	6	7,7	8,6	XLPE	1	0,8	Black/Brown/Ligth Blue	25	COOPER	20	PO	2,0	1,4	Gray
GSCC014/009	ED-COLOMBIA	330030	0,6/1,0	III	3 x 50 + 25 C	50	ALUMINUM	6	7,7	8,6	XLPE	1	0,8	Blue/Red/Yellow	25	COOPER	20	PO	2,0	1,4	Black
GSCC014/009	RJ/CE/GO/SP -BRAZIL	T330105	0,6/1,0	III	3 x 50 + 25 C	50	ALUMINUM	6	7,7	8,6	XLPE	1	0,8	White/Red/Black	25	COOPER	20	PO	2,0	1,4	Black
GSCC014/010	ED-ITALY	330021	0,6/1,0	III	3 x 95 + 35 C	95	ALUMINUM	15	11	12	XLPE	1,1	0,89	Black/Brown/Ligth Blue	35	COOPER	30	PO	2,0	1,4	Gray
GSCC014/010	ED-ROMANIA	330028	0,6/1,0	III	3 x 95 + 35 C	95	ALUMINUM	15	11	12	XLPE	1,1	0,89	Black/Brown/Ligth Blue	35	COOPER	30	PO	2,0	1,4	Gray
GSCC014/010	ED-CHILE	330022	0,6/1,0	III	3 x 95 + 35 C	95	ALUMINUM	15	11	12	XLPE	1,1	0,89	Blue/Black/Red	35	COOPER	30	PO	2,0	1,4	Black
GSCC014/010	RJ/CE/GO/SP -BRAZIL	T330104	0,6/1,0	III	3 x 95 + 35 C	95	ALUMINUM	15	11	12	XLPE	1,1	0,89	White/Red/Black	35	COOPER	30	PO	2,0	1,4	Black
GSCC014/011	ED-ROMANIA	330026	0,6/1,0	III	3 x 150 + 50 C	150	ALUMINUM	15	13,7	15	XLPE	1,4	1,16	Black/Brown/Ligth Blue	50	COOPER	35	PO	2,2	1,56	Gray
GSCC014/011	ED-CHILE	330021	0,6/1,0	III	3 x 150 + 50 C	150	ALUMINUM	15	13,7	15	XLPE	1,4	1,16	Blue/Black/Red	50	COOPER	35	PO	2,2	1,56	Black
GSCC014/012	ED-ROMANIA	330027	0,6/1,0	III	3 x 240 + 95 C	240	ALUMINUM	30	17,6	19,2	XLPE	1,7	1,43	Black/Brown/Ligth Blue	95	COOPER	45	PO	2,4	1,72	Gray
GSCC014/013	ED-COLOMBIA	330029	0,6/1,0	III	3 x 16 + 10 C	16	ALUMINUM	1	3,4	3,7	XLPE	1,2	0,98	Blue/Red/Yellow	16	COOPER	18	PO	2,0	1,4	Black
GSCC014/013	ED-CHILE	330027	0,6/1,0	III	3 x 16 + 10 C	16	ALUMINUM	1	3,4	3,7	XLPE	1,2	0,98	Blue/Black/Red	16	COOPER	18	PO	2,0	1,4	Black
GSCC014/014	ED-COLOMBIA	330028	0,6/1,0	III	3 x 35 + 25 C	35	COOPER	6	6,6	7,5	XLPE	0,9	0,71	Blue/Red/Yellow	25	COOPER	20	PO	2,0	1,4	Black

	GLOBAL STANDARD	Page 1 of 4
	LOW VOLTAGE CONCENTRIC CABLES WITH RATED VOLTAGE $U_0/U(U_m)$ 0,6/1,0 (1,2) kV	GSCC014 Rev. 00 Amendment 02/2023

**LOW VOLTAGE CONCENTRIC CABLES  
WITH RATED VOLTAGE  $U_0/U(U_m)$  0,6/1,0 (1,2) kV  
AMENDMENT**

Revision	Date	List of modifications
00	12/2020	First emission
Amendment	02/2023	The Conductor tensile strength and elongation at break are defined, and additional tests are required to test them; Brasil local section is update.

This Amendment of the Global Standard GSCC014 rev. 0 specifies the requirements applicable to Enel Distribucion Group. They are specified in this document with reference to the same paragraph number of GSCC014 rev.0 (12/2020).

### 5.1 Conductor

The Conductor tensile strength and elongation at break (before stranding and compacting) shall be:

Phase Conductor material Wire	Breaking Load [N/mm <sup>2</sup> ]	Minimum elongation at break (%)		
		0.1 < d ≤ 0.3	0.3 < d ≤ 1.0	d > 1.0
Copper	220/300	15	20	20
Aluminum (d ≥ 1.2 m)	120/190	-	-	1

d being the wire diameter

**Table 9 Conductor tensile strength and elongation at break**

### 6.3 Tests list

The following tests are added only for class 1 conductors.

N°	Test	Requirements	Test Method	R	S	T
35	<p><b>Only for class 1 conductors</b></p> <p><u>Mechanical testing of aluminium core</u></p> <p>Tensile strength</p> <p>- Cross-sectional area (mm<sup>2</sup>) = <math>\frac{\text{Mass(kg) of 1m conductor}}{2700 \text{ kg/m}^3} \times 10^6</math></p> <p>- Sample: 300 mm long</p> <p>- Rate of separation of the grip: Max. 1 cm/s</p> <p>- Distance between the marks on the sample: 200 mm</p> <p>- Tensile strength</p> <p>Elongation at break</p> <p>Winding test for aluminium circular solid conductors</p> <p>- Test cylinder diameter: 10 x diameter of the core</p>	<p>Table 9</p> <p>120 N/mm<sup>2</sup></p> <p>To</p> <p>190 N/mm<sup>2</sup></p> <p>&gt;1%</p> <p>No Crack</p>	<p>HD 605</p> <p>Subclause</p> <p>2.3.1.2</p>	-	X	X
<p>R: Routine test</p> <p>S: Sample test</p> <p>T: Type test</p>						



### LOCAL SECTION F – ENEL DISTRIBUIÇÃO (BRASIL)

ITEM	TITLE	DESCRIPTION																																										
5.10	Bend Radius	Bend Radius according to Standard ABNT NBR 9511 for complete cable. Additionally, phase conductors up to 16mm <sup>2</sup> are required to comply with it.																																										
6.3	Test List	For Brazil, the following tests are required:																																										
		<table border="1"> <thead> <tr> <th>N°</th> <th>Test</th> <th>Requirements</th> <th>Test Method</th> <th>R</th> <th>S</th> <th>T</th> </tr> </thead> <tbody> <tr> <td>36</td> <td>Ensaio de resistência à tração</td> <td>Capítulo 4.8 ABNT NBR 5118:2007</td> <td>ABNT NBR 6810</td> <td>-</td> <td>X</td> <td>X</td> </tr> <tr> <td>37</td> <td>Ensaio de alongamento</td> <td>Capítulo 4.8 ABNT NBR 5118:2007</td> <td>ABNT NBR 6810</td> <td>-</td> <td>X</td> <td>X</td> </tr> <tr> <td>38</td> <td>Ensaio de enrolamento Only for cables having a phase conductor cross-section up to and including 16 mm<sup>2</sup></td> <td>Capítulo 6.4 ABNT NBR 5118:2007</td> <td>ABNT NBR 5118</td> <td>-</td> <td>X</td> <td>X</td> </tr> <tr> <td>39</td> <td>Bend Radius (Complete cable)</td> <td>Capítulo 5 ABNT NBR 9511:2007</td> <td>Dimensional verification according ABNT NBR 9511:2007</td> <td>-</td> <td>X</td> <td>X</td> </tr> <tr> <td>40</td> <td>Bend Radius (Phase Conductor) Only for cables having a phase conductor cross-section up to and including 16 mm<sup>2</sup></td> <td>Capítulo 5 ABNT NBR 9511:2007</td> <td>Dimensional verification according ABNT NBR 9511:2007</td> <td>-</td> <td>X</td> <td>X</td> </tr> </tbody> </table>	N°	Test	Requirements	Test Method	R	S	T	36	Ensaio de resistência à tração	Capítulo 4.8 ABNT NBR 5118:2007	ABNT NBR 6810	-	X	X	37	Ensaio de alongamento	Capítulo 4.8 ABNT NBR 5118:2007	ABNT NBR 6810	-	X	X	38	Ensaio de enrolamento Only for cables having a phase conductor cross-section up to and including 16 mm <sup>2</sup>	Capítulo 6.4 ABNT NBR 5118:2007	ABNT NBR 5118	-	X	X	39	Bend Radius (Complete cable)	Capítulo 5 ABNT NBR 9511:2007	Dimensional verification according ABNT NBR 9511:2007	-	X	X	40	Bend Radius (Phase Conductor) Only for cables having a phase conductor cross-section up to and including 16 mm <sup>2</sup>	Capítulo 5 ABNT NBR 9511:2007	Dimensional verification according ABNT NBR 9511:2007	-	X	X
		N°	Test	Requirements	Test Method	R	S	T																																				
		36	Ensaio de resistência à tração	Capítulo 4.8 ABNT NBR 5118:2007	ABNT NBR 6810	-	X	X																																				
		37	Ensaio de alongamento	Capítulo 4.8 ABNT NBR 5118:2007	ABNT NBR 6810	-	X	X																																				
		38	Ensaio de enrolamento Only for cables having a phase conductor cross-section up to and including 16 mm <sup>2</sup>	Capítulo 6.4 ABNT NBR 5118:2007	ABNT NBR 5118	-	X	X																																				
		39	Bend Radius (Complete cable)	Capítulo 5 ABNT NBR 9511:2007	Dimensional verification according ABNT NBR 9511:2007	-	X	X																																				
		40	Bend Radius (Phase Conductor) Only for cables having a phase conductor cross-section up to and including 16 mm <sup>2</sup>	Capítulo 5 ABNT NBR 9511:2007	Dimensional verification according ABNT NBR 9511:2007	-	X	X																																				
R: Routine test																																												
S: Sample test																																												
T: Type test																																												

### Common List.

	GLOBAL STANDARD	Page 4 of 4
	LOW VOLTAGE CONCENTRIC CABLES WITH RATED VOLTAGE $U_0/U(U_m)$ 0,6/1,0 (1,2) kV	GSCC014 Rev. 00 Amendment 02/2023

The following Country Codes were modified:

GS Type Code	Distribution Company and Country	Old Country Code	New Country Code	Rated Voltage $U_0/U$ [kV]	Type of Cable	Formation [n° x mm <sup>2</sup> ]
GSCC014/001	RJ/CE/GO/SP -BRAZIL	T330028	990323	0,6/1,0	I	1 x 6 + 6 C
GSCC014/002	RJ/CE/GO/SP -BRAZIL	T330126	990346	0,6/1,0	I	1 x 10 + 6 C
GSCC014/003	RJ/CE/GO/SP -BRAZIL	T330125	990345	0,6/1,0	I	1 x 16 + 10 C
GSCC014/004	RJ/CE/GO/SP -BRAZIL	T330124	990344	0,6/1,0	I	1 x 25 + 16 C
GSCC014/005	RJ/CE/GO/SP -BRAZIL	T330123	990343	0,6/1,0	II	2 x 10 + 6C
GSCC014/006	RJ/CE/GO/SP -BRAZIL	T330122	990342	0,6/1,0	II	2 x 16 + 10C
GSCC014/007	RJ/CE/GO/SP -BRAZIL	T330121	990341	0,6/1,0	III	3 x 10 + 6 C
GSCC014/008	RJ/CE/GO/SP -BRAZIL	T330120	990340	0,6/1,0	III	3 x 25 + 16 C
GSCC014/009	RJ/CE/GO/SP -BRAZIL	T330105	990339	0,6/1,0	III	3 x 50 + 25 C
GSCC014/010	RJ/CE/GO/SP -BRAZIL	T330104	990338	0,6/1,0	III	3 x 95 + 35 C