

Application AreasPerimeter: *Global*

Staff Function: -

Service Function: -

Business Line: Enel Grids

CONTENTS

1 Scope	3
1.1 RELATED DOCUMENTS TO BE IMPLEMENTED AT COUNTRY LEVEL	3
2 DOCUMENT VERSION MANAGEMENT	4
3 UNITS IN CHARGE OF THE DOCUMENT	4
4 REFERENCES	4
5 ORGANIZATIONAL PROCESS POSITION IN THE PROCESS TAXONOMY	8
6 DEFINITIONS AND ACRONYMS	8
7 DESCRIPTION	9
7.1 List of Components	9
7.1.1. STANDARD CABLE	9
7.2 Service conditions	15
7.2.1. General service conditions	15
7.2.2. Specific service conditions	15
7.3 Technical characteristics	15
7.3.1. Type of cables	15
7.4 CONSTRUCTION CHARACTERISTICS	18
7.4.1. CONDUCTOR	18
7.4.2. INSULATION	21
7.4.3. Sheath	22
7.5 CONSTRUCTIVE ASPECT	22
7.6 Ampacity and Short-circuit rating	22
7.7 Marking and designation of the cable	22
7.8 TESTING	24
7.8.1. Acceptance tests	24



Technical Specification code: GRI-GRI-MAT-E&C-0021

Version no. 2 dated 12/2022

Subject: GSC009 LOW VOLTAGE AERIAL BUNDLED CABLES.

Application Areas

Perimeter: *Global*

Staff Function: -

Service Function: -

Business Line: Enel Grids

7.8.2. Sampling and acceptance criteria	25
7.8.5. Type test	27
7.9 TECHNICAL CONFORMITY ASSESSMENT	35
7.9.1 General conditions	35
7.9.2 Acknowledgement of TCA for previous revision of the standard.	35
8 LOCAL SECTION	36

THE HEAD OF GLOBAL NETWORK COMPONENTS

Fabrizio Gasbarri

Application Areas

 Perimeter: *Global*

Staff Function: -

Service Function: -

Business Line: Enel Grids

1. SCOPE

The aim of this document is to provide technical requirements for the supply of aerial low voltage cables to be used in the distribution networks in Enel Group Distribution Companies, listed below:

Country	Distribution Company
Argentina	Edesur
Brazil	Enel Distribuição Rio (RJ) Enel Distribuição Ceará (CE) Enel Distribuição Goiás (GO) Enel Distribuição São Paulo (SP)
Chile	Enel Distribución Chile
Colombia	Codensa
Iberia	E-distribución
Italy	E-distribuzione
Perú	Enel Distribución Perú
Romania	E-distributie Banat E-distributie Dobrogea E-distributie Muntenia

Distribution Companies

This standard specifies the construction, dimensions and test requirements that must be accomplished by overhead low voltage distribution cables with rated voltage $U_0/U(U_{max})= 0,6/1 (1,2) \text{ kV}$ used in distribution systems by the utilities mentioned above.

This standard replaces all the local standards used up to now by all the Distribution Companies, as long as local regulation allows it.

This document shall be implemented and applied to the extent possible within the Enel Grids Business Line and in compliance with any applicable laws, regulations and governance rules, including any stock exchange and unbundling-relevant provisions, which in any case prevail over the provisions contained in this document.

1.1 RELATED DOCUMENTS TO BE IMPLEMENTED AT COUNTRY LEVEL

This document does not require implementation of further documents.

Application Areas

 Perimeter: *Global*

Staff Function: -

Service Function: -

Business Line: Enel Grids

2. DOCUMENT VERSION MANAGEMENT

Version	Date	Main changes description
00	15/01/2018	First emission.
01	11/2018	Common list update Insulation thickness and neutral insulation color amendment Maximum diameters in Local section amendment
02	09/2022	Common list update Addition of cables with vegetable sheathing and recycled material

3. UNITS IN CHARGE OF THE DOCUMENT

Responsible for drawing up the document:

- Engineering and Construction / Components and Devices Design unit / Network Components unit

Responsible for authorizing the document:

- Enel Grids: Head of Network Components unit
- Enel Grids: Head of Quality unit.

4. REFERENCES

- Code of Ethics of Enel Group;
- Enel Human Right Policy;
- The Enel Group Zero Tolerance of Corruption (ZTC) Plan;
- Organization and management model as per Legislative Decree No. 231/2001;
- Enel Global Compliance Program (EGCP);
- Stop Work Policy;
- Integrated Policy for Quality, Health and Safety, Environment, anti-Bribery and Information security;
- ISO 9001:2015 - Quality Management System – Requirements;
- ISO 14001:2015 - Environmental Management System - Requirements with guidance for use;
- ISO 45001:2018 - Occupational Health and Safety Management System - Requirements with guidance for use;
- ISO 37001:2016 - Anti-bribery Management System - Requirements with guidance for use;
- ISO 27001:2017 - Information Security Management System – Requirements;
- MAT-O&M-NCS-2021-0033-EGIN version 3 “GSCG002 Technical Conformity Assessment

Application AreasPerimeter: *Global*

Staff Function: -

Service Function: -

Business Line: *Enel Grids*

GLOBAL STANDARDS**LAWS***Brazil*

- *NR-10 - Segurança em Instalações e Serviços em Eletricidade*

Chile

- *NSEG 5 En.71 Reglamento de Instalaciones Eléctricas de Corrientes Fuertes.*

Colombia

- *RETIE, Reglamento Técnico de Instalaciones Eléctricas.*
- *Código Eléctrico Colombiano, NTC 2050*

Peru

- *Código Nacional de Electricidad – Suministro 2011.*
- *Norma Técnica de Calidad de los servicios eléctricos (NTCSE)*

Romania

- *NTE007/08/00 Normativ pentru proiectare și executarea rețelelor de cabluri electrice*

Spain

- *R.D. 614/2001, de 8 de junio, sobre disposiciones mínimas para la protección de la salud y seguridad de los trabajadores frente al riesgo eléctrico.*
- *REAL DECRETO 842/2002, de 2 de agosto, por el que se aprueba el Reglamento Electrotécnico para Baja Tensión e Instrucciones Técnicas Complementarias (R.E.B.T.)*
- *R.D. 337/2014, de 9 de mayo, por el que se aprueban el Reglamento sobre condiciones técnicas y garantías de seguridad en instalaciones eléctricas de alta tensión y sus Instrucciones Técnicas Complementarias ITC-RAT 01 a 23.*
- *Reglamento (UE) nº 305/2011 del Parlamento Europeo y del Consejo, de 9 de marzo de 2011, por el que se establecen condiciones armonizadas para la comercialización de productos de construcción y se deroga la Directiva 89/106/CEE del Consejo.*

EUROPEAN & INTERNATIONAL STANDARDS

- HD 605 S2 “Electric cables - Additional test methods”

Application AreasPerimeter: *Global*

Staff Function: -

Service Function: -

Business Line: *Enel Grids*

- HD 626 S1 “Overhead distribution cables of rated voltage $U_0/U(U_m)$: 0,6/1 (1,2) kV”
- IEC 60228: “Conductors of insulated cables”
- IEC 60502-1:” Power cables with extruded insulation and their accessories for rated voltages from 1 kV up to 30 kV – Part 1: cables for rated voltages of 1 kV and 3 kV”
- IEC 60811-100 “Electric and optical fibre cables - Test methods for non-metallic materials-Part 100: General”
- IEC 60811-201 “Electric and optical fibre cables - Test methods for non-metallic materials-Part 201: General tests - Measurement of insulation thickness”
- IEC 60811-202 “Electric and optical fibre cables - Test methods for non-metallic materials-Part 202: General tests - Measurement of thickness of non-metallic sheath”
- IEC 60811-203 “Electric and optical fibre cables - Test methods for non-metallic materials-Part 203: General tests - Measurement of overall dimensions”
- IEC 60811-401 “Electric and optical fibre cables - Test methods for non-metallic materials-Part 401: Miscellaneous tests - Thermal ageing methods - Ageing in an air oven”
- IEC 60811-402 “Electric and optical fibre cables - Test methods for non-metallic materials-Part 402: Miscellaneous tests - Water absorption tests”
- IEC 60811-403 “Electric and optical fibre cables - Test methods for non-metallic materials-Part 403: Miscellaneous tests - Ozone resistance tests on cross-linked compounds”
- IEC 60811-409 “Electric and optical fibre cables - Test methods for non-metallic materials Part 409: Miscellaneous tests - Loss of mass test for thermoplastic insulations and sheaths
- IEC 60811-501 “Electric and optical fibre cables - Test methods for non-metallic materials-Part 501: Mechanical tests - Tests for determining the mechanical properties of insulating and sheathing compounds”
- IEC 60811-502 “Electric and optical fibre cables - Test methods for non-metallic materials Part 502: Mechanical tests - Shrinkage test for insulations
- IEC 60811-504 “Electric and optical fibre cables - Test methods for non-metallic materials-Part 504: Mechanical tests - Bending tests at low temperature for insulation and sheaths”
- IEC 60811-505 “Electric and optical fibre cables - Test methods for non-metallic materials-Part 505: Mechanical tests - Elongation at low temperature for insulations and sheaths”
- IEC 60811-506 “Electric and optical fibre cables - Test methods for non-metallic materials-Part 506: Mechanical tests - Impact test at low temperature for insulations and sheaths”
- IEC 60811-507 “Electric and optical fibre cables - Test methods for non-metallic materials-Part 507: Mechanical tests - Hot set test for cross-linked materials”
- IEC 60811-605 “Electric and optical fibre cables - Test methods for non-metallic materials-Part 605: Physical tests - Measurement of carbon black and/or mineral filler in polyethylene compounds”



Technical Specification code: GRI-GRI-MAT-E&C-0021

Version no. 2 dated 12/2022

Subject: GSC009 LOW VOLTAGE AERIAL BUNDLED CABLES.

Application Areas

Perimeter: *Global*

Staff Function: -

Service Function: -

Business Line: Enel Grids

- IEC 62230 Electric cables - Spark-test method
- ISO 2859-0 "Sampling procedures for inspection by attributes -- Part 0: Introduction to the ISO 2859 attribute sampling system"
- ISO 2859-1 "Sampling procedures for inspection by attributes -- Part 1: Sampling schemes indexed by acceptance quality limit (AQL) for lot-by-lot inspection"

Application Areas

 Perimeter: *Global*

Staff Function: -

Service Function: -

Business Line: Enel Grids

LOCAL STANDARDS

See local section

REPLACED LOCAL STANDARDS

See local section

5. ORGANIZATIONAL PROCESS POSITION IN THE PROCESS TAXONOMY

Value Chain/Process Area: Engineering and Construction.

Macro Process: Materials management Devices and Components Development

Process: Standard Catalog Management.

6. DEFINITIONS AND ACRONYMS

Acronym and Key words	Description
Acceptable Quality Level (AQL)	The maximum percentage of malfunctions that can be detected during a sample inspection and can still be considered satisfactory
Low Voltage (LV)	Any set of nominal voltage levels in the range 0,5 to 1 kV AC or 120 to 1500 V DC
Technical Conformity Assessment (TCA)	A “conformity assessment”with respect to “specified requirements” ¹ consists in functional, dimensional, constructional and test characteristics required for a product (or a series of products) and quoted in technical specifications and quality requirements issued by Enel Group distribution companies. This also includes the verification of conformity with respect to local applicable regulation and laws and possession of relevant requested certifications

Tabella 1

Application Areas

 Perimeter: *Global*

Staff Function: -

Service Function: -

 Business Line: *Enel Grids*
7. DESCRIPTION
7.1 LIST OF COMPONENTS
7.1.1. STANDARD CABLE

GS Type Code	Country	Country Code	Formation	Cross-section	Type of cable	Conductor material	Minimum Number of Wires of Conductor	Minimum conductor diameter [mm]	Maximum conductor diameter [mm]	Insulation material	Nominal insulation thickness [mm]	Minimum insulation thickness [mm]	Insulation color	Sheath material	Sheath nominal thickness [mm]	Sheath minimum thickness [mm]	Sheath color	Messenger material	Minimum Number of Wires in the Messenger	Messenger Cross-section	Minimum Messenger diameter [mm]	Maximum Messenger diameter [mm]	Messenger Nominal insulation thickness [mm]	Messenger minimum insulation thickness [mm]
GSCC009/001	AR	0101-0472	2x16	16	I	Aluminum	6	4,6	5,2	XLPE	1,2	0,98	Black	-	-	-	-	-	-	-	-	-	-	-
GSCC009/001	CL	330189	2x16	16	I	Aluminum	6	4,6	5,2	XLPE	1,2	0,98	Black	-	-	-	-	-	-	-	-	-	-	-
GSCC009/001	PE	330579	2x16	16	I	Aluminum	6	4,6	5,2	XLPE	1,2	0,98	Black	-	-	-	-	-	-	-	-	-	-	-
GSCC009/001	ES	330042	2x16	16	I	Aluminum	6	4,6	5,2	XLPE	1,2	0,98	Black	-	-	-	-	-	-	-	-	-	-	-
GSCC009/001	BR	330785	1x16+16	16	I	Aluminum	6	4,6	5,2	XLPE	1,2	0,98	Black	-	-	-	-	-	-	-	-	-	-	-
GSCC009/002	AR	0101-0471	4x16	16	I	Aluminum	6	4,6	5,2	XLPE	1,2	0,98	Black	-	-	-	-	-	-	-	-	-	-	-
GSCC009/004	ES	330043	4x25	25	I	Aluminum	6	5,6	6,5	XLPE	1,4	1,16	Black	-	-	-	-	-	-	-	-	-	-	-
GSCC009/004	BR	331276	4x25	25	I	Aluminum	6	5,6	6,5	XLPE	1,4	1,16	Black	-	-	-	-	-	-	-	-	-	-	-
GSCC009/004	BR (SP)	324066	4x25	25	I	Aluminum	6	5,6	6,5	XLPE	1,4	1,16	Black, Red grey and blue messenger	-	-	-	-	-	-	-	-	-	-	-
GSCC009/005	CO	330679	1x35+54,6	35	II	Aluminum	6	6,6	7,5	XLPE	1,6	1,34	Black	-	-	-	-	AL2	7	54,6	9,2	9,8	1,6	1,34
GSCC009/006	CO	330676	2x25+54,6	25	II	Aluminum	6	5,6	6,5	XLPE	1,4	1,16	Black	-	-	-	-	AL2	7	54,6	9,2	9,8	1,6	1,34
GSCC009/007	CO	330677	2x50+54,6	50	II	Aluminum	6	7,7	8,6	XLPE	1,6	1,34	Black	-	-	-	-	AL2	7	54,6	9,2	9,8	1,6	1,34

Application Areas

 Perimeter: *Global*

Staff Function: -

Service Function: -

Business Line: Enel Grids

GS Type Code	Country	Country Code	Formation	Cross-section	Type of cable	Conductor material	Minimum Number of Wires of Conductor	Minimum conductor diameter [mm]	Maximum conductor diameter [mm]	Insulation material	Nominal insulation thickness [mm]	Minimum insulation thickness [mm]	Insulation color	Sheath material	Sheath nominal thickness [mm]	Sheath minimum thickness [mm]	Sheath color	Messenger material	Minimum Number of Wires in the Messenger	Messenger Cross-section	Minimum Messenger diameter [mm]	Maximum Messenger diameter [mm]	Messenger Nominal insulation thickness [mm]	Messenger minimum insulation thickness [mm]
GSCC009/007	BR (SP)	324067	2x50+54,6	50	II	Aluminum	6	7,7	8,6	XLPE	1,6	1,34	Black, Red grey and blue messenger	-	-	-		AL2	7	54,6	9,2	9,8	1,6	1,34
GSCC009/008	CO	330678	3x25+54,6	25	II	Aluminum	6	5,6	6,5	XLPE	1,4	1,16	Black	-	-	-		AL2	7	54,6	9,2	9,8	1,6	1,34
GSCC009/008	AR	0101-0248	3x25+54,6	25	II	Aluminum	6	5,6	6,5	XLPE	1,4	1,16	Black	-	-	-		AL2	7	54,6	9,2	9,8	1,6	1,34
GSCC009/008	CL	330190	3x25+54,6	25	II	Aluminum	6	5,6	6,5	XLPE	1,4	1,16	Black	-	-	-		AL2	7	54,6	9,2	9,8	1,6	1,34
GSCC009/009	CO	330666	3x35+54,6	35	II	Aluminum	6	6,6	7,5	XLPE	1,6	1,34	Black	-	-	-		AL2	7	54,6	9,2	9,8	1,6	1,34
GSCC009/009	CL	330191	3x35+54,6	35	II	Aluminum	6	6,6	7,5	XLPE	1,6	1,34	Black	-	-	-		AL2	7	54,6	9,2	9,8	1,6	1,34
GSCC009/009	PE	330577	3x35+54,6	35	II	Aluminum	6	6,6	7,5	XLPE	1,6	1,34	Black	-	-	-		AL2	7	54,6	9,2	9,8	1,6	1,34
GSCC009/009	BR	330993	3x35+54,6	35	II	Aluminum	6	6,6	7,5	XLPE	1,6	1,34	Black	-	-	-		AL2	7	54,6	9,2	9,8	1,6	1,34
GSCC009/010	AR	0101-0249	3x50+54,6	50	II	Aluminum	6	7,7	8,6	XLPE	1,6	1,34	Black	-	-	-		AL2	7	54,6	9,2	9,8	1,6	1,34
GSCC009/010	CL	330192	3x50+54,6	50	II	Aluminum	6	7,7	8,6	XLPE	1,6	1,34	Black	-	-	-		AL2	7	54,6	9,2	9,8	1,6	1,34
GSCC009/010	ES	330044	3x50+54,6	50	II	Aluminum	6	7,7	8,6	XLPE	1,6	1,34	Black	-	-	-		AL2	7	54,6	9,2	9,8	1,6	1,34
GSCC009/010	BR	330994	3x50+54,6	50	II	Aluminum	6	7,7	8,6	XLPE	1,6	1,34	Black	-	-	-		AL2	7	54,6	9,2	9,8	1,6	1,34

Application Areas

 Perimeter: *Global*

Staff Function: -

Service Function: -

 Business Line: *Enel Grids*

GS Type Code	Country	Country Code	Formation	Cross-section	Type of cable	Conductor material	Minimum Number of Wires of Conductor	Minimum conductor diameter [mm]	Maximum conductor diameter [mm]	Insulation material	Nominal insulation thickness [mm]	Minimum insulation thickness [mm]	Insulation color	Sheath material	Sheath nominal thickness [mm]	Sheath minimum thickness [mm]	Sheath color	Messenger material	Minimum Number of Wires in the Messenger	Messenger Cross-section	Minimum Messenger diameter [mm]	Maximum Messenger diameter [mm]	Messenger Nominal insulation thickness [mm]	Messenger minimum insulation thickness [mm]
GSCC009/010	BR (SP)	324068	3x50+54,6	50	II	Aluminum	6	7,7	8,6	XLPE	1,6	1,34	Black, Red grey and blue messenger	-	-	-		AL2	7	54,6	9,2	9,8	1,6	1,34
GSCC009/011	CO	330680	3x70+54,6	70	II	Aluminum	12	9,3	10,2	XLPE	1,8	1,52	Black	-	-	-		AL2	7	54,6	9,2	9,8	1,6	1,34
GSCC009/011	CL	330193	3x70+54,6	70	II	Aluminum	12	9,3	10,2	XLPE	1,8	1,52	Black	-	-	-		AL2	7	54,6	9,2	9,8	1,6	1,34
GSCC009/012	CO	330661	3x95+54,6	95	II	Aluminum	15	11	12	XLPE	1,8	1,52	Black	-	-	-		AL2	7	54,6	9,2	9,8	1,6	1,34
GSCC009/012	AR	0101-0247	3x95+54,6	95	II	Aluminum	15	11	12	XLPE	1,8	1,52	Black	-	-	-		AL2	7	54,6	9,2	9,8	1,6	1,34
GSCC009/012	CL	310168	3x95+54,6	95	II	Aluminum	15	11	12	XLPE	1,8	1,52	Black	-	-	-		AL2	7	54,6	9,2	9,8	1,6	1,34
GSCC009/012	PE	330576	3x95+54,6	95	II	Aluminum	15	11	12	XLPE	1,8	1,52	Black	-	-	-		AL2	7	54,6	9,2	9,8	1,6	1,34
GSCC009/012	ES	330045	3x95+54,6	95	II	Aluminum	15	11	12	XLPE	1,8	1,52	Black	-	-	-		AL2	7	54,6	9,2	9,8	1,6	1,34
GSCC009/012	BR	330984	3x95+54,6	95	II	Aluminum	15	11	12	XLPE	1,8	1,52	Black	-	-	-		AL2	7	54,6	9,2	9,8	1,6	1,34
GSCC009/012	BR (SP)	324065	3x95+54,6	95	II	Aluminum	15	11	12	XLPE	1,8	1,52	Black, Red grey and blue messenger	-	-	-		AL2	7	54,6	9,2	9,8	1,6	1,34
GSCC009/013	BR	330990	3x150+80	150	II	Aluminum	15	13,9	15	XLPE	1,8	1,52	Black	-	-	-		AL2	19	80	11,2	12	1,8	1,52
GSCC009/013	CO	330681	3x150+80	150	II	Aluminum	15	13,9	15	XLPE	1,8	1,52	Black	-	-	-		AL2	19	80	11,2	12	1,8	1,52

Application Areas

 Perimeter: *Global*

Staff Function: -

Service Function: -

Business Line: Enel Grids

GS Type Code	Country	Country Code	Formation	Cross-section	Type of cable	Conductor material	Minimum Number of Wires of Conductor	Minimum conductor diameter [mm]	Maximum conductor diameter [mm]	Insulation material	Nominal insulation thickness [mm]	Minimum insulation thickness [mm]	Insulation color	Sheath material	Sheath nominal thickness [mm]	Sheath minimum thickness [mm]	Sheath color	Messenger material	Minimum Number of Wires in the Messenger	Messenger Cross-section	Minimum Messenger diameter [mm]	Maximum Messenger diameter [mm]	Messenger Nominal insulation thickness [mm]	Messenger minimum insulation thickness [mm]
GSCC009/013	AR	0101-0251	3x150+80	150	II	Aluminum	15	13,9	15	XLPE	1,8	1,52	Black	-	-	-		AL2	19	80	11,2	12	1,8	1,52
GSCC009/013	ES	330046	3x150+80	150	II	Aluminum	15	13,9	15	XLPE	1,8	1,52	Black	-	-	-		AL2	19	80	11,2	12	1,8	1,52
GSCC009/013	BR (SP)	324064	3x150+80	150	II	Aluminum	15	13,9	15	XLPE	1,8	1,52	Black, Red grey and blue messenger	-	-	-		AL2	19	80	11,2	12	1,8	1,52
GSCC009/014	IT	339061	2x16	16	III	Aluminum	7	4,6	5,2	XLPE	1,3	1,07	Black	XLPE	0,2	0,1	Grey	-	-	-	-	-	-	-
GSCC009/014	RO	339061	2x16	16	III	Aluminum	7	4,6	5,2	XLPE	1,3	1,07	Black	XLPE	0,2	0,1	Grey	-	-	-	-	-	-	-
GSCC009/015	IT	339063	4x16	16	III	Aluminum	7	4,6	5,2	XLPE	1,3	1,07	Black	XLPE	0,2	0,1	Grey	-	-	-	-	-	-	-
GSCC009/015	RO	339063	4x16	16	III	Aluminum	7	4,6	5,2	XLPE	1,3	1,07	Black	XLPE	0,2	0,1	Grey	-	-	-	-	-	-	-
GSCC009/016	IT	339012	3x35+54,6	35	IV	Aluminum	6	6,6	7,5	XLPE	1,6	1,34	Black	XLPE	0,2	0,1	Grey	AL2	7	54,6	9,2	9,8	1,6	1,34
GSCC009/016	RO	339012	3x35+54,6	35	IV	Aluminum	6	6,6	7,5	XLPE	1,6	1,34	Black	XLPE	0,2	0,1	Grey	AL2	7	54,6	9,2	9,8	1,6	1,34
GSCC009/017	IT	339013	3x70+54,6	70	IV	Aluminum	12	9,3	10,2	XLPE	1,6	1,34	Black	XLPE	0,2	0,1	Grey	AL2	7	54,6	9,2	9,8	1,6	1,34
GSCC009/017	RO	339013	3x70+54,6	70	IV	Aluminum	12	9,3	10,2	XLPE	1,6	1,34	Black	XLPE	0,2	0,1	Grey	AL2	7	54,6	9,2	9,8	1,6	1,34
GSCC009/018	PE	330580	3x35+2x16+54,6		II	Aluminum	6	6,6	7,5	XLPE	1,6	1,34	Black	-	-	-		AL2	7	54,6	9,2	9,8	1,6	1,34

GS Type Code	Country	Country Code	Formation	Cross-section	Type of cable	Conductor material	Minimum Number of Wires of Conductor	Minimum conductor diameter [mm]	Maximum conductor diameter [mm]	Insulation material	Nominal insulation thickness [mm]	Minimum insulation thickness [mm]	Insulation color	Sheath material	Sheath nominal thickness [mm]	Sheath minimum thickness [mm]	Sheath color	Messenger material	Minimum Number of Wires in the Messenger	Messenger Cross-section	Minimum Messenger diameter [mm]	Maximum Messenger diameter [mm]	Messenger Nominal insulation thickness [mm]	Messenger minimum insulation thickness [mm]
GSCC009/019	PE	330578	3x95+2x16+54,6		II	Aluminum	15	11	12	XLPE	1,8	1,52	Black	-	-	-		AL2	7	54,6	9,2	9,8	1,6	1,34
GSCC009/020	BR (SP)	324062	2X1X10+10MM ²	10	II	Aluminum	1	3,7	4,1	XLPE	1,2	0,98	Black, Red grey and blue messenger	-	-	-		Aluminum 1350 H19	7	10	4,1	4,6	1,2	0,98
GSCC009/021	BR (SP)	324070	3X1X10+10MM ²	10	II	Aluminum	1	3,7	4,1	XLPE	1,2	0,98	Black, Red grey and blue messenger	-	-	-		Aluminum 1350 H19	7	10	4,1	4,6	1,2	0,98
GSCC009/022	BR (SP)	324056	2X1X10MM ²	10	I	Aluminum	1	3,7	4,1	XLPE	1,2	0,98	Black, Red grey and blue messenger	-	-	-		-	-	-	-	-	-	-
GSCC009/023	BR (SP)	324069	3x1x25	25	I	Aluminum	6	5,6	6,5	XLPE	1,4	1,16	Black, Red grey and blue messenger	-	-	-		-	-	-	-	-	-	-
GSCC009/024	BR (SP)	324053	2x25	25	I	Aluminum	6	5,6	6,5	XLPE	1,4	1,16	Black, Red grey and blue messenger	-	-	-		-	-	-	-	-	-	-
GSCC009/025	BR (SP)	324071	2x70+70	70	II	Aluminum	12	9,3	10,2	XLPE	1,8	1,52	Black, Red grey and blue messenger	-	-	-		Aluminum alloy	7	70	10,35	10,9	1,6	1,34

Table 2 Common List

Application Areas

Perimeter: *Global*

Staff Function: -

Service Function: -

Business Line: Enel Grids

The cables included in the following table must be used exclusively for the maintenance of existing sections of the distribution network

TECHNICAL SPECIFICATION	GS Type Code	Distribution Company	Country Code	Formation	Cross-section	Type of cable	Conductor material	Minimum Number of Wires of Conductor	Minimum conductor diameter [mm]	Maximum conductor diameter [mm]	Insulation material	Nominal insulation thickness [mm]	Minimum insulation thickness [mm]	Outer sheath material	Sheath nominal thickness [mm]	Sheath minimum thickness [mm]	Constructive Characteristics
GSCC009	GSCC009/026	BR (SP)	323415	1x50	50	V	Copper	19	7,7	8,6	XLPE	1,6	1,34				Unipolar
GSCC009	GSCC009/027	BR (SP)	323121	1x70	70	V	Copper	19	9,3	10,2	XLPE	1,8	1,52				Unipolar
GSCC009	GSCC009/028	BR (SP)	323423	1x120	120	V	Copper	37	12,3	13,5	XLPE	1,8	1,52				Unipolar

Table 3 Common List for for the maintenance

Application Areas

 Perimeter: *Global*

Staff Function: -

Service Function: -

Business Line: Enel Grids

7.2 SERVICE CONDITIONS

7.2.1. General service conditions

See local section

7.2.2. Specific service conditions

Colombia (Enel Distribución Colombia): the reference altitude is 2.700 m

7.3 TECHNICAL CHARACTERISTICS

7.3.1. Type of cables

The typical layout of cable is shown in Figure 1, in Figure 2, Figure 3 and Figure 4.

The different parts of the cables are depicted in section 7.4.

In Table 1 Types of cables specified in this document are briefly depicted.

TYPE	DESCRIPTION
I	Aluminum conductor XLPE insulated self-supporting cables.
II	Cables with aluminum phase conductor insulated with XLPE supported by an aluminum alloy neutral conductor insulated with XLPE
III	Aluminum conductor XLPE insulated and sheathed self-supporting cables.
IV	Cables with aluminum phase conductor insulated and sheathed with XLPE supported by an aluminum alloy XLPE insulated neutral messenger.
V	Unipolar cables with Copper conductor, XLPE insulation used for maintenance

Table 4 Types of Cables

Application Areas

Perimeter: *Global*

Staff Function: -

Service Function: -

Business Line: Enel Grids

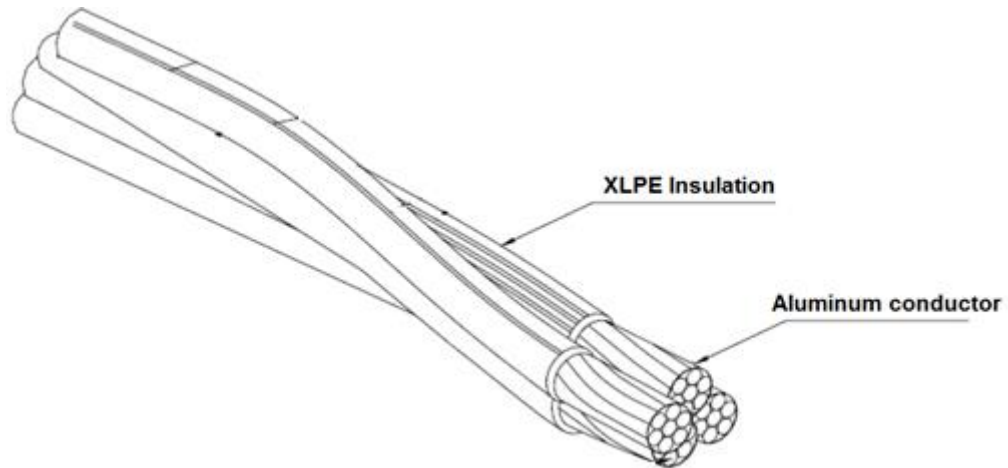

Figure 1 Type I LV self-supported cable.

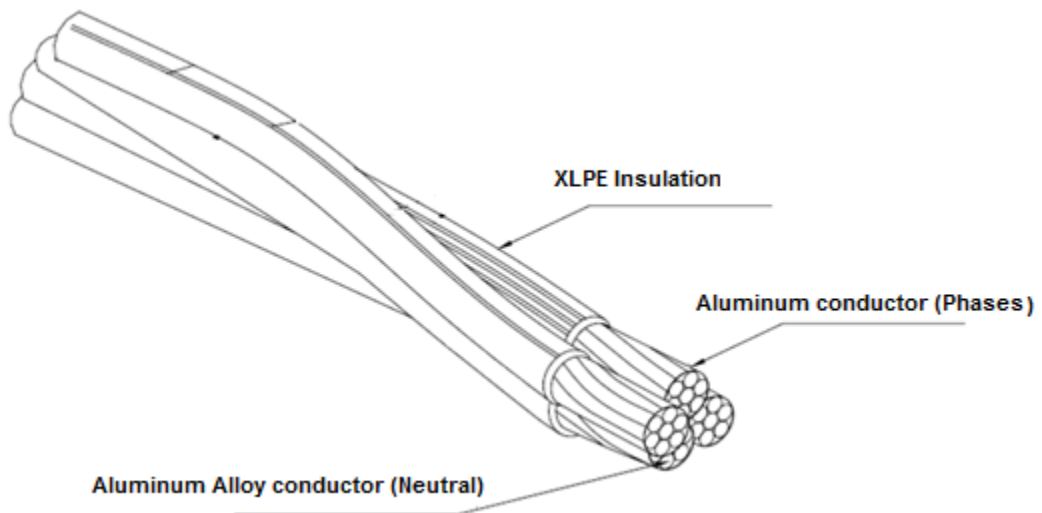

Figure 2 Type II LV neutral supported cable XLPE.

Application Areas

Perimeter: *Global*

Staff Function: -

Service Function: -

Business Line: Enel Grids

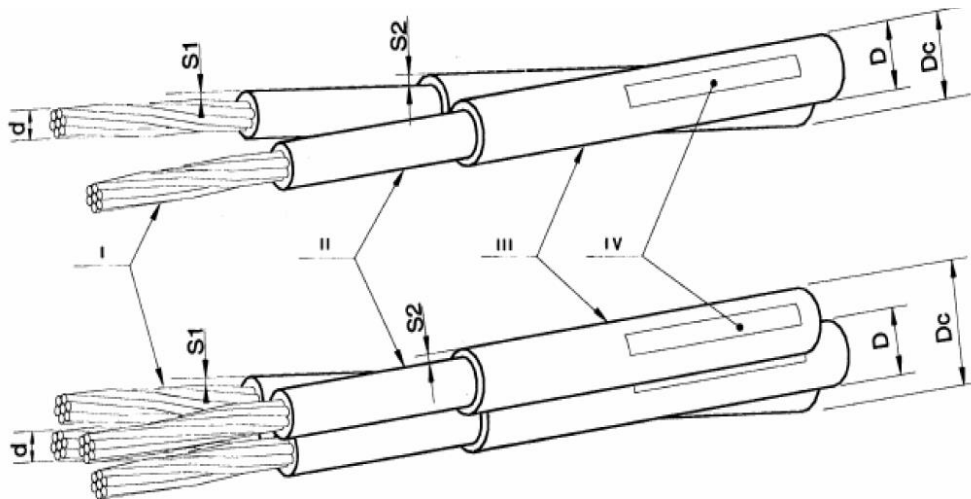

- I – Al conductor
- II – XLPE Insulation

- III – XLPE Sheath
- IV – Marking

Figure 3 Type III LV self-supported cable.

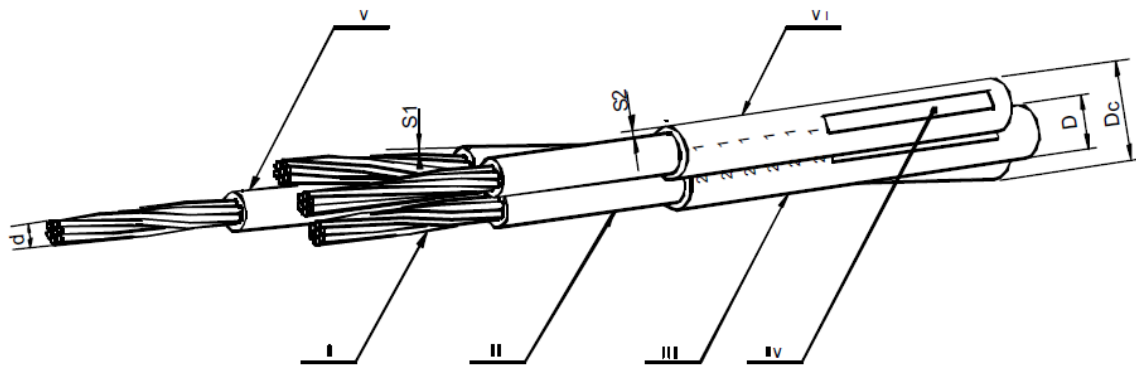

- I – Al phase conductor
- II – XLPE Insulation
- III – XLPE Sheath

- IV – Marking
- V – Al alloy Neutral core
- VI – Phase core

Figure 4 Type IV LV neutral supported cable.

Application Areas

Perimeter: *Global*

Staff Function: -

Service Function: -

Business Line: Enel Grids

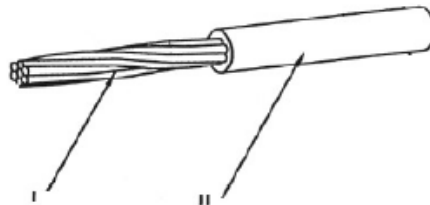

I – Cu conductor

II – XLPE Insulation

Figure 5 Type V cable for maintenance

Note: Figures are for illustrative purposes only.

For each of these cable types, is defined as a sustainable equivalent :

- Cable whose outer sheath is made of polyolefin of vegetable origin;
- Cables with a percentage of recycled material (in the conductor and/or sheathing)

7.4 CONSTRUCTION CHARACTERISTICS

7.4.1.CONDUCTOR

For **Type III** cables the conductors shall be stranded circular non-compacted (Class 2) made of aluminum with 99,5% purity degree.

For **Type I, Type II & Type IV** cables the phase conductors shall be stranded compacted circular (Class 2) made of aluminum with 99,5% purity degree.

Aluminum conductors shall comply all the features specified herein and in standard IEC 60228.

If required, the distance between welding points of the aluminum conductor shall not be less than:

- 15 m between two welding points of the whole conductor
- 200 m between two welding points of the external layer

For **Type V** the copper conductors shall be stranded compacted circular class 2, complying all the features specified herein and in standard IEC 60228.

On the other hand, for neutral supported cables (**Type II & Type IV**) aluminum alloy neutral conductor shall be stranded circular non-compacted, made with wires that shall comply all features specified in standard EN 50183, specifically for AL2 type.

Application Areas

 Perimeter: *Global*

Staff Function: -

Service Function: -

Business Line: Enel Grids

Welding points are forbidden in the central wire. However, welding points in other layers are permitted as long as the distance between welding is not less than:

- 50 m between two welding points of the whole conductor.
- 200 m between two welding point in the external layer

In Table 2 and Table 3 aluminum and aluminum alloy conductor characteristics are shown.

Nominal cross-section [mm ²]	Minimum number of wires	Diameter of conductors [mm]		Maximum resistance of conductor at 20°C [Ω/km]
		Minimum	Maximum	
16	6(7)*	4,6	5,2	1,91
25	6(7)*	5,6	6,5	1,20
35	6	6,6	7,5	0,868
50	6	7,7	8,6	0,641
54,6**	7	9,2	9,8	0,630
70	12	9,3	10,2	0,443
80**	19	11,2	12	0,437
95	15	11,0	12,0	0,320
150	15	13,9	15,0	0,206

*(7) For non-compacted conductors
 **Aluminum alloy conductor used for neutral cores

Table 5 Characteristics of aluminum and aluminum alloy conductors.

Nominal cross-section [mm ²]	Minimum number of wires	Diameter of conductors [mm]		Maximum resistance of conductor at 20°C [Ω/km]
		Minimum	Maximum	
50	19	7,7	8,6	0,387
70	19	9,3	10,2	0,268
120	37	12,3	13,5	0,153

Table 6 Characteristics of copper conductors

The lay direction of conductors external layer shall be right hand “Z” direction.

Application Areas

 Perimeter: *Global*

Staff Function: -

Service Function: -

Business Line: Enel Grids

Messenger conductor (Type II & Type IV)			
Material	AL2 EN 50183		
Stranding Type	Non-compacted		
Tensile strength of the individual wires (See EN 50183)	$\geq(325) \text{ N/mm}^2$		
Cross-section	[mm ²]	54,6	80
Wire nominal diameter	[mm]	3,15 ±0,03 mm	2,32 ±0,03 mm
Coefficient of linear thermal expansion	[°C ⁻¹]	23·10 ⁻⁶	
Young modulus	[MPa]	62.000	

Table 7 Neutral supporting conductor additional features.

The conductor material (Copper or Aluminum) shall contain minimum 10% of recycled material.

The conductor contained recycled material, shall be compliant with the characteristics required in this Global Standard.

Application Areas

 Perimeter: *Global*

Staff Function: -

Service Function: -

Business Line: Enel Grids

7.4.2.INSULATION

The insulation shall be applied by a suitable extrusion process, and shall form a compact and homogenous body, it shall not penetrate beyond the external layer of the conductor. In addition, it shall be possible to remove without creating any damage to the conductor.

The insulating material shall be cross-linked polyethylene (XLPE), compliant with the characteristics required herein this document.

The insulation must allow maximum conductor temperatures of 90 °C in normal operation and 250 °C under short circuit condition by at least 5 seconds.

The minimum thickness of insulation measured and accepted at any point of the cable shall not be less than 90% of the nominal value minus 0,1 mm. In addition, the average of all these measures should not be less than the nominal thickness.

$$t_{min} \geq 0,9 t_n - 0,1$$

Where:

t_{min} : minimum insulation thickness in millimeters

t_n : nominal thickness in millimeters

If there is any separator between the conductor and insulation it shall not be considered when the insulation thickness measurement is performed.

Cross-section [mm ²]	Type I and Type II		Type III and Type IV	
	Insulation nominal thickness [mm]	Insulation minimum thickness [mm]	Insulation nominal thickness [mm]	Insulation minimum thickness [mm]
16	1,2	0,98	1,3	1,07
25	1,4	1,16	1,3	1,07
35	1,6	1,34	1,6	1,34
50	1,6	1,34	1,6	1,34
70	1,8	1,52	1,6	1,34
95	1,8	1,52	1,8	1,52
150	1,8	1,52	1,8	1,52
54,6*	1,6	1,34	1,6	1,34
80*	1,8	1,52	1,8	1,52

*Aluminum alloy conductor used for neutral cores

Table 8 XLPE insulation thickness.

The insulation color shall be **black**.

Application Areas

Perimeter: *Global*

Staff Function: -

Service Function: -

Business Line: Enel Grids

For **Type IV** cables the insulation color of the neutral core shall be grey RAL 7001

7.4.3. Sheath

The following indications are only applied to **Type III** and **Type IV** cables on phase cores.

The outer sheath material shall be appropriate for normal operation at 90°C. In addition, it shall be resistant to moisture, abrasion, and solar radiation.

The outer sheath compound shall be made of cross-linked polyethylene (XLPE) compliant with the characteristic required herein in this document. In addition it shall be adhered to the insulation.

The minimum thickness of the outer sheath measured and accepted at any point of the cable shall not be less than 0,1 mm, and the average of all these measures should not be less than the nominal thickness.

Using a separator between insulation material and the outer sheath is not admitted.

Cross-section [mm²]	Sheath nominal thickness [mm]	Sheath minimum thickness [mm]	Color
All	0,2	0,1	Grey RAL 7001

Table 9 XLPE sheath thickness and color

ENEL could accept outer sheath compound of vegetable origin. Also outer sheath with recycled material could be accepted (minimum 30%).

Whether for the solution with PO of vegetable origin or recycled outer sheath, compound shall be compliant with the characteristics required in this Global Standard.

7.5 CONSTRUCTIVE ASPECT

Unless otherwise indicated in Local sections the following indications shall be followed:

For Type I & Type III cables the cores shall be bundled to the right (clockwise). The lay ratio shall be 15 up to 20 per the overall diameter of the bundled cores.

For Type II & Type IV cables the phase cores shall be bundled around the neutral core to the right (clockwise). The lay ratio shall be 25 up to 30 per the overall diameter of the configuration.

7.6 AMPACITY AND SHORT-CIRCUIT RATING

See local section.

7.7 MARKING AND DESIGNATION OF THE CABLE

7.7.1. Cable designation

The cable designation shall be the following:

- Aluminum conductor: A

Application AreasPerimeter: *Global*

Staff Function: -

Service Function: -

Business Line: Enel Grids

- Stranded compacted circular conductors: R
- Cross-linked polyethylene insulation: E4
- Polyolefin sheath: E
- Bundled assemble cores (if Type II): X
- Assigned voltage of the cable expressed in kV: Uo/U
- Nominal cross-section of the conductor

7.7.2. Marking

The marking must be indelible, easily legible and carried out by engraving or in relief above the surface of the outer sheath in a continuous way.

The distance between the end of the mark and the beginning of the next identical mark does not exceed 550 mm.

For Endesa, see the local section.

The cable marking shall contain:

- Property name: ENEL
- Cable designation: see 7.7.1
- Reaction to fire class (if applicable)
- Manufacturer name or trademark: XXXXX
- Identification of the production plant with a different letter of the alphabet: B
- Year and month of manufacturing (2022 12):
- Metric marking It is put only on the core sheath of "PHASE 1" in the multipolar cables with visible helix.

The inscription can be put on a cable surface other than that of the other inscriptions and it can also be made with ink.

- Core identification (FASE X) for Type II: to be placed on the sheath of each core. It shall be repeated at least every 100 mm in the intervals between two subsequent series of inscriptions. The inscription shall be repeated with a step no greater than 100mm on a cable surface other than that of the inscriptions.

Core identification could be made with ink.

For E-distribución, for cable designation and marking, see the local section.

For Codensa, in marking include also Maximum operating temperature (**according RETIE**).

Marking Example:

- Type III cables 2x16 configuration

Phase core:

ENEL ARE4*E4*X-0,6/1 kV 16 CPR XXXXX B 01 2017 12 0000 FASE FASE

Application AreasPerimeter: *Global*

Staff Function: -

Service Function: -

Business Line: Enel Grids

Neutral core

ENEL ARE4*E4*X-0,6/1 kV 16 CPR XXXXX B 01 2017 12

b) Type III cables 4x16 configuration

Phase core 1:

ENEL ARE4*E4*X-0,6/1 kV 16 CPR XXXXX B 01 2017 12 0000 FASE 1 FASE 1

Phase core 2 or 3:

ENEL ARE4*E4*X-0,6/1 kV 16 CPR XXXXX B 01 2017 12 FASE X FASE X

Neutral core

ENEL ARE4*E4*X-0,6/1 kV 16 CPR XXXXX B 01 2017 12

c) Type IV cables

Phase core 1, 2 or 3:

ENEL ARE4*E4*X*-0,6/1 kV 35 CPR XXXXX B 01 2017 12 FASE X FASE X

Neutral core:

ENEL ARE4*-0,6/1 kV 54,6 CPR XXXXX B 01 2003 12 0000

For cables containing recycled material and cables containing polyolefin of vegetable origin, this information must be included in the marking at the end (Green PO, Recycled PO, RECYCLED Al...)

7.8 TESTING

For **Endesa** cables test shall be performed according to standard **UNE 21030**.

7.8.1. Acceptance tests

Acceptance tests shall be carried out in the Supplier's facilities and are divided into two types with different sampling criteria, routine test and sample test.

7.8.1.1 Routine tests

Routine tests shall be performed at 100% of delivered spools

The Routine tests are those indicated in par.7.8.5.1 and 7.8.5.2.

7.8.1.2 Sample test

Sample tests are carried out over samples taken from a complete cable (See **Table 10** in sub-clause 7.8.2 for sampling).

The Sample tests are those indicated in par.7.8.5.1 and 7.8.5.2.

Application Areas

 Perimeter: *Global*

Staff Function: -

Service Function: -

Business Line: Enel Grids

7.8.2. Sampling and acceptance criteria

Quantities always refer to the number of reels. The supplier shall perform the sampling tests following a single sampling plan for normal inspection, AQL=1,5%, Level I in compliance with standard ISO 2859-1, as long as the resulting minimum number of samples (8) does not exceed 25% of the total lot size. In such case, the number of samples shall be 25% (1/4) of the total lot size rounded down to the nearest unit as shown in the following table.

Amount of Reels	Number of Samples	Acceptable Level	Rejection Level
1 - 32	Amount of reels /4*	0	1
33 - 280	8	0	1
281 - 1.200	32	1	2
1.201 - 3.200	50	2	3
3.201 - 10.000	80	3	4
10.001 - 35.000	125	5	6

Table 10 Application of single sampling plan for normal inspection, AQL=1,5%, Level I in compliance with standard ISO 2859-1

*down to the nearest unit.

The costs of rejected materials will be charged to the bidder. The approval or rejection of each one of the samples will be according to what is required in standard ISO 2859-1 for each one of the trials. In detail, if a lot doesn't comply with what is required in the electric resistance test according to the approval requirements of the reference standard, the Inspector can carry out such test to all the units that make up the lot. If only a single spool is purchased, it must be tested according to what is indicated for a single sample.

Tests performed during the production process on semi-finished products may also be considered valid, as acceptance test, if:

- The tests are performed as required by the relevant technical specifications and technical standards;
- The sampling plans adopted by the Supplier are in compliance with the aforementioned ones;
- The performed test results are properly recorded;
- The supplier demonstrates that the components/materials features do not vary during further production phases after the test.

The reports of the acceptance tests performed by the supplier shall be prepared and retained, for a possible verification by Enel inspectors.

Application Areas

 Perimeter: *Global*

Staff Function: -

Service Function: -

Business Line: Enel Grids

7.8.3.Repetition of acceptance tests carried out in presence of Enel's inspector or designate

The supplier shall be available to repeat the tests in the presence of Enel's inspector or designate, on a "reduced" sample of the supply lot

7.8.3.1. Routine tests

Routine tests must be performed on a reduced sample by applying the following reduction criteria:

The minimum between:

- 1/3 of Required Sampling (100%)
- Result of Single sampling plans for Normal Inspection, Level I, AQL 1% - according UNI ISO 2859-1 Ed 5-2007 (See **Table 11** in sub-clause 7.8.4 for sampling)

The Routine tests are those indicated in par.7.8.5.1 - clause 1,22 (spark test is not applicable).

7.8.3.2. Sample tests

Sample tests shall be performed at 1/2 of Required Simple size already adopted for the sample test independently performed by the supplier (referring to each test).

The Sample tests are those indicated in par.7.8.5.1 and 7.8.5.2.

7.8.4.Sampling and acceptance criteria

- Quantities always refer to the number of reels
- Enel inspector can choose to perform the test on spools already tested by the Supplier or on others from the lot)
- In case of repetition of routine test attended by Enel Inspector, the spark test is not applicable.
- If only a single spool is purchased, it shall be tested according to what is indicated for a single sample
- On a spool among those subjected to the electrical resistance measurement, shall be performed the verification of the total length of the cable, that shall be not shorter than that declared by the supplier by more than 0,5 m.

Amount of Reels	Number of Samples	Acceptable Level**	Rejection Level**
1 - 41	Amount of reels /3*	0	1
42 - 500	13	0	1
501 – 3200	50	1	2
3.201 – 10.000	80	2	3
10.001 - 35.000	125	3	4

Application AreasPerimeter: *Global*

Staff Function: -

Service Function: -

Business Line: Enel Grids

Table 11– Application of single sampling plan for normal inspection, AQL=1%, Level I in compliance with standard ISO 2859-1

*down to the nearest unit.

**The negative result of a single test will result in the rejection of the lot or, when possible, in the repetition of the test on all the units, in order to accept only the compliant ones.

7.8.5.Type test

Type tests shall be performed before supplying a type of cable covered by this standard in order to demonstrate satisfactory performance characteristics to meet the intended application.

When type tests have been successfully performed on one type cable covered herein with a specific cross-section and construction characteristics, the type approval shall be accepted as valid for as long as the following conditions are met:

- a) The conductor cross-section is not larger than that of the tested cable.
- b) The cable as similar constructions as that of the tested cable, i.e. utilizes same materials, (conductor, insulation, outer sheath) and the same manufacturing process.

When design, materials or manufacturing process of the cable are changed (which might affect the performance characteristics of the cable), type approval shall be repeated.

Cables shall undergo type tests and acceptance tests for type approval.

7.8.5.1. Tests list for Type I and Type II cables

Application Areas

 Perimeter: *Global*

Staff Function: -

Service Function: -

Business Line: Enel Grids

N°	Test	Requirements	Test Method	R	S	T
1	Voltage Test Duration of immersion Test voltage Voltage applied duration Test Result	1 h 4 kV AC 15 min No breakdown	IEC 60502-1 sub-clause 15.3 as applicable	X	-	-
2	Conductor electrical resistance	See clause 5.1	IEC 60502-1 sub-clause 15.2	X	-	-
3	Mechanical breaking load verification of: Phase conductors 16 mm ² 25 mm ² 35 mm ² 50 mm ² 70 mm ² 95 mm ² 150 mm ² Neutral conductors 54,6 mm ² 80 mm ²	≥190 daN ≥300 daN ≥420 daN ≥600 daN ≥840 daN ≥1140 daN ≥1800 daN ≥1660 daN ≥2100 daN	HD 626 Part 2 sub-clause 2.1.2	-	-	X
4	Conformity to the approved type	See clause 5	Constructional characteristics, markings colors, and phase identification shall be inspected by visual examination. Dimensions, thickness, pitches and diameters shall be measured according to IEC 60811 parts 201, 202 and 203.	-	X	-
5	Conductor mass per unit length Test carried out on a phase conductor	The value shall be recorded	HD 605 sub-clause 2.1.13.1 or equivalent standard	-	-	X
6	Durability of markings	HD 626-1 Part 1 Sub-clause 3.3	HD 605 sub-clause 2.5.4	-	X	-
7	Mechanical properties of XLPE Before ageing Minimum tensile strength Minimum elongation at break	14,5 Mpa 200%	IEC 60811-501	-	X	-
8	XLPE mechanical properties After ageing Temperature Duration T1 Minimum tensile strength Maximum variation T1/T0 Minimum elongation at break Maximum variation T1/T0	150 °C 240 h ±25% ±25%	IEC 60811-501 IEC 60811-401	-	-	X

Application Areas

 Perimeter: *Global*

Staff Function: -

Service Function: -

Business Line: Enel Grids

N°	Test	Requirements	Test Method	R	S	T
N°	Test	Requirements	Test Method	R	S	T
9	Hot set test of XLPE Temperature Duration Mechanical stress Maximum elongation under load Maximum residual elongation	200 °C 15 min 0,2 Mpa 175% 15%	IEC 60811-507	-	X	-
10	Shrinkage test (Complete cable) L Duration Temperature Maximum shrinkage	200 mm 1 h 130 °C 4%	IEC 60811-502	-	-	X
11	Capillarity water absorption test (Only Type I cables)	The end of the test piece outside the container shall show no trace of water	HD 626 Part 2 sub-clause 2.7.1	-	-	X
12	Insulation resistance at 20 °C Water immersion duration Insulation constant K_i [$M\Omega \cdot km$]	1 h $\geq 10^4$	IEC 60502-1 sub-clause 17.1	-	X	-
13	Insulation resistance at 90 °C Water immersion duration Volume resistivity [$\Omega \cdot cm$]	2 h $\geq 10^{12}$	IEC 60502-1 sub-clause 17.2	-	-	X
14	Carbon black content	2,5%±0,5%	IEC 60811-605	-	-	X
15	Abrasion test	The samples shall withstand \geq 2000 turns of the test rotor	HD 605 2.5.13	-	X	-
16	Test at low temperature When cable $D > 12,5$ mm Elongation test at low temperature Temperature Minimum elongation When cable $D < 12,5$ mm Bending test at low temperature Temperature	-25 °C 50% -25 °C	IEC 60811-505 IEC 60811-504	-	-	X

Application Areas

 Perimeter: *Global*

Staff Function: -

Service Function: -

Business Line: Enel Grids

N°	Test	Requirements	Test Method	R	S	T
17	High voltage test (Complete cable) Sample length approx. Duration of immersion Test voltage Voltage applied duration Test result	≥ 20 m 24 h 10 kV AC 30 min No breakdown	IEC 60502-1, Sub-clause 17.3 by water immersion as applicable. The test voltage shall be applied between all conductors in parallel and water.	-	-	X
18	Resistance of insulation to weather conditions	HD 626 Part 2 , Sub-clause 2.5.2	HD 626 Part 2, Sub-clause 2.5.2	-	-	X
19	Water absorption test (Gravimetric method) Temperature Duration Maximum variation of mass	85 °C 336 h 1 mg/cm ²	IEC 60811-402	-	-	X
R: Routine test S: Sample test T: Type test						

 7.8.5.2. *Test for Type III and Type IV cables*

Application Areas

 Perimeter: *Global*

Staff Function: -

Service Function: -

Business Line: Enel Grids

N°	Test	Requirements	Test Method	R	S	T
1	Voltage Test Duration of immersion Test voltage Voltage applied duration Test Result	1 h 4 kV AC 15 min No breakdown	IEC 60502-1 sub-clause 15.3 as applicable	X	-	-
2	Conductor electrical resistance	See clause 5.1	IEC 60502-1 sub-clause 15.2	X	-	-
3	Mechanical breaking load verification of conductors (Only for Type III cables)	BL≥280 daN	HD 626 Part 2 sub-clause 2.1.5	-	X	-
4	Conformity to the approved type	See clause 5	Constructional characteristics, markings colors, and phase identification shall be inspected by visual examination. Dimensions, thickness, pitches and diameters shall be measured according to IEC 60811 parts 201, 202 and 203.	-	X	-
5	Conductor mass per unit length Test carried out on a phase conductor	The value shall be recorded	HD 605 sub-clause 2.1.13.1	-	-	X
6	Durability of markings	HD 626 Part 1 Sub-clause 3.3	HD 605 sub-clause 2.5.4	-	X	-
7	Mechanical properties of XLPE (Insulation and sheath) Before ageing Minimum tensile strength Minimum elongation at break	14,5 Mpa 200%	IEC 60811-501	-	X	-
8	XLPE mechanical properties (Insulation and sheath) After ageing Temperature Duration T1 <i>Minimum tensile strength</i> Maximum variation T1/T0 <i>Minimum elongation at break</i> Maximum variation T1/T0	150 °C 240 h ±25% ±25%	IEC 60811-501 IEC 60811-401	-	-	X
9	Hot set test of XLPE (Insulation and sheath) Temperature Duration Mechanical stress Maximum elongation under load Maximum residual elongation	150 °C 15 min 0,4 Mpa 70% 10%	IEC 60811-507	-	X	-

Application Areas

 Perimeter: *Global*

Staff Function: -

Service Function: -

Business Line: Enel Grids

N°	Test	Requirements	Test Method	R	S	T
10	Capillarity water absorption test (Only for Type III cables)	The end of the test piece outside the container shall show no trace of water	HD 626 Part 2, sub-clause 2.7.2	-	X	-
11	Insulation resistance at 20 °C (Insulation and sheath together) Water immersion duration Insulation constant K_i [M Ω ·km]	1 h $\geq 10^4$	IEC 60502-1 sub-clause 17.1	-	X	-
12	Insulation resistance at 90 °C (Insulation and sheath together) Water immersion duration Insulation constant K_i [M Ω ·km]	2 h $\geq 10^3$	IEC 60502-1 sub-clause 17.2	-	-	X
13	Test at low temperature for XLPE (Insulation and sheath together) When cable $D > 12,5$ mm Elongation test at low temperature Temperature Minimum elongation When cable $D \leq 12,5$ mm Bending test at low temperature Temperature	-25 °C 50% -25 °C	IEC 60811-505 IEC 60811-504	-	-	X
14	High voltage test (On complete cable) Sample length approx. Duration of immersion Test voltage Voltage applied duration Test result	≥ 5 m 24 h 10 kV AC 30 min No breakdown	IEC 60502-1, Sub-clause 17.3 by water immersion as applicable. The test voltage shall be applied between all conductors in parallel and water.	-	-	X
15	Impulse test Sample length approximately Number of impulses Wave form of impulse Peak value Test result	≈ 5 m 5(+) and 5 (-) (1 to 5/(50 \pm 10) μ s 20 kV No breakdown	The sample shall be water immersed and the voltage shall be applied between phase conductors in parallel and water connected to neutral conductor (if any). Publications HD 588-1	-	-	X
16	Cold impact test (Insulation and sheath together) XLPE insulation and sheath	-20 °C	IEC 60811-506, extended also to XLPE insulation and sheath with hammer mass of 1000g	-	-	X

Application Areas

 Perimeter: *Global*

Staff Function: -

Service Function: -

Business Line: Enel Grids

N°	Test	Requirements	Test Method	R	S	T
17	Water absorption test (Gravimetric method) Temperature Duration Maximum variation of mass	85 °C 336 h 5 mg/cm ²	IEC 60811-402	-	-	X
18	Abrasion test	The samples shall withstand ≥ 2000 turns of the test rotor	HD 626 part 2 sub-clause 2.6.1	-	-	X
19	Mechanical breaking load verification of messenger (Only for Type IV cables)	≥1660 daN	HD 626 Part 2 Sub-clause 2.1.5		X	-
20	Thermo mechanical behavior	HD 626 Part 2 Sub-clause 2.3.4	HD 626 Part 2 Sub-clause 2.3.4 ⁽³⁾ with clamps DM 6020 or DM 6010 for Italy and Romania	-	-	X
21	Mechanical behavior of messenger with anchoring device (Only for Type IV cables)	HD 626 Part 2 Sub-clause 2.3.5	HD 626 S1 Sub-clause 2.3.5 with clams DM 6010 for Italy and Romania	-	-	X
³ NOTE: The measurement of Sgc15 and Scm15 shall be performed after the fifteenth cycle. The slippage of every sheath shall be measured after the final cycle. The thermal probe shall be installed in the middle of the sample, i.e. notes (1) and (2) of HD 626 §2.3.4 must not be considered.						

Application Areas

 Perimeter: *Global*

Staff Function: -

Service Function: -

Business Line: Enel Grids

N°	Test	Requirements	Test Method	R	S	T
22	Thermo-gravimetric test for insulating materials	It is assumed that the loss of mass and the characteristic peak temperature for each step are taken as the average of the results obtained on the two test specimens. During qualification tests, the values shall be recorded. During acceptance tests, for each step the loss of mass shall not differ by more than $\pm 10\%$ and the characteristic peak temperatures by more than $\pm 10\text{ }^{\circ}\text{C}$ from the corresponding values of the qualification tests	HD 605, Sub-clause 2.5.7	-	X	-
23	Resistance of insulation to weather conditions	No cracks on the exposed surface shall occur. Breaking load and elongation shall not vary more than 20% from the initial value	HD 626 Part 2 Sub-clause 2.5.3	-	-	X
24	Test at low temperature for XLPE (Insulation and sheath together) After ageing Temperature Duration When cable D>12,5 mm Elongation test at low temperature Temperature Minimum elongation When cable D<12,5 mm Bending test at low temperature Temperature	150 °C 240 h -25 °C 50% -25 °C	IEC 60811-401 IEC 60811-505 IEC 60811-504	-	-	X
25	Test under fire conditions (Complete cable)	The cable shall be classified Minimum fire class Fca	EN 50575 sub-clause 4.1	-	-	X
R: Routine test S: Sample test T: Type test						

Application AreasPerimeter: *Global*

Staff Function: -

Service Function: -

Business Line: Enel Grids

7.9 TECHNICAL CONFORMITY ASSESSMENT

7.9.1 General conditions

The manufacturer shall provide personnel and equipment necessary to carry out type tests and acceptance tests described herein. Otherwise, the supplier could hire the service to a laboratory previously accepted by the customer and assume the cost. The product shall comply with the requirements of GSCG002 regarding the Technical Conformity Assessment.

The equipment should be properly calibrated by a laboratory certified or approved by the client. The manufacturer shall possess up to date calibration certificates (to turn over) at the time of inspection.

7.9.2 Acknowledgement of TCA for previous revision of the standard.

Products with TCA in force under the ENEL Global standard GSCC009 Rev 2 of 11/2018 and their respective addendums will be recognized as homologated material for the present technical specification.

Enel, therefore, reserves the right to check that the conditions of supply, the type codes, the country codes etc. shall comply with the requirements of this technical specification.

Application Areas

Perimeter: *Global*

Staff Function: -

Service Function: -

Business Line: Enel Grids

8. LOCAL SECTION

LOCAL SECTION A – e-distribuzione (Italy), e- e-distributie (Romania)

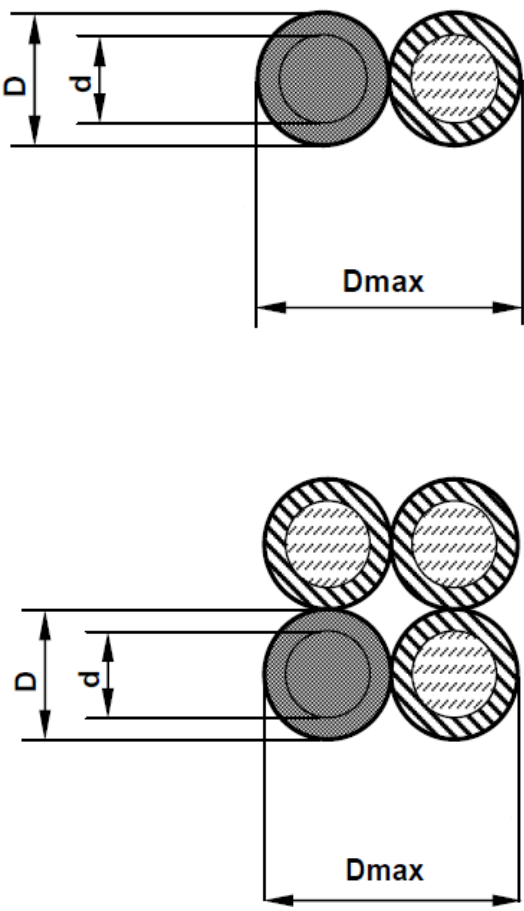
ITEM	TITLE	DESCRIPTION
3.3	Local standards	<p>e-distribuzione (Italy), e-distributie (Romania)</p> <ul style="list-style-type: none"> Standard PVR 006 Operational Note Vendor Rating Control: BARCODES Warranty and Traceability of Enel Distribution Materials. GUI 102 “Bobine per il trasporto di cavi elettrici, cavi ottici e conduttori per le linee elettriche di media e bassa tensione”
5.4	Constructive aspects.	<p>e-distribuzione (Italy), e-distributie (Romania)</p> <p>Values are given for network design purposes</p> <p>Type III cables</p> 

Application Areas

 Perimeter: *Global*

Staff Function: -

Service Function: -

Business Line: Enel Grids

LOCAL SECTION A – e-distribuzione (Italy), e- e-distributie (Romania)

ITEM	TITLE	DESCRIPTION																																														
5.4	Constructive aspects.	e-distribuzione (Italy), e-distributie (Romania)																																														
		<table border="1"> <thead> <tr> <th rowspan="2">Formation</th> <th colspan="2">D [mm]</th> <th rowspan="2">D_{max} [mm]</th> <th rowspan="2">Total Mass [kg/km]</th> <th rowspan="2">Breaking load [daN]</th> </tr> <tr> <th>Min</th> <th>Max</th> </tr> </thead> <tbody> <tr> <td>2x16 mm²</td> <td>7,4</td> <td>8,6</td> <td>16,8</td> <td>175</td> <td>550</td> </tr> <tr> <td>4x16 mm²</td> <td>7,4</td> <td>8,6</td> <td>20</td> <td>350</td> <td>1100</td> </tr> </tbody> </table> <p>Where: D= Core external diameter (insulation+sheath) D_{max}= Formation external diameter (indicative)</p> <p>Type IV cables</p> <table border="1"> <thead> <tr> <th rowspan="2">Formation [n° x mm²]</th> <th colspan="2">D_f [mm]</th> <th colspan="2">D_n [mm]</th> <th rowspan="2">D_{max} [mm]</th> <th rowspan="2">Total Mass [kg/km]</th> <th rowspan="2">Neutral core Breaking load [daN]</th> </tr> <tr> <th>Min</th> <th>Max</th> <th>Min</th> <th>Max</th> </tr> </thead> <tbody> <tr> <td>3x35+54,6</td> <td>10,2</td> <td>11,8</td> <td>12,4</td> <td>13,3</td> <td>33</td> <td>700</td> <td>1600</td> </tr> <tr> <td>3x70+54,6</td> <td>12,9</td> <td>14,5</td> <td>12,4</td> <td>13,3</td> <td>40</td> <td>1000</td> <td>1600</td> </tr> </tbody> </table> <p>Where: D_f= Phase core external diameter (insulation+sheath) D_n= Neutral core external diameter D_{max}= Formation external diameter (indicative)</p>	Formation	D [mm]		D _{max} [mm]	Total Mass [kg/km]	Breaking load [daN]	Min	Max	2x16 mm ²	7,4	8,6	16,8	175	550	4x16 mm ²	7,4	8,6	20	350	1100	Formation [n° x mm ²]	D _f [mm]		D _n [mm]		D _{max} [mm]	Total Mass [kg/km]	Neutral core Breaking load [daN]	Min	Max	Min	Max	3x35+54,6	10,2	11,8	12,4	13,3	33	700	1600	3x70+54,6	12,9	14,5	12,4	13,3	40
Formation	D [mm]			D _{max} [mm]	Total Mass [kg/km]				Breaking load [daN]																																							
	Min	Max																																														
2x16 mm ²	7,4	8,6	16,8	175	550																																											
4x16 mm ²	7,4	8,6	20	350	1100																																											
Formation [n° x mm ²]	D _f [mm]		D _n [mm]		D _{max} [mm]	Total Mass [kg/km]	Neutral core Breaking load [daN]																																									
	Min	Max	Min	Max																																												
3x35+54,6	10,2	11,8	12,4	13,3	33	700	1600																																									
3x70+54,6	12,9	14,5	12,4	13,3	40	1000	1600																																									

Application Areas

 Perimeter: *Global*

Staff Function: -

Service Function: -

Business Line: Enel Grids

LOCAL SECTION A – e-distribuzione (Italy), e- e-distributie (Romania)

ITEM	TITLE	DESCRIPTION										
5.5	Ampacity and Short-circuit rating	<p><u>e-distribuzione (Italy), e-distributie (Romania)</u></p> <p>The ampacity and short-circuit rating estimated values shall be given for network design purposes.</p> <p>Such currents shall be calculated in steady state condition when installed in air using the following operational conditions:</p> <ul style="list-style-type: none"> • Maximum conductor temperature 90 °C • Ambient air temperature 40 °C • Wind speed 2 km/h • Solar radiation intensity 10³ W/m² <p>For short-circuit capacity the following reference values could be used:</p> <table border="1" data-bbox="571 907 1468 1126"> <thead> <tr> <th data-bbox="571 907 866 978">Cross-section [mm²]</th> <th data-bbox="866 907 1468 978">Short circuit rating [kA]</th> </tr> </thead> <tbody> <tr> <td data-bbox="571 978 866 1014">16</td> <td data-bbox="866 978 1468 1014">1,6</td> </tr> <tr> <td data-bbox="571 1014 866 1050">35</td> <td data-bbox="866 1014 1468 1050">3,2</td> </tr> <tr> <td data-bbox="571 1050 866 1086">54,6</td> <td data-bbox="866 1050 1468 1086">4,5⁽¹⁾</td> </tr> <tr> <td data-bbox="571 1086 866 1126">70</td> <td data-bbox="866 1086 1468 1126">6,9</td> </tr> </tbody> </table> <p>The short circuit capacities are determined using the following parameters: Conductor initial temperature: 90 °C Conductor final temperature: 250 °C Short circuit duration: 1 s ⁽¹⁾ For the Aluminum alloy neutral conductor the following parameter are used: Conductor initial temperature: 65 °C Conductor final temperature: 180 °C</p>	Cross-section [mm ²]	Short circuit rating [kA]	16	1,6	35	3,2	54,6	4,5 ⁽¹⁾	70	6,9
Cross-section [mm ²]	Short circuit rating [kA]											
16	1,6											
35	3,2											
54,6	4,5 ⁽¹⁾											
70	6,9											

Application Areas

 Perimeter: *Global*

Staff Function: -

Service Function: -

Business Line: Enel Grids

ITEM	TITLE	DESCRIPTION															
8	CONDITIONS OF SUPPLY	<p><u>e-distribuzione (Italy), e-distributie (Romania)</u></p> <p>The maximum length and reel type for each configuration of cable are depicted in the following table:</p> <table border="1" data-bbox="571 600 1104 922"> <thead> <tr> <th data-bbox="577 607 743 707">Formation [n° x mm²]</th> <th data-bbox="743 607 914 707">Maximum Length [m]</th> <th data-bbox="914 607 1099 707">Coil Type (GUI 102)</th> </tr> </thead> <tbody> <tr> <td data-bbox="577 707 743 763">2x16</td> <td data-bbox="743 707 914 763">750</td> <td data-bbox="914 707 1099 763">10</td> </tr> <tr> <td data-bbox="577 763 743 819">4x16</td> <td data-bbox="743 763 914 819">750</td> <td data-bbox="914 763 1099 819">10</td> </tr> <tr> <td data-bbox="577 819 743 875">3x35+54,6</td> <td data-bbox="743 819 914 875">750</td> <td data-bbox="914 819 1099 875">14</td> </tr> <tr> <td data-bbox="577 875 743 922">3x70+54,6</td> <td data-bbox="743 875 914 922">750</td> <td data-bbox="914 875 1099 922">16</td> </tr> </tbody> </table> <p>The admitted tolerance is equal to $\pm 3\%$ of the length indicated in the order.</p> <p>Coils with total length less than indicated in the table above are permitted, as long as such reels constitute up a maximum to 10% of the cables forming the deliver batch (same transport document). However, each coil shall contain at least 100m, excluding the sample sizes whose length was reduced during the acceptance test.</p> <p>The far end of the cables shall be protected against the moisture.</p> <p>Due to traceability in the network a bar code shall be applied on the drum. Such bar code shall be in compliance with technical specification PVR006.</p> <p>Reels shall be made in compliance with the standard GUI102/GUI 102 RO.</p>	Formation [n° x mm ²]	Maximum Length [m]	Coil Type (GUI 102)	2x16	750	10	4x16	750	10	3x35+54,6	750	14	3x70+54,6	750	16
Formation [n° x mm ²]	Maximum Length [m]	Coil Type (GUI 102)															
2x16	750	10															
4x16	750	10															
3x35+54,6	750	14															
3x70+54,6	750	16															
8	CONDITIONS OF SUPPLY	<p><u>e-distribuzione (Italy), e-distributie (Romania)</u></p> <p>Following standard EN 50575, the CE marking and labelling shall be in accordance with the general principles set out in Article 30 of regulation (EC) No. 765/2008 and shall be affixed visibly, legibly and indelibly to the product labels affixed to the reels, coils or drums.</p> <p>In compliance with standard EN 50575 in particular annex V of the EU Construction Products Regulation n° 305/2011 (CPR) the supplier shall elaborate a Declaration of performance (DoP) and shall dispose a CE marking in function of the assessment and verification of constancy of performance (AVCP).</p>															

Application Areas

Perimeter: *Global*

Staff Function: -

Service Function: -

Business Line: Enel Grids

LOCAL SECTION B – CODENSA

ITEM	TITLE	DESCRIPTION
8	CONDITIONS OF SUPPLY	<p>Packaging and Labelling</p> <p>The cable shall be delivered by the manufacturer on a wooden or metal spool, which will not be returned, as per maximum and minimum dimensions indicated in Table 8 and in accordance with Figure 10.1.</p> <p>The total length of the cable supplied may not be less than that requested in the purchase order and shall not be longer by any more than 5%. In addition, there will be some special packaging requirements as indicated further ahead.</p> <p>The maximum gross weight of the packaged spool must not exceed 3500 kg.</p> <p>The ends of the cables on each spool must be protected with caps or hoods that prevent the entry of moisture. These ends internally secured to the spools, must be mechanically protected against possible damages resulting from handling and transportation of each spool, leaving both ends accessible through the use of an internal helix or reel on each spool.</p>

Application Areas

 Perimeter: *Global*

Staff Function: -

Service Function: -

Business Line: Enel Grids

LOCAL SECTION B – CODENSA

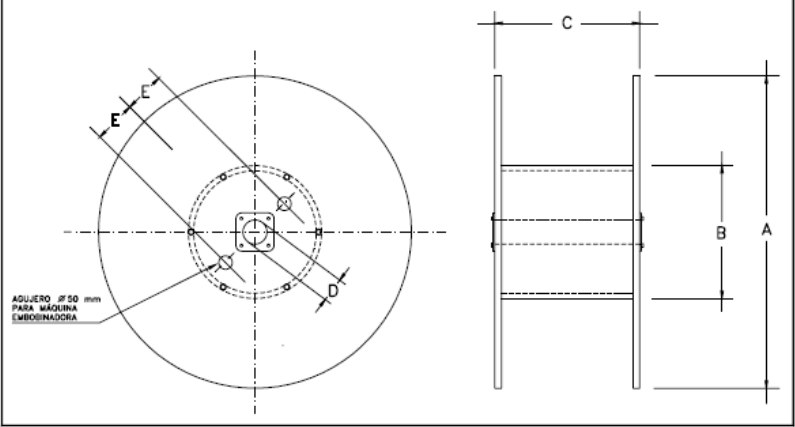
ITEM	TITLE	DESCRIPTION															
8	CONDITIONS OF SUPPLY	<p>When the distance between the origin of manufacture and the purchaser's storage area involves only one means of transport and a distance of less than 200 km, the use of the internal helix will be required only on spools of conductors with a diameter greater than or equal to 120 mm²; this does not make them exempt from the moisture protection on both visible ends of the conductor, mechanical protection, and careful handling of the spools.</p> <p>Temporarily, some of the batches of cables can be requested restricting them to 2,000 m of maximum length per spool and/or pre-joined, as per the Purchase Order.</p> <p>The wooden spools shall be treated according to the international requirements for the control of plant disease, avoiding the compounds "Pentachlorophenol" and "Creosote". The treatment must include, at least: highly toxic to xylophagous organisms, high penetration and holding power, chemical stability, non-corrosive substances to metals nor should they affect the physical characteristics of wood.</p>  <table border="1" data-bbox="683 1415 1347 1514"> <thead> <tr> <th>A⁽¹⁾</th> <th>B</th> <th>C⁽¹⁾</th> <th>D⁽²⁾</th> <th>E</th> </tr> <tr> <th>mm</th> <th>mm</th> <th>mm</th> <th>mm</th> <th>mm</th> </tr> </thead> <tbody> <tr> <td>1730</td> <td>(3)</td> <td>1120</td> <td>80</td> <td>(4)</td> </tr> </tbody> </table> <p>Notes:</p> <ul style="list-style-type: none"> (1) Maximum value (2) Minimum value (3) Two times the minimum cable curvature radius for transport 300 or 180mm according to type of drum (large or small respectively) 	A ⁽¹⁾	B	C ⁽¹⁾	D ⁽²⁾	E	mm	mm	mm	mm	mm	1730	(3)	1120	80	(4)
A ⁽¹⁾	B	C ⁽¹⁾	D ⁽²⁾	E													
mm	mm	mm	mm	mm													
1730	(3)	1120	80	(4)													

Application Areas

Perimeter: *Global*

Staff Function: -

Service Function: -

Business Line: Enel Grids

LOCAL SECTION C – Enel Distribución Chile

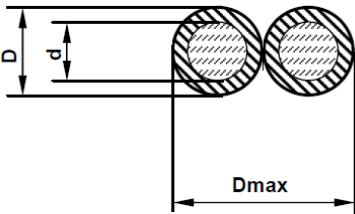
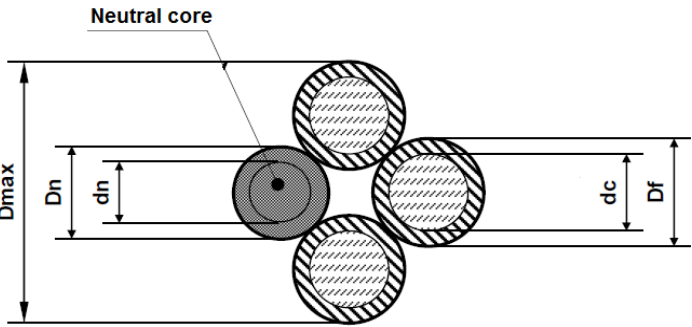
ITEM	TITLE	DESCRIPTION														
5.4	Constructive aspects.	<p><i>Enel Distribución Chile</i></p> <p>Values are given for network design purposes</p> <p>Type I Cables Aluminum conductor XLPE insulated cables self-supported</p>  <table border="1" data-bbox="571 1019 1276 1209"> <thead> <tr> <th rowspan="2">Formation [n° x mm²]</th> <th colspan="2">D_r [mm]</th> <th rowspan="2">D_{max} [mm]</th> <th rowspan="2">Total Mass kg/km</th> <th rowspan="2">Breaking load [daN]</th> </tr> <tr> <th>Min</th> <th>Max</th> </tr> </thead> <tbody> <tr> <td>2x16</td> <td>7</td> <td>7,9</td> <td>15,2</td> <td>170</td> <td>384</td> </tr> </tbody> </table> <p>Where: D= Core external diameter (insulation) D_{max}= Formation external diameter</p> <p>Type II Cables. Aluminum conductor XLPE insulated cables supported by an aluminum alloy XLPE insulated messenger.</p> 	Formation [n° x mm ²]	D_r [mm]		D_{max} [mm]	Total Mass kg/km	Breaking load [daN]	Min	Max	2x16	7	7,9	15,2	170	384
Formation [n° x mm ²]	D_r [mm]			D_{max} [mm]	Total Mass kg/km				Breaking load [daN]							
	Min	Max														
2x16	7	7,9	15,2	170	384											

LOCAL SECTION C – Enel Distribución Chile

Application Areas

 Perimeter: *Global*

Staff Function: -

Service Function: -

Business Line: Enel Grids

ITEM	TITLE	DESCRIPTION																																																				
5.4	Constructive aspects.	<i>Enel Distribución Chile</i>																																																				
		<table border="1"> <thead> <tr> <th rowspan="2">Formation [n° x mm²]</th> <th colspan="2">D_f [mm]</th> <th colspan="2">D_n [mm]</th> <th rowspan="2">D_{max} [mm]</th> <th rowspan="2">Total Mass kg/km</th> <th rowspan="2">Neutral core Breaking load [daN]</th> </tr> <tr> <th>Min</th> <th>Max</th> <th>Min</th> <th>Max</th> </tr> </thead> <tbody> <tr> <td>3x25+54,6</td> <td>8,4</td> <td>9,6</td> <td>12,4</td> <td>13,3</td> <td>32</td> <td>530</td> <td>1690</td> </tr> <tr> <td>3x35+54,6</td> <td>9,8</td> <td>10,9</td> <td>12,4</td> <td>13,3</td> <td>34</td> <td>650</td> <td>1690</td> </tr> <tr> <td>3x50+54,6</td> <td>10,9</td> <td>12,3</td> <td>12,4</td> <td>13,3</td> <td>35</td> <td>765</td> <td>1690</td> </tr> <tr> <td>3x70+54,6</td> <td>12,9</td> <td>14,0</td> <td>12,4</td> <td>13,3</td> <td>39</td> <td>1020</td> <td>1690</td> </tr> <tr> <td>3x95+54,6</td> <td>14,6</td> <td>16,0</td> <td>12,4</td> <td>13,3</td> <td>43</td> <td>1270</td> <td>1690</td> </tr> </tbody> </table>	Formation [n° x mm ²]	D_f [mm]		D_n [mm]		D_{max} [mm]	Total Mass kg/km	Neutral core Breaking load [daN]	Min	Max	Min	Max	3x25+54,6	8,4	9,6	12,4	13,3	32	530	1690	3x35+54,6	9,8	10,9	12,4	13,3	34	650	1690	3x50+54,6	10,9	12,3	12,4	13,3	35	765	1690	3x70+54,6	12,9	14,0	12,4	13,3	39	1020	1690	3x95+54,6	14,6	16,0	12,4	13,3	43	1270	1690
		Formation [n° x mm ²]		D_f [mm]		D_n [mm]					D_{max} [mm]	Total Mass kg/km	Neutral core Breaking load [daN]																																									
			Min	Max	Min	Max																																																
		3x25+54,6	8,4	9,6	12,4	13,3	32	530	1690																																													
		3x35+54,6	9,8	10,9	12,4	13,3	34	650	1690																																													
		3x50+54,6	10,9	12,3	12,4	13,3	35	765	1690																																													
3x70+54,6	12,9	14,0	12,4	13,3	39	1020	1690																																															
3x95+54,6	14,6	16,0	12,4	13,3	43	1270	1690																																															
Where:																																																						
D_f = Phase core external diameter (insulation)																																																						
D_n = Neutral core external diameter																																																						
D_{max} = Formation external diameter																																																						

Application Areas

 Perimeter: *Global*

Staff Function: -

Service Function: -

Business Line: Enel Grids

LOCAL SECTION C – Enel Distribución Chile

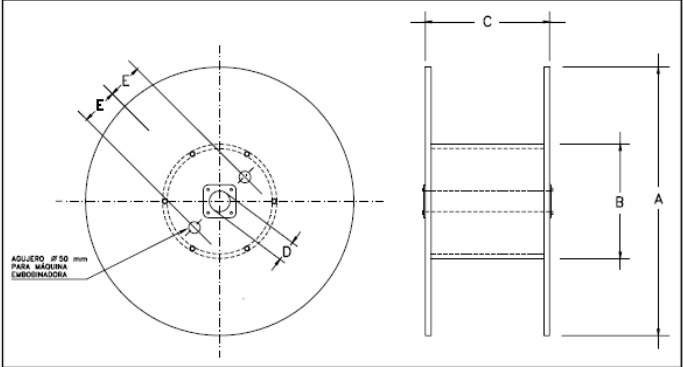
ITEM	TITLE	DESCRIPTION															
8	CONDITIONS OF SUPPLY	<p><u>Enel Distribución Chile</u></p> <p>PACKAGING AND LABELLING</p> <p>The conductor will be delivered by the manufacturer in wooden or steel reels, which will not be returned, according to maximum and minimum dimensions shown in Table below and according to Figure.</p>  <table border="1" data-bbox="683 1160 1347 1258"> <thead> <tr> <th>A⁽¹⁾</th> <th>B</th> <th>C⁽¹⁾</th> <th>D⁽²⁾</th> <th>E</th> </tr> <tr> <th>mm</th> <th>mm</th> <th>mm</th> <th>mm</th> <th>mm</th> </tr> </thead> <tbody> <tr> <td>1730</td> <td>(3)</td> <td>1120</td> <td>80</td> <td>(4)</td> </tr> </tbody> </table> <p>Notes:</p> <p>(4) Maximum value (5) Minimum value (6) Two times the minimum cable curvature radius for transport (7) 300 or 180mm according to type of drum (large or small respectively)</p> <p>The total length of the conductor given on each drum must not be less than the requested in the purchase order and shall not exceed by more than 1 %.</p> <p>The maximum gross weight of the packed drum is 3,500 kg.</p> <p>It should protect the ends of each cable with caps to prevent moisture ingress and must be internally secured to the spool ends, and must be mechanically protected against possible damages from the handling and transport of each drum.</p> <p>The hole for handling the drums must be round, center, with a diameter of 80mm and with a metallic flange on each side of the drum (centered at the hole).</p> <p>The wooden reels will be treated according to international requirements for pest control , avoiding the compound " Pentachlorophenol " and " Creosote " . Treatment should include, at least : high toxicity to decay organisms , high penetration and holding power , chemical stability, non-corrosive to metals and substances affecting physical characteristics of the wood and weather protection .</p> <p>The cable must be coiled in uniform layers and the last layer must be protected with a coating of impermeable material.</p>	A ⁽¹⁾	B	C ⁽¹⁾	D ⁽²⁾	E	mm	mm	mm	mm	mm	1730	(3)	1120	80	(4)
A ⁽¹⁾	B	C ⁽¹⁾	D ⁽²⁾	E													
mm	mm	mm	mm	mm													
1730	(3)	1120	80	(4)													



Technical Specification code: GRI-GRI-MAT-E&C-0021

Version no. 2 dated 12/2022

Subject: GSC009 LOW VOLTAGE AERIAL BUNDLED CABLES.

Application Areas

Perimeter: *Global*

Staff Function: -

Service Function: -

Business Line: Enel Grids

LOCAL SECTION D – EDESUR

ITEM	TITLE	DESCRIPTION
3.3	Local Standards	<u>EDESUR</u> IRAM 2263 “Cables preensamblados con conductores de aluminio aislados con politileno reticulado para lineas aereas de hasta 1,1 kV”
8	CONDITIONS OF SUPPLY	<u>EDESUR</u> The reels must meet the requirements of the IRAM 9590-1 standard

Application Areas

Perimeter: *Global*

Staff Function: -

Service Function: -

Business Line: Enel Grids

LOCAL SECTION E – Enel Distribución Peru

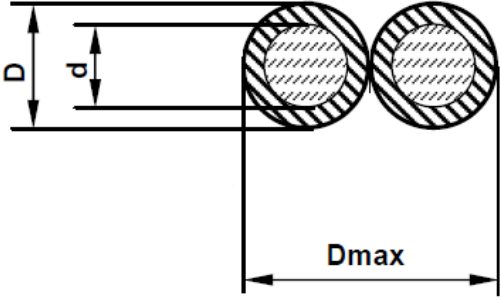
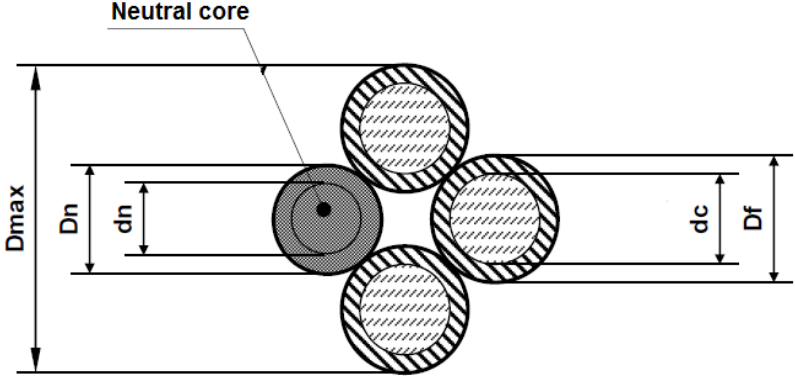
ITEM	TITLE	DESCRIPTION														
5.4	Constructive aspects.	<p>Type I cables Aluminum conductor XLPE insulated cables self-supported</p>  <table border="1" data-bbox="571 994 1276 1182"> <thead> <tr> <th rowspan="2">Formation [n° x mm²]</th> <th colspan="2">D [mm]</th> <th rowspan="2">D_{max} [mm]</th> <th rowspan="2">Total Mass kg/km</th> <th rowspan="2">Breaking load [daN]</th> </tr> <tr> <th>Min</th> <th>Max</th> </tr> </thead> <tbody> <tr> <td>2x16</td> <td>7</td> <td>7,9</td> <td>15,2</td> <td>170</td> <td>384</td> </tr> </tbody> </table> <p>Where: D= Core external diameter (insulation) D_{max}= Formation external diameter (reference value)</p> <p>Type II Cables. Aluminum conductor XLPE insulated cables supported by an aluminum alloy XLPE insulated messenger.</p> 	Formation [n° x mm ²]	D [mm]		D _{max} [mm]	Total Mass kg/km	Breaking load [daN]	Min	Max	2x16	7	7,9	15,2	170	384
Formation [n° x mm ²]	D [mm]			D _{max} [mm]	Total Mass kg/km				Breaking load [daN]							
	Min	Max														
2x16	7	7,9	15,2	170	384											

Application Areas

 Perimeter: *Global*

Staff Function: -

Service Function: -

Business Line: Enel Grids

LOCAL SECTION E – Enel Distribución Peru

ITEM	TITLE	DESCRIPTION															
		Formation [n° x mm ²]	D_f [mm]		D_n [mm]		D_{max} [mm]	Total Mass kg/km	Neutral core Breaking load [daN]								
Min	Max		Min	Max													
5.4	Constructive aspects.	3x35+54,6	9,8	11,0	12,5	13,3	34	650	1690								
		3x95+54,6	14,6	16,0	12,5	13,3	43	1270	1690								
		Where: D_f = Phase core external diameter (insulation) D_n = Neutral core external diameter D_{max} = Formation external diameter															
5.5	Ampacity and Short-circuit rating	The ampacity and short-circuit rating estimated values shall be given for network design purposes. Such currents shall be calculated in steady state condition when installed in air using the following operational conditions: <ul style="list-style-type: none"> • Maximum conductor temperature 90 °C • Ambient air temperature 40 °C • Wind speed 2 km/h • Solar radiation intensity 10³ W/m² The following estimated values could be used as reference for aluminum cables															
		<table border="1"> <thead> <tr> <th>Cross-section [mm²]</th> <th>Short circuit rating [kA]</th> </tr> </thead> <tbody> <tr> <td>16</td> <td>1,52</td> </tr> <tr> <td>35</td> <td>3,33</td> </tr> <tr> <td>95</td> <td>9,03</td> </tr> <tr> <td>54.6</td> <td>4,5</td> </tr> </tbody> </table>		Cross-section [mm ²]	Short circuit rating [kA]	16	1,52	35	3,33	95	9,03	54.6	4,5	The short circuit capacities are determined using the following parameters: Conductor initial temperature: 90 °C Conductor final temperature: 250 °C Short-circuit duration: 1 s (1) For the Aluminum alloy neutral conductor the following parameter are used: Conductor initial temperature: 65 °C Conductor final temperature: 180 °C			
Cross-section [mm ²]	Short circuit rating [kA]																
16	1,52																
35	3,33																
95	9,03																
54.6	4,5																

Application Areas

 Perimeter: *Global*

Staff Function: -

Service Function: -

Business Line: Enel Grids

LOCAL SECTION E – Enel Distribución Peru

ITEM	TITLE	DESCRIPTION
8	CONDITIONS OF SUPPLY	<p><u>Enel Distribución Perú</u></p> <p>The cable will be delivered by the manufacturer in wood or metal drum, which will not be returned , according to maximum and minimum dimensions shown in Table xxx and according to Figure N° xxx.</p> <p>The wooden spools will be treated according to international requirements for pest control , avoiding the compound " Pentachlorophenol " and " Creosote " . Treatment should include, at least : high toxicity to decay organisms , high penetration and holding power , chemical stability, non-corrosive to metals and substances affecting physical characteristics of the wood and weather protection</p> <p>The total length of the driver given on each reel may not be less than requested in the purchase order and shall not exceed by more than $\pm 5\%$. The maximum gross weight of the reel is packed 2,500 kg o 3500 kg</p> <p>The two ends of the insulated cable must be tightened up firmly to the internal part of the reel, they must be accessible and must be fully sealed with a hood or insulating material in order to prevent humidity from wetting the cables. The ends of the conductors shall be mechanically protected against potential damage produced by the handling and transportation of each reel.</p> <p>The spindle hole to handle the reels must be circular, centered in its axle, and with a minimum diameter of 80 millimeters, with a metal flange on each side of the reel (centered in the hole).</p> <p>The cable must be coiled in uniform layers and the last layer must be protected with a coating of impermeable material.</p> <p>The reels must:</p> <ul style="list-style-type: none"> • Be protected by wooden staves on the exterior, which are to be secured to the wooden spools. An equivalent system is to be used on the steel spools. The staves are to be fastened by steel or plastic bands. • Show the correct direction for unwinding the spools, by means of an arrow located on the sides. • Have a stainless steel nameplate on each side of the spool. Each nameplate will show the following information (as a minimum), in spanish. The following data will be required: <ul style="list-style-type: none"> • ENEL DISTRIBUCIÓN PERÚ • Manufacturer's name • Country of origin • Country code • Equipment description • Year and mounth of manufacture

Application Areas

 Perimeter: *Global*

Staff Function: -

Service Function: -

Business Line: Enel Grids

LOCAL SECTION E – Enel Distribución Peru

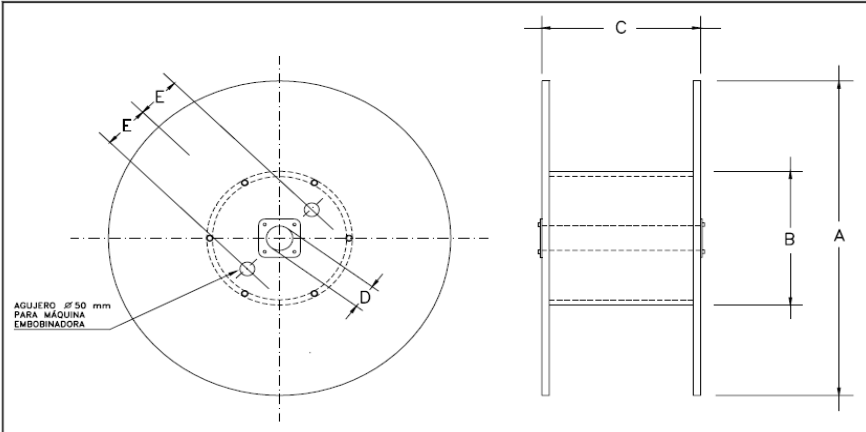
ITEM	TITLE	DESCRIPTION															
8	CONDITIONS OF SUPPLY	<ul style="list-style-type: none"> • Number of the spool within the delivered batch Cable length (m) • Initial metric labeled in cable • Final, metric labeled in cable • Conductor cross-section (mm²) • Cable type Insulation material and type • Manufacturing Standard • Rated insulation voltage: U₀ / U (U_{max}) kV • Purchase order number • Net weight / kg • Weight of one meter of cable (kg) • Coil Weight (Kg) • Coil dimension in mm. • Gross Weight (kg) • Coil Dimensions (mm) • <div style="text-align: center;">  </div> <ul style="list-style-type: none"> • Figure N° 1 Trial type <table border="1" style="margin: 10px auto; border-collapse: collapse; text-align: center;"> <thead> <tr> <th>A⁽¹⁾</th> <th>B</th> <th>C⁽¹⁾</th> <th>D⁽²⁾</th> <th>E</th> </tr> <tr> <th>mm</th> <th>mm</th> <th>mm</th> <th>mm</th> <th>mm</th> </tr> </thead> <tbody> <tr> <td>1730</td> <td>(3)</td> <td>1120</td> <td>80</td> <td>(4)</td> </tr> </tbody> </table> <p style="text-align: center;">able N° 1 Trial Dimension</p> <p><u>Notes:</u></p> <p>(1) Maximum value.</p> <p>(2) Minimum value</p> <p>(3) El Double the minimum cable curvature radius for transportation, in accordance with Manufacturer specifications.</p> <p>(4) 300 or 180 mm, in accordance with the type of spool (large or small, respectively).</p>	A ⁽¹⁾	B	C ⁽¹⁾	D ⁽²⁾	E	mm	mm	mm	mm	mm	1730	(3)	1120	80	(4)
A ⁽¹⁾	B	C ⁽¹⁾	D ⁽²⁾	E													
mm	mm	mm	mm	mm													
1730	(3)	1120	80	(4)													

Application Areas

 Perimeter: *Global*

Staff Function: -

Service Function: -

Business Line: Enel Grids

LOCAL SECTION F – ENDESA DISTRIBUCIÓN ELÉCTRICA

ITEM	TITLE	DESCRIPTION																								
3.3	Local standards	a) UNE 21030-0: Conductores aislados, cableados en haz, de tensión asignada 0,6/1 kV, para líneas de distribución, acometidas y usos análogos. Parte 0: Índice b) UNE 21030-1: Conductores aislados, cableados en haz, de tensión asignada 0,6/1 kV, para líneas de distribución, acometidas y usos análogos. Parte 1: Conductores de aluminio. c) UNE 211435 “Guía para la elección de cables eléctricos de tensión asignada superior o igual a 0,6/1 kV para circuitos de distribución” d) UNE 21167 “Bobinas de madera para cables aislados de transporte y distribución. Características generales”																								
5.1	Conductor	The following maximum diameters shall be satisfied: <table border="1" data-bbox="785 996 1254 1442"> <thead> <tr> <th>Cross-section [mm²]</th> <th>Min External Diameter [mm]</th> <th>Max External Diameter [mm]</th> </tr> </thead> <tbody> <tr> <td>16</td> <td>7,0</td> <td>7,9</td> </tr> <tr> <td>25</td> <td>8,4</td> <td>9,6</td> </tr> <tr> <td>50</td> <td>10,9</td> <td>12,3</td> </tr> <tr> <td>95</td> <td>14,6</td> <td>16,1</td> </tr> <tr> <td>150</td> <td>17,5</td> <td>19,1</td> </tr> <tr> <td>54.6</td> <td>12,4</td> <td>13,0</td> </tr> <tr> <td>80</td> <td>14,8</td> <td>15,8</td> </tr> </tbody> </table>	Cross-section [mm ²]	Min External Diameter [mm]	Max External Diameter [mm]	16	7,0	7,9	25	8,4	9,6	50	10,9	12,3	95	14,6	16,1	150	17,5	19,1	54.6	12,4	13,0	80	14,8	15,8
Cross-section [mm ²]	Min External Diameter [mm]	Max External Diameter [mm]																								
16	7,0	7,9																								
25	8,4	9,6																								
50	10,9	12,3																								
95	14,6	16,1																								
150	17,5	19,1																								
54.6	12,4	13,0																								
80	14,8	15,8																								
5.4	Constructive aspects.	For Type I & Type II cables the phase cores shall be bundled to the left “S” (anti-clockwise) without suffering any torsion. The lay length shall be the following: <table border="1" data-bbox="572 1626 1233 1998"> <thead> <tr> <th rowspan="2">Cross-section [mm²]</th> <th>Type I</th> <th>Type II</th> </tr> <tr> <th>Maximum lay length [mm]</th> <th>Maximum lay length [mm]</th> </tr> </thead> <tbody> <tr> <td>16</td> <td>400</td> <td>-</td> </tr> <tr> <td>25</td> <td>450</td> <td>550</td> </tr> <tr> <td>50</td> <td>530</td> <td>725</td> </tr> <tr> <td>95</td> <td>700</td> <td>850</td> </tr> <tr> <td>150</td> <td>900</td> <td>1000</td> </tr> </tbody> </table>	Cross-section [mm ²]	Type I	Type II	Maximum lay length [mm]	Maximum lay length [mm]	16	400	-	25	450	550	50	530	725	95	700	850	150	900	1000				
Cross-section [mm ²]	Type I	Type II																								
	Maximum lay length [mm]	Maximum lay length [mm]																								
16	400	-																								
25	450	550																								
50	530	725																								
95	700	850																								
150	900	1000																								

Application Areas

 Perimeter: *Global*

Staff Function: -

Service Function: -

Business Line: Enel Grids

LOCAL SECTION F – ENDESA DISTRIBUCIÓN ELÉCTRICA

ITEM	TITLE	DESCRIPTION
5.5	Ampacity and Short-circuit rating	<p>For all uses of cables, the maximum current-carrying permitted for conductors must be in accordance with Low-Voltage Electrotechnical Regulation (REBT), approved by R.D. 842/2002, of 2 August, and Standard UNE211425.</p> <p>The ampacity estimated values shall be given for network design purposes. Such currents shall be calculated in the following steady state conditions:</p> <ul style="list-style-type: none"> • A single circuit (3F+N) installed outdoors. • Far from any heat source. • Protected from the sun. • Maximum conductor temperature 90 °C. • Ambient air temperature 40 °C. <p>For short-circuit rating the following condition shall be used:</p> <ul style="list-style-type: none"> • Initial conductor temperature 90 °C • Final conductor temperature 250 °C
5.6.1	Cable designation	<p>The designation of the cables will be carried out by means of an acronym that, in the order mentioned below, will indicate the following:</p> <ul style="list-style-type: none"> • Constructive type: <ul style="list-style-type: none"> R that will designate the XLPE insulation Z that will designate visible bundle assembled cores • Assigned voltage of the cable which, expressed in kV, will designate the values U_0 and U in the form 0.6/1 kV. • Number of conductors and their nominal cross section. <p>Between the number of conductors and the section, the sign x will be interspersed. In case of a conductor of reduced section, the section of this one will follow the one of the main conductors separated by a slash.</p> <ul style="list-style-type: none"> • Nature of the conductors and eventually of the messenger if it acts as a neutral conductor. <p>After the cross section of the conductors the designation AI is placed. If the neutral conductor is made of aluminum, silicon and magnesium alloy, the designation Alm will follow the cross section thereof.</p> <p>Designation example of a 0,6/1kV neutral supported cable with three phase conductors of Aluminum with 95 mm² cross section and a neutral conductor of aluminum, silicon and magnesium alloy with 54.6 mm² cross section.</p> <p>RZ 0,6/1 kV 3 x 95 AI/54,6 Alm</p>

Application Areas

 Perimeter: *Global*

Staff Function: -

Service Function: -

Business Line: Enel Grids

LOCAL SECTION F – ENDESA DISTRIBUCIÓN ELÉCTRICA

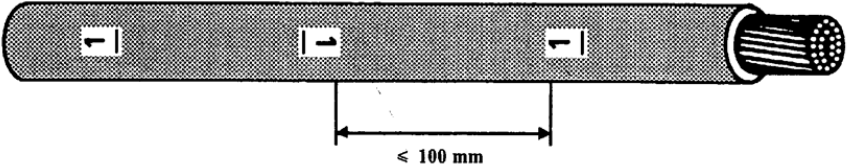
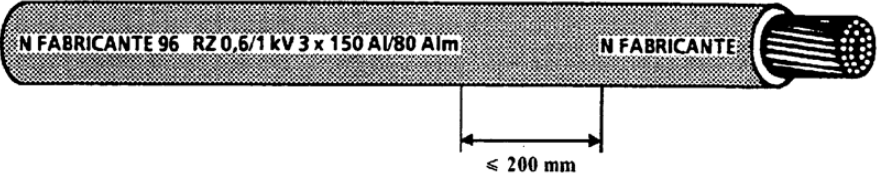
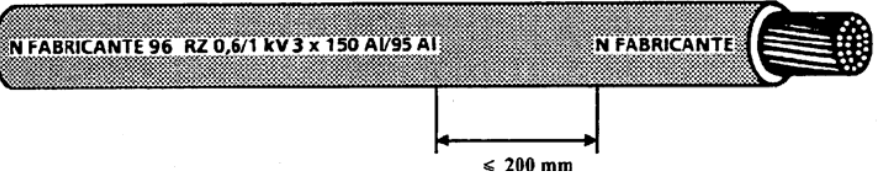
ITEM	TITLE	DESCRIPTION
5.6.2	Markings	<p>The marking must be indelible, easily legible and carried out by engraving or in relief above the surface of the outer sheath in a continuous way.</p> <p>The conductors shall have on the outer surface of the insulating cover, the following marks:</p> <ul style="list-style-type: none"> Phase conductors. Figures 1, 2 or 3 with a underscore bellow, inverted 180° alternately, and with a mark spacing of not more than 100mm, as indicated in the following image:  <ul style="list-style-type: none"> Neutral conductor (messenger or not). The letter N followed by the identification of the manufacturer, the last two digits of the manufacture year and the designation of the cable according to section 5.6.1. The distance between marks must not exceed 200 mm, as indicated in the following images:.  <p>Neutral supported cable</p>  <p>self-supported cable</p>

Application Areas

 Perimeter: *Global*

Staff Function: -

Service Function: -

Business Line: Enel Grids

LOCAL SECTION F – ENDESA DISTRIBUCIÓN ELÉCTRICA

ITEM	TITLE	DESCRIPTION
6	TEST CLASSIFICATION	All test shall be performed in compliance with standard UNE 21030
8	CONDITIONS OF SUPPLY	<p>The permitted tolerance range for a cable is $\pm 3\%$ of the length indicated in the order; lower lengths could be accepted for a maximum of 10% of the cables that make up the delivery lot (same transport document), provided that each is at least 100m long; in the calculation of this 10%, the sample cables whose length has been reduced due to the acceptance tests are excluded.</p> <p>Reels shall be in compliance with the Standard UNE 21167 “Bobinas de Madera para cables asilados de transporte y distribución”</p> <p>a) Protections</p> <p>The cables must be protected in such a way as to prevent damage or tampering during transport and handling, also within the sphere of ENEL.</p> <p>If the Supplier uses a type of protection as an alternative to staves, it must not be made with materials that during disposal are classifiable as hazardous waste; in any case, all protections that are alternatives to staves must be explicitly approved by ENEL during certification or during the tender process.</p> <p>The free ends of the cable must be properly protected against the penetration of water and moisture during transport, storage (which may also be outdoors) and lying.</p> <p>The finished and inspected cable drums at the Supplier's plant cannot be parked without staves or equivalent protections in zones exposed to bad weather (sun, rain, etc.) and to accidental impacts unless for the time necessary for their staving or similar protection. Unless otherwise provided in the purchase order letter, the protection (staving or other) of drums must be executed 100%.</p> <p>The spacing between the external layer of the cable and the staving must be sufficient for preventing damage to the cable and in any case never less than 50 mm; to comply with said prescription, sizes of length reduced up to the minimum allowed can be preferred, if necessary.</p>

Application Areas

Perimeter: *Global*

Staff Function: -

Service Function: -

Business Line: Enel Grids

LOCAL SECTION F – ENDESA DISTRIBUCIÓN ELÉCTRICA

ITEM	TITLE	DESCRIPTION
8	CONDITIONS OF SUPPLY	<p>b) Marking and tara.</p> <p>On the outer surface of at least one of the covers of the drum transport, the following information must be indicated in clearly legible and indelible characters, plus ordering information, where applicable:</p> <ul style="list-style-type: none"> ○ Name and registered address of the manufacturer. ○ Cable Type. ○ The effective length of the cable. ○ Order Number. ○ Number of drum. ○ Year of manufacture (last two digits). ○ Number of production order. ○ Direction of rotation of the drum (arrow). ○ Direction of unwinding (if the drum wrapped). ○ Gross weight, net and tare of the drum. <p>c) Transport.</p> <p>In order to facilitate unloading, drums should be arranged in the vehicle with a distance between the covers for inputting the charging and discharging means, so that either can be discharged with handling means with forks.</p> <p>d) Photographic documentation</p> <p>A side view photo and a front view photo showing the empty drum, the drum with wound cable without external cover, the drum complete with external cover (for a total of at least 6 photos) and the detailed view of the identification plate where the drum and supply data are provided (at an enlargement level such as to allow the information photographed to be read).</p>

Application Areas

 Perimeter: *Global*

Staff Function: -

Service Function: -

Business Line: Enel Grids

LOCAL SECTION G – ENEL DISTRIBUIÇÃO (BRASIL)

ITEM	TITLE	DESCRIPTION
3.3	Replaced local standards	<ul style="list-style-type: none"> NTE-M-056
8	CONDITIONS OF SUPPLY	<p>Packaging and Labelling</p> <p>Cables shall be delivered on spools made of wood or metal, such spool will not be returned. Characteristics are indicated in Figure A, dimensions are depicted in Table A.</p> <p>The total length of the supplied cable shall not be less than that requested in the purchase order and shall not be longer by any more than 5%.</p> <p>The maximum gross weight of the packaged spool must not exceed 3500 kg.</p> <p>The ends of the cables on each spool must be protected with caps or hoods that prevent the entry of moisture. These ends internally secured to the spools, must be mechanically protected against possible damages resulting from handling and transportation of each spool, leaving both ends accessible through the use of an internal helix or reel on each spool.</p> <p>When distance between manufacturing facilities and distribution company storage center is less than 200 km and is necessary only one mean of transportation,</p> <p>It is mandatory to use internal helix for cables cross-section greater of equal to 120 mm². However, moisture protection on both visible ends of the cables, mechanical protection, and careful handling shall be applied.</p> <p>Some Purchase orders could request 2,000 m of maximum length per spool and/or pre-joined cables.</p> <p>Spools made of wood shall be treated according to the international requirements for the control of plant disease, avoiding the compounds “Pentachlorophenol” and “Creosote”. The treatment must include, at least: highly toxic to xylophagous organisms, high penetration and holding power, chemical stability, non-corrosive substances to metals that could affect the physical characteristics of wood.</p>

Application Areas

 Perimeter: *Global*

Staff Function: -

Service Function: -

Business Line: Enel Grids

LOCAL SECTION G – ENEL DISTRIBUIÇÃO (BRASIL)

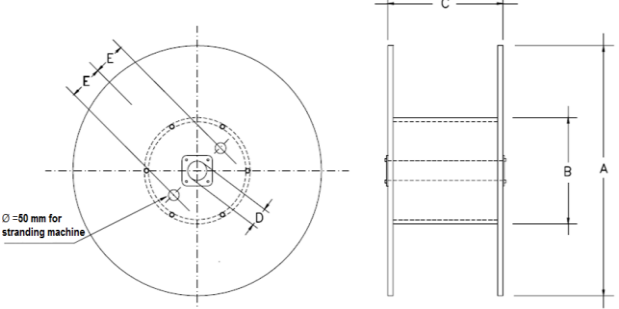
ITEM	TITLE	DESCRIPTION															
8	CONDITIONS OF SUPPLY	<div style="text-align: center;">  <p>Figure A</p> </div> <p><u>Dimensions:</u></p> <table border="1" data-bbox="726 952 1316 1075"> <thead> <tr> <th>A⁽¹⁾</th> <th>B</th> <th>C⁽¹⁾</th> <th>D⁽²⁾</th> <th>E</th> </tr> </thead> <tbody> <tr> <td>mm</td> <td>mm</td> <td>mm</td> <td>mm</td> <td>mm</td> </tr> <tr> <td>2000</td> <td>(3)</td> <td>1120</td> <td>80</td> <td>(4)</td> </tr> </tbody> </table> <p>Table A</p> <p>Notes:</p> <p>(1) Maximum value. (2) Minimum value. (3) Two times the minimum bending radius indicated by the supplier. (4) 300 or 180 mm according to spool type (large or small, respectively)</p> <p>The spools must contain:</p> <ul style="list-style-type: none"> • An external protection built with wooden flanges fixed on the wooden spools or some equivalent for metal spools, being secured with tapes or straps. • Indication with an arrow of the rolling direction. • A stainless steel plate for identification purposes. Such plate shall be applied in both flanges and shall have the following information (in Portuguese): <ol style="list-style-type: none"> 1) Manufacturer name 2) Country of origin 3) ENEL RIO/ENEL CEARÁ/ENEL GOIÁS (according to purchase) 4) Purchase order N° 5) Rated Voltage U₀/U (U_{max}) 6) Insulation material 7) Cable cross-section [mm²] 8) Spool number of the corresponding delivered batch 9) Net and gross weight [kg] 10) Configuration type (unipolar, triplex, quadruplex). 11) Cable length [m] 	A ⁽¹⁾	B	C ⁽¹⁾	D ⁽²⁾	E	mm	mm	mm	mm	mm	2000	(3)	1120	80	(4)
A ⁽¹⁾	B	C ⁽¹⁾	D ⁽²⁾	E													
mm	mm	mm	mm	mm													
2000	(3)	1120	80	(4)													