

A large industrial facility, possibly a power plant or refinery, with a worker in the foreground. The worker is wearing a dark jacket and a plaid shirt, and is holding a white hard hat and a black mallet. The facility features large blue and yellow machinery, pipes, and a complex steel structure. The scene is brightly lit with overhead lights.

**Focus on reliability to improve
availability, profitability and safety.**

Prediction and Protection for Production Assets

Recognize business goals and achieve top-quartile reliability by implementing technologies that enhance your digital transformation journey.



Unreliable equipment increases risk to both safety and profits

Unscheduled downtime caused by equipment failure eats into both the maintenance budget and production goals. Routine maintenance can help, but it doesn't reveal the developing issues that result in process slowdowns or shutdowns. You simply aren't able to avoid these preventable failures.

Introducing technology to monitor these assets sounds like the solution, but where do you start? The budget won't allow you to install the same monitoring system on every asset in the plant, so how would you choose what equipment to monitor and what equipment to ignore? And with the emergence of the digital transformation age, how do you prioritize where to invest in new technologies?

Critical assets come with another key consideration - they often are required to have API-certified protection systems so the equipment is tripped under unsafe operating conditions. But sometimes those trips aren't necessary - and again your production is shutdown while you determine the nature of the problem. You need a modern approach to protecting your assets that includes predictive intelligence.

To keep your plant assets available and producing revenue, you need solutions that are custom to the criticality of the asset being monitored and that identify the assets at risk of failure.

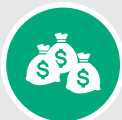

It costs approximately **50% more to repair** a failed asset than if the problem had been addressed prior to failure.
– U.S. National Response Center



Production capacity is lost to as much as **5% every year as a result of unplanned shutdowns**.
– Asdza Nadleeh, "Engineering & Maintenance: Prevention is Better Than Cure," Oil & Gas IQ, October 2011.



Companies need to apply innovative technologies hand in hand with their relevant industry expertise to succeed and gain a competitive edge. It is this combination that makes digital transformation both meaningful and powerful.
– IFS (Industrial and Financial Services) survey on Digital Maturity Across Industries, reported June 2017..





Focus on reliability to improve availability, profitability, and safety

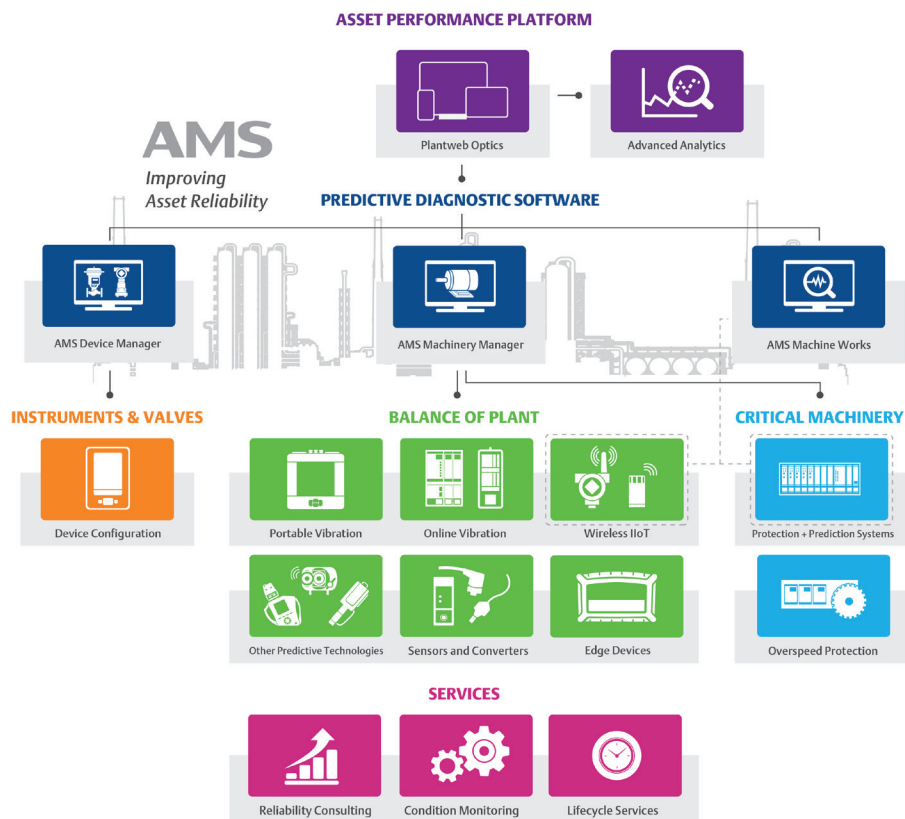

A key strategy to improving reliability is to monitor the condition of both production and automation assets in your plant. Emerson offers a variety of condition indicator technologies specific to the nature and criticality of those assets – portable handheld and asset management solutions, wireless transmitters, and online continuous monitoring systems that can include protection capabilities.

- Machinery Health Management combines condition monitoring technologies with predictive intelligence to reduce both scheduled and unscheduled downtime of your rotating equipment.
- Field Device Management utilizes configuration and calibration data to confirm your automation assets are operating effectively, thereby protecting the reliability of your production assets.



Drive equipment reliability using smart field devices.

Proactively managing your field device assets so that they are accurately configured and calibrated is key to ensuring the value of their predictive diagnostics. With effective asset management and predictive intelligence, you can focus on driving equipment performance.

Take advantage of modern innovations

Advances in protection system technology and the emergence of both IIoT and edge analytics have resulted in new approaches to machinery monitoring and collaboration. Now more than ever, you can get more information and diagnostics from more machines to more people.

Cut maintenance costs with predictive intelligence.

It costs approximately 50% more to repair a failed asset than if the problem had been addressed prior to failure. Predictive intelligence from condition indicators improves overall plant reliability by reducing scheduled and unscheduled downtime, driving down maintenance costs and increasing safety and availability.

Work with and learn from experts in reliability.

Regardless of where you are on the journey to improving reliability, Emerson experts can help. They can provide guidance, impart knowledge, or make themselves part of your team to accomplish your goals. Wherever you are, and whatever industry you are in, Emerson has been there to help facilities like yours achieve success.



Improve asset reliability using predictive field diagnostics

In a perfect world, your process would be consistent, day in and day out. But the reality is that field device performance, like most things, can degrade over time. Variability is a natural occurrence that must be dealt with.

Predictive diagnostics from field devices help your maintenance team keep sensing devices configured, calibrated, and operating effectively. And the measurements and control from those devices protect the reliability of your production equipment. Emerson's AMS Device Manager provides real-time online access to intelligent instrument and valve diagnostics and alerts, delivering a view of device health and troubleshooting information when an issue is found. The AMS Trex Device Communicator and 475 Field Communicator allow your personnel to assess health and repair devices from the field. Whether online or offline, Emerson gives you the tools to ensure your field devices are performing as expected.

What's your challenge?

Production capacity is lost to as much as 5% every year as a result of unplanned shutdowns.

– Asdza Nadleehe, "Engineering & Maintenance: Prevention Is Better Than Cure," *Oil & Gas IQ*, October 2011.



5%
Production
Capacity Lost

What's your opportunity?

Even small fixes have big impact. While using AMS Device Manager, Braskem S.A. found a calibration error on a pressure control valve, causing the valve to open 3% when it was supposed to be closed. Fixing the calibration error saved the plant \$300,000 a year.

– Braskem S.A. in Brazil



300k
Saved

Improve the effectiveness of your maintenance team



Predictive diagnostics help personnel focus their efforts on the assets that need attention, while eliminating unnecessary work on healthy devices.

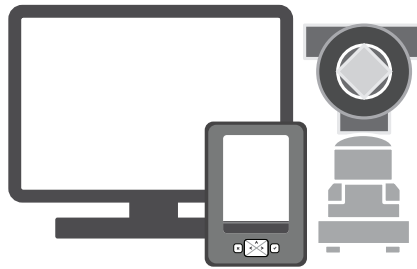

Troubleshoot problems directly from the maintenance shop or in the field. Troubleshooting advice helps technicians solve the problem quickly.



Easily prioritize work based on the criticality of the asset and the urgency of the alert. Ensure technicians are spending time on the production critical issues.

Reduce configuration/commissioning time

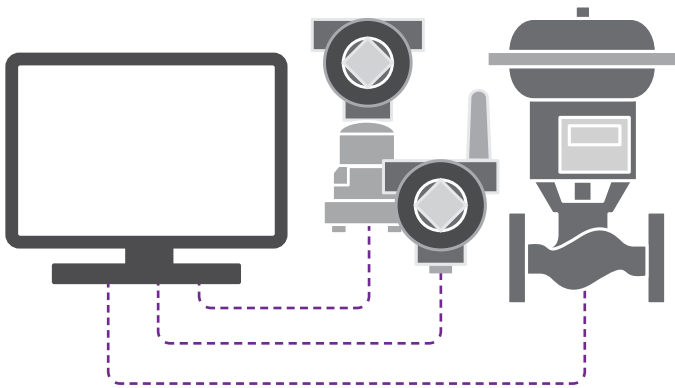

Use device templates to set up once and configure many, reducing set up errors and improving commissioning efficiency.

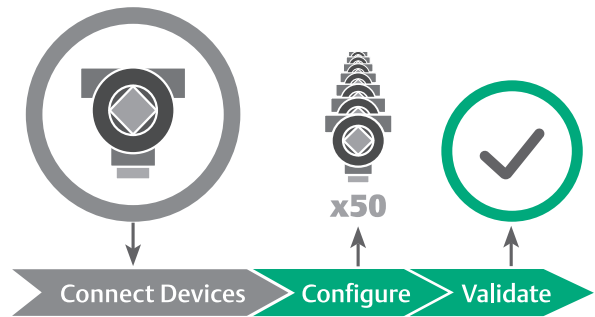

Configure in bulk to reduce commissioning time by up to 80%. Once device templates are complete, apply to common devices simultaneously. Then validate configurations quickly with a discrepancies report.

Streamline calibration work processes and reduce errors



Eliminate paper-based calibration by electronically managing routes with AMS Device Manager to reduce calculation and documentation errors.

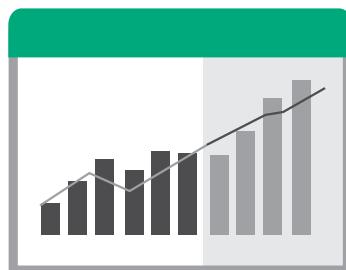

Extend calibration intervals while remaining compliant using historical drift trends in AMS Device Manager. Eliminate the unnecessary effort of scheduled-based calibration.

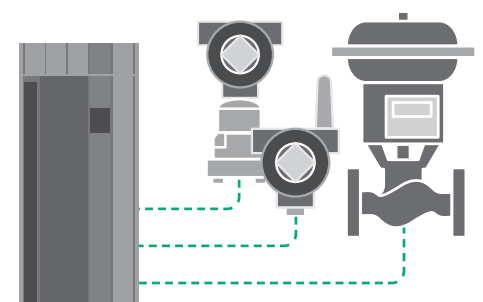

Centralize device data in a single database to enable better analysis of health and performance and improved resource planning and scheduling.



Drive success using predictive intelligence

When your assets aren't reliable, you can't maintain your schedule or operate within budget. Your assets become the drivers of your success. But with predictive intelligence, you gain the insight necessary to schedule maintenance that supports your production goals. Emerson's technology for delivering predictive intelligence puts you back in the driver's seat.

Vibration data is the cornerstone of predictive intelligence. Emerson offers accurate, industry-proven technology for data collection and field analysis of vibration data on a wide range of rotating assets. Factors such as asset criticality and location determine whether the technology is applied periodically or continuously. Vibration data can be routed back to the control room where operators can easily leverage both asset condition and process data to make educated production decisions.

Emerson's vibration data collection technologies feature a unique methodology - PeakVue technology - to cut through the complexity of machinery analysis and provide a simple, reliable indication of equipment health that is easily understood by both operations and maintenance.

50%
MORE 
Repair Costs

What's your challenge?

It costs approximately 50% more to repair a failed asset than if the problem had been addressed prior to failure.

– U.S. National Response Center

5%

Reduction in
maintenance
cost

What's your opportunity?

Reduce repair expense. By making use of predictive data to improve the reliability of their rotating equipment, Saudi Aramco, Ras Tanura refinery, reported a total program savings of over \$10 million annually and a 9% reduction in maintenance costs.

– Saudi Aramco, Winner
– Reliability Program of the Year 2015.

Safeguard critical assets 24/7 with online monitoring

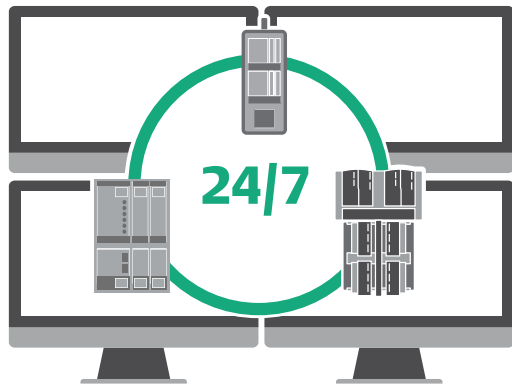

Continuous monitoring of both critical and balance of plant assets provides real-time machinery health feedback to the DCS – either integrated via AMS 6500 to DeltaV, or embedded as an Ovation Machinery Health Monitor.

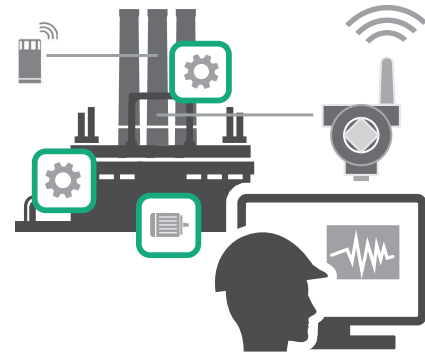

Wireless IIoT delivers machinery health information from remote or hazardous locations with minimal installation costs. The AMS 9420 and the AMS Wireless Vibration Monitor offer many of the same capabilities as other monitoring options.

Maintain availability through periodic monitoring

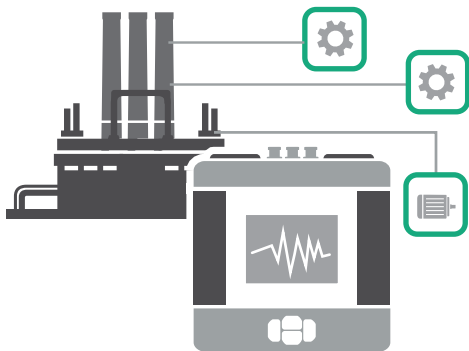

Route-based monitoring using the AMS 2140 maintains production-essential assets and allows for sophisticated diagnostic testing while in the field.

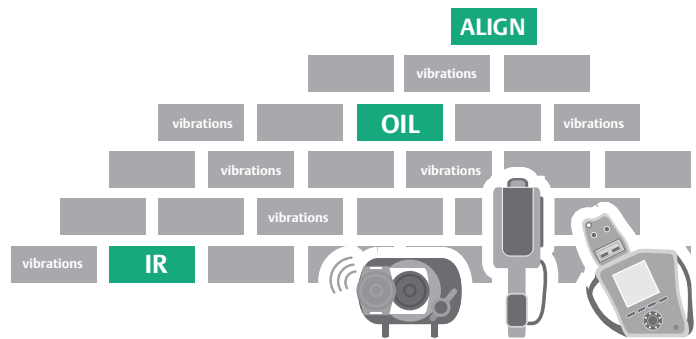

Integration of complementary technologies such as infrared thermography, oil analysis, and laser alignment capabilities creates a complete picture of machinery health.

Simplify data collection and analysis



One source of responsibility for the entire measurement chain streamlines troubleshooting of monitoring issues. Emerson offers a full portfolio of accelerometers, sensors, and specialized measurement instrumentation.

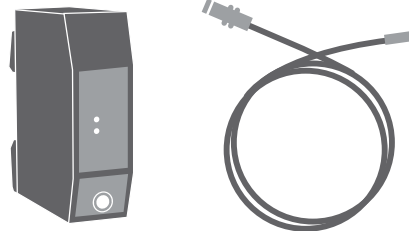

Reduce spares and order lead times with the AMS EZ 1000 eddy current measurement chain. Sensors are field-calibrated with a single button push. Converter calibration is a simple three-step process using the USB interface to Emerson's Machine Studio software.

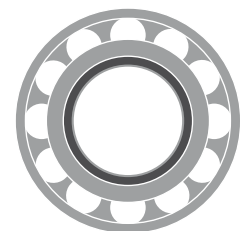

Cut through the complexity of machinery analysis using Emerson's patented PeakVue technology, embedded in all vibration monitoring equipment. As a measure of impacting, PeakVue readings are much easier to interpret.



Improve reliability using the most modern technologies

Not your old-fashioned protection system

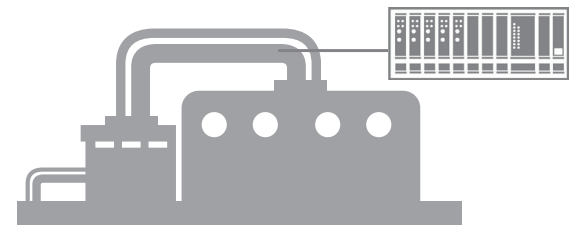

Safety regulations and often insurance requirements necessitate the installation of a shutdown system on your expensive and critical production assets to protect both lives and investments. But protection doesn't have to be just a necessary expense – the right protection system can be a path to integrating the predictive intelligence that allows you to avoid false or missed trips.

Through system integration and unique data access, Emerson protection systems allow you to confidently determine when critical assets can be allowed to continue running safely.

By recording data during equipment start-ups, coast downs, and other transient events, Emerson protection systems provide you the information necessary to make informed operational decisions. Systems are compliant to a variety of API standards and SIL environments, meeting the strict safety and insurance requirements such as those in the refining and petrochemical industries.

What's your challenge?



A typical refining facility will spend less than 10% of its time in transient operations. However, 50% of all process safety incidents occur during this time.

*– Tame Your Transient Operations,
Chemical Processing June 2010*



What's your opportunity?

Operate safely during typically dangerous conditions. The startup and coastdown of turbo machinery is potentially the most dangerous operating state due to the rapidly changing conditions. Rather than just snapshots of data, Emerson delivers real-time data on multiple channels simultaneously for the most powerful, accurate diagnostics and safer operating conditions.

Time to stop thinking outside the box

Installation costs and complexity have historically kept continuous online monitoring reserved for the most critical assets in the plant. And understanding the data from those systems required a certain level of vibration expertise. This has historically meant that balance of plant assets could only be monitored using route-based or wireless technologies - if they were monitored at all - and the data had to be reviewed by a vibration analyst.



While we usually refer to innovation as thinking “outside of the box”, the latest innovation in online monitoring is all about what is inside the box. The AMS Asset Monitor has everything you need – monitoring capabilities, software and expertise - inside the box to change the way you monitor balance of plant assets. This new edge analytics device that is designed to deliver prediction and basic protection capabilities, but with embedded diagnostics to identify the most common faults associated with a wide range of assets. Notification of these developing faults allows personnel from operations, process and reliability to assist in the monitoring of plant assets without extensive experience in vibration analysis.

Increase visibility with smaller, fewer footprints

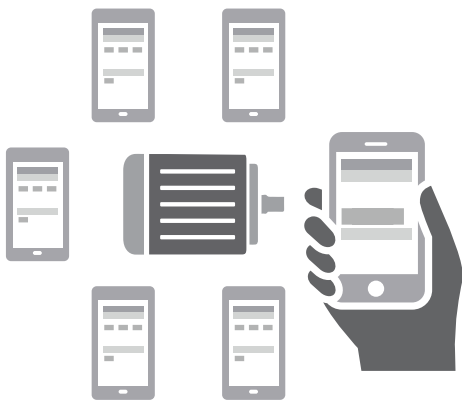

Anyone, anywhere can view asset health with the IP address and a mobile device.

Reduce Time, Components, and Cost

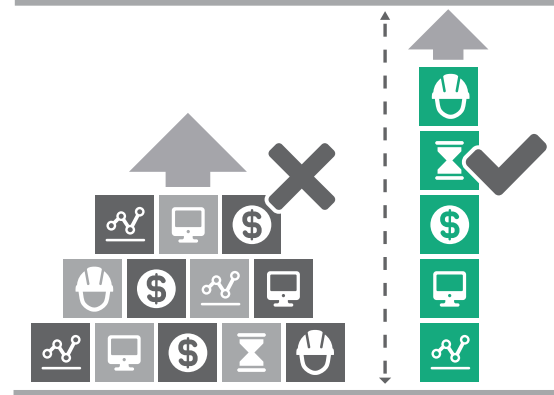

Achieve more with less: smaller and light-weight for easy field mounting, fewer cables, no additional server, no manual data collection.



Implement IIoT in your reliability program

The Industrial Internet of Things (IIoT) has arrived. Technology advances make it easier than ever to stay on top of asset health and stay in touch with the personnel who care about their performance – no matter where they are. But implementing IIoT can be a daunting task – where do you start? How do you bring together the silos of data in your plant without inundating the team with hundreds of alerts? You need a solution that promotes collaboration while still streamlining decision-making when problem calls for quick action.

Plantweb Optics is a software application that aggregates data from multiple sources, but delivers persona-based alerts and KPIs for improving reliability of your rotating equipment, instruments and valves. With additional connectivity to CMMS, advanced analytical tools, and other predictive intelligence programs, you'll stay on top of developing issues that could impact production. Anywhere, anytime.



60%

*of global manufacturers used analytics data recorded from connected devices to analyze processes and identify optimization possibilities**

*Source: IDC and SAP, as reported By Kelvin Claveria, 13 Stunning stats on the Internet of Things, Vision Critical blog, April 2017

**IIoT will lead to a*
↑ 15%
productivity increase
in delivery and supply chain performance

The platform for integrating and communication asset health information

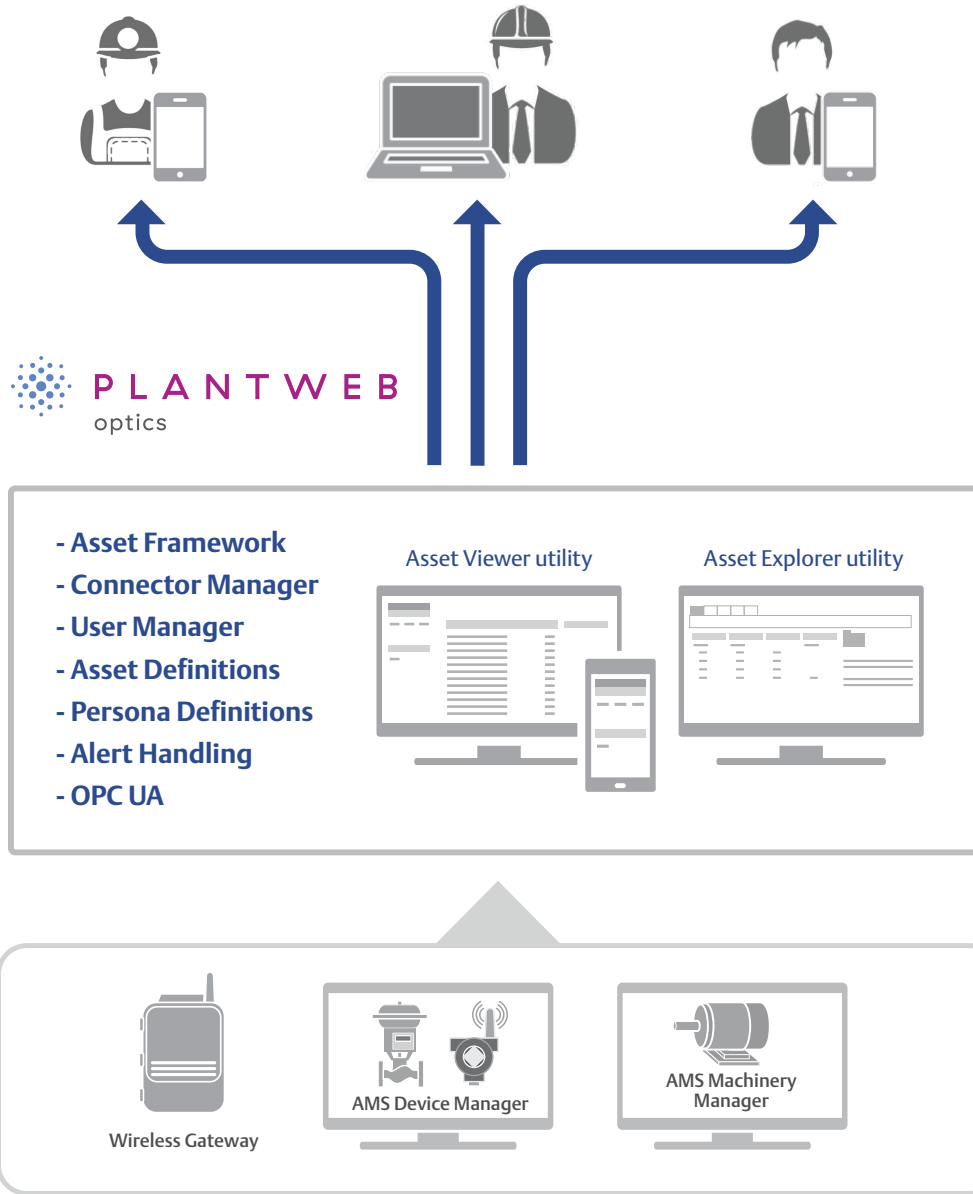

Easy to setup, easy to use

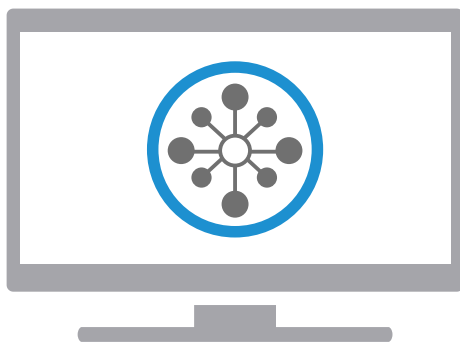

The **Asset Explorer** utility features an intuitive user interface for performing a wide range of setup and configuration activities, such as added machine trains, assigning roles and responsibilities, and much more.

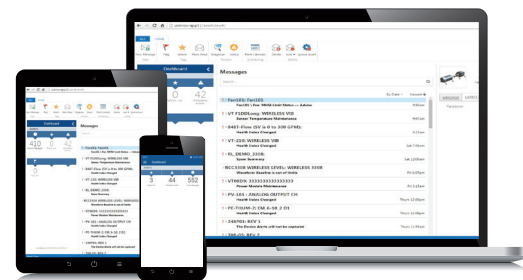

The **Asset Viewer** utility runs on laptops, tablets and smart phones to deliver the right information at the right time.

Supplement your industry expertise with our reliability expertise

Implementing predictive intelligence and protection technologies from Emerson will deliver positive results in reduced scheduled and unscheduled downtime. For companies pursuing top-quartile reliability, the return on investment is huge.

Emerson's Reliability Consulting delivers comprehensive, scalable asset management and reliability services to diverse industries. Core competencies are centered on two skill sets: reliability engineering and data integrity. Mastery in each skill set allows Emerson to serve clients independently in each area, or with a combined expertise to implement reliability on an enterprise scale.

Emerson is your partner for improving reliability by providing:

- Condition indicators and asset health analysis tools that drive information towards action.
- Consulting services to assist in the development of foundational data and enterprise-wide reliability management programs.

Enhance your team, expand their skill set



Machinery condition monitoring services utilize a global network of vibration and oil analysis experts to remotely analyze your data.



Scheduled onsite services provide additional manpower to perform a wide range maintenance services.

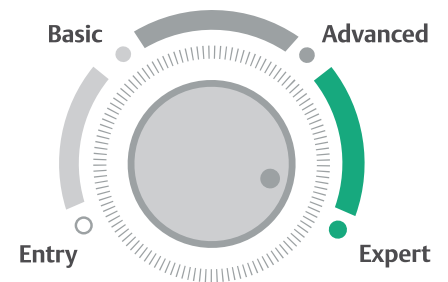

Hands-on training with proven educational tools elevates your team's expertise and ensures your plant's performance levels.



43% DOWNTIME
As much as 43% of unplanned downtime is caused by equipment failure

-Large Property Damage Losses in the Hydrocarbon-Chemical Industries, 17th Edition.

60-80% of the total life cycle costs

Operations and Maintenance costs are between 60-80% of the total life cycle costs for a given asset.

-Maintenance & Reliability Best Practices by Ramesh Gulati, 2012



Protect and expand the value of your technology investment

While many companies recognize a significant ROI following their technology implementation, companies that commit to maintaining their technology advantage reap the benefits for years to come.

Guardian Support Services

Improving reliability in the plant requires more than just acquiring the right monitoring and analysis technologies. You need to actively manage those investments and their lifecycle costs. Emerson offers Guardian Support services designed to optimize the reliability and performance of your machinery health products. Specific, critical information is matched to your system and proactively delivered to you through a secure dashboard portal available 24x7x365. Guardian Support also delivers incident management with access to experts to help you through critical issues. An accurate inventory of all system components and licensing combined with in-depth documentation and resources aids in your troubleshooting.

Educational Services

Companies today rely on fewer people to do more work. The need for training is more critical than ever to achieve and maintain cost effective maintenance programs. Emerson helps maximize the return on your investment in technology and people. Our goal is to provide you with the knowledge to keep your plant running smoothly.

Improve availability, profitability and safety with Emerson's reliability solutions.

AMS

Emerson – Reliability Solutions North America
835 Innovation Drive
Knoxville, TN 37932 USA
☎ +1 865 675-2400

Emerson – Reliability Solutions South America
Av. del Valle 601, 4to piso,
Ciudad Empresarial,
Santiago Chile
☎ +56 2 4310-7432

Emerson – Reliability Solutions Europe
Katzbergstr. 1
40764 Langenfeld (Rhld.)
☎ +49 0 2173 3348 0
☎ +49 0 2173 3348 100

Emerson – Reliability Solutions Asia/Australia
1 Pandan Crescent
Singapore 128461
☎ +65 6777 8211
☎ +65 6777 0947

Emerson – Reliability Solutions Middle East/Africa
PO Box 17033
Dubai - United Arab Emirates
☎ +971 4 811 8100
☎ +971 4 886 5465

🌐 www.emerson.com/ams

©2016-2020, Emerson. All rights reserved.

The Emerson logo is a trademark and service mark of Emerson Electric Co. All other marks are the property of their respective owners.

The contents of this publication are presented for informational purposes only, and while diligent efforts were made to ensure their accuracy, they are not to be construed as warranties or guarantees, express or implied, regarding the products or services described herein or their use or applicability. All sales are governed by our terms and conditions, which are available on request. We reserve the right to modify or improve the designs or specifications of our products at any time without notice.

AMS_BR_PredictionProtectionProductionAssets_0620



EMERSON. CONSIDER IT SOLVED.™