

17. 英語ぬりえ

提供：大阪樟蔭女子大学児童学部児童学科・菅ゼミ

解説【色を聞いて正しく色がぬれるかな】

「ぬり絵」の原画（線画）に書かれている番号の所に、英語の色名を聞いて、クレパスやクーピーなどの色鉛筆を使って、正しく色をぬる「英語ぬり絵」です。年齢によっては、線に沿って、綺麗にはみ出さないようにぬることは艱難なことなので、だいたいぬることができたら良いこととします。

ここで取り扱う色には、black（黒）、white（白）、red（赤）、blue（青）、green（緑）、brown（茶色）、purple（紫）、yellow（黄色）、orange（オレンジ）、gray（灰色）、pink（ピンク）です。他に独自で、light blue（水色）、dark blue（紺色）、gold（金色）、silver（銀色）など、他の色を子どもに伝えて、カラフルなものに仕上げることも可能です。

指導する場合には、英語での色の言い方を練習した後に、英語の導入期には1～3種類程度の色をぬる簡単な「ぬり絵」を利用し、学習時間が増えるにしたがって、徐々に複雑な色の「ぬり絵」へとチャレンジさせることが重要です。

また、通常の図工やお絵かきの時間に、子どもたちにクレパスやクーピーで絵を描かせた後に、子どもたちみんなの前で、英語の色名を言わせながら絵について説明させることも楽しいものです。是非、トライしてみてください。楽しい「ぬり絵」になることでしょう。



大阪樟蔭女子大学児童学部児童学科・菅ゼミ

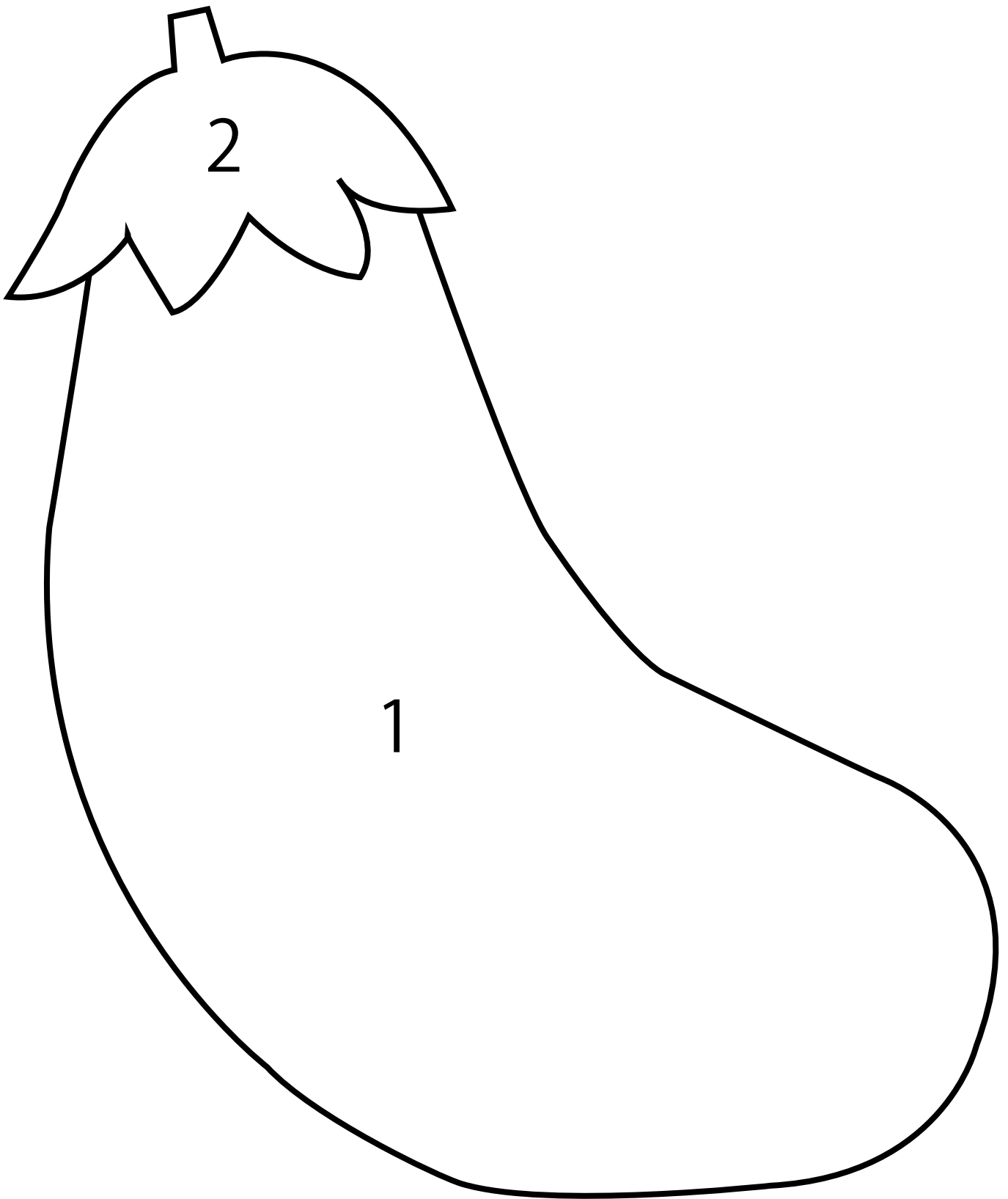

1.purple

2.black

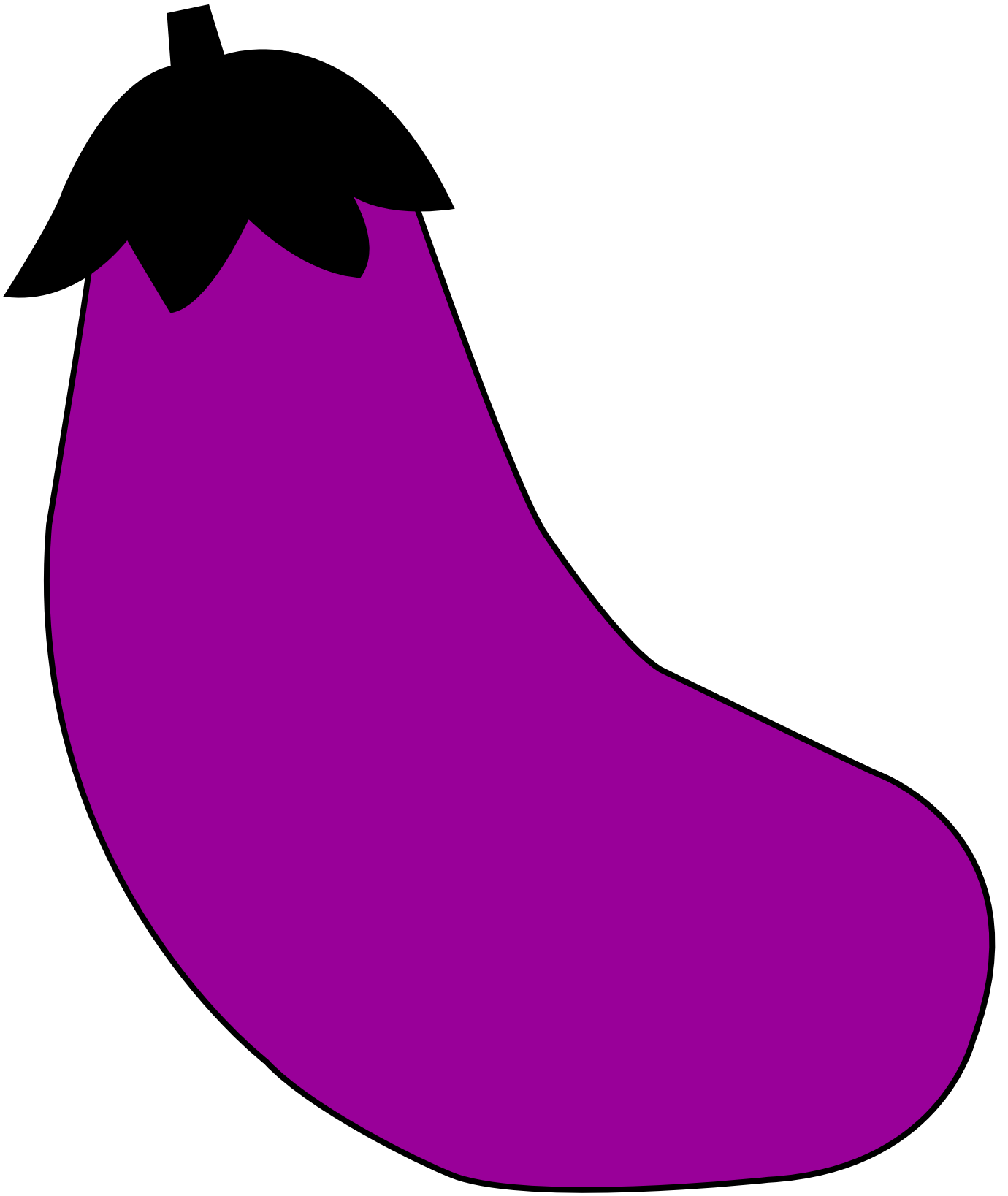

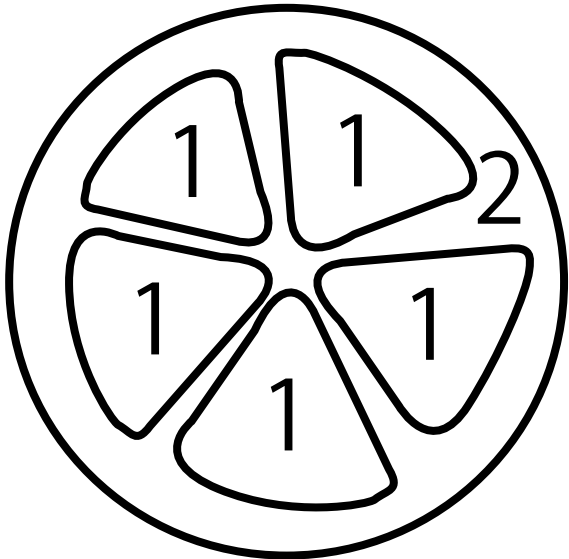
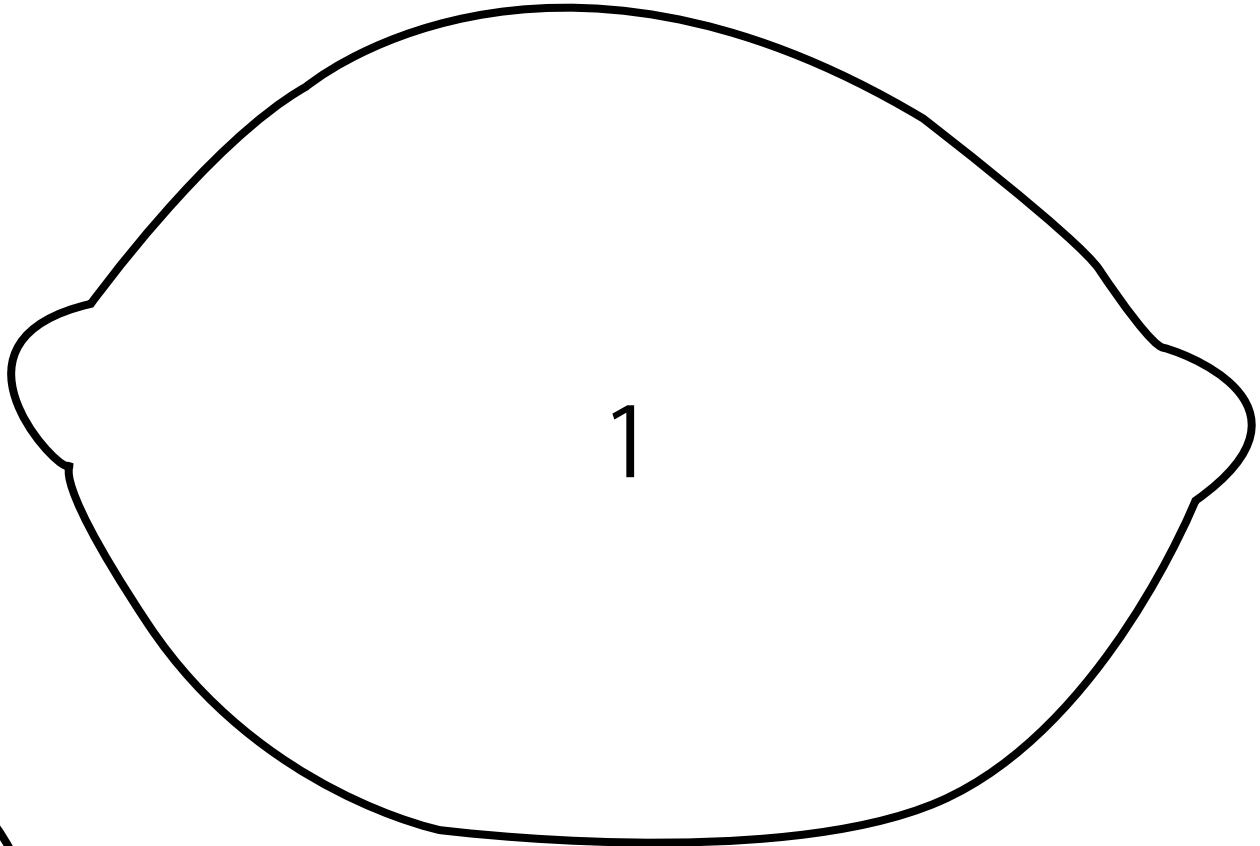

1.yellow

2.white

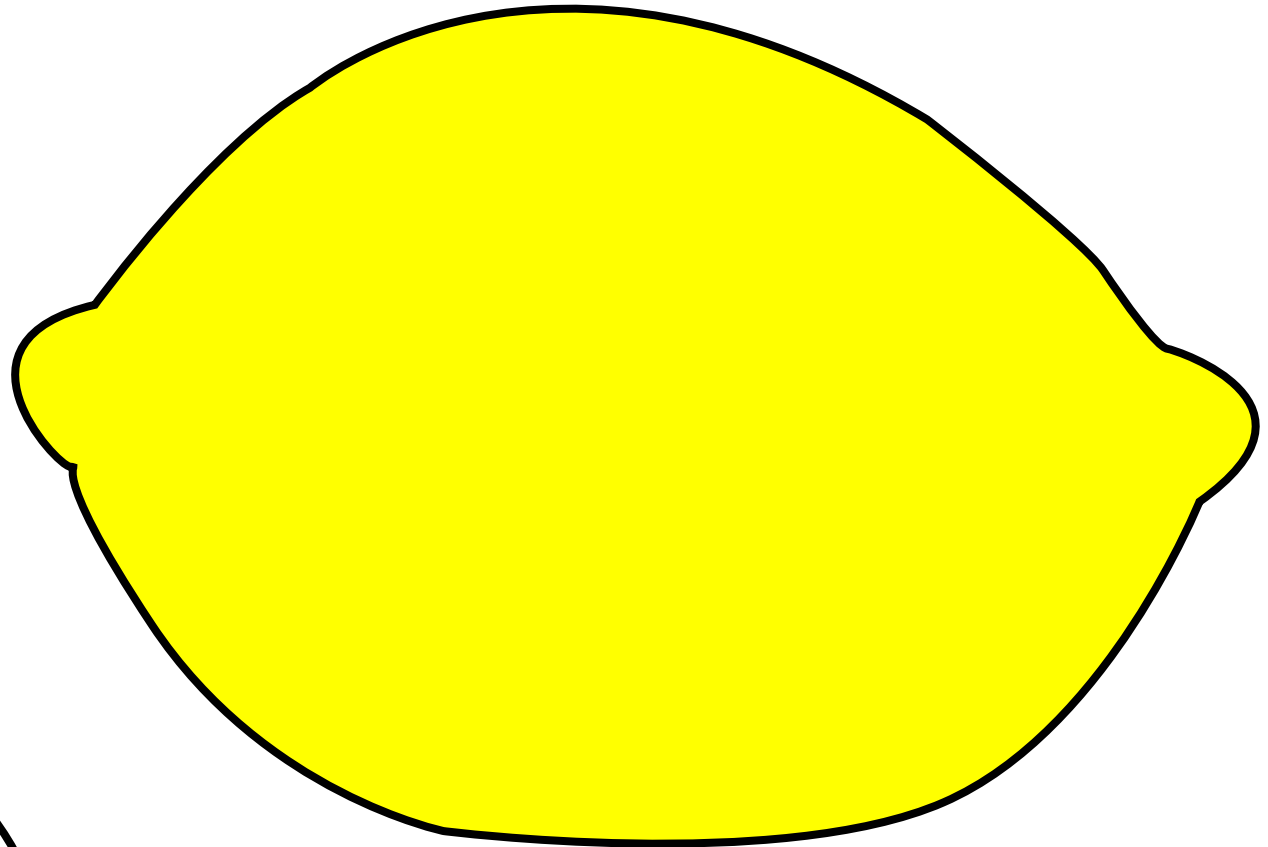
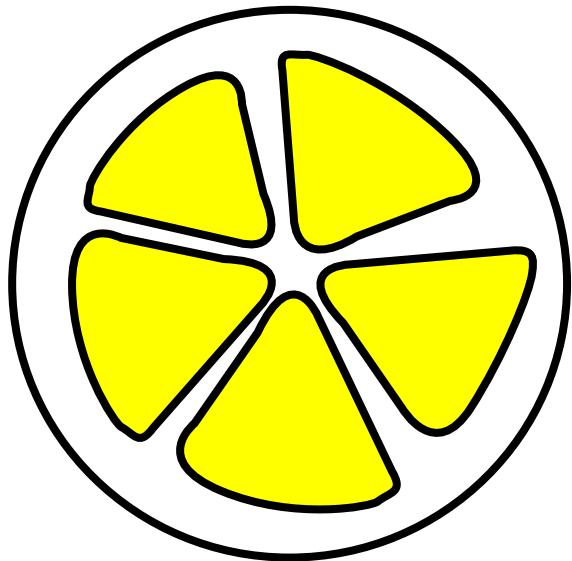

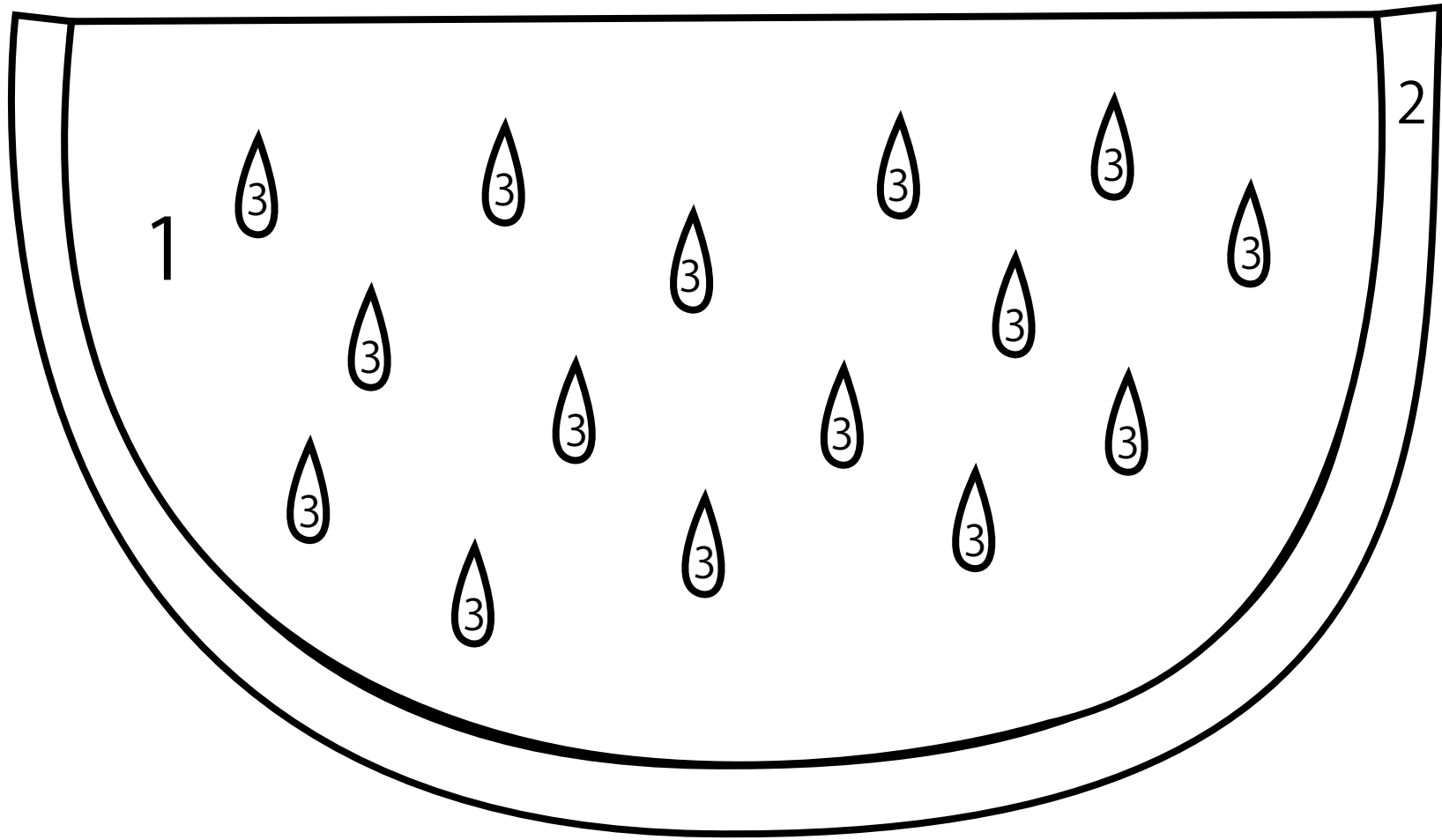

1.red

2.green

3.black

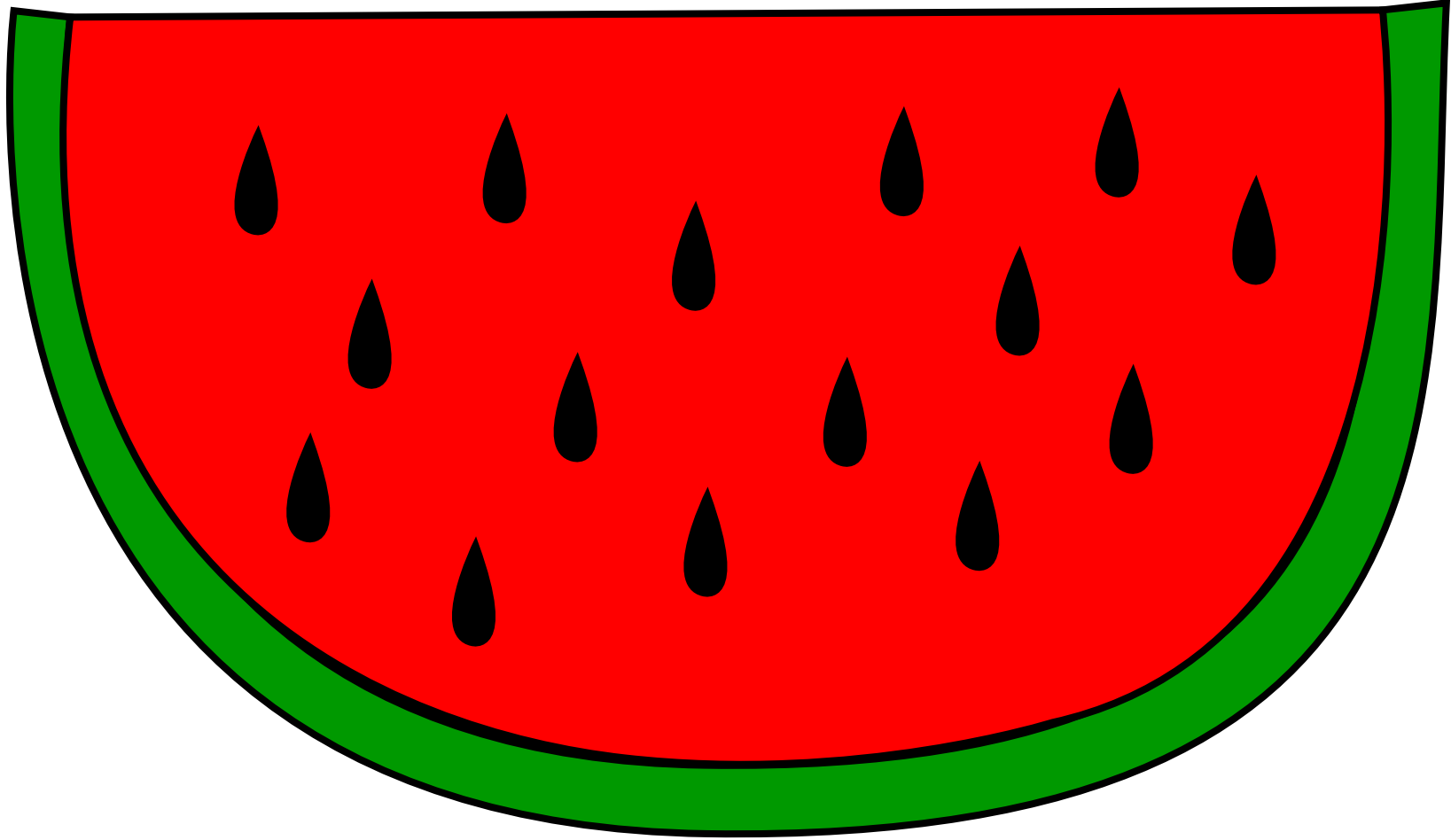

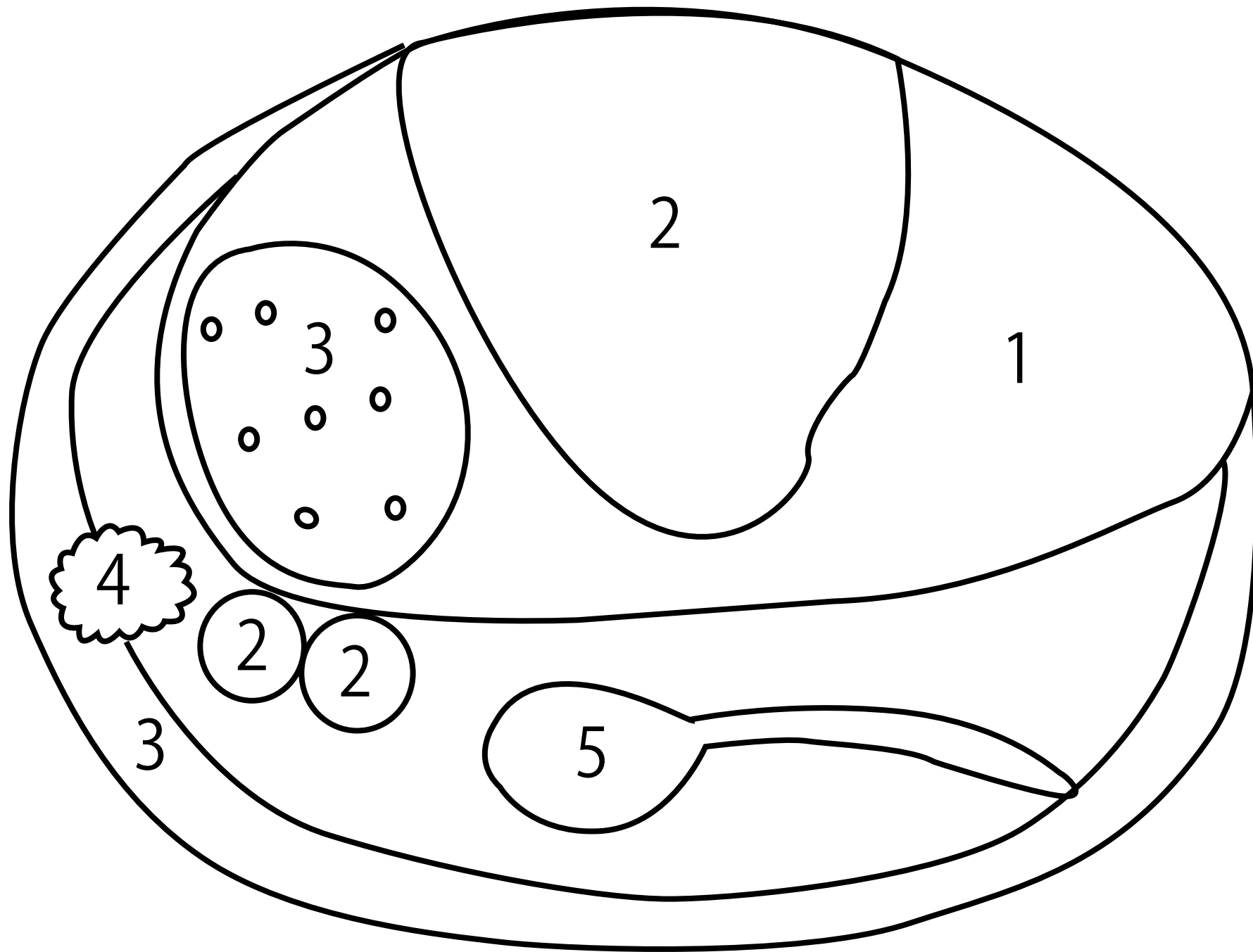

1.yellow

2.red

3.orange

4.green

5.gray

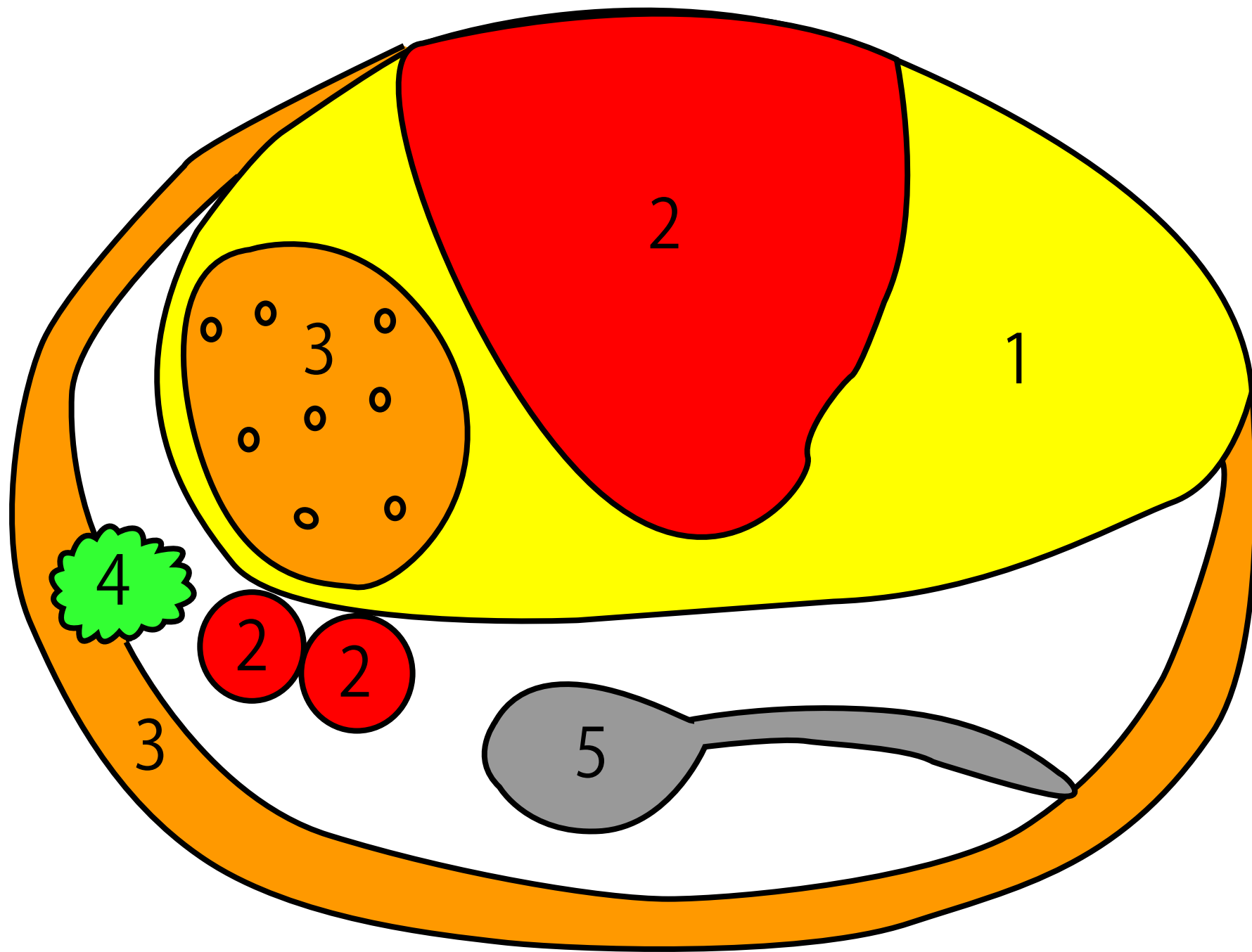

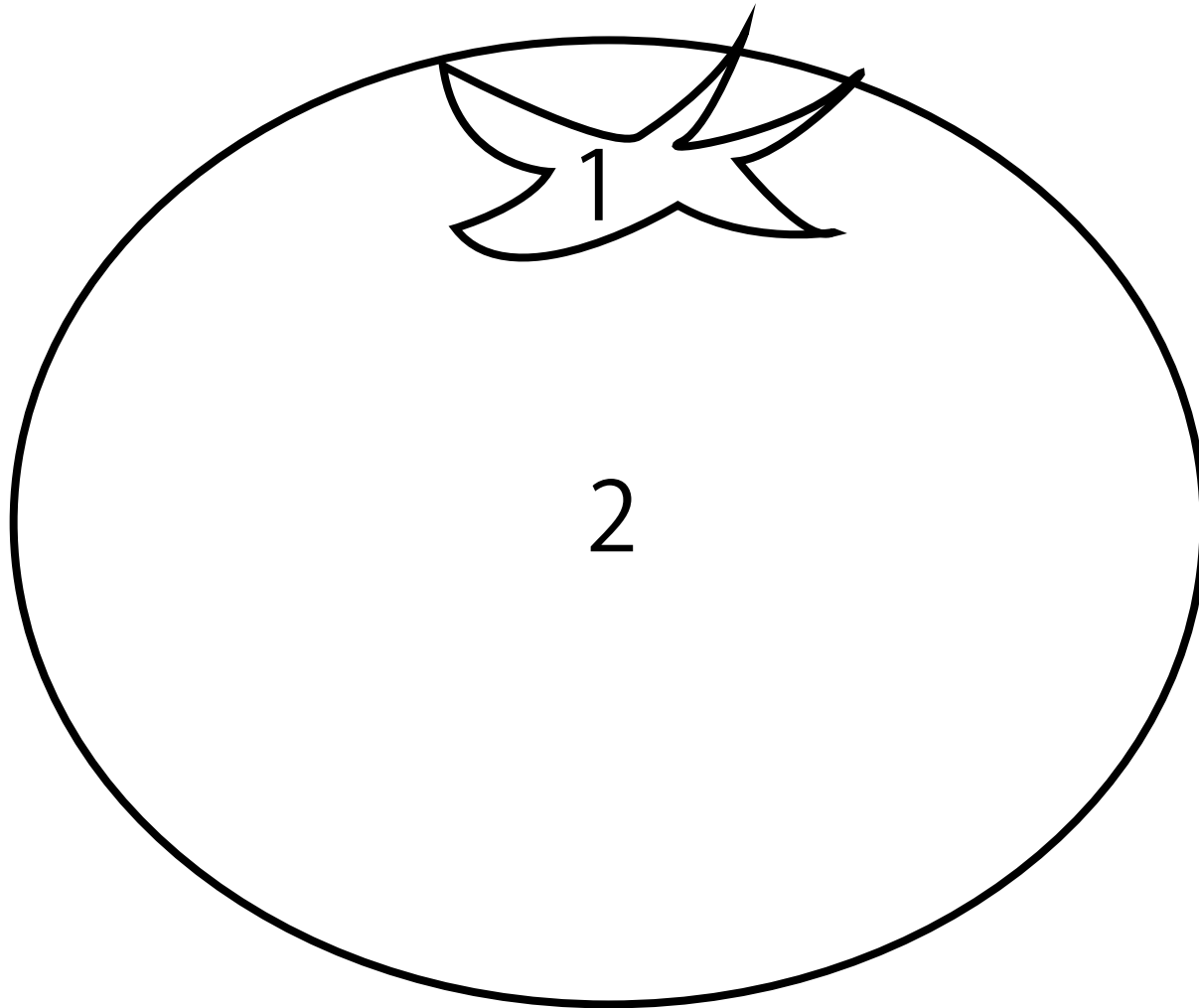

1.green

2.red

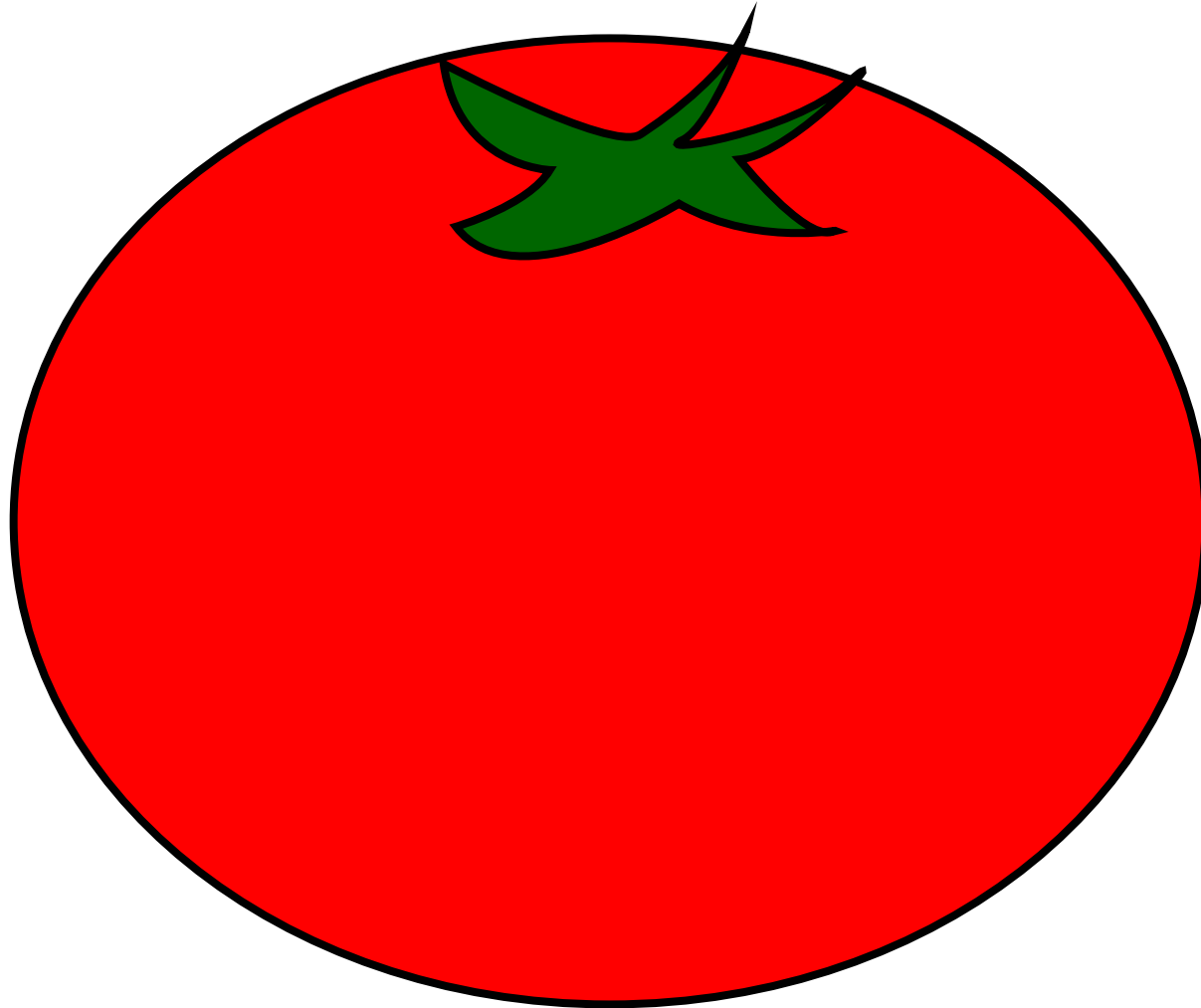

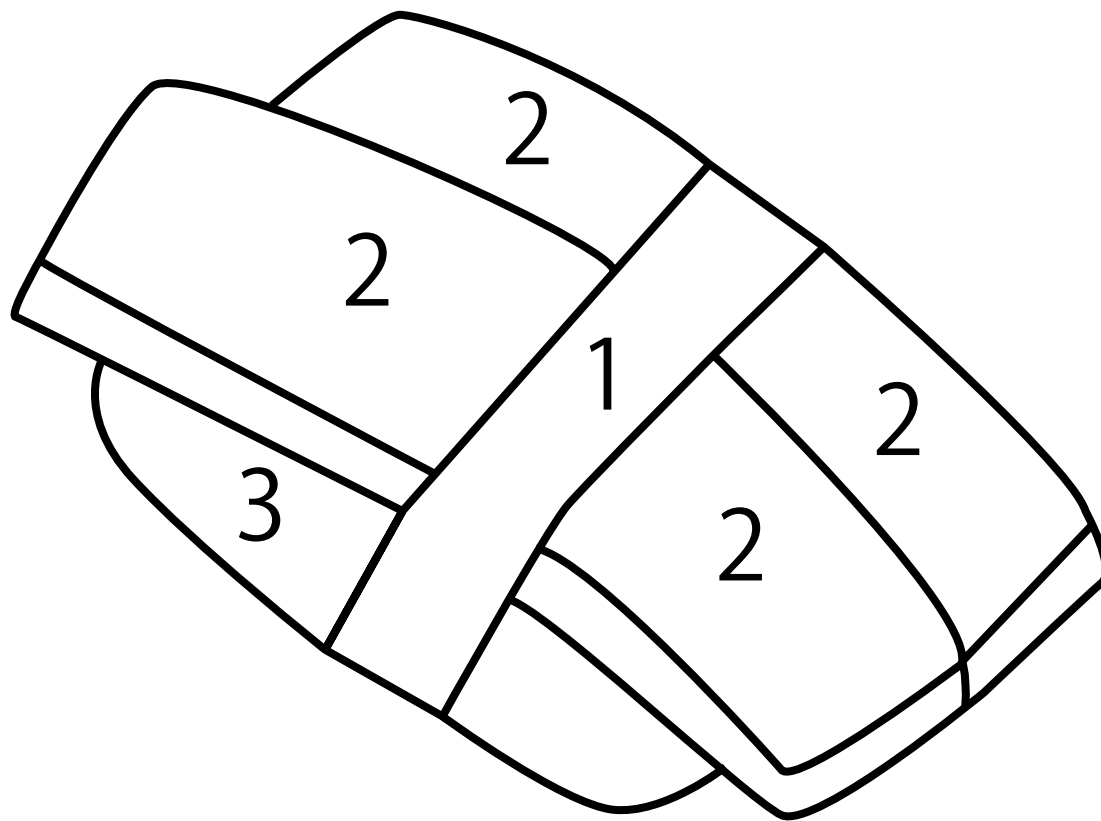

1.black

2.yellow

3.white

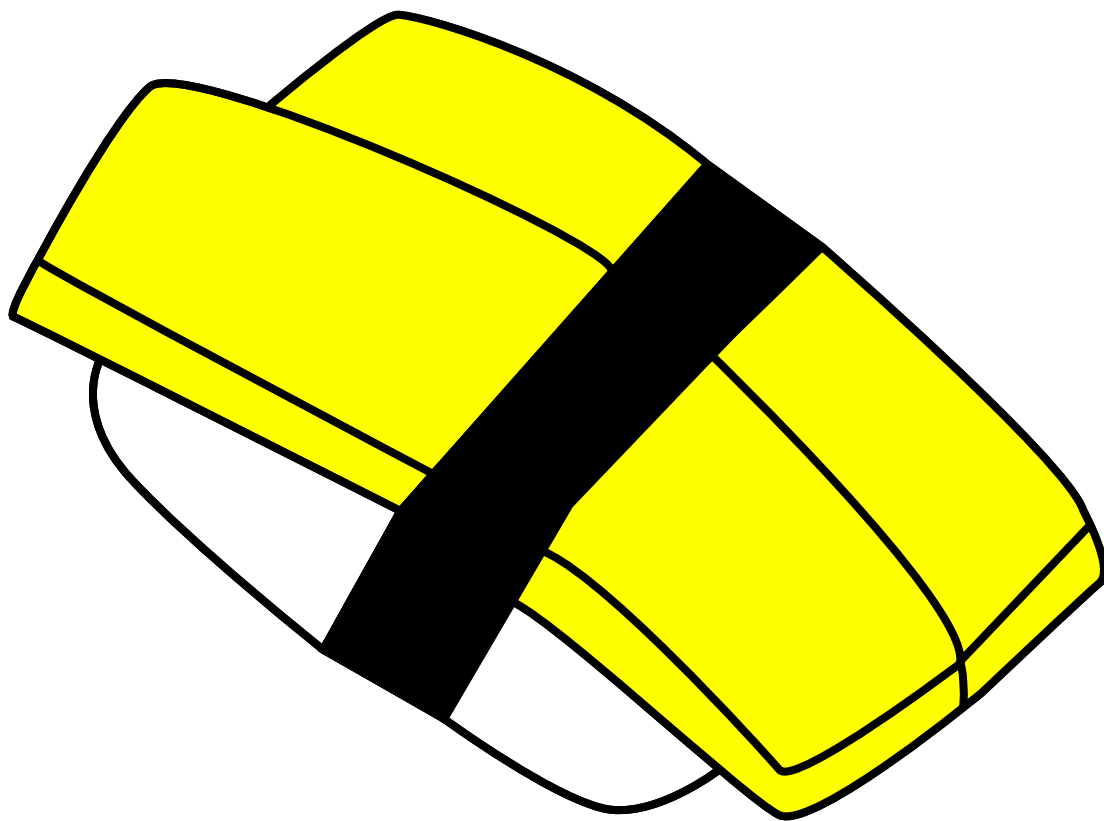

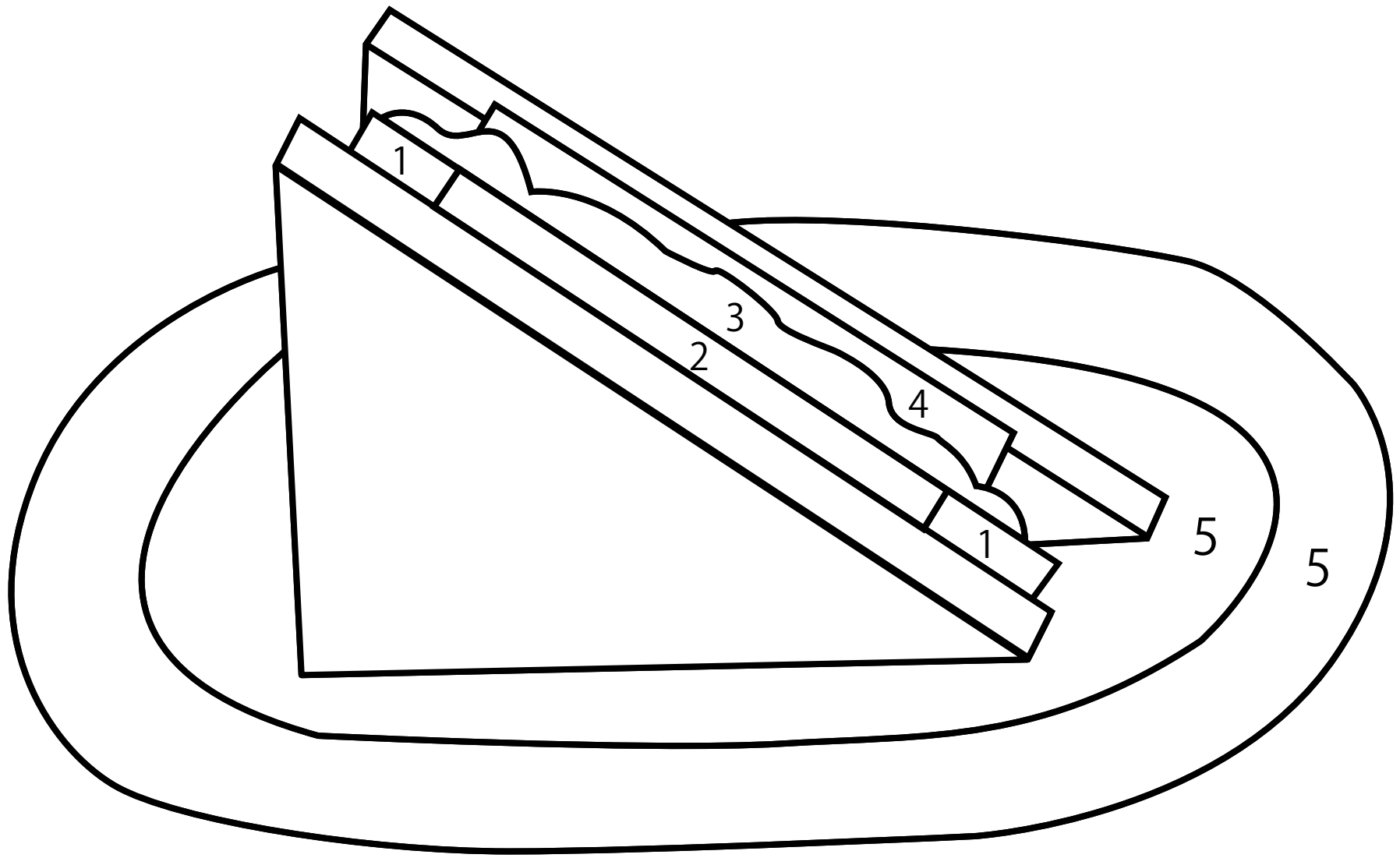

1.red

2.orange

3.green

4.brown

5.blue

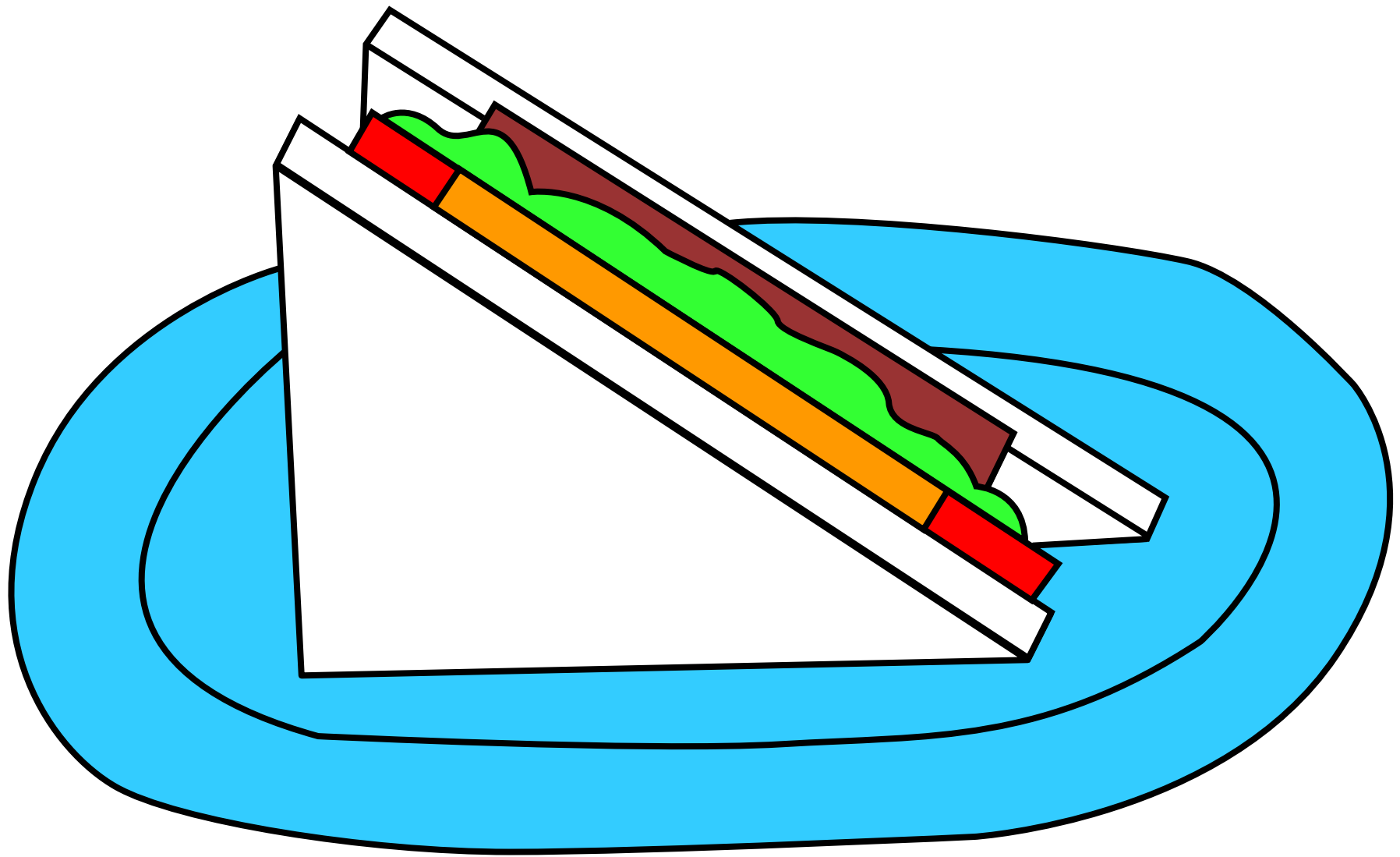

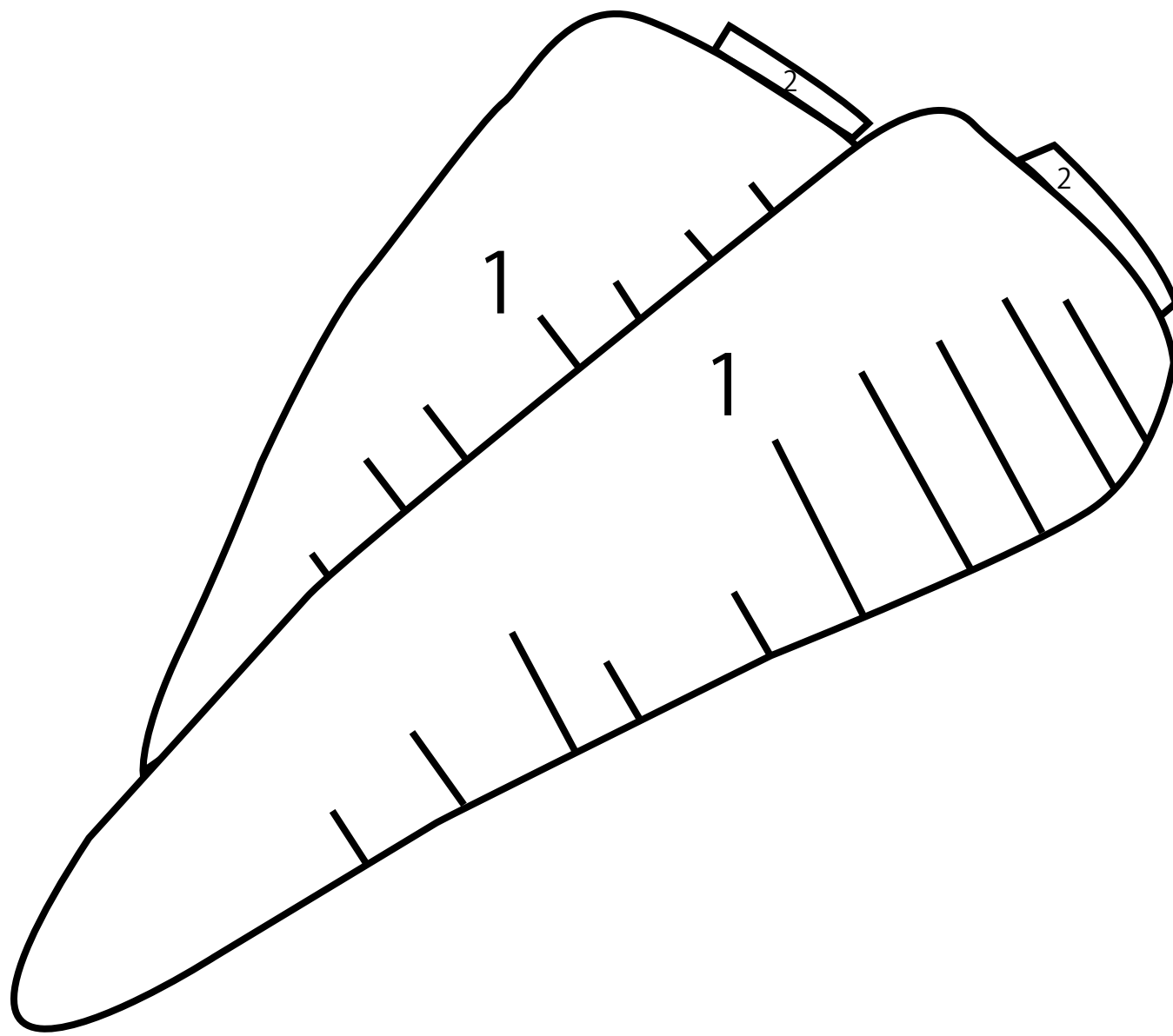

1.orange

2.green

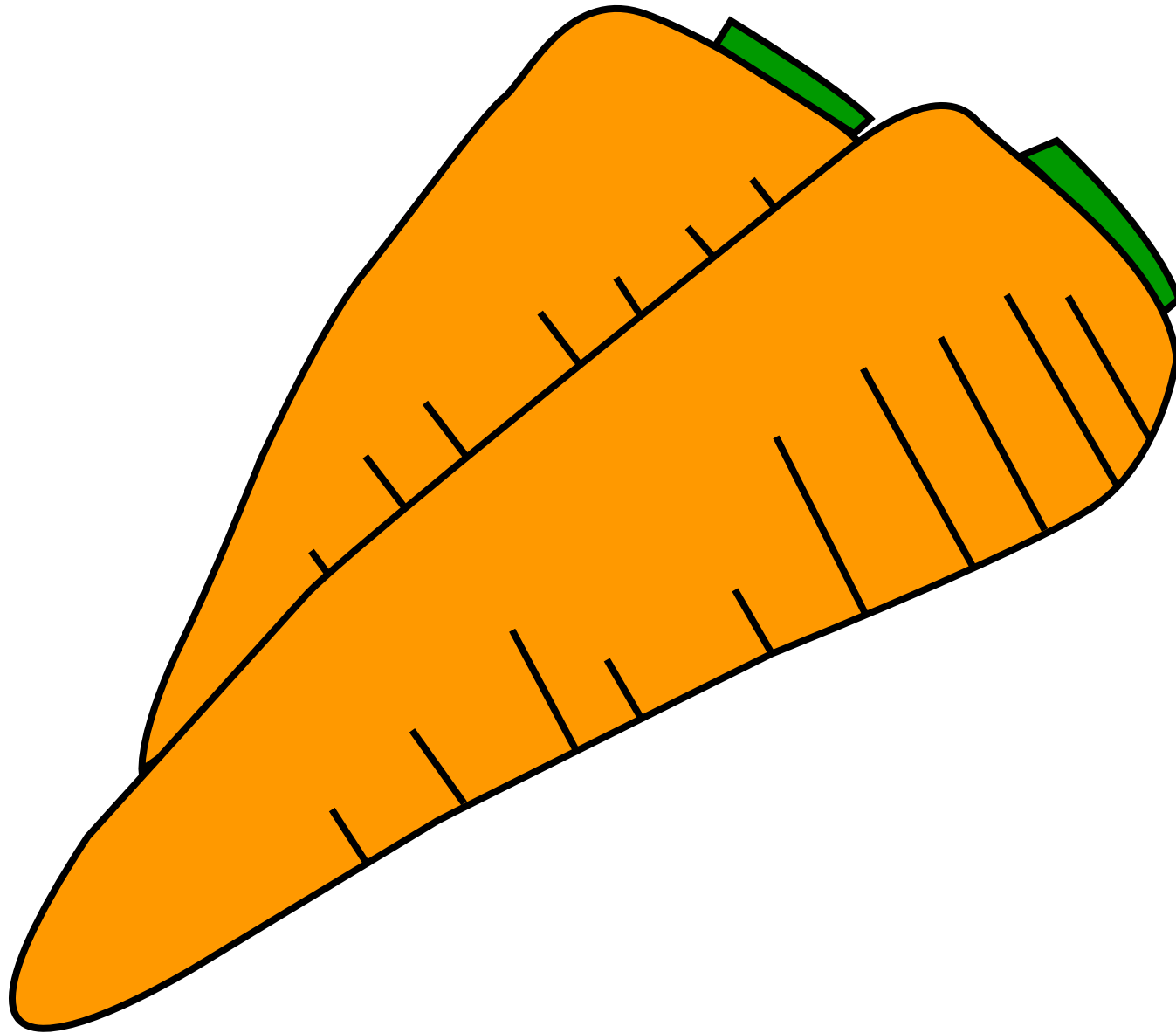

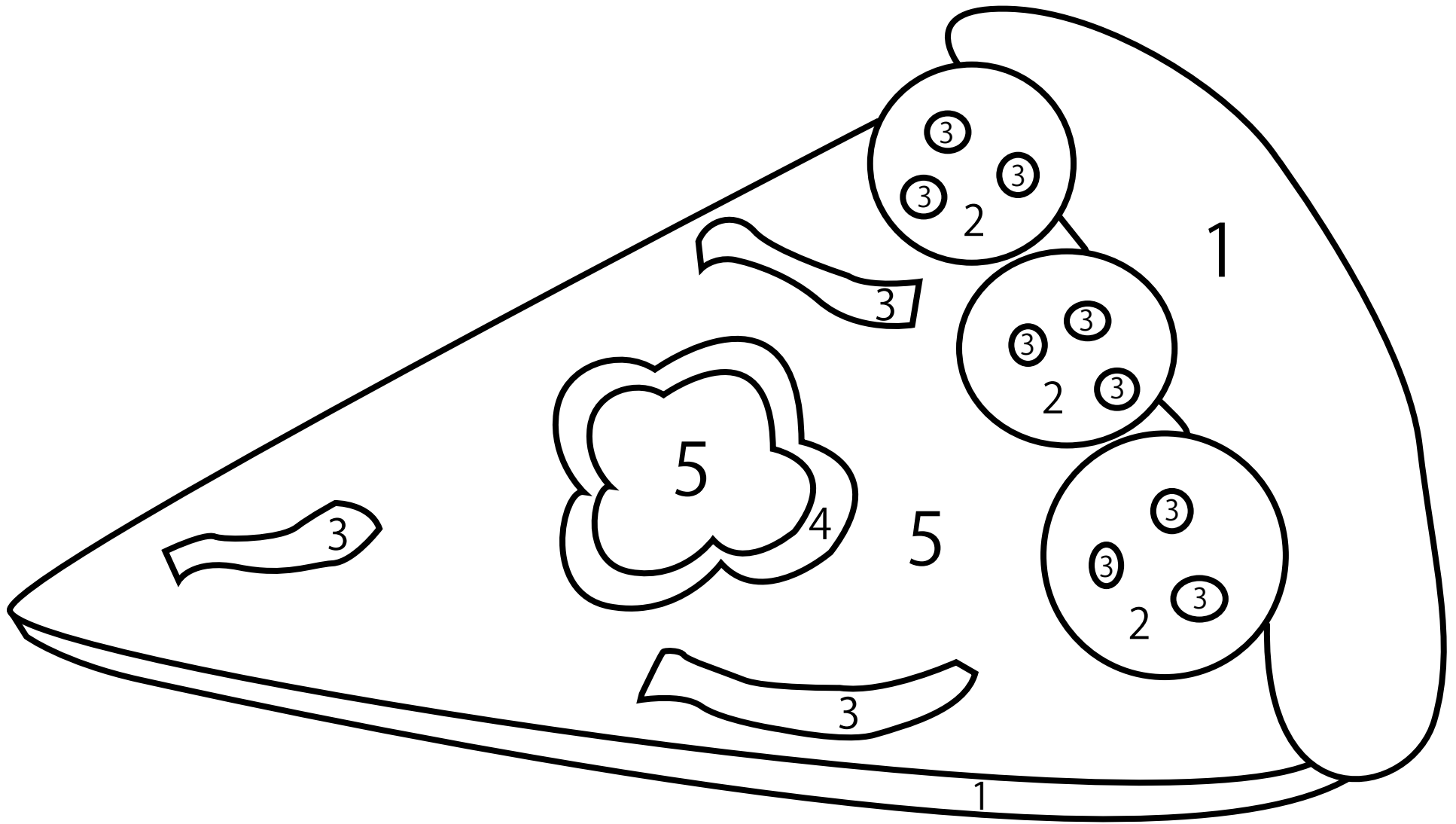

1.brown

2.pink

3.red

4.green

5.yellow

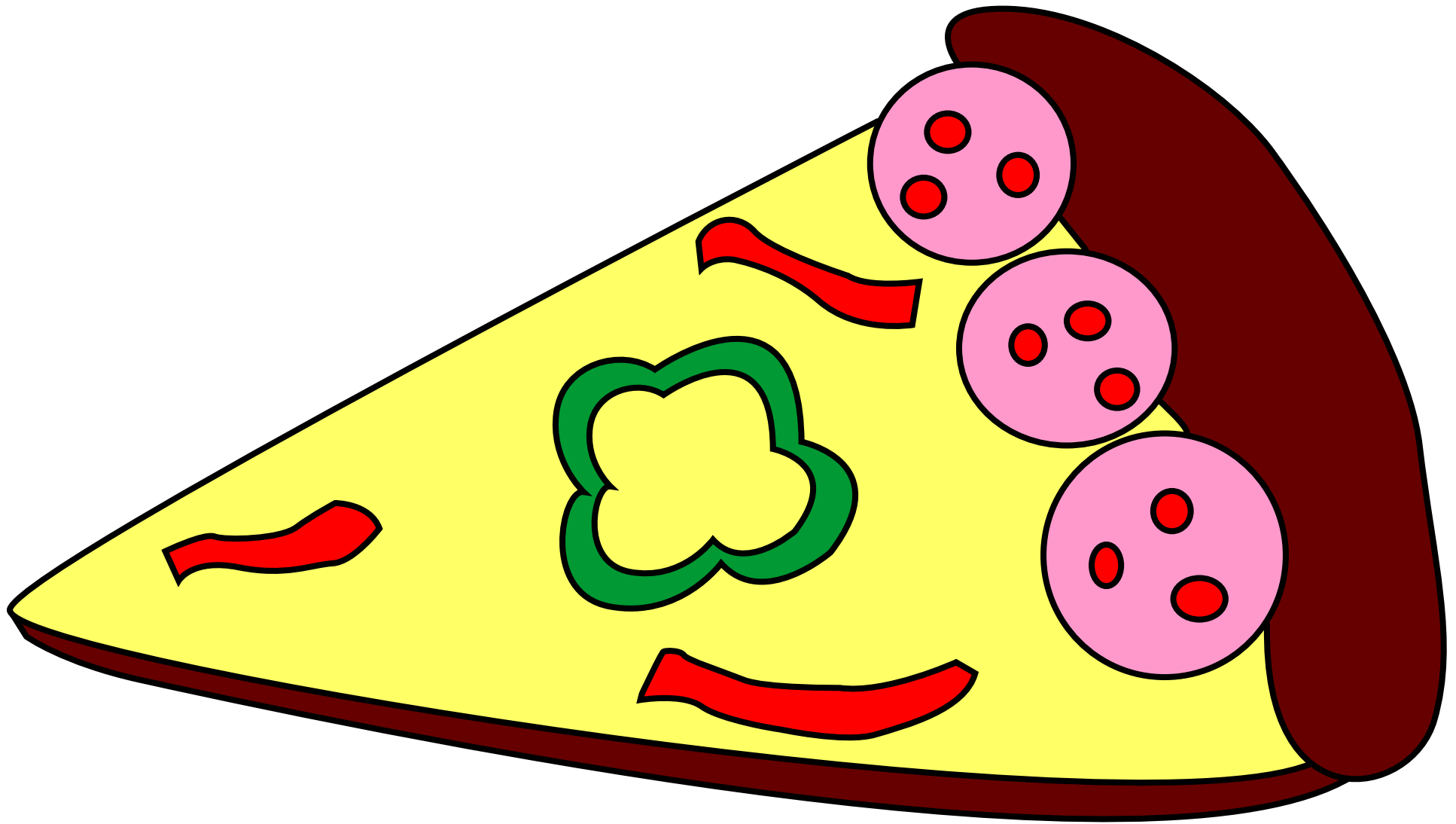

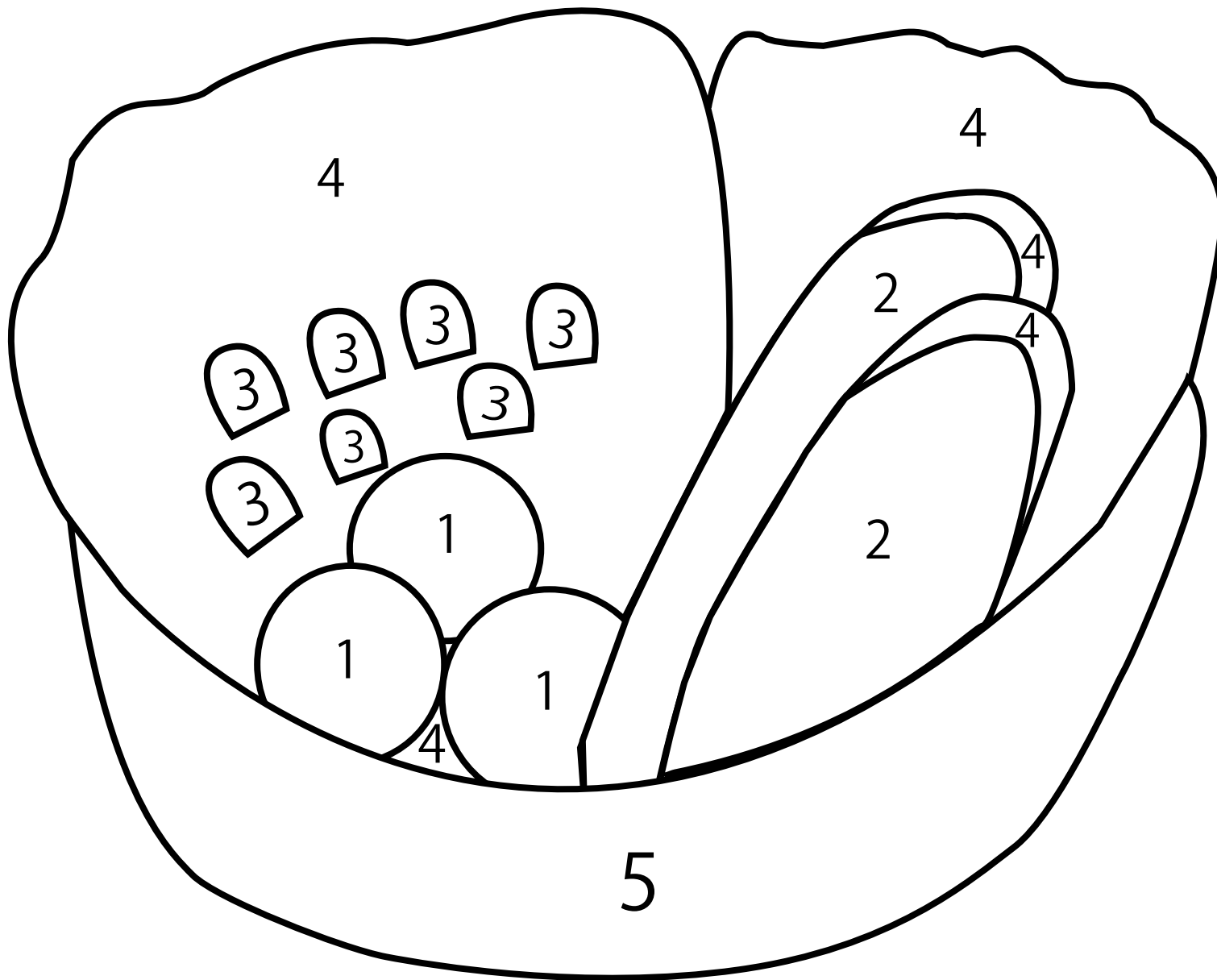

1.red

2.white

3.yellow

4.green

5.blue

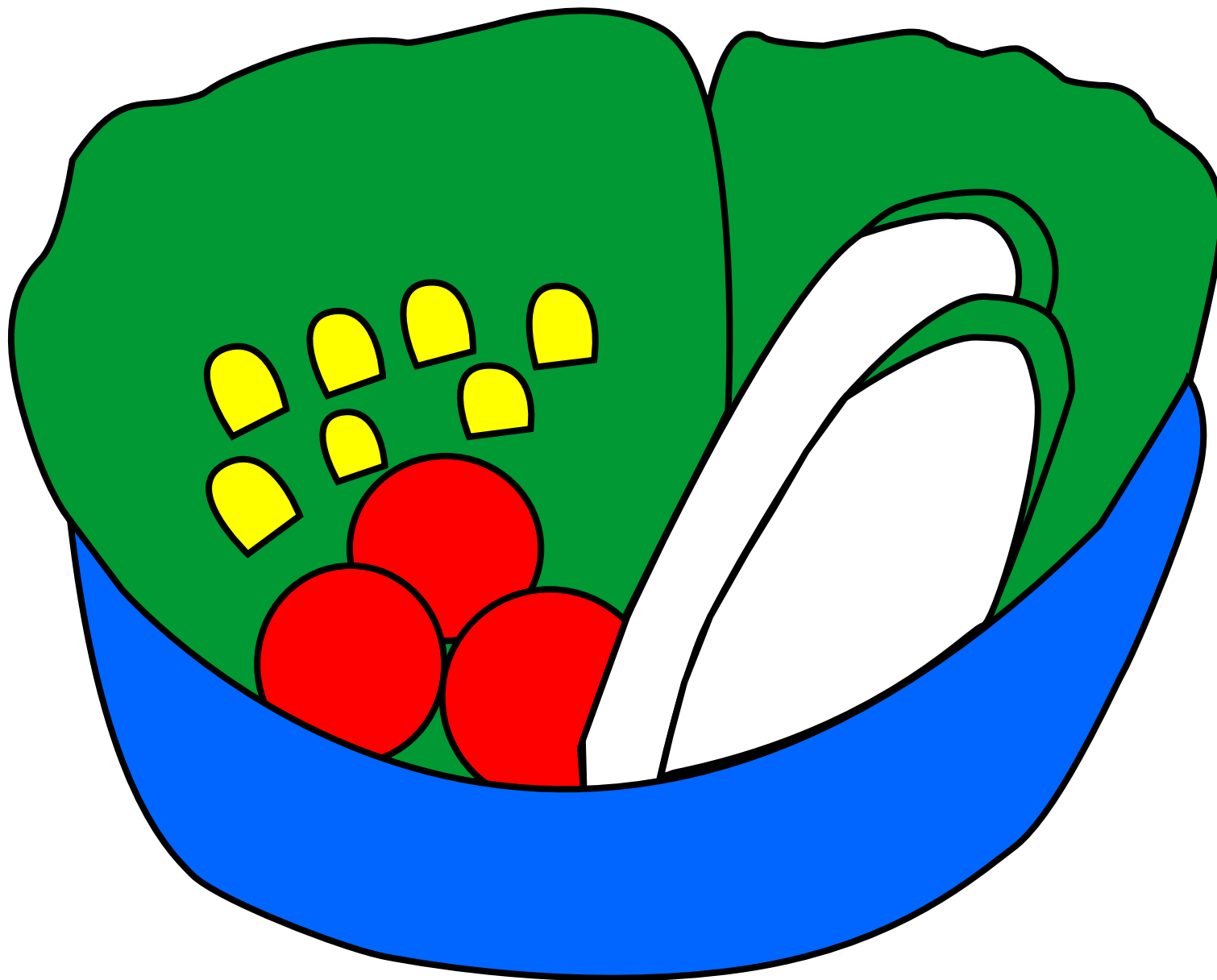

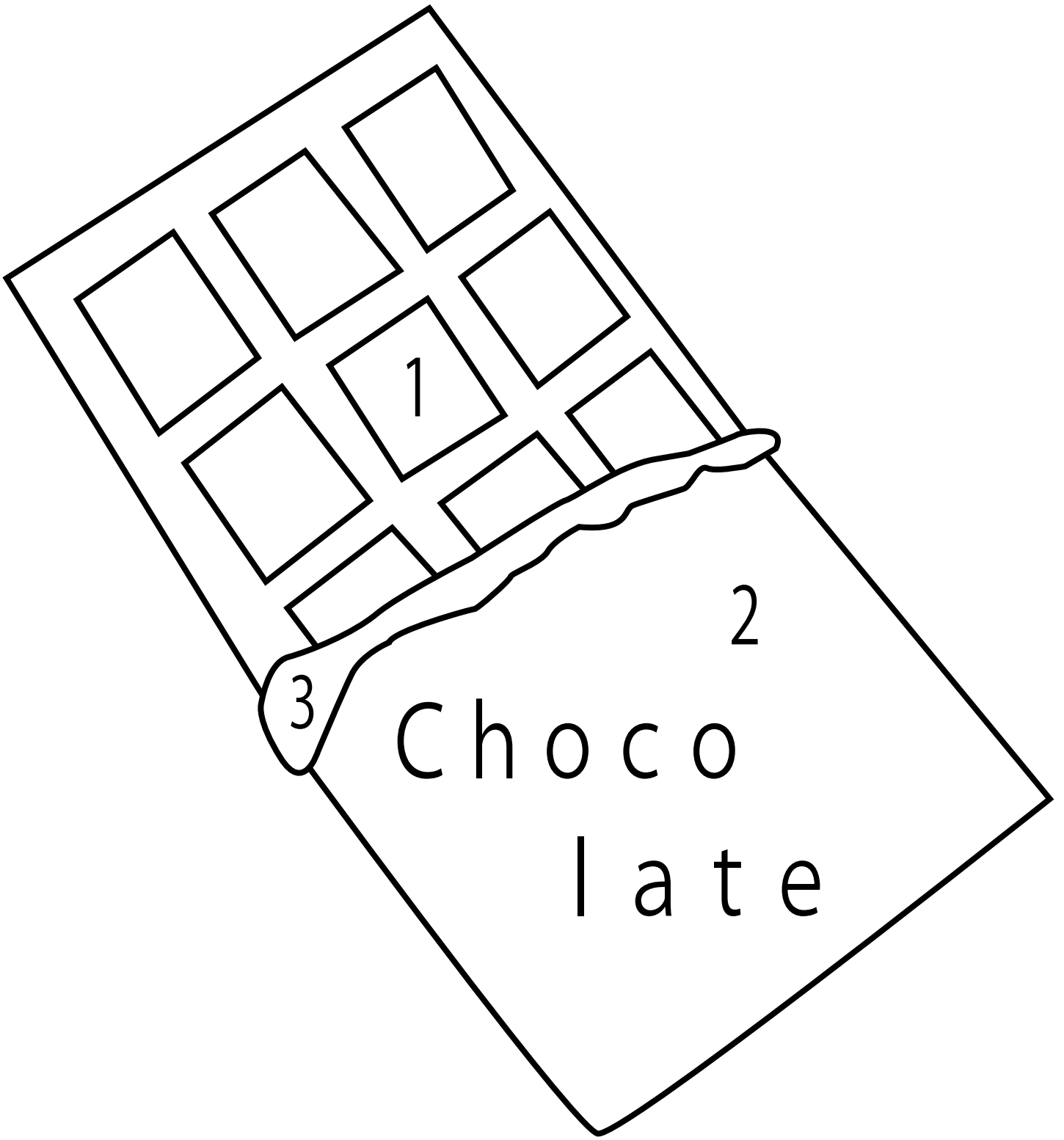

1.brown

2.red

3.gray



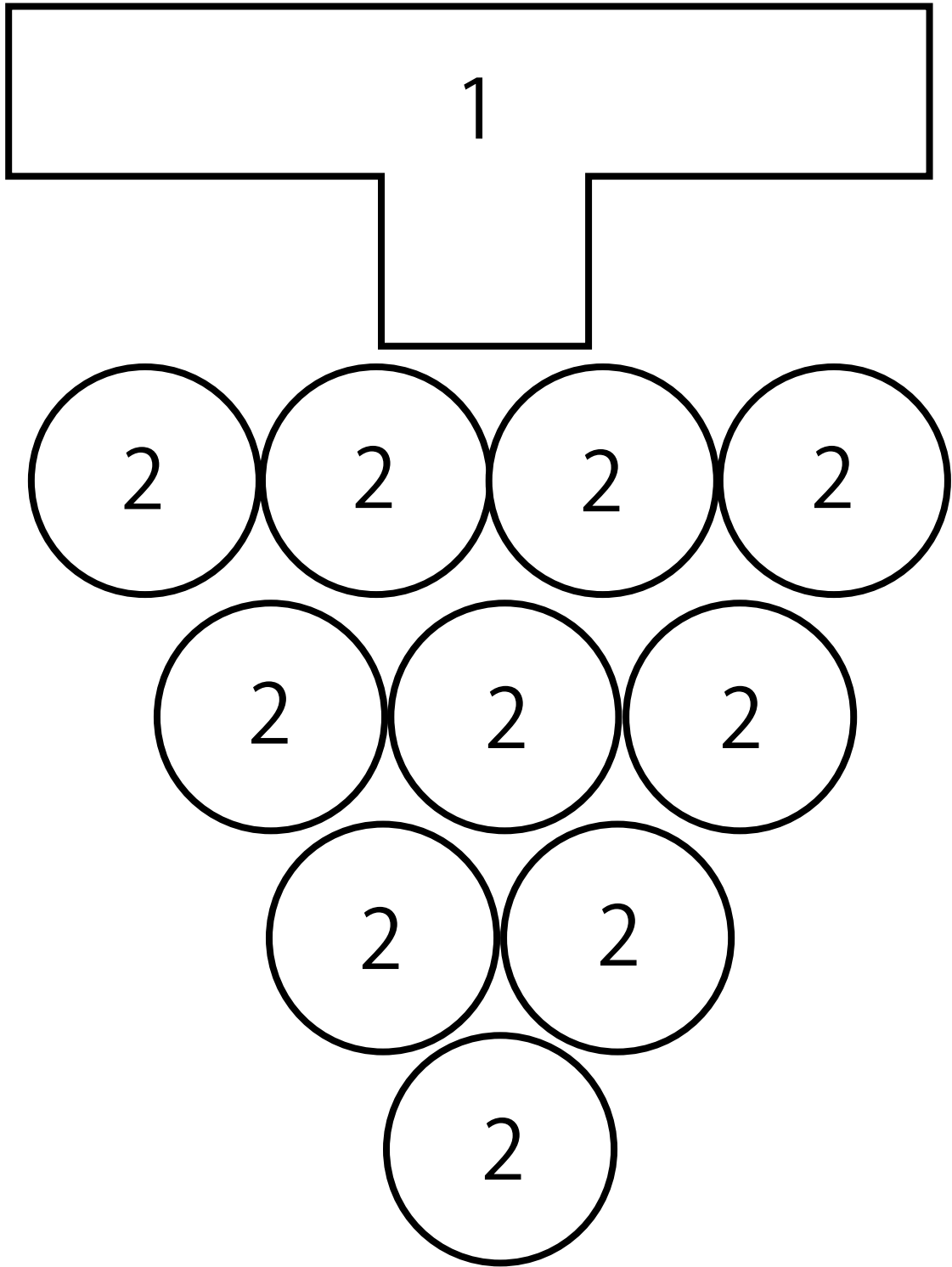

1.green

2.purple

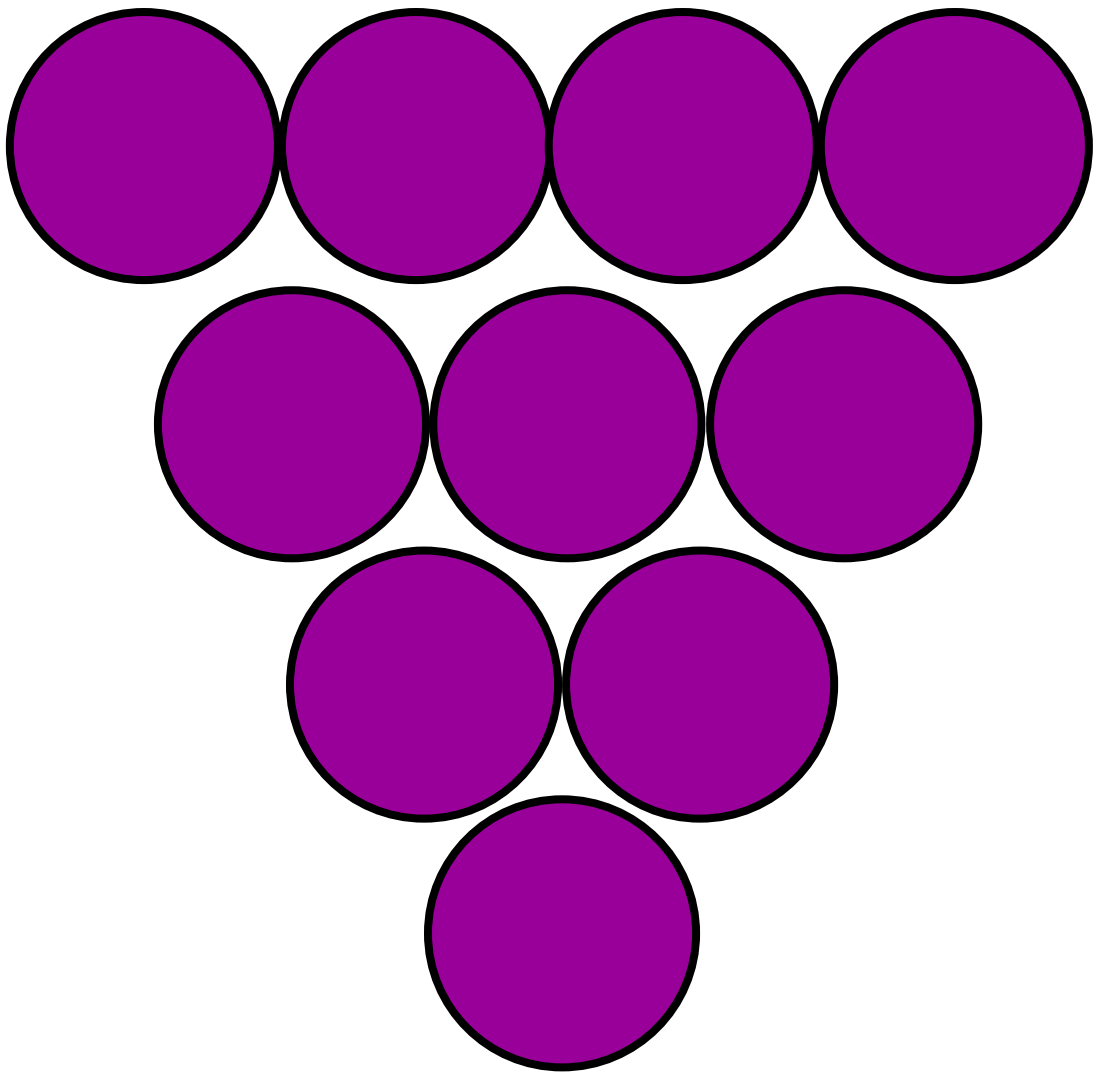
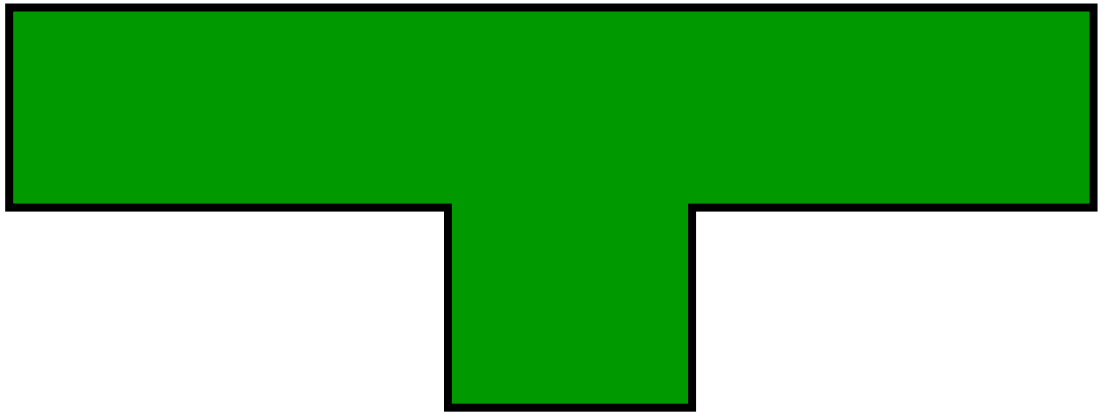

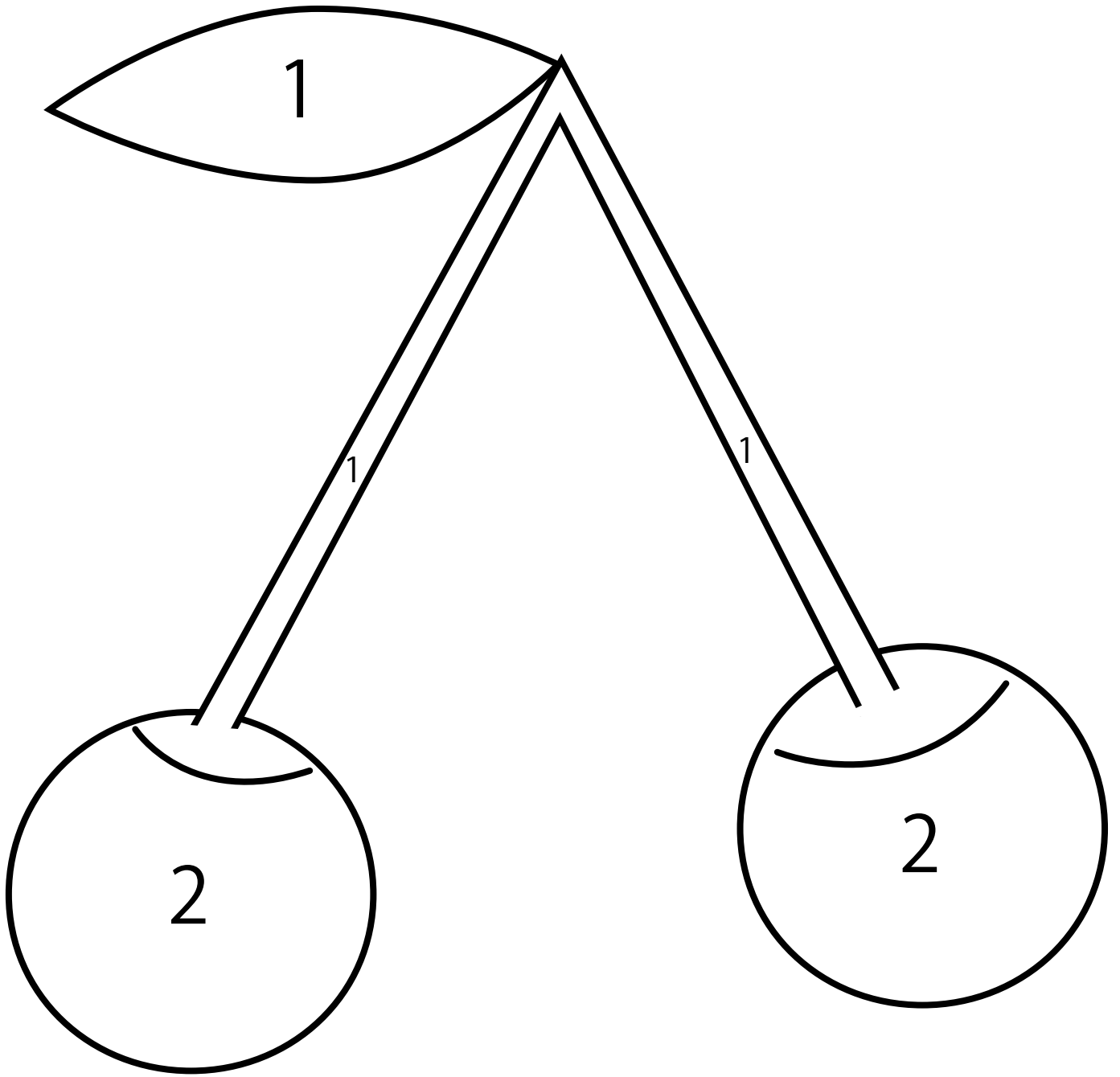

1.green

2.red

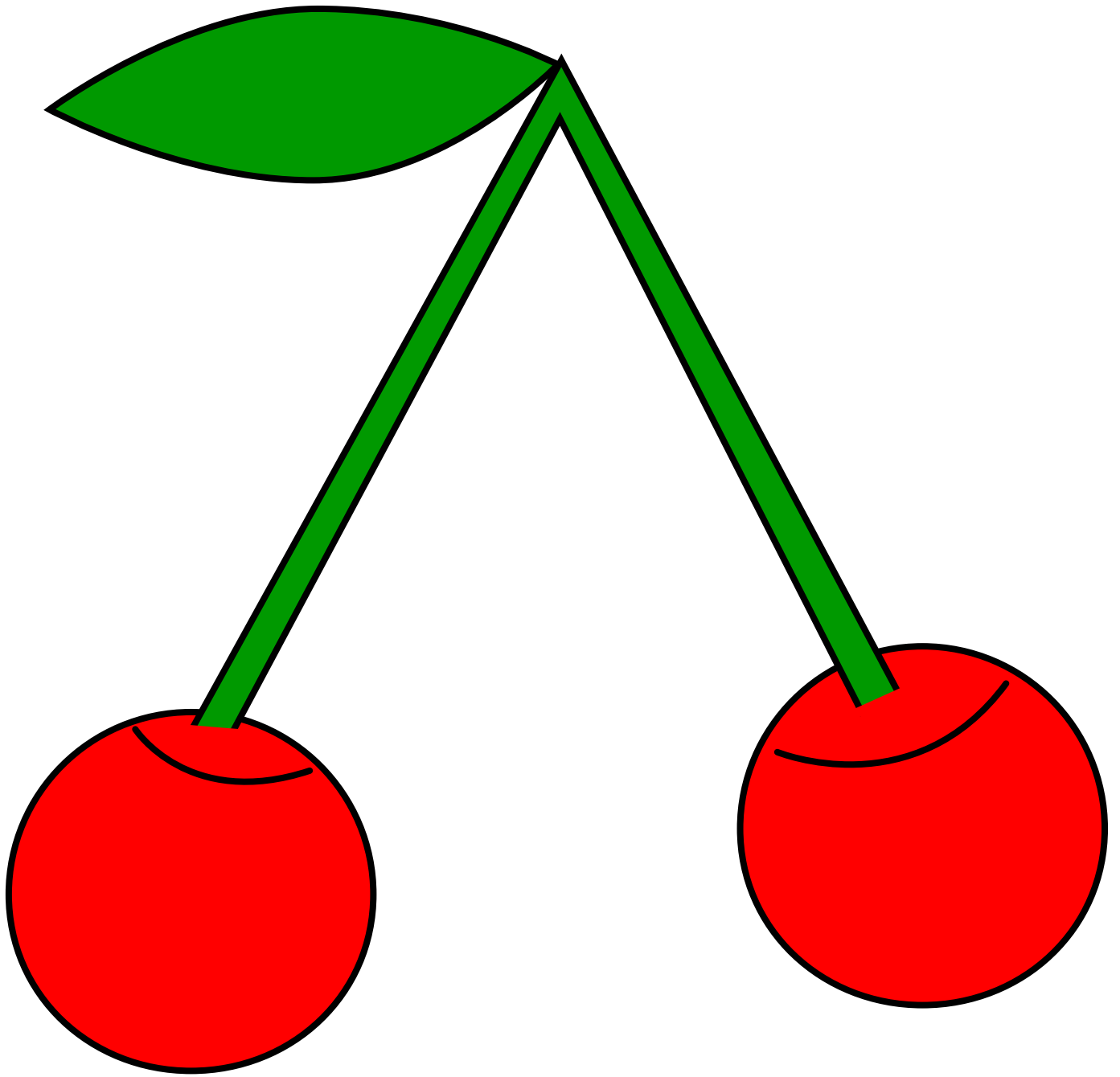

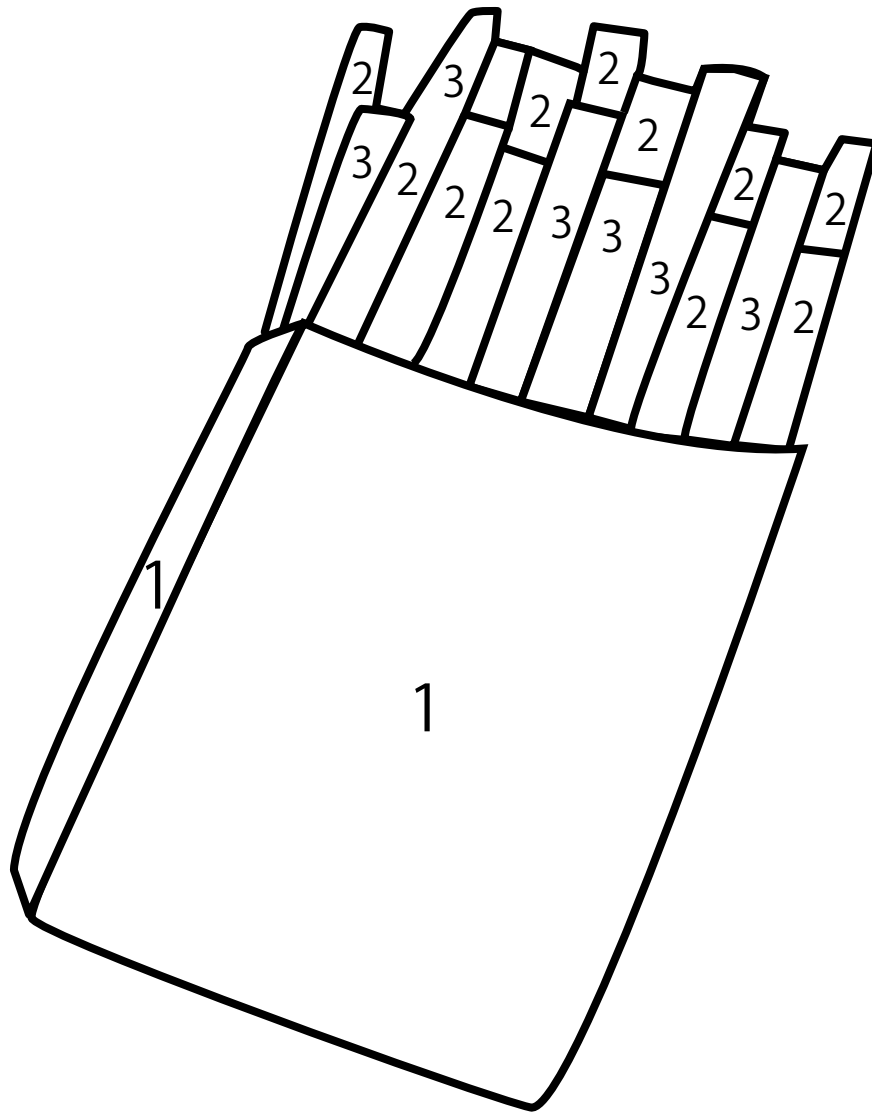

1.red

2.yellow

3.orange

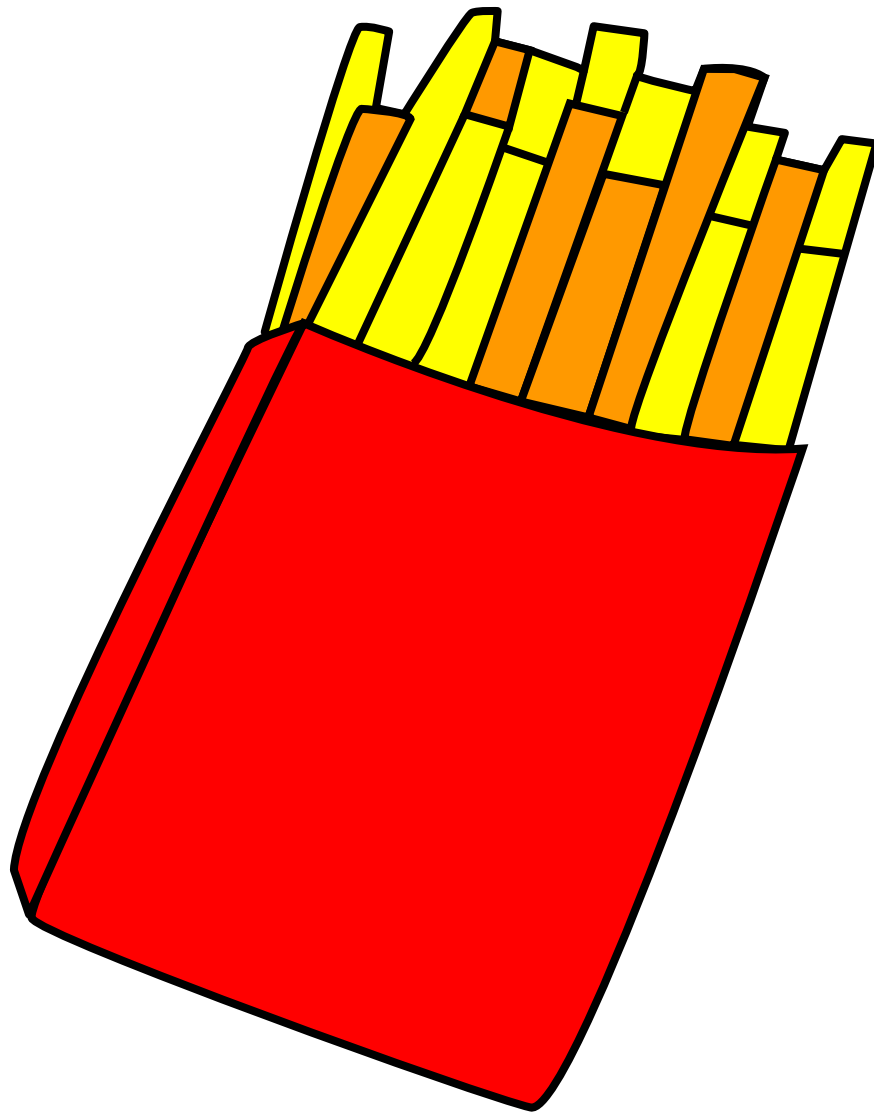

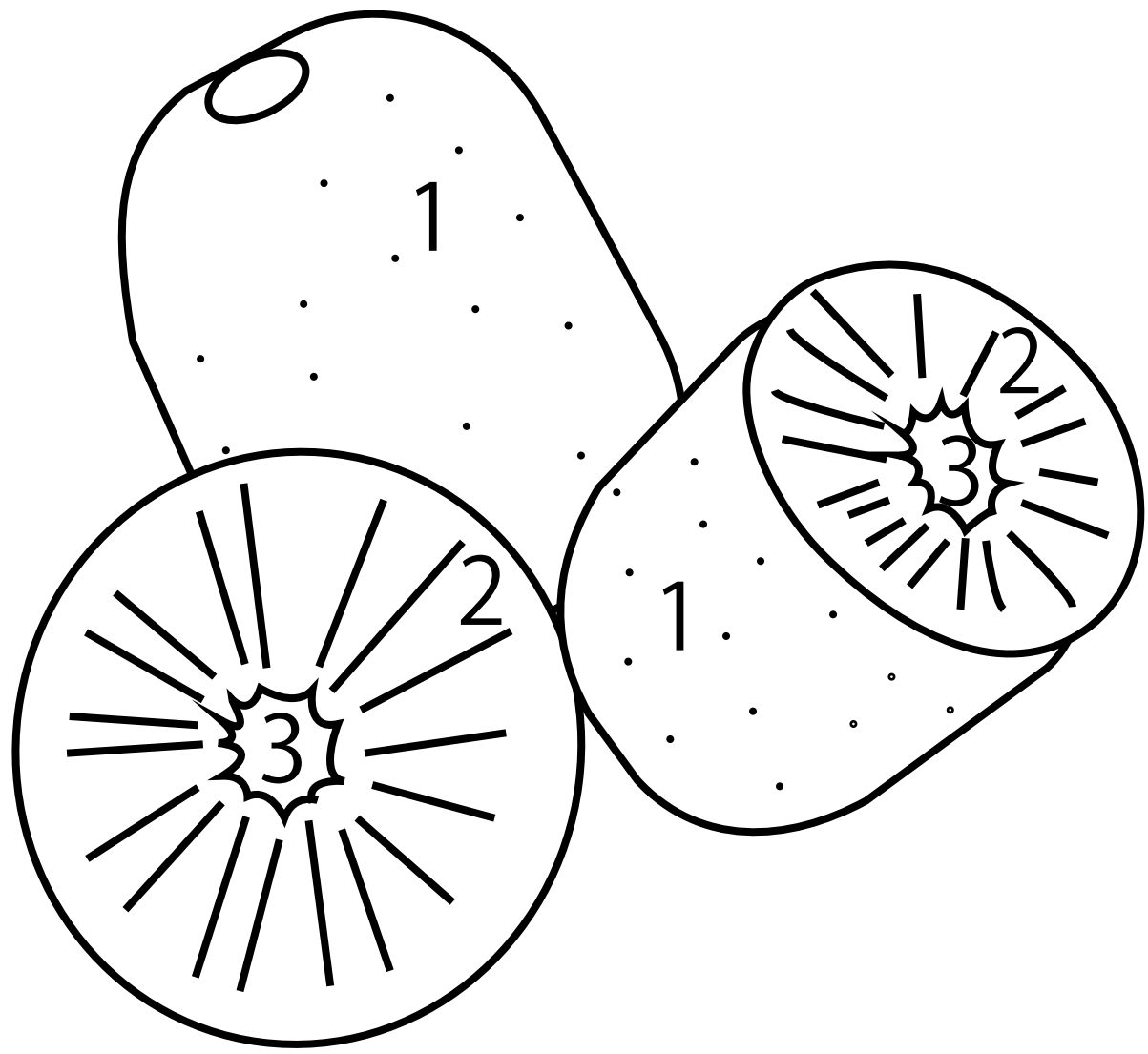

1.brown

2.green

3.yellow

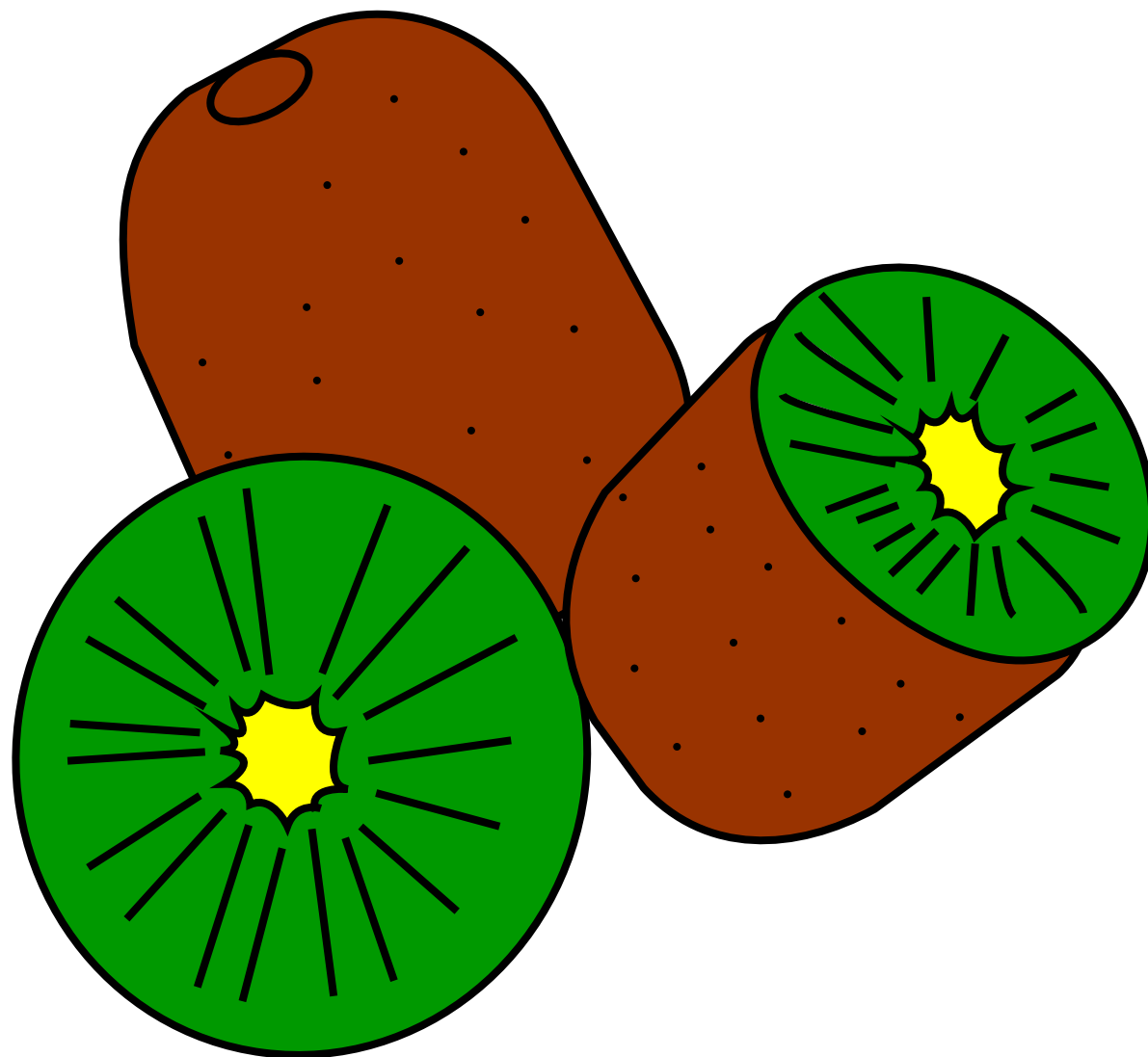

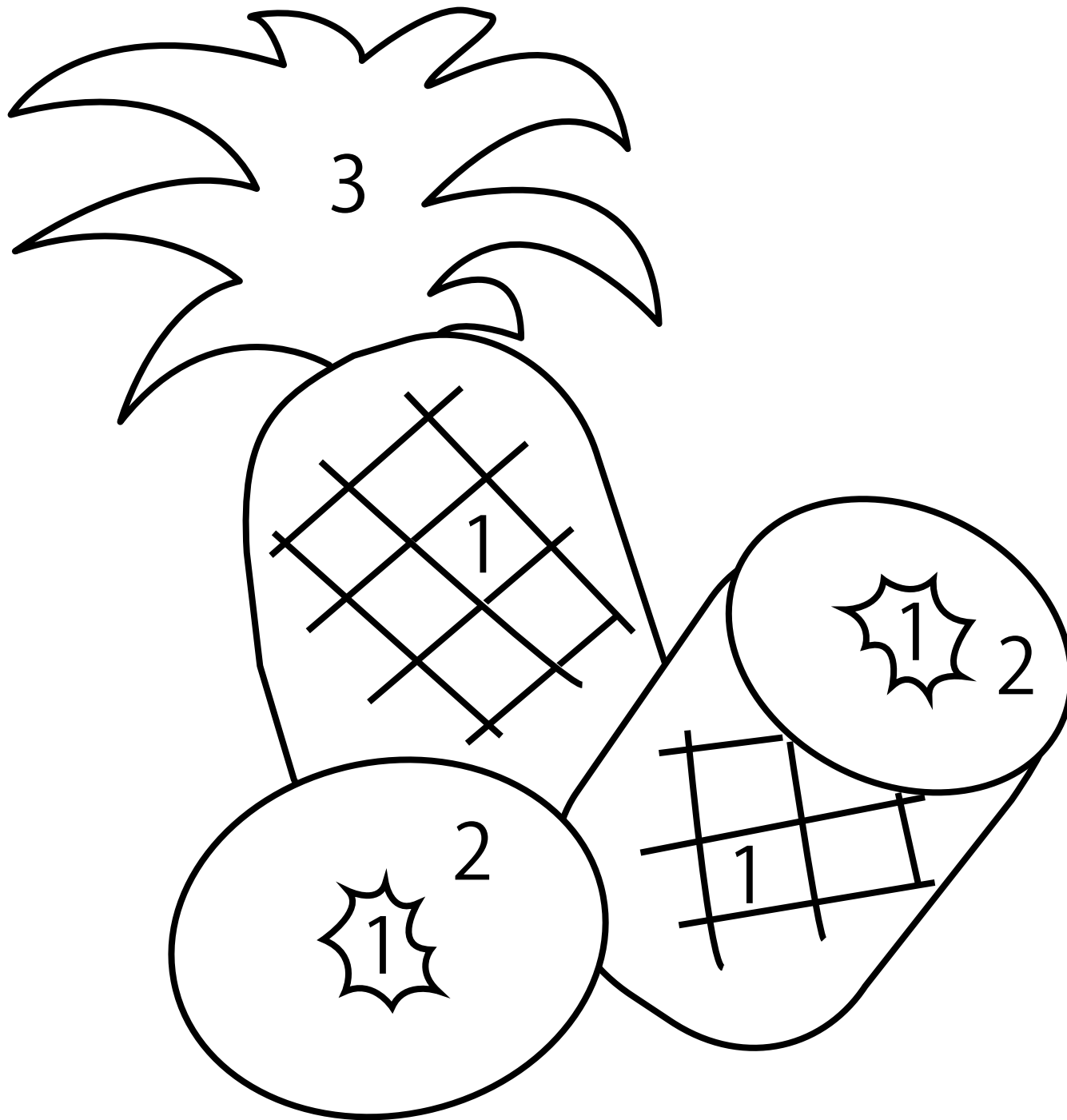

1.orange

2.yellow

3.green

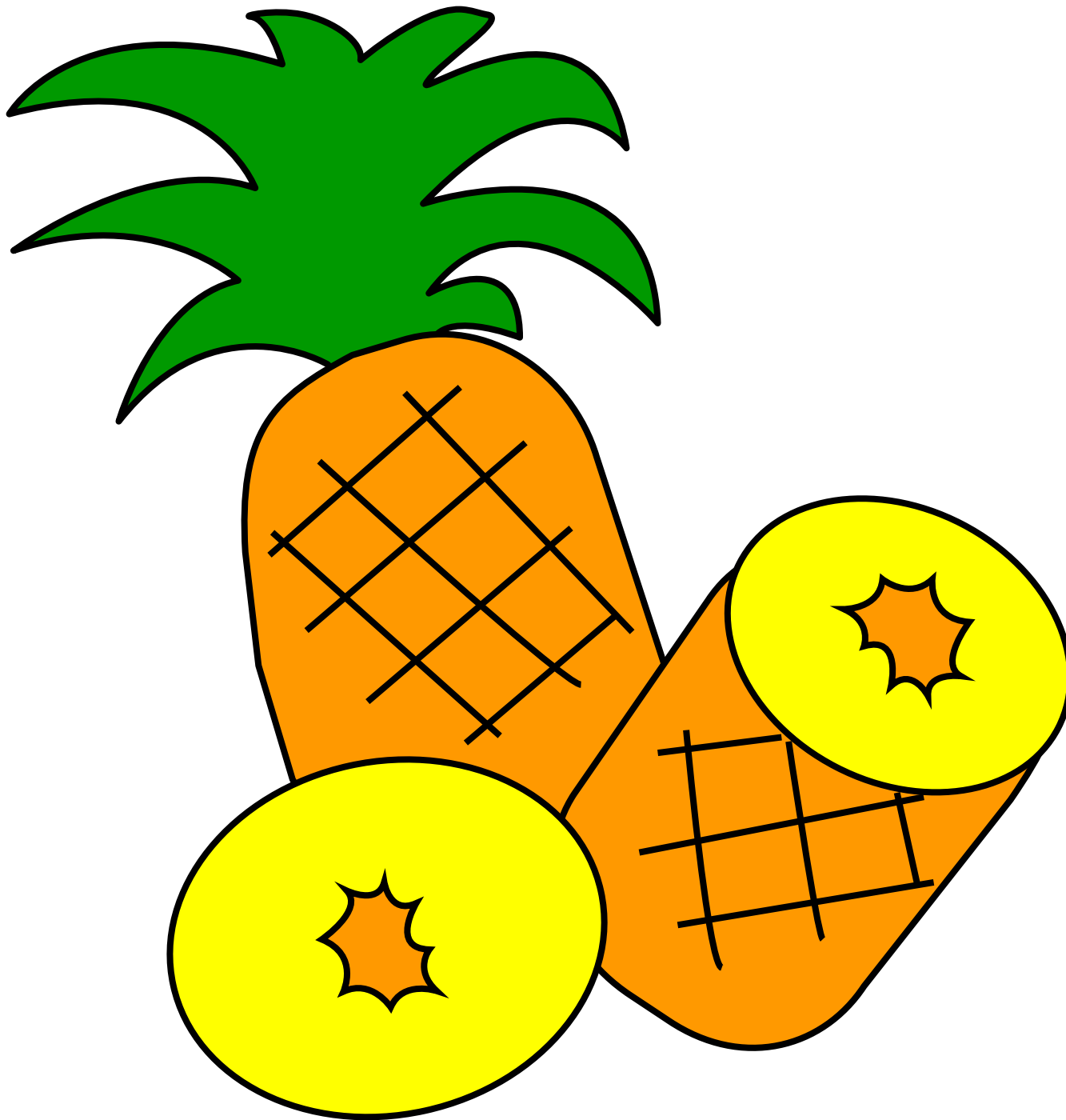

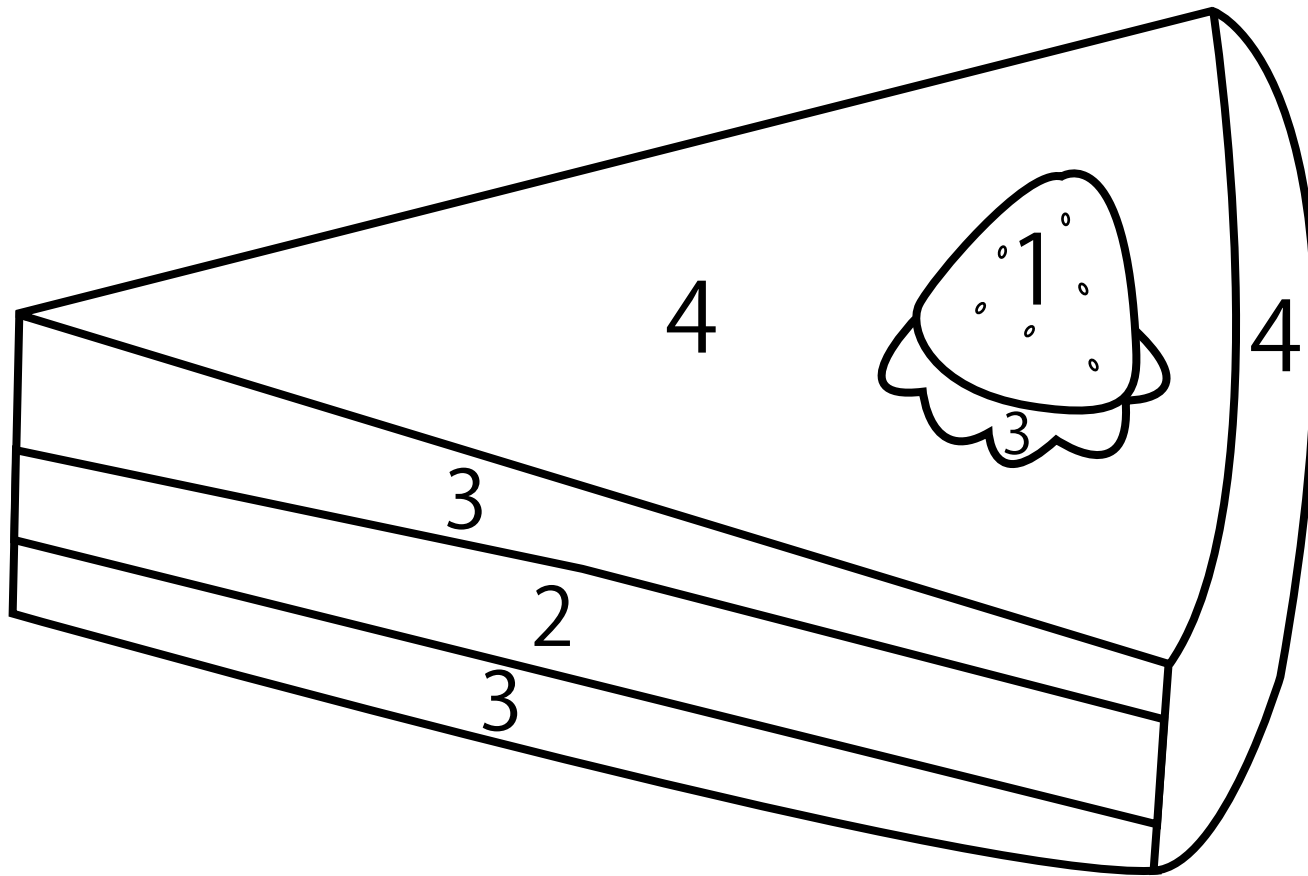

1.red

2.pink

3.white

4.brown

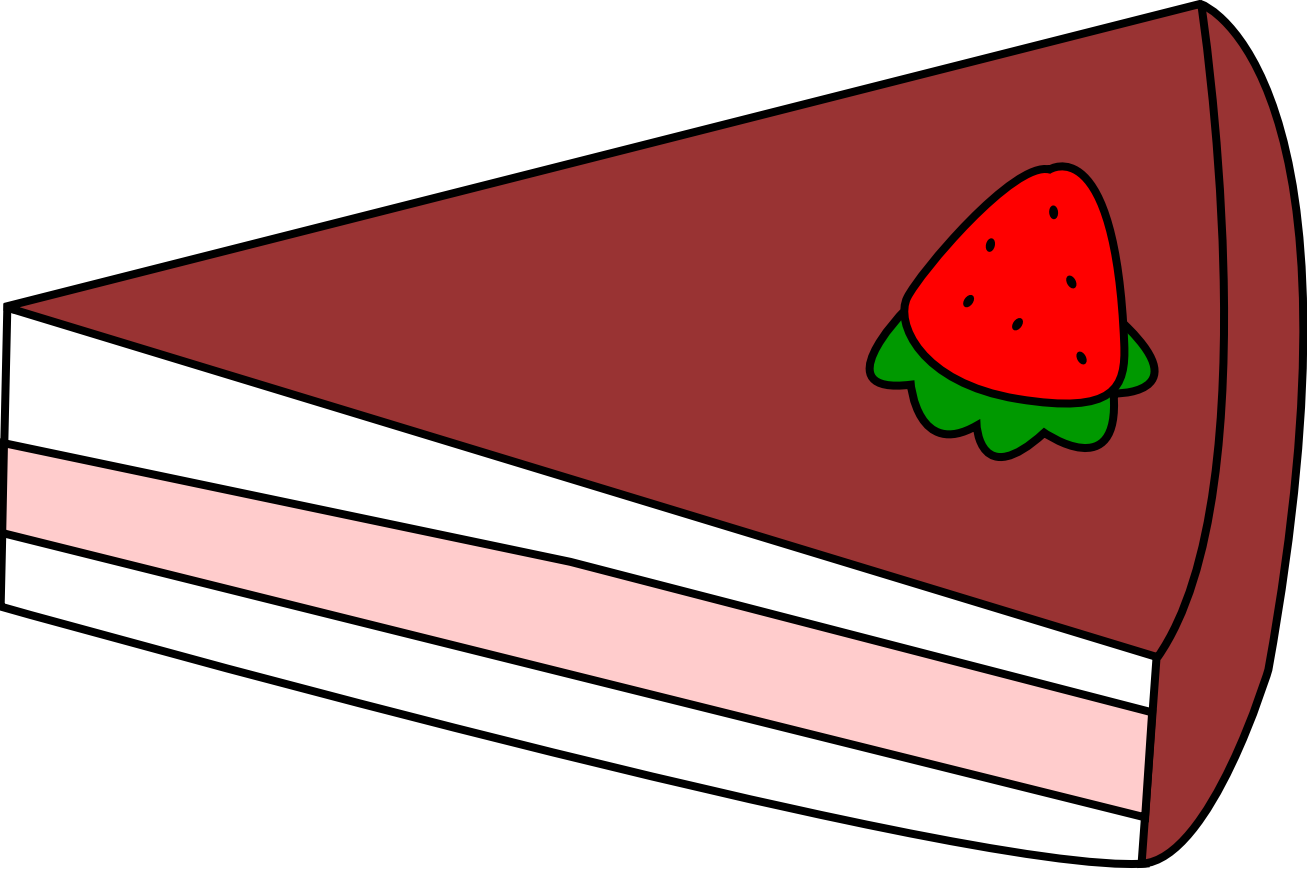

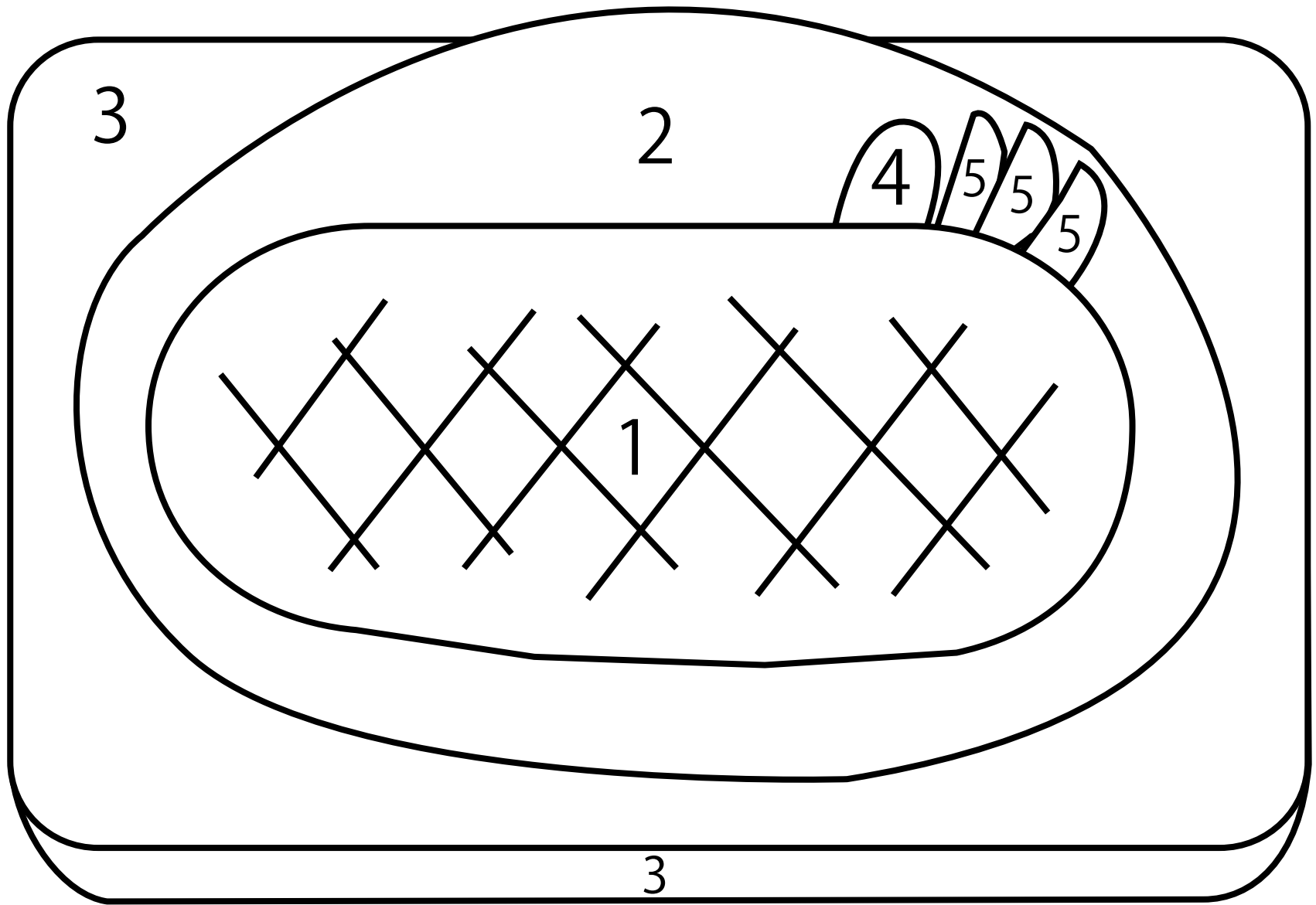

1.brown

2.black

3.green

4.orange

5.yellow

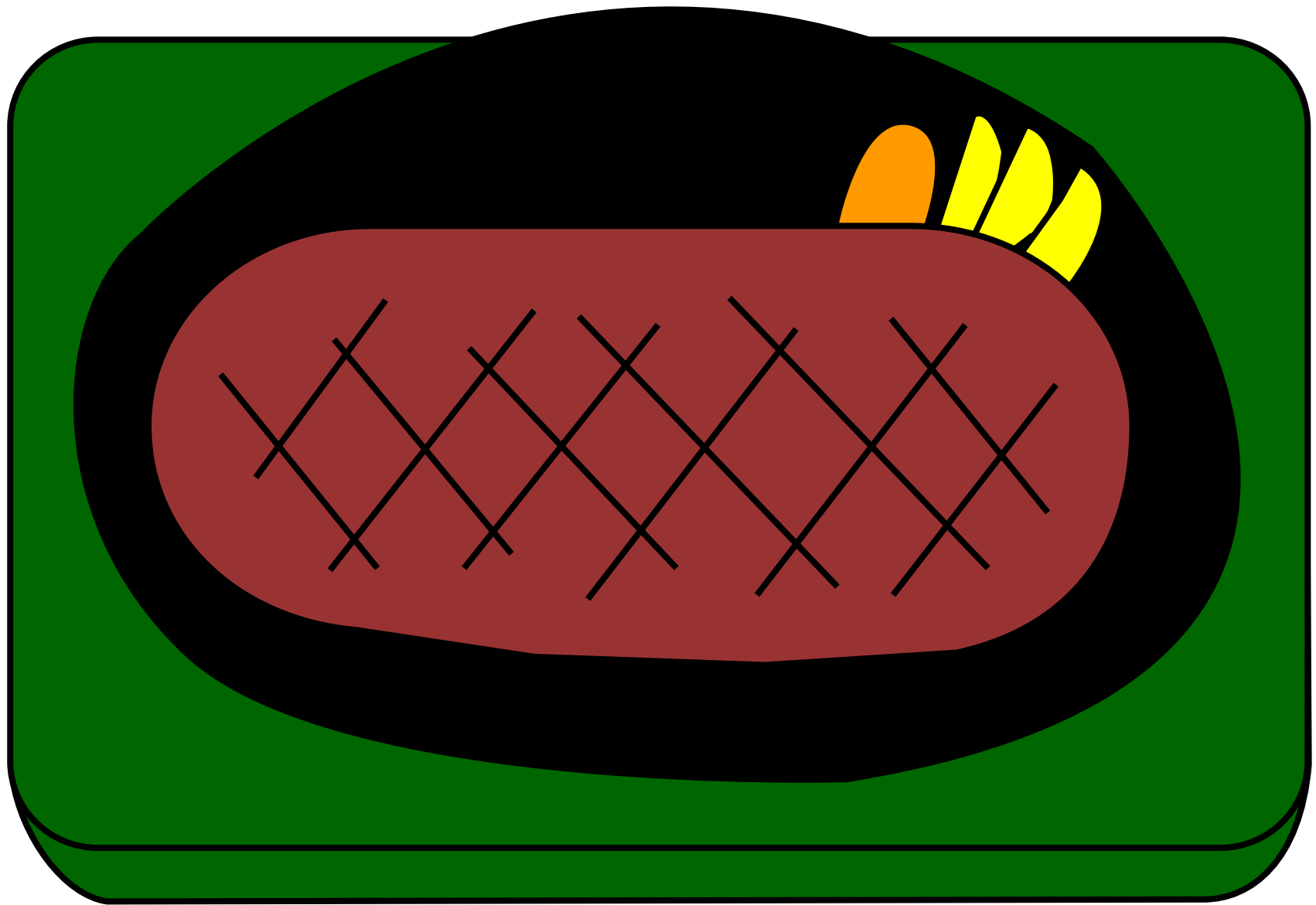

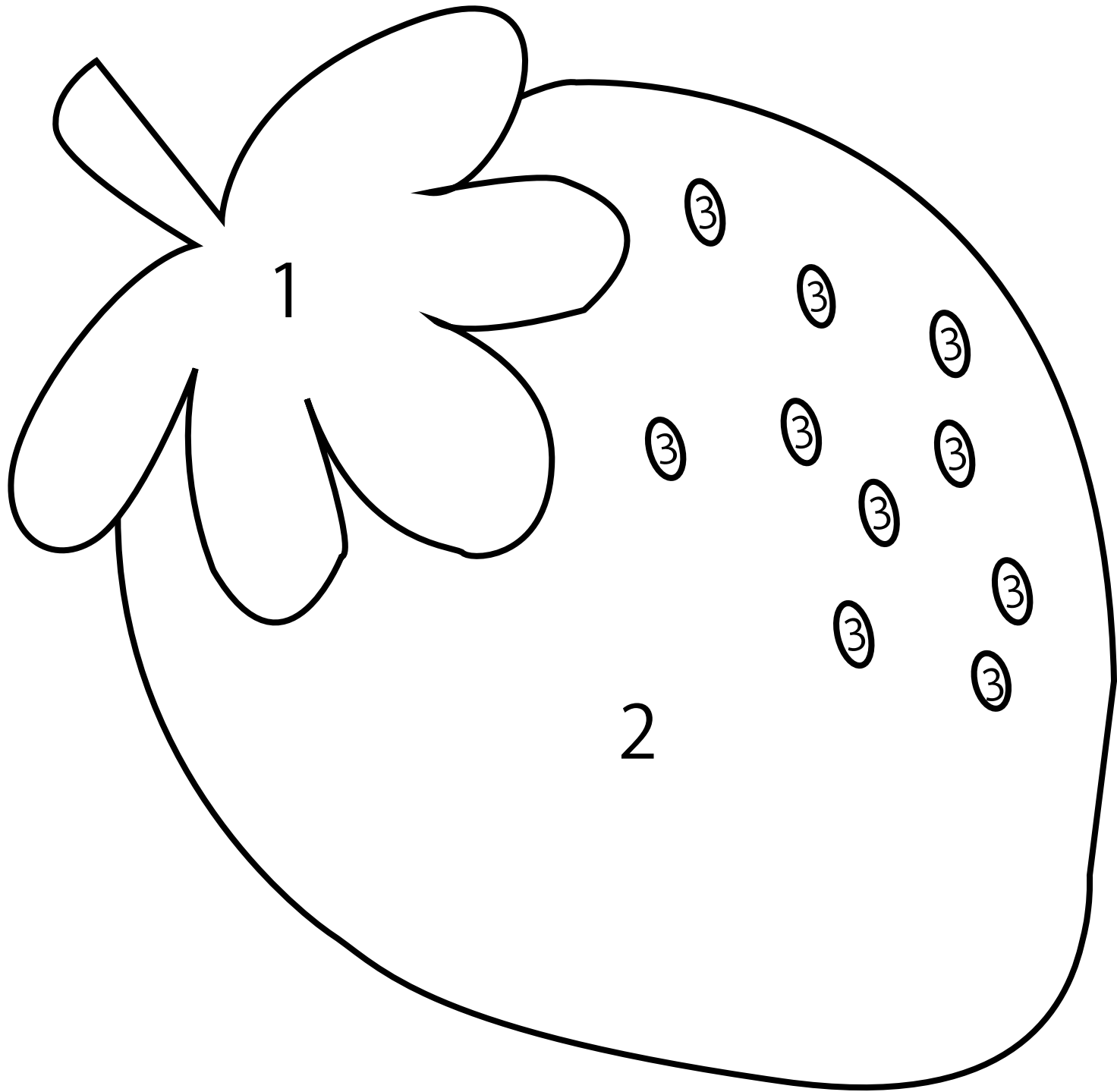

1.green

2.red

3.black

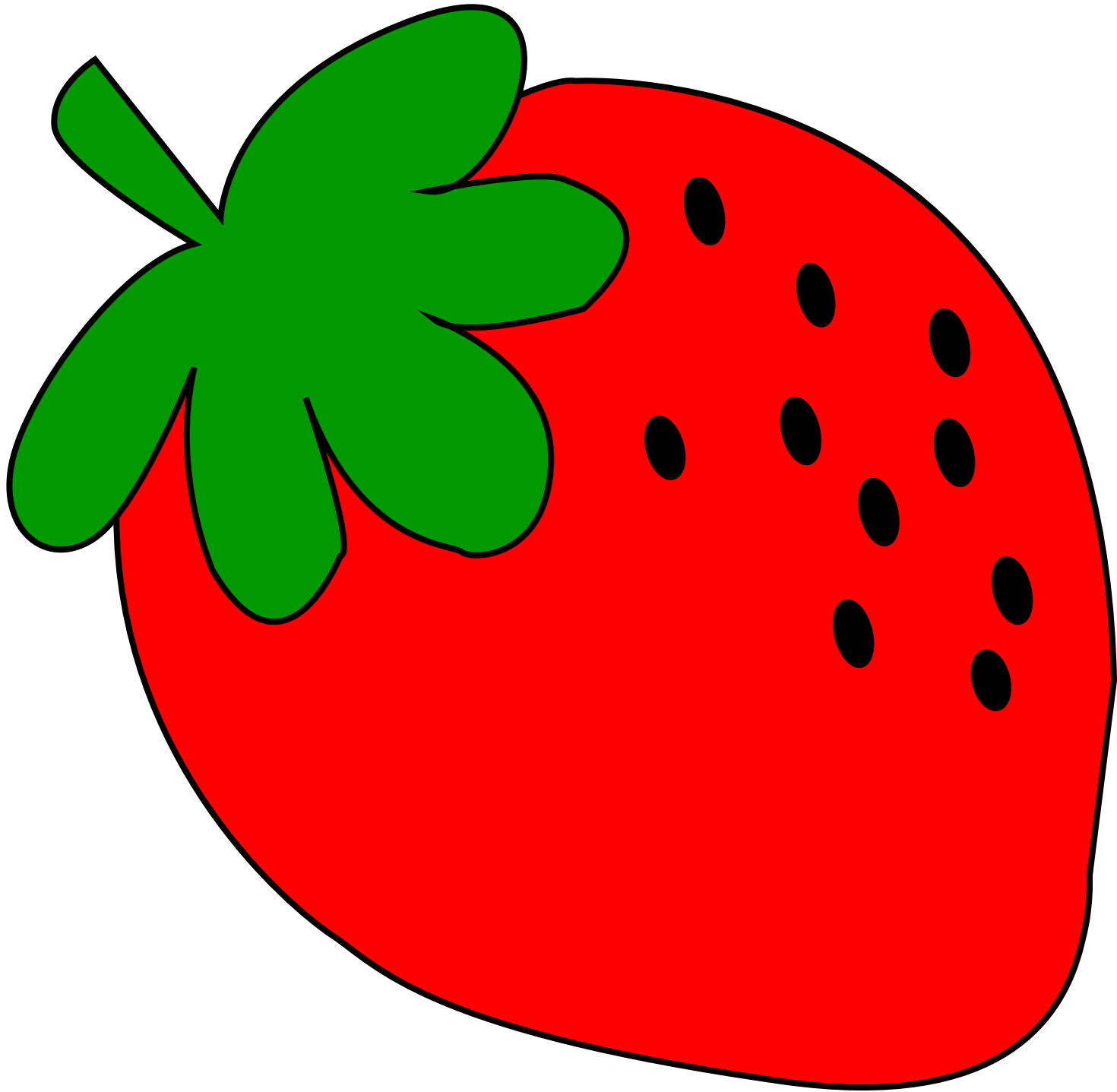

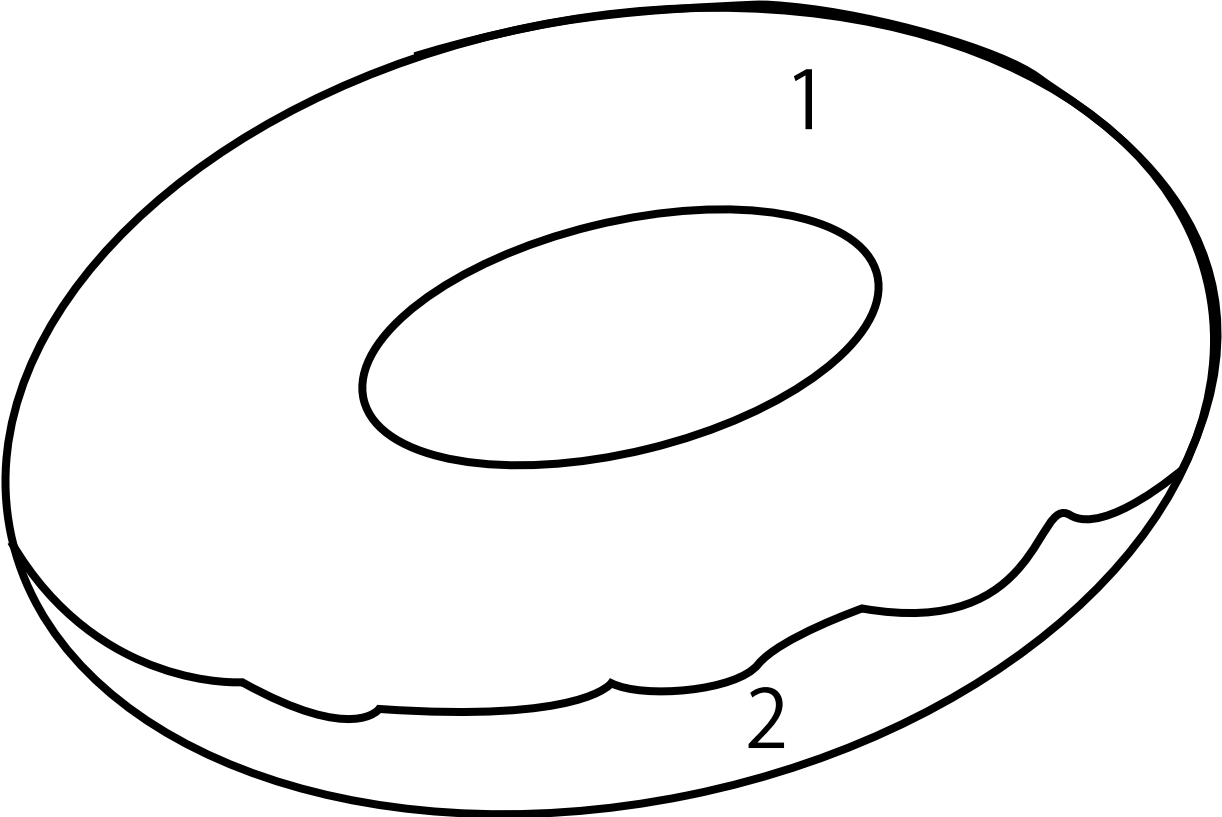

1.brown

2.yellow

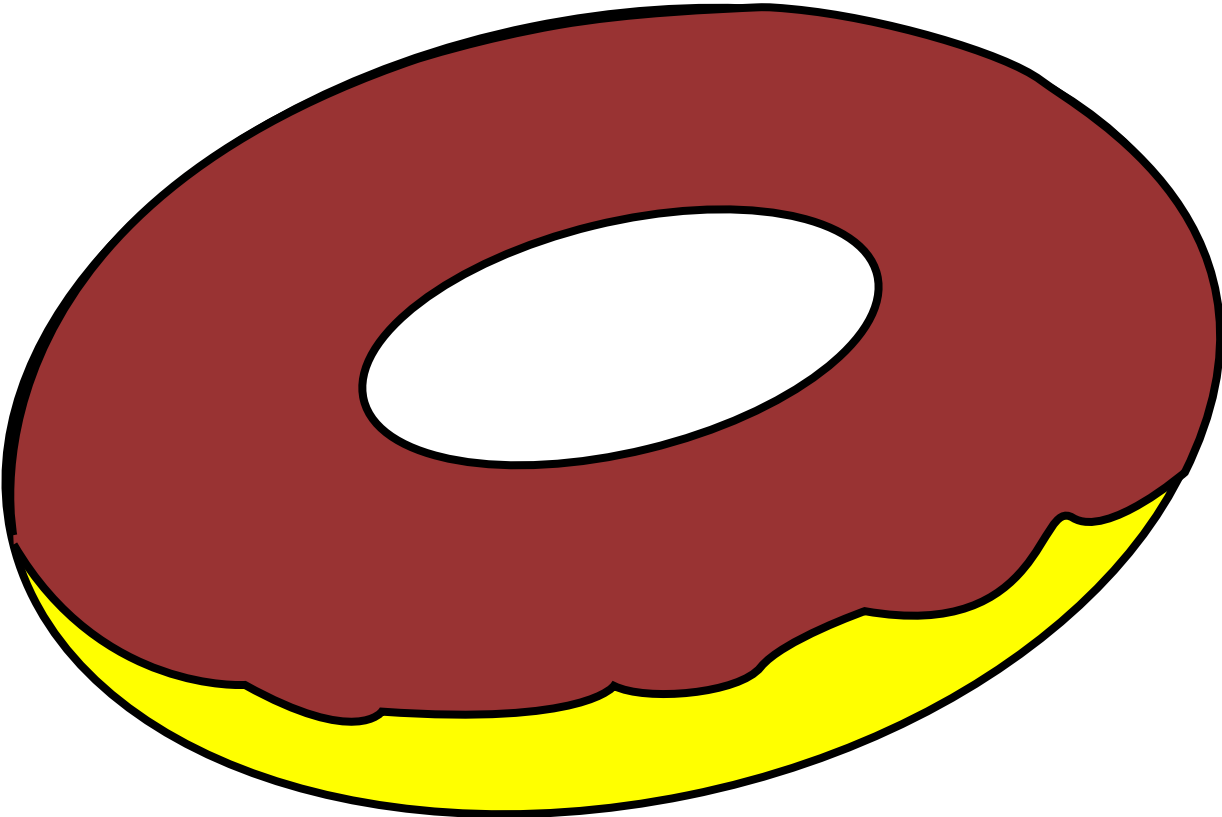

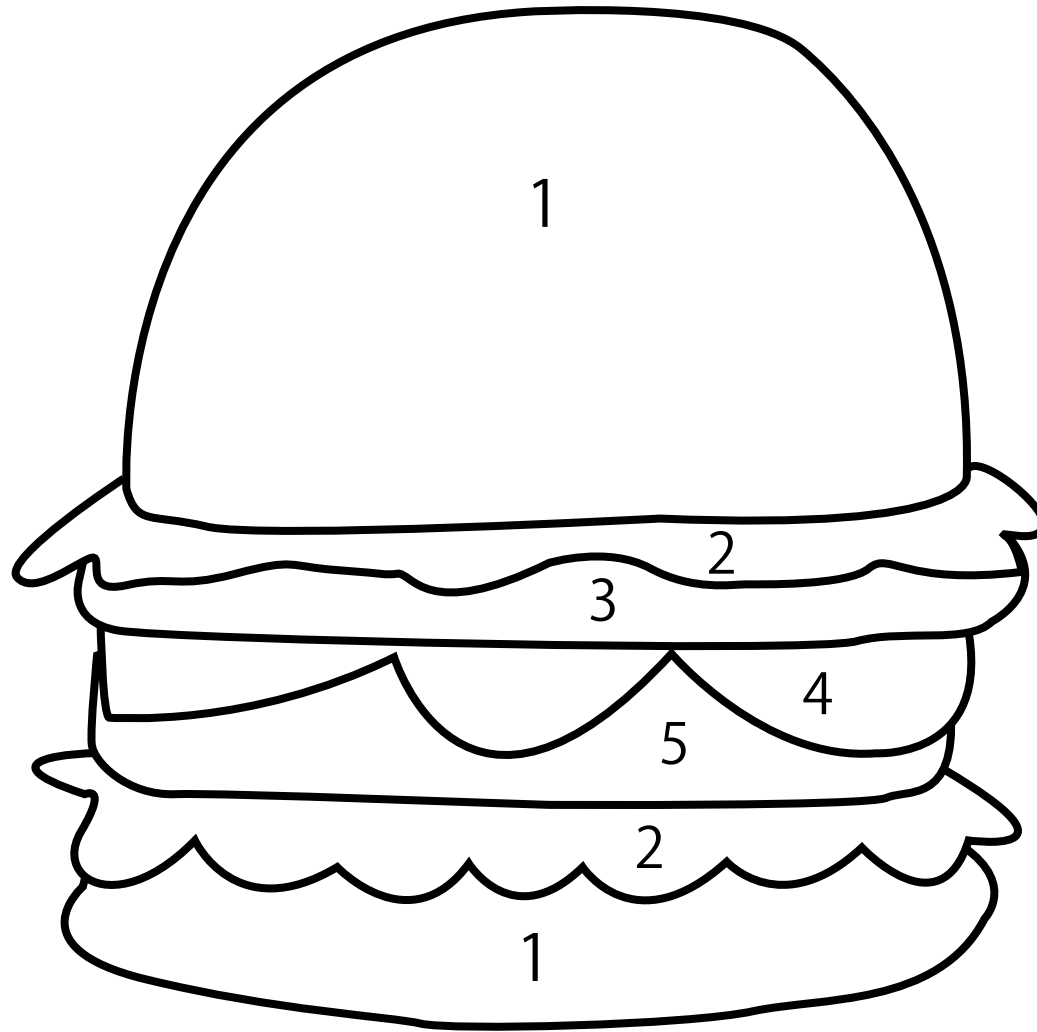

1.brown

2.green

3.red

4.yellow

5.orange

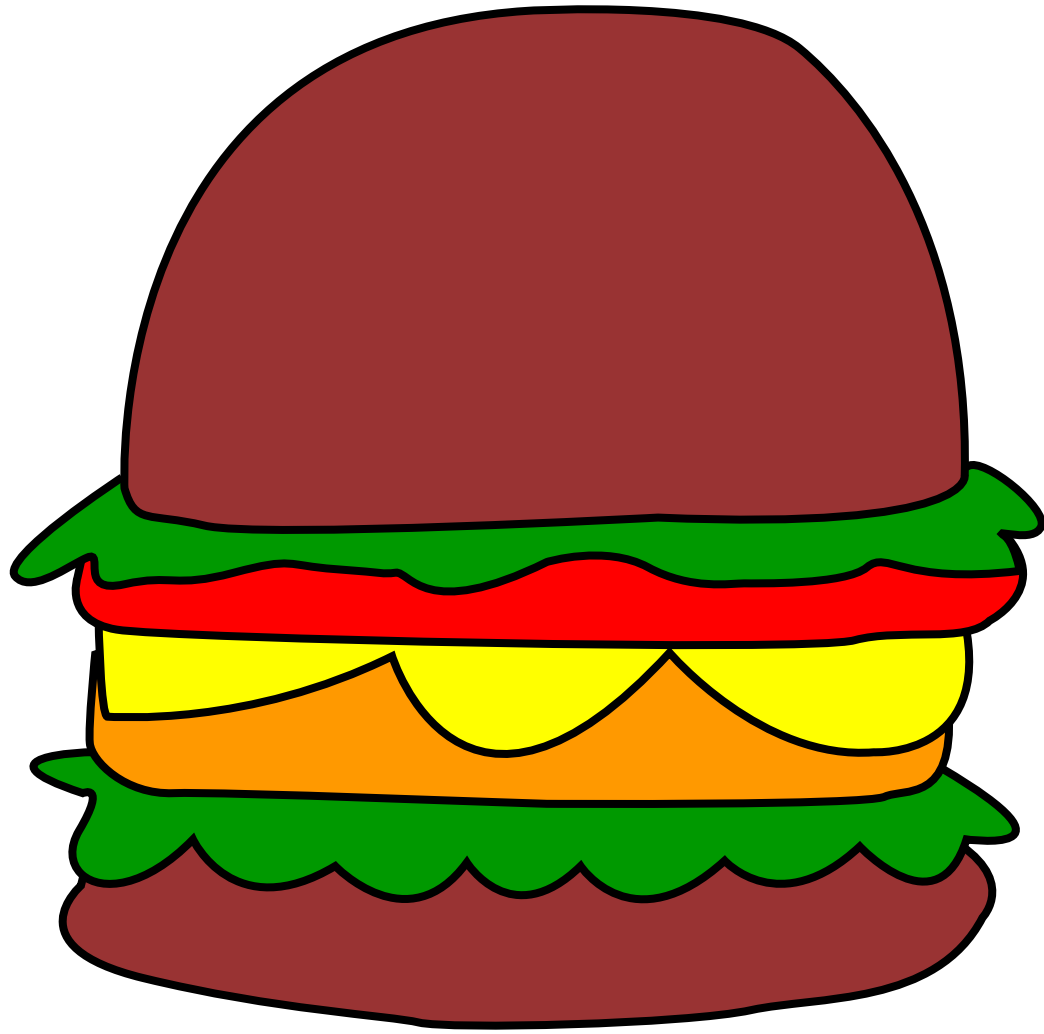

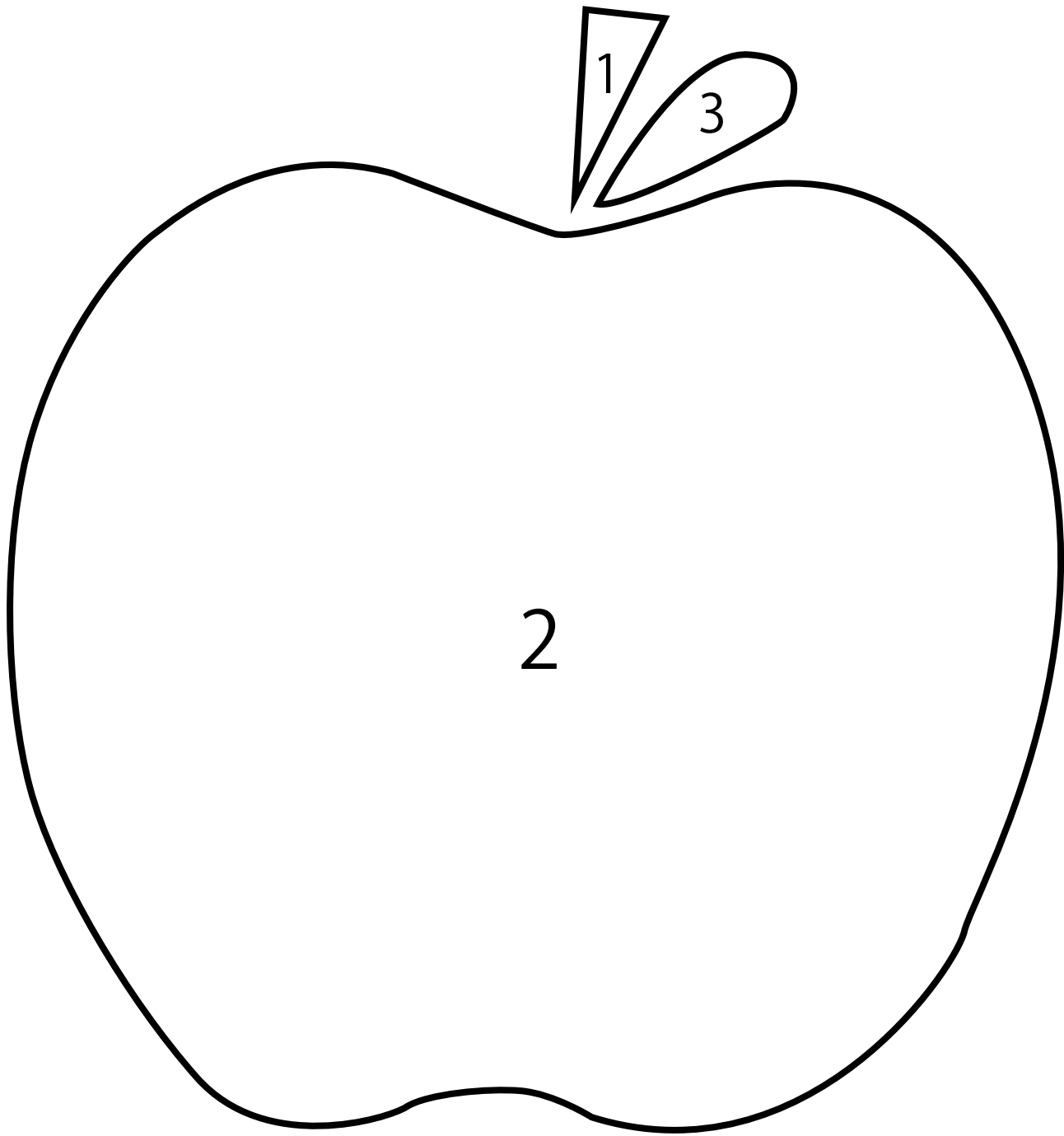

1.brown

2.red

3.green

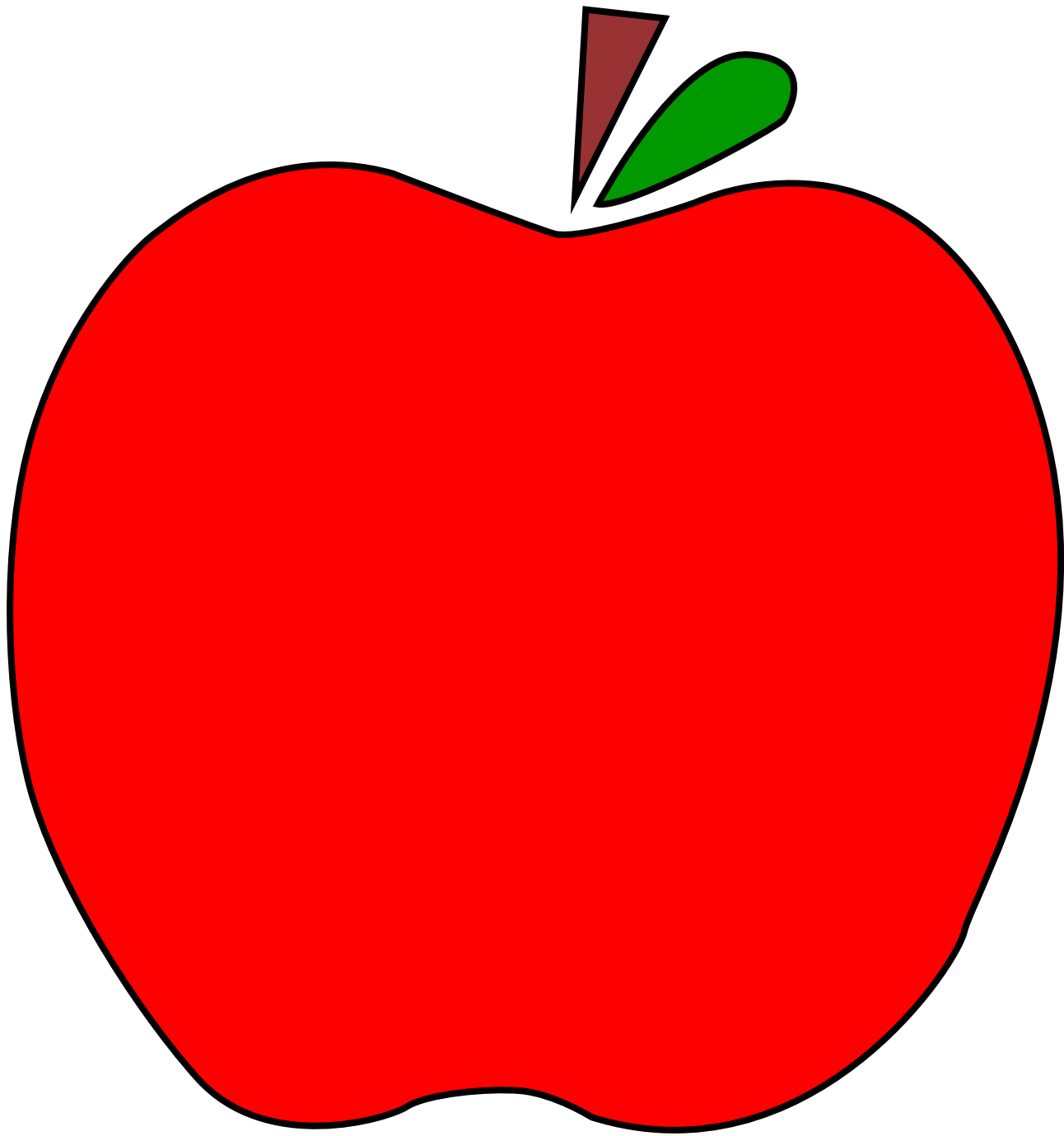

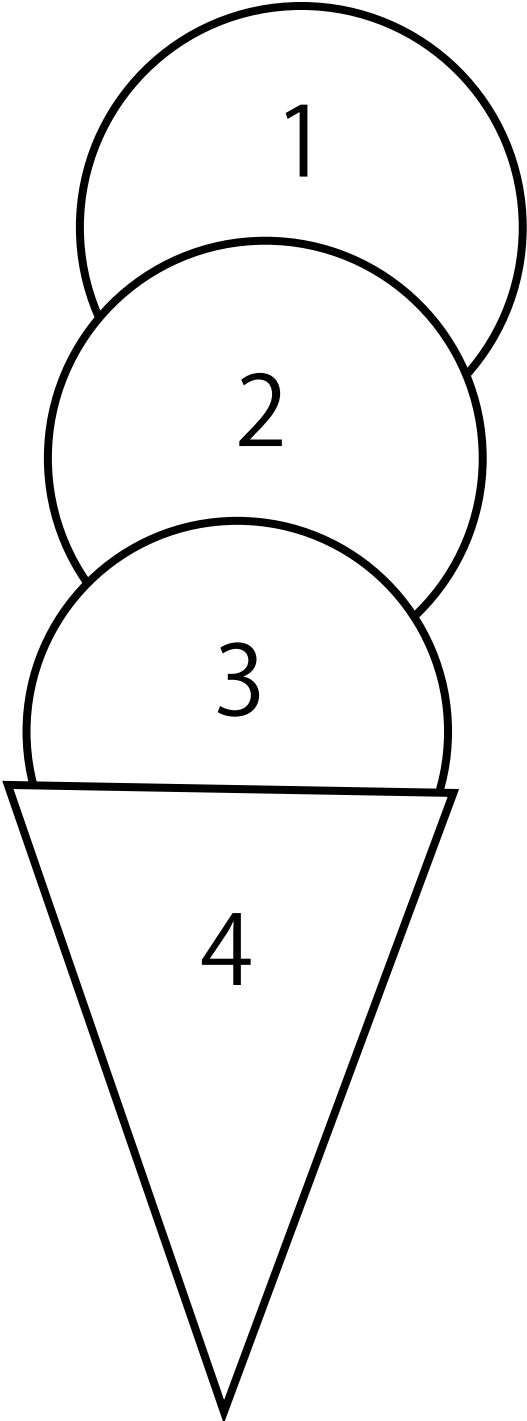

1.pink

2.orange

3.blue

4.brown

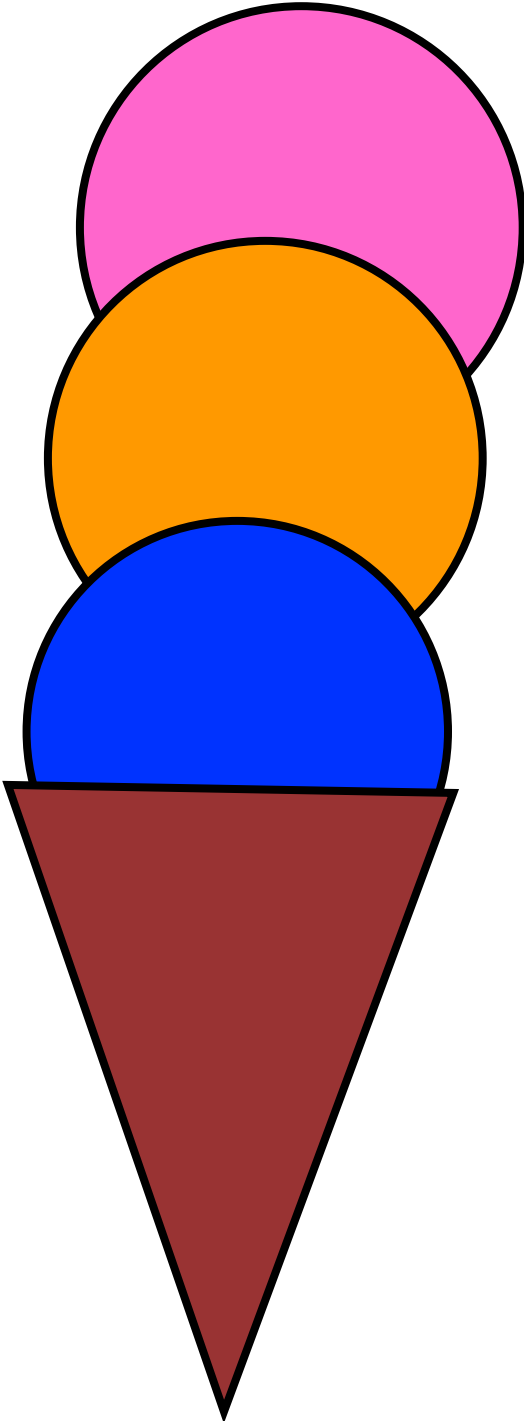

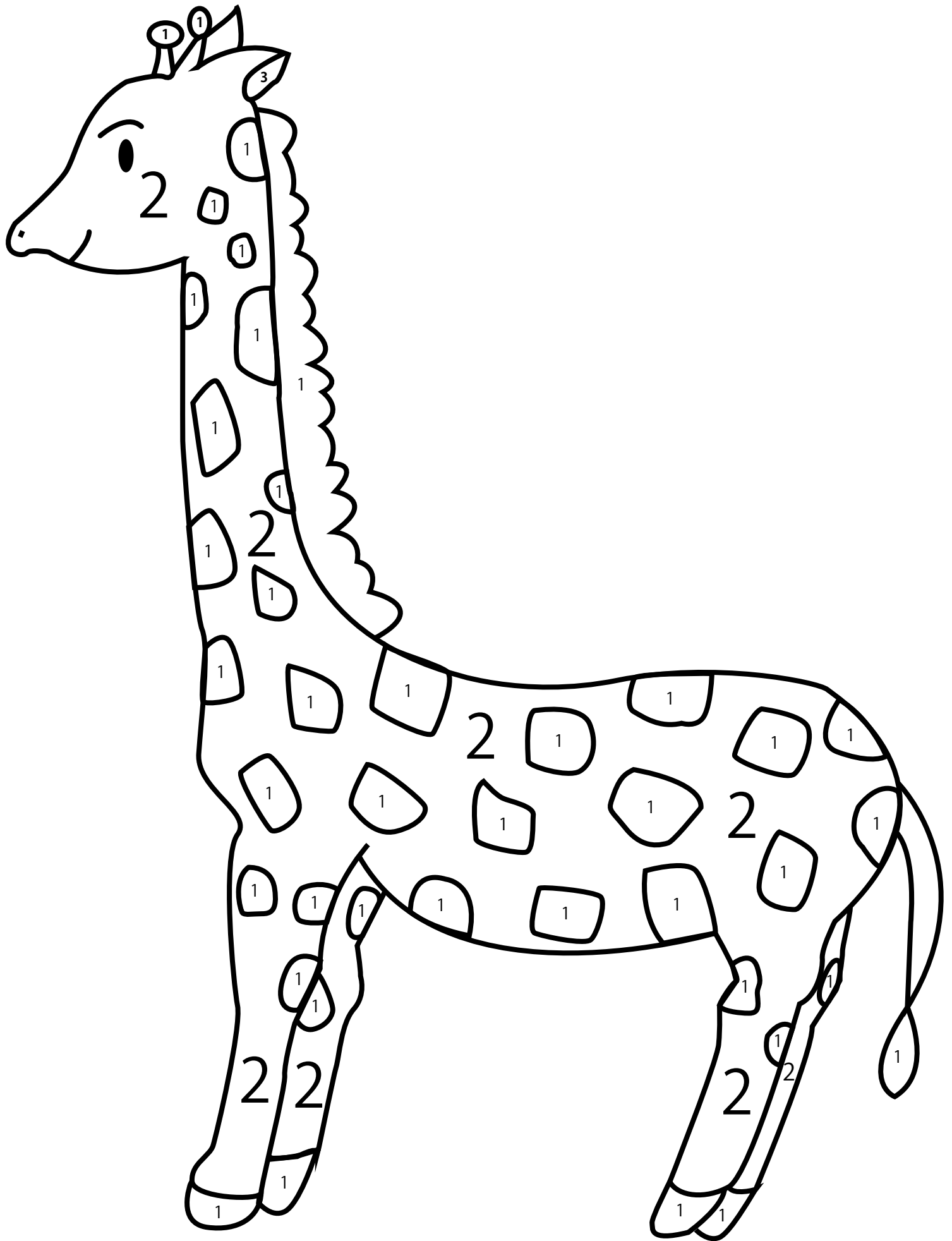

1.brown

2.yellow

3.pink

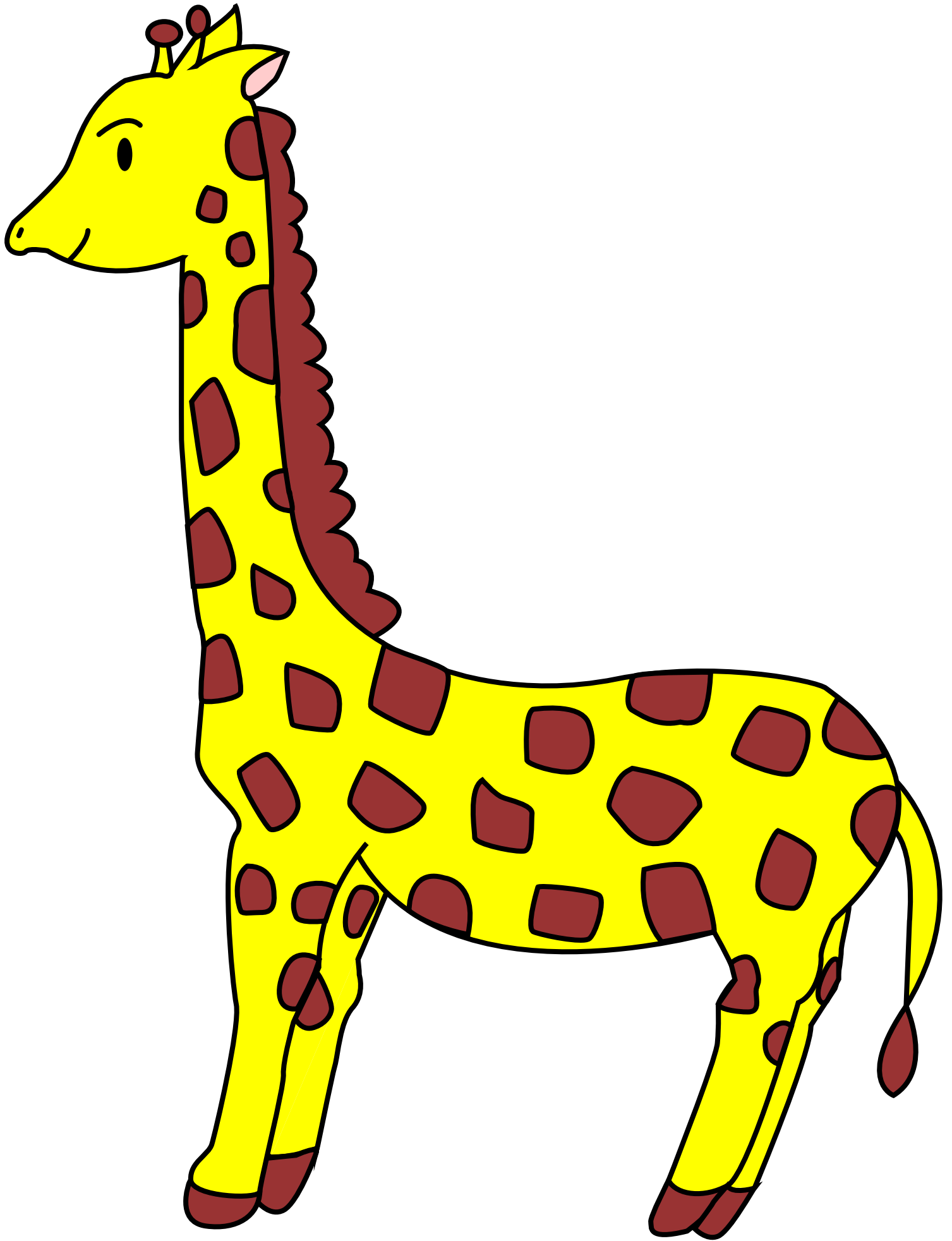

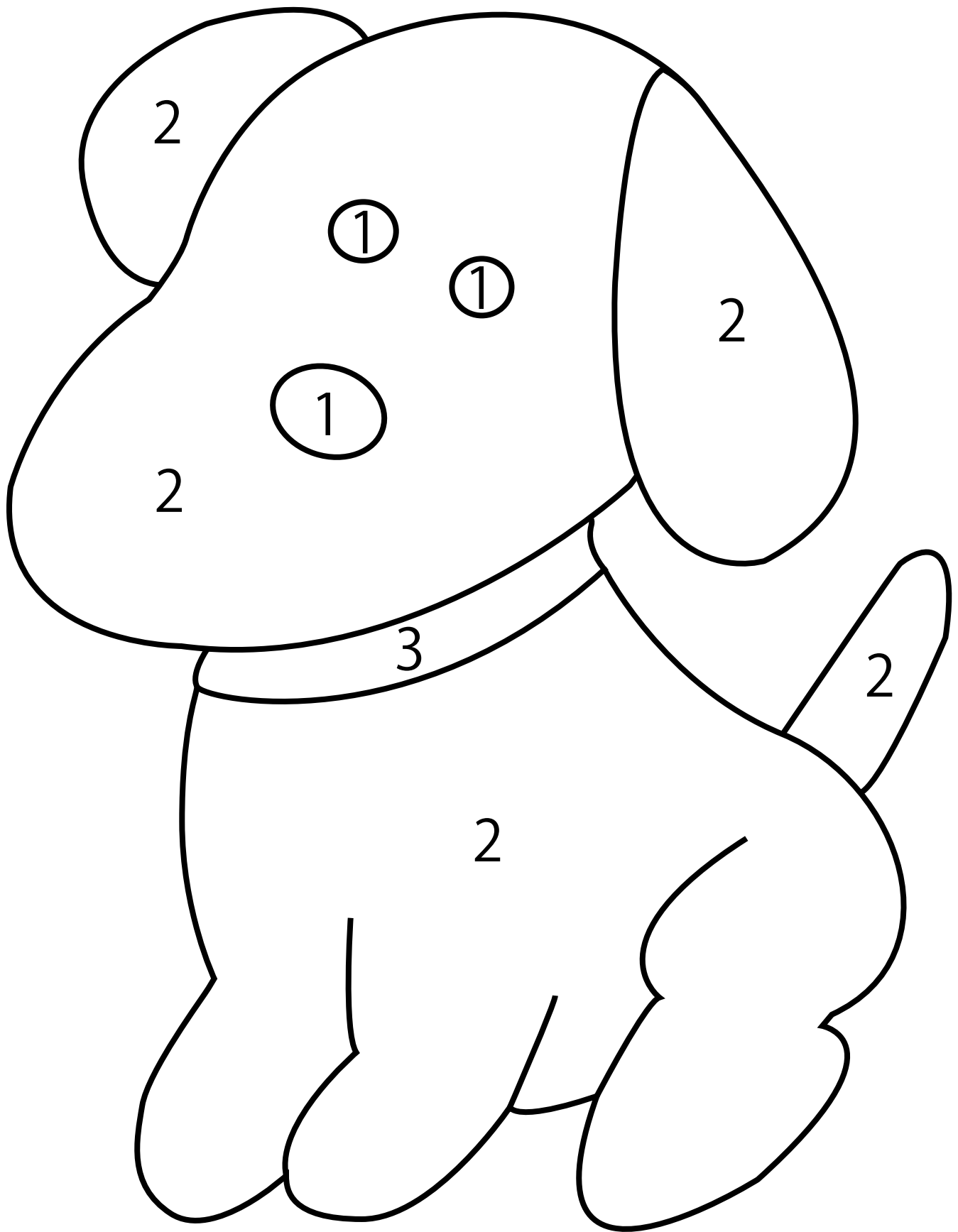

1.black

2.brown

3.red

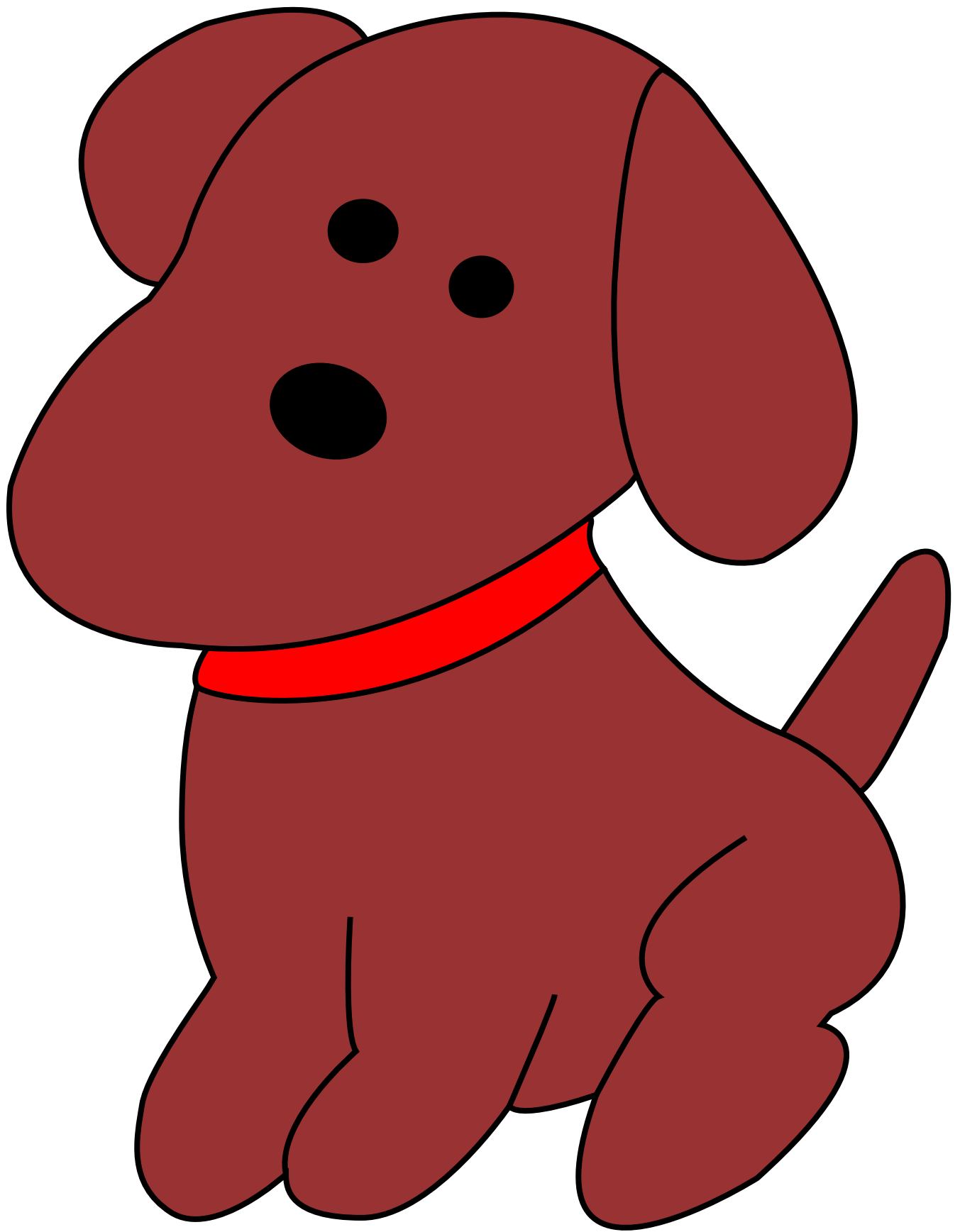

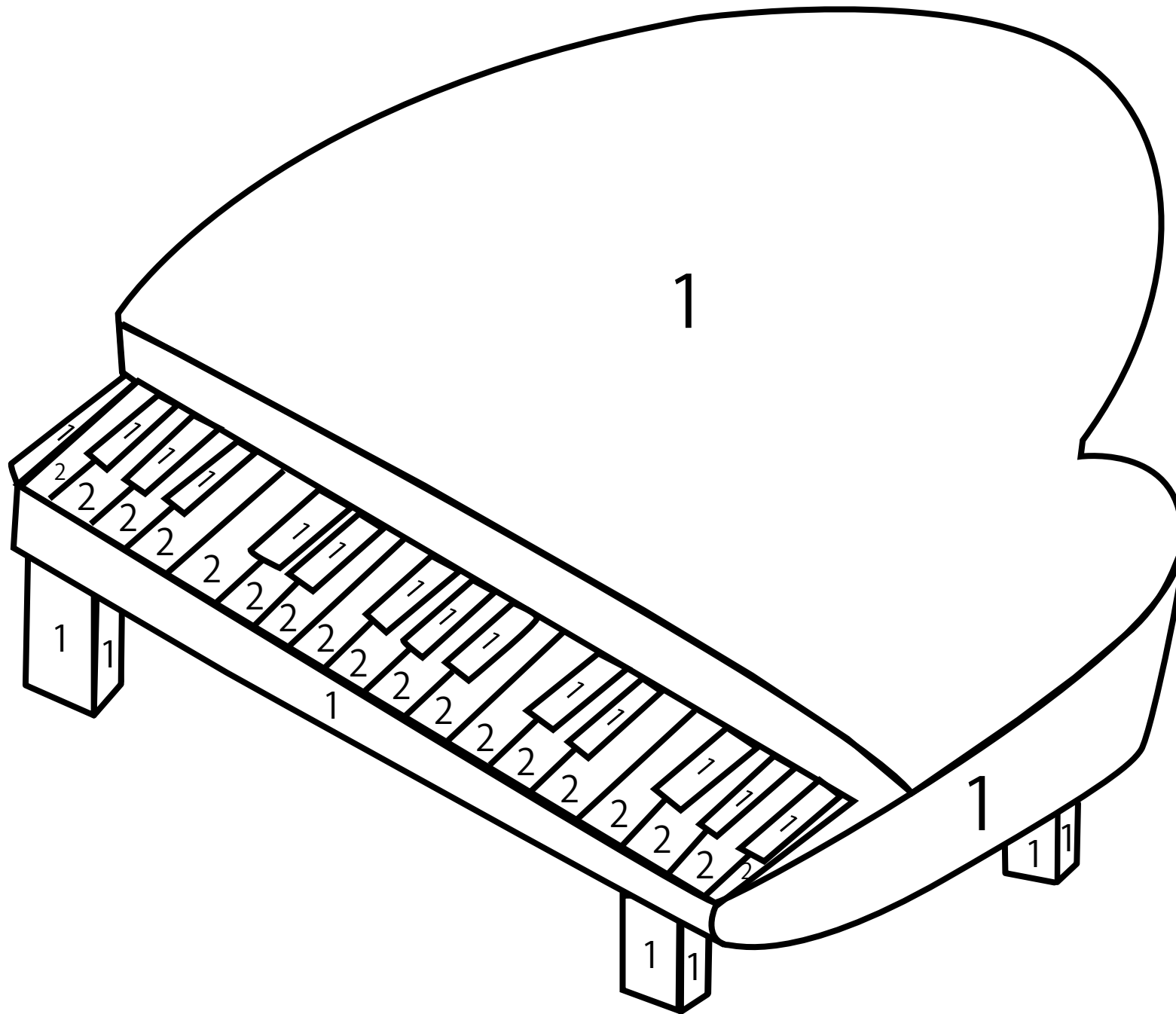

1.black

2.white

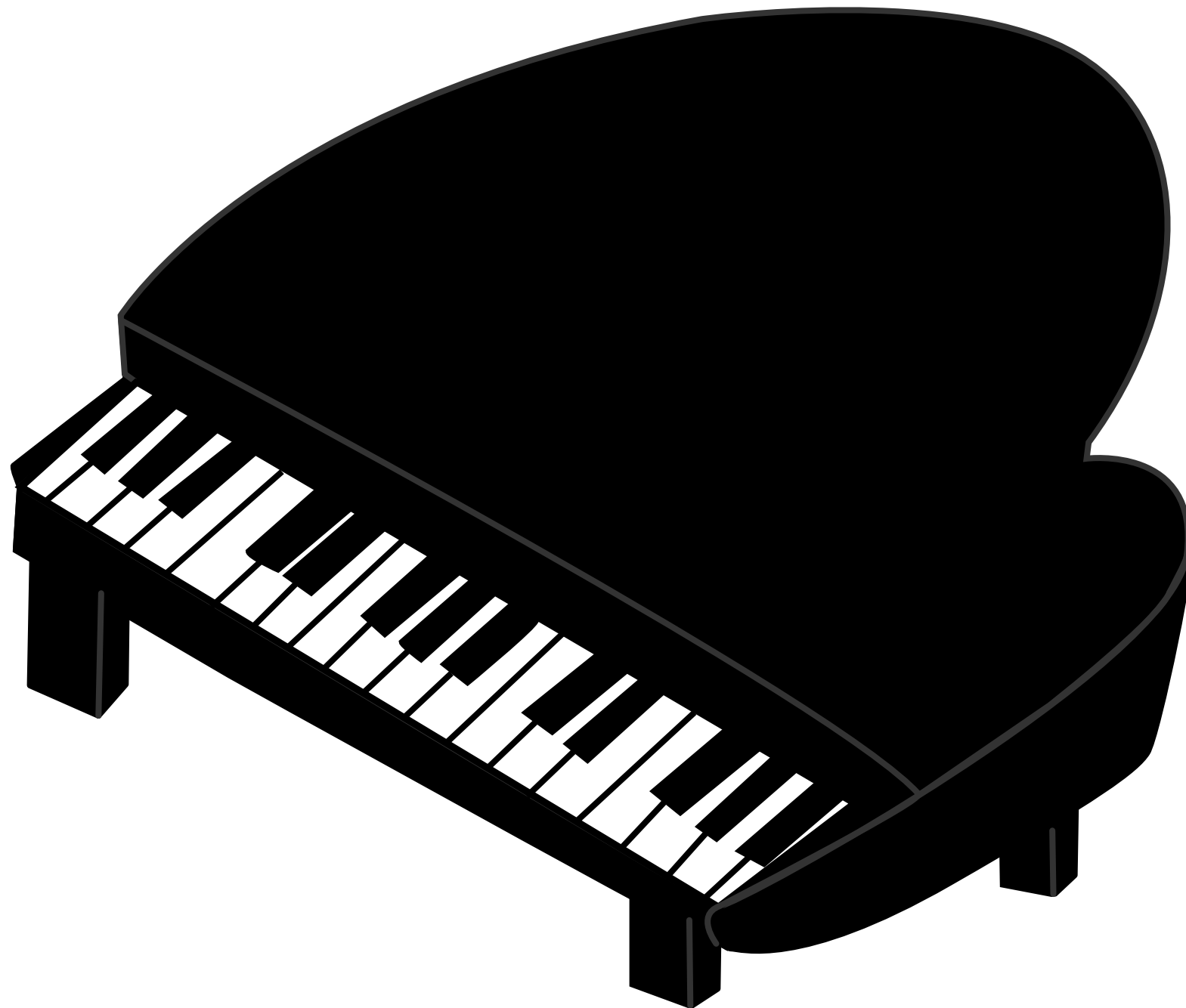

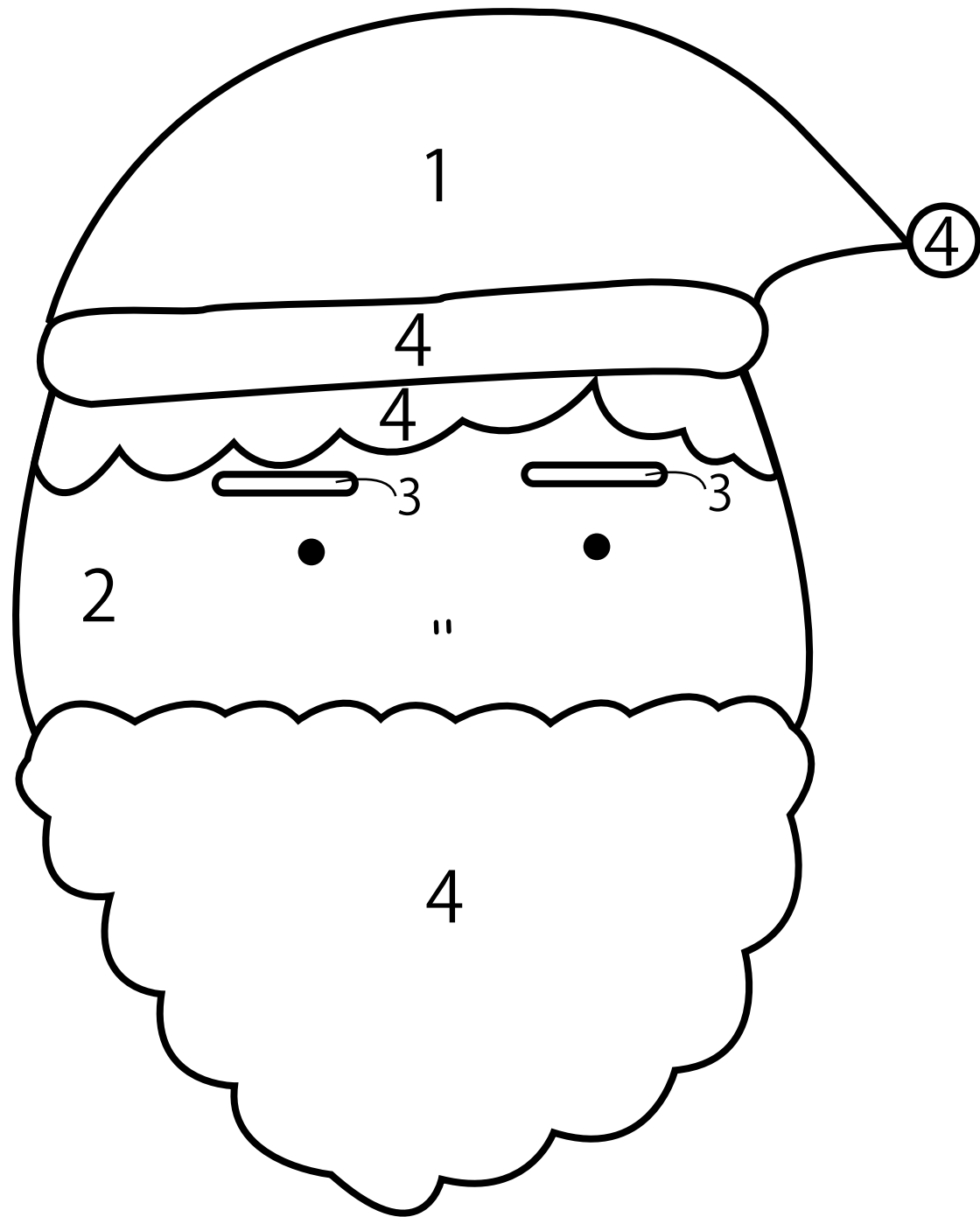

1.red

2.orange

3.black

4.white

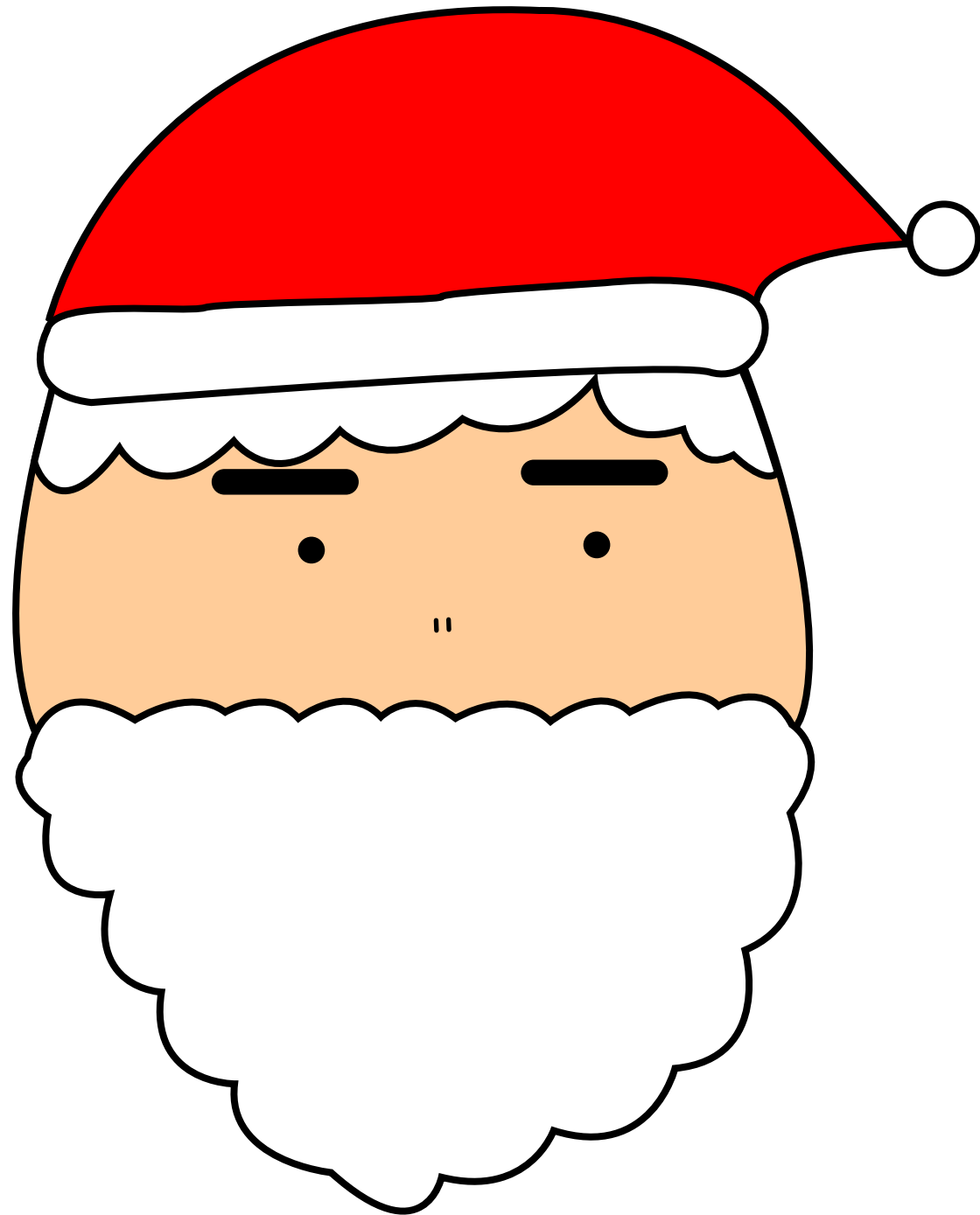

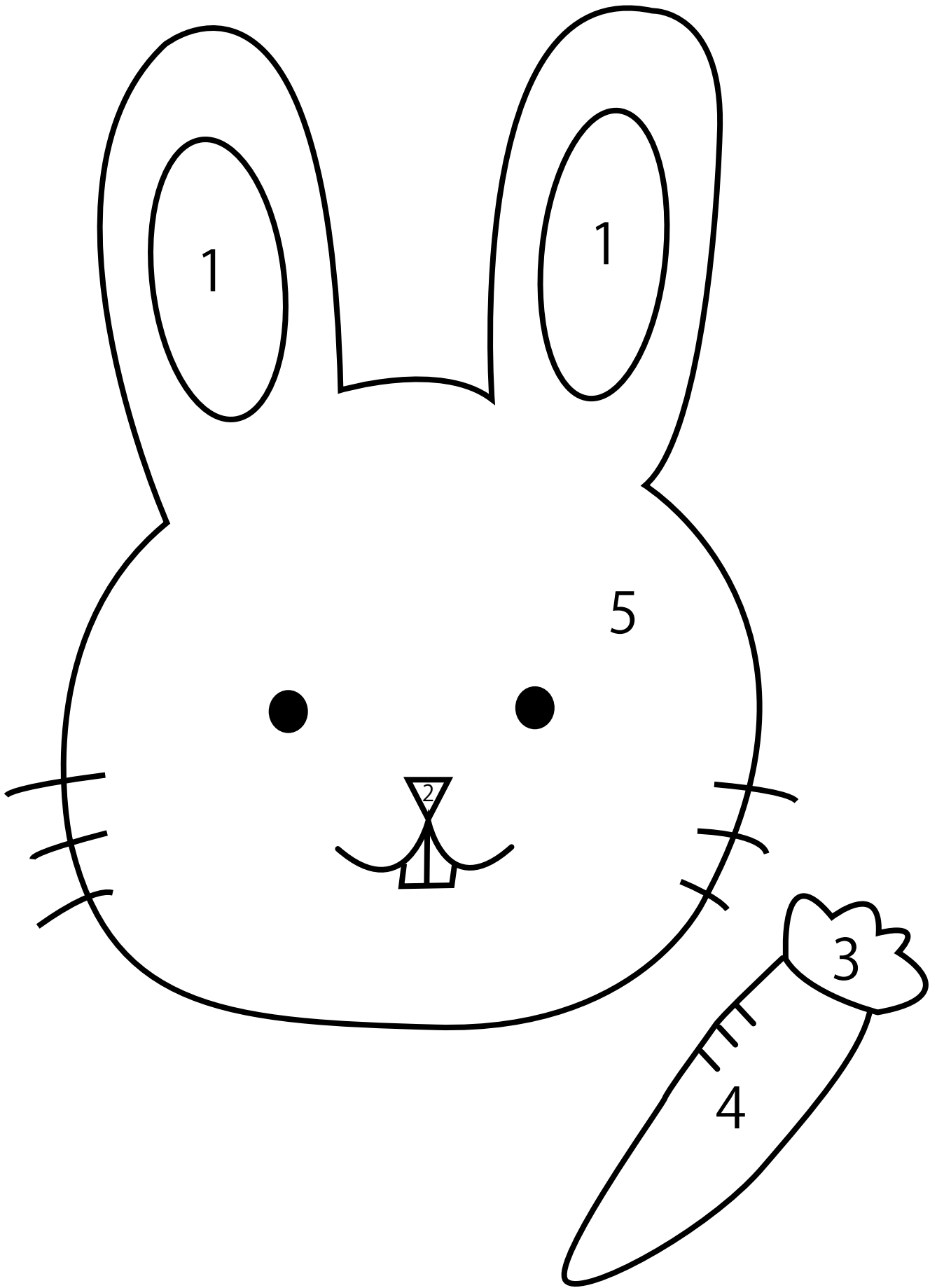

1.yellow

2.brown

3.green

4.orange

5.white

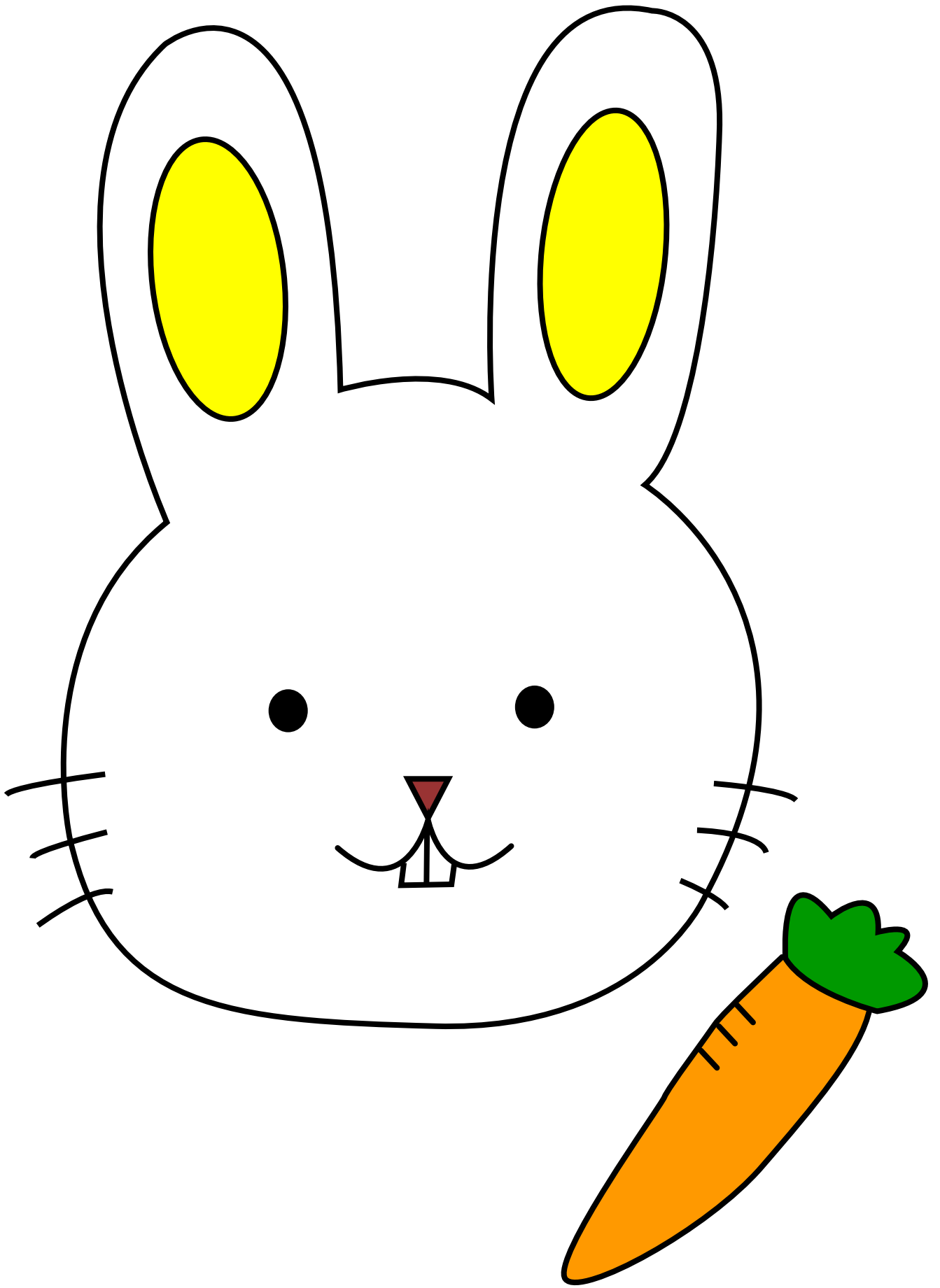

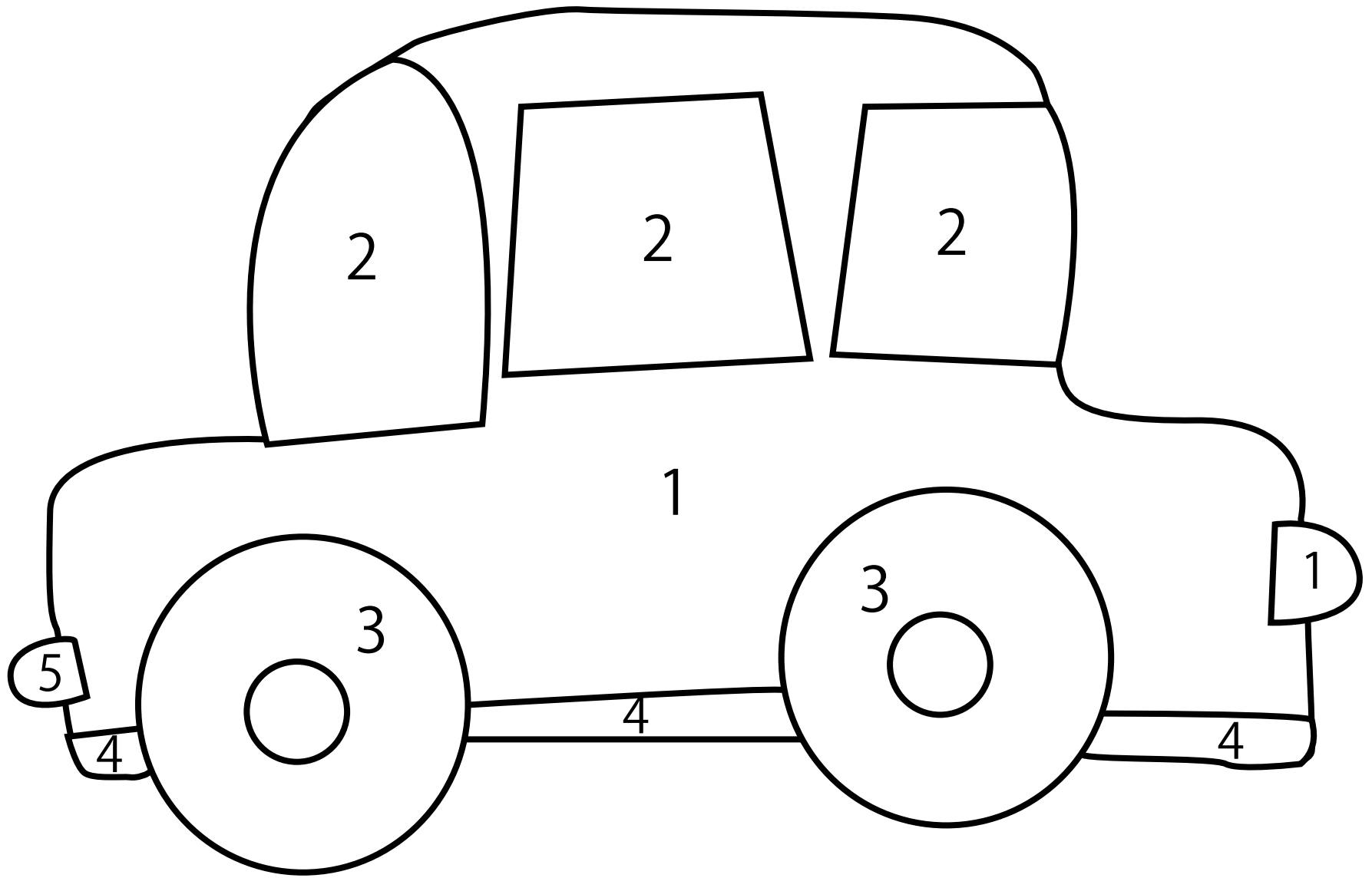

1.red

2.blue

3.black

4.green

5.yellow

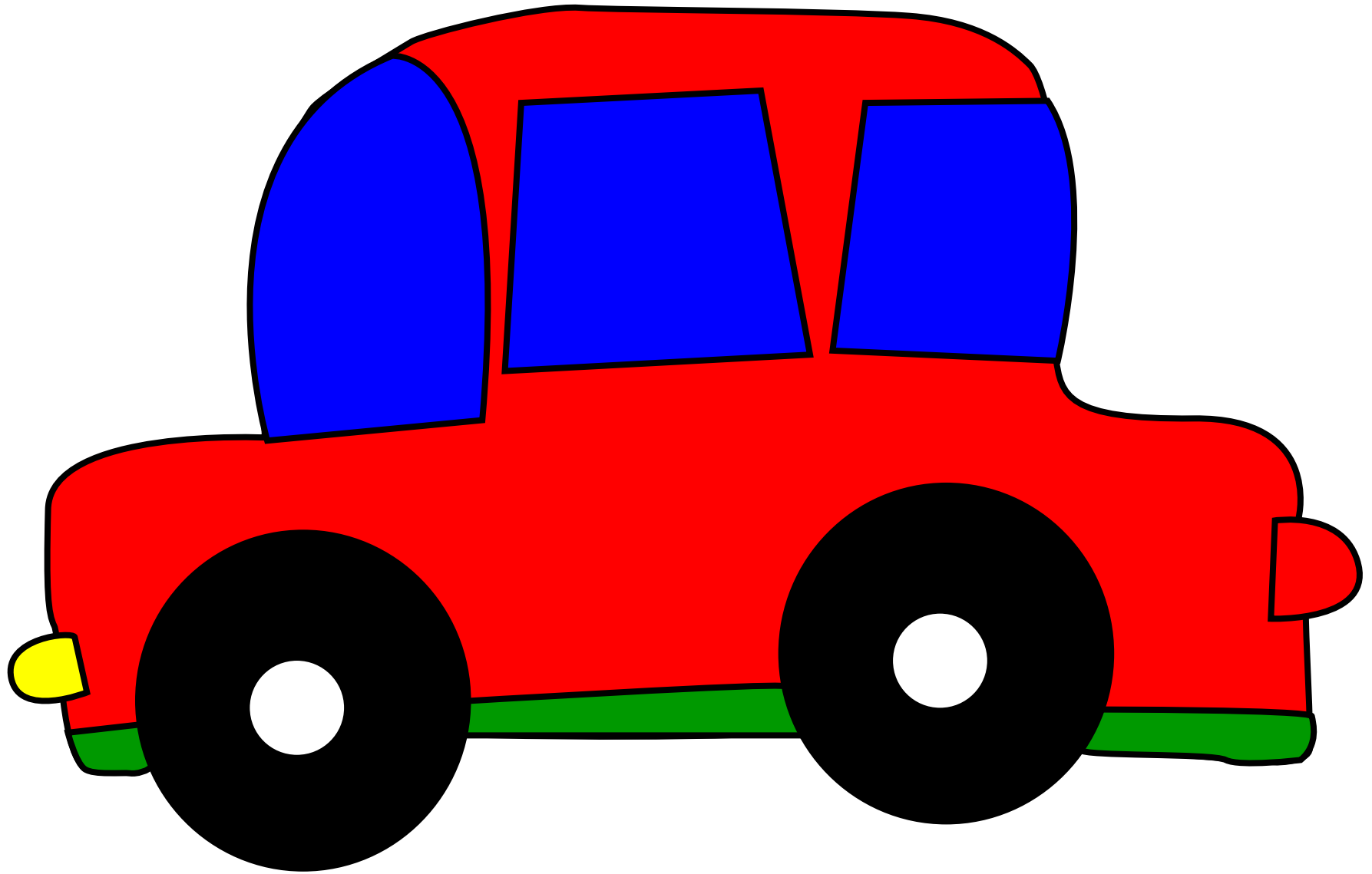

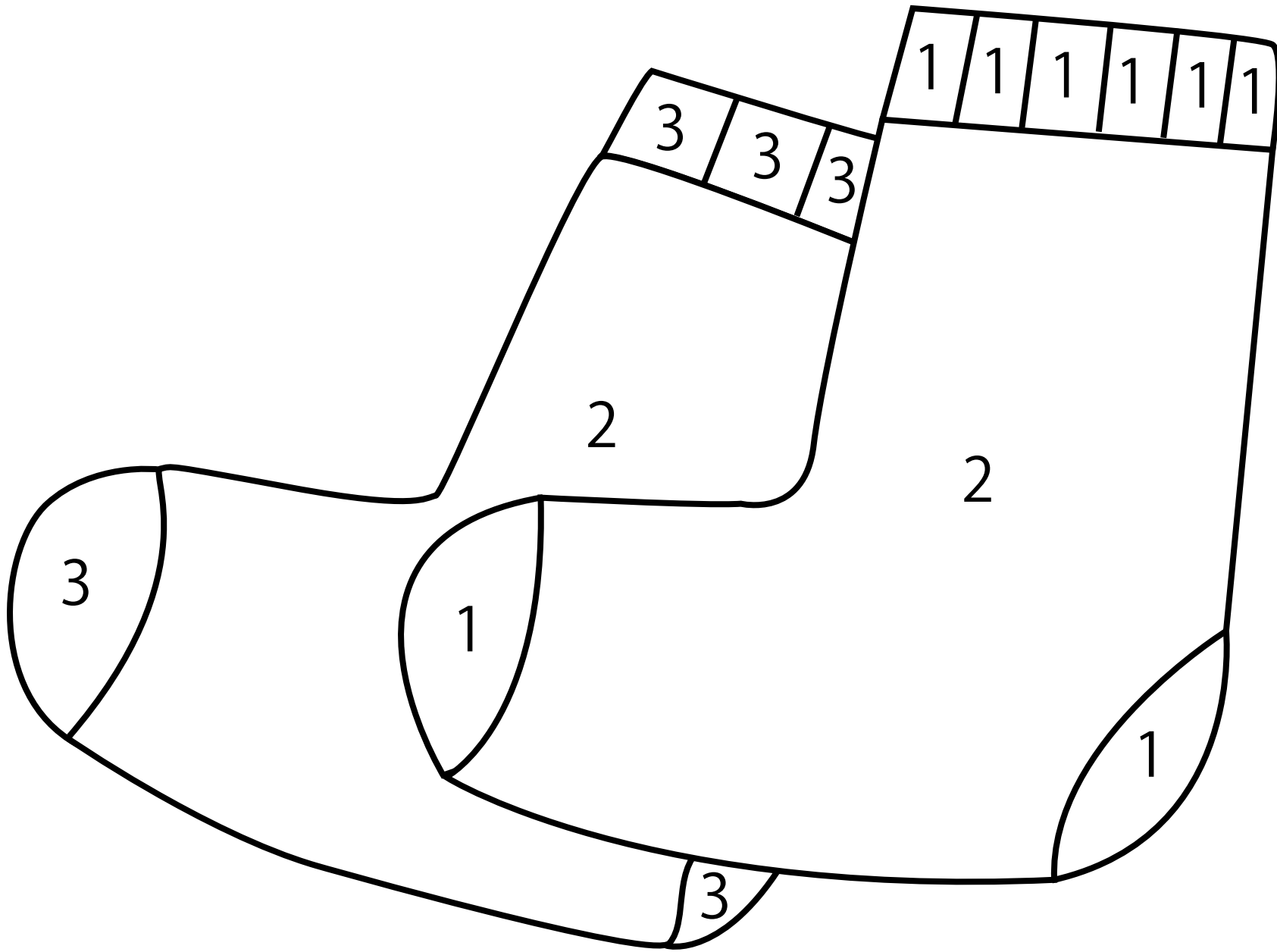

1.blue

2.white

3.red

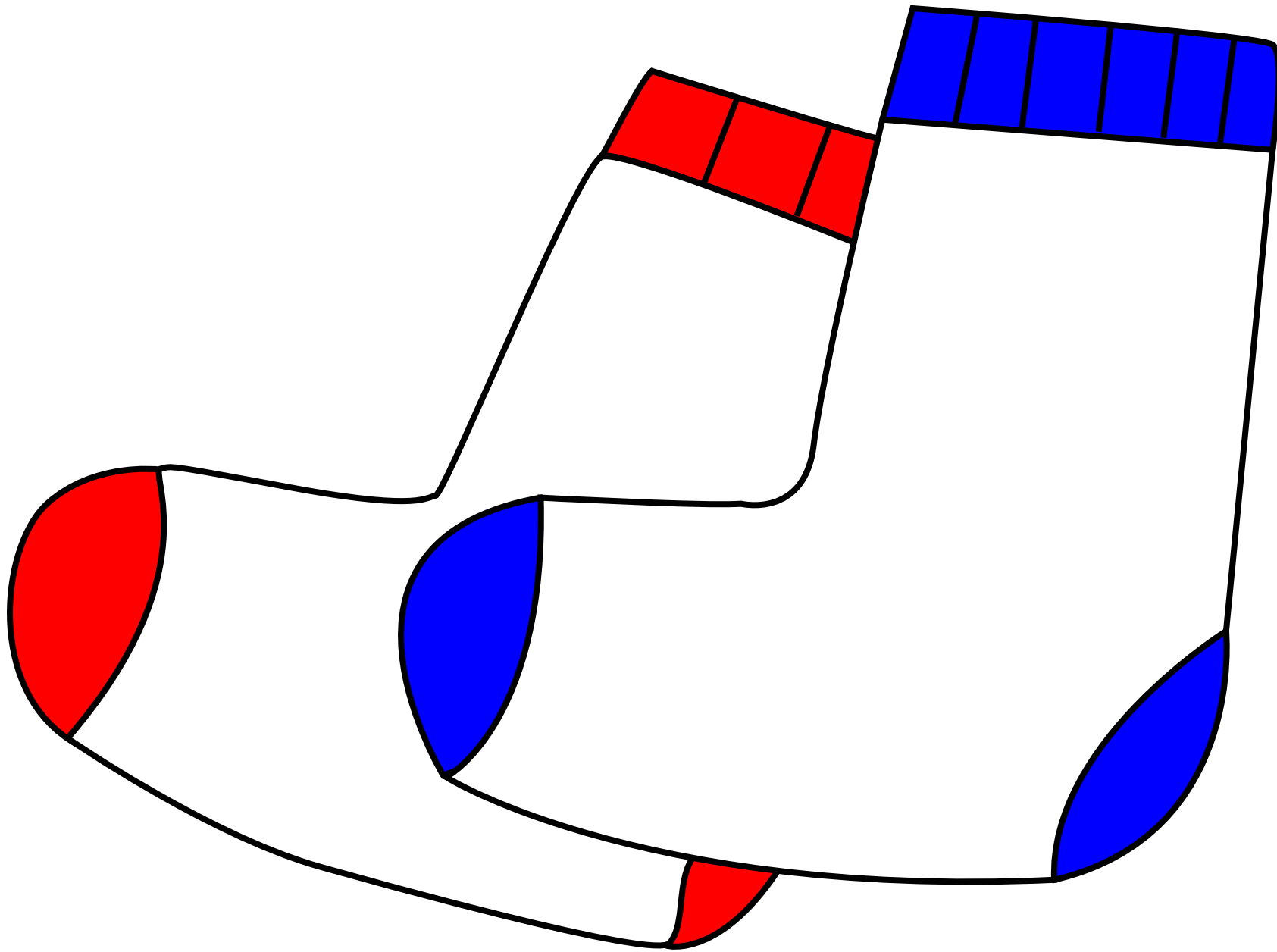

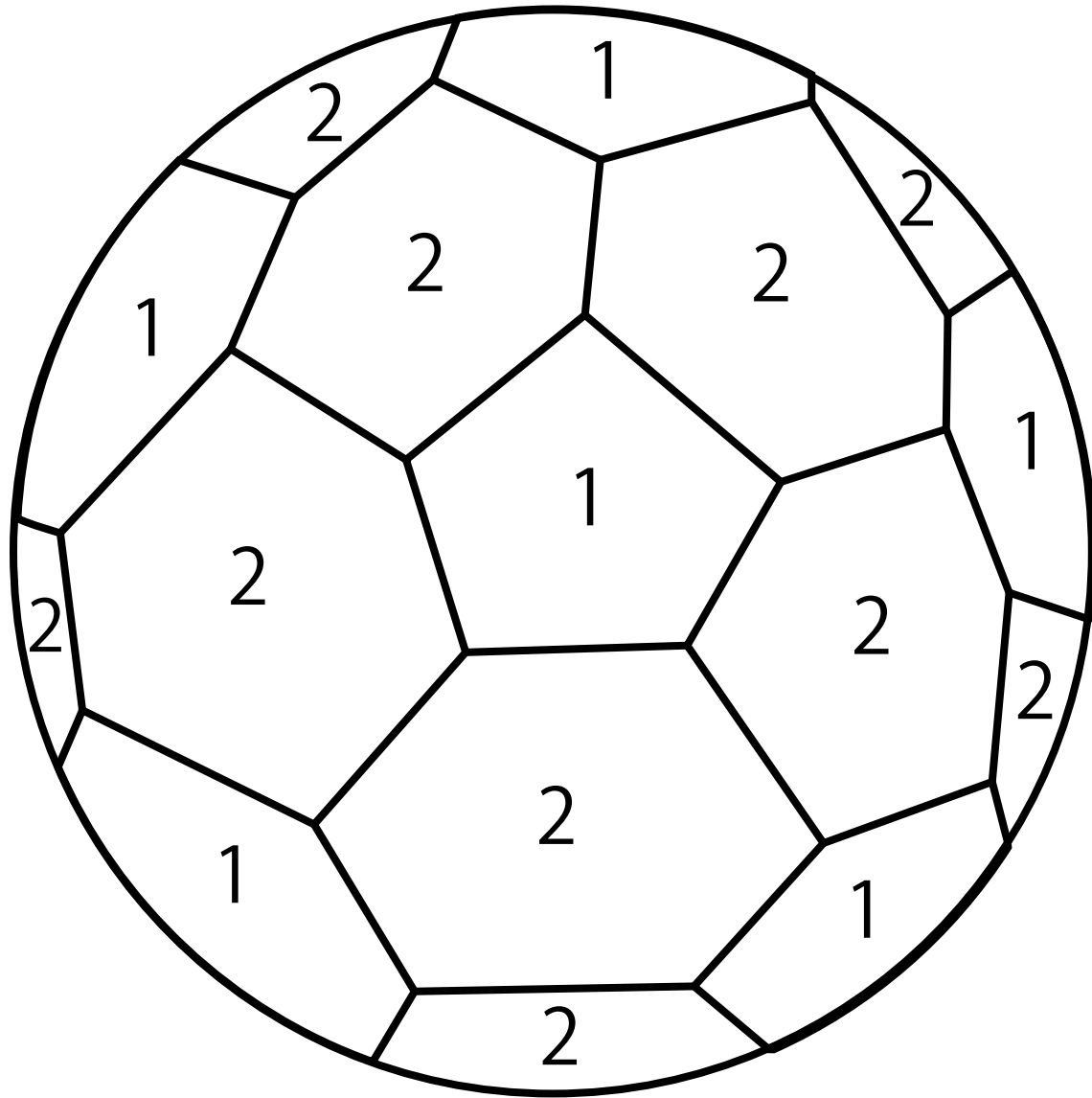

1.black

2.yellow

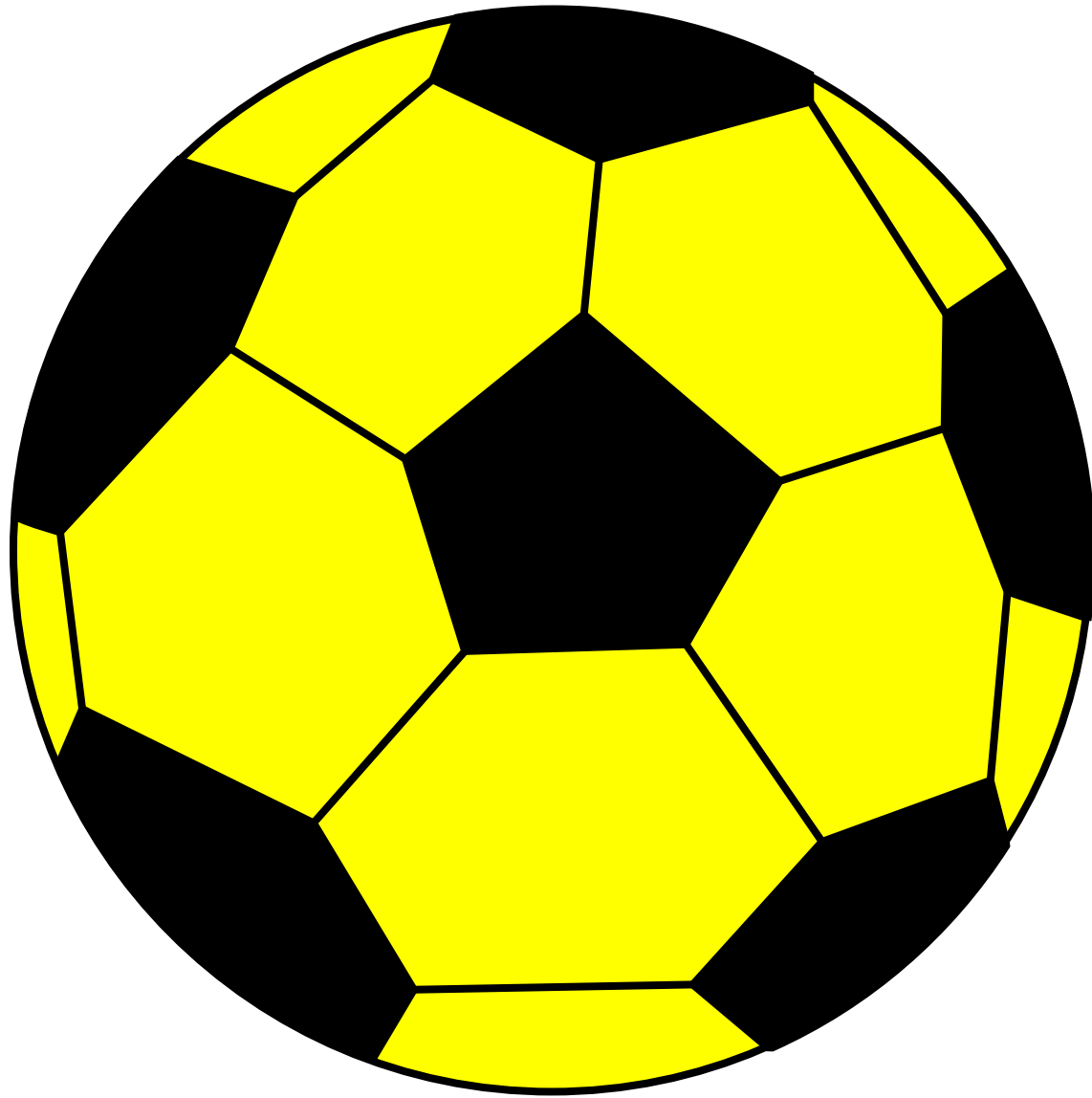

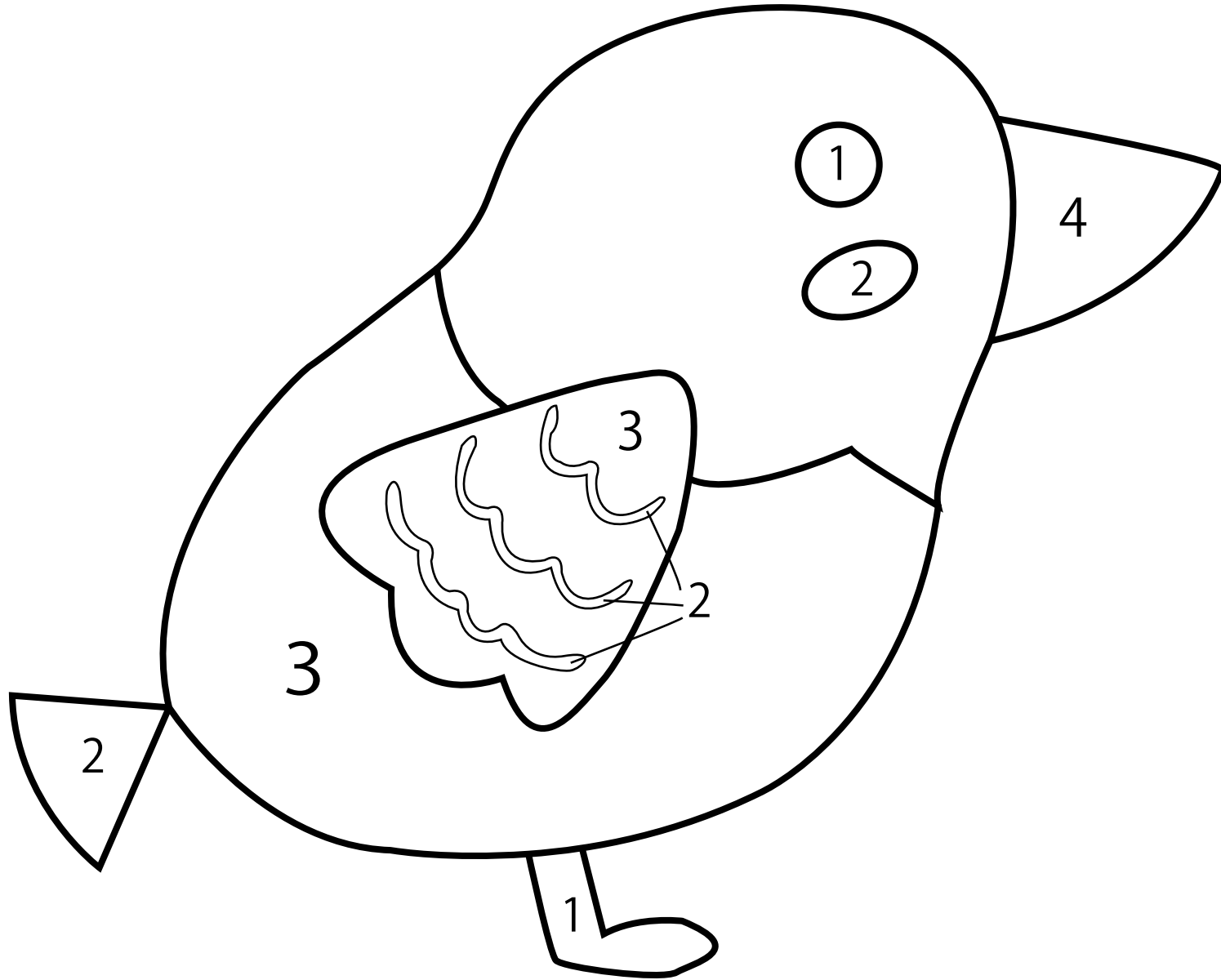

1. blown

2. pink

3. gray

4. yellow

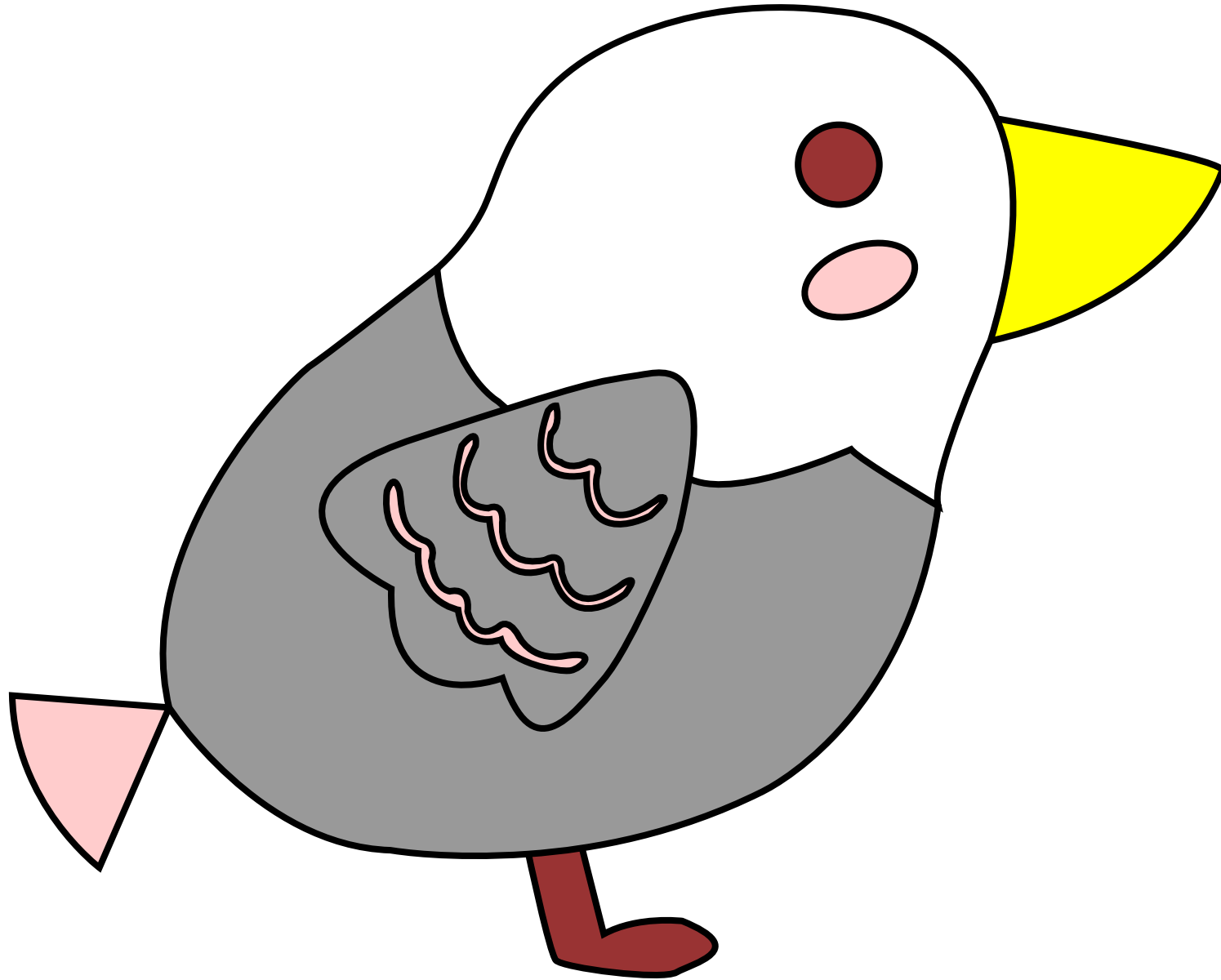

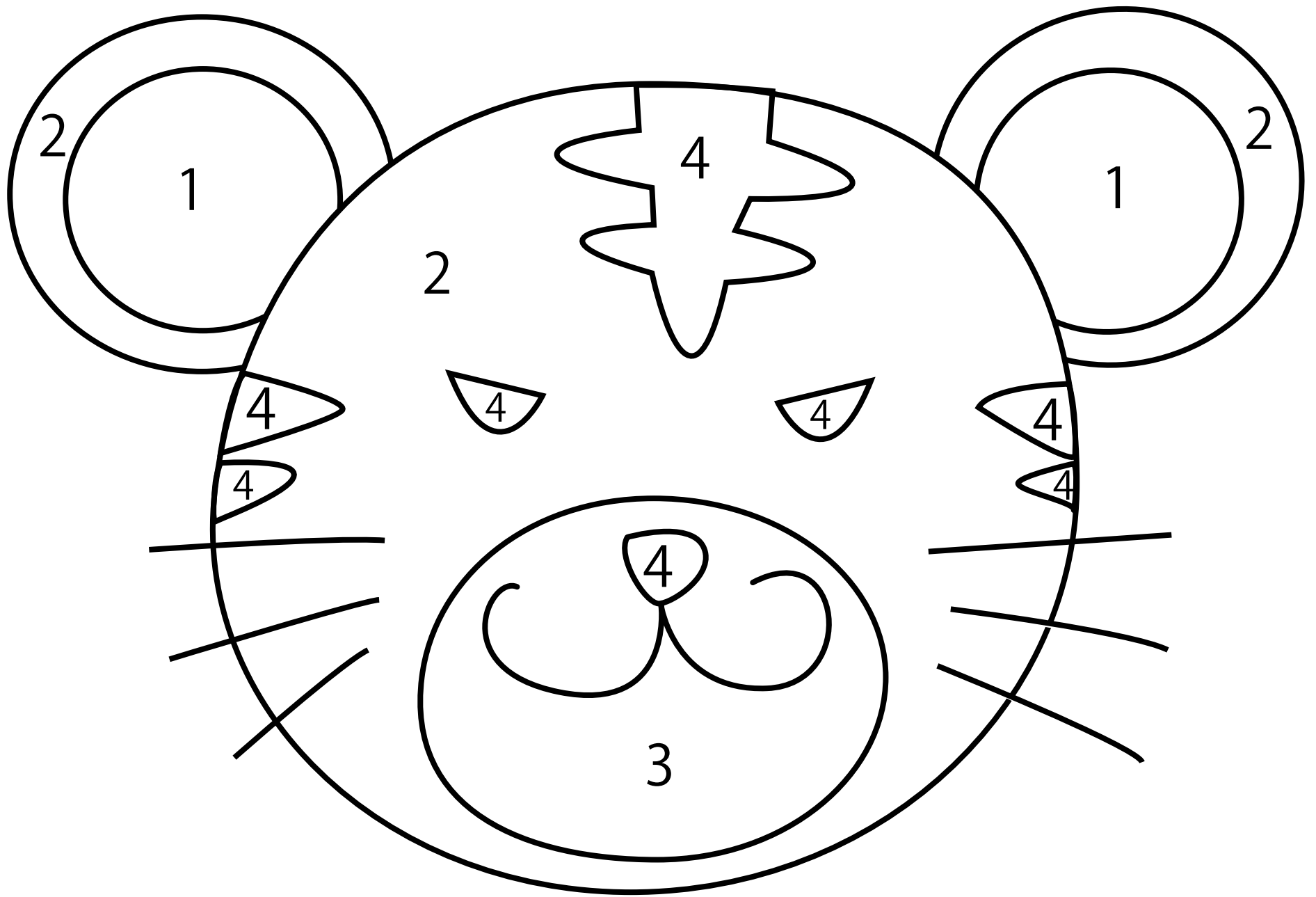

1. pink

2. yellow

3. white

4. black

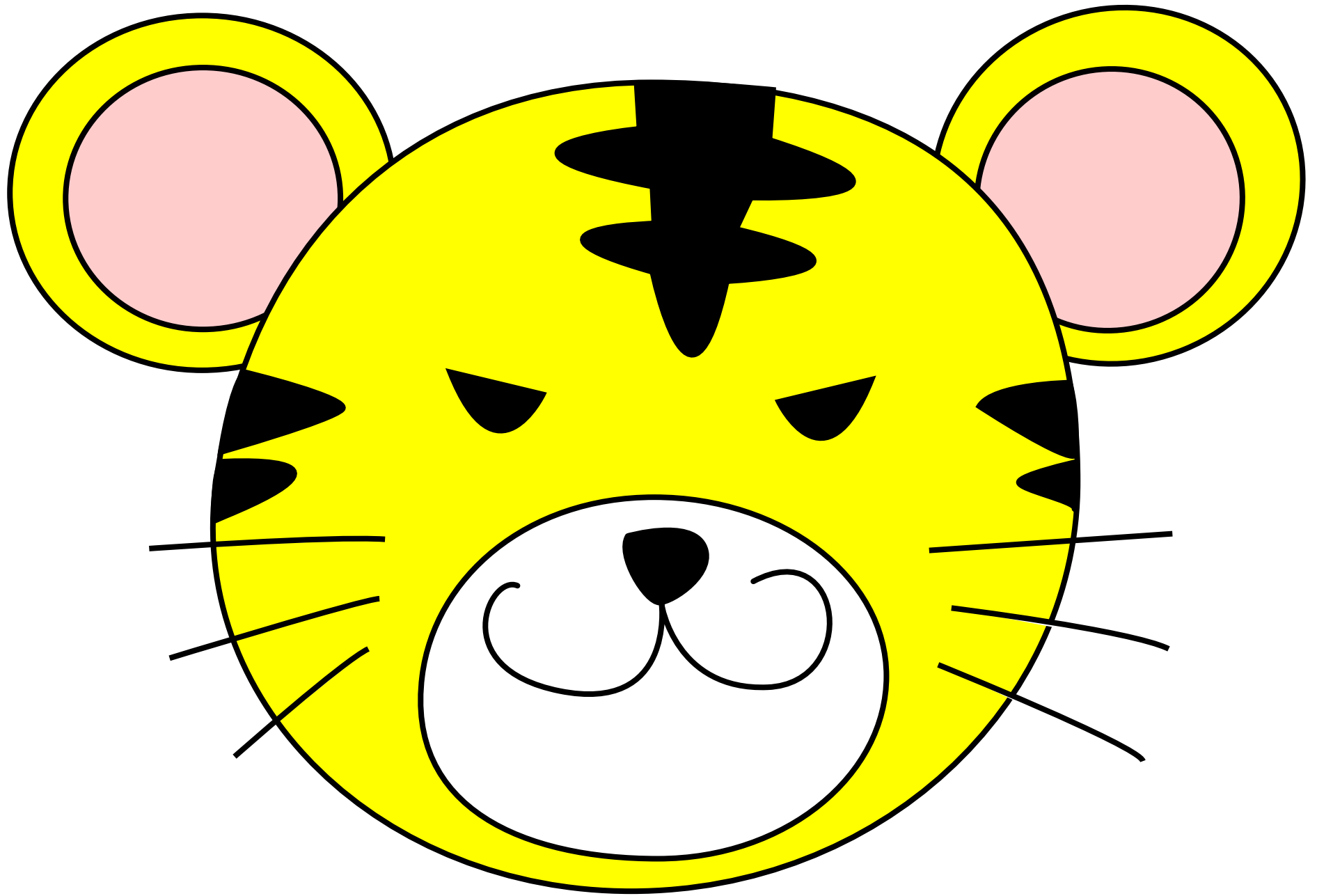

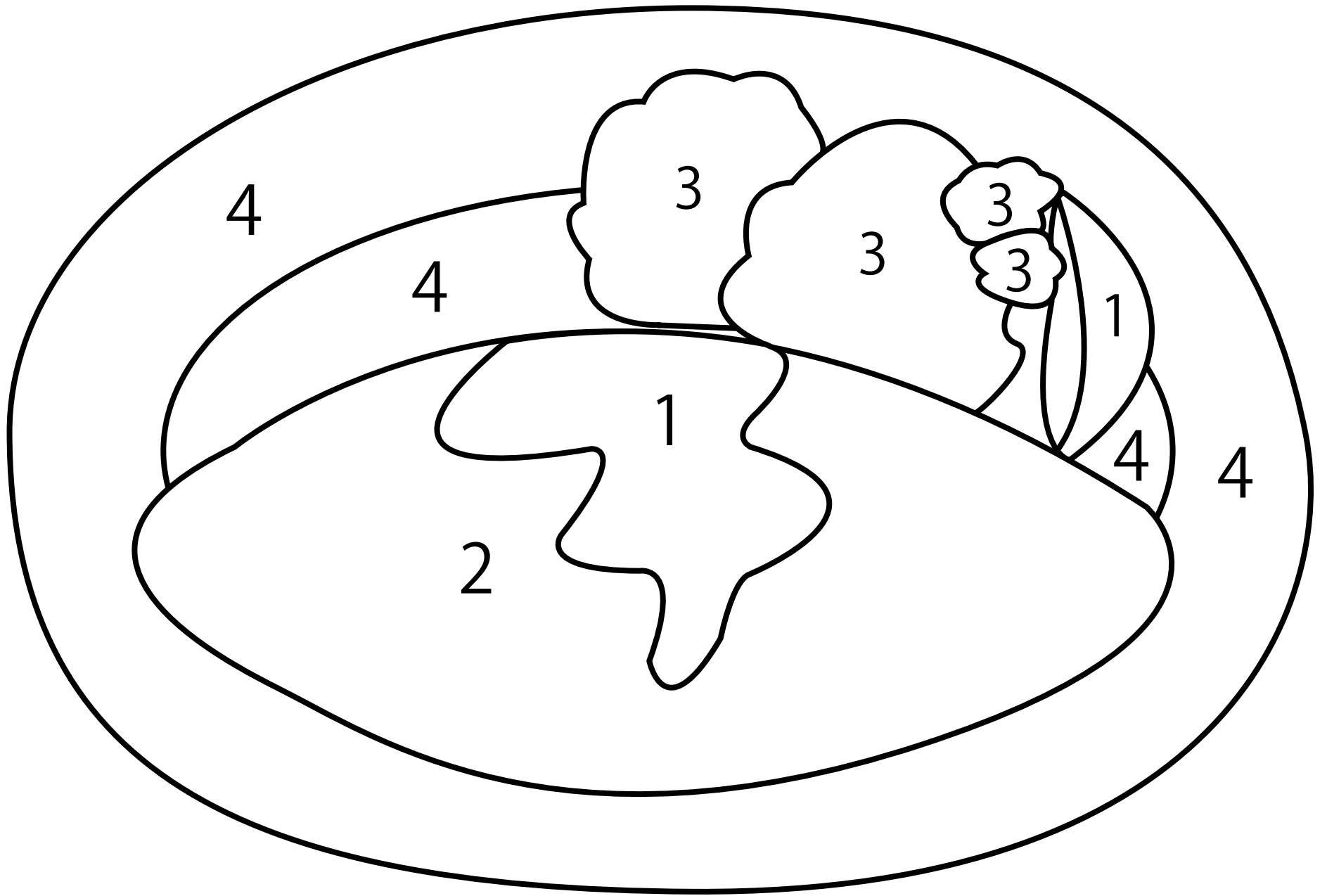

1. red

2. yellow

3. green

4. gray

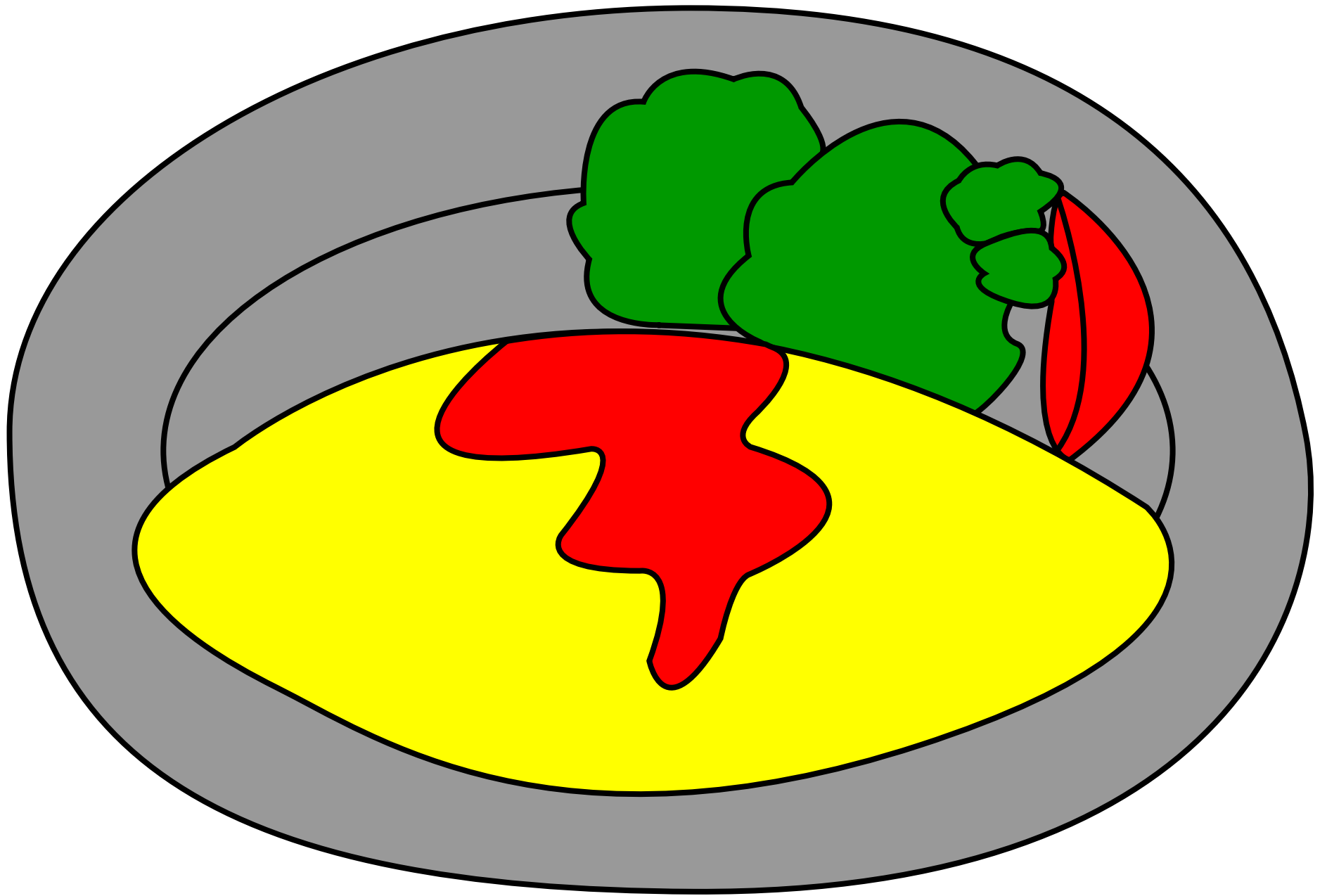

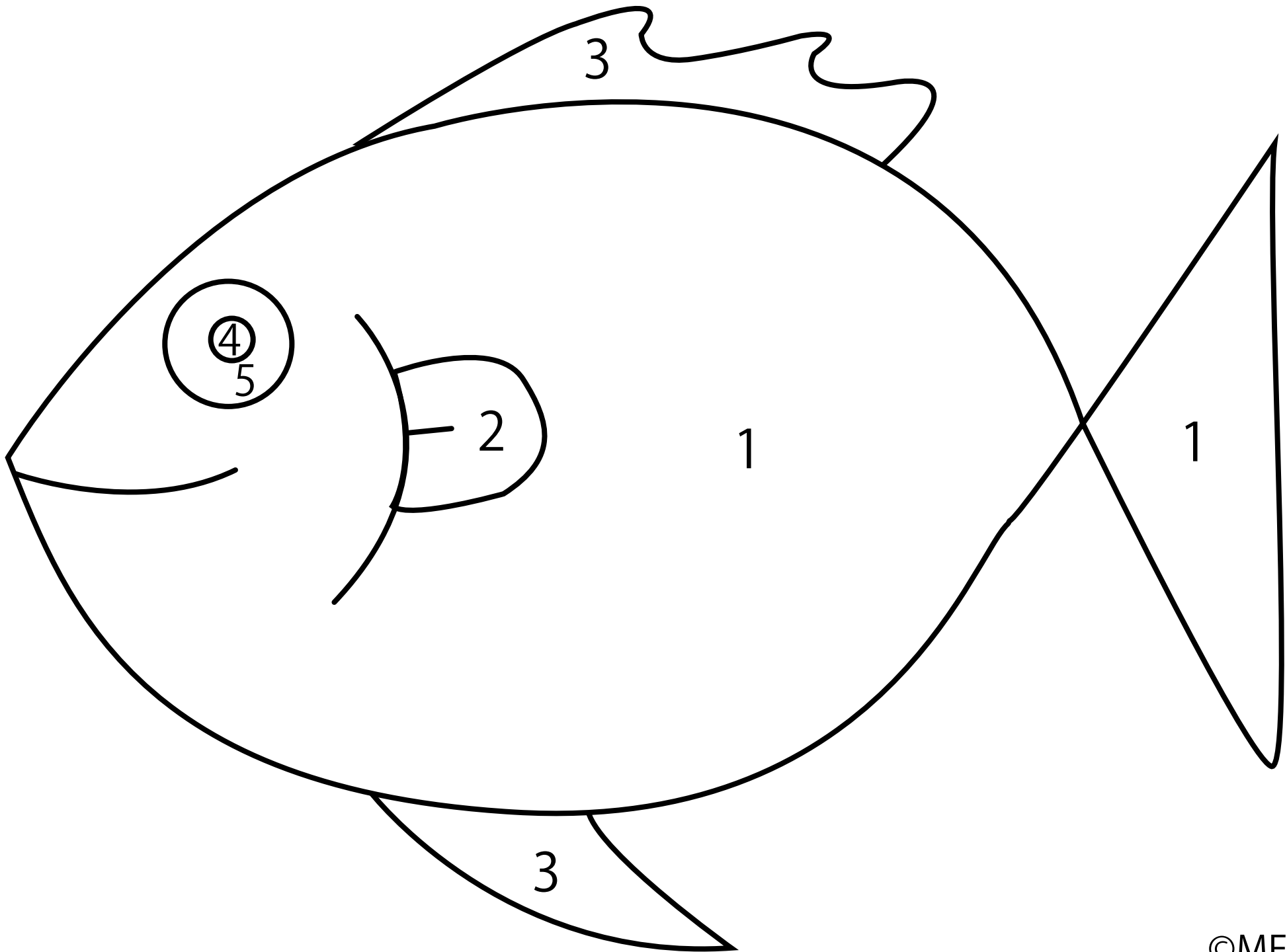

1.blue

2.yellow

3.green

4.black

5.white

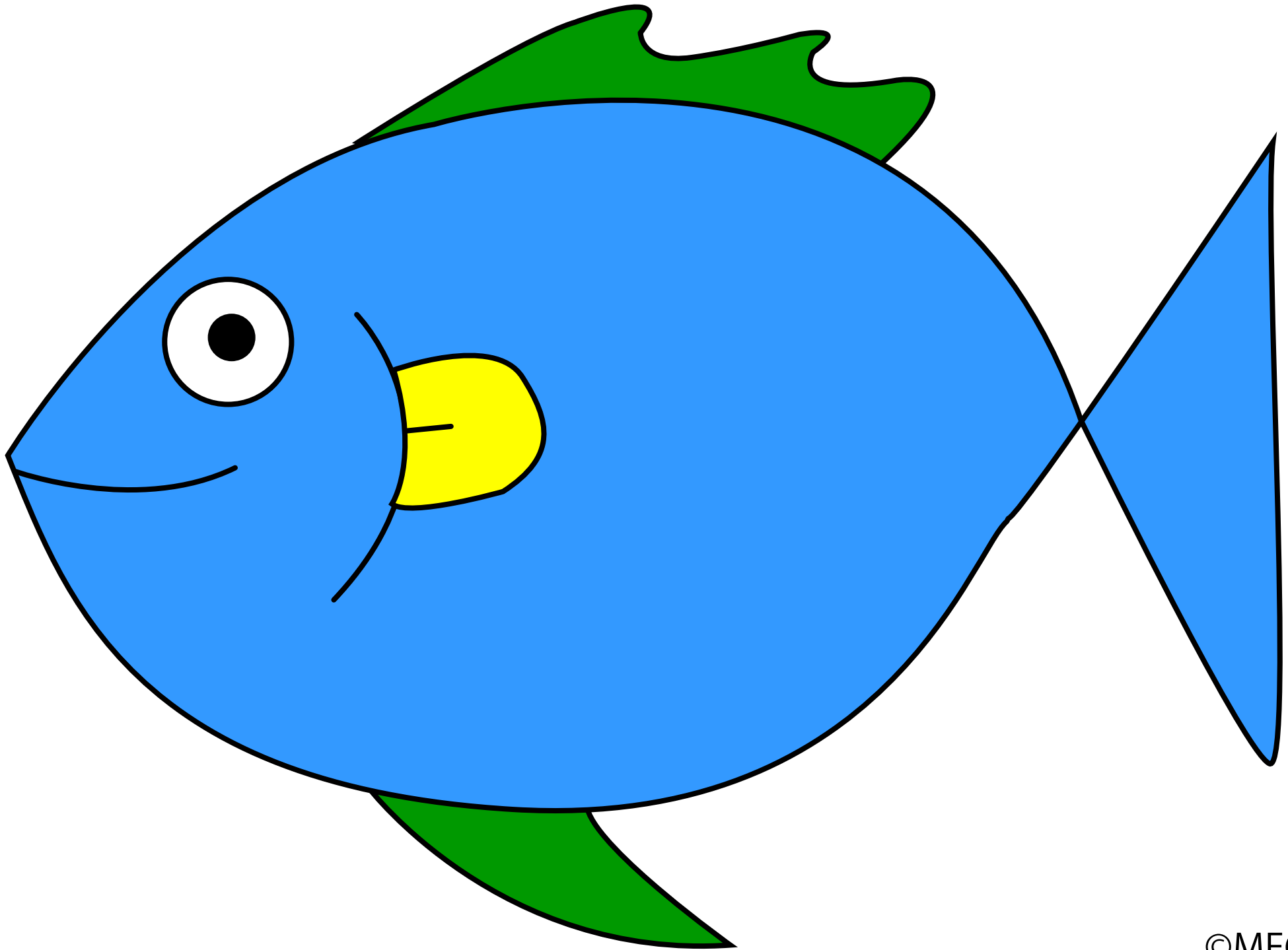

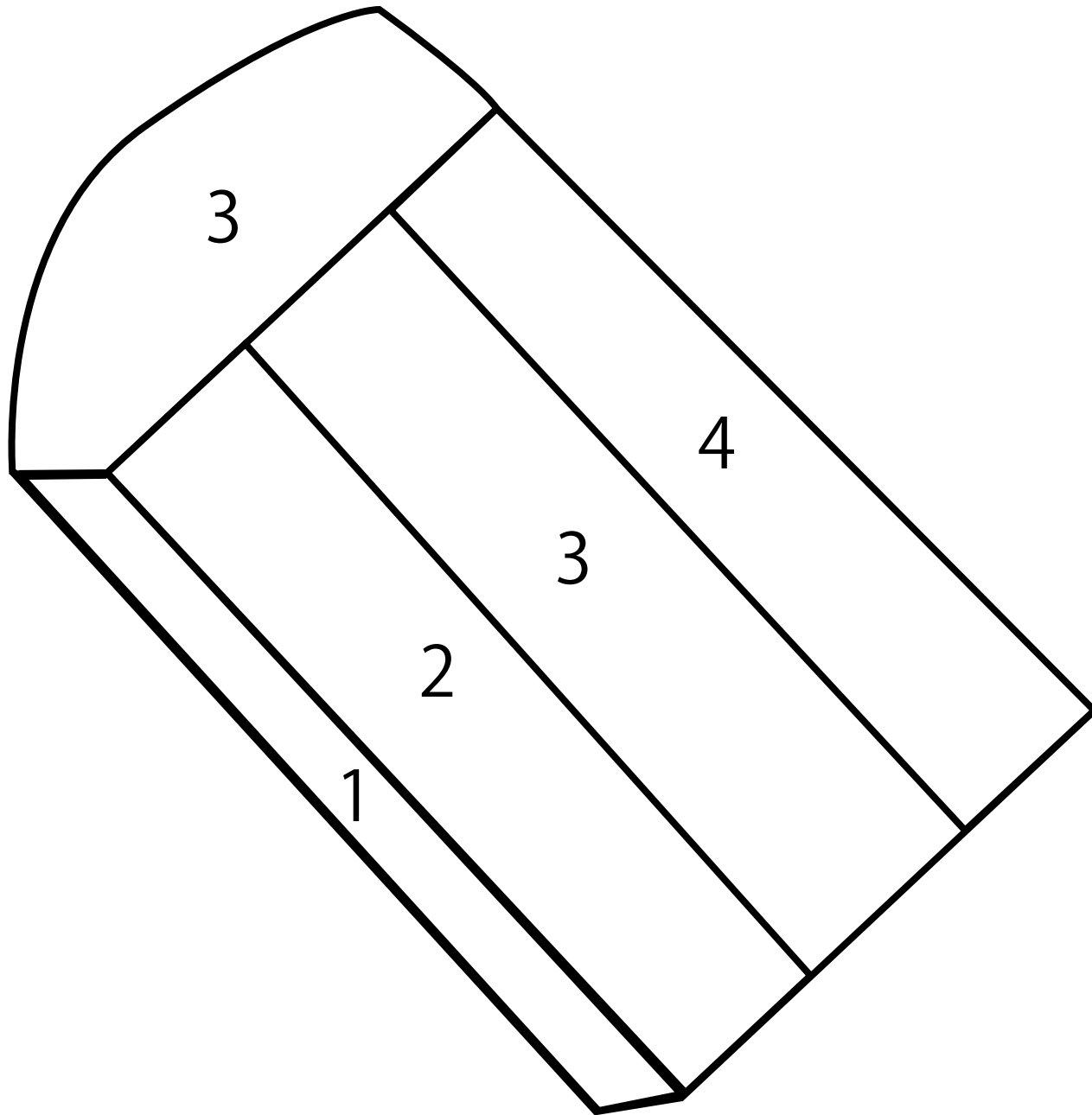

1.black

2.red

3.white

4.blue

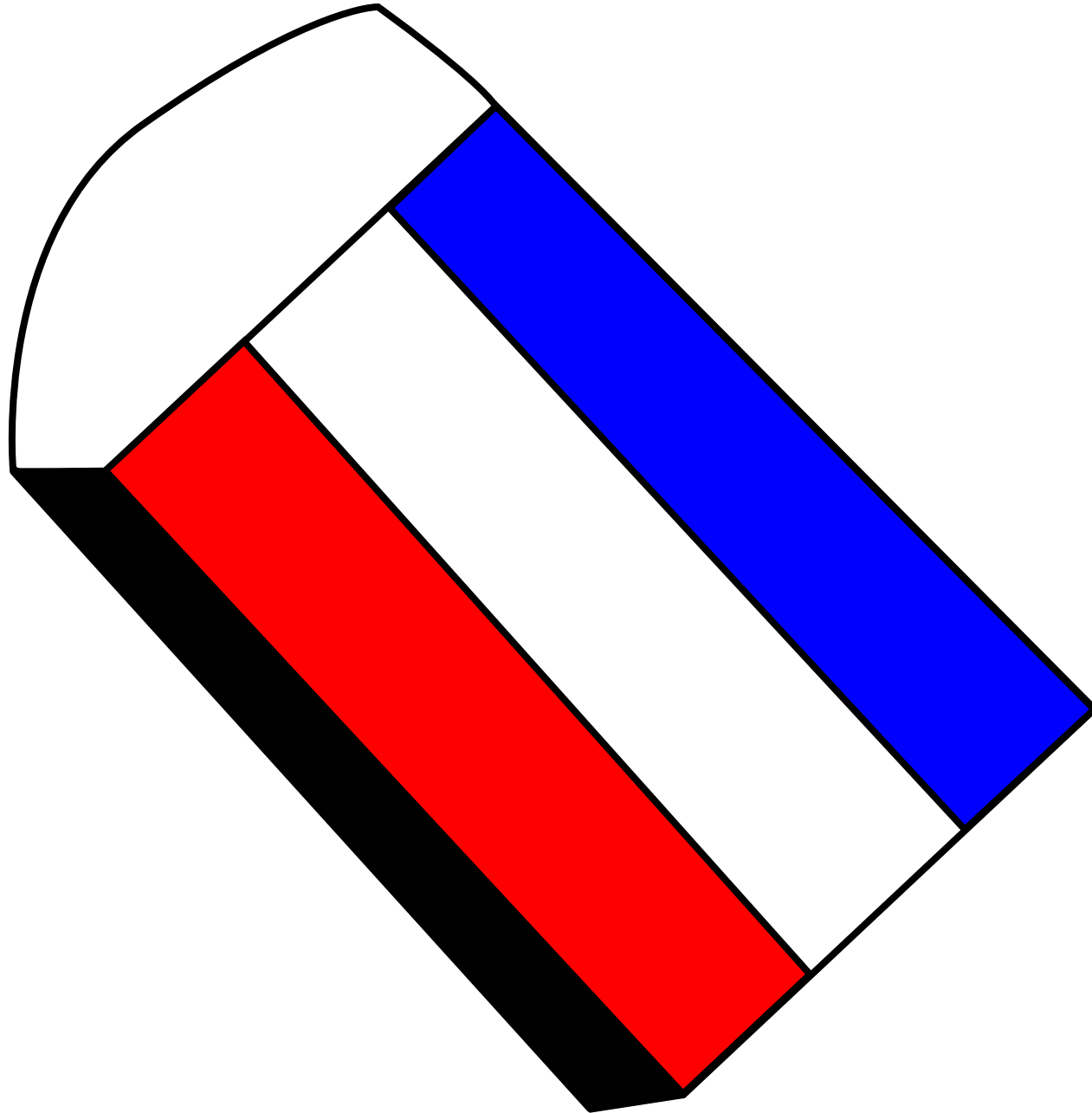

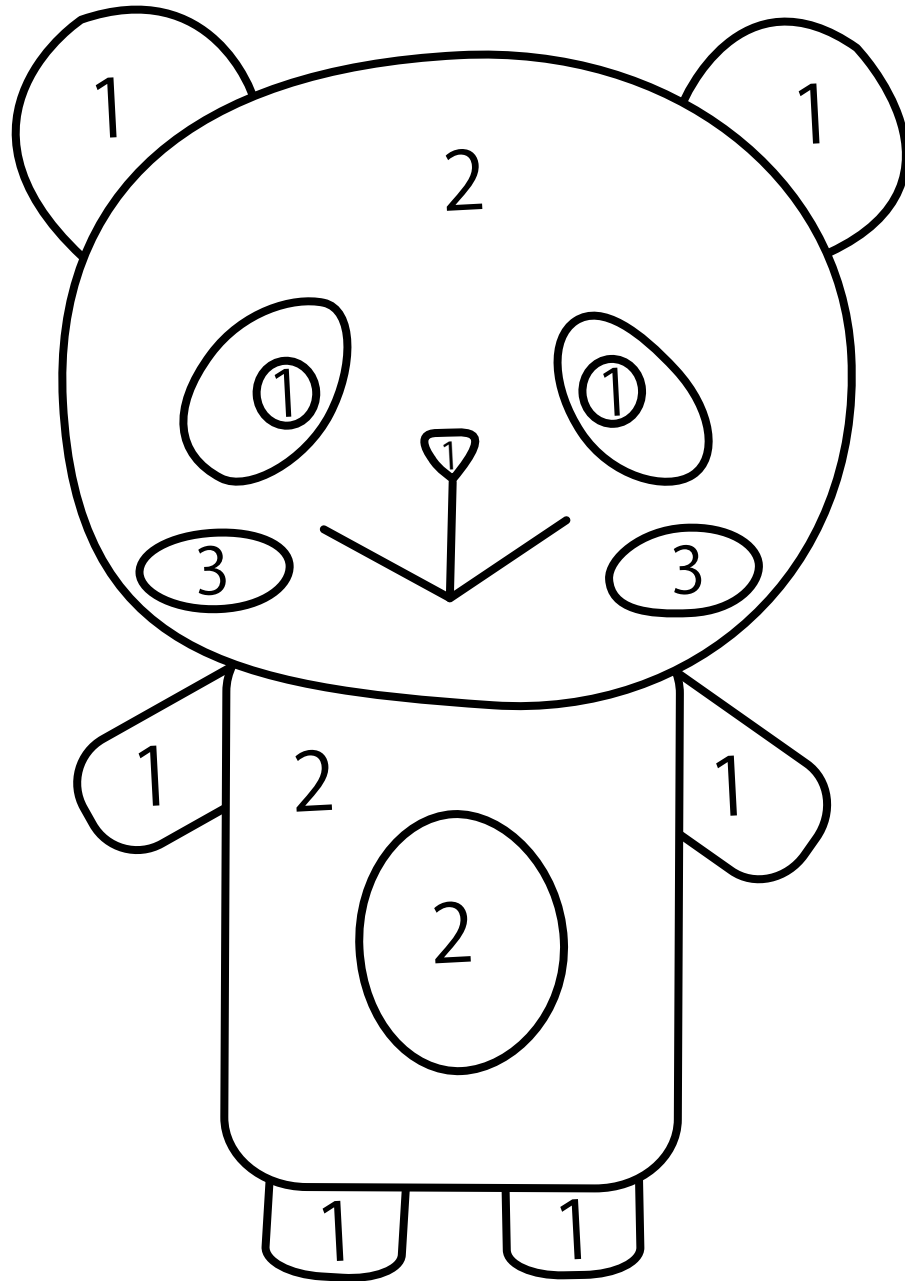

1.black

2.white

3.pink

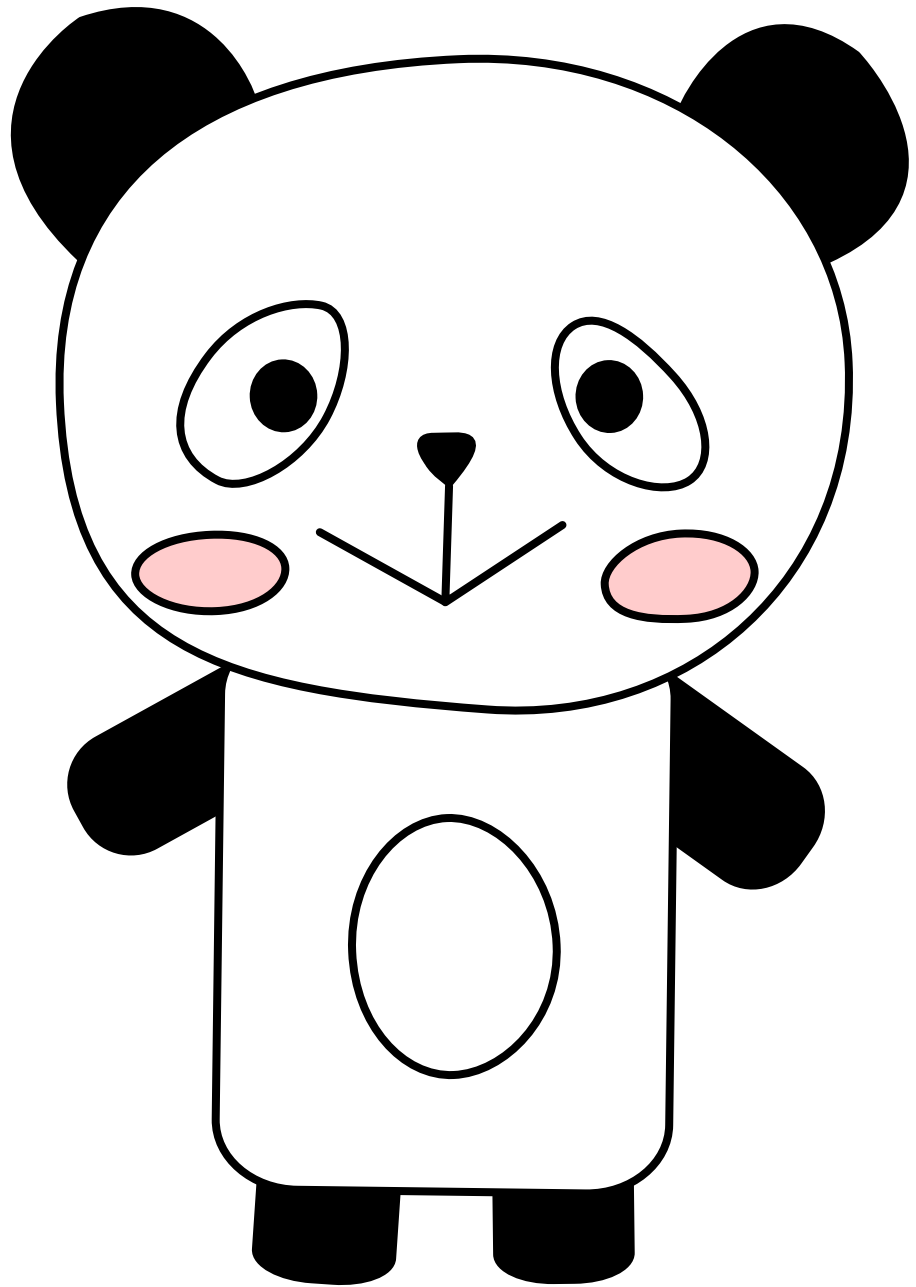

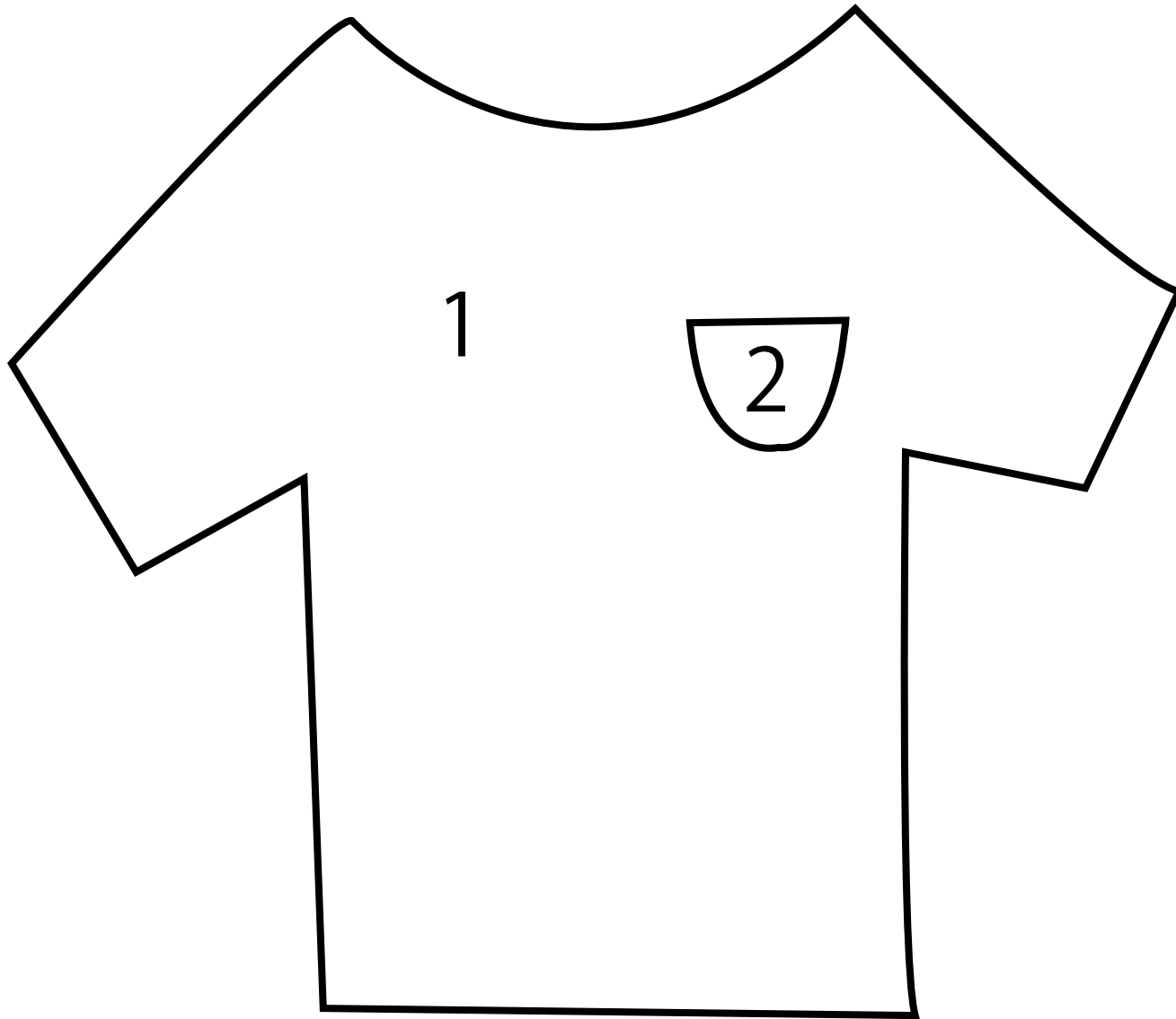

1.blue

2.green

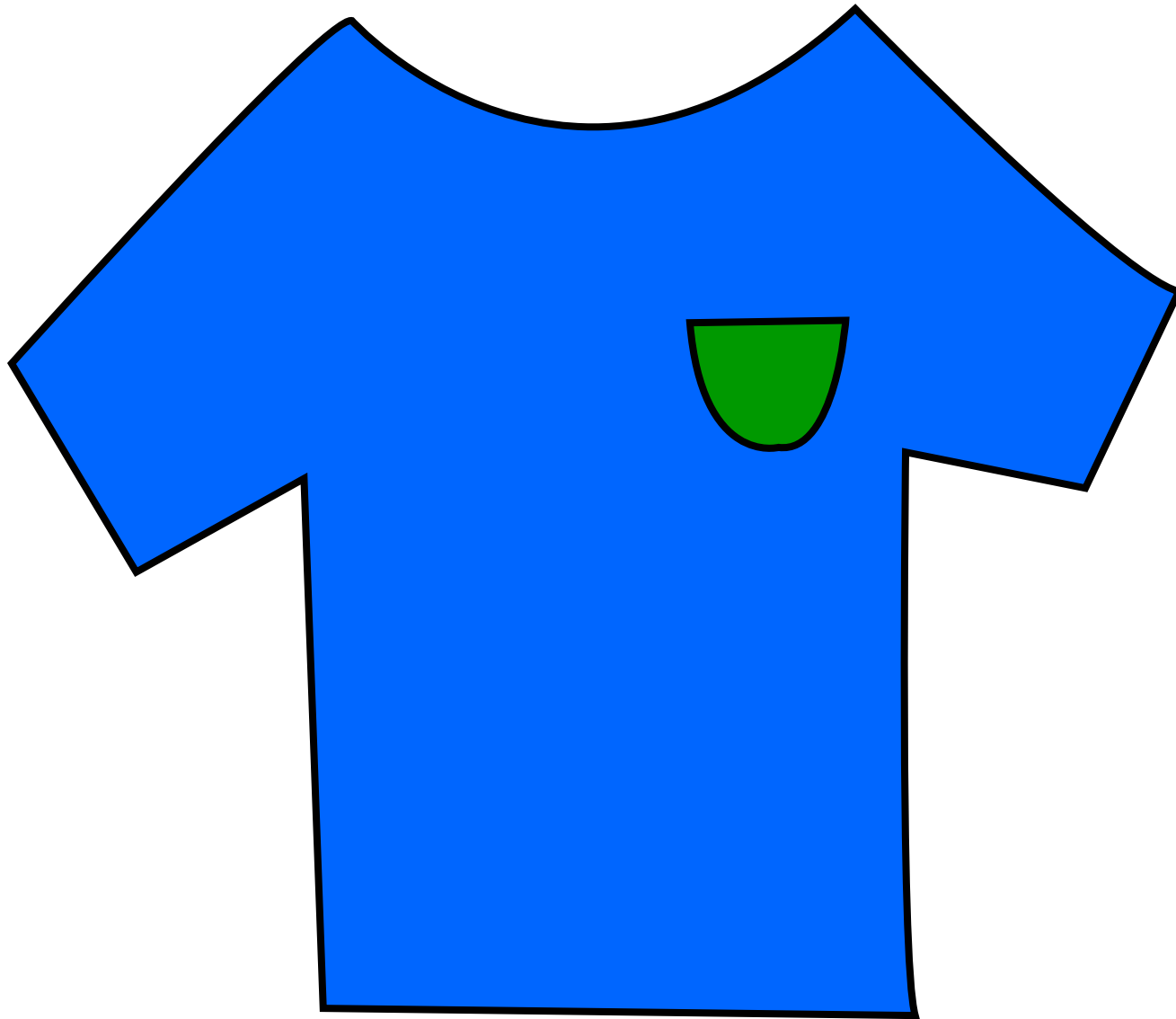

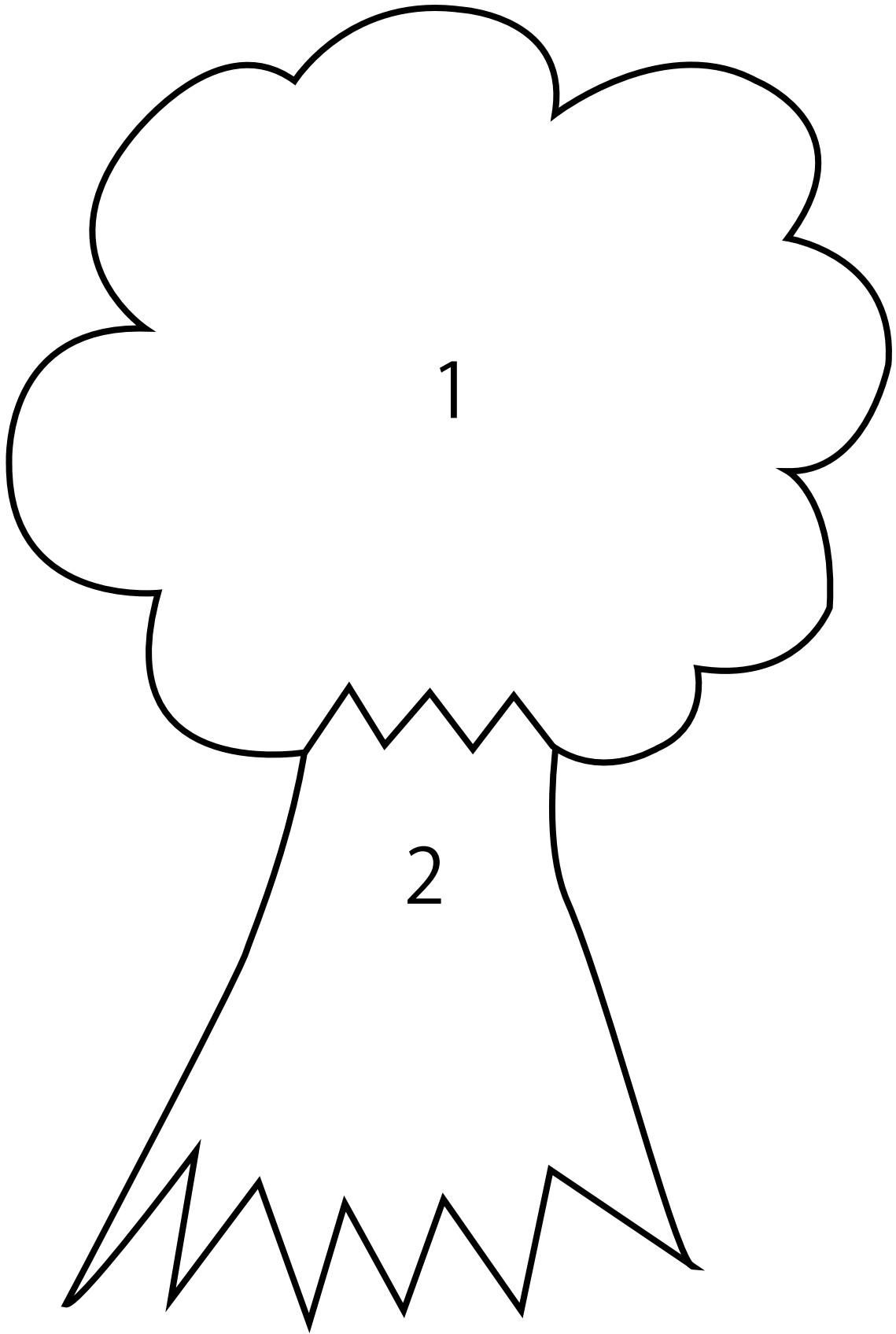

1.green

2.brown

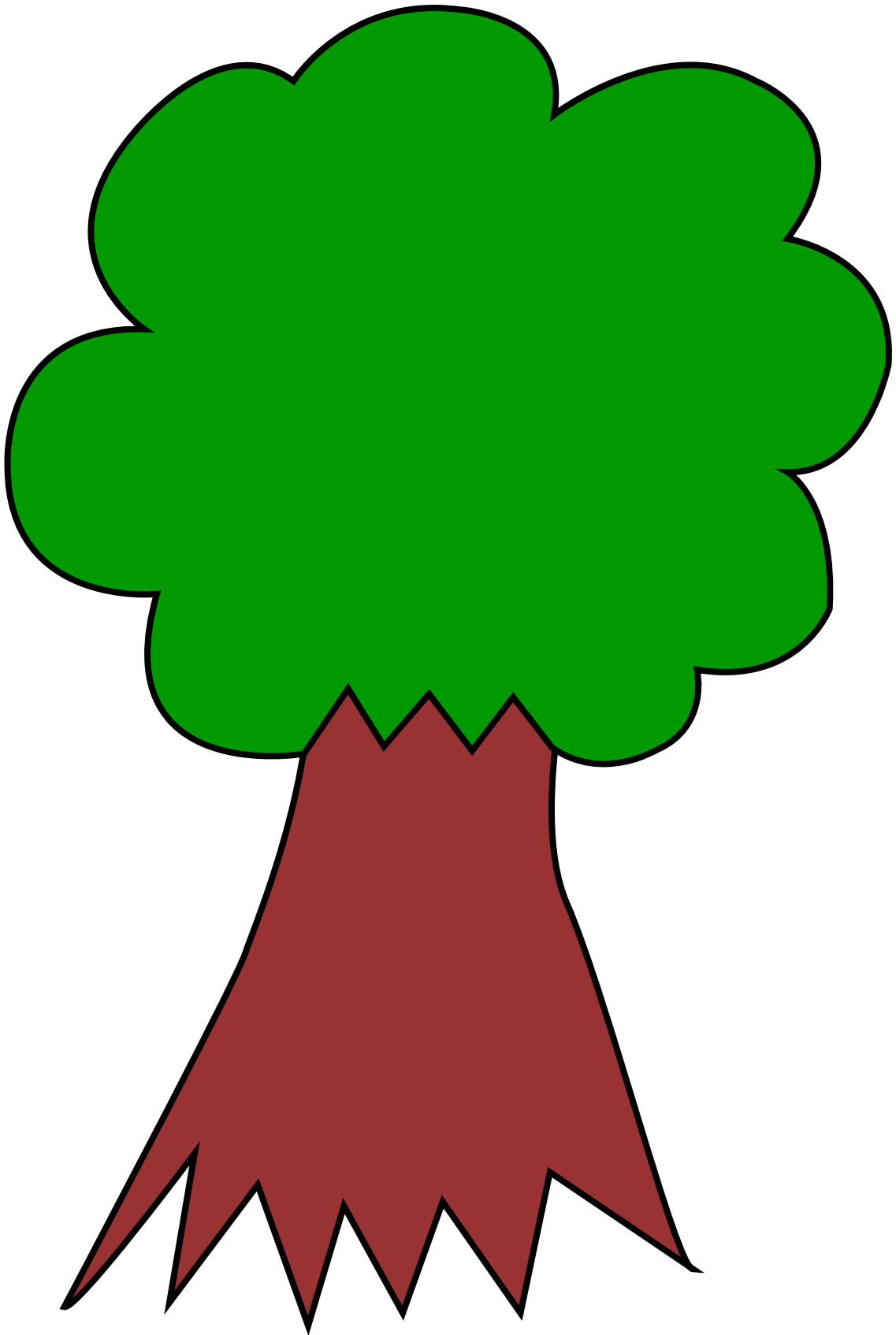

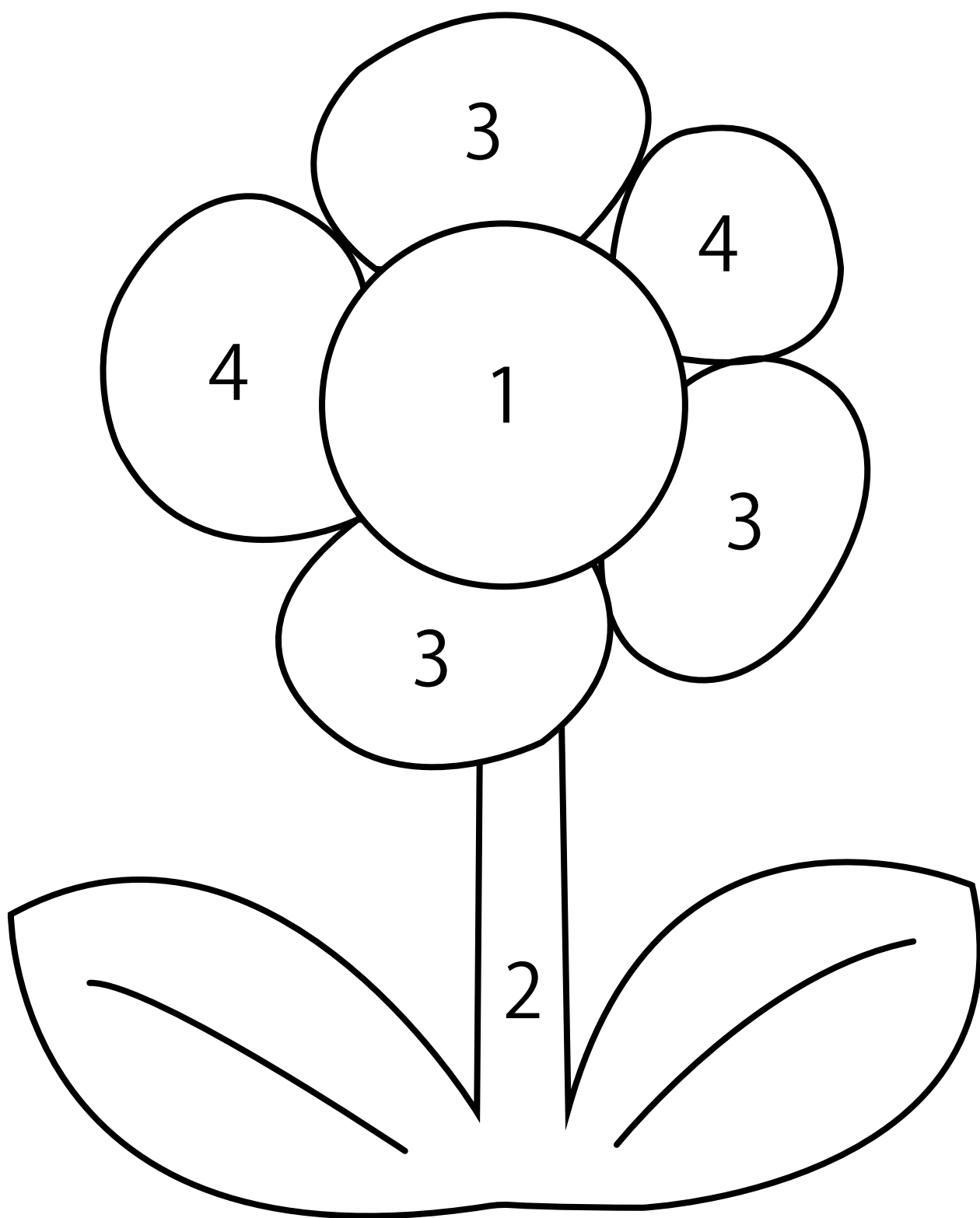

1.yellow

2.green

3.pink

4.orange

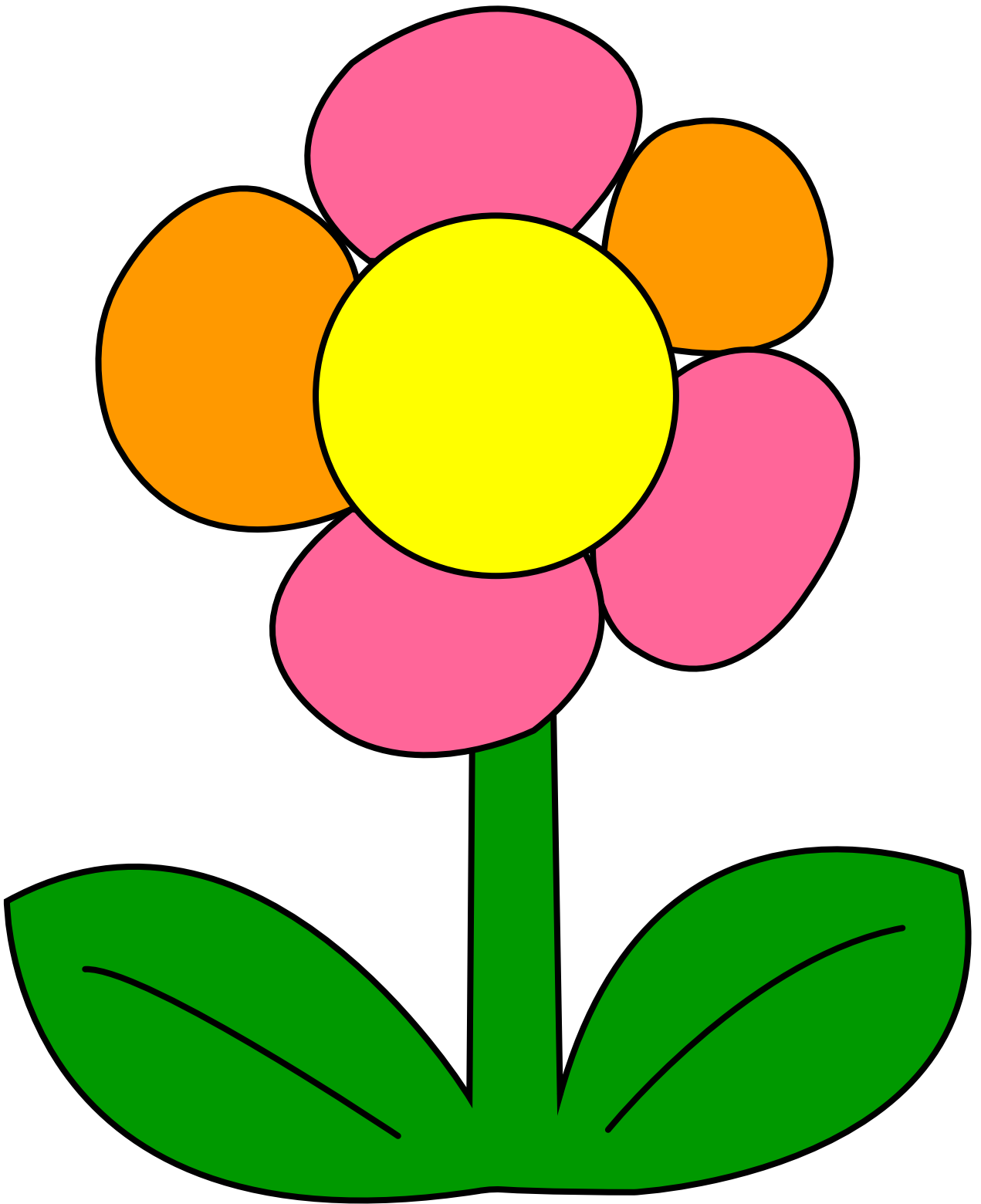

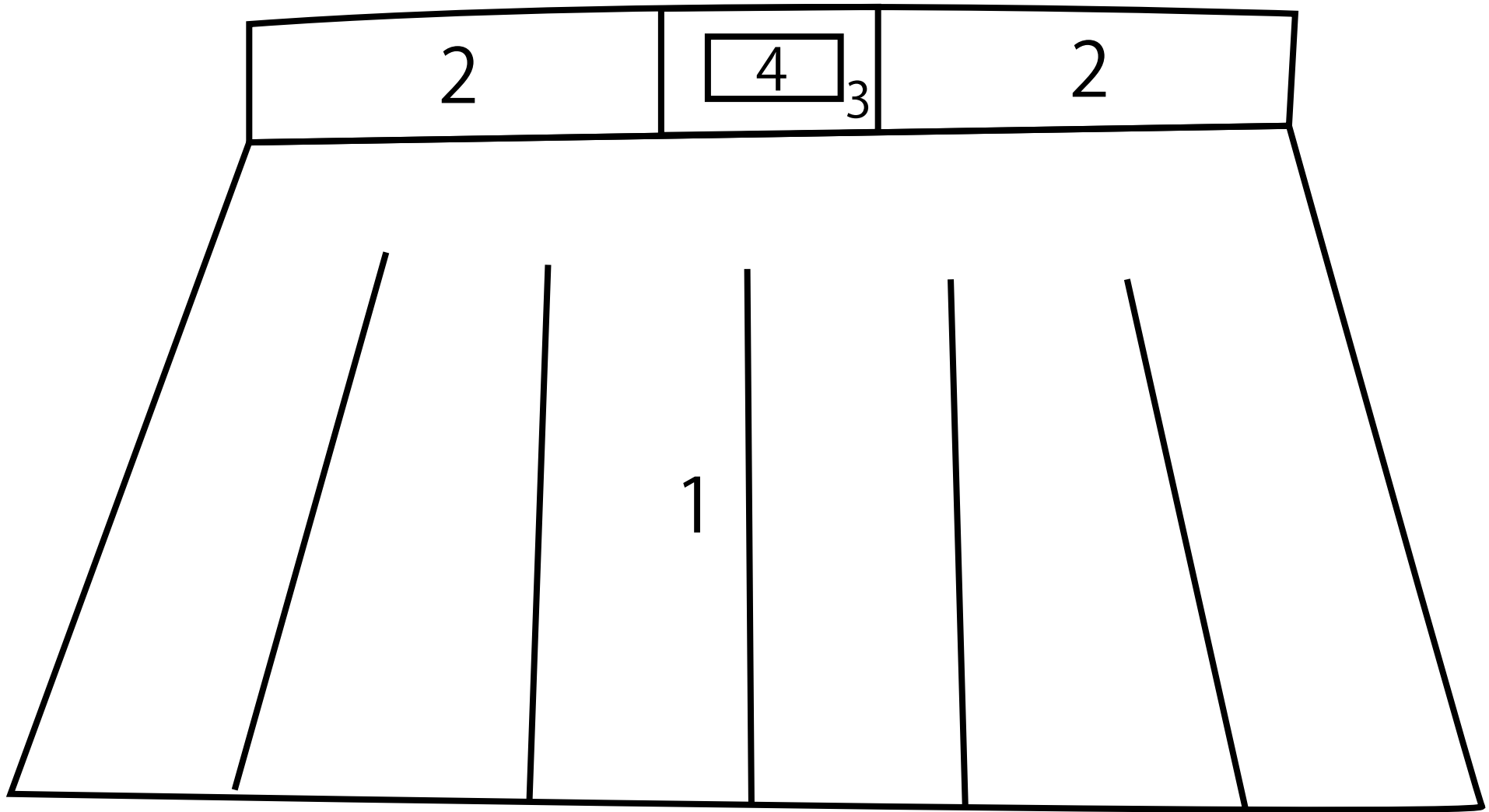

1.pink

2.orange

3.yellow

4.brown

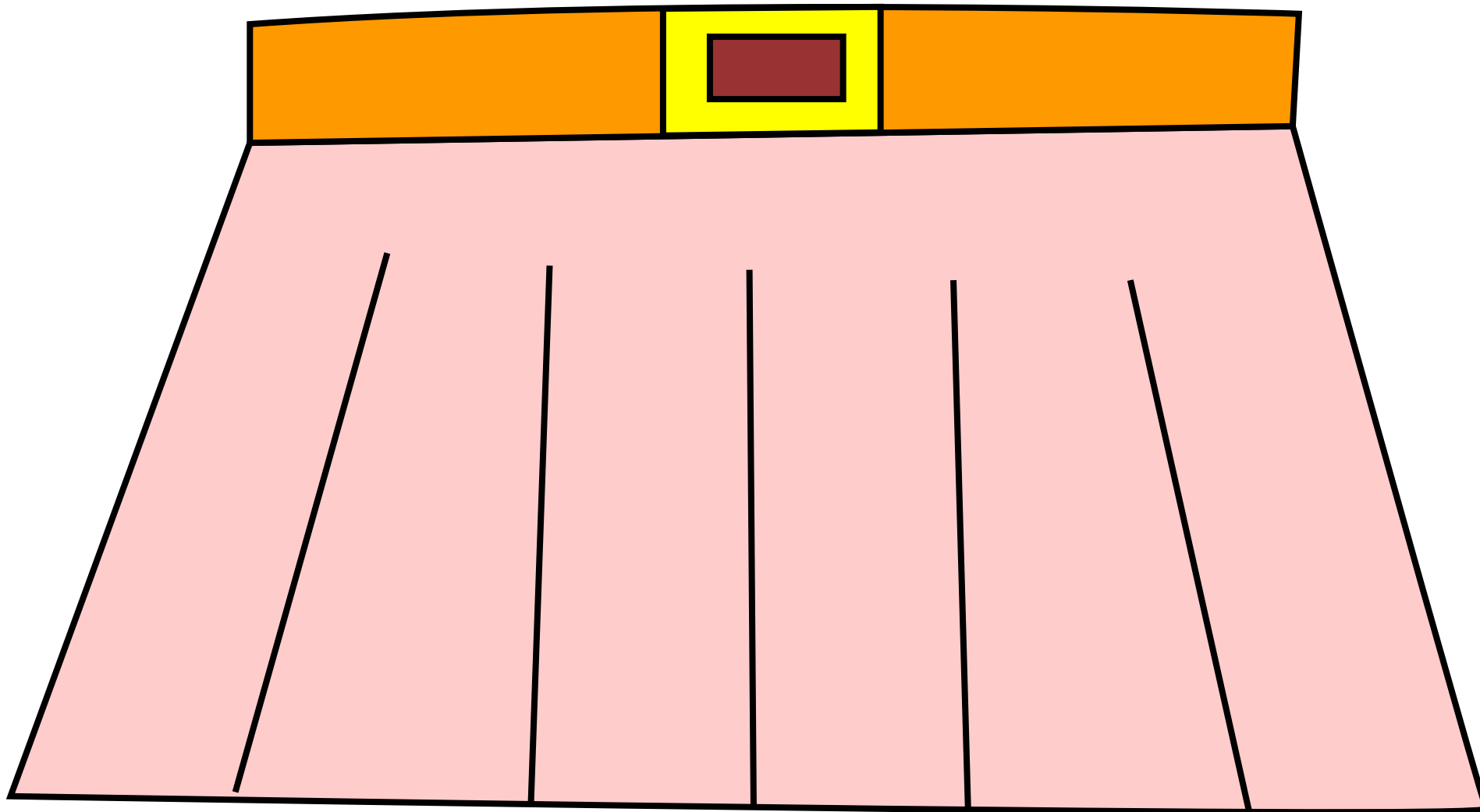

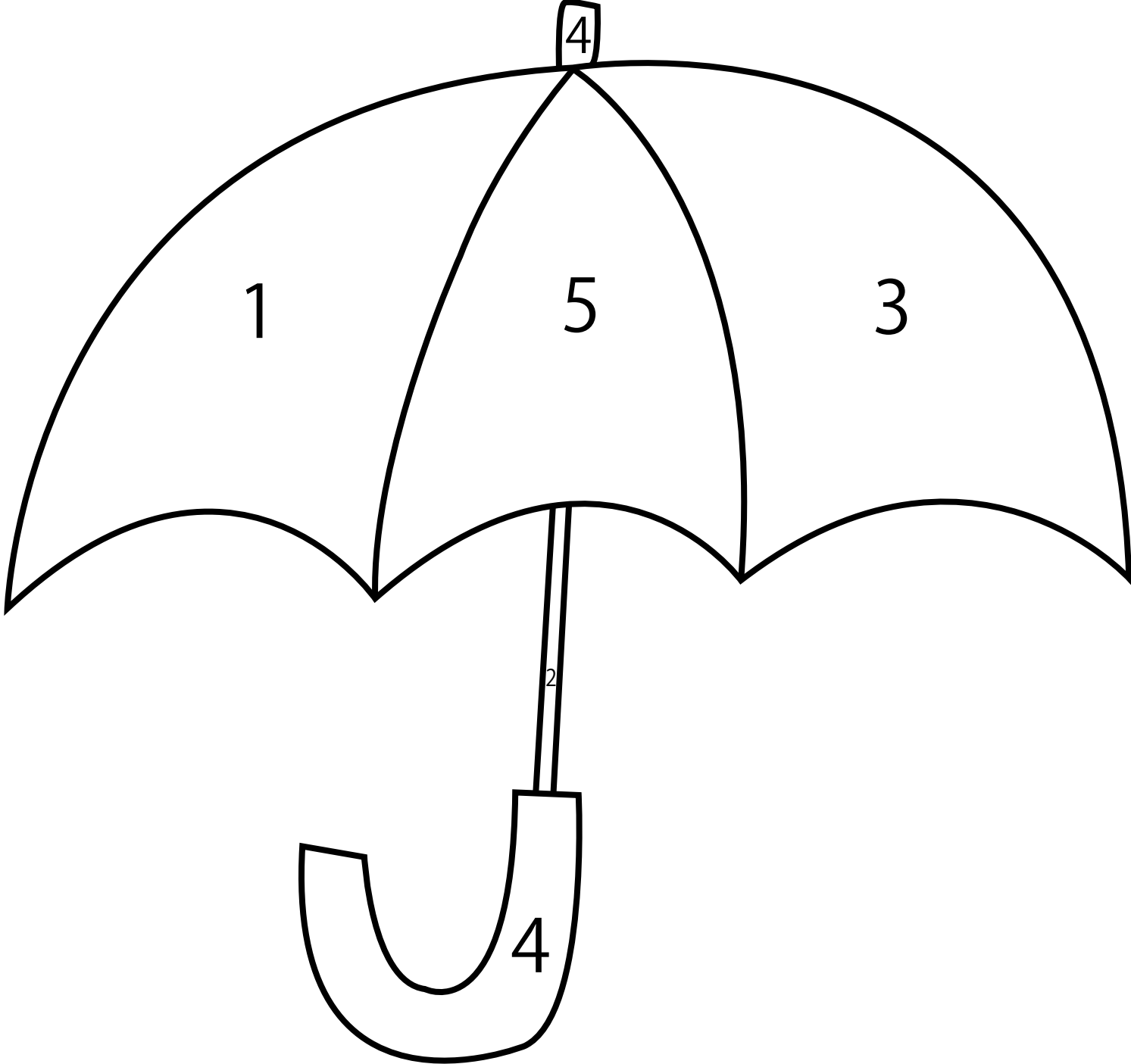

1.red

2.white

3.blue

4.yellow

5.green

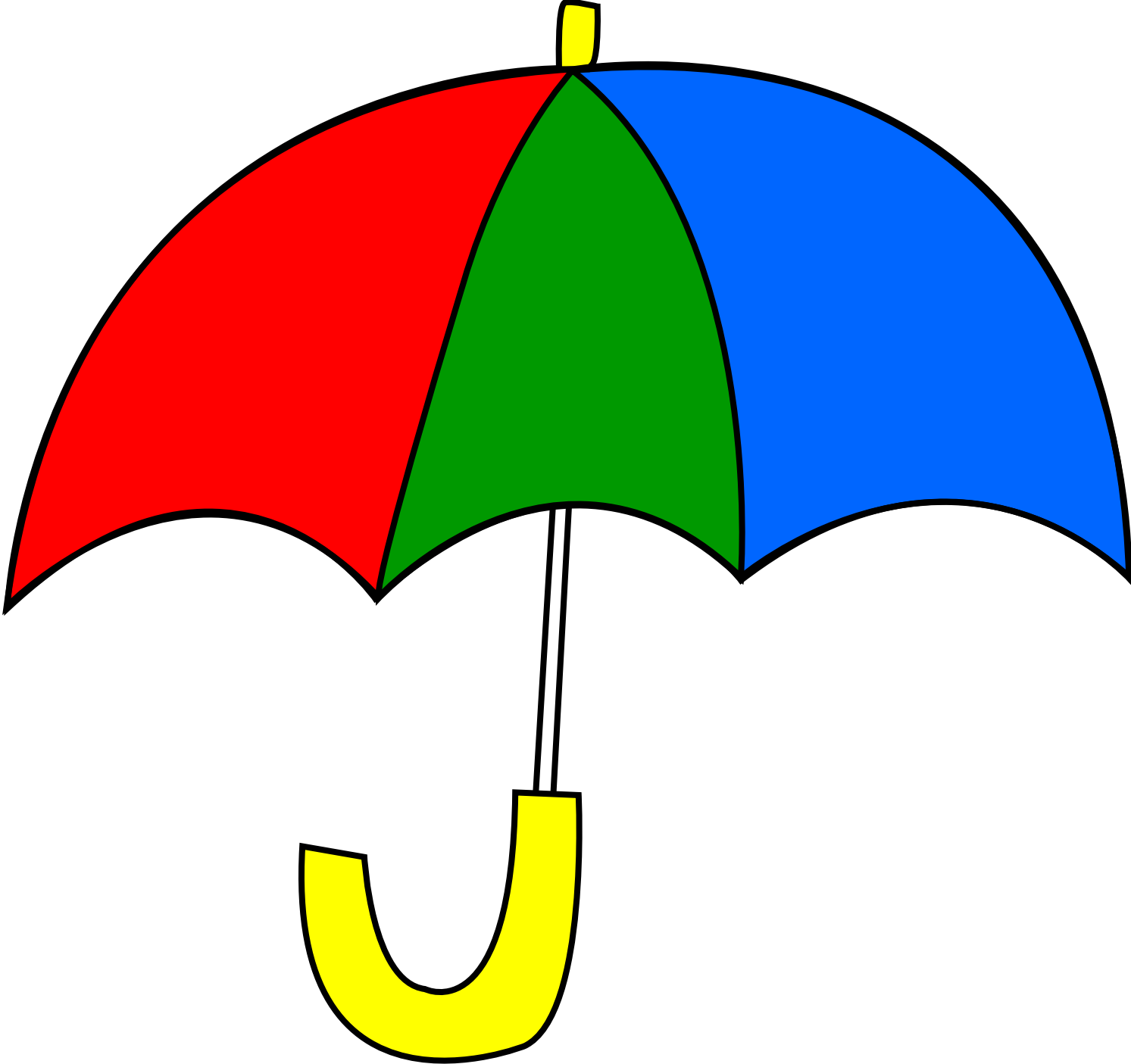

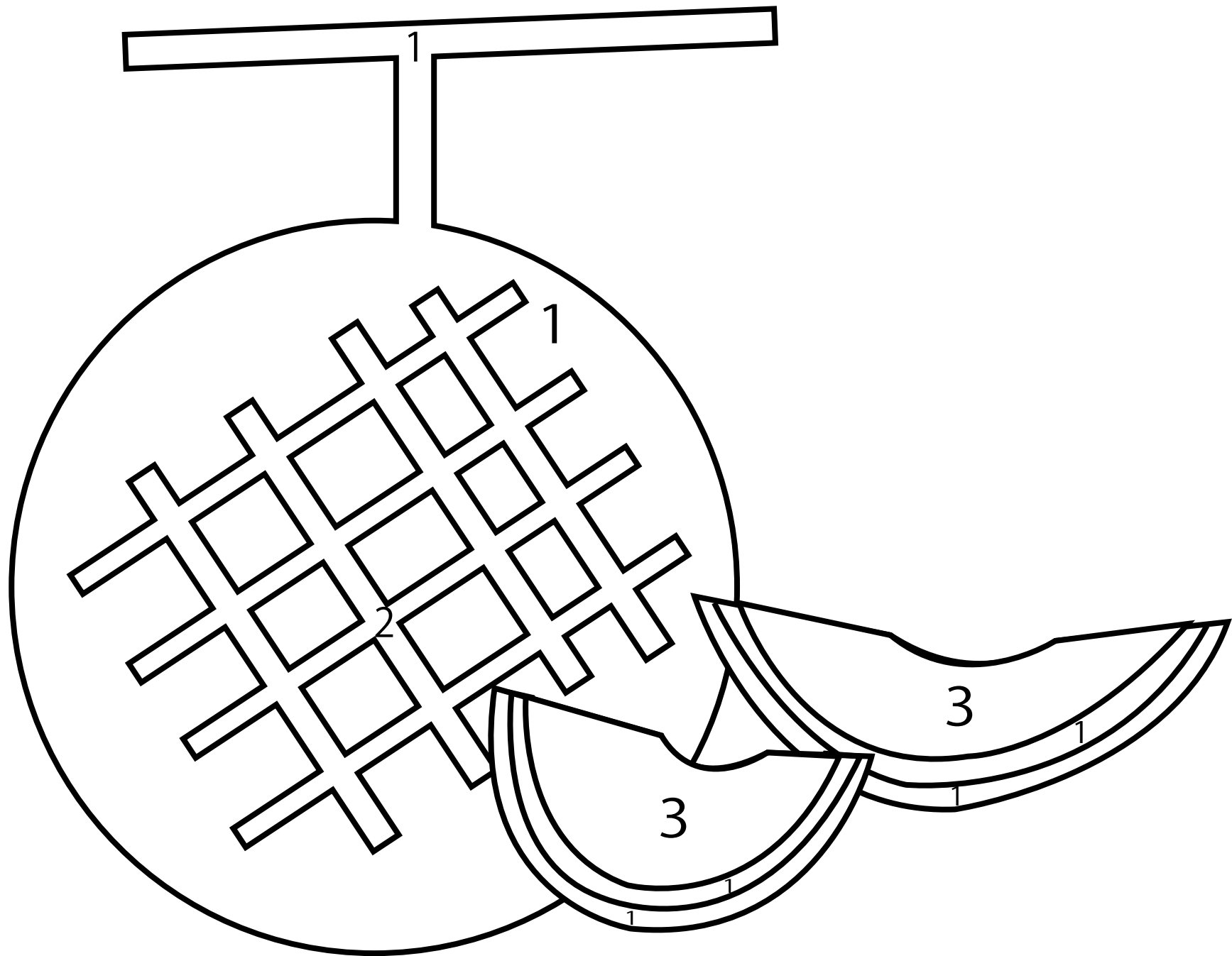

1.green

2.yellow

3.orange

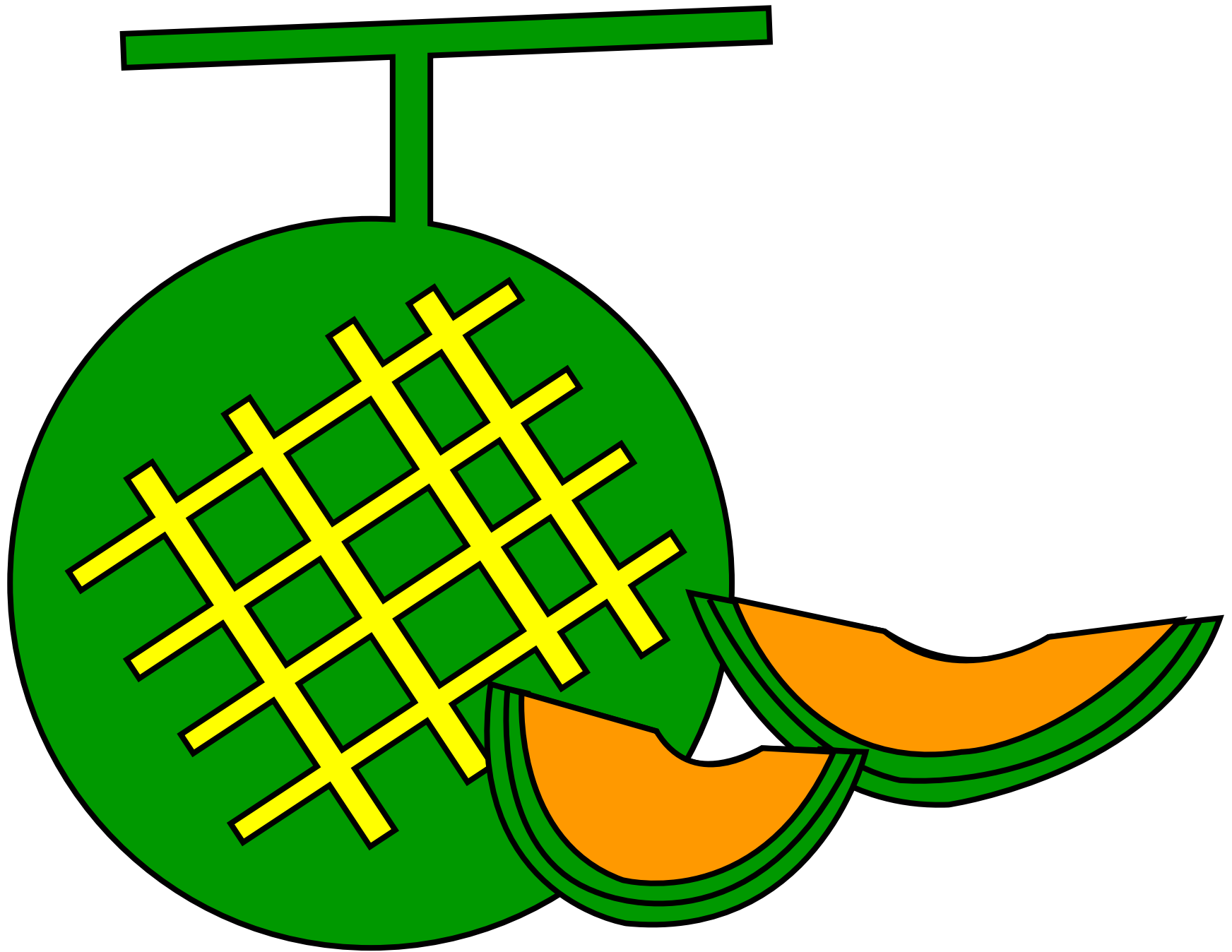

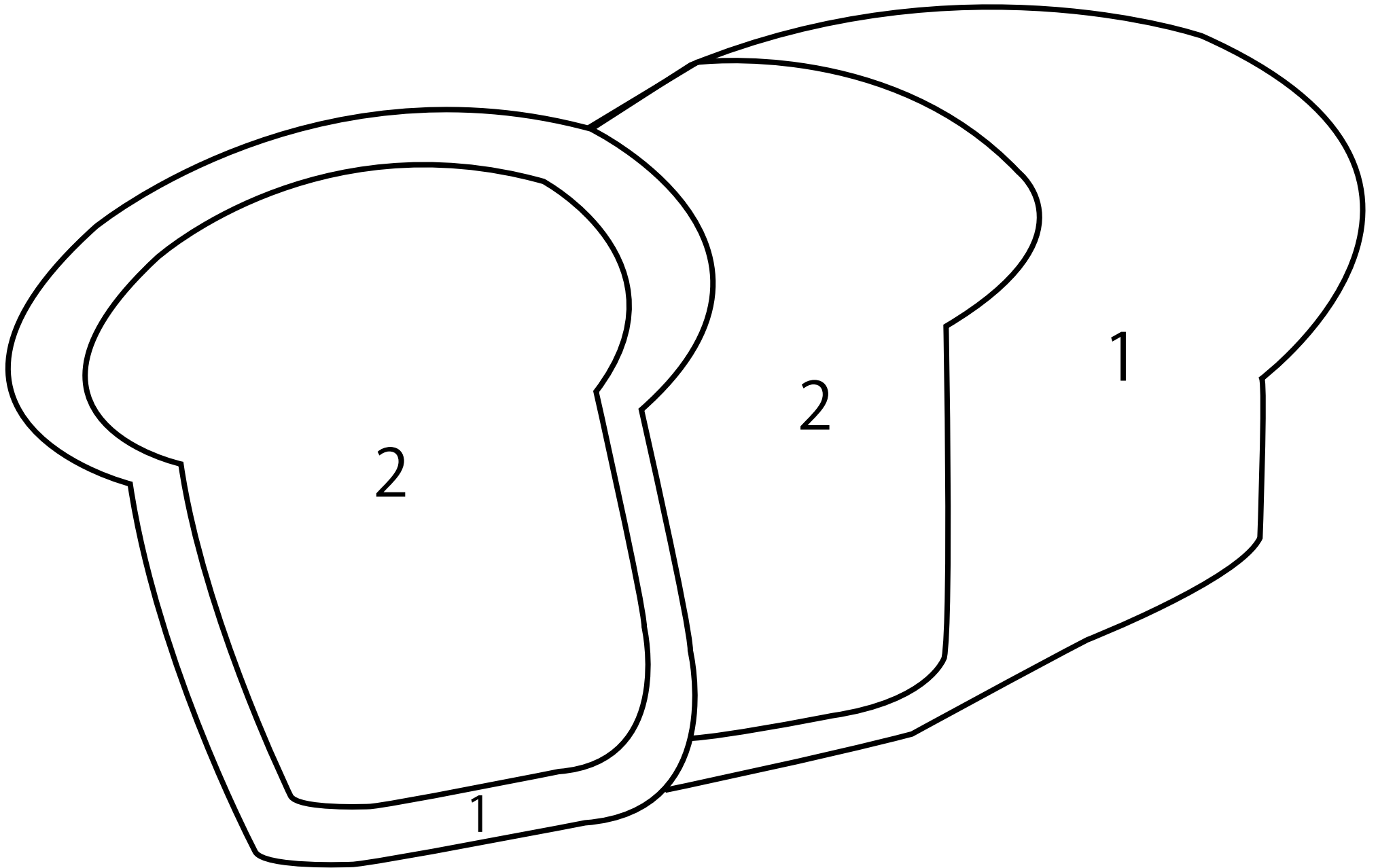

1.brown

2.white

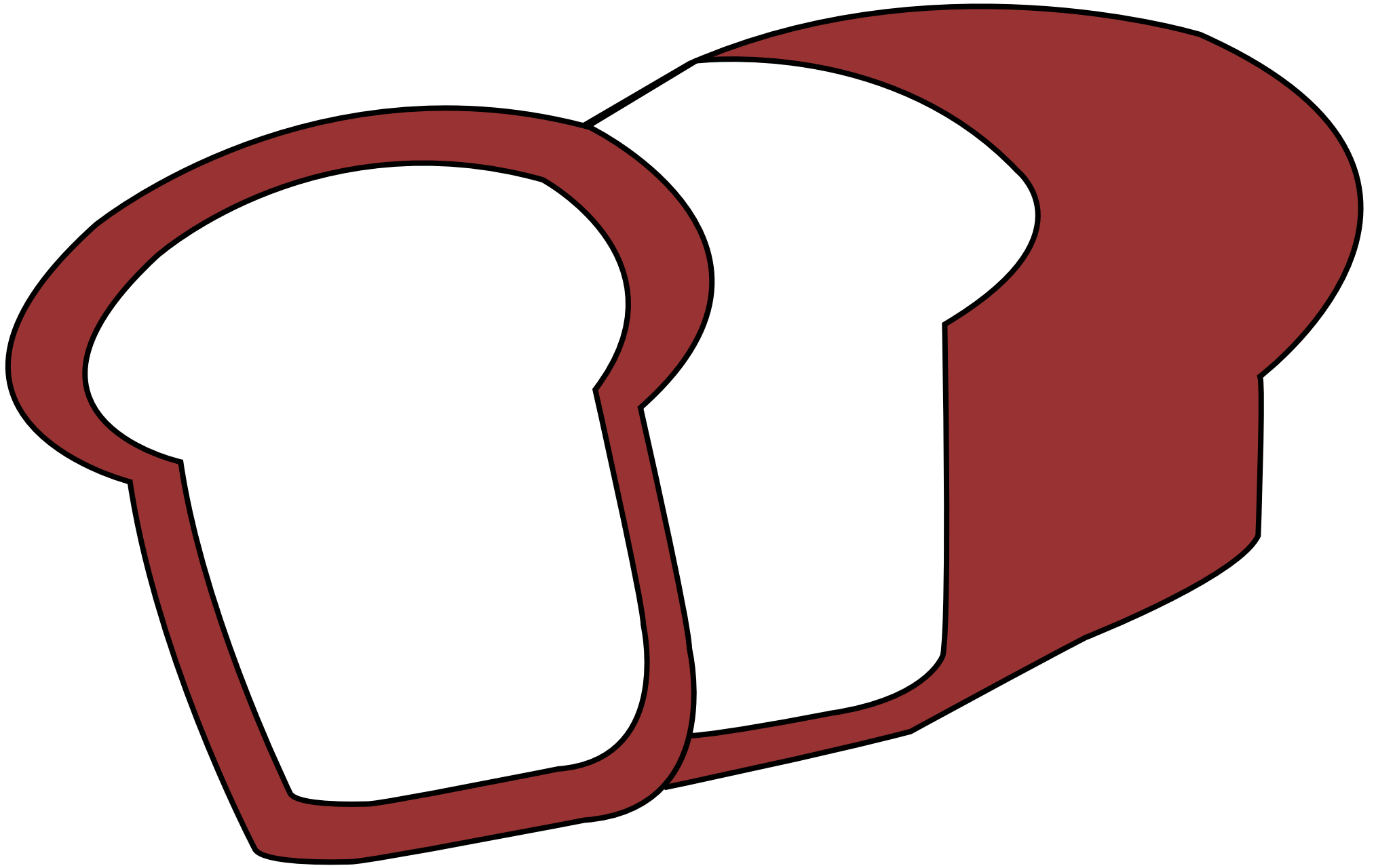

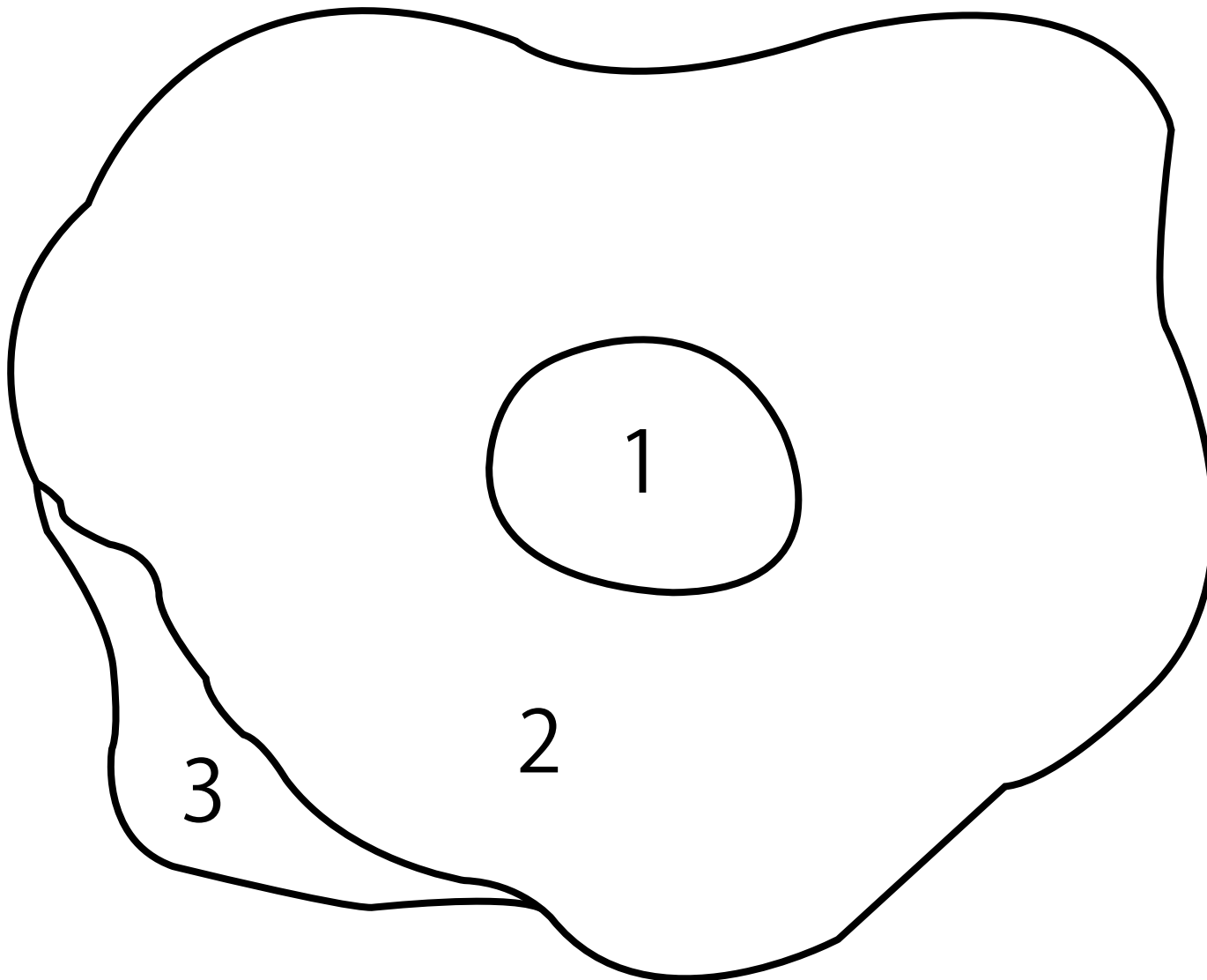

1.yellow

2.white

3.brown

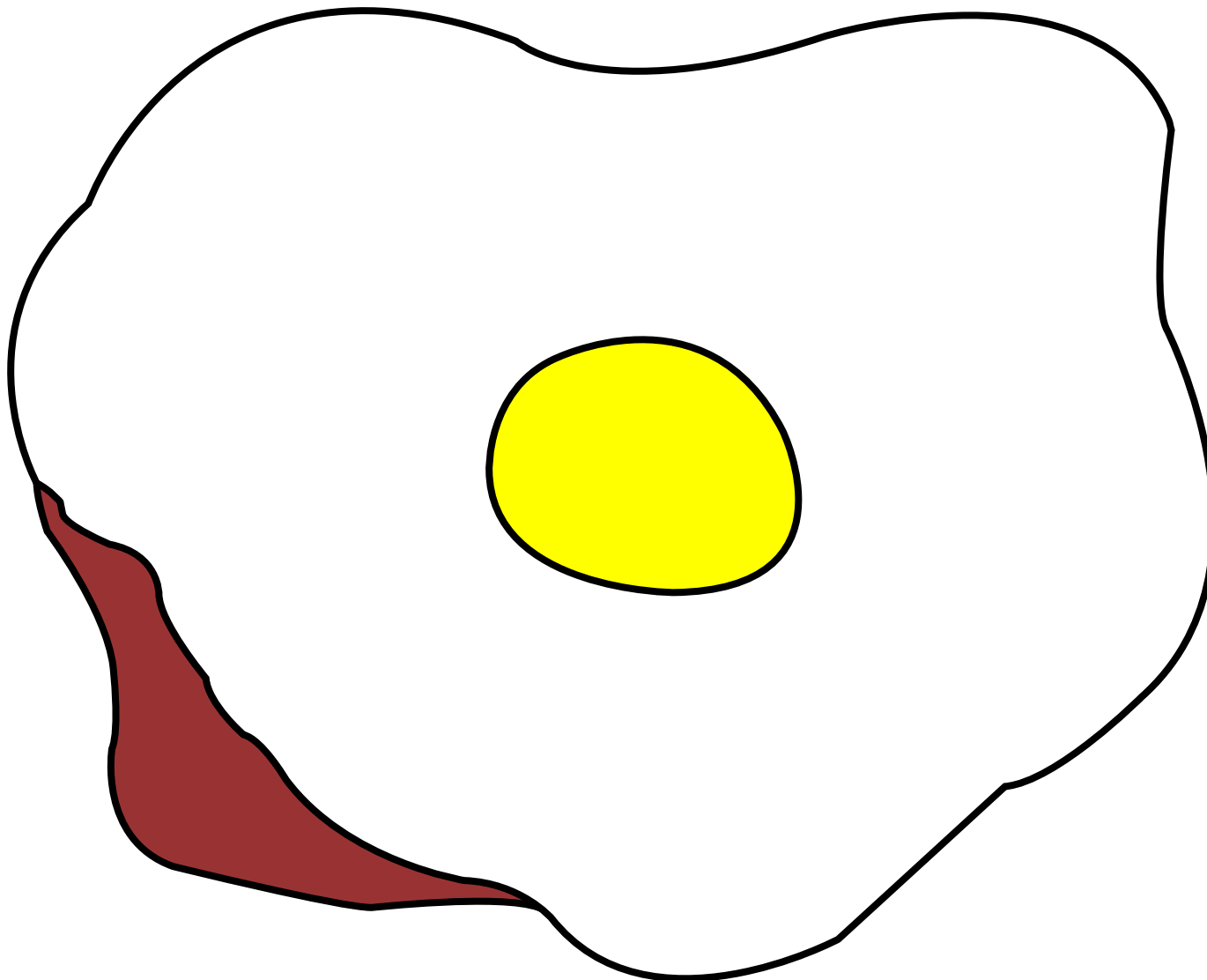

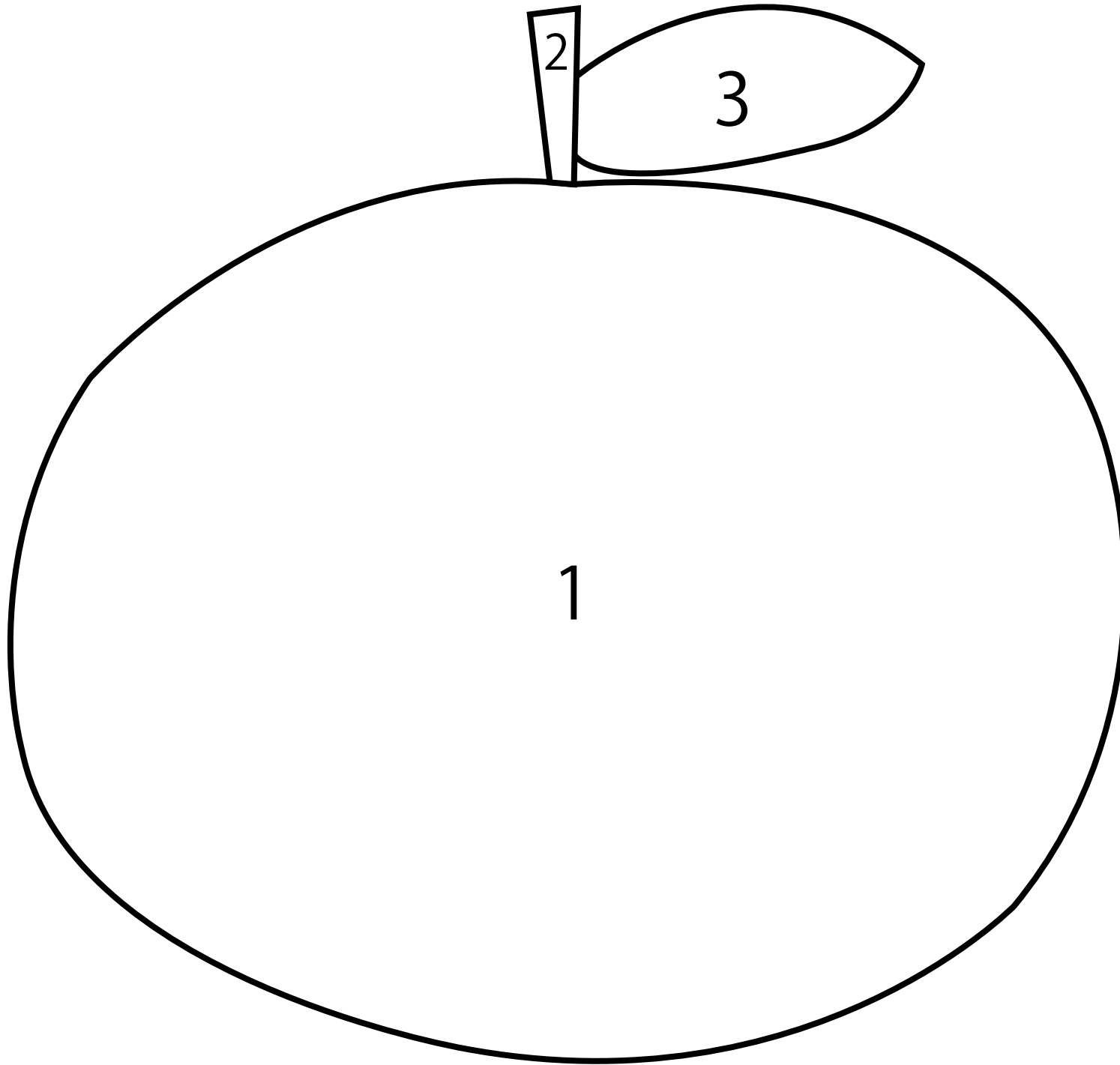

1.orange

2.brown

3.green

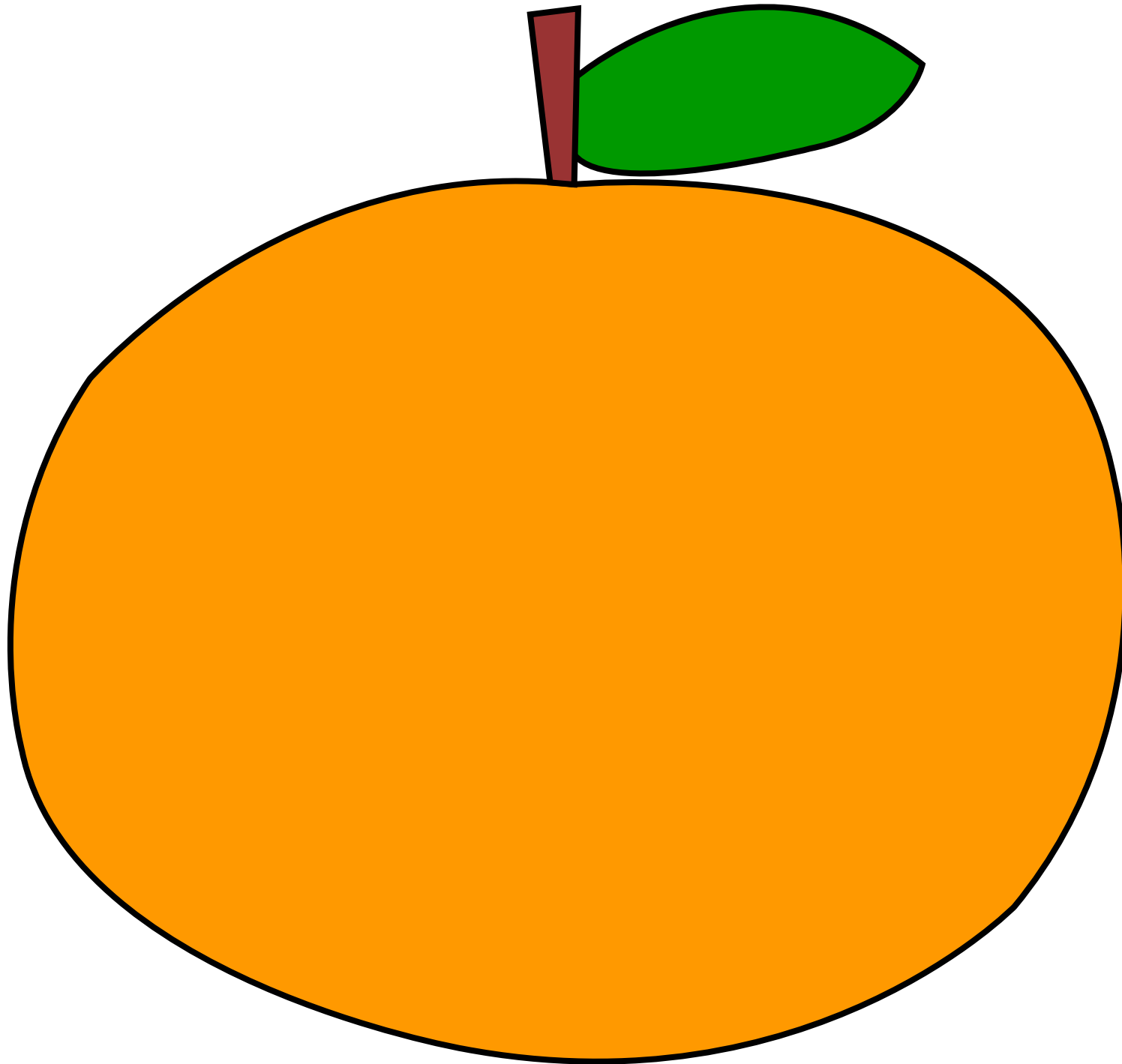

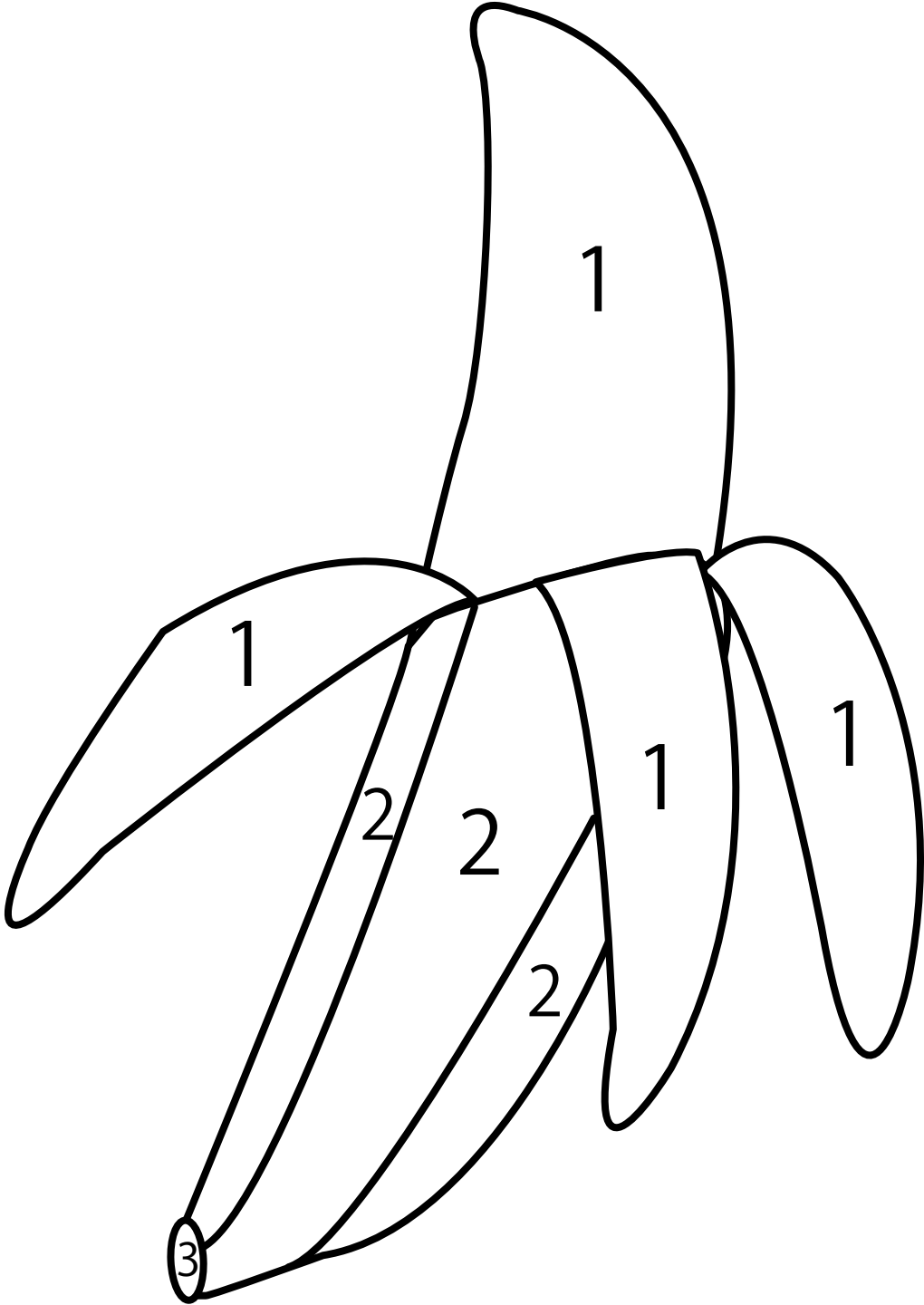

1.white

2.yellow

3.brown

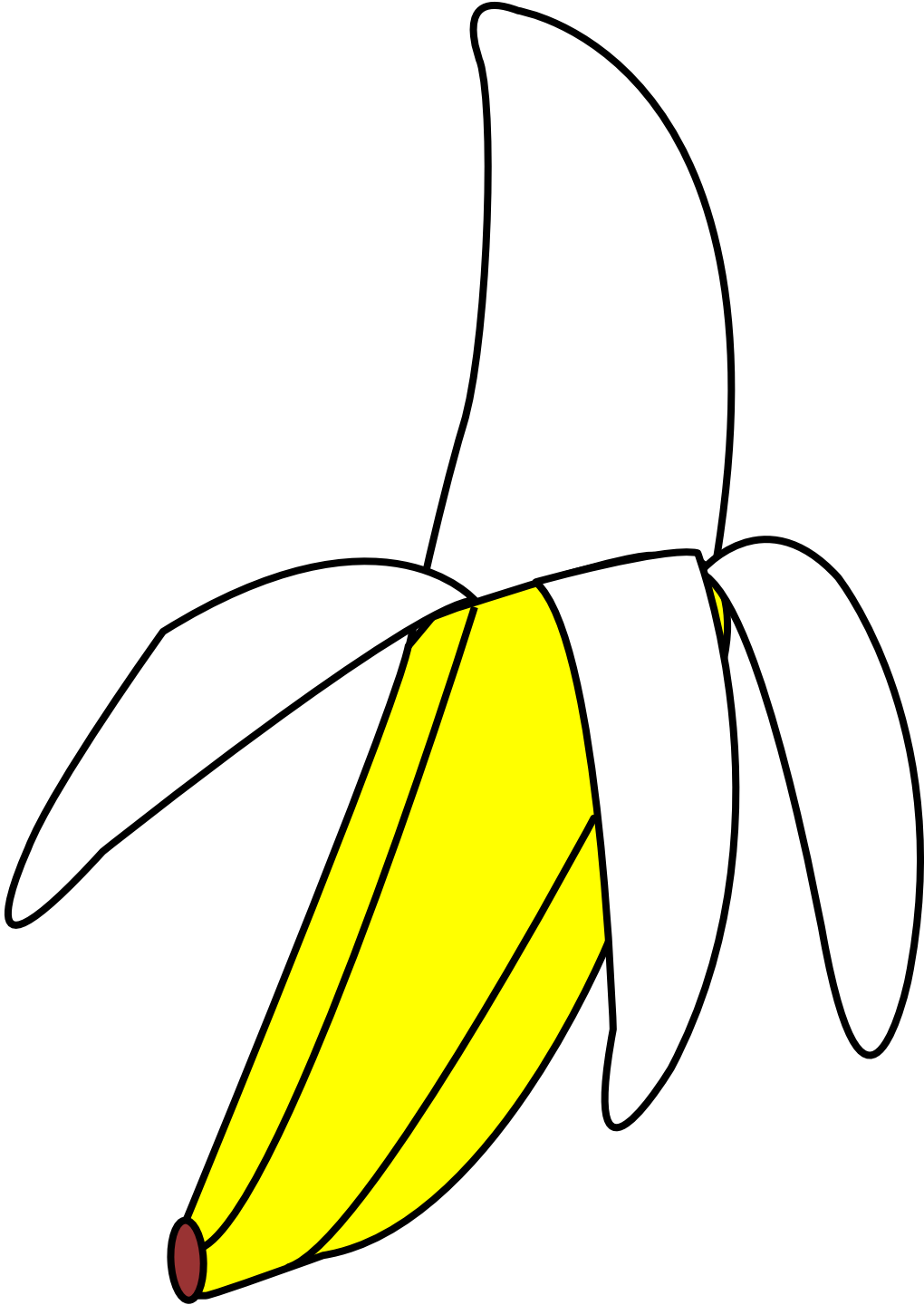

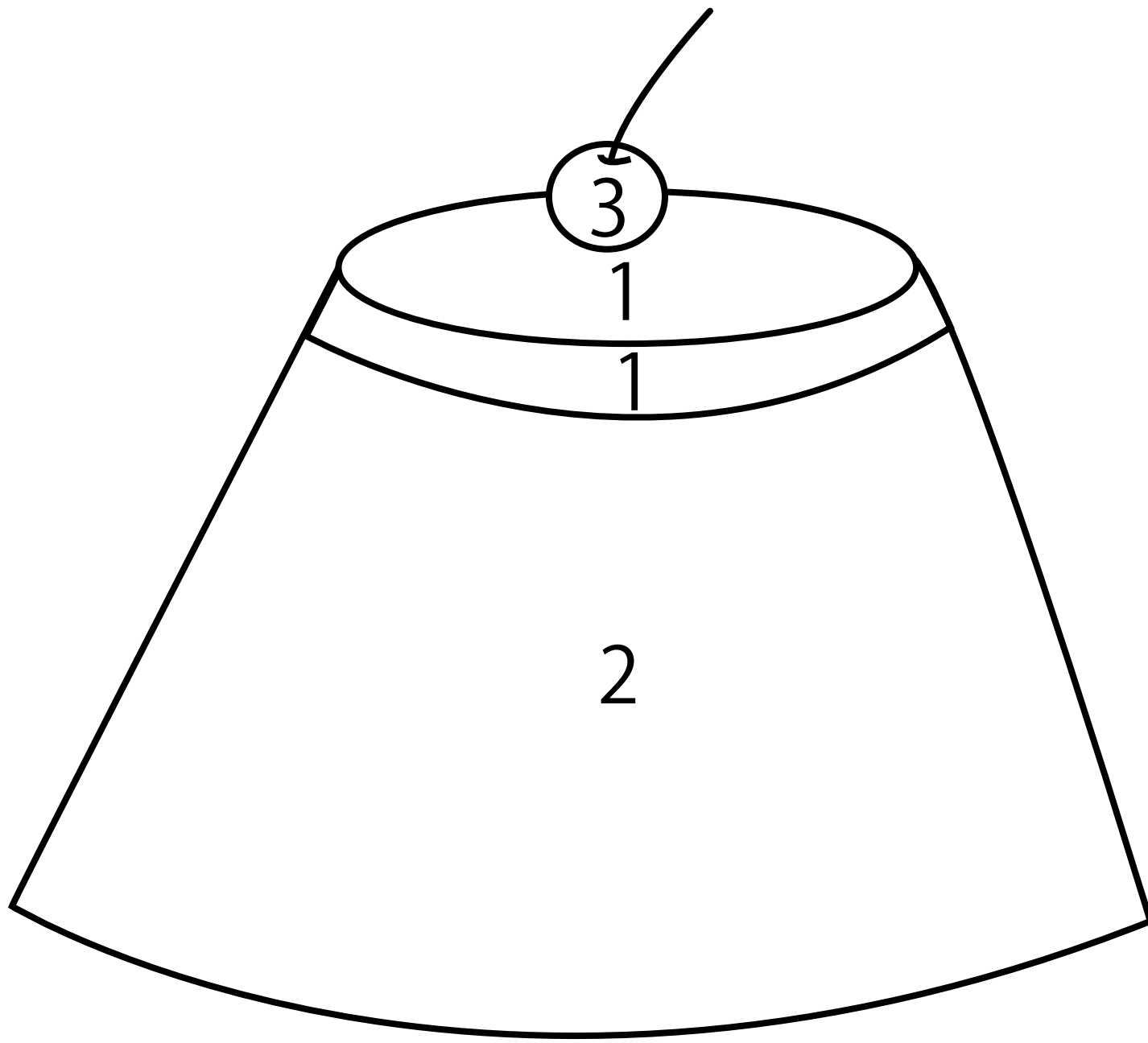

1.brown

2.yellow

3.red

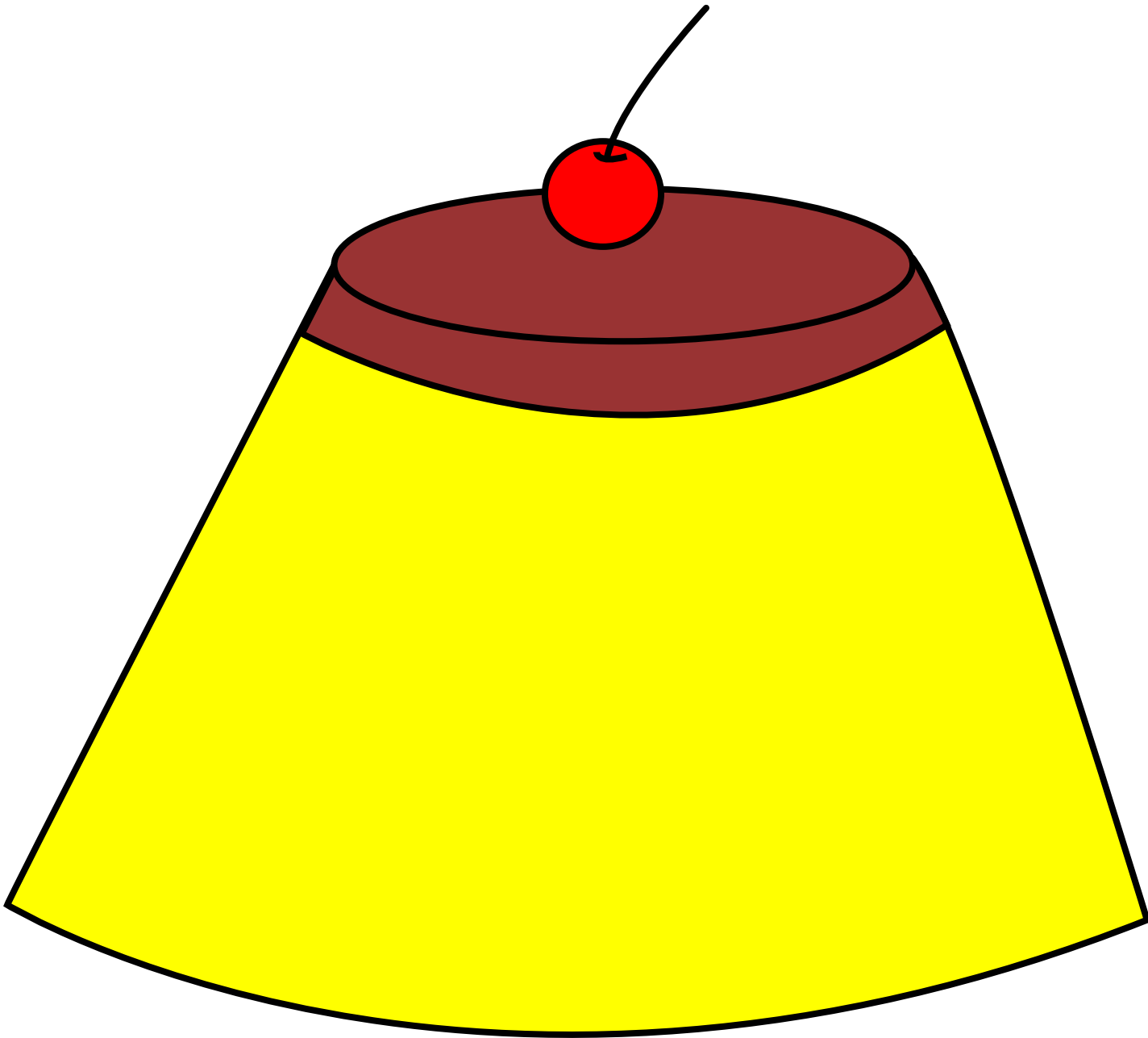

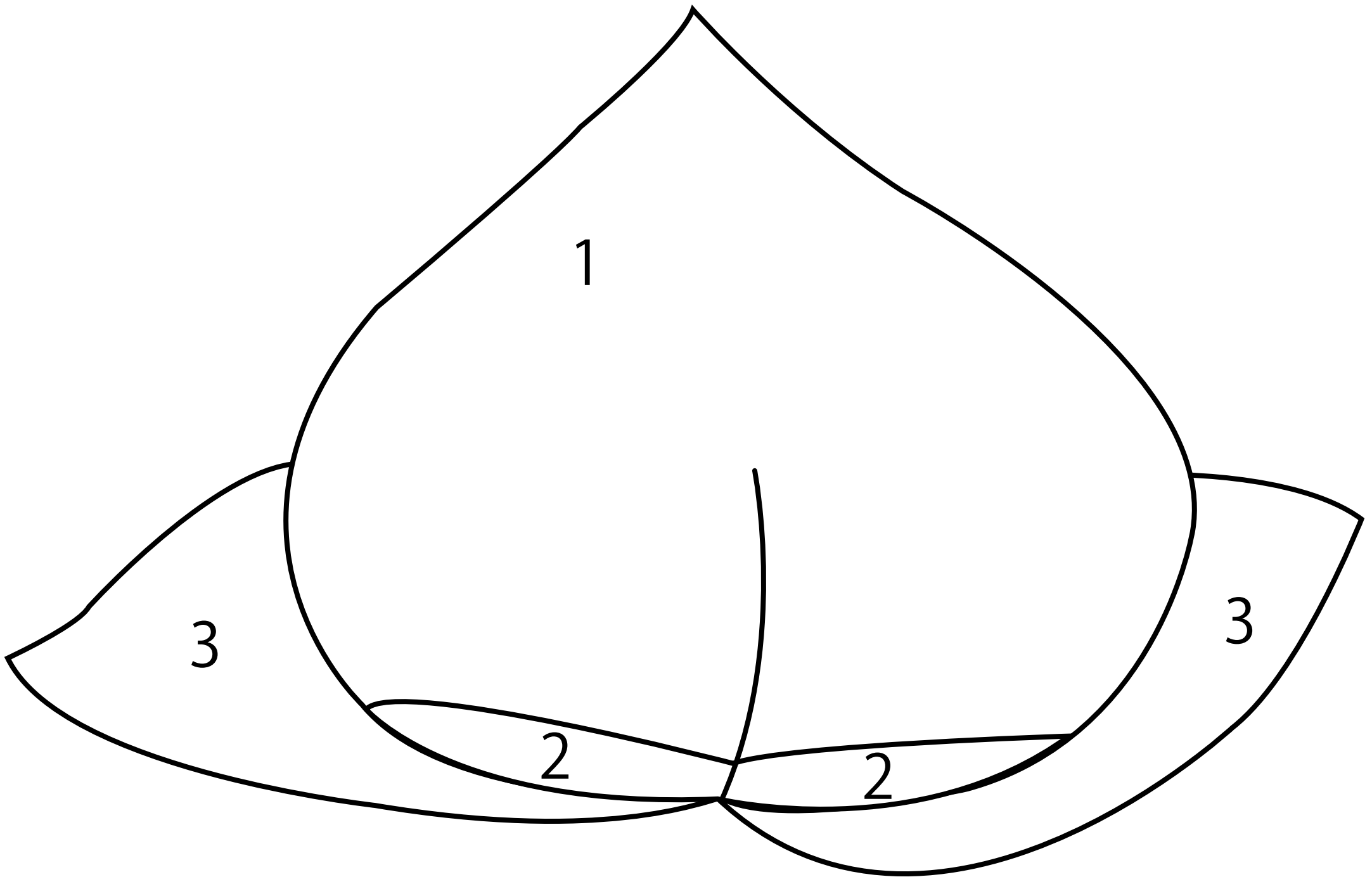

1.pink

2.yellow

3.green

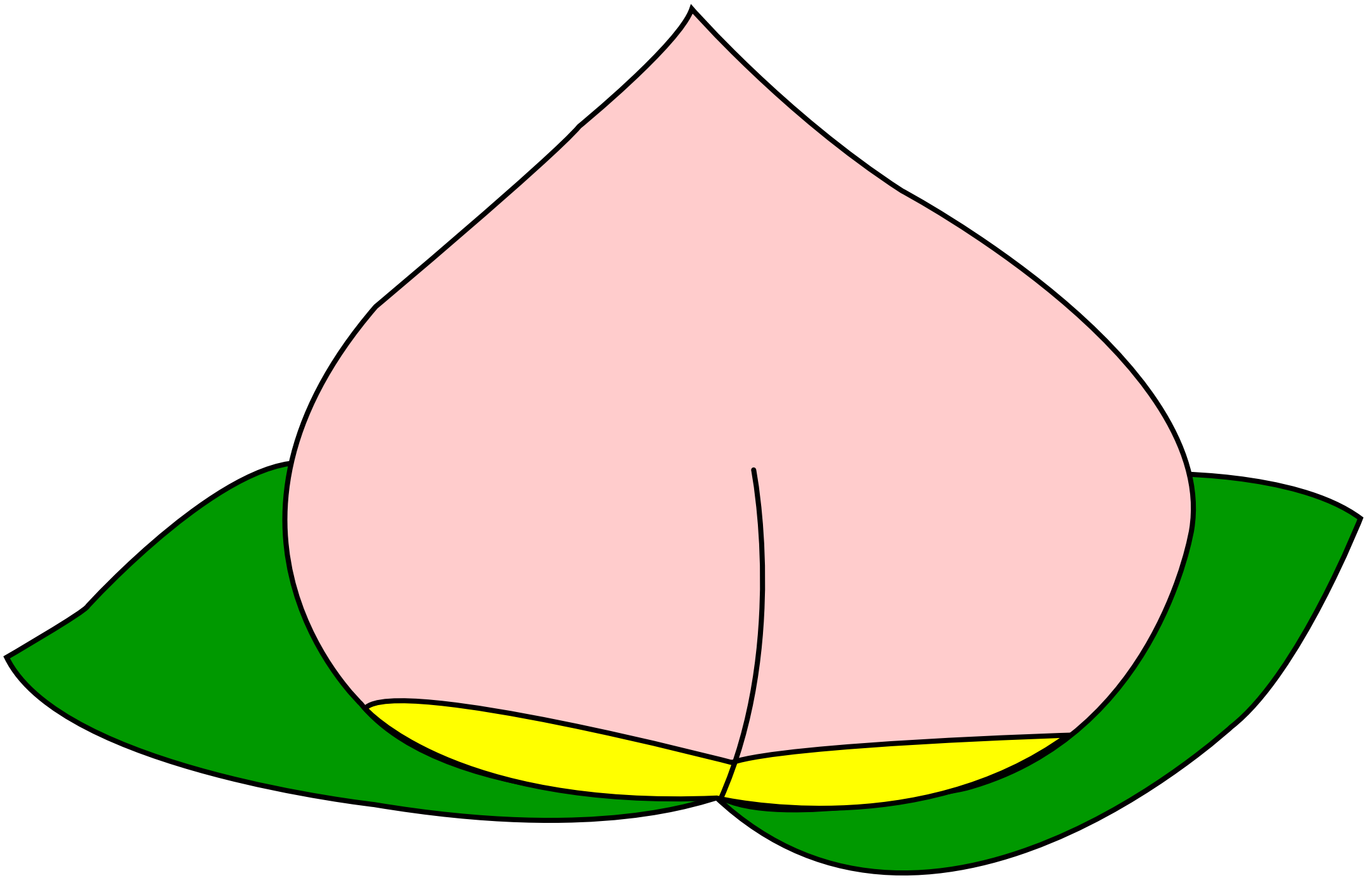

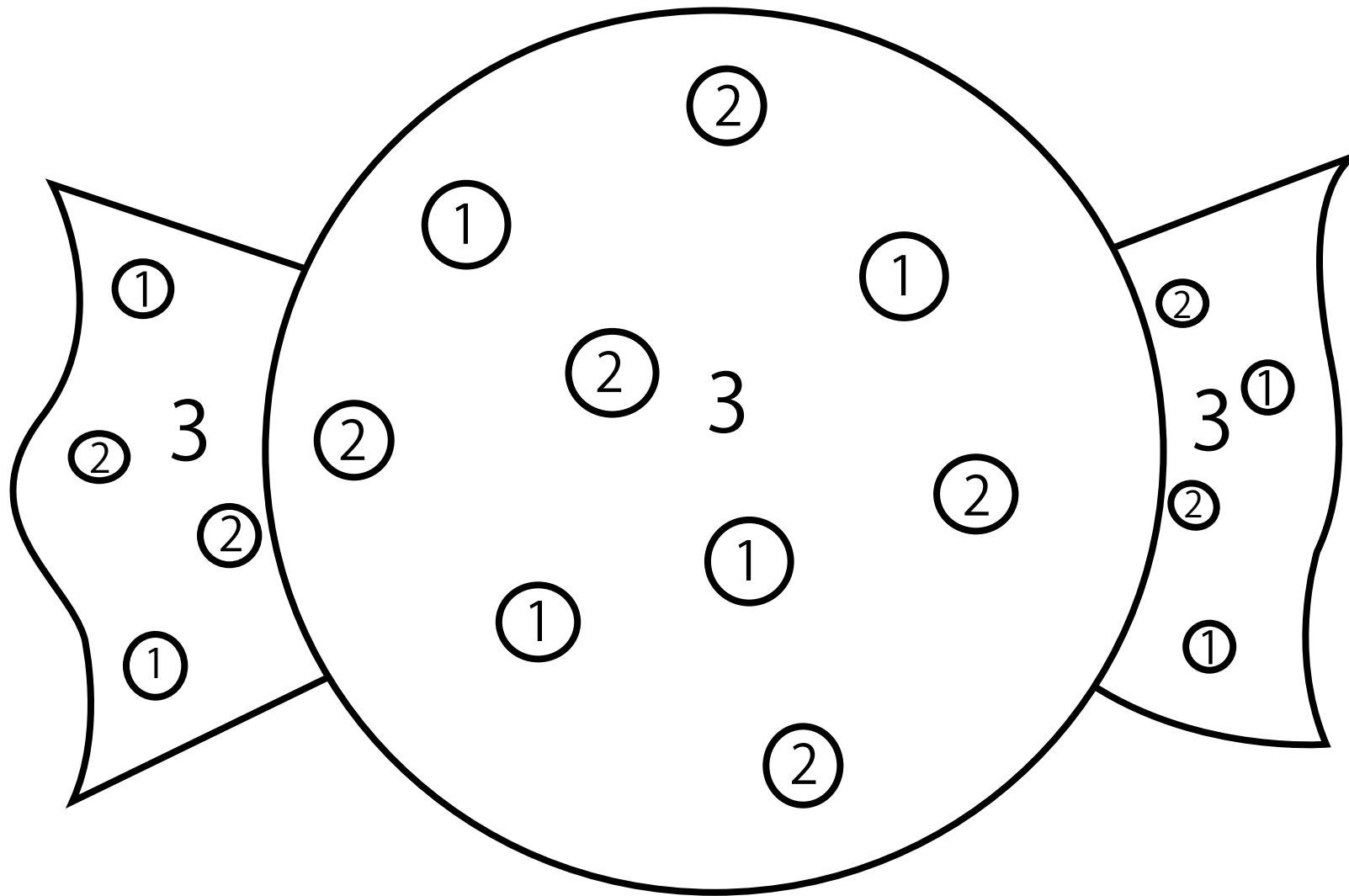

1.orange

2.pink

3.blue

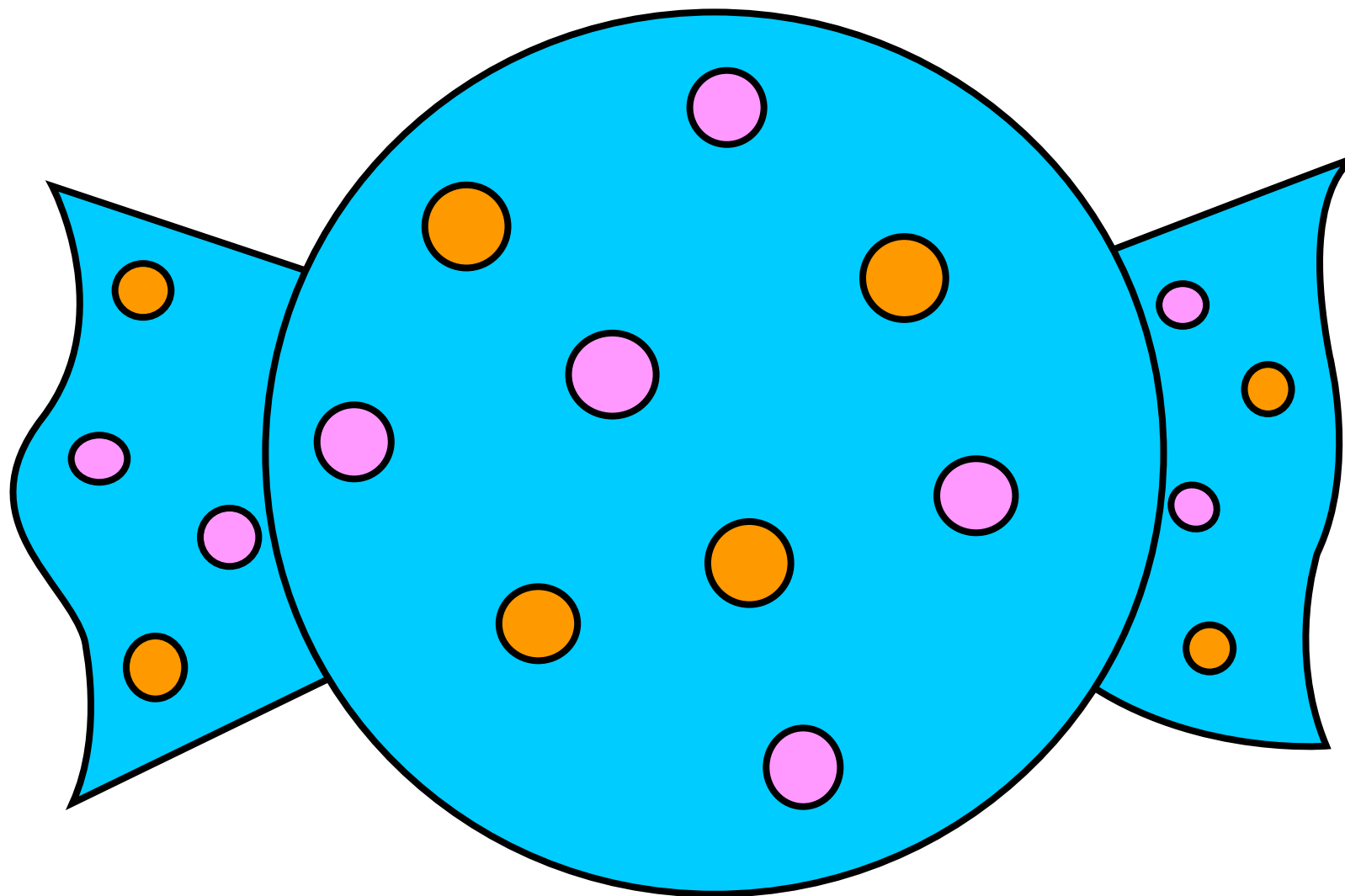

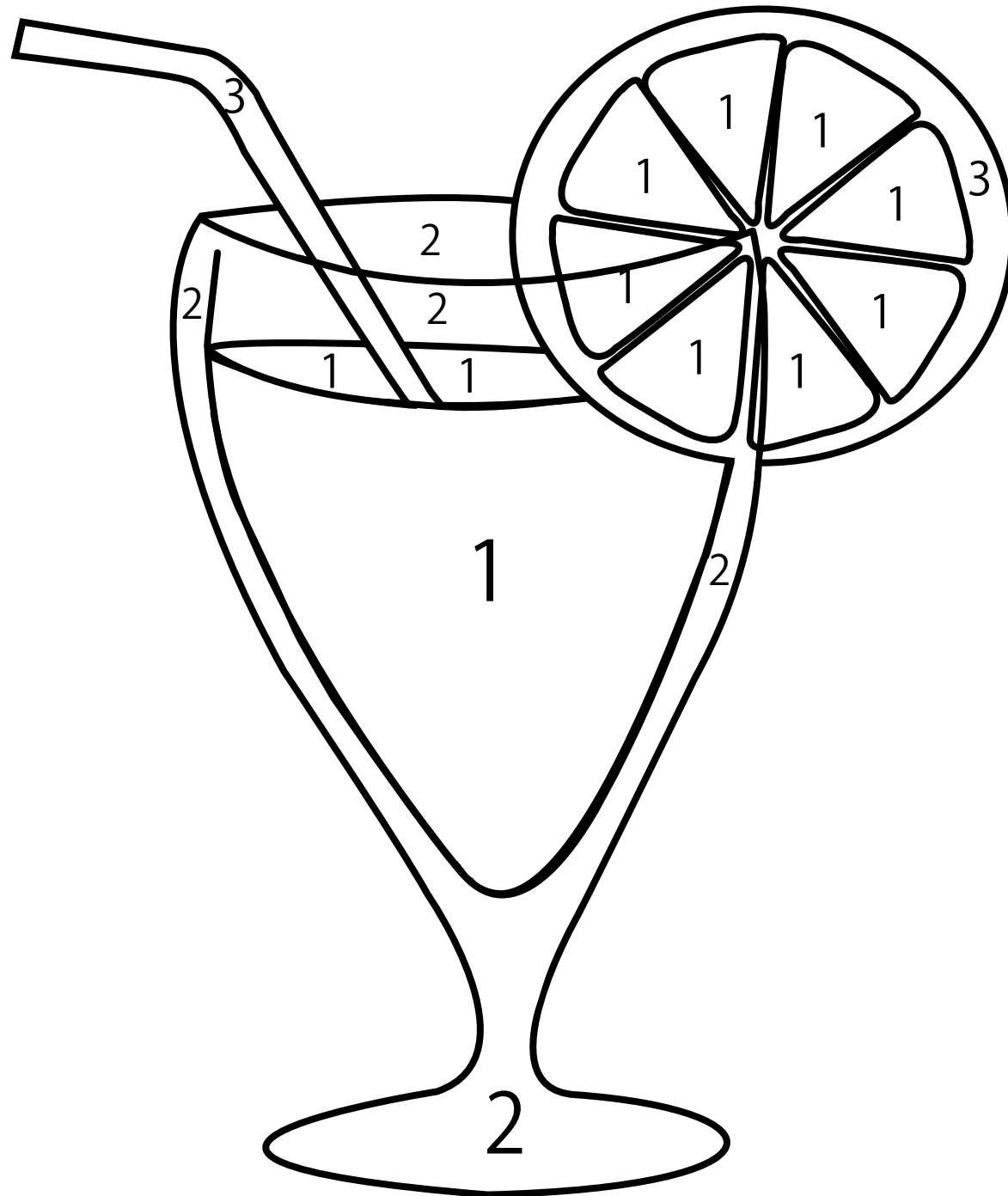

1.orange

2.blue

3.white

