

AsiaSat: A Real-World Case in Solving a Problem with BPF Installation

AsiaSat Engineering Department – White Paper

HU Hai, Senior Communications Systems Engineer, AsiaSat

April 2020

1. Introduction

Recently, the accelerated 5G cellular network rollout in the Asia-Pacific region has speeded up the installation and use of 5G rejection bandpass filters (BPF) for satellite television receive-only (TVRO) antenna systems. In Hong Kong alone, more than one thousand C-band TVRO antenna systems or satellite master antenna television (SMATV) systems need to be upgraded with 5G rejection BPF, where a great portion of the antennas will be upgraded using AsiaSat's 5G filters.

AsiaSat 5G rejection BPF has been put on the market since 2019 and has been well received in the satellite TV community. With its compact profile, light weight and excellent 5G rejection performance, the BPF has become an essential component for a C-band satellite reception site.

This paper summarises what we have learned from troubleshooting a problem involving BPF installation. Since the quality standard of the BPF installation could significantly impact the 5G rejection filter's performance and hence the satellite-TV's user experience, we are sharing this experience in order to provide some diagnosis guidelines that may be helpful for BPF installation.

2. A Real 5G Rejection BPF Installation Troubleshooting Case

One of our customers has reported that a recently installed 5G BPF did not function as expected – interference still occurred intermittently and impaired the satellite TV reception. The spectrum plots before and after BPF installation are shown in **Figure 1(a) and (b)**.

It can be seen from **Figure 1(a)** that there was intensive 5G interference at around 3430 MHz, with a bandwidth of about 60 MHz. After the BPF installation, interference was reduced by only 20 dB, as shown in **Figure 1(b)**, performing at a far lower level than the > 60 dB rejection level that AsiaSat BPF-3700S filter was designed to provide. The 5G interference to the TVRO system remained strong and “robbed” the satellite carrier power from the low noise block-downconverter (LNB), putting up mosaics on the TV screen.

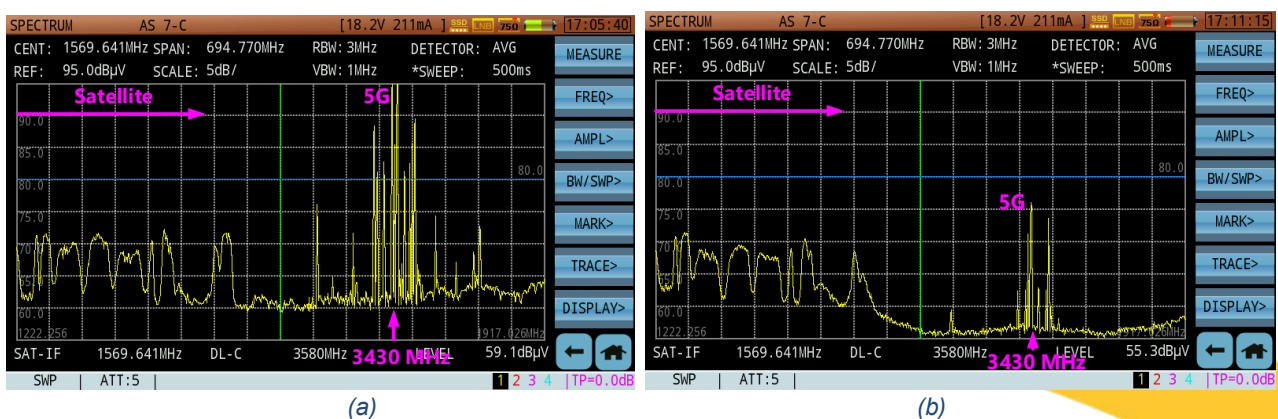

Figure 1 Spectrum at the TVRO LNB output: (a) before, and (b) after BPF installation.

2.1 Symptoms and the Preliminary Diagnosis

We started by asking our customer to describe the operational environment as well as the connection status of the equipment, e.g. the antenna feed horn, the BPF and the LNB.

According to the customer, no 5G base station shared the same rooftop with the satellite dish – which could have been the case for many buildings in Hong Kong. We were also told that there were no 5G base stations in the pointing direction of the satellite dish. In other words, there was no known reason why the 5G interference power would exceed the design limit of the 5G rejection BPF.

The customer sent us a close-up photo showing the connection on the TVRO equipment which is shown in **Figure 2(a)**. It was a front-fed TVRO, and the *Type-A LNB* used by the customer was of a light-weight type secured by four screws and has a non-standard waveguide interface. The LNB was enclosed in a plastic shell and appeared not to be fully EMI-shielded.

For the sake of comparison and in an attempt to mitigate the problem, we asked the customer to repeat the spectrum measurement using a *Type-B LNB* with a full-metallic body and standard WR229 input interface. **Figure 2(b)** shows the hardware connection of the Type-B LNB, where 10 screws were used to secure the BPF. Unfortunately, there was no improvement in the level of 5G interference at the *Type-B LNB*'s output.

The spectrum plots comparison is shown in **Figure 3**.

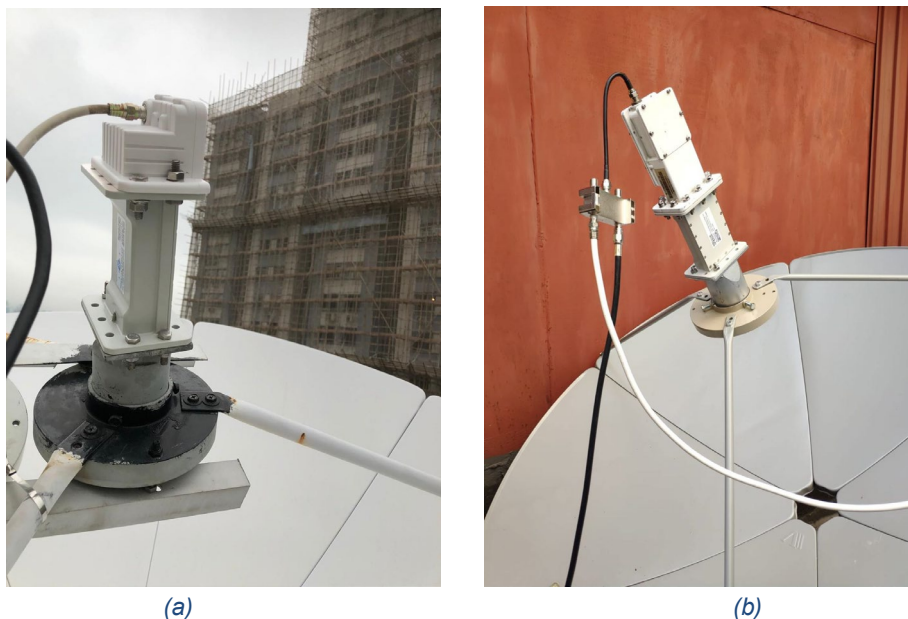

Figure 2. The feed horn, BPF and LNB hardware connection on the TVRO antenna, using (a) Type-A LNB, and (b) Type-B LNB. For Figure 2 (a), even the flange outer edges were not aligned, the waveguide openings of the LNB input and the BPF output were still aligned.

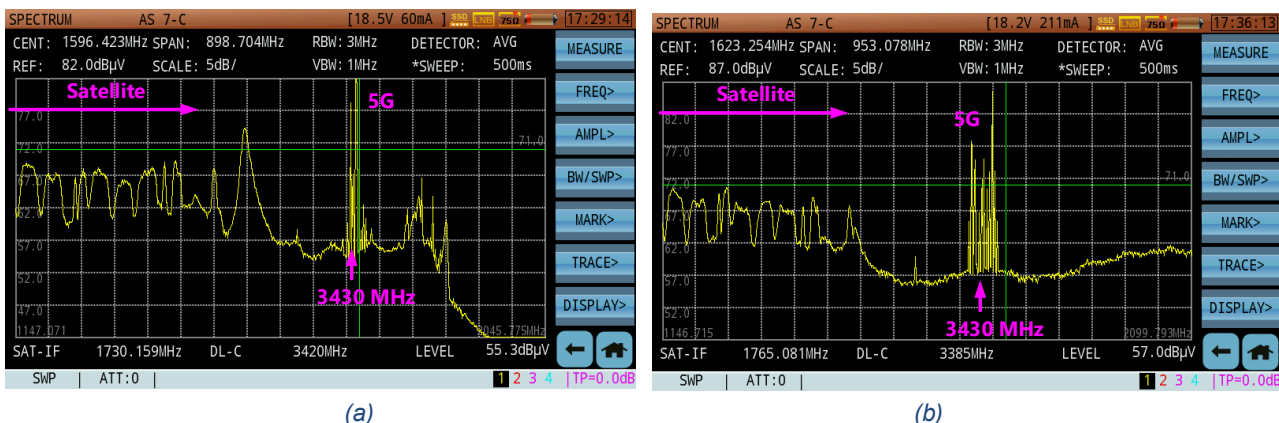

Figure 3. Spectrum at the TVRO LNB output, using (a) Type-A LNB and (b) Type-B LNB.

2.2 On-site Diagnosis

Given the unsatisfactory result of the preliminary diagnosis and the failed attempt at mitigation, we decided to conduct a site visit in order to assess the TVRO site environment and to inspect the quality standard of the hardware installation.

Upon arriving at the customer's site, we found the environment to be different from what we had expected. Unlike most rooftop-installed SMATV antennas, the TVRO antenna in question was located on the second floor balcony of an industrial building, overshadowed by skyscrapers of more than 30 stories high.

Figure 4(a) shows what appeared to be 5G base stations, and **Figure 4 (b)** shows that one of them was only 10 to 20 degrees from the pointing direction of the TVRO antenna.



Figure 4 What appeared to be 5G base stations installed (a) on the rooftop of the same building above the TVRO antenna and (b) on the rooftop of an adjacent building in the pointing direction of the TVRO antenna.

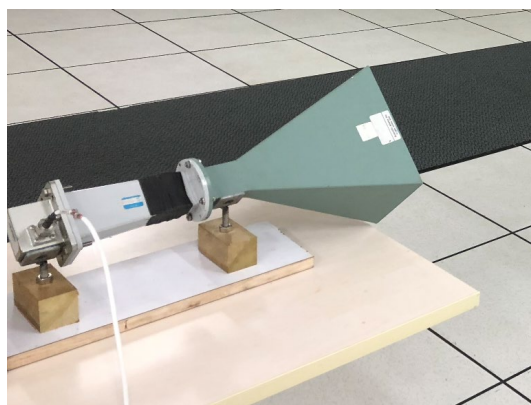

Figure 5 The standard C-band horn antenna used in the on-site diagnosis test.

As a first step, we took an interference scan with a standard C-band horn antenna (see **Figure 5**). The horn was connected to a hand-held spectrum analyser, and we manually scanned the horn in all possible directions with max-hold spectrum plot. The scanning results confirmed that the 5G interference generally **came from the rooftop of the adjacent building in the pointing direction of the satellite dish.**

The second diagnosis step was to take 5G interference measurements directly from the antenna feed output as shown at **Figure 6(a)**. The corresponding spectrum was max-held for more than 5 minutes and shown at **Figure 6(b)**. It can be seen that the interference was in the typical 5G spectrum shape, where the inner 15 MHz wide plateau was made of 5G synchronising signal blocks (SSB) which were broadcast and used for establishing the links between the base station and the 5G end user equipment. The estimated 5G power picked by the satellite dish antenna was less than -33 dBm, which should have had no noticeable impact to the satellite carriers if the BPF had functioned normally.

The third diagnosis step was to inspect the BPF-LNB interface and tighten the screws. First, the BPF-LNB junction was removed from the feed horn. After careful inspection, no gaps or cracks at the BPF-LNB interface could be observed, and all the screws were fastened as shown in **Figure 2(b)**. However, as we tried to tighten the screws, we found that 7 out of the 10 screws were not tightly fastened. The spring lock washers under the screw head were only slightly loaded. After tightening all the screws, we mounted the BPF-LNB junction back onto the feed, and the 5G interference was found to have gone immediately. **It turned out that an imperceptible gap between the LNB and the BPF was the culprit!** The spectrum plots comparison before and after the screw tightening is shown in **Figure 7**, and it can be seen that the tightened BPF-LNB interface has helped to reduce 5G interference by 20 to 25 dB.

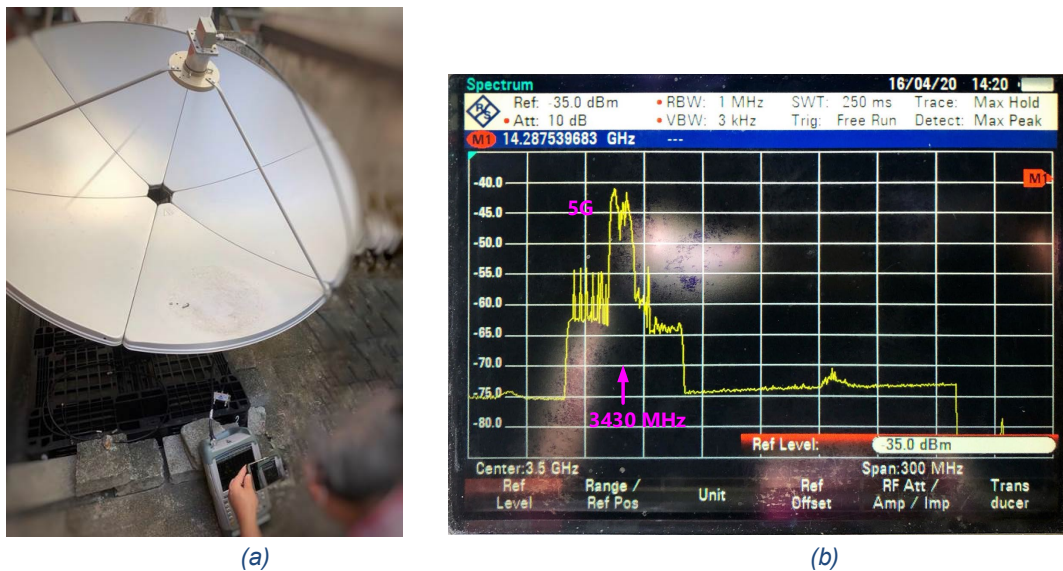

Figure 6 5G interference measured at the antenna output port: (a) the test setup and (b) the max-hold spectrum plot.



Figure 7 Spectrum plots at the Type-B LNB output: (a) before and (b) after tightening the BPF-LNB interface screws.

To further help the customer with the *Type-A LNB* as used in **Figure 2(a)**, we tried several ad-hoc shielding methods and tested their effectiveness. First, all four screws at the BPF-LNB interface were tightened. The resultant spectrum plot at the LNB output is shown in **Figure 8(b)** where the 5G interference signal was still strong.

A layer of conductive tape was then applied to seal the BPF-LNB interface, and the corresponding spectrum plot is shown in **Figure 8(c)**. The conductive tape improved the shielding effect by only a few dBs.

Finally, three layers of household aluminum foil were used to wrap the LNB, and the corresponding spectrum plot is shown in **Figure 8(d)**. It can be seen the conductive tape combined with the aluminum foils provided a total shielding effect of 20 dB, and the 5G interference has been reduced to an acceptable level.

Figure 8(a) shows the final appearance of the LNB. Based on the tests, we suspected there was a leakage from the *Type-A LNB* (e.g. gaps or simply non-metallic body enclosure) in addition to the BPF-LNB connection interface. The tapes and aluminum foils may work as a temporary shielding, but their effects may be degraded by the elements over time.



(a)



(b)



(c)



(d)

Figure 8 The ad-hoc shielding applied to the *Type-A LNB*: (a) the final appearance of the shielded LNB. The spectrum plots at the LNB output: (b) BPF only, no other shielding measures, (c) BPF with conductive tape sealing the BPF-LNB interface, and (d) LNB wrapped with aluminum foils in addition to the conductive tape sealing BPF-LNB interface.

3. Diagnosis Guidelines for BPF Installation

Based on our real world experience troubleshooting a problem with 5G interference and BPF installation, we think it may be worthwhile to summarise our experience and to provide some diagnosis guidelines for our customers. Some of the factors that need to be considered are:

- the location of the nearest 5G base station
- satellite dish type
- LNB type
- the quality standard of the BPF installation (i.e. BPF-LNB interface) (see **Figure 9**)

The guidelines are set out in **Table 1** below, with the most important tip being to **make sure that the BPF-LNB interface is tightly connected**. If the LNB used is similar to the one shown in **Figure 2(a)**, it may be better to upgrade it with a model having standard waveguide flange and full-metallic body enclosure. For a step-by-step installation guide, please watch the video on **our website**¹.

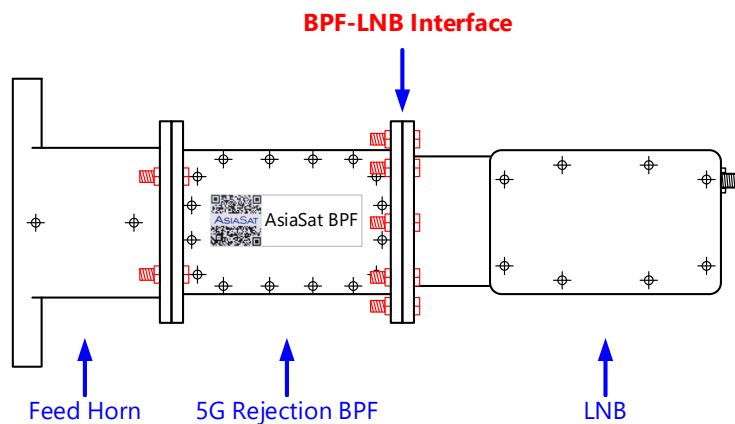

Figure 9 Connection between antenna feed horn, 5G rejection BPF and the LNB.

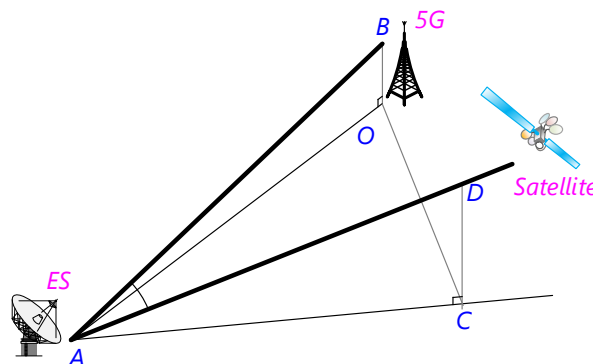

Figure 10 Relative position of the satellite earth station (ES), 5G base station (5G) and the GEO satellite, where line AB is the line-of-sight distance and $\angle BAD$ is the angular separation of the 5G base station and the GEO satellite seen by the ES.

¹ <https://www.asiasat.com/technology/5Gfilter>

Table 1 5G rejection BPF installation diagnosis guidelines

Step 1. 5G Base Station Location	<ul style="list-style-type: none"> Coexisting condition: <u>distance to ES</u> > 100 m, and <u>angular separation</u> > 10°. Refer to Figure 10 for the illustration. Single BPF solution may not be sufficient if neither the distance nor the angular separation condition can be met. Make sure the interference comes from 5G band if the spectrum plot is available.
Step 2. Satellite Dish Type	<ul style="list-style-type: none"> Backside-fed dish (e.g. Cassegrain type) is easy to have BPF installed without interrupting the feed horn. Front-fed dish (e.g. primary focus type) is recommended to connect the BPF with the LNB on bench first, tighten all connection screws and then mount them back to the feed horn for the best installation quality.
Step 3. LNB Type	<ul style="list-style-type: none"> LNB body is better a full metal cavity design. LNB input waveguide port is better to be standard WR229 flange.
Step 4. BPF-LNB Interface	<ul style="list-style-type: none"> The rubber gasket must be properly placed in the LNB input flange groove before fastening the screws. It is best to fill all screw holes and tighten all 10 screws with spring lock washers. If space is limited, prioritise using the screw holes on the broad sides of the flange. Make sure there is no visible gap at the interface after all screws are tightened up. Wrap the BPF-LNB interface with one or two layers of conductive tapes if needed.
Step 5. BPF-LNB to the Feed	<ul style="list-style-type: none"> Using at least four screws near the four corners of the flange to connect the feed horn output with the BPF input. Check the satellite carrier levels before and after BPF installation if possible.

4. Conclusion

In this White Paper, a typical problem with BPF installation is diagnosed and eventually solved. The cause of the partially-rejected interference is the insufficiently tightened BPF-LNB waveguide flange interface where the 5G signal could be directly coupled in without passing through the BPF. The solution is to simply tighten up all the screws between the BPF and LNB before re-mounting them onto the antenna feed horn. This White Paper provides some general diagnosis guidelines to help with BPF installation and troubleshooting.

For more information:

Asia Satellite Telecommunications Company Limited
15 Dai Kwai Street, Tai Po Industrial Estate, New Territories, Hong Kong
T: +852 25000888
E: 5G_info@asiasat.com
www.asiasat.com

