



## UHD TRANSMISSIONS WITH DVB-S2X

### INTERVIEW

Pradman P. Kaul,  
President, Hughes Network Systems, LLC

### FOCUS ASIA

Private Enterprise, Governments and Philanthropy in  
Asia's HTS Wireless Backhaul





Russian Satellite  
Communications Company

The National Satellite Operator  
of the Russian Federation

www.rsccl.ru

03	<b>MESSAGE FROM THE PRESIDENT</b>
04	<b>FEATURES: UHD Transmissions with DVB-S2X</b>
04	<b>AsiaSat:</b> UHD Transmission with DVB-S2X via Satellite
14	<b>MEASAT:</b> Ultra High Definition Television: Current Scenario and Challenges
20	<b>INTERVIEW</b>
20	<b>Pradman P. Kaul,</b> President, Hughes Network Systems, LLC
24	<b>FOCUS ASIA</b>
24	<b>NSR:</b> Private Enterprise, Governments and Philanthropy in Asia's HTS Wireless Backhaul
30	<b>SATELLITE TRENDS</b>
30	<b>Newtec:</b> UHD? Not Without DVB-S2X!
38	<b>APSCC MEMBERS</b>
40	<b>INSIDE APSCC</b>
40	APSCC 2015 Satellite Conference and Exhibition
42	<b>SATELLITE INDUSTRY NEWS</b>
47	<b>CALENDAR OF EVENTS</b>
48	<b>ADVERTISERS' INDEX</b>

CONTENTS







China Satellite Communications Co., Ltd.

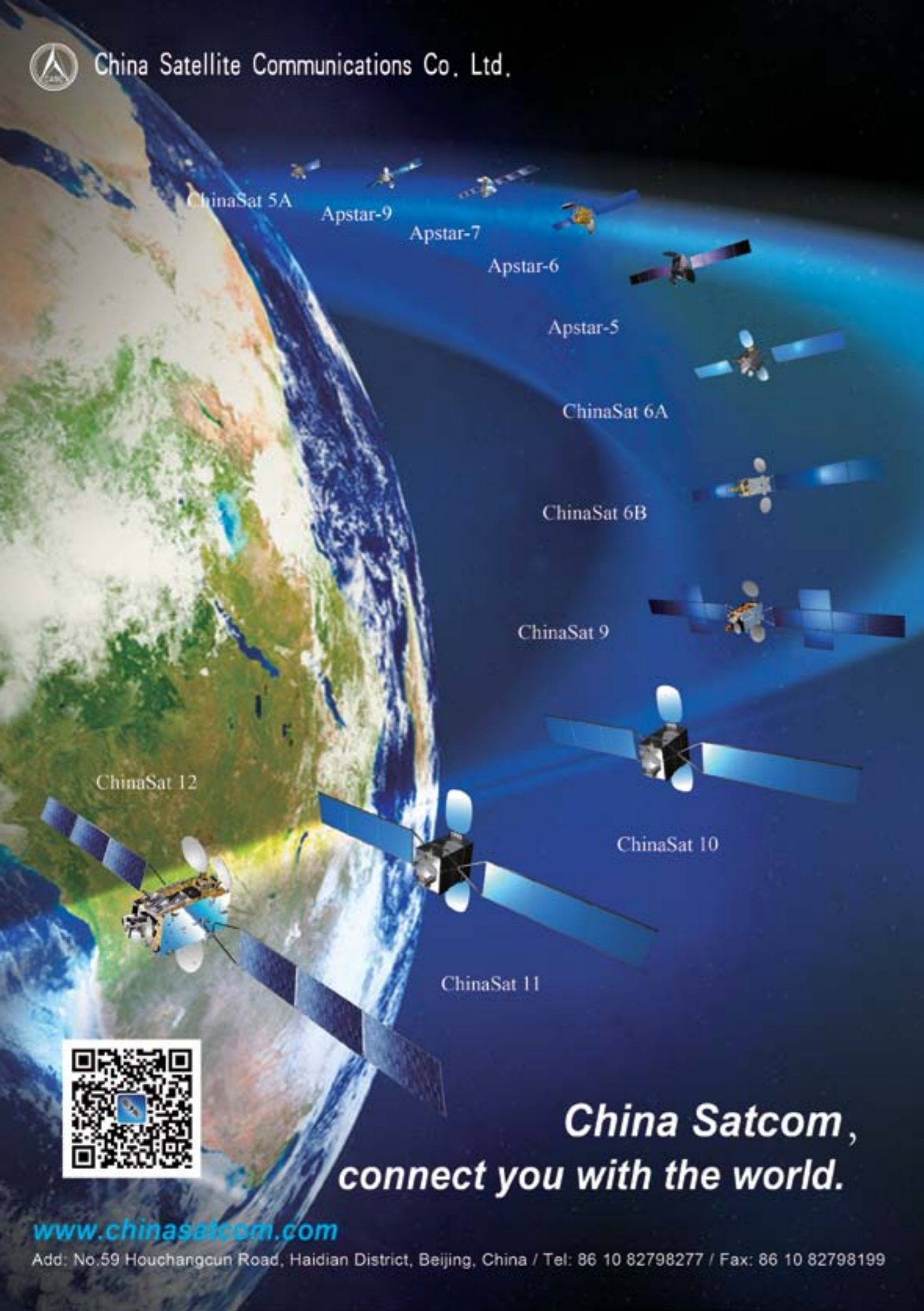

**China Satcom,**  
*connect you with the world.*

[www.chinasatcom.com](http://www.chinasatcom.com)

Add: No.59 Houchangcun Road, Haidian District, Beijing, China / Tel: 86 10 82798277 / Fax: 86 10 82798199



## MESSAGE FROM THE PRESIDENT

Ultra High Definition Television, or UHD TV, has been promised over the past few years as “the next big thing” for the video industry. 2015 has seen more advances in the UHD sector, and this trend will continue with more UHD content being made available to the end consumer. As UHD grows, satellite operators will play a key role in its broadcast and distribution.

With four times the resolution of HD TV, higher dynamic range, wider color gamut and greater frame rates, the superiority of UHD TV is unquestioned. There is genuine interest and excitement in the marketplace from content creators down to consumers. The consumer interest especially is vital in ensuring that UHD is successful in the marketplace and does not follow the way of 3D.

UHD also has its own supply chain. For content creators and channel owners, it largely means new production, storage, and delivery equipment. For consumers, it means new UHD TVs leading to an enhanced viewing experience. For satellite operators, it means new broadcasting and compression standards, as well as hardware.

In broadcasting standards, DVB-S2X (an extension of DVB-S2) offers up to 50% efficiency gains over its predecessor. In compression, the HEVC (High Efficiency Video Coding) video compression standard almost doubles the data compression ratio compared to its H.264/MPEG-4 forbearer. These two standards play a vital role for satellite operators and the need to be bandwidth efficient to be commercially viable.

In hardware, consumer UHD HEVC set top boxes which support free-to-air channels are readily available in the market. Professional decoder availability, however, is limited mainly due to the complexity in developing new HEVC chipsets that integrate with existing hardware. This is expected to change in the near future.

Thanks to these advances and the inherent strengths of satellite as a mass video delivery system, I expect satellite to be a key player in UHD distribution much as it has been for SD and HD. The satellite industry will play a major role in funneling UHD content from content creators and channel owners to pay-TV operators, and later to end consumers via DTH platforms.

I look forward to the satellite industry's success in the UHD sector, and trust that this issue of the APSCC newsletter will be extremely informative in the pursuit of this success.

**Paul Brown-Kenyon**  
President  
APSCC



## UHD Transmission with DVB-S2X via Satellite

Captain Ip, Communications Systems Engineer, Asia Satellite Telecommunications Company Limited (AsiaSat)

### Introduction

Ultra-High-Definition (UHD) satellite transmission using the new DVB-S2X transmission standard is already happening. The world's first 4K UHD video transmission over satellite using DVB-S2X was demonstrated at CommunicAsia 2014<sup>1</sup>. It is no longer a question of whether DVB-S2X will have a role in UHD broadcast networks, but rather a question of when mass adoption will happen.

### Current challenges and possible solutions among UHD

UHD is a hot topic in satellite broadcast industry. Following the demonstrated successful launch of "DVB UHD-1 Phase 1" services (3840x2160 resolution, up to 60fps, 10-bit sampling, standard dynamic range and BT.709 color space), the industry is evolving and improving to the next phase, DVB UHD-1 Phase 2, which includes more standards of BT.2020. The format is currently under intense industry evaluation and is intended for service in 2017/18.

High Dynamic Range (HDR), High Frame Rate (HFR), Wider Color Gamut (WCG) and Next Generation Audio (NGA) are the main enhancements in DVB UHD-1 Phase 2. Given these additional enhancements for complex live and non-linear workflow, the challenges on spectrum requirements, integration of video & audio codec, studio interconnection and the specification of HDR and HFR standards are proportionally multiplied. Figure 1<sup>2</sup> shows the challenges of DVB UHD-1 Phase 2.

### Possible solution for deploying UHD-1 Phase 2 in production process

To incorporate the new features of UHD-1 Phase 2, infrastructure in production workflow needs to be upgraded and layer-3 network technology (e.g. SMPTE 2022) is being proposed as the best means to realize the upgrade. It is scalable and able to transmit distinct services in both LAN and WAN networks. Progresses have been made to implement the network technology in UHD live broadcast services. Features like managing

some people just love satellite



Here at talk Satellite we know your market, and how important reliable information is to the planning and running of your company. talk Satellite reports region by region, providing truly global coverage of the latest developments in satellite.

[www.talksatellite.com](http://www.talksatellite.com)

Receive talk Satellite Weekly Newsletter; [circ@talksatellite.com](mailto:circ@talksatellite.com)

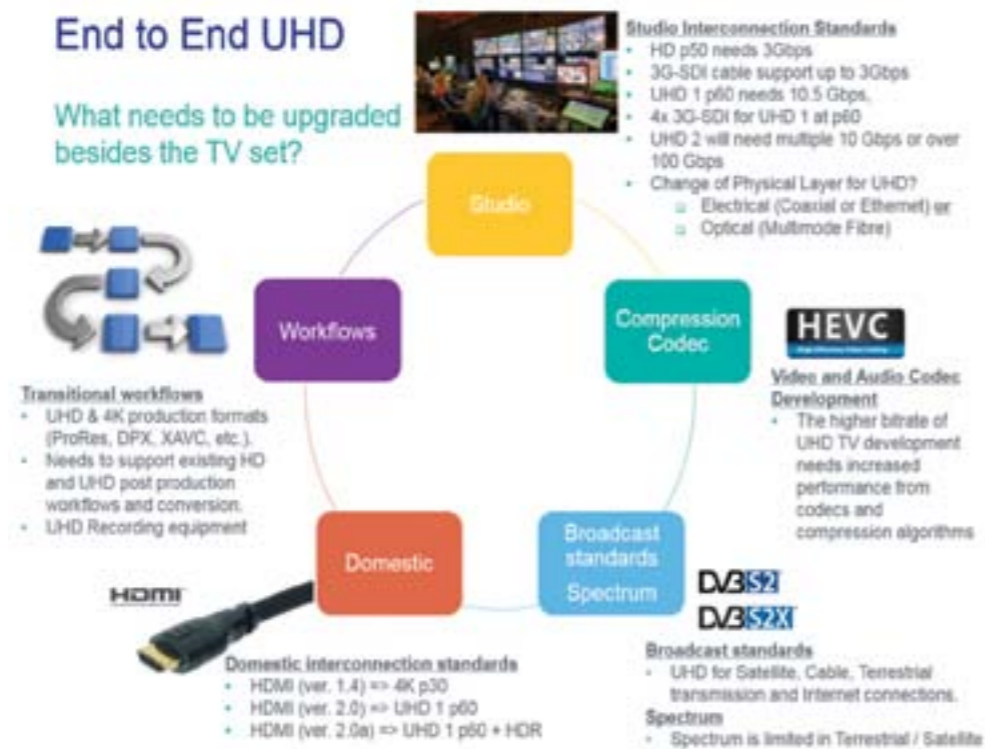

Figure 1. Challenges of DVB UHD-1 Phase 2

bandwidth, software defined networks (SDN) and performant Layer-3 control and monitoring system are being developed. Optical fiber distribution (Fiber-to-home) and new compression standard (e.g. Mezzanine compression) are used to overcome the large bandwidth requirement. While the IP-based infrastructure solutions are still evolving, standards have to be established to ensure interoperability of equipment from different vendors and transmission across different networks.

### UHD transmission via satellite

Satellite DTH (Direct-to-Home) has always been considered as the most spectrum efficient way of TV distribution in broadcasting. However, to improve transmission cost efficiency via satellite, it is required to increase the number of channels on a satellite transponder. The above can be achieved via either reducing the bitrate of individual channel or increasing the transponder throughput.

High Efficiency Video Coding (HEVC) is the most promising scheme to meet the first requirement above. HEVC video compression can significantly reduce the data rate of an UHD TV programme to around 20 Mbps, compared to the present MPEG-4 coding which requires approximately 80 to 100 Mbps. The development of HEVC started in 2013 but is still in development stage. The latest version published in early 2015 supports format range extensions, scalable coding extensions, multi-view extensions and 3D-HEVC extensions. New features such as screen content coding (SCC) extensions are still in development but are expected to complete in early 2016. It is anticipated that HEVC will continue to improve the compression capability for video containing rendered graphics, text, or animation as well as (or in place of) camera-captured video scenes to meet the future demand of UHD.

### Introduction of DVB-S2X

To increase the transponder throughput, advanced modulation schemes have to be adopted. The 2003 DVB-S2

is today's most widely adopted standard in the satellite broadcasting / communications market. The standard has a significant market penetration in contribution and distribution services, VSAT solutions, high-speed IP links as well as government and defense networks over satellite.

As new services (e.g. UHD) emerge, the demand of data rates increases at an accelerated pace and end-users expect to get communication anywhere, anytime. DVB-S2 standard is no longer adequate to meet today's high data rate need. The new DVB standard, DVB-S2X, with improved modulation efficiency will improve the bandwidth utilization efficiency and allow for business growth throughout all applications in the satellite industry.

The DVB-S2X standard was first approved in February 2014 and published as ETSI EN 302 307 part 2 in October 2014. It offers higher flexibility and more features than the core applications of DVB-S2. Compared to DVB-S2, efficiency gains up to 51% can be achieved with DVB-S2X<sup>3</sup>. It has higher modulation schemes (64/128/256APSK), smaller roll-off options (5%, 10% and 15%) and advanced filtering making it possible to have smaller carrier spacing.

In the press release of DVB-S2X specification approval, it clearly stated that the new standard was targeted to be the future standard for UHD broadcasting. "The timely approval of DVB-S2X means it can be implemented with HEVC, the latest video coding scheme. It is anticipated that the volume demand for chip sets and equipment will be driven by consumer internet services and broadcasts of UHD TV with HEVC coding via DTH satellites."<sup>4</sup>

Figure 2 shows the comparison between DVB-S2 with 20% roll-off and DVB-S2X with 5% roll-off. The DVB-S2X standard increases the modulation and coding (MODCOD) schemes and Forward Error Correction (FEC) options compared with DVB-S2. The number of MODCODs has increased from 28 in DVB-S2 to 112 in DVB-S2X, bringing efficiency as close to the Shannon limit as possible. For example, more than 30% improvement of spectral efficiency can be obtained with DVB-S2X for Carrier to Noise Ratios of 7dB.

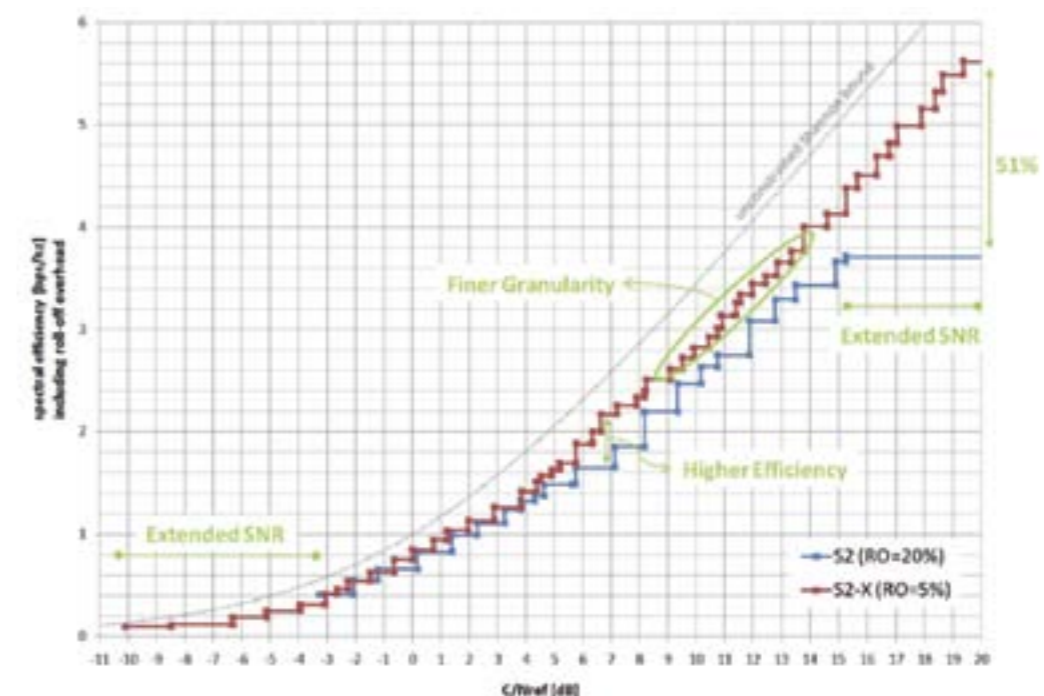

Figure 2<sup>5</sup>. Spectral efficiency for DVB-S2X (RO 5%) compared with DVB-S2 (RO 20%)



## Characteristics of DVB-S2X for DTH

The most relevant features of DVB-S2X for DTH are channel bonding, advanced filtering of carrier spacing, wideband technology, finer granularity of modulation and FEC options combined with sharper roll-offs.

Channel bonding of up to 3 satellite transponders will support higher aggregate data rates and allow for additional statistical multiplexing gain for high data rate services such as UHD. This will eventually be a key technology to distribute stat-muxed UHD channels in one "big" transport stream of more than 150 Mbps.

The wideband implementation in DVB-S2X addresses satellite transponders with bandwidth from 72 MHz (for C-band) to several hundred MHz (for Ka-band, HTS). Currently professional modulators can support 72 MBaud or above, resulting in a very high data rate in one single carrier to be transmitted over satellite. Maximum 20% efficiency is gained for non-linear operations.

The mandatory implementation of VCM (Variable Coding and Modulation) in receivers increases the feasibility of UHD TV service, so that broadcasters can balance between the broadcast quality and service robustness to their need. Standard scrambling sequences are added for better resilience to co-channel interference for broadcasting. A finer granularity of modulation and FEC options allows for improved operational flexibility.

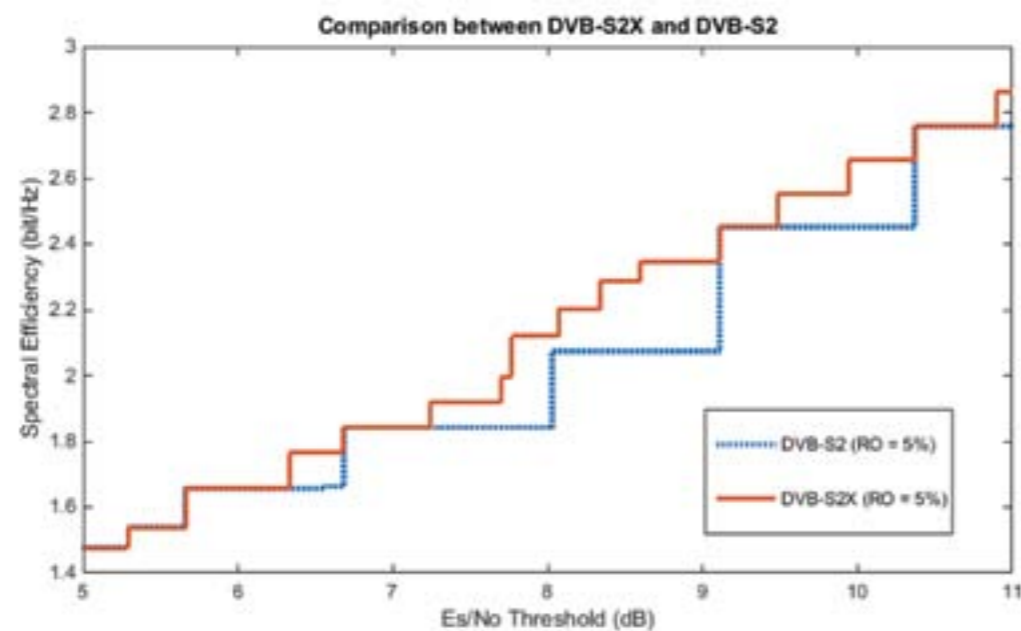

Figure 3. Comparison between DVB-S2X and DVB-S2 of Newtec MDM6100

Figure 3<sup>6</sup> shows the comparison between DVB-S2X and DVB-S2 of Newtec MDM6100. In order to show the benefits of DVB-S2X, same roll-off factor is assumed. Typical Es/No (CNR) received in a DTH network is from 6 to 10dB due to small receive antenna. DVB-S2X adds new 8PSK and 16APSK MODCODs in the CNR range from 6 to 9dB covered in DVB-S2 with lower granularity. The finer steps in MODCODs of DVB-S2X completely eliminate this drawback of limited number of MODCODs in DVB-S2 and thus increase the capacity of DTH service.

Estimated Bit Rate (Mbps) <sup>1</sup>	Compression		SD (p25/p30)	HD (p25/p30)	UHD (p50/p60)
	H.262 / MPEG-2		3-5	-	-
	H.264 / MPEG-4 AVC		2-3	8-10	75-85
	H.265 / HEVC		-	4-5	15-20

Satellite Transmission <sup>2</sup>	Carrier Data Rate	Target TVRO Size <sup>3</sup>	SD (p25/p30)	HD (p25/p30)	UHD (p50/p60)
DVB-S QPSK FEC 3/4	38Mbps	2.4m+	7-12 channels in MPEG-2	4-5 channels in MPEG-4	-
DVB-S2 8PSK FEC 5/6	72Mbps	2.4m+	24+ channels in MPEG-4	7-9 channels in MPEG-4 14-18 channels in HEVC	3-5 channels in HEVC
DVB-S2X 16APSK FEC 2/3	88Mbps	2.4m+	-	8-10 channels in MPEG-4 17-22 channels in HEVC	1 channel in MPEG-4 4-5 channels in HEVC

Assumptions:

- Estimated Bit Rate range is for reference only.
- Symbol Rate: 27.5MSps (DVB-S, 35% roll off); 30.0MSps (DVB-S2, 20% roll off); 34.285MSps (DVB-S2X, 5% roll off)
- TVRO size at beam centre region in C-band.

Figure 4. Number of channels of 36MHz C-band transponder with different DVB standards

## Availability of DVB-S2X silicon chips

The availability of DVB-S2X compliant silicon chips is a key element for the market success of UHD TV, set-top boxes (STBs) and satellite modems. In recent months Broadcom<sup>7</sup>, Silicon Labs<sup>8</sup> and ST Microelectronics<sup>9</sup> have announced the implementation of DVB-S2X on their DTH and Broadband system-on-chip (SoC) devices.

Broadcom's BCM453xx series system-on-a-chip (SoC) integrates dual Full Band Capture (FBC) Analog Digital Converters (ADCs) and up to eight DVB-S/S2/S2X demodulators in a single chip. The chips allow operators to digitize the entire 250-2350 MHz spectrum and provide flexible bandwidth deployment and tuning function in the digital domain.

Silicon Labs' single chip Si216x/6x2 and the new Si218x/8x2 digital TV demodulators support DVB-S2X specification. The single-channel Si218x/6x and dual-channel Si218x2/6x2 families enable TV and STB manufacturers to simplify complex video front-end designs and to address combinations of multiple broadcast standards with a single field-proven, low-power and cost-effective demodulator solution.

STMicroelectronics' STiD135, satellite full-band multi-tuner demodulator (up to 8 multi-standard demodulators), focuses on satellite broadband applications. It features two high-symbol-rate (HSR) demodulators with maximum baud rate of 500 MSymbol/s and is compliant with Annex M of the DVB-S2/S2X specification EN 302 307.

With these DVB-S2X compliant chip sets, manufacturers can design and produce future-ready satellite UHD devices such as STBs and satellite modems. STBs and iDTVs with DVB-S2X and HEVC capability are expected to be launched in 2016.

## Professional satellite equipment with DVB-S2X via satellite

Not only chip set vendors but also providers of professional satellite transmit and receive equipment are supportive of the launch of DVB-S2X. Newtec, Comtech EF Data, Ericsson, Appear TV, DekTec are either developing or have already developed DVB-S2X modulators/demodulators as well as complete set of solutions<sup>10</sup>.

Ericsson has provided an end-to-end solution for this new standard. It offers M6100 Broadcast Satellite

Modulator and RX8200 Advanced Modular Receiver for the fixed link systems while AVP 3000 would be used for DSN application.

Appear TV launched its end-to-end solutions supporting DVB-S2X standard at the ABU Digital Broadcasting Symposium in March 2015. The DVB-S2X modulation and demodulation modules run in the Appear TV XC 5000 Series Video & Signal processing Platform.

DekTec has a full implementation of DVB-S2X available now for its test modulator DTA-2115. It supports all constellations and modulation modes for each supported standard, including DVB-S2X, in VHF, UHF and L-band for PCI Express.

Comtech EF Data committed that the CDM-760 Advanced High-Speed Trunking Modem can be upgraded to support DVB-S2X. Novelsat stated that "it is committed to supporting all standards including the DVB-S2X standard" in a press release.

Newtec has announced that its 6000 series products are all software upgradeable to DVB-S2X and are available in market now. Newtec M6100 Broadcast Satellite Modem is one of the earliest professional modems that supports DVB-S2X. The world's first DVB-S2X 256APSK satellite transmission<sup>11</sup> performed in November 2014 was using this modem.

In the trial, 25 Mbps was modulated into a 5 MHz 256APSK carrier and transmitted from a Satellite News Gathering (SNG) truck using a 1.4m antenna to the JSAT Superbird-B2 satellite (Ku-band). The transmission was successfully received by a 5m dish at the headquarters of Nippon TV in Tokyo, Japan. This trial proved the feasibility of delivering carriers using high modulation schemes through a satellite transmission.

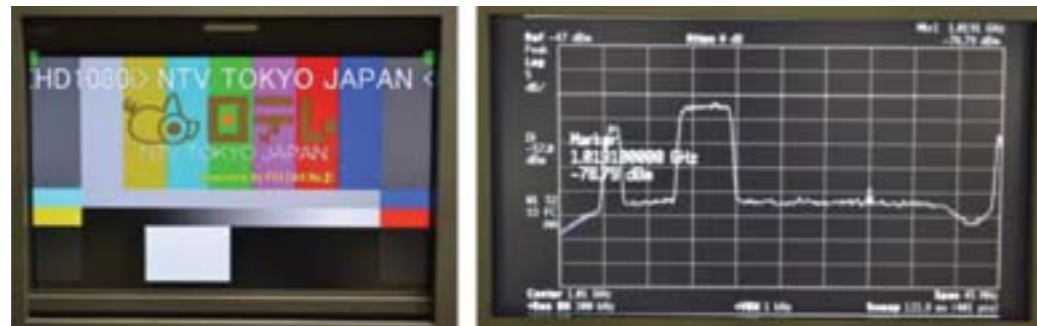

Figure 5<sup>11</sup>. Test image and spectrum plot showcasing 256APSK with DVB-S2X

### Different approaches in delivering UHD with DVB-S2X via satellite

The demonstration<sup>1</sup> at CommunicAsia 2014 acts as a POC (Proof of Concept) of combination of UHD and DVB-S2X in satellite communication while the 256APSK transmission showed the dramatic improvement in terms of bit per Hz ratio from DVB-S2 to DVB-S2X.

In 2013, the year prior to the launch of DVB-S2X, Asia Satellite Telecommunications Co. Ltd. (AsiaSat) performed a number of trial tests (high throughput/wideband tests in 36 MHz C-band transponder and 150 MHz Ku-band transponder) of the next generation modulation technology with some of the leading proprietary systems (which later evolved to DVB-S2X). The result was very encouraging, which demonstrated a more than

40% efficiency gain compared to DVB-S2. It is no doubt that the improvement achieved by DVB-S2X could bring forward the feasibility of UHD transmission via satellite.

There are two approaches, distribution and cable TV headend, to deliver UHD with DVB-S2X via satellites. Small antennas are used for distribution networks such as DTH service while headends such as TV stations or data centers tend to use larger antennas for reception in order to ensure service robustness. Benefits and drawbacks of two approaches are summarized in Table 1.

	Distribution	Cable TV Headend
<b>Advantage</b>	<ul style="list-style-type: none"> <li>- *Simple and low cost to deploy a receive site in rural districts</li> <li>- Easy to manage</li> </ul>	<ul style="list-style-type: none"> <li>- High throughput carrier using DVB-S2X</li> <li>- Re-distribute the carrier to different media</li> </ul>
<b>Disadvantage</b>	<ul style="list-style-type: none"> <li>- Cannot fully utilize the benefits of DVB-S2X such as high modulation scheme</li> <li>- *No commercial product in current market</li> </ul>	<ul style="list-style-type: none"> <li>- Expensive equipment cost</li> <li>- Operation cost for re-distribution networks</li> </ul>

\*Commercial STBs and IDTVs with DVB-S2X & HEVC are expected to be launched in 2016

Table 1. Pros and cons of different UHD delivery methods with DVB-S2X

### Economic viability of UHD transmission using DVB-S2X in the near future

Cable TV headend will be the forerunner in UHD transmission with DVB-S2X. Unlike distribution approach, the involvement of limited number of equipment (controllable equipment change cost) and the use of large receive antennas in headends give strong incentive for the use of DVB-S2X standard. In one of AsiaSat tests, more than 140 Mbps is achievable in a 36 MHz C-band transponder received by a 4.5m antenna, which demonstrated ~40% of throughput increase as compare with DVB-S2. The gain could be further increased to a maximum of 51% if a larger antenna is used, such significant throughput increase could compensate the cost of the change of new equipment and thus an economically viable solution for UHD transmission in the near future.

As to the distribution approach, it is expected that only several DTH platforms will change to DVB-S2X in next few years as the gain in throughput is not enough to absorb the cost of replacing tens of thousands of STBs in the near future. Less than 20% throughput increment can be obtained for a DVB-S2X DTH network via conventional satellites due to the limitation of receive dish size. The gain is merely enough to accommodate one more UHD HEVC encoded channel even with statistical multiplexing.

### Economic viability of UHD transmission using DVB-S2X in the long term

It is expected that like DVB-S2, DVB-S2X will become the mainstream. With more UHD content, enhanced HEVC compression efficiency, manageable cost of DVB-S2X equipment (e.g. STBs and modems) and launches of HTS, in the longer term the new DVB-S2X will be economically viable for UHD DTH networks as well.

### Conclusion

DVB-S2X showcases an evolution and enhancement of the DVB-S2 standard and offers significant advancement in the next generation DTH broadcast services. It fine-tunes both the physical and the upper protocol



layers of DVB-S2, which is producing a highly attractive package for service operators who are planning to launch new generation services and purchase new receivers. The obvious approach is the launch of UHD TV services with HEVC coding algorithms.

While the standardizations of DVB-S2X and UHD TV has taken the broadcast industry a step forward, the launch of DVB-S2X commercial products will revolutionize the current DTH market. With enhanced technologies, UHD satellite transmission with DVB-S2X will become the benchmark of the new generation DTH service in the next decade. 

## Reference

1. **FIRST EVER UHD TV 4K TRANSMISSION WITH DVB-S2X.** Newtec, 10 June 2014.
2. AsiaSat presentation materials
3. Koen Willems: **DVB-S2X DEMYSTIFIED.** Newtec White Paper, March 2014
4. **DVB-S2X Specification Receives Approval from Steering Board.** DVB Project, 27 February 2014
5. **DVB-S2X - S2 Extensions.** DVB Project, DVB Fact Sheet, May 2014
6. **Newtec online DVB-S2/EXT/S2X CALCULATOR.** Newtec. Retrieved from <http://www.newtec.eu/services-training/dvb-s2-calculator>
7. **Broadcom Delivers Multi-Channel DVB-S2X Satellite Set-Top Box Chip.** Broadcom Corporation, June 9, 2015. Retrieved from <http://www.prnewswire.com/news-releases/broadcom-delivers-multi-channel-dvb-s2x-satellite-set-top-box-chip-300093528.html>
8. **Silicon Labs Debuts Next-Generation Demodulator Portfolio for Digital Television Market.** Silicon Labs, December 8, 2014. Retrieved from <http://news.silabs.com/press-release/product-news/silicon-labs-debuts-next-generation-demodulator-portfolio-digital-televi>
9. **Industry-First Satellite Demodulator from STMicroelectronics Opens Doors to Fast, Affordable Broadband for All.** STMicroelectronics, 04 May 2015. Retrieved from <http://www.st.com/web/en/press/p3686>
10. Alberto Morello: **DVB-S2X Garners Market Momentum.** DVB Project, 28 May 2014. Retrieved from [https://www.dvb.org/news/dvb\\_s2x-garners-market-momentum](https://www.dvb.org/news/dvb_s2x-garners-market-momentum)
11. **NIPPON TV SUCCESSFULLY CARRIES OUT WORLD'S FIRST DVB-S2X 256APSK TRANSMISSION USING NEWTEC TECHNOLOGY.** Newtec, 02 March 2015. Retrieved from <http://www.newtec.eu/article/release/nippon-tv-successfully-carries-out-world-s-first-dvb-s2x-256apsk-transmission-using-newtec-technology>



**Captain Ip** is AsiaSat's Communications Systems Engineer. He received the B.E. Degree and M.Phil. Degree in the Department of Electronic Engineering from the Chinese University of Hong Kong in 2009 and 2011 respectively. Mr. Ip, a member of AsiaSat's UHD Research Laboratory, is responsible for technical evaluation of different UHD solutions including the compatibility of satellite reception and transmission, playout and compression technologies.

# DigiWorkz

The Asia-Pacific Training Arm of **APB**

## Fulfilling Needs

## Satellite Courses

with WDA subsidies\*

DigiWorkz provides a wide range of short courses designed to provide broadcast professionals with the most up-to-date information and skill-set required for an ever-changing media and broadcast landscape.

Contact us on your training requirements.

*\*From 1 May 2014, Singapore Citizens and Permanent Residents can now enjoy subsidised course fees when they enrol in selected courses by DigiWorkz that are supported by the Singapore Workforce Development Agency (WDA).*

Satellite  
Communication



Satellite  
Communication  
(RF Measurements)



Link Budget  
Analysis



Mobile Uplink  
Operations



For more information,  
please contact +65 6282 8456 or  
e-mail [siewmun@editecintl.com](mailto:siewmun@editecintl.com)

[www.digiworkz.com/wda\\_courses.html](http://www.digiworkz.com/wda_courses.html)



## Ultra High Definition Television: Current Scenario and Challenges

John Loke, Vice President, Network Engineering & Operations  
MEASAT Satellite Systems Sdn. Bhd.

### Digital Video: Where are we now?

The 2012 International Consumer Electronics Show was a key event for the TV industry with the launch of the first 4K Ultra High Definition TV (“UHDTV”) display.

With four (4) times the spatial resolution of High Definition TV (HDTV), UHDTV provides a sharper, more detailed picture. While the emphasis with UHDTV has been on the larger spatial resolution, UHDTV introduces a number of other enhancements – including higher frame rates, greater color gamut and increased dynamic range – which together create a more immersive TV viewing experience and realism.

But the widespread adoption of UHDTV requires more than just the availability of UHDTV services. It requires the wholesale upgrade of the entire broadcast eco-system:

1. Content creators filming and producing UHD content
2. Channel operators purchasing and aggregating UHD content into UHD channels
3. Distributors, i.e. satellite and fiber, delivering UHD channels to TV platforms
4. TV platforms broadcasting or delivering UHD channels to the end consumer
5. Consumers viewing UHD content



Figure 1. The digital video value chain

Whilst the satellite sector has already prepared for UHDTV, other participants in the value chain have more work to do.

**SATELLITE<sup>®</sup>2016**  
The Conduit of Innovation

March 7–10, 2016  
Gaylord National Convention Center  
National Harbor, MD

**Register Today!**  
**Early Bird Rates End December 9th!**

Experience first-hand how the conversations at SATELLITE shape the future of satellite technology. Register today for SATELLITE 2016 and gain access to:

- ✂ The top innovators and leaders in satellite communications leading 60 content driven sessions
- ✂ Products and services from more than 350 exhibitors showcasing the latest technologies and solutions in the global satellite communications marketplace
- ✂ Exclusive networking events with high-level executives representing government, military, broadcast, maritime, telecommunications, enterprise, and commercial satellite markets
- ✂ And more!

Register today with **VIP Code: APSCCAD** to take advantage of Early Bird discounts on the Conference and free access to the Exhibition!

[www.SATShow.com](http://www.SATShow.com) #SATShow



## Satellite Systems: Primed for UHD TV Delivery

TV channels have been distributed via satellite for many decades. Satellites provide a highly reliable delivery platform with their wide coverage allowing a single satellite to deliver a linear channel direct to hundreds or thousands of television head-ends across a region. As such, today C-Band satellites form the backbone of the video distribution system.

With four (4) times the resolution of HD, UHD requires at least four (4) times the data rate to carry its content. For satellites to be able to cost effectively deliver UHD TV content, more efficient compression and encoding is needed.

High Efficiency Video Coding ("HEVC") is a new video compression standard which meets this criteria. Introduced in 2013, HEVC is the successor to H.264/MPEG-4 AVC (Advanced Video Coding). It was jointly developed by the ISO/IEC Moving Picture Experts Group (MPEG) and ITU-T Video Coding Experts Group (VCEG) as ISO/IEC 23008-2 MPEG-H Part 2 and ITU-T H.265.

With HEVC encoding it is possible to distribute a good quality UHD feed over satellite transmission with bit rates of between 20 – 25 Mbps, without compromising the picture quality. This is a 75 % improvement over MPEG-4 encoding. Additional features of HEVC include:

- Supports multiple colour spaces such as but not limited to: generic film, NTSC, PAL, Rec. 601, Rec. 709, and Rec. 2020
- Uses larger block structures of up to 64x64 samples
- Offers better sub-partitioning of the picture
- Other enhancements in areas such as motion compensation, de-blocking filters, range extensions, and others.

In addition to improving the coding, it is also important to increase the efficiency of satellite transmission governing the modulation and bitrate of the satellite's bandwidth.

Increasing demands for more efficient use of bandwidth led to the development of DVB-S2X. DVB-S2X is a new digital satellite television broadcast protocol standardized by Digital Video Broadcasting Project (DVB) in March 2014 as an optional extension of the DVB-S2 standard. The key features of DVB-S2X are:

- Lower roll off (5%, 10%, 15%)
- Increased granularity for modulation coding by introducing new FEC (Forward Error Correction)
- Higher modulation (64APSK)
- Minimized implementation loss
- Wideband implementation (up to 72MBaud)

These new features help increase the link's spectral efficiency and improve the signal-to-noise ratio at the receiving end. The new DVB-S2X standard can achieve up to 20% improvement in data rate for a single carrier transmission on a conventional 36 MHz C-band transponder.

Broadcast vendors have produced equipment that support HEVC and DVB-S2X. This equipment has already been implemented by leading satellite operators, making satellite a technically viable delivery solution for UHD channels.

## Remaining Challenges in UHD TV Implementation

Whilst satellites are already prepared for the distribution of HDTV content, other elements of the value chain are not as well prepared. Roadblocks need to be overcome and investments need to be made to facilitate the mass adoption of UHD TV by consumers.

When it comes to content creation and its subsequent aggregation into channels by channel operators, there is a distinct lack of UHD content. Many content creators have only recently begun to produce content in UHD. The saleability of UHD content to channel operators is one issue. Other issues are the price, availability, and trained use of UHD production equipment for recording, storing, editing and transmitting UHD content. Even though most broadcast production equipment such as cameras and playout servers have been upgraded to support UHD as of mid-2015, the full ecosystem of UHD production equipment still needs to be available and made affordable for more UHD content to be distributed. A new UHD channel will require a library of hundreds of hours of UHD content and the accumulation of this takes time. This lack of content is a major reason for the delay in the launching of UHD commercial services.

Another challenge is the hesitance of channel operators and TV platforms to invest further in UHD until the other party confirms their readiness. From the channel operators' perspective, they will aggregate and provide UHD channels when the TV platforms are ready to broadcast UHD channels. However before TV platforms upgrade their equipment to support UHD, they want more UHD channels to be available from channel operators. Both parties are waiting for the other to make the first UHD move.

TV platforms will also need to invest in UHD set-top boxes that are compatible with HEVC and DVB-S2X, and convince consumers to replace existing units with these new UHD set-top boxes. They will also have to decide on how to monetize future UHD services.

And finally, in the consumer market, although a recent study showed that roughly 60% of the flat screen TVs sold in Asia are 4K-ready, this does not indicate if consumers are ready to pay extra for UHD content. Early UHD TV models might not meet current UHD specifications, and while the world's first UHD disc player has just been introduced it is yet to be available for purchase.

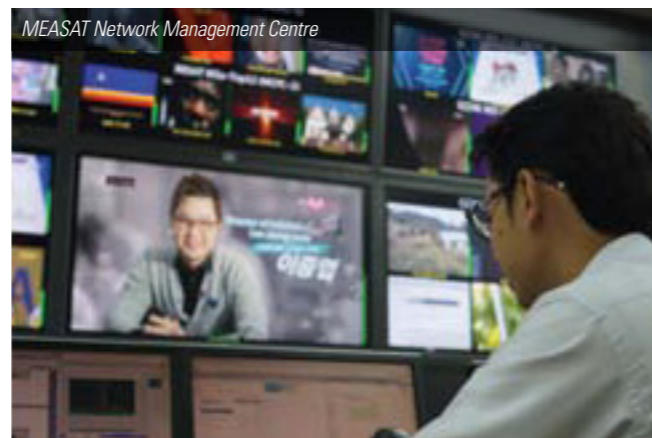



## UHDTV is Here to Stay

Despite various challenges and uncertainties that will require continued innovation, more content and crucial decisions, UHD sentiment remains high with it generally being accepted that UHD is the next stage in digital video's continuing evolution.

Consumer awareness of UHD will grow with more UHD trials which will coincide with major world events, such as the 2016 Olympics or World Cup 2018. The digital video value chain is also seeing progress across all stages. Content creators are ramping up UHD production for channel aggregation. Proven UHD distribution services are already available from leading satellite operators. Pay-TV operators are beginning to introduce UHD channels. Consumers have expressed UHD readiness with UHD TV sales increasing. And with the introduction of the world's first UHD channel in September 2015, UHDTV has arrived and is here to stay. 

### UHD Innovation and World's First UHD Channel Distributed via Satellite

There have been a number of trials over the last two years by broadcast operators to verify the performance of UHD transmission over satellite using DVB-S2 and DVB-S2X.

The first UHD transmission over satellite in Asia was carried out by MEASAT in 2013 with support from technology partners and TV manufacturers, using DVB-S2 transmission and H.264/MPEG-4 AVC compression. The trial proved that satellite is capable of supporting UHD video delivery for contribution or distribution.

More advanced trials and live demonstrations with DVB-S2X and HEVC followed. This culminated on 1st September 2015 with the launch of the world's first Ultra High Definition channel, whose distribution in Asia was provided by MEASAT. Beamed from 91.5°E, the region's leading video hot spot, the channel allows users in the Asia-Pacific, Middle East, Australia and Eastern Africa to enjoy a totally new TV viewing experience.



**John Loke** is MEASAT's Vice President, Network Engineering & Operations. He is responsible for managing MEASAT's Commercial Engineering division encompassing Customer Engineering, Network Management Centre, Product Development, and Value-Asses Service (Ground and IT) departments. John originally joined MEASAT in 2007 as Head of Customer Engineering and has more than 18 years of experience in the satellite industry. Prior to joining MEASAT, John was part of the pioneer team that started the ST-1 operation in Singapore Telecommunications Ltd (SingTel) in 1996. In SingTel, John managed the operating team of the ST-1 Telemetry, Tracking and Control (TT&C) system, and he is also a qualified Flight Dynamics Specialist. John holds a B. Eng (Electrical & Electronic Engineering) from Nanyang Technological University of Singapore.

# SATELLITE EVOLUTION Group

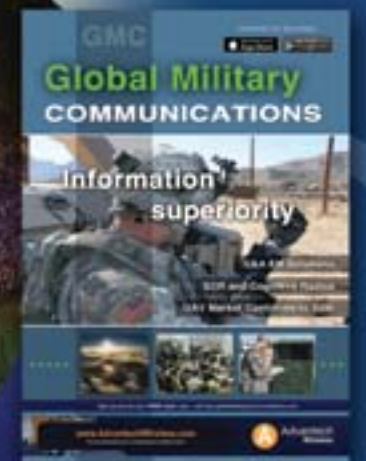

[www.satellite-evolution.com](http://www.satellite-evolution.com)

...your global marketing platform



## Interview with Pradman P. Kaul, President, Hughes Network Systems, LLC



### Q Looking back on 2015, how would you characterize the year for Hughes Network Systems?

- I would call 2015 a year of 360-degree success because of strides we made on three fronts: business, technology and corporate social responsibility.

On the business side, we saw continuing global demand for our JUPITER™ System with significant new sales in India, Russia, Turkey, Malaysia, Mexico, the Middle East, Africa and Southeast Asia. We surpassed five million satellite terminals shipped cumulatively to customers in more than 100 countries, representing close to 50 percent global market share in the satellite networking industry. HughesNet remains the world's largest satellite Internet service – now with over 1 million subscribers in North America – and Hughes Communications was again ranked #1 in the Indian VSAT market. We're also excited about our major technology and marketing partnership with OneWeb, a ground-breaking initiative to close the digital divide with a global constellation of LEO satellites. Hughes will play a particularly important role by developing the ground system, including gateways and terminals, and also employing the OneWeb network to deliver services to our global base of customers and distribution partners.

On the technology front, we released several new JUPITER-based products, including a high-throughput enterprise router to smooth the migration from C- and Ku-band to future HTS satellite services. New performance-enhancing features were introduced for both HughesON enterprise solutions and HughesNet Gen4 consumer service that help our customers get the maximum value from their bandwidth. In addition, we launched the first portable BGAN (Broadband Global Area Network) terminal for Inmarsat's mobile satellite applications.

Some of the most rewarding work we've done this year is through our partnership between the National 4-H Council and HughesNet, which introduces youth to STEM applications (science, engineering, technology and math) via hands-on learning and competitions – and hopefully gets them interested to pursue future technology careers.

### Q How is Hughes business in the Asia Pacific Region?

- Hughes won significant new business in the Asia Pacific region in 2015 and expanded in areas where we are already established.

Our Hughes India subsidiary continued its healthy growth, reporting a 12 month market share at 59% for FY 2014-15, with banking and rural installations as the key drivers along with delivering high-value broadband applications such as e-learning, digital cinema, and e-governance across the country's many towns and rural areas. In particular for e-learning, we've been working with various professional educational institutions to expand online training through the satellite-based Hughes Interactive Onsite Learning Platform. This novel solution enables online, live interaction among instructors in urban centers and professionals in towns across the country as though they were in the same room together – and not requiring the students to take leave from their daily work. Its important social and economic value was why Hughes was chosen for the "Changing Lives" award at this year's VSAT Global Satellite Industry Conference in London – which cited that in medical tutoring alone, over 25,000 students have been reached in 50 towns and cities. Other professional schools, namely the India Institute of Management Calcutta, the Indian Institute of Management, and the Indian Institute of Foreign Trade, have also adopted the same platform to deliver courses in leadership, management and international business.

In Malaysia, two of the country's largest satellite communications service companies purchased Hughes solutions in 2015: TS Global Network Sdn Bhd, chose the JUPITER system for a major technology upgrade of its C-band satellite network, and IPSAT Sdn Bhd, purchased a Hughes HX broadband satellite system comprising a hub and remote terminals.

We're optimistic that the Asia Pacific region will continue to be a source of growth for Hughes well into the future.

### Q From a technical standpoint, what were some key milestones reached in 2015?

- We made numerous technology improvements this year targeted to both service providers and end users, enterprises and consumers alike.



The cost and reliability of satellite connectivity has made satellite systems a viable option for medical coaching companies trying to span India's long distances.



Broadband satellite network solutions provide a virtual face-to-face experience with high-quality, high-clarity media that enables direct eye contact, two-way voice interaction, and chat-based queries.





*In India, franchise owners invest in small retail locations equipped with Internet classrooms. Students may travel to one of over 2,500 such centres to earn a college degree. Centres are equipped with two-way video and audio for maximum teacher/student interact*



At the provider level, our high-throughput HT1300 router gives operators the flexibility to use the JUPITER System over conventional C-band and Ku-band satellite capacity as well as Ka-band capacity, providing a seamless migration path to next-generation HTS services. It was designed specifically to meet the growing demand from enterprise customers for high-performance networks.

Airborne broadband service is a rapidly growing business and our successful relationship with Global Eagle (formerly Row44) in supplying their high-speed WiFi solution and satellite connectivity will now be further enhanced by the addition of aeronautical support on our JUPITER System platform.

For Inmarsat's global network, introduction of our Hughes 9211-HDR portable BGAN terminal is a first-of-its-kind product that supports communications-on-the-move applications by docking to active tracking antennas mounted on vehicles. It can connect at background IP speeds of up to 400+ kbps in both transmit and receive, while being used as a portable or on-the-move application.

At the consumer level, we updated our HughesNet® Gen4 service plans with a new generation of performance-enhancing innovations in downloading, browsing and data usage management. They're called Hughes SmartTechnologies™, and they let customers do more of what they want online without interruptions or running over their monthly data allowances. SmartTechnologies dramatically improve data compression, website loading, and media download speeds.

## Q What will 2016 bring for Hughes?

- 2016 will be another exciting year for Hughes. In the first half, we are planning to launch high-speed satellite Internet service for consumers and small businesses in Brazil. Late in the year, we anticipate the launch of EchoStar 19/JUPITER 2, a next generation Ka-band HTS satellite with over 150 Gbps capacity that will continue to power our HughesNet high-speed satellite Internet service in North America.

And throughout the year you can count on hearing about new developments in all of our enterprise, government and consumer platforms and services – because that's what Hughes is all about: Innovations in broadband technology, systems and solutions that keep us in front and move the industry forward. 

**Pradman P. Kaul** is president of Hughes Network Systems, LLC (HUGHES), a wholly owned subsidiary of EchoStar Corporation (NASDAQ: SATS). Previously, Mr. Kaul worked at COMSAT Laboratories. He has degrees from George Washington University and the University of California at Berkeley. He holds numerous patents and has published articles and papers on a variety of technical topics concerning satellite communications.



# The world runs on broadband. Hughes delivers it.

A country home in Oregon. A British supermarket chain with over 1,500 stores. A U.S. government agency. A financial services provider with a presence in 118 countries. What do they all have in common? They all need broadband. And they all get it from HUGHES.

For over three decades, Hughes has led the way in delivering advanced communications technology and services to every corner of the world. We pioneered high-speed satellite Internet for consumers and continually expand managed network solutions that fuel global enterprise and connect organizations of all kinds. Come with us and discover the possibilities.

For more information, contact us at [globalsales@hughes.com](mailto:globalsales@hughes.com) or visit [www.hughes.com](http://www.hughes.com)

**HUGHES**  
Connect to the future:

Business Consumer Government Defense Global [HUGHES.COM](http://HUGHES.COM)

© 2015 Hughes Network Systems, LLC, an EchoStar company. All rights reserved. HUGHES and CONNECT TO THE FUTURE are registered trademarks of Hughes Network Systems, LLC. EchoStar is a registered trademark of EchoStar Corporation.

An EchoStar Company



## Private Enterprise, Governments and Philanthropy in Asia's HTS Wireless Backhaul

Jose Del Rosario, Research Director, NSR

Based purely on market dynamics, Asia is the largest market for wireless backhaul via satellite currently and is projected to continue to be the dominant regional market in the globe over the long term. Asia is the fore-runner in wireless backhaul via HTS with the growing installed base of the Softbank/iPSTAR network in Japan, which has increased in terms of number of sites as well as bandwidth levels that support each site. Over the long term, Japan's use of HTS for wireless backhaul should continue to increase and continue to be at the forefront of advancing HTS use.

On the other side of the spectrum, the NBN Co HTS network sponsored by the Australian government will subsidize broadband access to its citizens that do not have broadband coverage. The government-led initiative ensures that all citizens independent of location will enjoy the same, if not close to the level of end user experience whether in an urban or rural setting. Although the NBN Co charter is for fixed broadband delivery, NSR believes that NBN Co's HTS satellites will be used for wireless backhaul as well given that form factors accessing the Internet are moving to smartphones, tablets and laptops.

These two examples based on different models and market players ensure that for these two countries at least, connectivity levels in rural and remote locations will be at par or close to the urban end user experience. At issue, however, is the rest of Asia, specifically developing and emerging Asian countries, which have not adopted HTS for wireless backhaul. SoftBank/iPSTAR has proven a business case in developed country markets and wealthy Australia's NBN is a unique arrangement, poised to succeed in connecting its citizens at ultra high-speed levels. But it remains to be seen if Asia's emerging and developing markets will follow suit. More importantly, will the unconnected in Asia be enabled by pure market forces or should governments intervene where each nation adopts an NBN-like program of their own?

The answer could lie somewhere in the middle or another player may be required to leverage the resources of both.

The private sector or pure market forces always "follow the money." The result, given that the Digital Divide

Commercial Space Aeronautical  
**Over 15 Years of  
 Ahead of the Curve Analysis**

Unique Actionable Intelligence

UltraHD Hybrid & Emerging Markets

**NSR's Mission.** Land-Mobile

Providing Industry Leading Maritime

Market Research and Consulting Services

in Satellite and Related Industries M2M/IoT

to Clients Around the World. Global

Satellite Launch

Earth Observation Nanosats

Ahead of the Curve Analysis

Broadcasting and Digital Media

Capacity Analysis SATCOM

HTS Geostationary Satellite

Low Earth Orbit

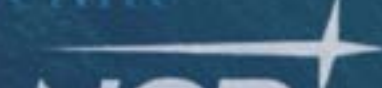
**NSR** 

**www.nsr.com** NORTHERN SKY RESEARCH



in Asia and elsewhere has widened, is a market failure when it comes to enabling broadband capability in poor communities. The all important ARPU level is the measure by which an investment in a given community is justified, whereby the question of - "Is the ROI in a given town, community or area sustainable?" - needs to be positively answered first before investments can be realized.

When market failures occur, governments intervene to correct or address such failures. In addressing the digital divide, governments have stipulated Universal Service Obligations (USO) to wireless operators in the licensing process. Governments also collect taxes towards funding Universal Service Funds (USF). USO and USF aim to bridge the widening Digital Divide as well as usher in economic development given that cities, townships or areas that have higher broadband access capabilities result in higher economic growth. As such, improving the broadband access capability of a city, town or area automatically leads to economic improvement.

Basically, there is market failure and governments (except for Australia) that have intervened have fallen short in bridging the broadband gap. Not for a lack of trying but one measure, either private enterprise or government, working independently has not resulted in improving rural connectivity with the added benefit of economic improvement.

So what does this all mean for satellite backhaul in Asia? It is worth mentioning that one of the more interesting and noteworthy announcements and events late this year included the following:

- During the Indian prime minister's visit to Silicon Valley, it was reported that Microsoft and Google announced initiatives to fund broadband and public Wi-Fi in villages and railway stations across India.
- Mark Zuckerberg announced in the United Nations that Facebook would be delivering connectivity to refugee camps across the world.
- It was reported as well that the United Nations' "To transform our world: the Program of sustainable development for 2030" was unanimously voted by the 193 member states and the "worldwide access to the Internet" project passed with an annual budget in the \$billions covering a 15-year period to be made available for countries where Internet connectivity is still low.
- Outside of Asia, Eutelsat and Facebook announced a multi-year agreement with Spacecom, where the two companies will utilize the entire broadband payload on the future AMOS-6 satellite and will build a dedicated system comprising of satellite capacity, gateways and terminals in providing reach to large parts of Sub-Saharan Africa.

Having discussed the role and track record of private enterprise and governments, the initiatives above have one additional element in the mix: Philanthropy. Although details are still not fully available such as service costs, equipment price, how and who will be paying for the satellite-based service, whether the platform is fixed or wireless, and many others, there are new players involved in the experiment that will be funding various programs.

Just as the Facebook/Eutelsat/Spacecom undertaking in Sub Saharan Africa will be a test case over the next decade to see if the public/private sector collaboration works, India will be the test case that can be replicated in other countries in Asia if or when it succeeds.

NSR's take: Governments such as India's, non-governmental organizations such as the U.N. and Internet.org, and the private sector with companies such as Google, Facebook and Microsoft will usher in improved con-

nectivity that brings economic improvement to underserved markets. This in turn will result in the private sector or market forces justifying investments due to the possibility and improvement of ROI. In a way, the vicious cycle of poor communities with low connectivity levels being left behind by a widening digital gap that further leads to worsening poverty levels can be turned into a virtuous circle where improved connectivity leads to economic growth, ushering in private sector investments on wireless networks. Simply put, adding philanthropy to the mix, meaning the infusion of capital that specifically targets the connectivity needs of the poor, is a way of improving the ARPU levels of poor communities that should bring in private sector investments.

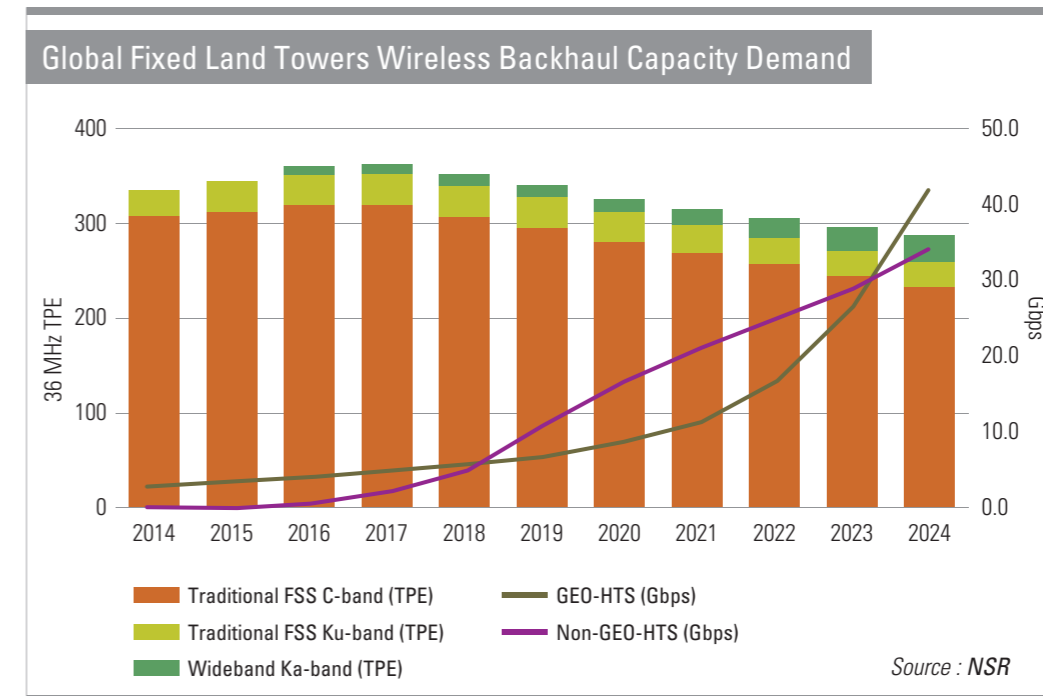

From a technical solution standpoint, HTS is the most efficient platform to run wireless backhaul such that NSR foresees a shift from traditional FSS demand on C-band and Ku-band to HTS over the long term. This includes HTS capacity on C-band frequency such as Intelsat's EpicNG. And this is expected to be on a global level as well.

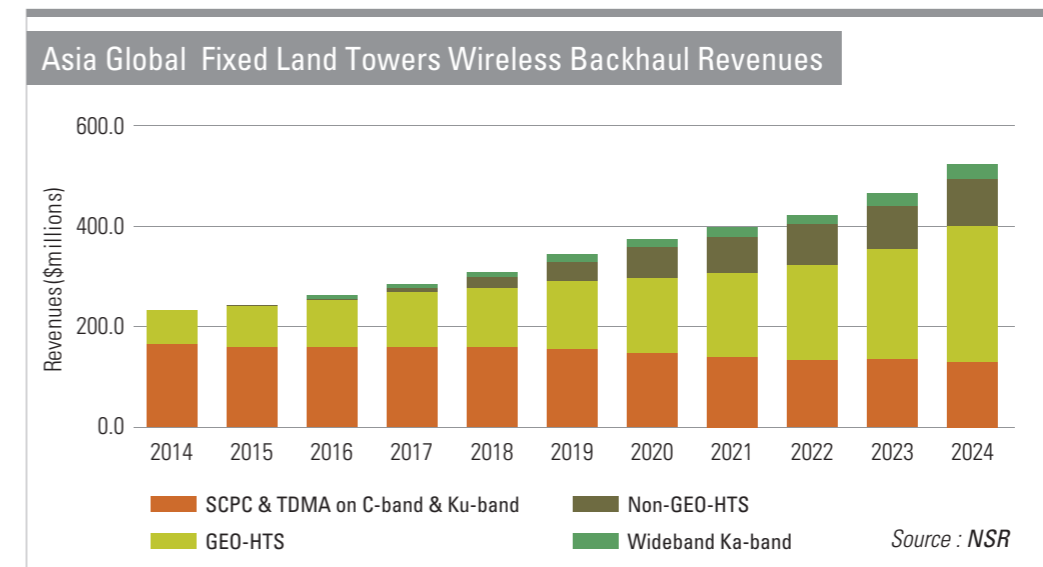

More importantly, the market potential in terms of HTS usage is expected to grow at very high levels. NSR is not expecting an equalization of urban and rural usage levels or bandwidth speed levels; however, NSR is advocating for a narrowing gap between urban and rural capabilities. For instance, if the urban user with a higher ARPU level is enjoying 1 Mbps throughput, the rural user with 256 Kbps or even 128 Kbps capability is acceptable. The gap is still wide but it enables the rural user to run applications at reasonable speeds and run the same applications as his urban counterpart.

From a cost perspective, HTS is far more justifiable when looking at ROI in the case of the private sector as well as USF/development funds in the case of governments and NGOs. As such, investments, procurement and revenue streams in Asia should see a shift as well from traditional capacity to next-generation HTS systems.

**Bottom Line**

The game change that has taken place in the satellite industry via HTS has not impacted the lives of the “other three billion” unconnected people of the globe. Some HTS plans have changed course from originally connecting Africa to targeting the Pacific Islands and wealthy passengers on cruise ships.

The free market is not always the most efficient means of delivering services and in the case of broadband and wireless access, it has failed when measured against the connectivity levels of a large part of Asia as well as other regions such as Sub Saharan Africa. Governments have likewise tried but have fallen short in bridging the digital gap via USO and USF.

The good news is that initiatives that involve both public and private entities in a collaborative effort led by philanthropy should result in higher connectivity in underserved regions and a narrowing of the digital divide. This, private/public/philanthropic collaboration, in the end may usher in the real game change that HTS could bring to Asia and other parts of the globe.

A final note: Organizations such as the APSCC could become an agent of change and an engine of growth as it can bring together governments, the private sector and philanthropists to design a digital divide initiative across Asia. [A](#)



**Jose Del Rosario** is a senior member of the consulting team where he focuses his research on quantitative modeling, data verification, and market forecasting for the commercial and government satellite communications sectors. He conducts ongoing research with specialization in policy analysis, economic indicators, regulatory initiatives and end user demand trends. In addition to authoring numerous syndicated reports in his areas of focus, Del Rosario has been involved in a wide range of strategic consulting projects. He has advised clients on market trends, implications, and strategies on such diverse topics as high throughput satellites (HTS), hosted payloads, wireless backhaul, SCADA/M2M/LDR and multi-mission satellite programs.



**No. 1 Broadcast, Satellite, Digital Entertainment & Media Event In Middle East, Africa & South Asia**

**Covering all Filmed Entertainment and Audio Content**



**WHAT'S NEW?**

<b>CONTENT CONGRESS</b> 	<b>AERIAL ROBOTICS AND DRONE ZONE</b> 	<b>CXO ROUNDTABLES</b> 
<b>TRAININGS</b> Final Cut X Advanced Techniques 	<b>HD SHORT FILM COMPETITION</b> 	<b>24 HOUR LIVE HACKATHON</b> 

**FOR EXHIBITING & SPONSORSHIP OPPORTUNITIES**  
CONTACT US ON: +971 4 308 6077/6282 CABSAT@DWTC.COM WWW.CABSAT.COM





## UHD? Not Without DVB-S2X!

Hans Massart, Market Director Broadcast, and Kerstin Roost, Public Relations Director, Newtec

*Beyond four times (4K) the resolution of High Definition (HD) video, true Ultra HD (UHD) delivers a more immersive viewing experience, boosting picture detail and sharpness, as well as providing more realistic and richer colors.*

*Until recently, the UHD market has mainly been driven by TV manufacturers. Now it is set to expand, providing opportunities for the whole value chain from content suppliers through to service providers and equipment manufacturers.*

*Although the timescale for UHD mass deployment may vary from 2016 to 2023, according to different analysts, it is commonly acknowledged that UHD is becoming 'the new normal'. Several satellite operators have already launched UHD services or are planning to launch them in the very short-term, including, for example, Eutelsat, Intelsat, and SES. Several service providers worldwide also stand firmly behind the deployment of UHD services, such as DirecTV, Dish Network, Sky Germany, India's Videocon and Tata Sky, to name just a few.*

*Further East, Japan's SKY Perfect JSAT has already launched three UHD channels, while the nation is ramping up to cover the Tokyo 2020 Olympics with even Super Hi-Vision 8K.*

*But with capacity already at a premium due to trends like HD video generating high bitrate streams, is the satellite industry ready to cope with a UHD world?*

### 4K UHD Requirements

Broadcasting HD – which has grown to become hugely popular – requires more bandwidth than broadcasting in Standard Definition (SD), even if more efficient coding (H.264/AVC) is used.

In order to launch 4K channels, again more bandwidth is required, as the efficiencies introduced by even

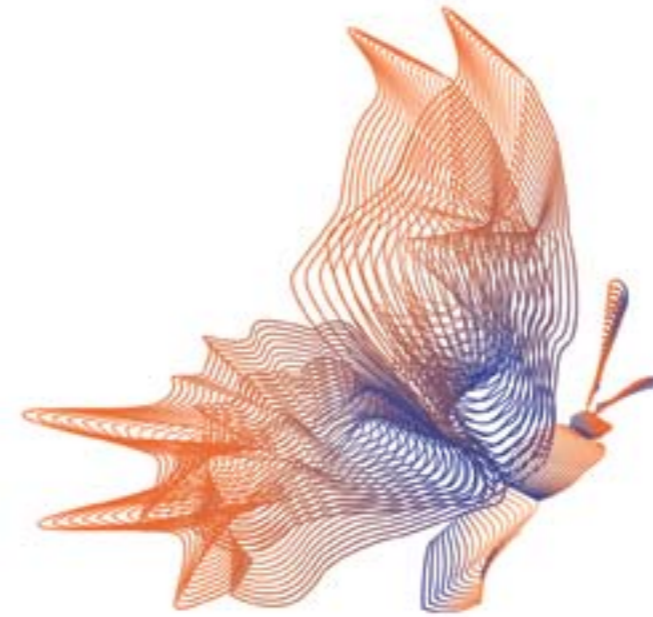

# PTC'16

## Reimagining Telecoms

17-20 January 2016 | Honolulu, Hawaii  
Hilton Hawaiian Village® Waikiki Beach Resort

### Join Key Industry Leaders at PTC'16 in Honolulu



**Hugh Bradlow**  
Chief Scientist, Telstra, Australia



**Vinton Cerf**  
VP & Chief Internet Evangelist, Google, USA



**Steve Collar**  
Chief Executive Officer, C3 Networks, USA



**Margaret Dawson**  
Global Product Marketing, Red Hat, USA



**Masao Fukushima**  
General Manager, ITS Technical Consultant, Nissan Motor Co., Ltd., Japan



**Yuji Inoue**  
Chairman of the Board, Toyota Info Technology Co., Ltd., Japan



**Peter Jackson**  
CEO, P2Square Ltd., Hong Kong SAR, China



**Katsumi Nakata**  
Senior EVP, NTT Communications, Japan



**Seizo Onoe**  
CTO, EVP, Member of Board of Directors, and Managing Director, R&D Innovation Division, NTT DCOMO, Inc., Japan



**Tricia Paoletta**  
Partner, Harris, Whitefire & Grannis LLP, USA



**Robert Pepper**  
VP, Global Technology Policy, Cisco, USA



**Jill Singer**  
VP, National Security, AT&T Government Solutions, USA



**Koichi Suzuki**  
Chairman & Chief Executive Officer, Internet Initiative Japan Inc., Japan



**Ihab Tarazi**  
Chief Technology Officer, Eiparis, Inc., USA



**Jack Waters**  
Chief Technology Officer, Level 3 Communications, USA



**Rick Whitt**  
Corporate Director for Strategic Initiatives, Google Access Team, Google Inc., USA



**Greg Wyler**  
Founder, OneWeb, USA



**Houlin Zhao**  
Secretary-General, ITU, Switzerland

REGISTER TODAY AT [PTC.ORG/PTC16](http://PTC.ORG/PTC16)

more efficient coding (H.265/HEVC) are outweighed by the significantly higher resolution. Where an HD channel may require an average of up to 5 Mbps, the same channel in UHD may require up to 20 Mbps.

This is a challenge which broadcasters, satellite operators and satellite service providers need to address as the uptake of 4K UHD begins to gather pace.

Sports event broadcasting was the obvious candidate to adopt UHD first, providing a real 'in the stadium' perspective and moving away from looking at a picture inside a box. Aside from large contribution trunks, Satellite News Gathering (SNG) and Direct-to-Home (DTH) applications are also affected by a migration to UHD.

Consequently, now is the time for the satellite industry to ensure it is prepared for the growing popularity of 4K UHD TV by investing in technologies which support the latest standards and go hand-in-hand with 4K UHD TV.

### Introducing DVB-S2X

The new transmission standard, DVB-S2X, and High Efficiency Video Coding (HEVC) are just two examples of technologies which the satellite industry needs to consider investing in.

In comparison with DVB-S2, DVB-S2X – released in February 2014 – results in an efficiency gain of between 15% and 30% in a typical distribution network (including DTH), increasing to up to 51% in selected contribution networks; see Figure 1. This exceeds the results from proprietary systems available today.

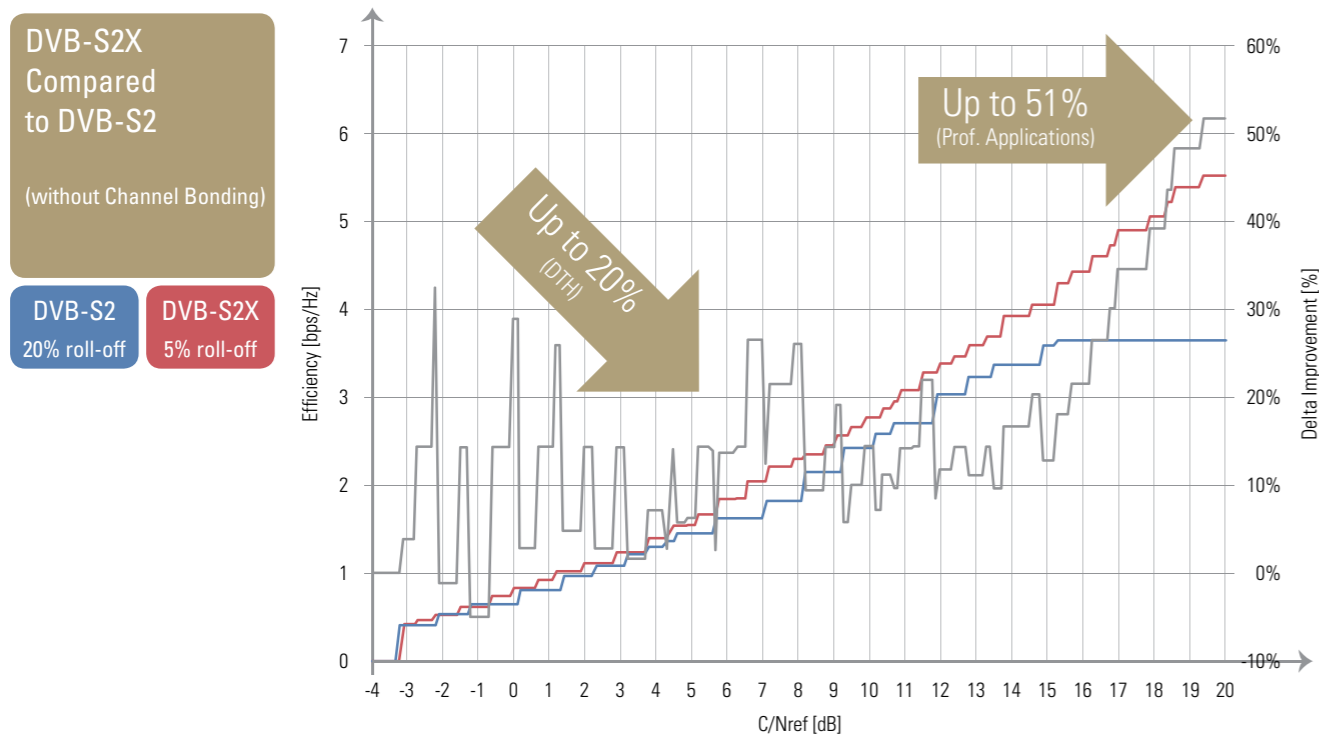

Figure 1. DVB-S2X with 5% Roll-off Compared to DVB-S2 with 20% Roll-off

Improvements include smaller roll-offs, advanced filtering of satellite carriers and increased granularity in MODulation and CODing schemes (MODCODs). It also features higher order modulation (64/128/256APSK)

support, linear and non-linear MODCODs, better implementation of MODCODs and wideband support, as well as very low Signal-to-Noise Ratio (SNR) support for mobile applications, channel bonding and additional standard scrambling sequences to mitigate co-channel-interference.

As shown in Figure 2, the advantages of efficiency technologies can be stacked, which leads to more bandwidth, better picture quality, additional channels, a higher link margin or an increased satellite footprint.

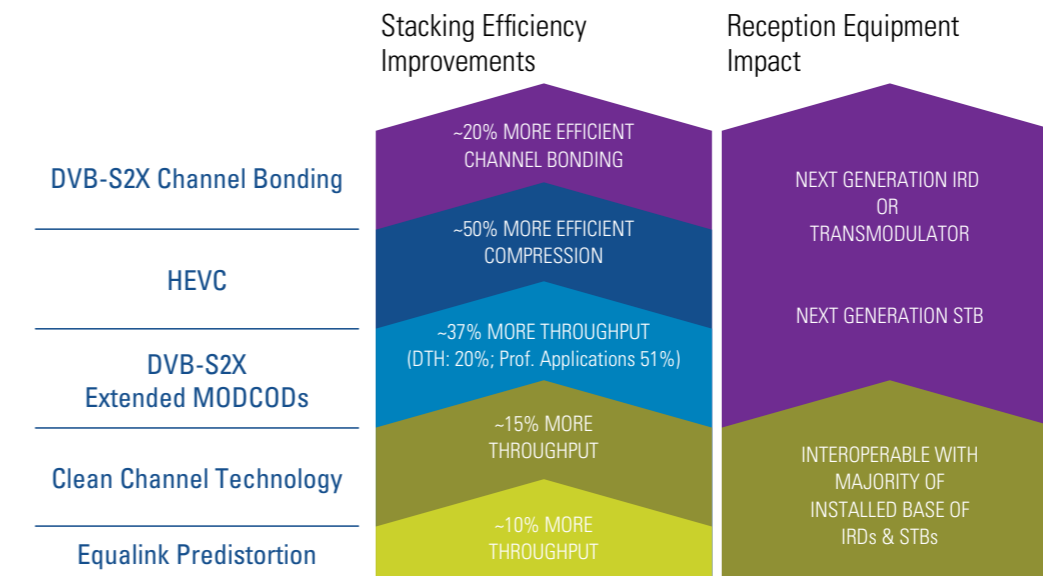
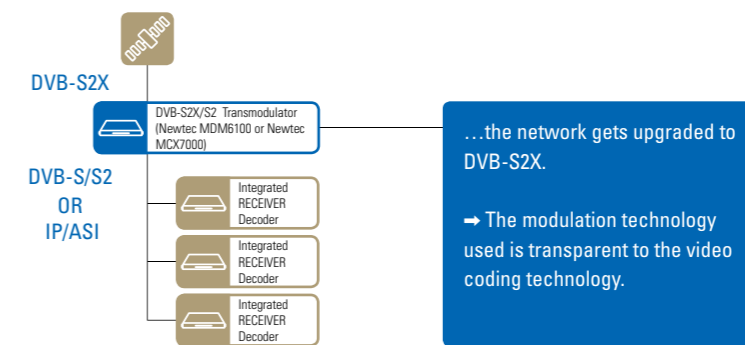

Figure 2. Stacking Efficiency Improvements & Reception Equipment Impact

For content contribution and primary distribution to remote headends or DTT towers, where both transmission and reception equipment is of professional grade, upgrading the equipment to the DVB-S2X standard already makes sense today, as the reduction of satellite OPERational EXPenditure (OPEX) significantly outweighs any CAPital EXPenditure (CAPEX) of swapping modems. By making use of DVB-S2X/DVB-S2 (or DVB-S2X/DVB-S) transmodulation, the installed base of existing IRDs may be preserved, effectively allowing operators to decouple the modulation migration to DVB-S2X from the coding migration, for example, from AVC to HEVC; see Figure 3.

### By Adding one Box only per remote site...



#### Gained Benefits

- More channels
- Higher picture quality
- Higher link margin
- Increase footprint
- Decouple modulation migration from coding migration decision (=flexibility)

Figure 3. Adding a DVB-S2X/S2 Transmodulation Device



In the case of DTH, as new set-top boxes are required to receive 4K and benefit from HEVC anyway, it is only logical to go for one which is also DVB-S2X compatible as soon as possible. This is reinforced by the fact that chipsets supporting DVB-S2X are becoming readily available.

## Channel Bonding

Within the improvements DVB-S2X delivers, channel bonding is particularly important.

A single high bitrate transport stream is created, whereby channels are statistically multiplexed. Channel bonding allows this single stream to be distributed over up to three transponders, treating them as if it was a single one. This operation dramatically increases the efficiency of a broadcaster's operations.

Under the assumption a UHD channel requires about 20 Mbps (see Figure 4), in a traditional 36 MHz transponder it is possible to transmit about three UHD channels, totaling about 60 Mbps. The statistical multiplexing gain obtained by multiplexing three channels is fairly low. When spanning three transponders, a total of nine channels can be hosted.

### Channel Bonding calculation: Example

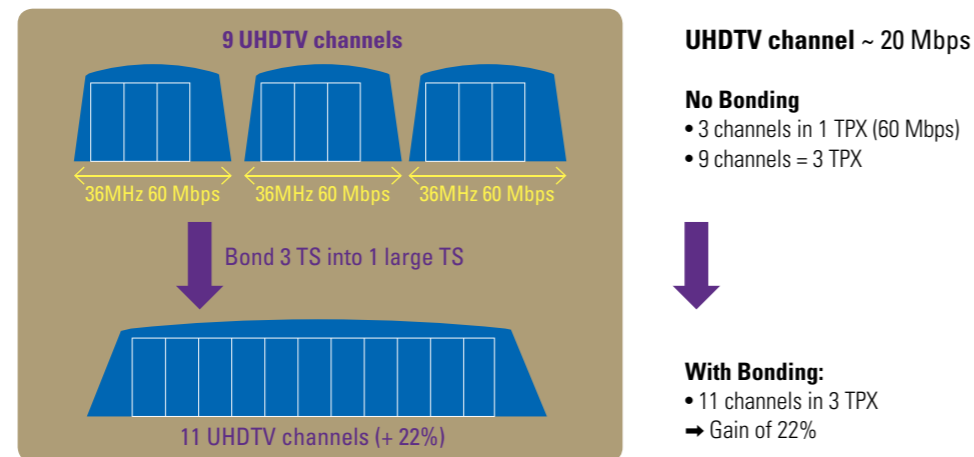

Figure 4. Channel Bonding Example Calculation

With DVB-S2X Channel Bonding, the accumulated gain provided by statistical multiplexing will allow broadcasters to host up to 11 channels on three transponders.

## Wideband

Another important improvement of the DVB-S2X standard is that it supports technology for typical wideband transponders, which are available today to host high-speed data links. The wideband implementation in DVB-S2X typically addresses satellite transponders with bandwidths from 72 MHz – typically C-band – up to several hundred MHz – Ka-band and High Throughput Satellites (HTS).

The DVB-S2X demodulator will receive the complete wideband signal up to, for example, 72 Mbaud, resulting in a very high data rate. The introduction of the wideband technology facilitates transmission of UHD content.

## DVB-S2X with 256APSK Is a Reality

Perhaps the most exciting part of DVB-S2X is that the benefits it brings are already being demonstrated by and delivered to a number of broadcasters.

The world's first DVB-S2X 256APSK satellite transmission, for example, was successfully completed by Japan-based Nippon Television Network Corporation (Nippon TV) with Newtec technology in November 2014; see Figure 5 '256APSK Constellation Diagram'.

The test followed Nippon TV's interest in the new DVB-S2X modulation standard for its next-generation video network over Japan. Considering the benefit of the 5% roll-off technology that saves satellite bandwidth, Nippon TV wanted to establish the feasibility of using this higher modulation and see if the associated challenges could be overcome.

Nippon TV transmitted a 256APSK carrier in a 5 MHz slot from an SNG truck to JSAT's Superbird-B2 satellite. The transmission was successfully received at Nippon TV's headquarters in Minato, Tokyo.

Newtec's MDM6100 Broadcast Satellite Modems transmitted 25 Mbps from the SNG truck using a 1.4m antenna, which was received on a 5m dish at the TV station.

## Beyond 4K: 8K

The same technologies which increase efficiency to enable 4K content can also be applied to enable 8K content. The channel bonding feature implemented on DVB-S2X, as discussed above, is not only beneficial when broadcasting 4K video channels by treating up to three transponders as a single large transponder but also allows the splitting of an 8K contribution signal, which may consume as much as 140 Mbps to 180 Mbps, over more than one transponder.

From Newtec's point of view, as shown in Figure 3 'Adding a DVB-S2X/S2 Transmodulation Device', the modulation and demodulation equipment is transparent for the video format, as well as for the encoding technology used. Hence, upgrading the contribution and distribution chain to DVB-S2X today for efficient 4K UHD transmission, is a safe investment if 8K transmissions are also being considered.

## Improving Performance on Top of DVB-S2X?

In addition to DVB-S2X, there are other techniques that broadcasters can use to increase the efficiency and availability of their operations.

These advanced transmission technologies can increase the capacity by up to 50% – and without increasing OPEX.

Our pre-distortion technology Equalink® 3, for instance, is designed to compensate for the effects of imper-

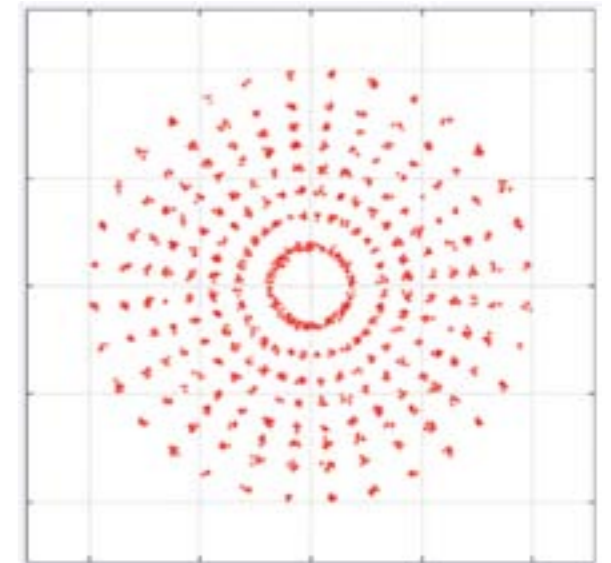

Figure 5. 256APSK Constellation Diagram



Figure 6. Japan-based Nippon Television Network Corporation (Nippon TV) has successfully completed the world's first DVB-S2X 256APSK satellite transmission using Newtec technology

fections in the satellite's filters and amplifiers. By installing this technology, the performance of the end-to-end satellite communication channel is typically improved by 2dB. This can be more when a higher modulation scheme (such as 16/32APSK or 64/128/256APSK on carriers occupying a full transponder) is enabled. The result is a bandwidth efficiency gain of 10% and more. This is even the case when used on saturated non-linear transponders.

### Conclusion

As the successor to the DVB-S2 standard, DVB-S2X accommodates increased profitability, interoperability and growth in the satellite communications market – all of which is particularly relevant when talking about delivering UHD TV.

Applications such as sports contribution and distribution are leading the way to 4K becoming 'the new normal' in the years ahead.

The combination of the technologies implemented on DVB-S2X result in an efficiency optimization of up to 51% in a professional satellite link. For DTH networks, the average gain will be around 20%, even when the gains from channel bonding are excluded.

Indeed, if UHD is to become as popular as HD, DVB-S2X will be essential in guaranteeing the best performance with barrier-breaking throughputs at optimal service availability.

For over a year, Newtec has already supported the DVB-S2X standard across its portfolio of professional modulators, demodulators, modems (6000 & 7000 series) and hubs (HUB6000). DVB-S2X is also supported by the Newtec Dialog® multiservice broadcast (MSBC) solution. Soon this standard will also be supported on the Newtec Dialog VSAT platform, enabling unprecedented performance and efficiency across a wide range of applications, including low-speed, enterprise, mobility and high-speed trunking. [A](#)



**Hans Massart** has more than 15 years of experience in the broadcast industry. Before joining Newtec in 2012, he served for fourteen years in various sales and business development positions on a European scale at Cisco, Scientific-Atlanta and BarcoNet. In 2012, he became Newtec's Director of Strategic Business Development and was appointed Market Director Broadcast in 2014.



**Kerstin Roost** is Public Relations Director at Newtec. Based in Luxembourg, Kerstin has 17 years' experience in the IT, media and satellite communications industry with cross-function expertise in strategic PR & communications, marketing, sales, customer support and engineering. Before joining Newtec's global marketing and sales team, Kerstin started to work for Newtec in 2004, first as software and support engineer for its Berlin division in Germany in the TCP/IP software team (Tellitec Engineering), and later as marketing manager for the related software and solutions.

# CONVERGENCE INDIA

## Your "Digital India" Platform



"Digital India"

Convergence India 2016

International Exhibition & Conference

Pragati Maidan, New Delhi

20-22 January 2016



### REGISTRATION OPEN FOR VISITORS & DELEGATES

**400+** Exhibitors

**20,000+** Business Visitors

**150+** Domestic & International Speakers

**1500+** Conference Delegates

**30+** Countries

### Technologies on Display

- 4G/LTE
- Broadband and Internet
- Internet of Things
- Broadcast
- Pay TV
- TV Digitization
- OTT
- Smart Solutions
- Cloud Services
- Big Data & Analytics
- Smart Phones
- ICT Manufacturing
- e-Commerce
- Apps for the World

Organiser



Exhibitions India Group

Support

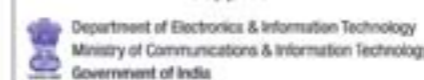

Supporting Association



For Exhibition & Conference, please contact:

Mr. Yash Menghani, Senior Manager, yashm@eigroup.in  
217-B, Okhla Industrial Estate, Phase III, New Delhi 110 020  
Tel: +91 11 4279 5000 | Fax: +91 11 4279 5098

[www.convergenceindia.org](http://www.convergenceindia.org)



# APSCC MEMBERS

## Platinum Member



## Regular Member



## Gold Member



## Affiliate Member



## Regular Member (Government)



# The 18<sup>th</sup> Asia-Pacific Satellite Communication, Broadcasting and Space Conference & Exhibition, APSCC 2015 Satellite Conference and Exhibition



22-24 September 2015, Coex Convention Center, Seoul, Korea

The 18<sup>th</sup> Asia-Pacific Satellite Communication, Broadcasting and Space Conference & Exhibition (APSCC 2015), an annual flagship event of APSCC was held on 22 - 24 September 2015 at Coex Convention, Seoul, Korea.

The APSCC 2015 Satellite Conference focused on exchanging information on the new technologies and services strategies for the satellite industry as well as assessing new developments in technology for business breakthroughs in the Asia Pacific region. Over 80 senior level officers and professionals from the satellite business arenas participated as speakers for the 16 sessions at APSCC 2015.

In conjunction with the Conference, the **APSCC 2015 Satellite Exhibition** was held on 22 - 24 September 2015. 9 leading players of the industry including GMV (Spain) / Intellian (Korea) / L3 (USA) / Kratos Integral Systems (USA) / Ktsat (Korea) / KT Skylife (Korea) / SELFSAT (Korea) / SeraData (UK) / Thuraya (UAE) participated as exhibitors to introduce their latest technologies, innovations, products and services.

This year, 19 companies officially sponsored the event through various networking programs and 19 affiliations supported APSCC 2015 as endorsers

The **2015 APSCC Awards Ceremony** was held on 22 September 2015. Based on a series of criteria set by the Awards Selection Committee, the awards are presented each year to individuals and organizations whose



contributions and achievements have been deemed exceptional by the satellite industry and the Awards Selection Committee, consisting of industry experts. The 'Satellite Executive of the Year in the Asia-Pacific Award' was presented to Samer Halawi, CEO, Thuraya and the 'Lifetime Achievement Award' was presented to and Yutaka Nagai, Adviser, APSCC, respectively to commemorate their achievements.

The **4<sup>th</sup> Satellite Radio Frequency Interference Mitigation Forum** was held on 24 September as part of the conference program. The Satellite RF Interference Mitigation Forum was to continue multilateral talks among satellite operators in the region and to maintain a mutual operation contact point for the prevention of and prompt response to interference. The Forum provided a platform for satellite operators to discuss on the methods of preventing interference and coming up with a realistic solution to satellite interference by satellite operators in the region.

Overall the APSCC 2015 event in Seoul Korea gathered **over 470 attendees from 26 countries**.

Hosted by the Asia-Pacific Satellite Communications council (APSCC), the APSCC Annual Satellite Conference and Exhibition has been representing an unparalleled opportunity to reach the satellite community in Asia for more than a decade. The APSCC 2016 will be held on Kuala Lumpur, Malaysia.

For more information on the APSCC 2015 event report, please visit [http://www.apsc.or.kr/sub3\\_3.asp](http://www.apsc.or.kr/sub3_3.asp)





# SATELLITE INDUSTRY NEWS

## Arianespace to Launch GSAT-17 and GSAT-18 Satellites for India

November 10, 2015 - The Indian Space Research Organisation (ISRO) has chosen Arianespace to launch its GSAT-17 and GSAT-18 telecommunications satellites. The two satellites will be launched by Ariane 5 launch vehicles at the Guiana Space Center, Europe's Spaceport in Kourou, French Guiana, in 2016 and 2017. The GSAT-17 and GSAT-18 satellites, designed, assembled and integrated by ISRO, will each weigh around 3,400 kg at launch. They are planned as replacement satellites for the currently operational satellites providing key national services in multiple frequency bands including C, Extended-C and Ku Bands.

## Arabsat Badr-7 Successfully Launched

November 10, 2015 - Arabsat's first Satellite of the 6th generation, "Badr-7" was launched successfully from Kourou base in the island of French Guyana in South America by the Ariane 5 Rocket. The Ariane 5 rocket blasted off carrying Badr-7, a Eurostar satellite, manufactured by Airbus Defense & Space with Thales Alenia Space, to be placed in ARABSAT exclusive orbital hotspot 26 degrees East. This Step Comes as part of ARABSAT ambitious expansion projects, and it is the 6th satellite launched during the past seven years on three deferent orbital positions to provide diverse services of TV broadcasting and Telecommunications services. Badr-7 will join Arabsat satellites Badr -4, Badr-5 and Badr-6 on its exclusive TV Broadcasting orbital position 26 degrees East.

## Hughes and Telesat Sign Agreement for High-Throughput Capacity

November 11, 2015 - The agreement calls for Telesat to deliver Ka-band capacity of 31 Gbps on T19V covering many countries in South America, which Hughes will utilize to expand its broadband satellite services for consumers. High-throughput JUPITER™ technology from Hughes will be deployed for the ground system and customer premises equipment. Telstar 19 VANTAGE, which will be co-located with our Telstar 14R satellite at 63 degrees West, is the second of a new generation of Telesat satellites designed with high-throughput capabilities optimized to serve the types of bandwidth intensive applications at which Hughes excels. In addition to its high-throughput Ka-band capacity for Hughes, Telstar 19 Vantage will bring significant additional state-of-the-art Ku-band capacity to Latin America, providing users in the region with greater choice and the competitive advantages they need to succeed in the markets they serve.

## International Launch Services Announces Multi-Launch Agreement with Intelsat

November 11, 2015 - International Launch Services (ILS) announces a Multi-Launch Agreement with Intelsat for five ILS Proton missions through 2023 from the Baikonur Cosmodrome in Kazakhstan. The Multi-Launch Agreement is designed to provide Intelsat with increased flexibility in their fleet management and the necessary launch schedule assurance that they require. The five satellites, yet to be designated, will be launched using the Proton Breeze M launch vehicle, manufactured by Khronichev State Research



## SmallSat Symposium™ The Small Satellite Business & Finance Show

February 23-24, 2016  
www.smallsatshow.com

The SmallSat Symposium promises to unlock not only the technology, but the business, financial and legal know-how of the flourishing small satellite market. Hosted in the heart of Silicon Valley, the Symposium is where leaders, supporters, investors, and activists network. Through a wide range of thought-provoking panels and visionary speakers, discover the innovations enabling the rapid growth of the industry.



### 18 in-depth Business and Finance Sessions

- No Longer Small – Differentiating Miniature Satellites, Growth of the sector
- NASA's Role in Supporting Leading Technologies
- Risks & Regulations In Small Sat Launches
- Financing New Small Sat Operations
- Promising Areas for the Future – The View from the Academic and Business Worlds
- The Operational Environment – Policy/Regulation
- Launch Provider Roundtable – Efficiency & Innovation
- COTS – Their new role in space based hardware
- Cost Savings & Budgetary Considerations in Small Satellite Alternatives
- Earth Observation
- Mobile Communications – Phone & Data
- Structuring Financial Alternatives
- Hosted Payloads & Shared Launches – Key differences, costs and advantages
- Legal Considerations for Small Sat Operators
- Defense/ Government
- Structuring Small Satellite Operations
- Effective Evaluation of Technical Bottlenecks

### Select Speakers To Date

Arianespace	Clayton Mowry
Boeing Space	Erik Daehler
Boreal Space	Barbara Plante
Ecliptic Enterprises	Rex Ridenoure
Euroconsult & Irwin Communications	Sue Irwin
GeoOptics Inc.	Dr. Alex Saltman
Google-Skybox Imaging	Joe Rotherber
Hogan Lovells	Randy Segal
Kritos Technology & Training Solutions	Stuart Daughtridge
Kymeta	Dr Nathan Kundtz
Lux Capital	Dr Shahin Farshchi
Milbank, Tweed, Hadley & McCloy	Dara Panahy
Nanoracks LLC	Jeffrey Manber
NASA Ames Research Center	Roger Hunter
Near Earth LLC	Hoyt Davidson
OmniEarth	Lars Dyrud
Orbital ATK, Inc.	Amer Khouri
Planet Labs	Ben Haldeman
Pumpkin Inc, Stanford University	Dr. Andrew Kalman
Raymond James	Chris Quilty
Silicon Valley Space Center	Dr. Sean Casey
Spaceflight Industries	Jason Andrews
Space Angeles Network	Amir Blachman
SSL - Space Systems Loral	David Lackner
Summit Ridge Group, LLC	Armand Musey
Thales Alenia Space	Sami Ben Amor
ULA - United Launch Alliance	Keith Karantzios
Virgin Galactic	William Pomerantz

Hosted By:



Limited Spaces Available - Book Now  
www.smallsatshow.com

and Production Space Center (Khrunichev), the majority owner of ILS and one of the mainstays of the space industry. Proton has launched 407 missions since its maiden flight in 1965. Under the auspices of ILS, there have been 91 ILS Proton missions launched for global commercial satellite operators.

### **Thales Alenia Space to Build Bangabandhu Telecommunication Satellite for Bangladesh**

November 11, 2015 - Thales Alenia Space has signed a contract with BTRC (Bangladesh Telecommunication Regulatory Commission) to build the telecommunications satellite, Bangabandhu. As program prime contractor of this turnkey system, Thales Alenia Space is in charge of the design, production, testing and the delivery in orbit of the satellite. Built on the upgraded Spacebus 4000B2 platform, Bangabandhu will be fitted with 26 Ku-Band and 14 C-Band transponders. The satellite's coverage zone encompasses the Bangladesh and the surrounding region. This system will offer capacity in Ku-Band over Bangladesh and its territorial waters of the Bay of Bengal, India, Nepal, Bhutan, Sri Lanka, Philippines and Indonesia; it will also provide capacity in C-Band over the whole region. Thales Alenia Space will also take charge of the ground segment, which will benefit of the SpaceOps Thales Alenia Space tools for the mission planning and monitoring. It includes two ground facility buildings gathering Satellite Control and Network Operations Center based on the SpaceGate Thales Alenia Space global solution. Spectra Engineers Ltd., Thales partner in Bangladesh, is in charge of the civil work of the ground facilities. To be launched in 2017, this Bangladesh's first satellite will be positioned at 119.1 degrees East longitude.

### **Hinduja Group's HITS Service on Thaicom 7**

November 12, 2015 - Thaicom announced its Thaicom 7 satellite is now fully booked following an order from Grant

Investrade Ltd (GIL). The subsidiary of Hinduja Ventures Ltd., part of the global Hinduja Group, confirmed the order for the C-band transponders on the satellite, which it will use to provide digital cable TV services through a Headend-In-The-Sky (HITS) system. The HITS service – branded 'NXT Digital' – will help the distribution fraternity smoothly transition to digital and allow customers to choose channels through a satellite multiplex across India. The technology program manager for 'NXT Digital' is Castle Media which has set up several world class operations in broadcasting and digital networks in India and overseas. Castle Media has been tasked with the design-to-delivery of the HITS service including setting up a state-of-the-art next generation broadcast facility and a robust back-end facility for SMS, CRM, Billing, CAS and other mission critical components and services.

### **Airbus Defence and Space Enable PETSE to Expand VSAT Services**

November 12, 2015 - Integrated Petroleum & Energy Services company (PETSE) and Airbus Defence and Space have signed a three year agreement for supply of the Terralink Hub communications services. Terralink Hub will provide a fully managed service to PETSE which again provide them with the complete range of connectivity services to their local market in the Kingdom of Saudi Arabia. Already a licensed VSAT services reseller and leading provider of Engineering, Project Management, Business consultancy and Procurement services for the Oil, Water treatment and Civil work segments in the Kingdom, PETSE will become a full VSAT service provider, enabling high levels of IP connectivity with support from Airbus Defence and Space and the Terralink Hub platform, enabling PETSE to provide more flexible services to their customers.

### **SpeedCast to Acquire ST Teleport**

November 13, 2015 - SpeedCast International Limited has

entered into a definitive agreement to acquire ST Teleport, a leading satellite communications services provider based in Singapore. The acquisition includes ST Teleport's world class teleport facilities and data centre infrastructure in Singapore, a major hub in Asia for global maritime and oil & gas customers. The acquisition enables SpeedCast to remain, more than ever, the partner of choice for satellite communications in Asia-Pacific and further strengthens the Company's position in both the maritime and energy sectors. ST Teleport's hybrid satellite-fiber infrastructure supports access to more than 22 satellites and direct connections to fiber switches in Asia and in the US, facilitating an extensive reach in global content and data distribution. Services for maritime and oil & gas customers represent a significant percentage of ST Teleport's business, and will further enhance SpeedCast's position in these two important sectors.

### **Bluewave Selects Eutelsat's IP Easy Service for Broadband in Myanmar**

November 16, 2015 - Bluewave has announced its selection of the IP Easy solution provided by Eutelsat Communications in order to offer a new satellite broadband service in Myanmar. Commercialised from today, the service will offer speeds of up to 12 Mbps and will be operational from first quarter of 2016 using capacity on the Eutelsat 70B satellite that provides countrywide coverage of Myanmar. Eutelsat's IP Easy service will accelerate broadband access for unserved and underserved users, remote communities and enterprises at a time of exceptional economic development in Myanmar. The new service uses Newtec's cutting edge VSAT broadband platform (Sat3Play) and terminals (MDM2200 IP satellite modems, antennas and interactive LNBs). The user-friendly installation of the equipment can be done directly by end-users thanks to a "Point & Play" system and the set-up is compact with similar antenna sizes to satellite TV antennas.

### **iDirect SatHaul Optimization Suite Helps Mobile Operators Enhance 4G/LTE Experience over Satellite**

November 17, 2015 - VT iDirect, Inc. (iDirect), a company of Vision Technologies Systems, Inc. (VT Systems), announced the release of the iDirect SatHaul Optimization Suite. This set of features is designed to enhance the cellular backhaul solution, iDirect SatHaul, which helps mobile operators create a highly efficient and cost-effective solution for connecting rural and remote locations over satellite. The iDirect SatHaul solution is designed to help mobile operators expand coverage in a smart and profitable way. When used for 4G/LTE networks, the iDirect SatHaul Optimization Suite enhances the end-user experience and at the same time reduces the amount of bandwidth needed for voice or data, redefining the business case for serving rural and remote markets or specialized environments like emergency services or mobile networks.

### **SES Techcom Services and Newtec Expand Astra Connect Broadband Service**

November 18, 2015 - SES Techcom Services, a subsidiary of SES, announced it will be expanding its Astra Connect broadband service in Africa for the Enterprise and Oil & Gas markets via the Newtec Dialog multiservice platform on SES's Astra 2G satellite. SES is extending its current relationship with long-term partner Newtec by the new platform, which is due to be launched in Q1 2016 and will utilise the West Africa Ku-band beam of the Astra 2G satellite, located at 28.2 degrees East. The platform will broaden SES Techcom Services' current portfolio and flexibly support different services, be it for consumer, Small Office, Home Office and SME customers, or for Enterprise and Oil & Gas customers. Newtec Dialog supports MF-TDMA and SCPC technologies, as well as Newtec's Mx-DMA technology, increasing bandwidth efficiency and service reliability for enterprise applications and enabling those services to run more cost-effectively and reliably than before.



### ViaSat and Cobham Bring Innovative Push-to-Talk System to the Mobile Satellite Services Market

November 19, 2015 - ViaSat and Cobham Satcom announced a strategic agreement to introduce new and innovative product and service offerings to the Mobile Satellite Services (MSS) market. The first satellite terminal product from the Cobham/ViaSat collaboration is the Explorer 122, a compact, vehicle mount real-time IP satellite terminal, which will complement the Explorer PTT-II system for mission-critical voice and data communications. The proprietary Cobham PTT technology allows for the seamless handover of voice calls from cellular-to-satellite, when the terrestrial connection is lost, without interrupting the conversation. The new Explorer 122, operating over the all-IP ViaSat L-band Managed Service network, features a ruggedized terminal design in a small form-factor with omnidirectional antenna architecture and no moving parts, thus increasing the reliability and reducing the structure-borne noise heard from inside the vehicle. The PTT satellite service utilizes ViaSat's new L-band waveform that offers true IP multicast voice over LightSquared's Skyterra-1 satellite, allowing for flat rate service plans while protecting the users' information with the most advanced commercial encryption available.

### CRRC Selects Gilat to Bring Satellite Connectivity to All its Trains, Worldwide

November 19, 2015 - Gilat Satellite Networks announced that China Railway Rolling Stock Corporation (CRRC), the world's largest railway transportation supplier and Gilat have agreed on a long-term strategic partnership, to jointly drive the development of satellite communications and managed services, and provide the best-in-class service in the global railway transportation sector. The vision of the cooperation is to bring communication connectivity to every train powered by CRRC technology around the world. This agreement brings together CRRC's leading rail transit equip-

ment technology and manufacturing capabilities with Gilat's advanced satcom on-the-move technology and its rich expertise in deploying and managing satellite networks globally, in over 90 countries. The companies will develop a solution that will provide passengers on CRRC high-speed trains with on-the-move satellite-based broadband internet access. The solution will also enable CRRC to monitor and perform maintenance services via satellite on trains wherever they are in the world, in real time via a cloud-based network operations center (NOC).

### Intelsat and Next Step Team Up to Deliver HD Content to Thailand via a New DTH Platform

November 19, 2015 - As the prices of High Definition (HD) satellite set-top boxes have become more affordable in Asia, larger numbers of viewers are demanding and switching over to HD services. With Direct-to-Home (DTH) TV platforms in Thailand expected to add more than 2.5 million new subscribers in the next 10 years, Intelsat S.A. announced that Next Step, a multi-channel operator and distributor, is leveraging Intelsat's satellite solutions on Horizons 2 at 85 degrees East to launch a new Free-to-Air DTH platform in Thailand. Under its multi-year agreement with Intelsat, Next Step is utilizing Ku-band capacity on Horizons 2 to diversify its business offerings - moving from content provider to platform operator through its new Freeview HD platform, a platform positioned to serve an addressable market of approximately 67 million people. Given Intelsat's global, flexible fleet, Horizons 2 was moved to the 85 degrees East orbital location and its beam repositioned to enable Next Step to capitalize on the opportunity to support the HD trend in Thailand. ▲

## CALENDAR OF EVENTS

2015	2016					
12	01	02	03	04	05	06

### DECEMBER

- 1-4 **Asia-Pacific Regional Space Agency Forum (APRSAT-22)** • Bali, Indonesia • [www.aprsaf.org](http://www.aprsaf.org)
- 12-15 **ITU Telecom World 2015** • Budapest, Hungary • <http://telecomworld.itu.int/>
- 16-18 **SIA's 11th Annual DoD Commercial Satcom Workshop** • Arlington, VA, USA • <http://www.dodsatcom.com/ginfo.html>

### JANUARY

- 17-20 **PTC'16** • Honolulu, Hawaii, USA • [www.ptc.org/ptc16](http://www.ptc.org/ptc16)
- 18 **APSCC Session at PTC'16** • Honolulu, Hawaii, USA • [www.ptc.org/ptc16](http://www.ptc.org/ptc16)
- 20-22 **Convergence India 2016** • New Delhi, India • [www.convergenceindia.org](http://www.convergenceindia.org)

### FEBRUARY

- 11-12 **Global Space and Technology Convention** • Singapore • [www.gstcsingapore.com](http://www.gstcsingapore.com)
- 23-24 **SmallSat Symposium** • Silicon Valley, CA, USA • [www.smallsatshow.com](http://www.smallsatshow.com)
- 29-3 **ABU Digital Broadcasting Symposium 2016 (ABU DBS 2016)** • Kuala Lumpur, Malaysia • [www.abu.org.my/dbsymposium](http://www.abu.org.my/dbsymposium)

### MARCH

- 7-10 **Satellite 2016** • Washington DC, USA • [www.satshow.com](http://www.satshow.com)
- 8-10 **CABSAT 2016** • Dubai, UAE • [www.cabsat.com](http://www.cabsat.com)

### APSCC Officers

#### PRESIDENT

Paul Brown-Kenyon  
MEASAT

#### BOARD OF DIRECTORS

Thomas Choi  
ABS  
Huang Baozhong  
APT Satellite Company Ltd.  
Richard Bowles  
Arianespace  
Philip Balaam  
AsiaSat  
Thomas Carroll  
ILS  
Sung-Ho Choi  
KTSAT  
Hiroshi Koyama  
Mitsubishi Electric Corporation  
Dani Indra  
TELKOM Indonesia  
Deepak Mathur  
SES  
Lim Kian Soon  
SingTel  
Mitsutoshi Akao  
SKY Perfect JSAT  
Eddie Kato  
Space Partnership International  
Daryl Mossman  
Space Systems/Loral  
Tom Ochinerio  
SpaceX  
Sandy Gillio  
Thales Alenia Space

#### VICE PRESIDENTS

Patrick French  
Intelsat  
Pramook Chaiwongwutthikul  
Thaicom  
Gregg Daffner  
Gapsat

#### EXECUTIVE DIRECTOR

Seong Joong Kim

# Fiber Performance, Satellite Reach... Delivered!

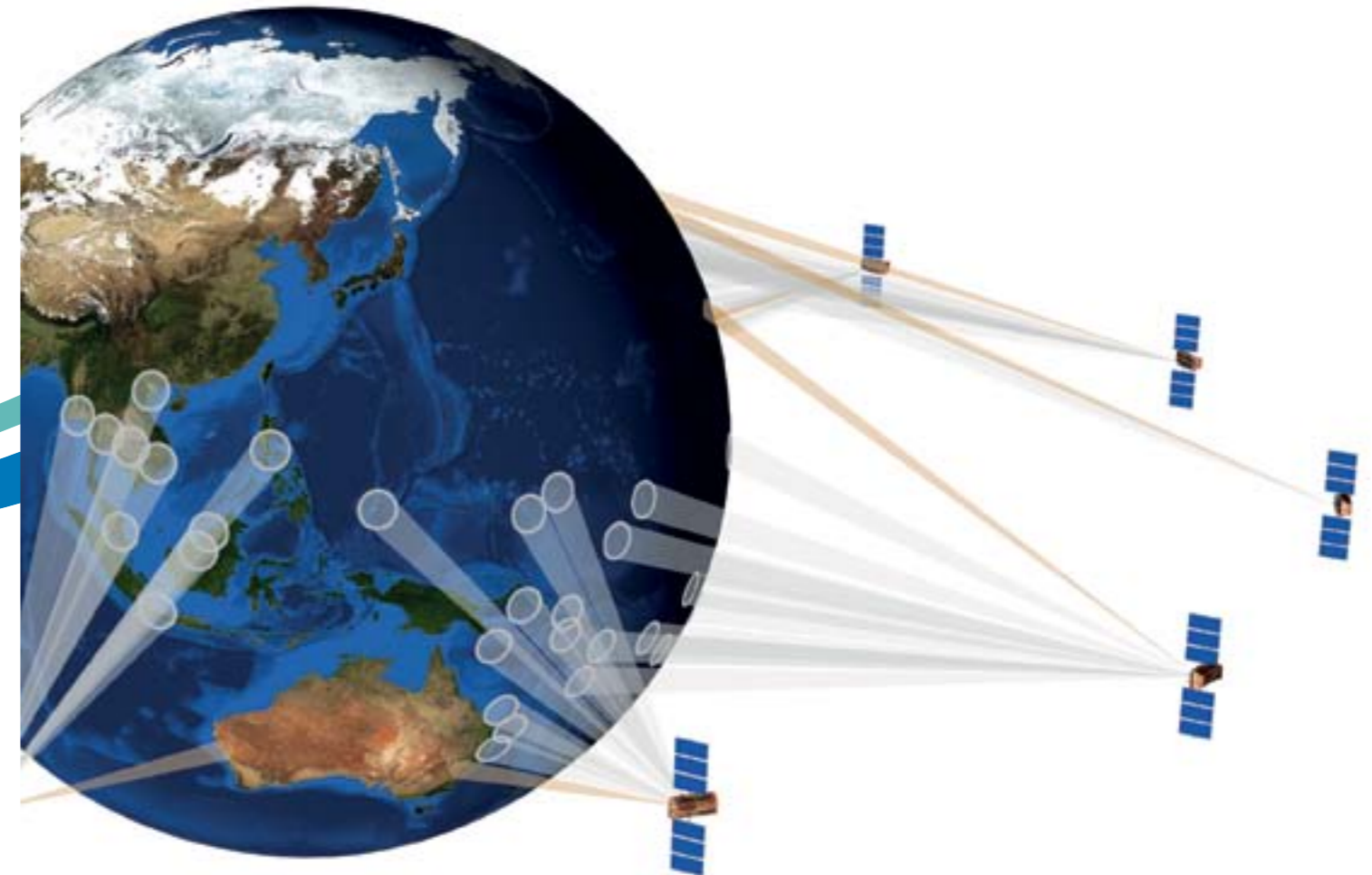

Be the next to be **#ConnectedBy03b**

03b is enabling a digital transformation everywhere. Find out what our customers are already saying about the **#lowlatency, #highthroughput, affordable** satellite solution to connect to the rest of the world.



Timor Telecom



ASTCA



DigiCel

03bnetworks.com



Email us today at:  
[getconnected@03bnetworks.com](mailto:getconnected@03bnetworks.com)



## APSCC Newsletter - A Great Way to Advertise

With a vast international circulation that includes the most prominent members of the satellite, space and communications communities, APSCC Newsletter is seen by an elite readership of industry professionals around the Asia-Pacific and globally.

**Your message will reach the right people.** Advertising in APSCC Newsletter is a cost-effective way to reach your potential clients and business partners. APSCC Newsletter can bring your company to the attention of key personnel in the satellite and space technologies, telecommunications and broadcasting industries. We offer you exclusive contact with people in the government, academic and industry sectors.

### 4<sup>th</sup> Quarter 2015

Advertiser	Page	Advertiser	Page
RSCC	Inside front cover	HUGHES	23
China Satcom	02	NSR	25
talk Satellite	05	CABSAT 2016	29
APB	13	PTC'16	31
Satellite 2016	15	Convergence India 2016	37
Satellite Evolution Group	19	SatNews	43
		03b Networks	Inside back cover



**APSCC** APSCC is a non-profit, international regional association representing all sectors of satellite and space related industries. APSCC membership is open to any government body, public and private organization, association, or corporation that is involved in satellite services, broadcasting, manufacturing, launch services, risk management or associate fields such as datacasting, informatics, multi-media, telecommunications, and other outer space-related activities with interests in the Asia-Pacific region.

APSCC aims to exchange views and ideas on technologies, systems, policies and outer space activities in general along with satellite communications including broadcasting for the betterment of the Asia-Pacific region. Conferences, forums, workshops, summits, symposiums, and exhibitions are organized through regional coordination in order to discuss issues that affect the industries and to promote and accelerate the efficient introduction of outer space activities, new services and businesses via satellites.

In order to disseminate industry related information, APSCC publishes a quarterly satellite magazine as well as a monthly e-newsletter, which are distributed worldwide to members and others. The quarterly magazine and other publications are available on the Web at [www.apsccl.or.kr](http://www.apsccl.or.kr).

### Editorials and Inquiries

Inho Seo, Editor  
Asia-Pacific Satellite Communications Council  
T-1602, 170 Seohyeon-ro Bundang-gu, Seongnam-si, Gyeonggi-do SEOUL 463-862 Rep. of KOREA  
Tel: +82-31-783-6247 / Fax: +82-31-783-6249 / E-mail: [editor@apsccl.or.kr](mailto:editor@apsccl.or.kr) / Website: [www.apsccl.or.kr](http://www.apsccl.or.kr)

APSCC Newsletter is a publication of the Asia-Pacific Satellite Communications Council. It is published quarterly in March, June, September and December. The contents of this publication may not be reproduced, either in whole or in part without, prior written permission from the editor. The views and opinions expressed are those of the authors and are not necessarily supported by APSCC.

Design and Printing by Design CRETA  
Tel: +82-2-454-2022 / Fax: +82-2-458-1331 / Website: [www.designcreta.com](http://www.designcreta.com)