



iPhone 14

iPhone 14 Plus

Apple Recycler Guide

June 2023

Contents

3	About This Guide
4	Identification
5	Directive 2012/19/EU Annex VII Components
6	Safety Considerations
9	Recommended Tools
10	Disassembly Instructions
31	Material Categorization of Output Fractions

About This Guide

Apple Recycler Guides provide guidance for electronics recyclers on how to disassemble products to maximize recovery of resources. The guides provide step-by-step disassembly instructions and information on the material composition to help recyclers direct fractions to the appropriate material recycler.

To conserve important resources, we work to reduce the materials we use and aim to one day source only recycled or renewable materials in our products. A key path to reaching that goal is resource recovery from end-of-life electronics.

Disassembly procedures are intended to be performed only by trained electronics recycling professionals. The recycler is responsible for independently evaluating and ensuring compliance with all applicable environmental, health, and safety laws related to the work. These include but are not limited to laws relating to the management, handling, shipping, and disposal of the outputs of this work as waste and laws in place to ensure the health and safety of all employees who support this work.

For questions or feedback about this guide, email contactesci@apple.com.

Note: This guide may show images from other similar models, but the procedures are the same.

Identification

Generally, you can find the model number for the iPhone inside the SIM tray slot.

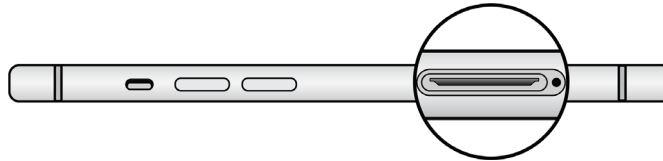

Model numbers:

*(iPhone 14) A2881, A2882, A2883, A2884
(iPhone 14 Plus) A2885, A2886, A2887, A2888*

For an iPhone with no SIM tray slot, use the diagonal measure to identify the model:

- iPhone 14 (6.1 inch or 15.5 cm diagonal)
- iPhone 14 Plus (6.7 inch or 17 cm diagonal)



Model numbers:

(iPhone 14) A2649; (iPhone 14 Plus) A2632

Directive 2012/19/EU Annex VII Components

Directive 2012/19/EU Annex VII requirements apply to the following substances and components.

Substance/Component	Apple Part Name	Removal Instructions
Printed circuit board if the surface is greater than 10 square centimeters	Display logic board, front camera and main logic board	Follow steps 1–17
External electric cables	Charge cable	Follow step 1
Battery	Lithium-ion polymer battery	Follow steps 1–15
Cover glass and organic light-emitting diode (OLED) display if the surface is greater than 100 square centimeters	OLED Display	Follow steps 1–7
No further substances or components as listed in Annex VII		

Safety Considerations

The recycler is responsible for independently evaluating all activities undertaken by its employees to perform or support the work and ensuring compliance with all applicable health and safety laws related to the work. These include but are not limited to laws relating to the health and safety of all employees who perform or support this work. The recycler is also responsible for evaluating the workspace and ensuring that the area in which the work is to be undertaken is designed using ergonomic best practices and meets all ergonomic requirements to ensure the protection of its employees.

Personal Protective Equipment

Personal protective equipment should be worn during the entire recycling process.



Wear hand protection



Wear foot protection



Wear eye protection



Wear a mask



Wear protective clothing

Battery Safety

This product uses a lithium-ion polymer battery. Before beginning any disassembly work, ensure that a safe working procedure for handling lithium-ion batteries has been established, which could include discharging the batteries so that they can be more safely managed. The following considerations may also be included:

- Remove anything from your person that could conduct energy, such as jewelry and watches, to avoid electric shock to yourself or the logic board.
- To avoid the potential for thermal runaway and the release of potentially noxious fumes, don't puncture, strike, or crush lithium-ion polymer batteries or devices powered by them.
- Don't throw, drop, or bend the battery.
- Don't expose the battery to excessive heat or sunlight.
- Don't use tools that are sharp or conduct electricity.
- Keep your workspace clear of foreign objects and sharp materials.
- Dispose of batteries according to local environmental laws and guidelines.

Workspace safety guidelines

- Use heat-resistant gloves and safety glasses.
- Keep a sand dispenser within arm's reach (2 feet or 0.6 m) on one side of the workstation, not above the workstation. The dispenser should be a wide-mouthed, quick-pour metal container with a flip-top lid or tray that contains 8–10 cups (1.9–2.4 L) of clean, dry, untreated sand.
- Keep the battery at least 2 feet (0.6 m) from paper and other combustible materials.
- Work in an area with adequate ventilation.

Handling a thermal runaway

If you notice any of the following signs, a thermal runaway is likely underway, and you should act immediately:

- The lithium-ion polymer battery or a device containing one begins to smoke or emit sparks or soot.
- The battery pouch suddenly and quickly puffs out.
- You hear hissing or popping sounds.

Don't use water or an ABC/CO₂ fire extinguisher on a thermal runaway battery or a device containing one. Water and ABC/CO₂ fire extinguishers will not stop the reaction.

Do smother the battery or device immediately with plenty of clean, dry sand, dumped all at once. Timing is critical; the faster you pour all the sand, the faster the thermal runaway will stop.

Do leave the room for 30 minutes if the thermal runaway causes any irritation.

Do wait 30 minutes before touching the battery. Wear heat-resistant gloves and safety glasses to remove the battery from the sand, or use a touchless thermometer to measure the battery temperature. Only touch the battery when the event has finished.

Do dispose of the damaged battery or device (including any debris removed from the sand) according to local environmental laws and guidelines.

OLED Safety

Broken OLEDs must be handled properly to ensure the safety of your employees and mitigate any hazards. Package broken OLEDs in an appropriate container to properly manage the hazards associated with the materials and store only with compatible materials. All waste must be properly classified, packaged, and labeled in accordance with all relevant laws and regulations.

Hazard Warnings



Broken glass hazard



Chemical inhalation hazard



Rechargeable battery hazard

Recommended Tools

Flat-blade screwdriver

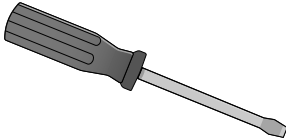

Miniature plastic pry bar

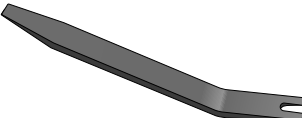

Miniature pry bar

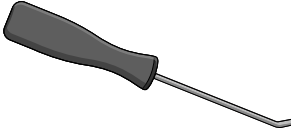

SIM-eject tool



Tweezers



Disassembly Instructions

1. Remove the charge cable.

- » *Ensure that the iPhone is turned off.*
- » *Disconnect the charge cable.*

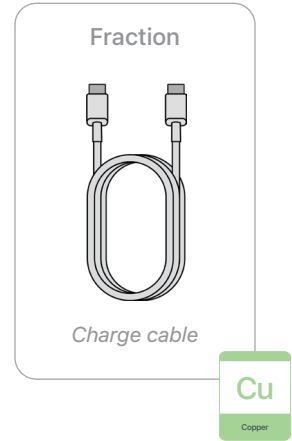
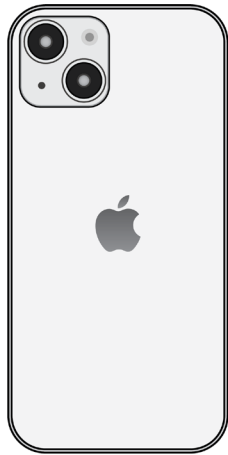

2. Remove the OLED display.



Broken glass hazard



Chemical inhalation hazard

- » *Hold the iPhone at the edge of a counter with the display faceup and the Lightning connector toward the counter edge.*
- » *Insert the tool tip into the Lightning connector. Push the handle down to pry the display away from the enclosure.*

Tools Used

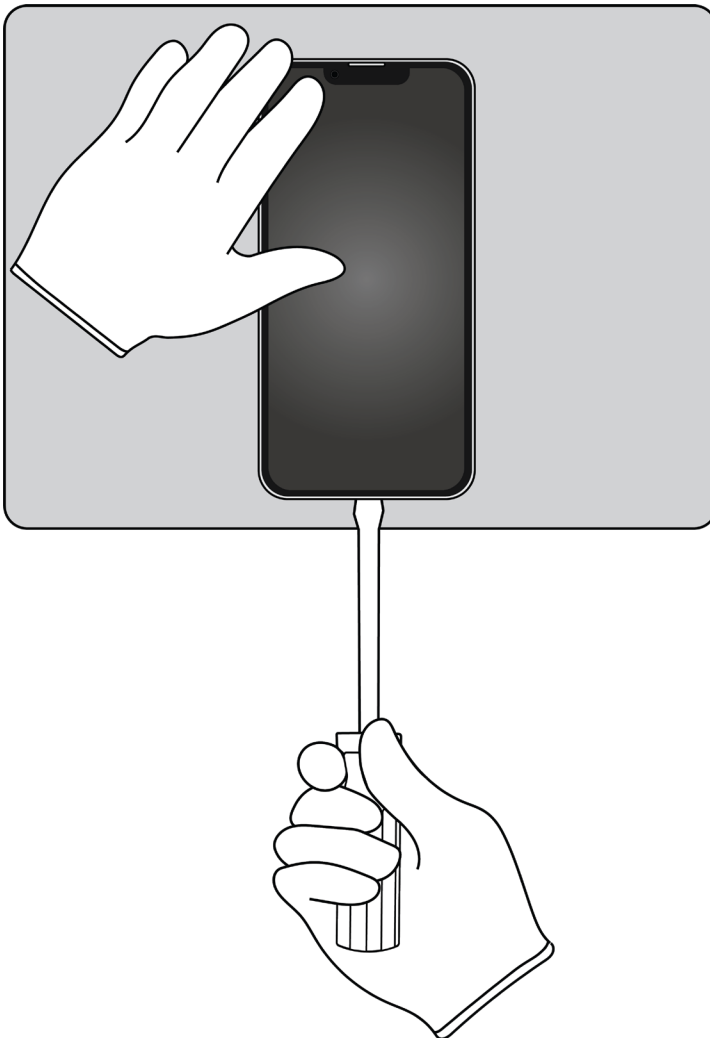
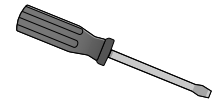

» Remove the display by hand. Set the enclosure aside.

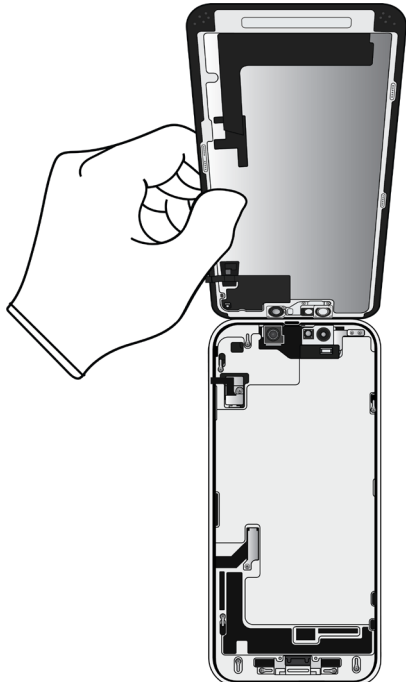

- 3.** Pry off the display frame surrounding the OLED display. Set the OLED display aside.

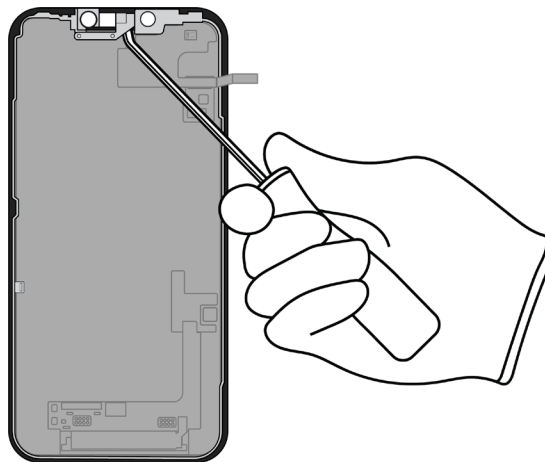

4. Pry the light sensor off the display frame.

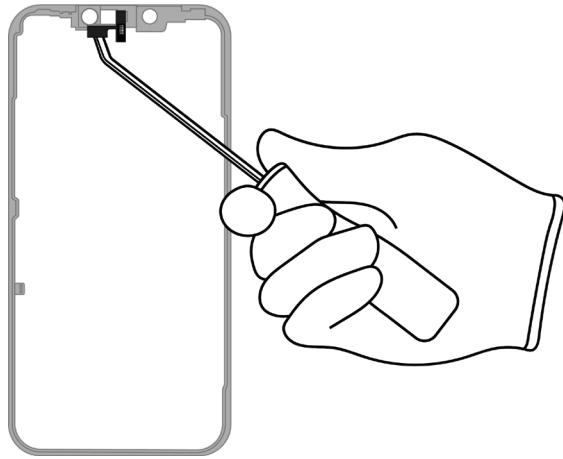

Tools Used



Fraction



Light sensor

Cu

Copper

Fraction



Display frame

Fe

Ferrous

5. Remove the other light sensor from the display backing on the OLED display.

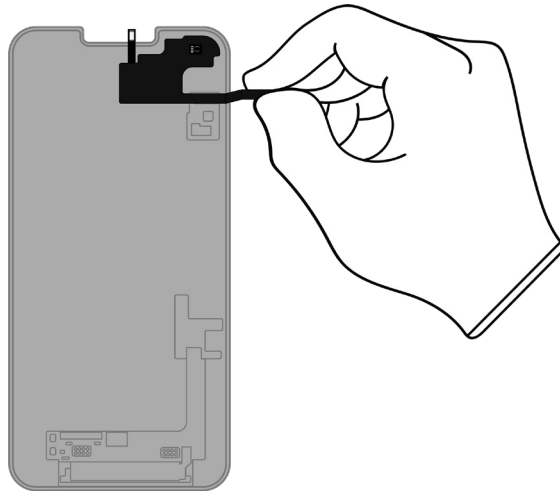

Fraction



Light sensor

Cu
Copper

A diagram showing a small black component labeled "Light sensor" with a "Fraction" label above it. To the right is a green box containing the chemical symbol "Cu" and the word "Copper".

6. Remove the display logic board.

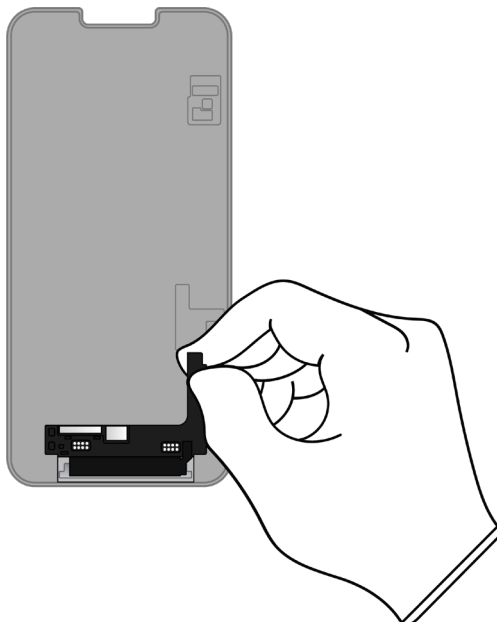

Fraction

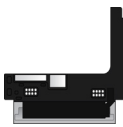

Display logic board

PMs
Precious Metals

A diagram showing a larger black component labeled "Display logic board" with a "Fraction" label above it. To the right is a green box containing the chemical symbol "PMs" and the words "Precious Metals".

7. Separate the display backing from the OLED display.

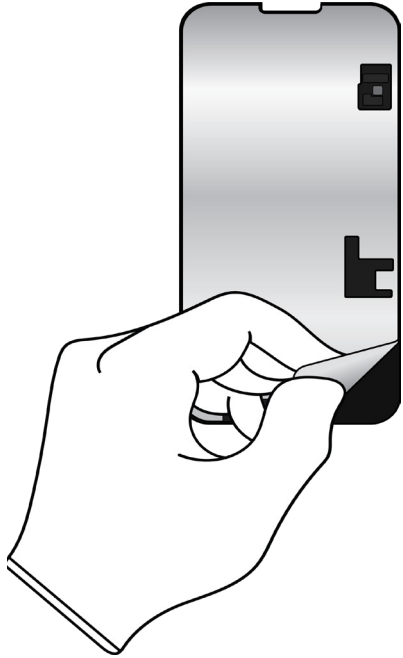

8. On the enclosure, use the SIM-eject tool to remove the SIM tray. (For models with no SIM tray slot, skip to step 11.)

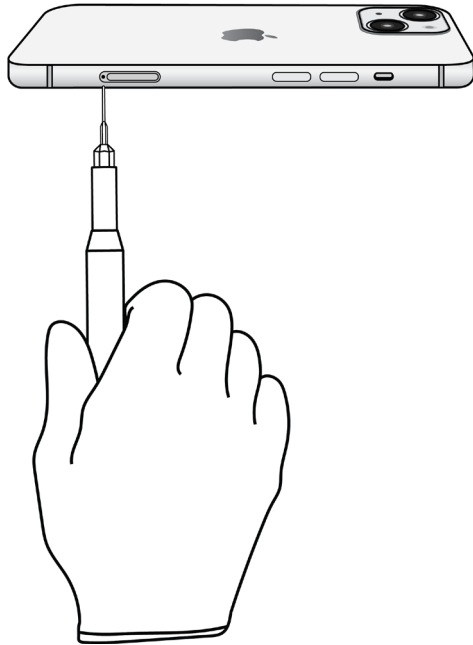

9. Remove the SIM card from the SIM tray.

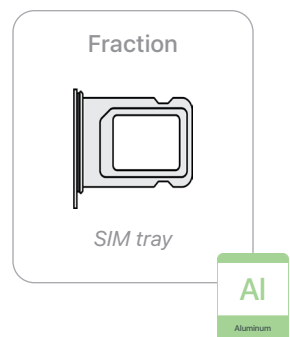
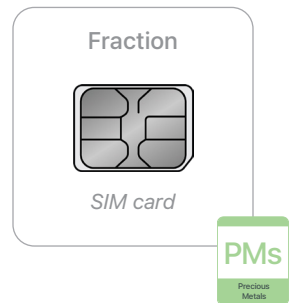
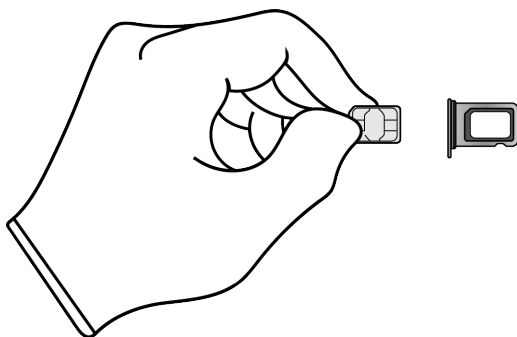

10. Remove the ribbon cable.

- » *Hold the enclosure at the edge of a counter with camera faceup and the SIM tray slot facing the counter edge.*
- » *Insert the tool tip into the SIM tray slot. Push the handle down to separate the support plate from the enclosure.*

Tools Used

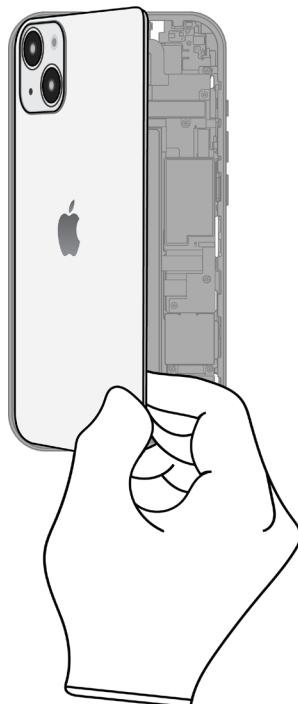
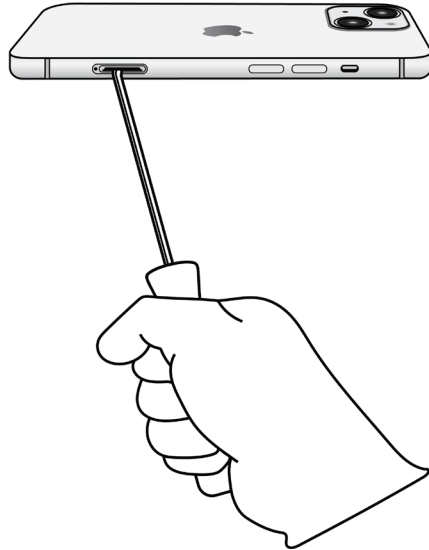

- » *Set the enclosure aside.*
- » *Remove the ribbon cable from the support plate. Then skip to step 12.*

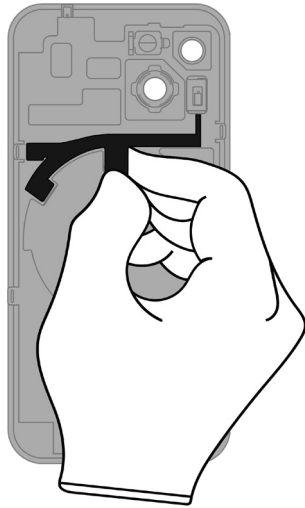

Fraction



Ribbon cable

Cu
Copper

A diagram showing a black ribbon cable with a fraction symbol (a horizontal line with a diagonal slash) drawn over it. To the right of the cable is a green rectangular box containing the chemical symbol 'Cu' and the word 'Copper' below it.

11. For models with no SIM tray slot, remove the ribbon cable.

- » *Insert the tool tip between the enclosure and the support plate. Push the handle down to separate the support plate from the enclosure.*

Tools Used

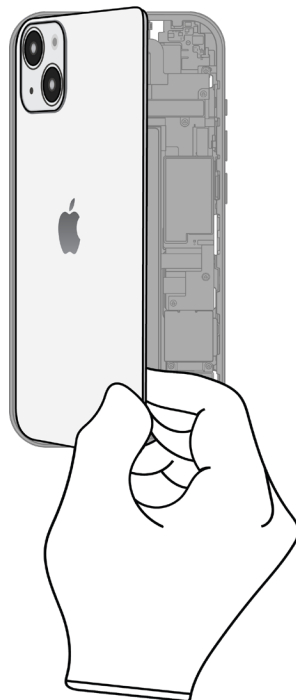
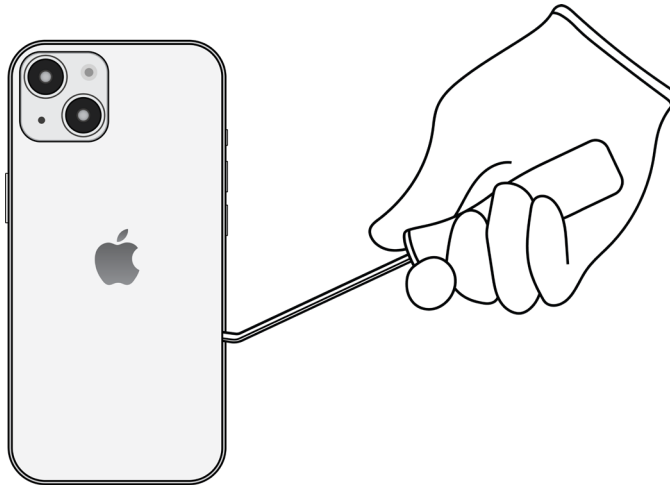

» *Set the enclosure aside.*

» *Remove the ribbon cable from the support plate by hand.*

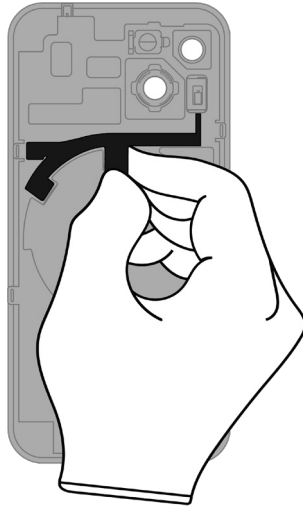

Fraction



Ribbon cable

Cu

Copper

12. Pry off the MagSafe charging coil.

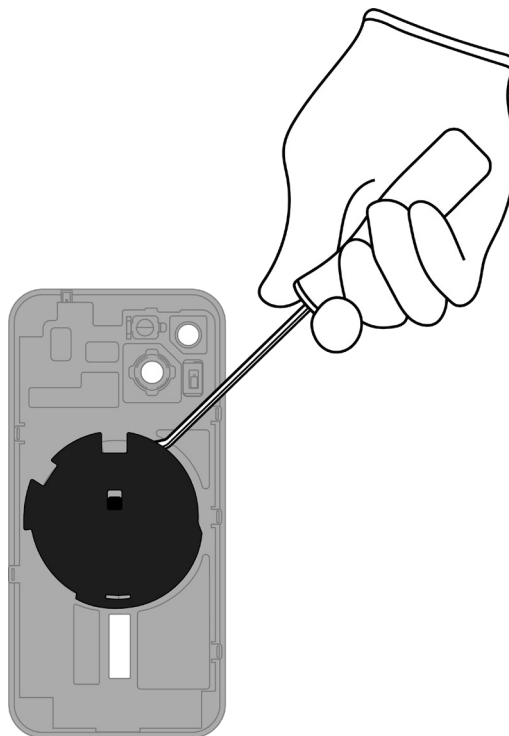

Tools Used



Fraction



MagSafe charging coil

Cu

Copper

13. Pry off the microphone.

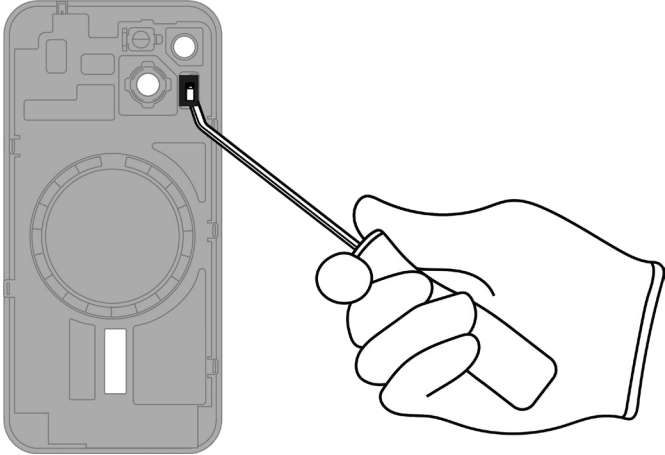

Tools Used



Fraction



Microphone

Cu

Copper

14. Pry off the MagSafe magnets.

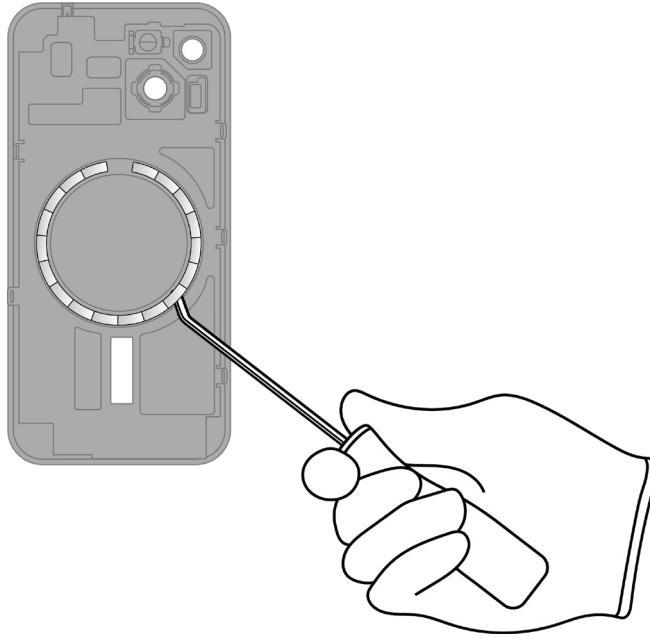

Tools Used



Fraction

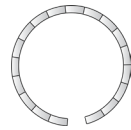

MagSafe magnets

REE

Rare Earth Elements

Fraction

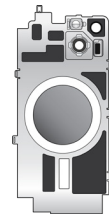

Support plate

Cu

Copper

15. Gently remove the lithium-ion polymer battery from the enclosure.



Rechargeable battery hazard

- » *Using tweezers, gently peel one of the battery adhesive tabs away from the battery.*
- » *Twist the tab around the tweezers until white adhesive appears. Continue twisting until the entire adhesive strip is removed.*
- » *Repeat this process for the remaining battery tabs. Continue with the miniature plastic pry bar if needed.*

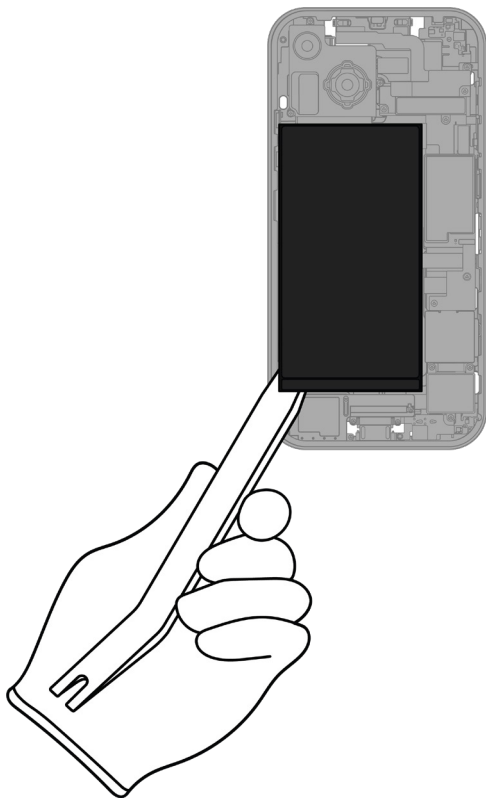

Tools Used



Fraction



Lithium-ion polymer battery

BT

Battery

16. Pry off the rear camera.

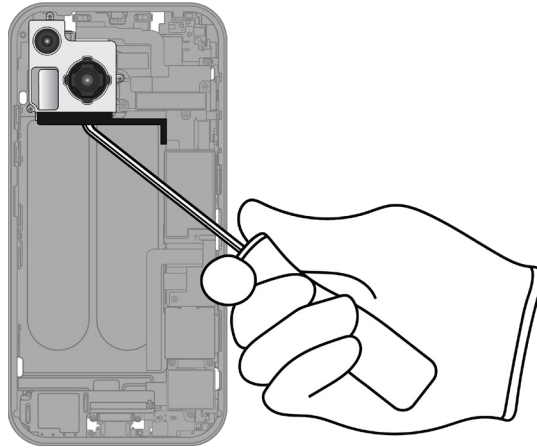

Tools Used



Fraction



Rear camera

PMs
Precious Metals

17. Pry off the front camera and main logic board.

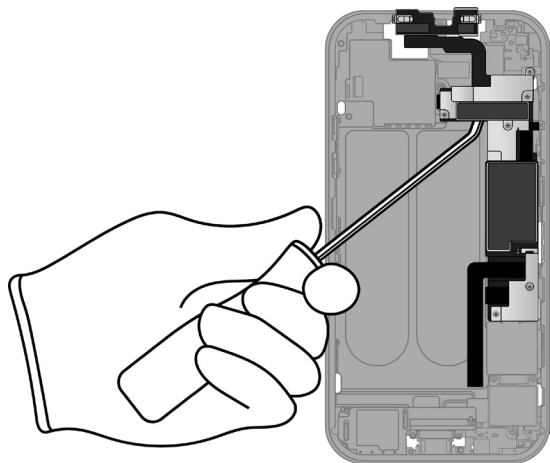
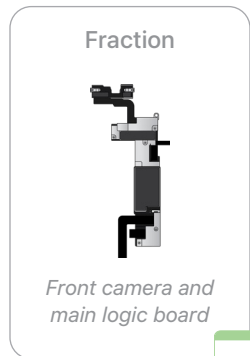
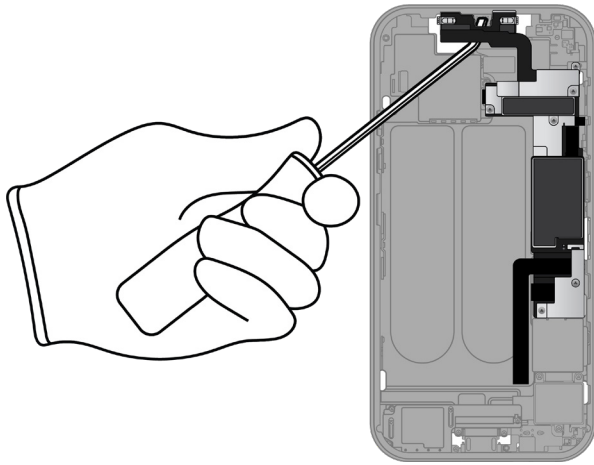

18. Pry off the receiver.

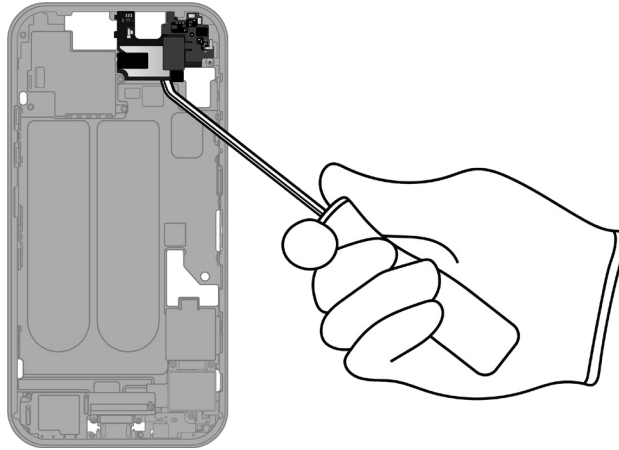

Tools Used



Fraction

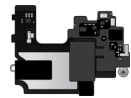

Receiver

REE

Rare Earth
Elements

19. Pry off the SIM reader. (For models with no SIM reader, skip to step 20.)

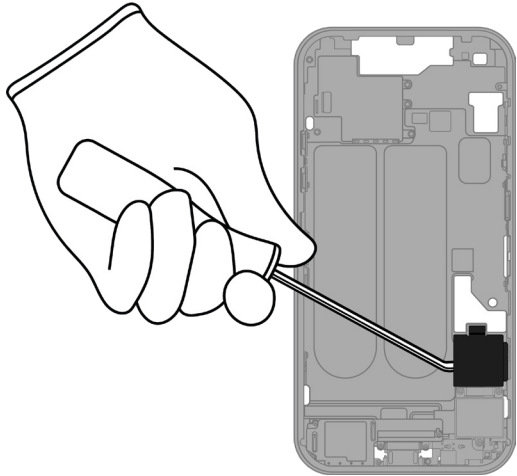

Tools Used



Fraction



SIM reader

Cu

Copper

20. Pry off the Taptic Engine.

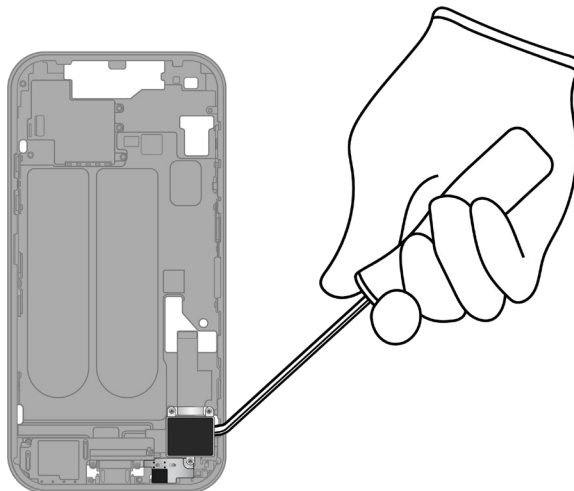

Tools Used



Fraction

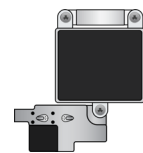

Taptic Engine

REE

Rare Earth Elements

21. Pry off the speaker.

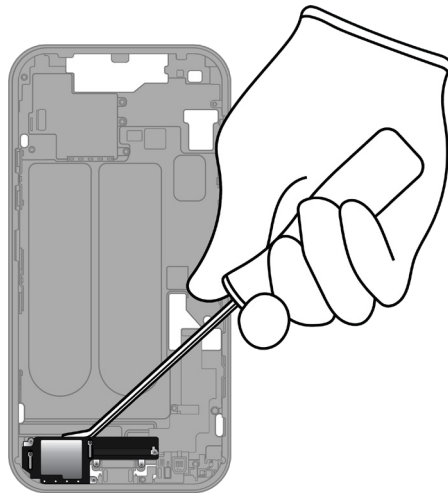

Tools Used



Fraction

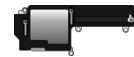

Speaker

REE
Rare Earth
Elements

22. Pry off the microphone and ribbon cable.

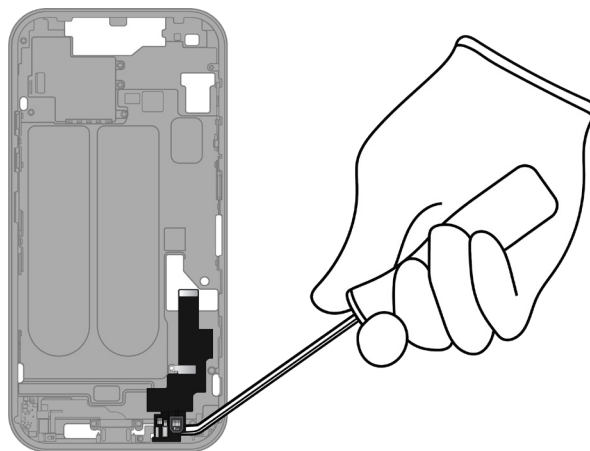

Tools Used



Fraction



Microphone and
ribbon cable

Cu
Copper

23. Pry off the Lightning connector.

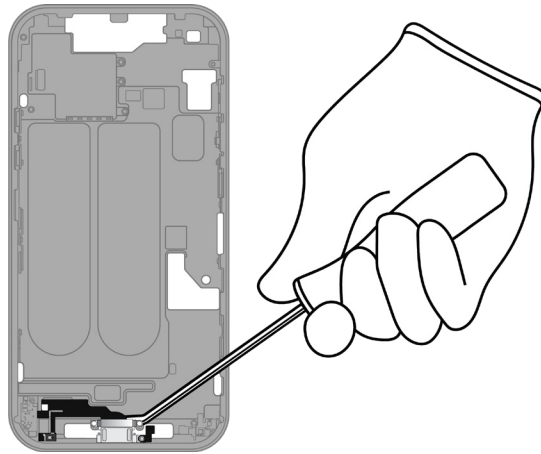

Tools Used



Fraction



Lightning connector

Cu

Copper

24. Pry off the button components.

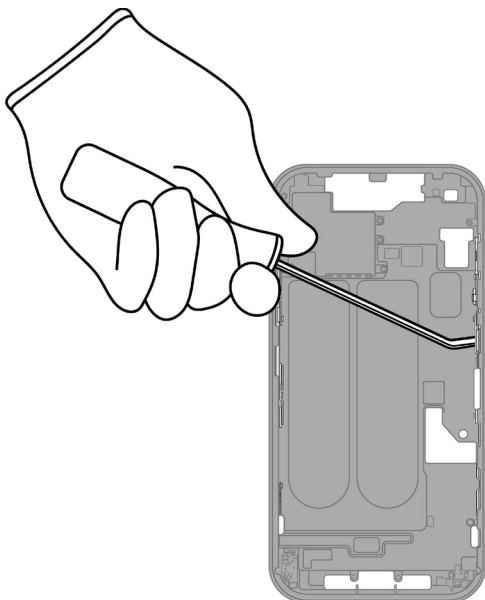

Tools Used



Fraction



Button components

Fe

Ferrous

25. Pry off the remaining logic board fragments.

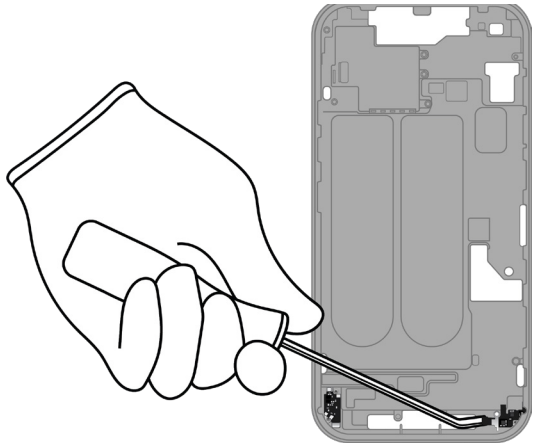

Tools Used



Fraction

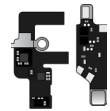

Logic board fragments

PMs
Precious Metals

Fraction

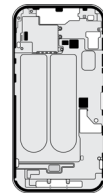





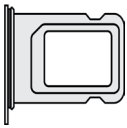
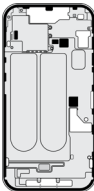

Enclosure

Al
Aluminum

Material Categorization of Output Fractions

All outputs from this process must be managed, handled, and disposed of in accordance with applicable waste laws and regulations, including but not limited to the Waste Framework Directive and its national enactments in Europe.

Fraction	Downstream Processing
<p data-bbox="435 604 570 632">Aluminum</p>  <p data-bbox="342 814 662 863"><i>SIM tray (except in models A2649, A2632)</i></p>  <p data-bbox="451 1115 553 1142"><i>Enclosure</i></p>	<p data-bbox="967 604 1276 632">Primary Target Material</p>  <p data-bbox="927 806 1317 833">Potential Additional Materials</p>   

<p data-bbox="440 1241 565 1268">Batteries</p>  <p data-bbox="367 1514 638 1541"><i>Lithium-ion polymer battery</i></p>	<p data-bbox="967 1241 1276 1268">Primary Target Material</p> 
---	--

Fraction

Downstream Processing

Ferrous



Display frame



Display backing



Button components

Primary Target Material



Glass



OLED display

Primary Target Material



Potential Additional Materials



Fraction

Downstream Processing

Logic Boards

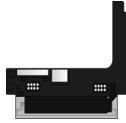

Display logic board



*SIM card
(except in models A2649, A2632)*



Rear camera



*Front camera and
main logic board*

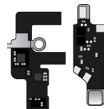

Logic board fragments

Primary Target Material



Potential Additional Materials



Fraction

Downstream Processing

Mixed Electronics

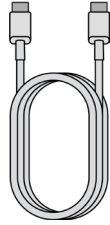

Charge cable



Light sensor



Light sensor



Ribbon cable



MagSafe charging coil



Microphone



Support plate

Primary Target Material



Potential Additional Materials



Fraction

Downstream Processing

Mixed Electronics (cont.)



SIM reader
(except in models A2649, A2632)



Microphone and ribbon cable

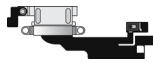

Lightning connector

Rare Earth Magnets

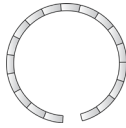

MagSafe magnets

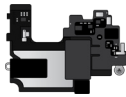

Receiver

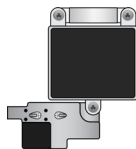

Taptic Engine



Speaker

Primary Target Material



Potential Additional Materials

